

P116, P108, P104

User Manual

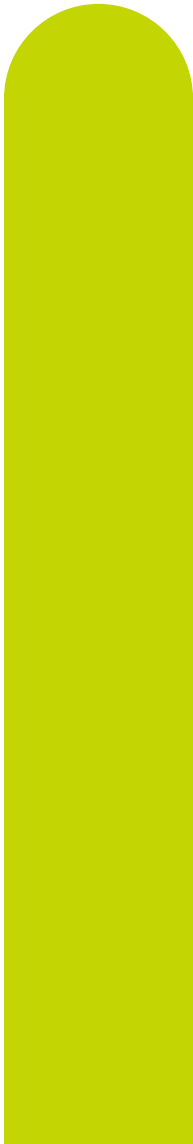

Piccolo Range Process Controller

HA031260/7

April 2015

Piccolo Range PID Temperature Controllers

User Manual Part Number HA031260 Issue 7.0 April -15

Includes P116, P108 and P104 Controllers.

Contents

1.	Installation and Basic Operation	5
1.1	What Instrument Do I Have?	5
1.2	Unpacking Your Controller.....	5
1.3	Dimensions.....	5
1.4	Step 1: Installation	6
1.4.1	Panel Mounting the Controller	6
1.4.2	Panel Cut Out Sizes	6
1.4.3	Recommended minimum spacing of controllers	6
1.4.4	To Remove the Controller from its Sleeve.....	6
1.5	Order Code	7
1.5.1	Hardware.....	7
1.5.2	Configuration Code	8
2.	Step 2: Wiring.....	10
2.1	Terminal Layout P116 Controller	10
2.2	Terminal Layout P108 and P104 Controllers.....	10
	Isolation Boundaries	11
2.3	Wire Sizes	11
2.4	Controller Power Supply.....	11
2.4.1	High Voltage Power Supply	11
2.4.2	Low Voltage Power Supply	11
2.5	Sensor Input (Measuring Input).....	12
2.5.1	Thermocouple Input.....	12
2.5.2	RTD Input	12
2.5.3	Linear Input (mA or mV).....	12
2.5.4	Linear Input (Volts).....	12
2.5.5	Two-Wire Transmitter Inputs.....	12
2.6	Output 1.....	13
2.6.1	Relay Output (Form A, normally open)	13
2.6.2	Logic (SSR drive) Output	13
2.7	Output 2.....	13
2.7.1	Relay Output (Form A, normally open)	13
2.7.2	DC Output (P116 only).....	13
2.7.3	Triac Output.....	13
2.8	Output 3.....	14
2.8.1	Relay Output (Form A, normally open)	14
2.8.2	DC Output.....	14
2.9	Output 4 (AA Relay).....	14
2.10	General Note About Relays and Inductive Loads	14
2.11	Digital Inputs DI1 & DI2.....	15
2.12	Current Transformer	15
2.13	Transmitter Power Supply	15
2.14	Digital Communications	16
2.15	Wiring Examples	17
2.15.1	Heat/Cool Controller.....	17
2.15.2	CT Wiring Diagram	17
3.	Safety and EMC Information.....	18
3.1	Installation Safety Requirements.....	19
4.	Switch On	21
4.1	New Unconfigured Controller	21
4.1.1	Quick Configuration Code.....	21
4.1.2	To Load the Factory Default Data	21
4.1.3	Quick Code Tables.....	22
4.1.4	Alarm Allocation using the Quick Code.....	23
4.1.5	To Re-Enter Quick Code mode	23
4.1.6	Summary of Start-up Displays.....	23
4.1.7	Subsequent Start-ups.....	24
4.2	Front Panel Layout.....	24
4.2.1	To Set The Target Temperature (Setpoint 'SP').....	25

4.3	Level 1 Operator Parameters	25
4.4	Alarms	26
4.4.1	To Set Alarm Setpoints	26
4.4.2	Alarm Indication	26
4.4.3	To Acknowledge an Alarm	26
4.4.4	Alarm Latching	27
4.4.5	Blocking Alarms	27
4.4.6	Alarm Hysteresis	27
4.4.7	Sensor Break Alarm, <i>Sbr</i>	28
4.4.8	Sensor Break Safe Output Demand	28
4.4.9	Loop Break Alarm, <i>Lbr</i>	28
4.4.10	Current (CT) Alarms	28
4.4.11	EEPROM Write Frequency Warning, <i>E2Fr</i>	29
4.4.12	Remote Setpoint Fail, <i>rEmF</i>	29
4.5	Alarms Advanced	30
4.5.1	Behaviour of Alarms after a Power Cycle	30
4.5.2	Example 1	30
4.5.3	Example 2	30
4.5.4	Example 3	30
4.5.5	Diagnostic Alarms	31
4.5.6	Out of Range Indication	31
4.6	Other Levels of Operation	32
4.7	Level 2 Operation	32
4.7.1	To Select Level 2	32
4.7.2	Operator Level 2 Parameters	33
4.8	User Calibration	36
4.9	To Return to Level 1	36
4.10	Auto, Manual and Off Mode	37
4.10.1	To Select Auto, Manual or Off Mode	37
4.11	Estimated Energy Usage	37
4.12	Timer Operation	38
4.12.1	Dwell Timer	38
4.12.1.1	Example: To Configure and Operate a Dwell Timer	39
4.12.1.2	Example: To Configure Timer Digital Outputs	39
4.12.1.3	Example: To Configure Timer Digital Inputs	39
4.12.2	Delayed Switch on Timer	40
4.12.2.1	Example: To Configure and Set up a Delayed Switch on Timer	40
4.12.3	Soft Start Timer	41
4.12.3.1	Example: To Configure and Set up a Soft Start Timer	41
5.	Configuration Level	42
5.1	To Select Configuration Level	42
5.2	Configuration Level Parameters	43
5.2.1	Summary of 'P' Codes	43
5.2.2	Analogue Input	44
5.2.3	Input Ranges and Limits	45
5.2.4	Control	46
5.2.5	Output 1	47
5.2.6	Output 2	48
5.2.7	Output 3	49
5.2.8	Output 4	50
5.2.9	DC Output Range	50
5.2.10	Setpoint Retransmission Range	50
5.2.11	Alarms	51
5.2.12	Current Transformer	52
5.2.13	Loop Break Alarm	52
5.2.14	Sensor Break, Loop Break and Current (CT) Alarms	53
5.2.14.1	Sensor Break Impedance	53
5.2.15	Timer	54
5.2.16	Digital (Contact) Inputs	55
5.2.17	Digital Communications	56
5.2.17.1	Broadcast Communications	57
5.2.18	Pushbutton Functionality	58
5.2.19	Display Functionality	59
5.2.20	Passcodes	59
5.2.21	Energy Meter Source	60
5.2.22	Recovery Point	61
5.2.22.1	Recovery Point Save	61
5.2.22.2	Recovery Point Load	61

6.	Controller Block Diagram.....	62
6.1	Input/Output.....	63
7.	Control.....	64
7.1	Types of Control.....	64
7.1.1	On/Off Control.....	64
7.1.2	PID Control.....	64
7.1.3	Proportional Band ' P_b '.....	65
7.1.4	Integral Term ' I_i '.....	65
7.1.5	Derivative Term ' D_d '.....	66
7.1.6	Cooling Algorithm.....	66
7.1.7	Relative Secondary (Cool) Gain ' r_{2G} '.....	66
7.1.8	High and Low Cutback ' C_{bH} ' and ' C_{bLo} '.....	67
7.1.9	Manual Reset ' r_r '.....	67
7.1.10	Loop Break.....	68
7.2	Tuning.....	69
7.2.1	Loop Response.....	69
7.2.2	Initial Settings.....	70
7.2.3	Automatic Tuning.....	71
7.2.4	To Start Auto Tune.....	71
7.2.5	Auto Tune from Below SP - Heat/Cool.....	72
7.2.6	Auto Tune From Below SP - Heat Only.....	73
7.2.7	Auto Tune at Setpoint - Heat/Cool.....	74
7.2.8	Manual Tuning.....	75
7.2.9	Manually Setting Relative Cool Gain.....	75
7.2.10	Manually Setting the Cutback Values.....	76
7.2.11	Effect of Control Action, Hysteresis and Deadband.....	77
8.	Digital Communications.....	78
8.1	Configuration Port.....	78
8.2	EIA485 Field Communications Port.....	78
8.3	Master/Slave (Broadcast) Communications.....	79
8.4	EEPROM Write Cycles.....	80
8.5	Broadcast Master Communications Connections.....	81
8.5.1	Wiring.....	81
8.6	DATA ENCODING.....	81
8.7	Parameter Modbus Addresses.....	82
9.	Calibration.....	86
9.1	To Check Input Calibration.....	86
9.1.1	Precautions.....	86
9.1.2	To Check mV Input Calibration.....	86
9.1.3	To Check Thermocouple Input Calibration.....	87
9.1.4	To Check RTD Input Calibration.....	87
9.2	Input Calibration.....	88
9.2.1	To Calibrate mV Input.....	88
9.2.2	To Calibrate Thermocouple Input.....	89
9.2.3	To Calibrate RTD Input.....	90
9.2.4	To Calibrate mA Outputs.....	91
9.2.5	CT Calibration.....	92
9.2.6	To Return to Factory Calibration.....	93
9.3	Calibration Parameters.....	93
10.	Configuration Using iTools.....	94
10.1	Loading an IDM.....	94
10.1.1	Using the H Communications Port.....	94
10.2	Connecting a PC to the Controller.....	94
10.2.1	Configuration Clip.....	Error!
	Bookmark not defined.	
10.3	Starting iTools.....	95
10.4	Configuration using the Wizard.....	96
10.4.1	Sensor Input.....	97
10.4.2	Setpoints.....	98
10.4.3	Control.....	98
10.4.4	Alarms.....	99
10.4.5	Timer.....	99
10.4.5.1	Dwell Timer.....	99
10.4.5.2	Delay Timer.....	100
10.4.5.3	Soft Start Timer.....	100

10.4.6	Outputs	101
10.4.7	Digital Inputs	101
10.4.8	Current Transformer Input	102
10.4.9	Energy	102
10.4.10	Digital Communications	103
10.4.11	Pushbutton and Display Functionality	103
10.4.12	Promote	104
10.4.13	Example: Summary	104
10.5	The 'Browse' List	105
10.5.1	Operating List	105
10.5.1.1	Settings	105
10.5.1.2	Variables	106
10.5.1.3	Status	106
10.5.1.4	User Calibration	106
10.5.2	Configuration List	107
10.5.2.1	Example: To Configure the Sensor Input	107
10.5.2.2	Example: To Configure Outputs for Control	108
10.5.2.3	Example: To Configure Alarms	109
10.5.2.4	Example: To Store and Retrieve Current Settings in the Controller	110
10.5.2.5	To Load Stored Settings in the Controller	110
10.5.2.6	To Return to Factory Settings	110
10.5.2.7	To Return to Quick Start Configuration	110
10.5.3	Summary	111
10.6	Configurations only available using iTools	112
10.6.1	Example: To Promote Parameters	112
10.6.2	To Load A Special Linearisation Table	113
10.7	Cloning	114
10.7.1	Save to File	114
10.7.2	To Clone a New Controller	114
10.7.3	Clone Error	114
11.	Appendix A Factory Default Settings	115
11.1	Factory Default Configuration	115
11.2	Factory Default Parameter Settings	115
12.	Appendix B TECHNICAL SPECIFICATION	116
13.	Index	118

Issue Status of this Manual

Issue 1 applies to software versions V1.01.

Issue 2 applies to software versions V1.01 but updates description of auto tune and loop break.

Issue 3 applies to software versions V1.01 and V1.02 (from July 2013) and makes minor improvements to some descriptions.

Issue 4 corrects the EIA485 connection diagram

Issue 5 removes the CP function from the order code

Issue 6 adds logic output to OP2

Issue 7 adds an example and further description to EEPROM Warning

1. Installation and Basic Operation

1.1 What Instrument Do I Have?

Thank you for choosing this Controller.

It provides precise control of industrial processes and is available in three standard DIN sizes:-

- 1/16 DIN Model Number P116
- 1/8 DIN Model Number P108
- 1/4 DIN Model Number P104

A universal input accepts various thermocouples, RTDs or process inputs. Up to three (P116) or four (P108 and P104) outputs can be configured for control, alarm or re-transmission purposes. Digital communications and a current transformer input are available as options.

The controller may be ordered against a hardware ordering code only (section 1.5.1). In this case when it is new and first switched on 'out of the box' it will start in a 'Quick Configuration' mode (section 4.1). Alternatively, it may be ordered against both hardware and software codes, in which case it will be supplied configured and will start up directly showing the operator display (section 4.2). A label fitted to the right side of the sleeve shows this ordering code together with the serial number, which also includes the date of manufacture. A label on the left side shows the terminal connections for the hardware fitted.

A full configuration mode may also be entered and provides more detailed functionality to be configured (section 5).

This Manual takes you through all aspects of installation, wiring, configuration and use of the controller.

1.2 Unpacking Your Controller

The controller is supplied with:-

- Sleeve (with the controller fitted in the sleeve)
- Two panel retaining clips and IP66 sealing gasket mounted on the sleeve
- Component packet containing a snubber for a relay output (see section 2.10) and a 2.49Ω resistor for a current input (see section 2.5)
- Installation sheet Part Number HA031173EFG (English, French, German) and HA031173ISC (Italian, Spanish, Chinese).

1.3 Dimensions

General views of the controllers are shown below together with overall dimensions.

P116

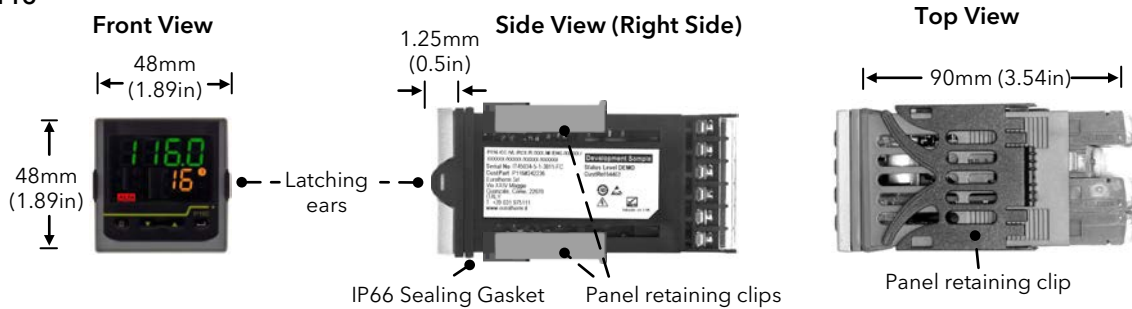

P108 and P104



1.4 Step 1: Installation

This instrument is intended for permanent installation, for indoor use only, and enclosed in an electrical panel

Select a location which is subject to minimum vibrations the ambient temperature is within 0 and 55°C (32 - 131°F) and operating humidity of 0 to 90% RH non condensing.

The instrument can be mounted on a panel up to 15mm thick.

To ensure IP66 front protection, mount on a non-textured surface.

Please read the safety information in section 3 before proceeding. An EMC Booklet, part number HA025464, gives further installation information and can be downloaded from www.eurotherm.co.uk.

1.4.1 Panel Mounting the Controller

1. Prepare a cut-out in the mounting panel to the size shown. If a number of controllers are to be mounted in the same panel observe the minimum spacing shown.
2. Carefully remove the panel retaining clips from the sleeve using figures or a small screwdriver.
3. To achieve IP66 sealing, make sure the gasket is fitted behind the front bezel of the controller
4. Insert the controller through the cut-out
5. Spring the panel retaining clips back into place. Secure the controller in position by holding it level and pushing both retaining clips forward.
6. Peel off the protective cover from the display.
7. If the panel retaining clips subsequently need removing, they can be unhooked from the side with either your fingers or a screwdriver.

1.4.2 Panel Cut Out Sizes

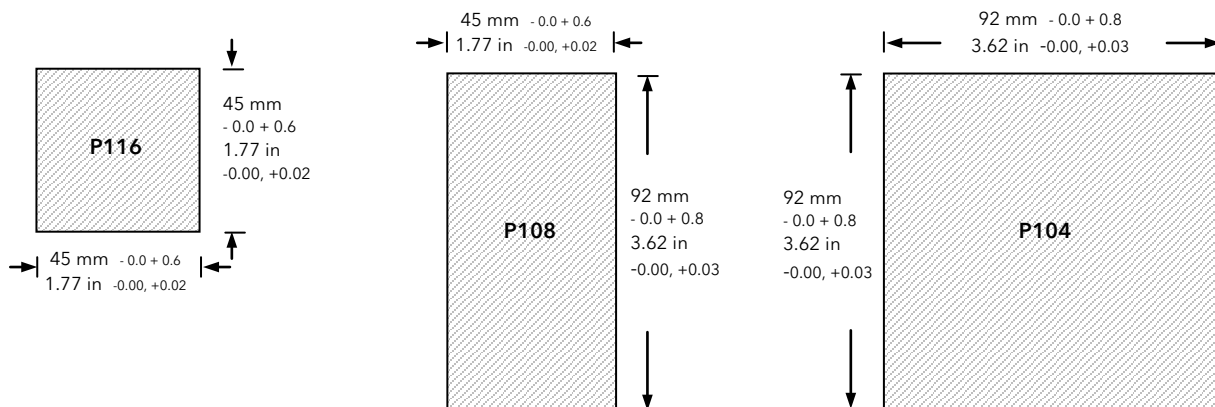

1.4.3 Recommended minimum spacing of controllers

Applies to all models.

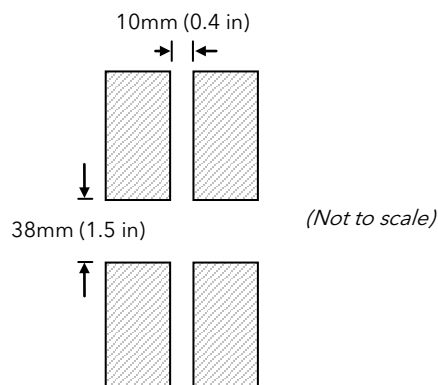

1.4.4 To Remove the Controller from its Sleeve

The controller can be unplugged from its sleeve by easing the latching ears outwards and pulling it forward out of the sleeve. When plugging it back into its sleeve, ensure that the latching ears click back into place to maintain the IP66 sealing.

1.5 Order Code

1.5.1 Hardware

1	2	3	4	5	6	7	8	9	10	11	12
Model	Function	Supply Voltage	OP1/2/3	OP4	Options	Label	Special	Warranty	Certificates	Accessories	Pre-configuration

1. Model No.	
P116	1/16 DIN size
P108	1/8 DIN size
P104	1/4 DIN size

2. Function	
CC	Controller

3. Supply Voltage	
VH	100 - 230Vac
VL	24Vac/dc

4. Outputs (OP1, OP2) P116	
LRX	OP1 Logic, OP2 Relay
RRX	OP1 Relay, OP2 Relay
RCX	OP1 Relay, OP2 Analogue isolated
LTX	OP1 Logic, OP2 Triac (not supported for supply voltage VL)
LLX	OP1 Logic, OP2 Logic
LCX	OP1 Logic, OP2 Analogue isolated

4. Outputs (OP1, OP2, OP3) P108 and 104	
LRR	OP1 Logic, OP2 Relay, OP3 Relay
RRR	OP1 Relay, OP2 Relay, OP3 Relay
RRC	OP1 Relay, OP2 Relay, OP3 Analogue isolated
LTR	OP1 Logic, OP2 Triac, OP3 Relay (not supported for supply voltage VL)
LLR	OP1 Logic, OP2 Logic, OP3 Relay
LRC	OP1 Logic, OP2 Relay, OP3 Analogue isolated

5. Output 4 (OP4)	
R	Changeover Relay

6. Options	
XXX	None
XCL	CT & Digital input 1
4CL	EIA485 + CT & Digital input 1

7. Custom Label	
XXXXXX	None

8. Special	
XXXXXX	No special required

9. Warranty	
XXXXX	Standard
WL005	Extended

10. Certificates	
XXXXX	None
CERT1	Certificate of conformity
CERT2	5 Point Factory Calibration

11. Accessories	
XXXXXX	None
RES250	250R resistor for 0-5Vdc OP
RES500	500R resistor for 0-10Vdc OP

12. Pre-configuration	
0	Quick code entry requested at first start up
F	Factory default table loaded
P	Quick code pre-loaded

Notes regarding Pre-configuration	
0	The controller will start up showing the request of SET1 followed by SET2. The values of SET1 and SET2 must be entered by the user when the controller is first powered up. See section 4.1.3.
F	Controller will start in operating mode with a predetermined set of parameters. See section 11.
P	The controller will start up with a preloaded set of characters as specified by the Configuration Code as defined in the next section.

1.5.2 Configuration Code

The controller can be ordered and supplied pre-configured and is shown by the code below.

(Note: These codes also correspond with the Quick Codes listed in section 4.1.3. where SET1 corresponds to tables 1, 2, 3 and 4 and SET2 corresponds to tables 5, 6, 7 and 8).

1	2	3	4	5	6	7	8
Input Type	Range	Output 1	Output 2	Output 3	Output 4	Digital Input 1	Digital Input 2

1. Input Type	
Thermocouple	
X	No input type specified
B	Type B
J	Type J
H	Type K
L	Type L
N	Type N
R	Type R
S	Type S
T	Type T
C	Custom/Type C
Resistance Thermometer	
P	Pt100
Linear	
V	0-80mV
2	0-20mA
4	4-20mA

2. Range	
X	No range specified
C	°C Full Range
F	°F Full Range
Celsius	
0	0-100
1	0-200
2	0-400
3	0-600
4	0-800
5	0-1000
6	0-1200
7	0-1400
8	0-1600
9	0-1800
Fahrenheit	
G	32-212
H	32-392
I	32-752
J	32-1112
L	32-1472
M	32-1832
N	32-2192
P	32-2552
R	32-2912
T	32-3272

3. Output 1	
X	No output specified
N	Unconfigured
Control	
H	PID heating - logic, relay
C	PID cooling - logic, relay
J	ON/OFF heating - logic, relay
F	ON/OFF cooling - logic, relay
Alarm 3	
0	High alarm
1	Low alarm
2	Deviation high
3	Deviation low
4	Deviation band
Event ⁽¹⁾	
E	Timer end status
R	Timer run status
Note (1) If the timer is configured as a Dwell Timer	

5. Output 2	
X	No output specified
N	Unconfigured
Control⁽²⁾	
H	PID heating - logic, relay or 4- 20 ma ⁽²⁾
C	PID cooling - logic, relay or 4- 20 mA ⁽²⁾
J	ON/OFF heating - logic, relay or 4- 20 mA ⁽²⁾
F	ON/OFF cooling - logic, relay or 4- 20 mA ⁽²⁾
Alarm 1	
0	High alarm
1	Low alarm
2	Deviation high
3	Deviation low
4	Deviation band
DC OUT	
Retransmission	
T	4 -20mA Set Point
U	4 -20mA Process Value
Y	4 -20mA Output power
A	0 -20mA Set Point
B	0 -20mA Process Value
D	0 -20mA Output power
Event ⁽¹⁾	
Timer events	
E	Timer end status
R	Timer run status
Note (1) If the timer is configured as a Dwell Timer	
Note (2) Output 2 can be DC linear on P116 only	

Configuration (Continued)

1	2	3	4	5	6	7	8
Input Type	Range	Output 1	Output 2	Output 3	Output 4	Digital Input 1	Digital Input 2

5. Output 3 (Only available in P108 and P104)			
X	No output specified		
N	Unconfigured		
Control			
H	PID heating - relay or 4- 20 mA		
C	PID cooling - relay or 4- 20 mA		
J	ON/OFF heating - relay or 4- 20 mA		
F	ON/OFF cooling - relay or 4- 20 mA		
Alarm 3	Energised in alarm	De-energised in alarm	
0	High alarm	5	High alarm
1	Low alarm	6	Low alarm
2	Deviation high	7	Deviation high
3	Deviation low	8	Deviation low
4	Deviation band	9	Deviation band
DC OUT	Retransmission		
T	4 -20mA Set Point		
U	4 -20mA Process Value		
Y	4 -20mA Output power		
A	0 -20mA Set Point		
B	0 -20mA Process Value		
D	0 -20mA Output power		
Event ⁽¹⁾	Timer events		
E	Timer end status		
R	Timer run status		
Note (1)	If the timer is configured as a Dwell Timer		

7. Digital Input 1	
X	Digital Input not specified
N	Unconfigured
A	Alarm acknowledge
S	Setpoint 2 select
L	Keylock
T	Timer reset
R	Timer run
U	Timer run/reset
H	Timer hold
M	Manual status
B	Standby mode

8. Digital Input 2	
X	Digital Input not specified
N	Unconfigured
A	Alarm acknowledge
S	Setpoint 2 select
L	Keylock
T	Timer reset
R	Timer run
U	Timer run/reset
H	Timer hold
M	Manual status
B	Standby mode

6. Output 4			
X	No output specified		
N	Unconfigured		
Control			
H	PID heating - relay		
C	PID cooling - relay		
J	ON/OFF heating - relay		
F	ON/OFF cooling - relay		
Alarm 2	Energised in alarm	De-energised in alarm	
0	High alarm	5	High alarm
1	Low alarm	6	Low alarm
2	Deviation high	7	Deviation high
3	Deviation low	8	Deviation low
4	Deviation band	9	Deviation band
Event ⁽¹⁾	Timer events		
E	Timer end status		
R	Timer run status		
Note (1)	If the timer is configured as a Dwell Timer		

Isolation Boundaries

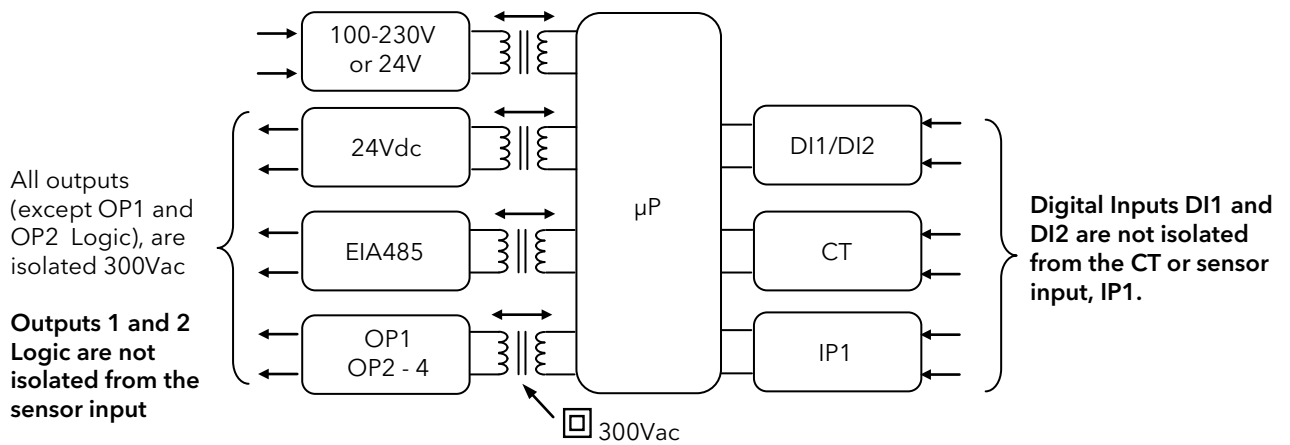

2.3 Wire Sizes

The screw terminals accept wire sizes from 0.5 to 1.5 mm (16 to 22AWG). Hinged covers prevent hands or metal making accidental contact with live wires. The rear terminal screws should be tightened to 0.4Nm (3.5lb in).

2.4 Controller Power Supply

1. Before connecting the instrument to the power line, make sure that the line voltage corresponds to the description on the identification label.
2. Use copper conductors only.
3. For 24V the polarity is not important
4. The power supply input is not fuse protected. This should be provided externally
 Recommended external fuse ratings are as follows:-
 For 24 V ac/dc, fuse type: T rated 2A 250V
 For 100-230Vac, fuse type: T rated 2A 250V.

2.4.1 High Voltage Power Supply

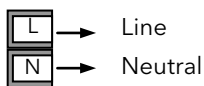

- 100 to 230Vac, ±15%, 48 to 62 Hz
- Power rating P116: 6W; P108 and P104: max 9W

2.4.2 Low Voltage Power Supply

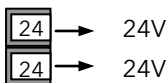

- 24Vac, -15%, +10%
- 24Vdc, -15%, +20% ± 5% ripple voltage
- Power rating P116: 6W; P108 and P104: max 9W

2.5 Sensor Input (Measuring Input)

Precautions

- Do not run input wires together with power cables
- When shielded cable is used, it should be grounded at one point only
- Any external components (such as zener barriers, etc) connected between sensor and input terminals may cause errors in measurement due to excessive and/or un-balanced line resistance or possible leakage currents
- The sensor input is not isolated from the logic outputs & digital inputs
- Pay attention to line resistance; a high line resistance may cause measurement errors
- A single sensor should not be connected to more than one instrument. Sensor break operation could be severely compromised

2.5.1 Thermocouple Input



- Use the correct compensating cable preferably shielded

2.5.2 RTD Input

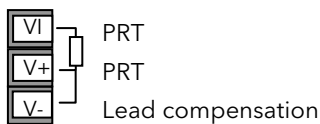

- The resistance of the three wires must be the same. The line resistance may cause errors if it is greater than 22Ω

2.5.3 Linear Input (mA or mV)

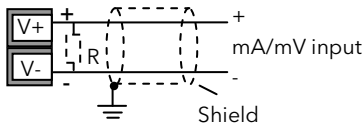

- If shielded cable is used it should be grounded in one place only as shown
- For a mA input connect the 2.49Ω burden resistor (R) supplied between the + and - input terminals as shown. The resistor supplied is 1% accuracy 50 ppm.

2.5.4 Linear Input (Volts)

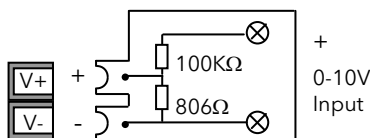

- For a 0-10Vdc input an external input adapter is required (not supplied). Part number: SUB21/IV10
- Sensor break alarm does not operate with this adaptor fitted.

2.5.5 Two-Wire Transmitter Inputs

Using internal 24V power supply (P108 and P104 only)

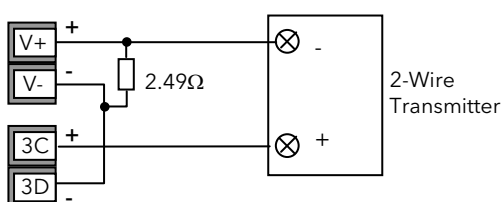

All models using an external power supply

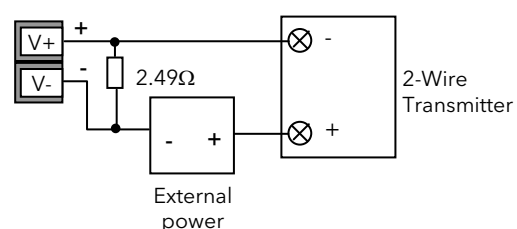

2.6 Output 1

This output is available in all models and can be logic (SSR drive), or relay, depending on the order code. For output functions, see Quick Start Code in section 4.1.1 or 'P' Codes in section 5.2.

2.6.1 Relay Output (Form A, normally open)

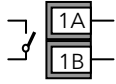

- Isolated output 300Vac CAT II
- Contact rating: 2A 230Vac $\pm 15\%$ resistive

2.6.2 Logic (SSR drive) Output

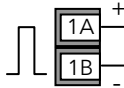

- **Not isolated from the sensor input, the current transformer input or the digital inputs**
- Output ON state: 12Vdc at 40mA max
- Output OFF state: <300mV, <100 μ A
- The output switching rate must be set to prevent damage to the output device in use. See parameter 1.PLS in section 4.7.2.

2.7 Output 2

Output 2 is available in all models.

In P116 it can be ordered as Relay, Analogue, Triac or Logic.

In P108 and P104 it can be ordered as Relay, Triac or Logic.

For output functions, see Quick Start Code in section 4.1.1 or 'P' Codes in section 5.2.

2.7.1 Relay Output (Form A, normally open)

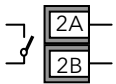

- Isolated output 300Vac CAT II
- Contact rating: 2A 230Vac $\pm 15\%$ resistive

2.7.2 DC Output (P116 only)

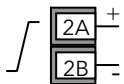

- Output isolated 300Vac
- Software configurable: 0-20mA or 4-20mA.
- Max load resistance: 500 Ω
- Calibration accuracy: $\pm (<1\%$ of reading + <100 μ A)

2.7.3 Triac Output

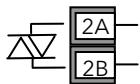

- Isolated output 300Vac CATII
- Rating: 0.75A rms, 30Vac (minimum) to 230Vac $\pm 15\%$ resistive

2.7.4 Logic (SSR drive) Output

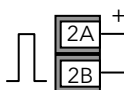

- **Not isolated from the sensor input, the current transformer input or the digital inputs**
- Output ON state: 12Vdc at 40mA max
- Output OFF state: <300mV, <100 μ A
- The output switching rate must be set to prevent damage to the output device in use. See parameter 2.PLS in section 4.7.2.

2.8 Output 3

Output 3 is only available in the models P108 and P104. It will be either a Relay or Analogue output depending on the order code.

For output functions, see Quick Start Code in section 4.1.1. or 'P' codes in section 5.2.

2.8.1 Relay Output (Form A, normally open)

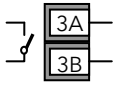

- Isolated output 300Vac CAT II
- Contact rating: 2A 230Vac $\pm 15\%$ resistive

2.8.2 DC Output

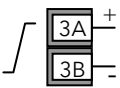

- Isolated output 300Vac CAT II
- Software configurable: 0-20mA or 4-20mA
- Max load resistance: 500 Ω
- Calibration accuracy: $\pm (<0.25\%$ of reading + $<50\mu\text{A}$)

2.9 Output 4 (AA Relay)

Output 4 is a changeover relay (Form C) and is available in all models.

For output functions, see Quick Start Code in section 4.1.1 or 'P' Codes in section 5.2.

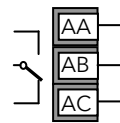

- Isolated output 300Vac CAT II
- Contact rating: 2A 230Vac $\pm 15\%$ resistive

2.10 General Note About Relays and Inductive Loads

High voltage transients may occur when switching inductive loads such as some contactors or solenoid valves. Through the internal contacts, these transients may introduce disturbances which could affect the performance of the instrument.

For this type of load it is recommended that a 'snubber' is connected across the normally open contact of the relay switching the load. The snubber recommended consists of a series connected resistor/capacitor (typically 15nF/100 Ω). A snubber will also prolong the life of the relay contacts.

A snubber should also be connected across the output terminal of a triac output to prevent false triggering under line transient conditions.

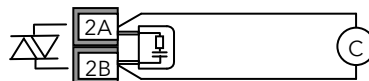
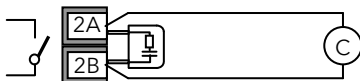

WARNING

When the relay contact is open or it is connected to a high impedance load, the snubber passes a current (typically 0.6mA at 100Vac and 1.2mA at 230Vac). You must ensure that this current will not hold on low power electrical loads. If the load is of this type the snubber should not be connected.

2.11 Digital Inputs DI1 & DI2

Digital input 1 is an optional input in all P100 series controllers.

Digital input 2 is always fitted in models P108, and P104, but is not available in P116.

Digital in 1

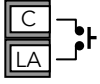

Digital in 2

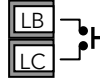

- **Not isolated from the current transformer input, the sensor input or logic outputs**
- Switching: 12Vdc at 40mA max
- Contact open > 600Ω. Contact closed < 300Ω
- Input functions: Please refer to the list in the quick codes, section 4.1.3.

2.12 Current Transformer

The current transformer input is an optional input in all P100 series controllers.

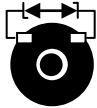

- **C terminal is common to both the CT input and Digital input 1. They are, therefore, not isolated from each other, the sensor input or the logic outputs.**
- CT input current: 0-50mA rms (sine wave, calibrated) 50/60Hz
- A burden resistor, value 10Ω, is fitted inside the controller.
- It is recommended that the current transformer is fitted with a voltage limiting device to prevent high voltage transients if the controller is unplugged. For example, two back to back zener diodes. The zener voltage should be between 3 and 10V, rated at 50mA.
- CT input resolution: 0.1A for scale up to 10A, 1A for scale 11 to 100A
- CT input accuracy: $\pm 4\%$ of reading.

2.13 Transmitter Power Supply

The Transmitter Supply is not available in the Model P116.

It is fitted as standard in the Models P108 and P104.

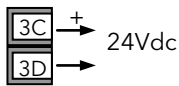

- Isolated output 300Vac CAT II
- Output: 24Vdc, +/- 10%. 28mA max.

2.14 Digital Communications

Optional.

Digital communications uses the Modbus protocol EIA485 2-wire (formerly RS485).

☺ Cable screen should be grounded at one point only to prevent earth loops.

- Isolated 300Vac CAT II.

EIA485 Connections

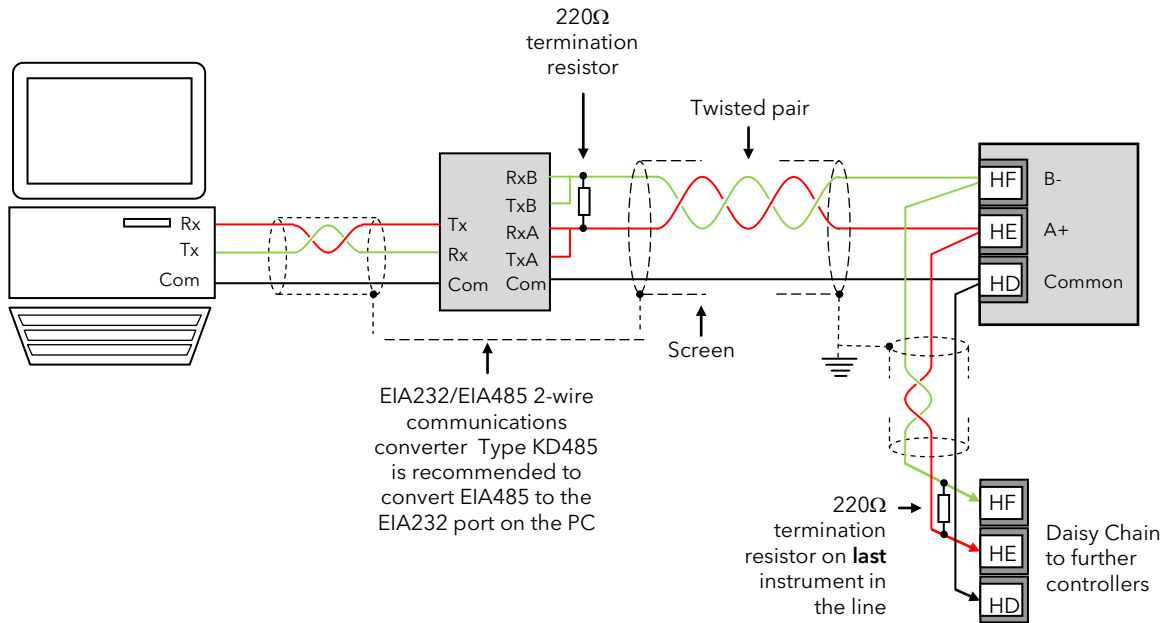

Note:

The device physical interface can only support up to 31 devices for each segment. More than 31 devices will require additional buffering. For more details see the Communications Manual HA026230 which can be downloaded from www.eurotherm.co.uk.

2.15 Wiring Examples

2.15.1 Heat/Cool Controller

This example shows a heat/cool temperature controller where the heater control uses a SSR, triggered by a logic output on OP1, and the cooling control uses the relay, OP4.

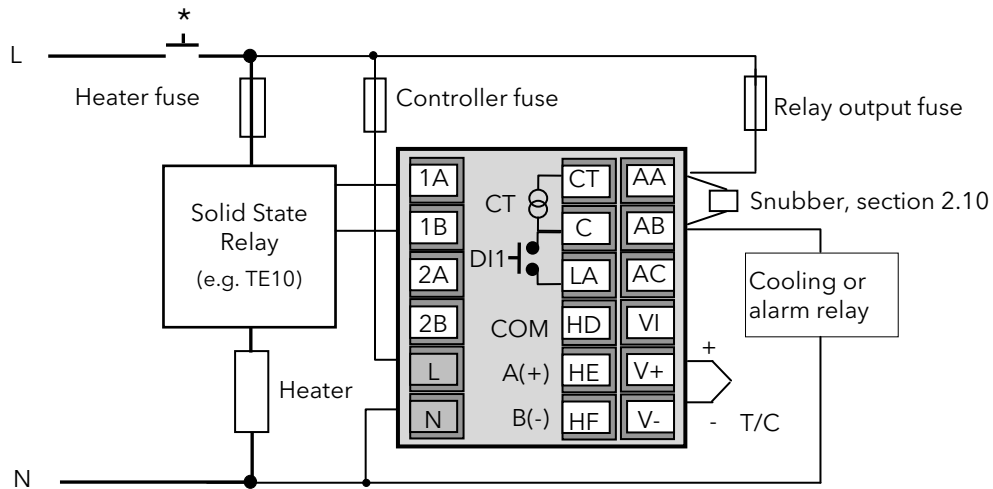

* Safety requirements for permanently connected equipment state:

- A switch or circuit breaker shall be included in the building installation
- It shall be in close proximity to the equipment and within easy reach of the operator
- It shall be marked as the disconnecting device for the equipment

☺ A single switch or circuit breaker can drive more than one instrument

2.15.2 CT Wiring Diagram

This diagram shows an example of wiring for a CT input.

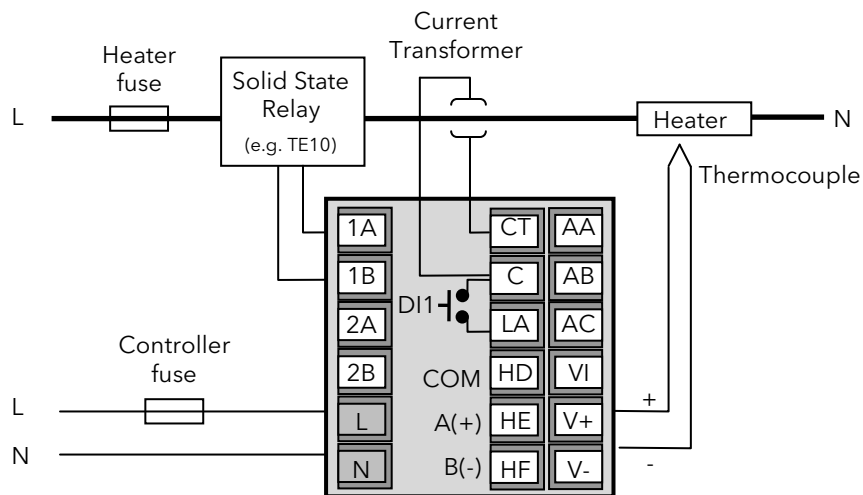

Note: a burden resistor value 10Ω is mounted inside the controller.

To prevent a build up of high voltages at the output of the CT if it is disconnected from the controller, it is recommended that a voltage limiting device be connected directly across the output of the CT. A suitable device is two back to back zener diodes, rated between 3 and 10V at 50mA, as shown.

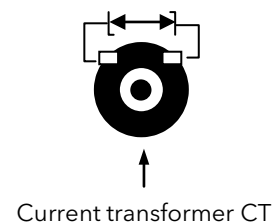

3. Safety and EMC Information

This controller is intended for industrial temperature and process control applications when it will meet the requirements of the European Directives on Safety and EMC. Use in other applications, or failure to observe the installation instructions of this manual may impair safety or EMC. The installer must ensure the safety and EMC of any particular installation.

Safety

This controller complies with the European Low Voltage Directive 2006/95/EC, by the application of the safety standard EN 61010.

Electromagnetic compatibility

This controller conforms with the essential protection requirements of the EMC Directive 2004/108/EC, by the application of a Technical Construction File. This instrument satisfies the general requirements of the industrial environment defined in EN 61326. For more information on product compliance refer to the Technical Construction File.

GENERAL

The information contained in this manual is subject to change without notice. While every effort has been made to ensure the accuracy of the information, your supplier shall not be held liable for errors contained herein.

Unpacking and storage

The packaging should contain an instrument mounted in its sleeve, two mounting brackets for panel installation and an Installation & Operating guide. Certain ranges are supplied with an input adapter.

If on receipt, the packaging or the instrument are damaged, do not install the product but contact your supplier. If the instrument is to be stored before use, protect from humidity and dust in an ambient temperature range of -20°C to +70°C.

Service and repair

This controller has no user serviceable parts. Contact your supplier for repair.

Caution: Charged capacitors

Before removing an instrument from its sleeve, disconnect the supply and wait at least two minutes to allow capacitors to discharge. It may be convenient to partially withdraw the instrument from the sleeve, then pause before completing the removal. In any case, avoid touching the exposed electronics of an instrument when withdrawing it from the sleeve.

Failure to observe these precautions may cause damage to components of the instrument or some discomfort to the user.

Electrostatic discharge precautions

When the controller is removed from its sleeve, some of the exposed electronic components are vulnerable to damage by electrostatic discharge from someone handling the controller. To avoid this, before handling the unplugged controller discharge yourself to ground.

Cleaning

Do not use water or water based products to clean labels or they will become illegible. Isopropyl alcohol may be used to clean labels. A mild soap solution may be used to clean other exterior surfaces of the product.

3.1 Installation Safety Requirements

Safety Symbols

Various symbols may be used on the controller. They have the following meaning:



Refer to manual.



Risk of electric shock.



Take precautions against static.



C-tick mark for Australia (ACA) and New Zealand (RSM).



Complies with the 40 year Environment Friendly Usage Period.



Restriction of Hazardous Substances



Protected by DOUBLE ISOLATION.



Helpful hints

Personnel

Installation must only be carried out by suitably qualified personnel in accordance with the instructions in this manual.

Enclosure of Live Parts

To prevent hands or metal tools touching parts that may be electrically live, the controller must be enclosed in an enclosure.

Caution: Live sensors

The controller is designed to operate if the temperature sensor is connected directly to an electrical heating element. However you must ensure that service personnel do not touch connections to these inputs while they are live. With a live sensor, all cables, connectors and switches for connecting the sensor must be mains rated for use in 230Vac \pm 15% CATII..

Wiring

It is important to connect the controller in accordance with the wiring data given in this guide. Take particular care not to connect AC supplies to the low voltage sensor input or other low level inputs and outputs. Only use copper conductors for connections (except thermocouple inputs) and ensure that the wiring of installations comply with all local wiring regulations. For example in the UK use the latest version of the IEE wiring regulations, (BS7671). In the USA use NEC Class 1 wiring methods.

Power Isolation

The installation must include a power isolating switch or circuit breaker. This device should be in close proximity to the controller, within easy reach of the operator and marked as the disconnecting device for the instrument.

Overcurrent protection

The power supply to the system should be fused appropriately to protect the cabling to the units.

Voltage rating

The maximum continuous voltage applied between any of the following terminals must not exceed 230Vac \pm 15%:

- relay output to logic, dc or sensor connections;
- any connection to ground.

The controller must not be wired to a three phase supply with an unearthed star connection. Under fault conditions such a supply could rise above 264Vac with respect to ground and the product would not be safe.

Conductive pollution

Electrically conductive pollution must be excluded from the cabinet in which the controller is mounted. For example, carbon dust is a form of electrically conductive pollution. To secure a suitable atmosphere in conditions of conductive pollution, fit an air filter to the air intake of the cabinet. Where condensation is likely, for example at low temperatures, include a thermostatically controlled heater in the cabinet.

This product has been designed to conform to BSEN61010 installation category II, pollution degree 2. These are defined as follows:-

Installation Category II (CAT II)

The rated impulse voltage for equipment on nominal 230V supply is 2500V.

Pollution Degree 2

Normally only non-conductive pollution occurs. Occasionally, however, a temporary conductivity caused by condensation shall be expected.

Grounding of the temperature sensor shield

In some installations it is common practice to replace the temperature sensor while the controller is still powered up. Under these conditions, as additional protection against electric shock, we recommend that the shield of the temperature sensor is grounded. Do not rely on grounding through the framework of the machine.

Over-temperature protection

When designing any control system it is essential to consider what will happen if any part of the system should fail. In temperature control applications the primary danger is that the heating will remain constantly on. Apart from spoiling the product, this could damage any process machinery being controlled, or even cause a fire.

Reasons why the heating might remain constantly on include:

- the temperature sensor becoming detached from the process
- thermocouple wiring becoming short circuit;
- the controller failing with its heating output constantly on
- an external valve or contactor sticking in the heating condition
- the controller setpoint is set too high.

Where damage or injury is possible, we recommend fitting a separate over-temperature protection unit, with an independent temperature sensor, which will isolate the heating circuit.

Please note that the alarm relays within the controller will not give protection under all failure conditions.

Installation requirements for EMC

To ensure compliance with the European EMC directive certain installation precautions are necessary as follows:

- For general guidance refer to Eurotherm Controls EMC Installation Guide, HA025464.
- When using relay outputs it may be necessary to fit a filter suitable for suppressing the emissions. The filter requirements will depend on the type of load.
- If the unit is used in table top equipment which is plugged into a standard power socket, then it is likely that compliance to the commercial and light industrial emissions standard is required. In this case to meet the conducted emissions requirement, a suitable mains filter should be installed.

Routing of wires

To minimise the pick-up of electrical noise, the low voltage DC connections and the sensor input wiring should be routed away from high-current power cables. Where it is impractical to do this, use shielded cables with the shield grounded at both ends. In general keep cable lengths to a minimum.

4. Switch On

Whenever the controller is switched on (powered up) it will start in a diagnostic mode lasting for a few seconds. The diagnostic display illuminates all bars of each character and every beacon. This is followed by the firmware version number and the instrument type number as shown below for each model.

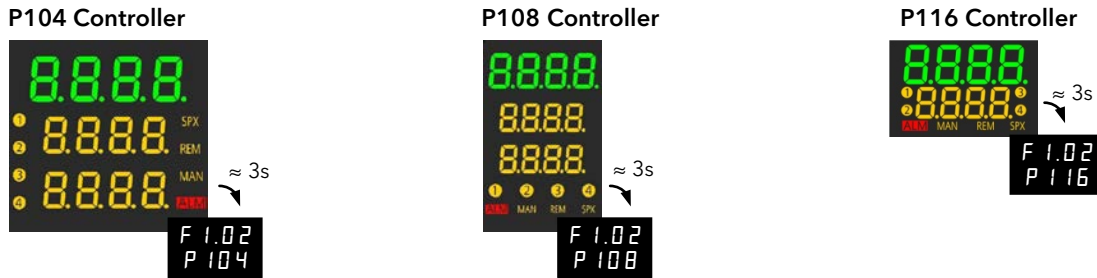

The display that automatically follows depends on the way the controller has been supplied or re-configured and is described in the following sections.

4.1 New Unconfigured Controller

If the controller is supplied new with the Configuration Code = 'P' (section 1.5.2) then it is unconfigured and will start up requesting the 'Quick Configuration' codes. This is a built in tool which enables you to quickly configure commonly used functions such as the input type and range, the outputs and digital input functions.



Incorrect configuration can result in damage to the process and/or personal injury and must be carried out by a competent person authorised to do so. It is the responsibility of the person commissioning the controller to ensure the configuration is correct.

4.1.1 Quick Configuration Code

The quick configuration code consists of two 'SETS' of four characters. The upper section of the display shows the set selected, the lower section shows the four digits which make up the set.



Adjust these as follows:-

1. The first character '-' will be flashing.
2. Press ▲ or ▼ to enter the required code shown in the quick code tables - section 4.1.3
3. Press ↵ accept the change and to scroll to the next character.
- ☺ You cannot scroll to the next character until the current character is configured.
- ☺ To return to the first character press ⏪
4. When all four characters have been configured the display will go to Set 2.

5. When the last digit has been entered press ↵ again, the display will show



6. Press ▲ or ▼ to YES done and ↵ to accept.



The controller will then automatically go to the operator level, section 4.2.

4.1.2 To Load the Factory Default Data

Instead of entering each character individually, it is possible to load the factory default data directly.

See section 11 for the factory default values.

1. When the SEt 1 shows "----"
2. Press ↵

3. The display will jump to



4. Press ▲ or ▼ to YES done and ↵ to accept.



The controller will then automatically go to the operator level, section 4.2.

4.1.3 Quick Code Tables

Note: The Quick Code Tables are a repeat of the Order Code tables - section 1.5.2.



1. Input Type	
Thermocouple	
b	Thermocouple type B
J	Thermocouple type J
H	Thermocouple type K
L	Thermocouple type L
C	Thermocouple type C or Custom linearisation
n	Thermocouple type N
r	Thermocouple type R
S	Thermocouple type S
t	Thermocouple type T
RTD	
P	Platinum resistance thermometer type Pt100
mV / mA	
u	0-80mV
z	0-20mA
y	4-20mA

2 Range	
C	°C Full range
F	°F Full range
Celsius	
0	0-100
1	0-200
2	0-400
3	0-600
4	0-800
5	0-1000
6	0-1200
7	0-1400
8	0-1600
9	0-1800
Fahrenheit	
G	32-212
H	32-392
i	32-752
J	32-1112
L	32-1472
n	32-2192
P	32-2552
r	32-2912
t	32-3272

3. Output OP1 - Alarm 3	
n	Unconfigured
H	PID Heating
C	PID Cooling
J	ON/OFF Heating
F	ON/OFF Cooling
Alarm: energised in alarm	
0	High alarm
1	Low alarm
2	Deviation high
3	Deviation low
4	Deviation band
Alarm: de-energised in alarm	
5	High alarm
6	Low alarm
7	Deviation high
8	Deviation low
9	Deviation band
Event	
E	End status
r	Run status

4. Output OP2 - Alarm 1	
n	Unconfigured
H	PID Heating
J	ON/OFF Heating
C	PID Cooling
F	ON/OFF Cooling
Alarm: energised in alarm	
0	High alarm
1	Low alarm
2	Deviation high
3	Deviation low
4	Deviation band
Alarm: de-energised in alarm	
5	High alarm
6	Low alarm
7	Deviation high
8	Deviation low
9	Deviation band
DC Retransmission (P116)	
t	4-20mA Setpoint
u	4-20mA PV
y	4-20mA Output
r	0-20mA Setpoint
b	0-20mA PV
d	0-20mA Output
Event	
E	End status
r	Run status

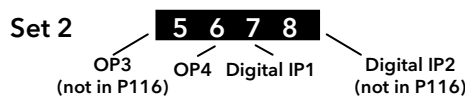

5. Output OP3 - Alarm 3 (only available in P108 and P104)	
n	Unconfigured
H	PID Heating
C	PID Cooling
J	ON/OFF Heating
F	ON/OFF Cooling
Alarm: energised in alarm	
0	High alarm
1	Low alarm
2	Deviation high
3	Deviation low
4	Deviation band
Alarm: de-energised in alarm	
5	High alarm
6	Low alarm
7	Deviation high
8	Deviation low
9	Deviation band
DC Retransmission	
t	4-20mA Setpoint
u	4-20mA PV
y	4-20mA Output
r	0-20mA Setpoint
b	0-20mA PV
d	0-20mA Output
Event	
E	End status
r	Run status

6. Output OP4 - Alarm 2	
n	Unconfigured
H	PID Heating
J	ON/OFF Heating
C	PID Cooling
F	ON/OFF Cooling
Alarm: energised in alarm	
0	High alarm
1	Low alarm
2	Deviation high
3	Deviation low
4	Deviation band
Alarm: de-energised in alarm	
5	High alarm
6	Low alarm
7	Deviation high
8	Deviation low
9	Deviation band
Event	
E	End status
r	Run status

7. Digital Input 1	
r	Alarm acknowledge
S	Setpoint 2 select
L	Keylock
t	Timer reset
r	Timer run
u	Timer run/reset
H	Timer hold
n	Manual select
b	Standby mode (outputs off)
n	Unconfigured

8. Digital Input 2 (P108 & P104 only)	
r	Alarm acknowledge
S	Setpoint 2 select
L	Keylock
t	Timer reset
r	Timer run
u	Timer run/reset
H	Timer hold
n	Manual select
b	Standby mode (outputs off)
n	Unconfigured

Example

J C H C

5 6 r S

Set 1 - Thermocouple type J, °C, OP1 PID heating, OP2 PID cooling.

Set 2 - OP3 (P108 & P104 only) high alarm, OP4 low alarm, alarm acknowledge on logic input 1, setpoint select on logic input 2.

4.1.4 Alarm Allocation using the Quick Code

Alarms have a fixed assignment when they are set up by means of the 'Quick Codes'. The assignment is :-

OP1 → AL3

OP2 → AL1

OP3 → AL3. If OP1 and OP2 have been allocated to heat/cool then AL3 defaults to Output 3.

OP4 → AL2. If OP1 and OP2 have been allocated to heat/cool then AL2 defaults to Output 4.

In the example shown in the previous section AL2 operates OP4 and AL3 operates AL3, AL1 is not available.

The table below shows some examples of how alarms are allocated for different 'Quick Codes':-

Quick Code	OP1	OP2	OP3	OP4	
JCHC 56nn	Heat	Cool	AL3	AL2	AL1 is not used
JCHS nnnn	Heat	AL1			No heat/cool
JCS6 nnnn	AL3	AL1			AL2 is not used
JCHS 6Cnn	Heat	AL1	AL3	Cool	AL2 is not used
JCHS 6nnn	Heat	AL1	AL3		AL2 is not used
JCHS 67nn	Heat	AL1	AL3	AL2	

4.1.5 To Re-Enter Quick Code mode

If you need to re-enter the 'Quick Configuration' mode it is necessary to do a Cold Start:-

Warning: A Cold Start will remove all previous configurations. It is recommended that a clone file (section 10.7) is taken of the controller before attempting a cold start.

To Cold Start the controller refer to section 5.2.22.

4.1.6 Summary of Start-up Displays

In addition to the above mode, the controller may also be ordered with a factory pre-determined set of parameters loaded as defined by Configuration Order Code F, or with the quick codes pre-loaded as defined by Configuration Order Code P. A summary of the start up display is shown below for all three modes.

Software Order Code 'O'.

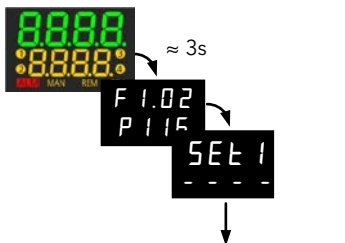

Quick Codes must be entered as described in section 4.1.1.

Software Order Code 'F'.



Quick Codes are not requested or displayed

Software Order Code 'P'.

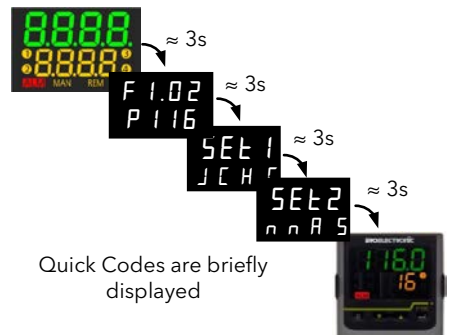

Quick Codes are briefly displayed

4.1.7 Subsequent Start-ups

Whenever the controller is powered up it will run through the diagnostic mode. It will then always start in **Operator Level 1** and show the default or 'HOME' display - section 4.2.

The start up procedure for an existing controller is slightly different depending how the controller has been configured.

If the controller has been configured using the Quick Configuration procedure only, section 4.1.1, then the Quick codes are also displayed for a few seconds whenever the controller is switched on.

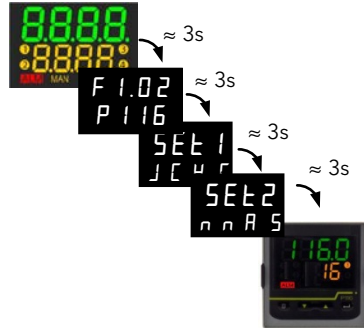

If the factory default data - section 4.1.2. is entered OR the controller is configured or re-configured using the 'P' codes the quick codes are not shown during start up since they may no longer be relevant



4.2 Front Panel Layout

P104 Controller



← Measured Temperature (or Process Value 'PV')
 ← Target Temperature * (Setpoint 'SP')
 ← Output Power demand *

P108 Controller



Measured Temperature (or Process Value 'PV') →
 Target Temperature * (Setpoint 'SP') →

P116 Controller



Beacons 1 2 3 4	
ALM	Alarm active (Red)
1	Lit when output 1 is ON (typically heating)
2	Lit when output 2 is ON (typically cooling)
3	Lit when output 3 is ON (P108 & P104 only)
4	Lit when output 4 is ON (typically alarm)
SPX	Alternative setpoint in use (SP2)
REM	Digital communications active (flashing)
MAN	Manual mode selected

Operator Buttons	
	Scroll button. Press to scroll forward through a list of parameters. Hold down to scroll continuously.
	Page button. Press to scroll back through a list of parameters. Hold down to select a different operating level. This button can be assigned a specific function - see 'P' code P73 section 5.2.18.
	Press to decrease a value.
	Press to increase a value.
Press and together to return to the operating display.	
F1	Function key 1
F2	Function key 2

Alpha-Numeric Display		
Top row	Measured Temperature (Process Value, PV) or the value of a selected parameter	
* Second Line	Target Temperature (Setpoint, SP) or the mnemonic of a selected parameter	These are the default parameters. They may be customised to show alternative parameters to suit the requirements of a particular process, see section 5.2.19.
* Third Line	Output power demand	

4.2.1 To Set The Target Temperature (Setpoint 'SP').

From the HOME display:-

Press  to raise the setpoint

Press  to lower the setpoint

The units (if configured *) are displayed briefly when either button is first pressed. If either button is pressed repeatedly the units are not displayed - it requires about 1 second between button presses for the units to be displayed again.



The new setpoint is entered when the button is released and is indicated by a brief flash of the display.

* Units are configured in Operator Level 2, section 4.7.2.









4.3 Level 1 Operator Parameters

A minimal list of parameters is available in Operator Level 1 which is designed for day to day use. Access to these parameters is not protected by a pass code.

Press  to step through the list of available parameters. The mnemonic of the parameter is shown in the lower display.

The value of the parameter is shown in the upper display. Press  or  to adjust this value. If no key is pressed for 30 seconds the controller returns to the HOME display.

The parameters that appear depend upon the functions configured. They are:-

Parameter Mnemonic	Description and Alterability	Further Information
<i>OP</i>	Output power. This is read only when the controller is in 'Auto' or 'OFF' mode and shows the current output power demand. In a temperature control application, 100% = full heating, -100% = full cooling. When the controller is in 'Manual' mode the output power demand can be adjusted using  or  .	Auto/Manual/Off mode is described in section 4.10
<i>SP</i>	Current setpoint. This is read only when the controller is in 'Manual' or 'OFF' mode.	
<i>ACK</i>	Alarm acknowledge - Yes or no. This parameter only appears if a latching alarm is configured.	Section 4.4.3
<i>EST</i>	Status of timer - Run, Reset, Hold, End. This parameter only appears if the timer function is configured.	Section 4.12 Timer Operation.
<i>SP1</i>	Setpoint 1 value. Press  or  to raise or lower setpoint 1.	
<i>SP2</i>	Setpoint 2 value. Press  or  to raise or lower setpoint 2.	
<i>TEL</i>	Time elapsed. Hours or minutes depending on configuration. This parameter only appears if the timer function is configured. It is read only.	'P' Code P42
<i>TER</i>	Time remaining. Hours or minutes depending on configuration. This parameter only appears if the timer function is configured. The time may be extended or reduced when the timer is running by pressing  or  .	'P' Code P42
<i>EPRr</i>	Energy counter partial value This parameter is read only and is intended to measure energy usage for specific batches. It is also possible to configure the second or third line of the display to read this value	'P' Code P74
<i>ETot</i>	Energy counter total value This parameter is read only and is intended to measure energy usage for a complete process which might consist of a number of batches. It is also possible to configure the second or third line of the display to read this value	'P' Code P75
Note: <i>EPRr</i> and <i>ETot</i> can be reset using the parameter <i>ERSt</i> . This is normally available in Operator Level 2 (section 4.7.2), but it is possible to 'promote' it to Level 1 using iTools configuration package. Alternatively, it is possible to customise pushbuttons F1, F2 or  to display <i>ERSt</i> .		iTools section 10.5.3. 'P' Codes P71, P72 or P73.
		☺ P codes are found in section 5.2.

4.4 Alarms

Alarms are used to alert an operator when a pre-set level has been exceeded. They are indicated by flashing the alarm number and the red ALM beacon in the display.

Up to three process alarms may be configured using the Quick Start Codes, section 4.1.1. or 'P' Codes **P21 to P29**.

They may also switch an output, usually a relay, to allow external devices to be operated when an alarm occurs ('P' code **P11 to P14**).

Each alarm can be configured to the types listed below:-

Alarm Type	Description
Full Scale Low	The alarm is shown if the process value falls below an absolute threshold
Full Scale High	The alarm is shown if the process value rises above an absolute threshold
Deviation Low	The alarm is shown if the process value deviates below the setpoint by a set threshold
Deviation High	The alarm is shown if the process value deviates above the setpoint by a set threshold
Deviation Band	The alarm is shown if the process value deviates above or below the setpoint by a set threshold

😊

'P' codes are found in section 5.2.

In addition to the above alarms the following alarm types may be configured:-



Sensor Break	If the sensor becomes open circuit the alarm message 5br is flashed in the display. The controller control outputs can be configured to output a 'safe' value. ('P' code P36).
Excess Current	An alarm will be indicated if the current is exceeded. ('P' code P33). Current alarms can be Load, Leakage, Overcurrent
Loop Break	The loop is considered to be broken if the PV does not respond to a change in the output in a given time. ('P' code P34).

If an alarm is not configured it is not shown in the list of level 2 parameters shown in section 4.7.2.

4.4.1 To Set Alarm Setpoints

The levels at which alarms operate are adjusted by the alarm setpoint parameters **AL1**, **AL2** or **AL3**. By default, these can only be set in Operator Level 2*, (section 4.7.2). If the controller is configured to measure load conditions, parameters **LdAL**, **LEAL**, **HcAL** are used to set alarm setpoints for load currents.

Press  until the required alarm setpoint is shown *.

Press  or  to raise or lower the alarm setpoint.

Press  to accept the value.







* The alarm setpoint parameters can be 'promoted' to Level 1 using iTools (section 10.5.3).

4.4.2 Alarm Indication

If an alarm occurs, the red **ALM** beacon will flash together with the alarm number, for example **AL1**. If more than one alarm is present each alarm number is flashed in turn. Any output (usually a relay) attached to an alarm will operate. An alarm relay can be configured, using the Quick Start Codes or the 'P' codes P11 to P14, to be energised or de-energised in the alarm condition. It is normal to configure the relay to be de-energised in alarm so that an alarm is indicated if power to the controller fails.

4.4.3 To Acknowledge an Alarm

There are three ways in which an alarm can be acknowledged:

- In all cases an alarm can be acknowledged in Level 2, or in Level 1 if it is a latching alarm, as follows:-
 - Press  to select **AcAL** (Alarm Acknowledge). This parameter is always present in operator level 2, unless a function key has been configured for Alarm Acknowledge ('P' code P71, P72 or P73).
 - Press  or  to select **YES**.
 - Press  to accept.
- By operating an external pushbutton attached to Digital Input 1 or 2, if either of these have been configured for Alarm Acknowledge ('P' code **P51 and P52**).
- Press  or  or  if any of these buttons have been configured for Alarm Acknowledge ('P' codes **P71, P72 and P73**).

If the alarm is still present the ALM beacon will light continuously and the alarm message will continue to flash.

The action which takes place depends on the latching type of the alarm configured, as described in the next section.

4.4.4 Alarm Latching

Alarm latching is used to hold the alarm condition active once an alarm has been detected. Alarm Latching is configured using 'P' codes, **P22** (Alarm 1), **P25** (Alarm 2), **P28** (Alarm 3), **P33** (CT Alarm) as:-

☺
'P' codes are found
in section 5.2.

<i>nonE</i>	Non latching	A non latching alarm will reset itself when the alarm condition is removed. If it is still present when acknowledged the ALM beacon illuminates constantly, the flashing alarm messages remain and the output remains active.	
<i>Auto</i>	Automatic	An auto latching alarm requires acknowledgement before it is reset. The acknowledgement can occur BEFORE the condition causing the alarm is removed. An example of the action for Alarm 1 attached to OP4 is described below:	
		Alarm 1 occurs	ALM and <i>RL 1</i> flash. 4 is ON.
		Acknowledge (the alarm is still present)	ALM is constant. <i>RL 1</i> remains flashing, 4 is ON.
		Alarm 1 condition is removed.	All conditions are reset.
		Alarm 1 occurs	ALM and <i>RL 1</i> flash. 4 is ON.
		Alarm 1 condition is removed	ALM and <i>RL 1</i> flash. 4 is ON.
<i>MAN</i>	Manual	The alarm continues to be active until both the alarm condition is removed AND the alarm is acknowledged. The acknowledgement can only occur AFTER the condition causing the alarm is removed. An example of the action for Alarm 1 attached to OP4 is described below:	
		Alarm 1 occurs	ALM and the alarm number flash. 4 is ON.
		Acknowledge (the alarm is still present)	The alarm indication and output continue to show alarm.
		Alarm 1 condition is removed.	The alarm indication and output continue to show alarm.
		Acknowledge (the alarm condition has been removed)	The alarm indication and output are reset.
<i>NoAL</i>	No alarm	No alarm indication and no latching. An example of the action for Alarm 1 attached to OP4 is described below:	
		Alarm 1 occurs	4 is ON.
		Acknowledge (the alarm is still present)	4 is ON.
		Alarm 1 condition is removed.	4 is OFF.
		Alarm 1 occurs momentarily	4 is ON but reset as soon as Alarm 1 condition is removed.

By default alarms are configured as non-latching, de-energised in alarm.

It is possible to mix alarms between any of the latching types listed above. Each alarm so configured will behave independently.

4.4.5 Blocking Alarms

The alarm may be masked during start up. Blocking prevents the alarm from being activated until the process has first achieved a safe state. It is used, for example, to ignore start up conditions which are not representative of running conditions. Blocking is re-instated after a power cycle or when going from configuration level to an operating level.

Blocking alarms may be configured using 'P' codes **P23**, **P26** and **P29**.

It is possible to mix blocking alarms with any of the latching types listed above. Each alarm so configured will behave independently

4.4.6 Alarm Hysteresis

Hysteresis is the difference between the point at which the alarm switches 'ON' and the point at which it switches 'OFF'. It is used to provide a definite indication of the alarm condition and to prevent alarm relay chatter. It is particularly useful in conditions where the PV is noisy. Hysteresis is set in Level 2.

4.4.7 Sensor Break Alarm, *Sbr*

A sensor break alarm occurs if the sensor or its connections to the sensor input become open circuit or greater than a high impedance, see section 5.2.14.1. It can be configured using 'P' code **P35** as follows:-

😊
P codes are found
in section 5.2.

<i>On</i>	This is the default state.	In operator levels 1 and 2, <i>Sbr</i> will flash in the display if the sensor is open circuit.
<i>LAL</i>	Latching	If an open circuit input occurs the alarm will be latched until acknowledged. The alarm will only reset after it has been repaired. It behaves the same as a latched alarm configured as <i>MAN</i> (Manual).
<i>oFF</i>	No sensor break alarm	An open circuit input will not be detected.

A sensor break alarm can operate independently of other alarms.

4.4.8 Sensor Break Safe Output Demand

If a sensor break alarm occurs *Sbr* is displayed and the output from the controller will adopt a 'Safe' level. This is set using 'P' code **P36**. The default is 0% which means that all control outputs are off. For a heat/cool controller the full range is -100% to +100%. It is not limited by the Output High and Low limits set in Operator Level 2. The level set must be chosen with care to make sure that the process does not over heat or over cool. It may, however, be useful to maintain a small amount of power to keep the process at a 'standby' temperature if the input sensor fails.

If the controller is in MAN mode (Auto/Manual = Man) *Sbr* is displayed, but the output power does not adopt the Safe value but will adopt the manually set level.

If the controller is in standby mode (Auto/Manual = OFF) *Sbr* will be displayed and the outputs will always go to off (0%).

4.4.9 Loop Break Alarm, *Lbr*

The control loop is considered to be broken if the PV does not respond to the output in a set amount of time.

It is configured by 'P' code P34, section 5.2.13.

If a loop break alarm occurs the ALM beacon flashes together with the message *Lbr* and OP3 (default) or any other output attached to the Loop Break Alarm operates.

If the PV then changes showing that the loop is responding, the loop break alarm condition disappears.

Acknowledgement of the loop break alarm sets the ALM beacon to constant if the alarm is still present - the *Lbr* message continues to flash and the output remains active.

Loop break detection works for all control algorithms, PID and ON-OFF.

A further description is given in section 7.1.10.

4.4.10 Current (CT) Alarms

If the load current is being measured using the Current Transformer option, there are three alarm types available:-

Mnemonic	Name	Alarm Message Displayed
<i>LdAL</i>	Load Current Alarm Setpoint	<i>CTLd</i>
<i>LEAL</i>	Leakage Current Alarm Setpoint	<i>CTLE</i>
<i>HeAL</i>	Overcurrent Alarm Setpoint	<i>CTHc</i>

The threshold levels for these alarms are set in Level 2.

4.4.11 EEPROM Write Frequency Warning, *E2Fr*

As stated in sections 8.3 and 8.4 the EEPROM used in the Piccolo range has a limited number of write cycles. If any parameter writing to the EEPROM (typically over digital communications) starts to approach the limit specified for the EEPROM, an advanced warning alarm is activated. The alarm is displayed in a similar manner to other alarms. It consists of the mnemonic *E2Fr*, followed by an identifier of the first parameter that has caused the warning. This is flashed in sequence with other active alarms in the second line of the display. The identifier is the parameter Modbus address (Hex), for example, *E2Fr*, flashing in sequence with 0018 identifies the SP1 parameter.

Should this alarm occur, it is essential that the parameter(s) identified are removed from the communications and, where possible, substituted by alternatives such as those stated in section 8.4 - 'EEPROM Write Cycles'. In the unlikely event that the identifier shows an address of Hex 4000 or above, this indicates that an internal parameter has exceeded the write rate and you should contact your supplier.

The calculation for the warning to be displayed is based upon a worst case write cycle of 100,000 over a 10 year minimum life span.

The hourly write rate to give a minimum 10 year life is calculated as follows:

$$\begin{aligned} \text{10 year rate} &= \text{Worst case life cycles} / \text{the number of hours in 10 years} \\ &= 100,000 / (10 * 365 * 24) \\ &= 1.1 \text{ writes per hour} \end{aligned}$$

When configuring, commissioning or starting/completing an operation it is conceivable for the number of writes to be greater than this rate. However, as this is not expected to continue for a long period, the warning will not be activated until a period of 6 hours has elapsed. The 6 hour check is overridden if the number of writes in a single hour is greater than a maximum threshold. This threshold has been set at 30 writes i.e. one every 2 minutes. This is to help conserve EEPROM cell life by informing the user early of a potential issue.

Note:

It is possible that during commissioning or development of a program a valid parameter is written to repetitively. This may cause the warning message to be displayed and under these circumstances it may be disregarded. If preferred, the message may be reset by power cycling the instrument. The warning must not be disregarded, however, if it appears during normal operation and the root cause must be identified.

4.4.12 Remote Setpoint Fail, *rEmF*

If the remote setpoint is enabled (address 276, section 8.7) then the Remote Setpoint parameter AltSP (address 26, section 8.7) is used as a setpoint provided that a value has been reached within a window of about 5 seconds. If no value is received then the controller falls back to the currently selected setpoint (SP1 or SP2) and an alarm is generated. The alarm consists of the mnemonic *rEmF* which is flashed in sequence with other active alarms in the second line of the display. The ALM beacon blinks at the same time.

The message disappears when remote setpoint values are sent within the time period.

4.5 Alarms Advanced

4.5.1 Behaviour of Alarms after a Power Cycle

The response of an alarm after a power cycle depends upon the latching type, whether it has been configured to be a blocking alarm, the state of the alarm and the acknowledge status of the alarm.

The response of active alarms after a power cycle is as follows:

For a non-latching alarm, blocking, if configured, will be re-instated. If blocking is not configured the active alarm will remain active. If the alarm condition has gone safe during the down time the alarm will return inactive.

For an auto-latching alarm, blocking, if configured, will be re-instated, only if the alarm had been acknowledged prior to the power cycle. If blocking is not configured or the alarm had not been acknowledged the active alarm will remain active. If the alarm condition has gone safe during the downtime the alarm will return inactive if it had been acknowledged prior to the power cycle else it will return safe but not acknowledged. If the alarm was safe but not acknowledged prior to the power cycle the alarm will return safe but not acknowledged.

For a manual-latching alarm, blocking will not be re-instated and the active alarm will remain active. If the alarm condition has gone safe during the downtime the alarm will return safe but not acknowledged. If the alarm was safe but not acknowledged prior to the power cycle the alarm will return safe but not acknowledged.

The following examples show graphically the behaviour under different conditions:-

4.5.2 Example 1

Alarm configured as Low; Blocking: No Latching

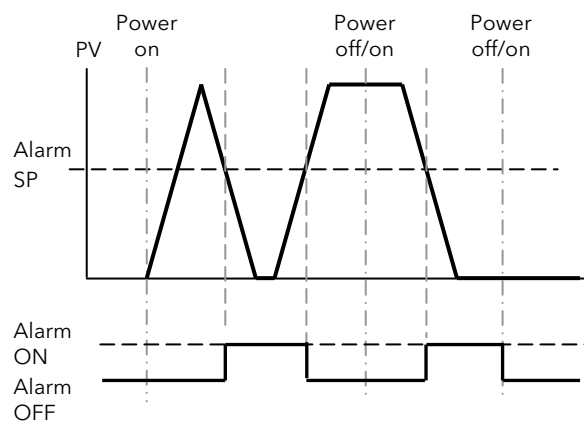

4.5.3 Example 2

Alarm configured as Low; Blocking: Manual Latching

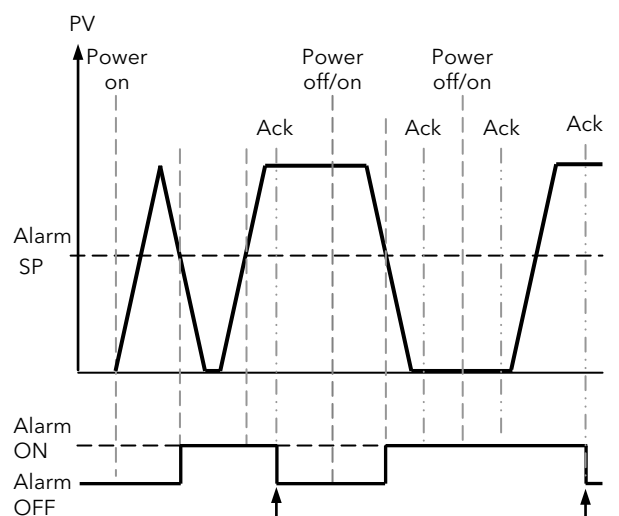

Note: The alarm will only cancel when the alarm condition is no longer current AND then it is acknowledged

4.5.4 Example 3

Alarm configured as Low; Blocking: Auto Latching

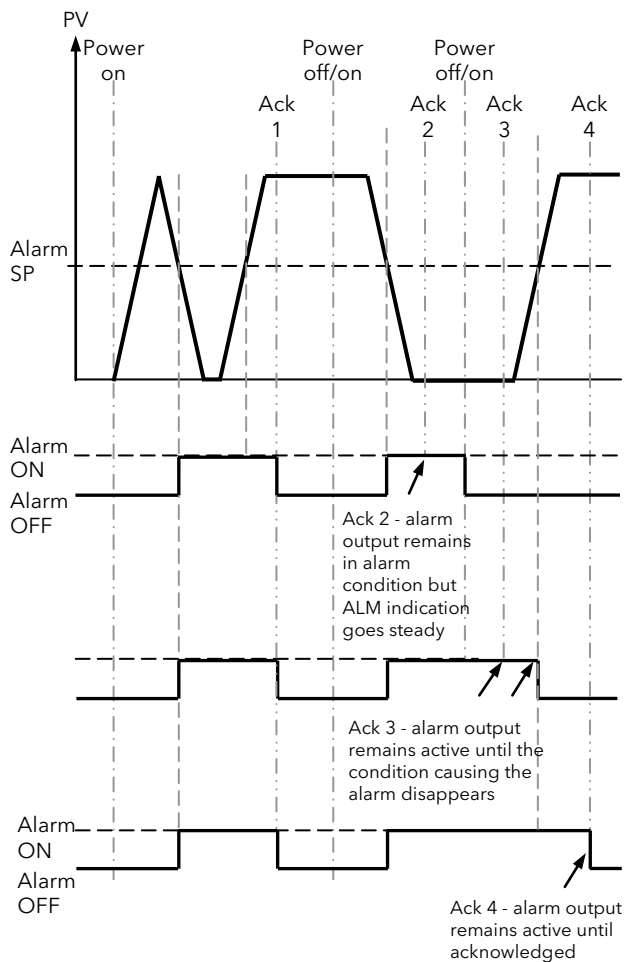

4.5.5 Diagnostic Alarms

Diagnostic alarms indicate a possible fault within the controller or connected devices.

Display shows	What it means	What to do about it
<i>EConF</i>	A change made to a parameter takes a finite time to be entered. If the power to the controller is turned off before the change has been entered then this alarm will occur.	Avoid turning the power off while <i>EConF</i> is flashing. Enter configuration mode then return to the required operating mode. It may be necessary to re-enter the parameter change since it will not have been entered in the previous configuration.
<i>EEAL</i>	Calibration error	Re-instate Factory calibration, section 9.2.6.
<i>EEEr</i>	EEPROM error (see section 8.4)	Return to factory for repair
<i>EEEr</i>	Non-volatile memory error	Note the error and contact your supplier
<i>ELi n</i>	Invalid input type. This refers to custom linearisation which may not have been applied correctly or may have been corrupted.	Go to the INPUT list in configuration level and set a valid thermocouple or input type
<i>Emod</i>	OP1, OP2, or OP3 has been changed	If this has been field changed by the installation of a new board, enter configuration level, then exit back to operator level. If the message occurs at any other time return to factory for repair.
<i>ETUn</i>	Autotune error	An autotune has been unsuccessful. This message can take around two hours to be shown. Check that the loop is closed, the controller is in Auto mode and the controller outputs and the loop itself respond correctly when changes are made to the setpoint. If this message occurs, <i>FAIL</i> will also be shown in the <i>ATUn</i> parameter in Level 2, section 4.7.2. To clear <i>ETUn</i> change <i>ATUn</i> to <i>OFF</i> . Auto-tune is described in section 7.2.

4.5.6 Out of Range Indication

If the display range, set by 'P' codes P3 and P4, is exceeded the display will flash to indicate that the process value is out of range. If the PV is further exceeded the display will show *S.br*. This is the Sensor Break alarm which is shown if the sensor or its connections become open circuit.

If the display range, set by 'P' codes P3 and P4, is exceeded and the resolution of the display is greater than the number of decimal points which can be shown, then *LLLL* (low) or *HHHH* (high) will be displayed. If the PV is further exceeded the display will show *S.br*.

4.6 Other Levels of Operation

There are 3 levels of operation:-

LEu 1 - Level 1 has no pass code and is a subset of Level 2 parameters.

LEu 2 - Level 2 displays a full set of operator parameter as mnemonics.

ConF - Configuration level sets all features of the controller. See section 5.2.



Level 2 and Configuration level can be protected by pass codes.

4.7 Level 2 Operation





Parameters available in level 1 are also available in level 2, but level 2 includes additional parameters for commissioning purposes and for more detailed operation.

The additional parameters are listed and explained in the following sections.







4.7.1 To Select Level 2

Operation	Action	Indication	Notes
Select Level 2	<ol style="list-style-type: none"> 1. Press and hold [E] until Goto is shown. 2. Press [▲] to choose LEu 2 (Level 2). 3. Press [↵] to enter. 		Choices are:- LEu 1 LEu 2 ConF
Enter the pass code (if configured)	<ol style="list-style-type: none"> 4. Press [▼] or [▲] to enter the correct pass code 5. Press [↵] to accept the value 6. The controller is now operating in Level 2 		The default pass code for level 2 is '2'. A special case exists if a security code has been configured as '0'. If this has been done it is not necessary to enter a code and the controller will enter the chosen level immediately.

4.7.2 Operator Level 2 Parameters

1. Press  to scroll through a list of parameters. (Press  to scroll back).
2. Press  or  to adjust the value of a selected parameter.
3. Press  to accept the value

The table below shows all parameters that are available depending on features configured.

Parameter mnemonic	Parameter Description	Further Information	
<i>SP</i>	Current setpoint.	This shows the current (working) setpoint which is read only when the controller is in 'Manual' or 'OFF' mode. It is not shown here when the controller is in Auto mode.	
<i>oP</i>	Output power.	This shows the working output demand which is read only when the controller is in 'Auto' or 'OFF' mode. In a heat/cool temperature control application, 100.0% = full heating, -100.0% = full cooling For heat only 100.0 = full heating; 0.0 = no heating. For cool only 100.0 = full cooling; 0.0 = no cooling. (All limited by <i>oPHi</i> and <i>oPLo</i>). When the controller is in Manual mode the output power demand can be adjusted using  or  from the default display.	
<i>AcAL</i>	Alarm Acknowledge	An alarm can be acknowledged by selecting YES .	
<i>A-M</i>	Loop Mode.	Select this for <i>Auto, MAN, OFF</i> operation (Off = control outputs inhibited).	
<i>tSt</i>	Timer Status	This displays the current status of the timer. <i>rES</i> = reset, <i>rUn</i> = counting, <i>HoLd</i> = hold, <i>End</i> = timed out.	
<i>ErSt</i>	Energy Counter Reset	<i>nonE</i>	No action
		<i>EPAr</i>	To reset the partial value
		<i>Etot</i>	To reset the total value. Available only if the partial value, <i>EPAr</i> , has been previously reset and its content is equal to zero.
<i>Unit</i>	Display Units	Choose from <i>nonE</i> , °C, °F. If °C or °F are selected then the units appear momentarily in the display when the setpoint is changed. If 'none' is selected then no units are displayed when the setpoint is changed.	
<i>SPLo</i>	Setpoint Low Limit.	The setpoint low limit is automatically set depending on the 'Input Type' selected using the 'Quick Codes' or by 'P' code P1. It can be further limited between the Setpoint High Limit value and the Low Range Limit value using  or  .	
<i>SPHi</i>	Setpoint High Limit.	The setpoint high limit is automatically set depending on the 'Input Type' selected using the 'Quick Codes' or by 'P' code P1. It can be further limited between the Setpoint Low Limit value and the High Range Limit value using  or  .	
<i>SP1</i>	Setpoint 1	Two setpoints are available. These can be pre-set ready to be selected by the Setpoint Select parameter below, or via a digital input if configured.	
<i>SP2</i>	Setpoint 2		
<i>SPSL</i>	Setpoint Select	To select between SP1 and SP2. Read only when SP selection is configured by a digital input.	See also 'P' code P51 and P52 section 5.2.16
<i>SPrr</i>	Setpoint Rate Limit	This applies a limit to the rate at which either SP1 or SP2 changes. When turned OFF no limit is applied to the rate of change of setpoint. Select a value between 0.1 to 3000 units per minute to ramp to a new setpoint. Whenever the selected setpoint is changed, the controller will servo to the current PV then ramp at the rate selected in <i>SPrr</i> to the new value. If switching between setpoints 1 and 2 the controller will servo to the current PV then ramp to the new setpoint value. If the power to the controller should fail during a ramp then the controller setpoint will servo to the current PV when the power is restored and then ramp to the selected setpoint value.	

Parameter mnemonic	Parameter Description	Further Information																																												
<i>AL1</i>	Alarm 1 Setpoint	Sets the level at which alarm 1 operates																																												
<i>AL1H</i>	Alarm 1 Hysteresis	Hysteresis sets the difference between alarm 1 switching on and switching off. It is designed to prevent random switching if the PV is noisy or changing significantly.																																												
<i>AL2</i>	Alarm 2 Setpoint	Sets the level at which alarm 2 operates																																												
<i>AL2H</i>	Alarm 2 Hysteresis	Hysteresis sets the difference between alarm 2 switching on and switching off. It is designed to prevent random switching if the PV is noisy or changing significantly.																																												
<i>AL3</i>	Alarm 3 Setpoint	Sets the level at which alarm 3 operates																																												
<i>AL3H</i>	Alarm 3 Hysteresis	Hysteresis sets the difference between alarm 3 switching on and switching off. It is designed to prevent random switching if the PV is varying significantly.																																												
<i>Auto</i>	Auto-Tune Enable.	OFF (disable), On (enable), FAIL (Auto-tune has been unsuccessful. This may be due to an open loop condition).																																												
<i>Pb</i>	Proportional Band	Range 1 to 9999 engineering units (e.g °C). Default 20.																																												
<i>ti</i>	Integral Time	Range OFF, 1 to 9999 seconds (default 360).																																												
<i>td</i>	Derivative Time	Range OFF, 1 to 9999 seconds (default 60)																																												
<i>cbHi</i>	Cutback High	Range Auto, 1 to 9999 display units (default Auto = 3*Pb)																																												
<i>cbLo</i>	Cutback Low	Range Auto, 1 to 9999 display units (default Auto = 3*Pb)																																												
<i>rr</i>	Manual Reset	Range -100 to 100 (default 0.0)																																												
<i>r2G</i>	Relative Secondary (Cool) Gain	Range 0.1 to 10.0 (default 1.0)																																												
<i>HYS</i>	Primary Output Hysteresis	Sets hysteresis for all outputs configured for ON/OFF Heating. It is available for a single action ON/OFF controller. Range 1 to 3000 display units (0.1 to 3000 or 0.01 to 300.0 depending on the number of decimal places configured).																																												
<i>HYS C</i>	Secondary Output Hysteresis	Sets hysteresis for all outputs configured for ON/OFF Cooling in a double action controller. Range 1 to 3000 display units (0.1 to 3000 or 0.01 to 300.0 depending on the number of decimal places configured).																																												
<i>dbnd</i>	Dead Band	Dead Band Between Heating And Cooling; Range OFF, 0.1 to 100% of cooling Pb. (Off = no deadband)																																												
<i>1PLS</i>	Output 1 Minimum Pulse Time	<p>Time proportioning is a method of delivering power to the load by switching the output on and off for accurately measured time intervals.</p> <p>To deliver 50% power the output on period will be the same as the off period.</p> <p>When set to Auto, the minimum pulse time that can be set is 100ms. A very low power demand is represented by a short on pulse of 100ms duration followed by a correspondingly long off time. As the power demand increases the on pulse becomes longer and the off pulse becomes correspondingly shorter. For a 50% power demand the on and off pulse lengths are the same (at 200ms on and 200ms off).</p> <p>The choice of minimum pulse time is determined by two factors:</p> <ol style="list-style-type: none"> 1. The stability of the control. If the minimum pulse time is set too long then the process variable will appear to dip during the off times. This may cause apparent control instability. 2. The life of the control actuator. Relay outputs or mechanical contactors may wear out prematurely if the minimum pulse time is set too short. <p>Setting to Auto is suitable for triac or logic outputs, not driving a mechanical device.</p> <p>If the control device is a relay or contactor the minimum on time should be set greater than 5 seconds (for example) to prolong relay life.</p> <p>By way of illustration, the ON/OFF times are shown in the table for a typical relay setting of 5 seconds and a typical logic setting of 0.1s:-</p> <table border="1"> <thead> <tr> <th rowspan="2">Power demand</th> <th colspan="2">-PLS Time = 5 seconds</th> <th colspan="2">-PLS Time = 0.1 second (Auto)</th> </tr> <tr> <th>ON seconds</th> <th>OFF seconds</th> <th>ON ms</th> <th>OFF ms</th> </tr> </thead> <tbody> <tr> <td>1%</td> <td>5</td> <td>500</td> <td>100</td> <td>10,000</td> </tr> <tr> <td>10%</td> <td>5</td> <td>50</td> <td>100</td> <td>1000</td> </tr> <tr> <td>25%</td> <td>6.7</td> <td>20</td> <td>130</td> <td>400</td> </tr> <tr> <td>50%</td> <td>10</td> <td>10</td> <td>200</td> <td>200</td> </tr> <tr> <td>75%</td> <td>20</td> <td>6.7</td> <td>400</td> <td>130</td> </tr> <tr> <td>90%</td> <td>50</td> <td>5</td> <td>1000</td> <td>100</td> </tr> <tr> <td>99%</td> <td>500</td> <td>5</td> <td>10,000</td> <td>100</td> </tr> </tbody> </table> <p>For relay outputs the range is Auto or 0.1 to 150.0 seconds (default 5.0).</p> <p>For logic outputs the range is Auto or 0.1 to 150.0 (default Auto = 100ms).</p>	Power demand	-PLS Time = 5 seconds		-PLS Time = 0.1 second (Auto)		ON seconds	OFF seconds	ON ms	OFF ms	1%	5	500	100	10,000	10%	5	50	100	1000	25%	6.7	20	130	400	50%	10	10	200	200	75%	20	6.7	400	130	90%	50	5	1000	100	99%	500	5	10,000	100
Power demand	-PLS Time = 5 seconds			-PLS Time = 0.1 second (Auto)																																										
	ON seconds		OFF seconds	ON ms	OFF ms																																									
1%	5		500	100	10,000																																									
10%	5	50	100	1000																																										
25%	6.7	20	130	400																																										
50%	10	10	200	200																																										
75%	20	6.7	400	130																																										
90%	50	5	1000	100																																										
99%	500	5	10,000	100																																										
<i>2PLS</i>	Output 2 Minimum Pulse Time																																													
<i>3PLS</i>	Output 3 Minimum Pulse Time																																													
<i>4PLS</i>	Output 4 Minimum Pulse Time																																													

Parameter mnemonic	Parameter Description	Further Information	
oFS	PV Offset	PV Offset applies a single offset to the temperature or process value over the full display range of the controller. It has the effect of moving the curve up a down about a central point as shown.	
FiLlE	PV Input Filter Time	A first order filter provides damping of the input signal. This may be necessary to prevent the effects of excessive process noise on the PV input from causing poor control and indication. More typically used with process inputs. Settable range oFF 0.1 to 100.0 seconds. Default value 1.6 seconds.	
oPLo	Output Low Limit	Range -100.0% to P36 for a Heat/Cool controller; 0.0% to P36 for a heat only controller. The upper range is limited to the value set by oPHi .	oPLo and oPHi are also limited by the value of the Safe Output Power Limit set in configuration level by P36. This is to ensure that the Safe Output Power cannot be overridden by the Output High and Low Limits. For example, if the Safe Output Power Limit is set to +10.0, oPLo can be set between -100.0 and +10.0 (0.0 and +10.0 for heat only or cool only) and oPHi can be set between +10.0 and +100.0. Note: by default P36 is set 0.0 which means that for a heat only (or cool only) controller oPLo is fixed at 0.0.
oPHi	Output High Limit	Range P36 to +100.0%. Note: For a cool only controller oPHi represents the maximum cooling power limit.	
LdA	Load Current	Reads the current applied to the load (elements). Read only.	Only shown if the CT function is configured. See also section 5.2.12, 'Current Transformer'.
LEA	Leak Current	Reads the leakage current in a load. Read only	
LdAL	Load Current Alarm Threshold	To set an alarm if the load current is exceeded.	
LEAL	Leakage Current Alarm Threshold	To set an alarm if the leakage current is exceeded.	
HcAL	Overcurrent Alarm Threshold	To set an alarm if the load current is exceeded beyond a 'safe' limit.	
tDUr	Set Timer Duration	Only shown if the timer function is configured	Section 4.12, 'Timer Operation'
tEHr	Timer Start Threshold	Only shown if timer type = Dwell	
SSSP	Soft Start Setpoint	Only shown if timer type = soft start	
SSoP	Soft Start Output Power Limit	Only shown if timer type = soft start	
tEL	Time Elapsed	Read only indication of the time elapsed	
tRE	Time Remaining	Time remaining before the timer times out. This value can be extended while the timer is running or after it has timed out.	
EPRr	Energy Counter Partial Value	This parameter is read only and is intended to measure energy usage for specific batches.	
EtoT	Energy Counter Total Value	This parameter is read only and is intended to measure energy usage for a total process which may consist of a number of batches.	Section 4.11 'Energy Usage'. It is also possible to configure the second/third line of the display to read this value - section 5.2.19, 'P' Codes P74 and P75
UcAL	User Calibration	Select the point for two point offset. dLE (not calibrating), Lo (low point cal), Hi (high point cal), rESt (remove user cal)	Section 4.8.
cAdJ	Calibration Adjust	Adjust for two point offset if UcAL = Lo or Hi .	

Note: If at any time you wish to return to the default operating display press and together.

4.8 User Calibration

User calibration provides a method of adjusting the process value displayed to compensate for known measurement errors in a particular process or batch, without affecting the fundamental calibration of the input. Since adjustment may be required between batches, it is available in level 2.

It provides a two point offset which adjusts both a low point and a high point and applies a straight line between them. Any readings above and below the calibration points will be an extension of this straight line. For this reason it is best to calibrate with the two points as far apart as possible.

Example: Assume the controller is calibrated to display 0.0 for an input of 0.0mV and 500.0 for an input of 40.0mV. A particular process has known system errors such that the controller is required to read 5.0 for an input of 0.0mV and 490 for an input of 40.0mV.

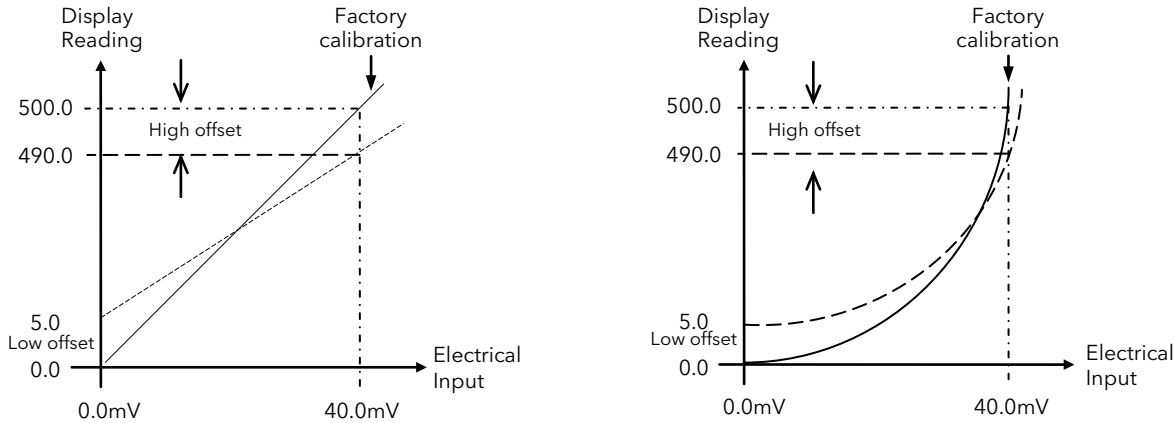

Adjust as follows:-

Operation	Action	Display
In Level 2, select User Calibration	1. Press until UcAL is displayed	
Apply the low mV input (0.0mV in this example).	2. Press or to select Lo 3. Press 4. Press or to read 5.0 5. Press to enter the value 6. Then scroll back to UcAL	
Apply the high mV input (40.0mV in this example).	7. Press or to select Hi 8. Press 9. Press or to read 490.0 10. Press to enter the value	
In Operator Level the controller will now read 5.0 for an input of 0.0mV and 490.0 for an input of 40.0mV.		
To remove the user set values	11. Scroll back to UcAL 12. Press or to read rEST 13. Press to enter the value	
In Operator Level the controller will now read 0.0 for an input of 0.0mV and 500.0 for an input of 40.0mV.		

4.9 To Return to Level 1

1. Press and hold until **GoTo** is displayed
2. Press or to select **LEu 1**

The controller will return to the level 1 default display. Note: A security code is not required when going from a higher level to a lower level.

4.10 Auto, Manual and Off Mode

In Level 2, the controller can be put into Auto, Manual or Off mode.



Auto mode is the normal operation where the output is adjusted automatically by the controller in response to changes in the measured value (temperature).

In Auto mode all the alarms and the special functions (for example, auto tuning and timer) are operational.

Manual mode means that the controller output power is manually set by the operator. The input sensor is still connected and reading the temperature but the control loop is 'open'.

In Manual mode all the alarms are operational.

In manual mode the MAN beacon will be lit, the auto-tuning and timer functions are disabled.







The power output can be continuously increased or decreased using the  or  buttons.

 **Manual mode must be used with care. When in Manual, the power level must not be set and left at a value that can damage the process or cause over-heating. The use of a separate 'over-temperature' controller is recommended.**

Off mode means that the heating and cooling outputs are turned off. The High, Low and Deviation alarms will be OFF. The analogue retransmission outputs will, however, still be active.

4.10.1 To Select Auto, Manual or Off Mode

In Level 2

1. Press  to scroll to *A - n*.
 2. Press  or  to select *AUTO*, *MAN* or *OFF*
 3. Press  to accept the value
- If **OFF** has been selected, *OFF* will be shown in the display and the heating and cooling outputs will be set to zero. The current working setpoint cannot be changed.
 - If manual mode has been selected, the **MAN** beacon will light. The upper display shows the measured temperature and the lower display the demanded output power.
-  The transfer from Auto to manual mode is 'bumpless'. This means the output will remain at the current value at the point of transfer. Similarly when transferring from Manual to Auto mode, the current value will be used. This will then slowly change to the value demanded automatically by the controller.
- To manually change the power output, press  or  to raise or lower the output. The output power is continuously updated when these buttons are pressed.

4.11 Estimated Energy Usage

The aim of this function is to have an estimation of the energy consumption of the controlled process. By setting a nominal power of the load the controller is able to calculate the integral of the ON time period of a selected output. Two totalisers are provided in operator level to display partial and total counting values. The purpose of this feature is to provide visual feedback on the energy being consumed so that any deviation observed from the average value can alert you to possible problems in the process.

In Configuration Level, section 5.2.21:

1. Use P81 to define the output (normally heating) on which the load is to be monitored
2. Enter the nominal load power in KW in P82.

In Levels 1 & 2:

1. *EPRr* is a totaliser which estimates the energy usage for individual batches .
2. *ELot* a totaliser which estimates the energy usage for the whole process.

These parameters may also be displayed in the second and third lines of the display. This is configured using P codes P74 and P75, section 5.2.19.

EPRr and *ELot* are reset using the Energy Counter Reset parameter *ERSL* available in Level 2.

ELot can only be reset after *EPRr* has been reset and its contents are equal to zero. There is a window of approximately 10 seconds in which to reset the Total counter before the Partial counter starts to count again and its contents become greater than zero.

P71, P72 or P73 can customise one of the function buttons or the Page button to access the Reset parameter.

4.12 Timer Operation

An internal timer can be configured to operate in one of three different modes or types. These are Dwell Timer, Delayed Switch on Timer and Soft Start Timer and are described in the following three sections. The timer types are configured by 'P' code **P41** section 5.2.15.

The **Timer Resolution** is configured using 'P' code **P42**.

4.12.1 Dwell Timer

P41 = d.LL.

A dwell timer is used to control a process at a fixed temperature, set by SP1, for a defined period.

When **Run** is selected the setpoint will servo immediately to the current PV, and the display will show **rUn** immediately.

If setpoint ramping is enabled, then the setpoint ramps to SP1 at the set rate.

Timing starts when the temperature is within the threshold of the setpoint, set by parameter **tEhr** in Operator Level 2. If the threshold is set to OFF the timing starts immediately. Heating or cooling will come on as appropriate during the timing period. Once the timer is running, it will continue to run even if the temperature falls below the threshold.

When the timer has timed out the controller behaviour depends on the configuration of the END state parameter. This is set up in **ConF** Level using P code **'P43'**.

OFF: When the timer completes its dwell, the instrument will be put into Standby mode. The output power will be set to 0%, and the standard home display will display PV and OFF instead of setpoint. The PV will revert towards ambient since no power is being applied.

SP2: When the timer completes, the target setpoint will switch to setpoint 2. Setpoint 2 may be a lower or a higher temperature. If the Setpoint Rate Limit is enabled, then the controller will ramp to the setpoint 2 at the **SPrr** rate. During this ramp, the Timer status will indicate RUN. Once the setpoint 2 is reached the status will change to **End**. This configuration can be used to provide a simple ramp/dwell/ramp/dwell sequence.

dLL: Dwell. When the timer completes, the controller will continue to control at setpoint.

rES: Reset. The timer will reset on completion reverting to SP1.

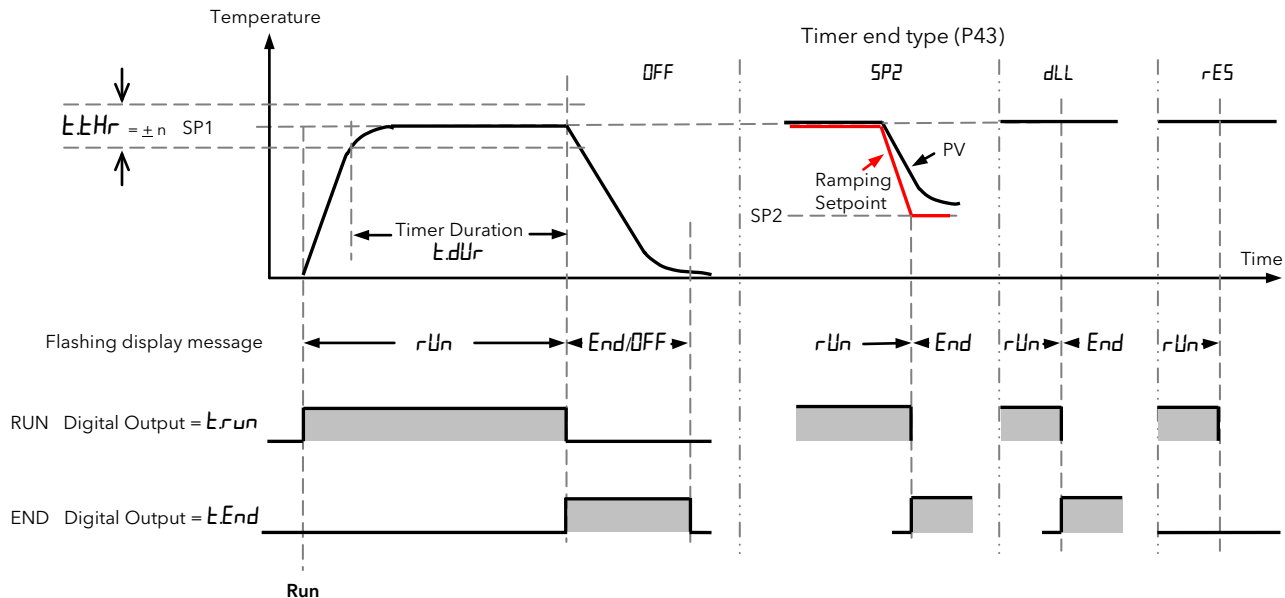

Notes: The dwell period can be reduced or increased while the timer is running by adjusting **tRE** (Time Remaining) in Level 2.

The parameter **tEhr** is a deviation band from setpoint value. It is set by the user in Level 2. Timing starts when the process value reaches the deviation limit. Because it is set as a deviation band the operation will apply to both increasing (heating) or decreasing (cooling) values.

4.12.1.1 Example: To Configure and Operate a Dwell Timer

1. In **CONF** level set **P41 = dLL** to select Dwell type timer.
2. In **CONF** level set **P42 = Hold** or **n/n** to select the timer resolution. In this example **n/n**
3. In **CONF** level set **P43 = OFF, SP2, dLL** or **rES** to define the action required at the end of the timing period. In this example set it to **SP2**.
4. In Level 2 set the Timer Start Threshold parameter **t.tHr** to define the PV value at which the timer starts to countdown. This is set as a deviation from setpoint. In this example $\pm 10^{\circ}\text{C}$.
5. In Level 2, set the Timer Duration parameter **t.dUr** to the required period. In this example 1 minute.
6. In Level 1 or 2 set SP1 and SP2 to the required control temperatures. In this example 100°C and 50°C .
7. In Level 1 or 2, set the Timer Status parameter **t.St** to **rUn**. The default display will flash **rUn** but the time elapsed and time remaining parameters will not be changing until the PV is within the $\pm 10^{\circ}\text{C}$ deviation limit set by **t.tHr**.

When the PV reaches $\pm 10^{\circ}\text{C}$ of setpoint the timer will run for the period set in **t.dUr** (1 minute). The time elapsed parameter **t.eL** will begin to count up and the time remaining **t.rE** parameter will begin to count down. After the set time the controller will control at SP2 (50°C). The display will flash between **End** and the current setpoint value. At this point the working setpoint is SP2 and any change to the value of SP2 will take effect immediately. It is possible to change the value of SP1, but this change will only take effect when SP1 becomes the current working setpoint.

Entering a further time in the parameter **t.rE** will switch the controller back to SP1 and the timer will run again for the additional time (assuming the PV is within the set deviation). If the PV is not within the set deviation the controller will show **rUn** but will not begin to count down until it is within the deviation ($\pm 10^{\circ}\text{C}$ in this example).

In Level 1 or 2 reset the timer by setting parameter **t.St** to **rSt**. The timer will not run whilst it is in Reset.

Note: if the deviation drops below the set value, the timer will indicate **rUn** and will repeat the timing sequence described above again.

At any time the Timer Status parameter **t.St** can be set to **Hold**. The display will flash between **Hld** and the current setpoint and the controller will remain in its current condition until the hold condition is released.

Following power up the controller will automatically enter the run sequence.

In P116 controller a digital input can be configured so that the Timer Status parameter **t.St** can be operated remotely. In P108 and P104 controllers two digital inputs are available. If this has been done in a particular application the timer may be put into Run, Reset, Hold by a remote switch.

4.12.1.2 Example: To Configure Timer Digital Outputs

This example applies to all timer types.

Any output (OP1 to OP4) - normally relay or logic, can be made to operate when the timer is in Run mode, Reset mode or End mode as shown in the timer diagrams. In this example choose OP4.

1. In **CONF** level set **P14 = t.rUn**. The output 4 relay will operate when the timer is running or is in hold.
2. In **CONF** level set **P14 = t.End**. The output 4 relay will operate when the timer has timed out.

4.12.1.3 Example: To Configure Timer Digital Inputs

This example applies to all timer types.

The timer can be made to operate from external digital sources.

1. In **CONF** level set **P51 = t.rUn**. The timer will enter Run mode when Digital Input 1 is true.
2. In **CONF** level set **P52 = t.rES**. The timer will enter Reset mode when Digital Input 2 is true. (Note: Logic input 2 is not available in P116 controller).

Other settings for 'P' codes P51 and P52 are:

t.Hld - the timer will enter Hold mode when the digital input is true.

t.rS - the timer will run when the digital input is true and reset when the digital input is false.

4.12.2 Delayed Switch on Timer

P41 = dELY. This timer is used to switch on the output power after a set time. The timer starts immediately on power-up. It will also start whenever the timer start parameter **tSt** is manually set to **rUn**.

The controller remains in standby with heating and cooling off until the time has elapsed. After the time has elapsed, the instrument controls at the target setpoint.

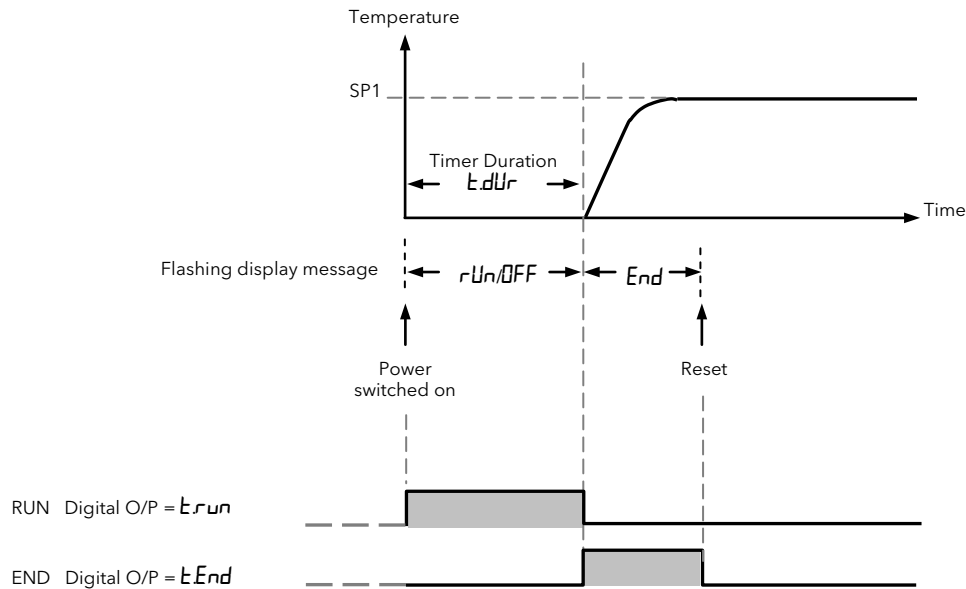

4.12.2.1 Example: To Configure and Set up a Delayed Switch on Timer

1. In **CONF** level set **P41 = dELY** to select Delay type timer
2. In **CONF** level set **P42 = Hour** or **min** to select the timer resolution. In this example **min**
(Note: 'P' code P43 is not shown when this timer type is configured).
3. In Level 2, set the Timer Duration parameter **t.dUr** to the required period. In this example, 1 minute.
(Note: **t.Hr** is not shown when this timer type is configured).
4. In level 1 or 2 set the Timer Status parameter **t.St** to **rUn**, or power cycle the controller. The display will flash between **rUn** and **OFF**. The time elapsed parameter **t.El** will begin to count up and the time remaining **t.rE** parameter will begin to count down.

During the timing period the control outputs (heat and cool) will remain at **0.0**.

At the end of the timing period the display will flash between **End** and the current setpoint. The control outputs will go to the required demand level at a controlled rate so that the switch over is 'bumpless'.

At this point entering a further time in the parameter **t.rE** will switch the controller back to run again for the additional time, the outputs will go to **0.0** and will switch back to control at the end of the timing period.

5. In Level 1 or 2 reset the timer by setting parameter **t.St** to **rSt**.

Following a time out, the Timer Status parameter **t.St** can be set to **rUn**. The outputs will immediately go to **0.0** until the end of the timing period and the sequence will repeat.

At any time the Timer Status parameter **t.St** can be set to **Hold**. The display will flash between **HLd** and **OFF** and the outputs will remain off until the hold condition is released.

Logic I/O can be configured as shown in section 4.12.1.3.

4.12.3 Soft Start Timer

P41 = 55.

A Soft Start timer starts automatically on power up. It applies a power limit ('**55.oP**', set in Level 2) until the temperature reaches a value ('**55.SP**', set in Level 2). It is typically used, for example, to dry-out heaters in Hot Runner control systems before full power is allowed.

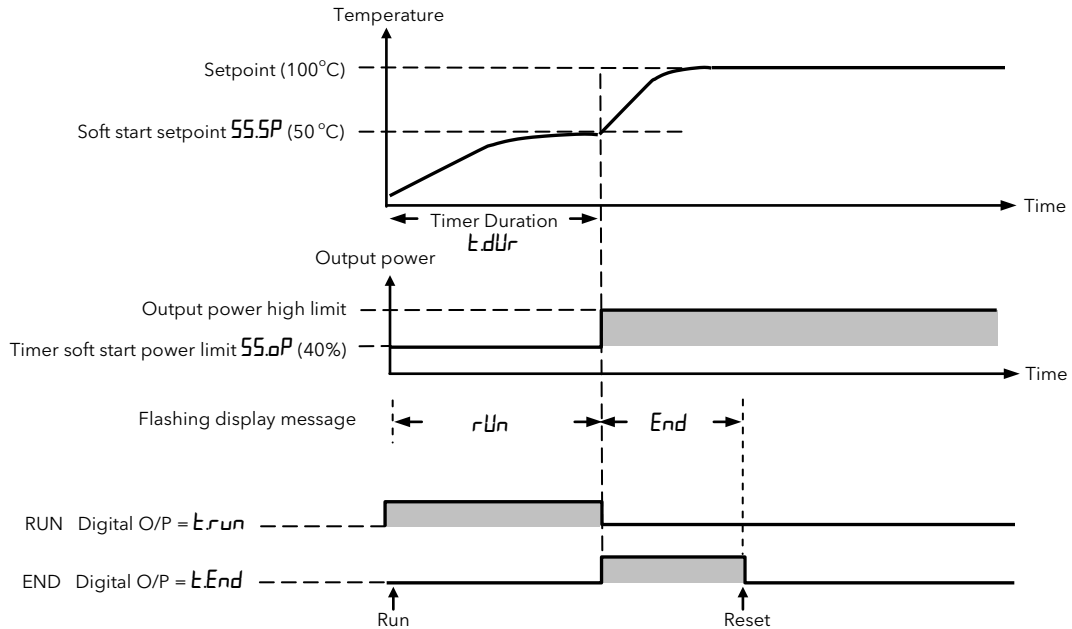

4.12.3.1 Example: To Configure and Set up a Soft Start Timer

1. In **CONF** level set **P41 = 55** to select Soft Start type timer
2. In **CONF** level set **P42 = Hold** or **Run** to select the timer resolution. In this example **Run** (Note: 'P' code P43 is not shown when this timer type is configured).
3. In Level 2, set the Timer Duration parameter **t.dur** to the required period. In this example 1 minute. (Note: **t.Hr** is not shown when this timer type is configured).
4. In Level 2, set **55.SP** to the required soft start setpoint threshold. In this example 50°C.
5. In Level 2, set **55.oP** to the required power limit. In this example 20%.
6. In level 1 or 2 set SP1 to the required operating level. 100°C in this example.
7. In level 1 or 2 set the Timer Status parameter **t.St** to **run** or power cycle the controller. The display will flash between **run** and the current setpoint. The time elapsed parameter **t.El** will begin to count up and the time remaining **t.rE** parameter will begin to count down.

During the timing period the control outputs (heat and cool) will be limited to **55.oP** (20.0%).

At the end of the timing period the display will flash between **End** and the current setpoint. The control outputs will go to the required demand level.

At this point entering a further time in the parameter **t.rE** will switch the controller back to run again for the additional time, the outputs will go to **55.oP** and will switch back to control at the end of the timing period.

8. In Level 1 or 2 reset the timer by setting parameter **t.St** to **rSt**.

Following a time out, the Timer Status parameter **t.St** can be set to **run**. The outputs will immediately go to **55.oP** until the end of the timing period and the sequence will be the same as when the controller is power cycled.

As soon as the PV reaches the value set by **55.SP** (50°C) the timer will stop and go to the end state.

At any time the Timer Status parameter **t.St** can be set to **Hold**. The display will flash between **Hld** and the current setpoint and the outputs will remain at **55.oP** until the hold condition is released.

Digital I/O can be configured as shown in section 4.12.1.3.

5. Configuration Level

Configuration of the controller is carried out using a list of 'P' codes. Each P code is associated with a particular feature of the controller such as Input Type, Ranging, Control Type, Outputs, Alarms, Current Measurement, Timer, Digital Communications, Display Functionality, Energy Measurement, Calibration, etc. These are listed in the tables in section 5.2.



WARNING

Configuration level gives access to a wide range of parameters which match the controller to the process. Incorrect configuration could result in damage to the process being controlled and/or personal injury. It is the responsibility of the person commissioning the process to ensure that the configuration is correct.

In configuration level the controller is not controlling the process or providing alarm indication. Do not select configuration level on a live process.





5.1 To Select Configuration Level

Operation	Action	Indication	Notes
Select configuration level	<ol style="list-style-type: none"> 1. Press and hold until Goto is shown. 2. Press to choose CONF (Configuration Level). 3. Press to enter. 		Choices are:- LEU1 LEU2 CONF
Enter the pass code (if configured)	<ol style="list-style-type: none"> 4. Press or to enter the correct pass code 5. Press to accept the value 		The default pass code for configuration level is '4'. The pass code can be changed in configuration level using P code P77. A special case exists if a security code has been configured as '0'. If this has been done it is not necessary to enter a code and the controller will enter the chosen level immediately.
	<ol style="list-style-type: none"> 6. The controller is now operating in Level CONF 		
Configure a function	<ol style="list-style-type: none"> 7. Press to scroll through a list of P codes 8. Press or to select the function associated with the P code 9. Press to accept the function 		The first P code is P1 which selects the Input Type - thermocouple, platinum resistance thermometer (<i>rtd</i>), mV or mA. The example shows J type thermocouple. All P codes are listed in the next section:

5.2 Configuration Level Parameters

Configuration parameters are defined by a set of 'P' codes.

A summary and full description of the 'P' codes is given below.

1. Press  to scroll through a list of 'P' codes.
2. Press  or  to select the function associated with the 'P' code.
3. Press  to accept the function.

5.2.1 Summary of 'P' Codes

Sensor input and Ranging	<i>P1</i>	Input type	Sensor break	<i>P35</i>	Sensor break alarm type	
	<i>P2</i>	Decimal point position		<i>P36</i>	Sensor break safe output power	
	<i>P3</i>	Low scale range		<i>P37</i>	Sensor break alarms output	
	<i>P4</i>	High scale range		Timer	<i>P41</i>	Timer type
	<i>P5</i>	Linear input low mV			<i>P42</i>	Timer resolution
	<i>P6</i>	Linear input high mV			<i>P43</i>	Timer end type
	<i>P7</i>	Control type				
Control type	<i>P8</i>	Cooling algorithm	Digital inputs	<i>P51</i>	Digital 1 input function	
Outputs	<i>P11</i>	Output 1		<i>P52</i>	Digital 2 input function	
	<i>P12</i>	Output 2	Digital communications	<i>P61</i>	Digital Comms address	
	<i>P13</i>	Output 3		<i>P62</i>	Digital Comms baud rate	
	<i>P14</i>	Output 4		<i>P63</i>	Digital Comms parity	
	<i>P15</i>	DC output range		<i>P64</i>	Digital Comms master/slave	
	<i>P16</i>	Retransmission scale low value				
	<i>P17</i>	Retransmission scale high value	Pushbutton functionality	<i>P71</i>	F1 pushbutton functionality	
Alarms	<i>P21</i>	Alarm 1 type		<i>P72</i>	F2 pushbutton functionality	
	<i>P22</i>	Alarm 1 latching		<i>P73</i>	Page pushbutton functionality	
	<i>P23</i>	Alarm 1 blocking	Display functionality	<i>P74</i>	Content of second line display	
	<i>P24</i>	Alarm 2 type		<i>P75</i>	Content of third line display	
	<i>P25</i>	Alarm 2 latching	Access passcodes	<i>P76</i>	Level 2 passcode	
	<i>P26</i>	Alarm 2 blocking		<i>P77</i>	Configuration level passcode	
	<i>P27</i>	Alarm 3 type	Energy measurement	<i>P81</i>	Energy meter source	
	<i>P28</i>	Alarm 3 latching		<i>P82</i>	Energy meter nominal load power	
	<i>P29</i>	Alarm 3 blocking	Configuration recovery	<i>rEcS</i>	Recovery point save	
	Current transformer	<i>P31</i>	Current transformer source		<i>rEcL</i>	Recovery point load
<i>P32</i>		Current transformer range	Calibration	<i>PHAS</i>	Calibration phase	
<i>P33</i>		Current transformer alarm latching	Feature passcodes	<i>PASc</i>	Feature passcode	
Loop Break	<i>P34</i>	Loop break alarm time		<i>PAS2</i>	Feature passcode	

5.2.2 Analogue Input

P1	Select P1 to configure the Input Type . Selects the type of sensor connected to the instrument PV input. It is also possible to download a custom curve.		Input Types and Ranges					
			Min Range	Max Range	Units	Min Range	Max Range	Units
	<i>Jtc</i>	Thermocouple type J (factory default)	-210	1200	°C	-346	2192	°F
	<i>cRtc</i>	Thermocouple type K	-200	1372	°C	-328	2502	°F
	<i>Ltc</i>	Thermocouple type L	-200	900	°C	-328	1652	°F
	<i>rtc</i>	Thermocouple type R	-50	1700	°C	-58	3092	°F
	<i>btc</i>	Thermocouple type B	0	1820	°C	32	3308	°F
	<i>ntc</i>	Thermocouple type N	-200	1300	°C	-328	2372	°F
	<i>ttc</i>	Thermocouple type T	-200	400	°C	-328	752	°F
	<i>Stc</i>	Thermocouple type S	-50	1768	°C	-58	3215	°F
	<i>rtd</i>	Pt100	-200	850	°C	-328	1562	°F
	<i>mv</i>	-10 to +80mV linear	-10.00	80.00				
<i>020</i>	0 - 20mA linear							
<i>420</i>	4 - 20mA linear							
<i>Ctc</i>	Custom downloadable curve.	This requires the use of iTools configuration package, see section 10.6.2.						

5.2.3 Input Ranges and Limits

P2	Select P2 to configure the number of Decimal Places This sets the maximum displayed resolution for the process variable and other process settings. Up to two decimal places may be selected for any input type. Choose from the list below:-	
	nnnn	No decimal places (factory default)
	nnn.n	One decimal place
	nn.nn	Two decimal places
P3	Select P3 to configure the Low Range Limit for the input type selected. The Low Scale Range Value sets a lower setpoint limit on the sensor being used. It may be used to set a safe range for operator setpoint adjustment. Range limits are automatically clipped to the range of the sensor being used. Range limits are also used in conjunction with the Linear Input High and Low values to set the display range for linear inputs. The low scale value is also clipped to the High Range Limit (P4). Default value for linear inputs -1999.	
	Select P4 to configure the High Range Limit for the input type selected. The High Scale Range Value sets an upper setpoint limit on the sensor being used. It may be used to set a safe range for operator setpoint adjustment. Range limits are automatically clipped to the range of the sensor being used. Range limits are also used in conjunction with the Linear Input High and Low values to set the display range for linear inputs. The high scale value is also clipped to the Low Range Limit (P3). Default value for linear inputs 9999.	
P5	Select P5 to configure the Low Range Limit for Linear millivolt inputs. (P5 is only shown for mV linear inputs). Linear input types allow the mapping of a millivolt value to a configurable display range. The example shown opposite shows how to do this. -10.00 to +80mV Default value 0.00	
	Select P6 to configure the High Range Limit for Linear millivolt inputs. (P6 is only shown for mV linear inputs). Linear input types allow the mapping of a millivolt value to a configurable display range. The example shown opposite shows how to do this. -10.00 to +80mV Default value 80.00	

See the table 'Input Types and Ranges' in the previous section for default values.

Example:

mV Input Scaling

In this example the display is required to read -1000 for a mV input of -5.0 and +2000 for a mV input +20.0.

Select configuration level (see section 5.1):

Select P2 and adjust to nnnn

Select P3 and adjust to -1000

Select P4 and adjust to +2000

Select P5 and adjust to -5.0mV

Select P6 and adjust to +20.0mV

Note: In operator level, if the input signal is exceeded a sensor break **5br** is indicated.

mA Input Scaling

Using an external burden resistor of 2.49Ω, the controller can be made to accept 0-20mA or 4-20mA from a current source.

In this case the default value of -1999 is indicated for an input of 0 or 4mA and 3000 for an input of 20mA.

Adjust P3 and P4 for the display readings required for a particular application.

Note: In operator level, if the input signal is exceeded a sensor break **5br** is indicated.

5.2.4 Control

This selects the control algorithm, which may be PID heat and/or cool or an ON/OFF. The control algorithm may also be disabled in which case all outputs configured for control will revert to off in the case of a switching output or 0% power demand in the case of an analogue output.

P7	Select P7 to configure Control Type . Having defined a control type it will be necessary to allocate control outputs using P11/P12/P13/P14.		Control options are described in section 7.1
	NonE	Control action disabled	
	HP	PID heating (factory default) The control function block is configured for PID (three term) heating, no cooling. Typical applications include furnaces and ovens.	
	CP	PID cooling The control function block is configured for PID (three term) cooling, no heating. May be used in cryogenic applications.	
	HPCP	PID heat + PID cool The control function block is configured for PID (three term) heating and PID cooling. Typical applications include extruder temperature control.	
	HoCP	ON/OFF heat + PID cool The control function block is configured for ON/OFF heating and PID (three term) cooling.	
	Ho	ON/OFF heating The control function block is configured for ON/OFF heating, no cooling. Simple heat only applications.	
	Co	ON/OFF cooling The control function block is configured for ON/OFF cooling, no heating. Simple cool only applications	
	HPCo	PID heat + ON/OFF cool The control function block is configured for PID (three term) heating and ON/OFF cooling. Typical applications include extruder temperature control.	
HoCo	ON/OFF heat + ON/OFF cool The control function block is configured for ON/OFF heating and cooling. Simple heat/ cool applications.		

P8	Select P8 to configure Non Linear Cooling Type . P8 is only shown if the control type, P7, is heat and cool. Different cooling mediums change the effectiveness of cooling in a non linear way. This parameter selects cooling characterisation to match the type of cooling medium. It is typically used in the control of extruder barrel temperatures where the cooling medium may be water, oil or forced air. When using non-linear cooling it is common practice to pulse the coolant using a relay, triac or logic output. This is determined by the hardware fitted.		This is typically used for extruder applications and is described further in section 7.1.6 'Cooling Algorithm'.
	Lin	Linear (factory default) The characterisation of the cool output is linear	
	Oil	Oil Being non-evaporative, oil cooling is pulsed. It is deep and more direct and will not need such a high cool gain as fan cooling.	
	H2o	Water A complication with water-cooling comes if the zone is running well above 100°C. Usually the first few pulses of water will flash off into steam giving a greatly increased cooling capacity due to the latent heat of evaporation. When the zone settles down, less or even no evaporation is a possibility and the cooling is less severe. To handle evaporative cooling, water cool mode would generally be chosen. This technique delivers much shortened pulses of water for the first few percent of the cooling range, when the water is likely to be flashing off into steam. This compensates for the transition out of the initial strong evaporative cooling.	
	FAn	Forced air (Fan) This is much gentler than water cooling and not so immediate or decisive because of the long heat transfer path through the finned aluminium cooler and barrel. With fan cooling, a cool gain setting of 3 upwards would be typical. Delivery of pulses to the blower is such that the on time increases with percentage cool demand determined by the controller.	

5.2.5 Output 1

Output 1 may be fitted with a relay (form A), or a logic output depending on the order code. The function of the output may be selected from a list of options including heat or cool outputs for the control loop, or alarms or events which may be used for external indication.

P11	Select P11 to configure Output 1 (OP1) .		The code can be checked against the label on the side of the controller and the 'Order Code' in section 1.5.		
	<i>nonE</i>	Output disabled			
	<i>HEAT</i>	Heat output (factory default)	Output 1 controls the heating power demand. The sense is set to normal - the state of the output is shown in the table. This is the usual setting for control outputs.	OP1 State when heating	
				Relay	Energised
				Logic	ON
	<i>COOL</i>	Cool output	Output 1 controls the cooling demand. The sense is set to normal - the state of the output is shown in the table. This is the usual setting for control outputs.	OP1 State when cooling	
				Relay	Energised
				Logic	ON
	<i>AL1</i>	Alarm 1	Output 1 will operate as shown in the table if the alarm selected is active.	Alarm active	
	<i>AL2</i>	Alarm 2		Relay	Energised
	<i>AL3</i>	Alarm 3		Logic	ON
	<i>AL1.i</i>	Alarm 1 inverted.	Output 1 will operate as shown in the table if the selected alarm is active. This is the normal setting for alarms since if power to the controller fails an alarm state will be indicated by a powered external device.	Alarm active	
<i>AL2.i</i>	Alarm 2 inverted	Relay		De-energised	
<i>AL3.i</i>	Alarm 3 inverted	Logic		OFF	
<i>tEnd</i>	Timer end status	OP1 can be used to operate an external device to indicate when the timer has timed out. A relay is energised or a logic output is ON when the timer has timed out.	Timer Operation is described in section 4.12.		
<i>tRun</i>	Timer run status	OP1 can be used to operate an external device to indicate when the timer is running. A relay is energised or a logic output is ON when the timer is running.			

5.2.6 Output 2

Output 2 may be fitted with a relay (form A), or a triac or an analogue output depending on the order code. The function of the output may be selected from a list of options including heat or cool outputs for the control loop, or alarms or events which may be used for external indication. mA outputs may be used to re-transmit setpoint, measured temperature or output demand.

P12	Select P12 to configure Output 2 (OP2) . In P116, output 2 may be Relay, Analogue or Triac depending on the order code. In P108 and P104, output 2 may be Relay or Triac depending on the order code. Each output can be used for control, retransmission, alarms or events as listed below:-		The code can be checked against the label on the side of the controller and the 'Order Code' in section 1.5.		
	nonE	Output disabled (factory default)			
	HEAT	Heat output	Output 2 controls the heating power demand. The sense is set to normal - the state of the output is shown in the table. This is the usual setting for control outputs.	OP2 State when heating	
				Relay	Energised
				Logic	ON
	Analogue	On			
	COOL	Cool output	Output 2 controls the cooling demand. The sense is set to normal - the state of the output is shown in the table. This is the usual setting for control outputs.	OP2 State when cooling	
				Relay	Energised
				Logic	ON
	Analogue	On			
	AL1	Alarm 1	Output 2 will operate as shown in the table if the alarm selected is active.	Alarm active	
	AL2	Alarm 2		Relay	Energised
	AL3	Alarm 3		Logic	ON
	Analogue	On			
	AL1.	Alarm 1 inverted.	Output 2 will operate as shown in the table if the selected alarm is active. This is the normal setting for alarms since if power to the controller fails an alarm state will be indicated by a powered external device.	Alarm active	
AL2.	Alarm 2 inverted	Relay		De-energised	
AL3.	Alarm 3 inverted	Logic		OFF	
Analogue	Off (0mA)				
SPrt	SP re-transmission	If OP2 is mA it can be used to transmit an analogue value proportional to the setpoint to an external device.	The value is clipped to Low (SPLo) and High (SPHi) Setpoint limits set in Level 2.		
OPrt	OP re-transmission	If OP2 is mA it can be used to transmit an analogue value proportional to the output to an external device.	The value of the analogue signal is clipped to the Low (OPLo) and High (OPHi) output limits set in Level 2.		
PVrt	PV re-transmission	If OP2 is mA it can be used to transmit an analogue value proportional to the process variable to an external device.	The value of the analogue signal is clipped to the Low and High scale range set in P codes P3 and P4.		
tEnd	Timer end status	OP2 can be used to operate an external device to indicate when the timer has timed out. A relay is energised and a logic output is ON when the timer has timed out.	Timer Operation is described in section 4.12.		
tRun	Timer run status	OP2 can be used to operate an external device to indicate when the timer is running. A relay is energised and a logic output is ON when the timer is running.			

5.2.7 Output 3

Output 3 is available in P108 and P104 only and may be fitted with a relay (form A), or an analogue output depending on the order code. It can be a control or re-transmission output. The function of the output may be selected from a list of options including heat or cool outputs for the control loop, or alarms or events which may be used for external indication.

P13	Select P13 to configure Output 3 (OP3) .		The code can be checked against the label on the side of the controller and the 'Order Code' in section 1.5.		
	Output 3 is not available in model P116.				
	nonE	Output disabled (factory default)			
	HEAT	Heat output	Output 3 controls the heating power demand. The sense is set to normal - the state of the output is shown in the table. This is the usual setting for control outputs.	OP3 State when heating	
				Relay	Energised
				Analogue	On
	COOL	Cool output	Output 3 controls the cooling demand. The sense is set to normal - the state of the output is shown in the table. This is the usual setting for control outputs.	OP3 State when cooling	
				Relay	Energised
				Analogue	On
	AL1	Alarm 1	Output 3 will operate as shown in the table if the alarm selected is active.	Alarm active	
	AL2	Alarm 2		Relay	Energised
	AL3	Alarm 3		Analogue	On
	AL1,	Alarm 1 inverted.	Output 3 will operate as shown in the table if the selected alarm is active. This is the normal setting for alarms since if power to the controller fails an alarm state will be indicated by a powered external device.	Alarm active	
	AL2,	Alarm 2 inverted		Relay	De-energised
AL3,	Alarm 3 inverted	Analogue		Off (0mA)	
SPrt	SP re-transmission	If OP3 is mA it can be used to transmit an analogue value proportional to the setpoint to an external device.	The value is clipped to Low (SPLo) and High (SPHi) Setpoint limits set in Level 2.		
oPrt	OP re-transmission	If OP3 is mA it can be used to transmit an analogue value proportional to the output to an external device.	The value of the analogue signal is clipped to the Low (oPLo) and High (oPHi) output limits set in Level 2.		
PVrt	PV re-transmission	If OP3 is mA it can be used to transmit an analogue value proportional to the process variable to an external device.	The value of the analogue signal is clipped to the Low and High scale range set in P codes P3 and P4.		
tEnd	Timer end status	OP3 can be used to operate an external device to indicate when the timer has timed out. A relay is energised when the timer has timed out.	Timer Operation is described in section 4.12.		
tRun	Timer run status	OP3 can be used to operate an external device to indicate when the timer is running. A relay is energised when the timer is running.			

5.2.8 Output 4

Output 4 is available as standard in all models. It is always a changeover relay and can be used for control, alarms or events.

P14	Select P14 to configure Output 4 (OP4) .			The code can be checked against the label on the side of the controller and the 'Order Code' in section 1.5.	
	<i>nonE</i>	Output disabled			
	<i>HEAT</i>	Heat output	Output 4 controls the heating power demand. The sense is set to normal - the state of the output is shown in the table. This is the usual setting for control outputs.	OP4 State when heating	
				Relay	Energised
	<i>COOL</i>	Cool output	Output 4 controls the cooling demand. The sense is set to normal - the state of the output is shown in the table. This is the usual setting for control outputs.	OP4 State when cooling	
				Relay	Energised
	<i>AL1</i>	Alarm 1	Output 4 will operate as shown in the table if the alarm selected is active.	Alarm active	
	<i>AL2</i>	Alarm 2 (factory default)		Relay	Energised
	<i>AL3</i>	Alarm 3			
	<i>AL1,1</i>	Alarm 1 inverted.	Output 4 will operate as shown in the table if the selected alarm is active. This is the normal setting for alarms since if power to the controller fails an alarm state will be indicated by a powered external device.	Alarm active	
	<i>AL2,1</i>	Alarm 2 inverted		Relay	De-energised
	<i>AL3,1</i>	Alarm 3 inverted			
<i>tEnd</i>	Timer end status	OP4 can be used to operate an external device to indicate when the timer has timed out. A relay is energised and a logic output is ON when the timer has timed out.	Timer Operation is described in section 4.12.		
<i>tRun</i>	Timer run status	OP4 can be used to operate an external device to indicate when the timer is running. A relay is energised and a logic output is ON when the timer is running.			

5.2.9 DC Output Range

Isolated DC (analogue) outputs may be fitted in OP2 in P116 and OP3 in P108 & P104 depending on the order code. They can be configured using P15 for 0 - 20mA or 4 - 20mA. P15 sets the range for all DC outputs.

P15	Select P15 to define the DC output .			
	P15 is only shown if a DC output is fitted.			
	<i>0.20</i>	0 - 20mA	<i>4.20</i>	4 - 20mA (factory default)

5.2.10 Setpoint Retransmission Range

P16	Retransmission low scale value		
	P16 sets the low limit range for the setpoint re-transmission. It is only shown if a DC output is fitted and <i>SPrt</i> is set in P12 or P13. This value is clipped to the SP Low Limit set by <i>SPLo</i> in Level 2.		

P17	Retransmission high scale value		
	P17 sets the high limit range for the setpoint re-transmission. It is only shown if a DC output is fitted and <i>SPrt</i> is set in P12 or P13. This value is clipped to the SP High Limit set by <i>SPHi</i> in Level 2.		

5.2.11 Alarms

Up to three alarms can be configured. They are used to detect out of range values.

P21	Select P21 to configure Alarm 1 Type . P21 is always available.			For further details see section 4.4 'Alarms'. Alarms can also be configured using the Quick codes section 4.1.3 or using iTools section 10.5.2.3.	
	<i>nonE</i>	Alarm not configured (factory default)	<i>dHi</i>		Deviation high
	<i>Hi</i>	Full scale high	<i>dLo</i>		Deviation low
	<i>Lo</i>	Full scale low	<i>bnd</i>		Deviation band
P22	Select P22 to configure Alarm 1 latching type . P22 is not shown if P21 = none.			See section 4.4.4.	
	<i>nonE</i>	Non latching (factory default). A non latching alarm will reset itself when the alarm condition is removed. If it is still present when acknowledged the ALM beacon illuminates constantly, the flashing alarm messages remain and the output remains active.	<i>RuLo</i>	Latching with automatic reset. An auto latching alarm requires acknowledgement before it is reset. The acknowledgement can occur BEFORE the condition causing the alarm is removed.	
	<i>lARn</i>	Latching manual reset The alarm continues to be active until both the alarm condition is removed AND the alarm is acknowledged. The acknowledgement can only occur AFTER the condition causing the alarm is removed.	<i>noRL</i>	Non latching no ALM message. If an alarm occurs, any output attached to the alarm will operate and the corresponding beacon on the controller display will illuminate. No alarm message will be flashed in the display.	
P23	Select P23 to configure Alarm 1 as a Blocking Alarm . P23 is not shown if P21 = none. Alarm Blocking is used to prevent alarms from activating during start-up. In some applications, the measurement at start-up is in an alarm condition until the system has come under control. Blocking causes the alarms to be ignored until the system is under control (in the safe state), after this any deviations trigger the alarm.			See section 4.4.5	
	<i>no</i>	Alarm 1 operates as a normal alarm (no blocking) (factory default)	<i>YES</i>		Alarm 1 is a blocking alarm
P24	Select P24 to configure Alarm 2 Type . P24 is always available.			See section 4.4.	
	<i>nonE</i>	Alarm not configured	<i>dHi</i>		Deviation high
	<i>Hi</i>	Full scale high (factory default)	<i>dLo</i>		Deviation low
	<i>Lo</i>	Full scale low	<i>bnd</i>		Deviation band
P25	Select P25 to configure Alarm 2 latching type . P25 is not shown if P24 = none.			See section 4.4.4.	
	<i>nonE</i>	Non latching (factory default)	<i>RuLo</i>	Latching with automatic reset	
	<i>lARn</i>	Latching manual reset	<i>noRL</i>	Non latching no ALM indication	
P26	Select P26 to configure Alarm 2 as a Blocking Alarm . P26 is not shown if P24 = none.			See section 4.4.5	
	<i>no</i>	Alarm 2 operates as a normal alarm (no blocking) (default)	<i>YES</i>		Alarm 2 is a blocking alarm
P27	Select P27 to configure Alarm 3 Type .			See section 4.4.	
	<i>nonE</i>	Alarm not configured (factory default)	<i>dHi</i>		Deviation high
	<i>Hi</i>	Full scale high	<i>dLo</i>		Deviation low
	<i>Lo</i>	Full scale low	<i>bnd</i>		Deviation band
P28	Select P28 to configure Alarm 3 Latching Type . P28 is not shown if P27 = none.			See section 4.4.4.	
	<i>nonE</i>	Non latching (factory default)	<i>RuLo</i>	Latching with automatic reset	
	<i>lARn</i>	Latching manual reset	<i>noRL</i>	Non latching no ALM indication	
P29	Select P29 to configure Alarm 3 as a Blocking Alarm . P29 is not shown if P27 = none.			See section 4.4.5	
	<i>no</i>	Alarm 3 operates as a normal alarm (no blocking) (factory default)	<i>YES</i>		Alarm 3 is a blocking alarm

5.2.12 Current Transformer

The current transformer is used to measure current for use in energy estimation calculations and heater health diagnostics. The current transformer fault detection algorithms must be synchronised to the output demand. The CT source identifies which output is responsible for switching current through the load. It is valid only for logic or relay outputs. DC Outputs cannot be used with this facility.

P31	Select P31 to configure the Current Transformer Source .			CT alarms include:- Load current Leakage current Over-current The threshold values are set in Level 2.	
	Note: the output mnemonic in the following list will only be shown if the output is configured for control.				
	<i>nonE</i>	Load diagnostics and alarms are not generated. The values for load and leakage current will follow the instantaneous current read via the CT. This can be useful to allow an 'indication only' reading of current.			
	<i>oP1</i>	OP1 Function linked to output 1	<i>oP3</i>		OP3 Function linked to output 3. This must be a relay output.
	<i>oP2</i>	OP2 Function linked to output 2. This must be either a triac or relay output.	<i>oP4</i>	OP4 Function linked to output 4	

P32	Select P32 to configure Current Transformer Range . The CT input is designed to accept signals in the range 0-50mA. An external current transformer is required to step down the switched current to this range. The range should be set to the nominal rating of the electrical load. Only available if the CT option is configured by P31.	Default 10.0
	10.0 to 999.9 amps	

P33	Select P33 to configure Current Transformer Alarm Latching . Latching alarms retain the alarm state until acknowledged by the operator. There are three CT alarm types (Leak, Load and OverCurrent) which all share the same configuration. A current alarm may be attached to AL1, AL2 or AL3 using P37.			Latching alarms are described in section 4.4.4 'Alarm Latching'. The CT alarms may be attached to AL1, AL2 and AL3 using the parameter P37. This is described in section 5.2.14.
	<i>nonE</i>	Non Latching alarms clear automatically when the condition causing the alarm clears, and require no operator intervention.		
	<i>ALto</i>	An automatic latch may be acknowledged at any time. The alarm will reset immediately after the alarm has been acknowledged <i>and</i> the measurement has returned to the safe state.	<i>MAN</i>	

5.2.13 Loop Break Alarm

The loop is considered to be broken if the PV does not respond to a change in the output in a set amount of time. Since the time of response will vary from process to process the Loop Break Alarm Time parameter allows a time to be set before an alarm is initiated.

P34	Select P34 to configure Loop Break Alarm Time . Range is <i>oFF</i> (factory default) or <i>1</i> to <i>9999</i> seconds	Loop Break is described in more detail in section 7.1.10 The loop break alarm may be attached to AL1, AL2 and AL3 using the parameter P37. This is described in section 5.2.14.

5.2.14 Sensor Break, Loop Break and Current (CT) Alarms

The instrument monitors the health of the input sensor so that if a fault develops the loop can be put into a safe state. A sensor fault is normally an open circuit or high impedance, see section 5.2.14.1).

P35	Select P35 to configure Sensor Break Alarm Type .	
	on	A sensor fault will be detected (factory default). The alarm message 5br will be flashed in the display. An output attached to this alarm will operate as a logic OR with the alarm type also attached to the output. Acknowledging the alarm has no effect.
	LAL	A sensor fault alarm will be latched. The alarm indication and the state of the output can only be acknowledged after the open circuit sensor condition has been repaired. Then the output resets, the ALM beacon and the 5br indication will disappear. The latching of the sensor break alarm is independent of any other alarm connected to the same output.
	oFF	Open circuit sensor will not be detected.

P36 Select P36 to configure **Safe output power (sensor break)**.
 If a sensor break alarm occurs this parameter sets the output level that the controller will adopt. The default is 0% which means that all control outputs are off. The full range is limited by the settings of **oPLo** and **oPHi** set in Level 2. These settings are also limited by P36. The level set must be chosen with care to make sure that the process does not over heat or over cool. It can, however, be useful to maintain a small amount of power to keep the process at a 'standby' temperature for a short time while the sensor is changed or the break is repaired.

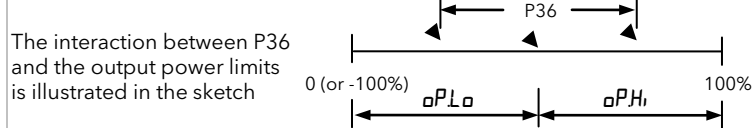

The interaction between P36 and the output power limits is illustrated in the sketch

P37 Select P37 to configure **Break alarms output**
 Break alarms include sensor break, loop break and current (CT) alarms. P37 attaches the break alarms to AL1, AL2 and/or AL3. AL1, AL2 and AL3 can only be selected if they have been connected to an output using P11 to P14. The selected output, which may be latched or unlatched, acts as a logic OR with other alarms attached to it.
 Note: A break alarm will still operate an output even if the alarm type is not configured, i.e. the alarm type may be set to NONE.

nonE	The sensor break alarm is indication only and does not operate an output (factory default).
AL 1	AL 1, AL 2, or AL 3 must be connected to an output using 'P' codes P11, P12, P13 and/or P14, for it to become available in this list, otherwise it will not be shown here.
AL 2	
AL 3	If P37 is then configured for AL 1, AL 2, or AL 3 the break alarm will operate on the appropriate output.

Note: It is possible to connect AL1 (or 2 or 3) to more than one output. In this case all outputs that have been connected will operate if AL1 (or 2 or 3) is active.
 This is illustrated in the examples given in the table:

P11 OP1	P12 OP2	P13 OP3	P14 OP4	Alarms available in P37		
H	C	AL 1	AL 2	AL 1	AL 2	AL 3
H	AL 1	AL 2	AL 3	AL 1	AL 2	AL 3
AL 1	AL 2	AL 3	nonE	AL 1	AL 2	AL 3
AL 1	AL 2	nonE	nonE	AL 1	AL 2	
nonE	nonE	nonE	nonE	nonE	nonE	
tEnd	tRun	H	nonE	nonE	nonE	
AL 1	AL 1	AL 1	AL 1	AL 1		
AL 2	AL 2	AL 2	AL 2	AL 2		
AL 1	AL 3	nonE	nonE	AL 1	AL 3	

Example 1:

To Configure a Sensor Break Alarm

In this example the break alarms will be attached to **AL 1** which will operate the output 4 relay.

To connect alarm 1 to output 4, select P14 for **AL 1**.

To attach the break alarms to alarm 1, select P37 for **AL 1**.

If it is required to latch output 4, select P35 to latch the sensor break alarm, P33 to latch the load current alarms or P34 to latch the loop break alarm.

Select P36 and adjust to a value of output power which the controller should go to in the event of an open circuit sensor. This may be 0 or it may be a level which keeps the process in a 'standby' state. Care must be taken to ensure that the power level selected is safe for the process. In a temperature control application a separate over temperature unit should be used.

When the controller is in operating mode any break alarm will operate OP4. OP4 will also operate if AL1 type (P21) is configured.

Alarm	Display
Sensor break	5br
Low load current threshold Ld.AL	ctLd
High leakage current threshold LE.AL	ctLE
Loop break alarm	Lbr

Note: if AL1 Type = Hi (or D.hi or Bnd) then both **5br** and **AL 1** will be flashed in the display because the sensor break alarm exceeds the high alarm setting.

5.2.14.1 Sensor Break Impedance

In some cases the sensor may not immediately break but corrosion may lead to a high impedance condition.

1. For thermocouples a break is indicated if the impedance is greater than about 20KΩ.
2. For a PRT input, sensor break is indicated if any one of the three wires is broken or if the source resistance exceeds about 420Ω or falls below about 15Ω.
3. For mA and volts input sensor break will not be detected due to the load resistor connected across the input terminals.

5.2.15 Timer

An internal timer can be configured to operate in one of three different modes or types. These are Dwell Timer, Delayed Switch on Timer and Soft Start Timer. Event outputs (using outputs 1 to 4) may be configured to trigger when the timer is running or at the end of the timer sequence.

P41	Select P41 to configure the Timer Type .				For further details see section 4.12 'Timer'.
	nonE	Timer disabled (factory default)	dLL	Dwell at temperature. This may be used in combination with the setpoint ramp limit to provide a simple ramp/dwell temperature sequence, which may be used to control a process at a fixed temperature for a defined period. It is necessary to set a threshold level at which timing will start. This parameter is LEhr and is available in operator level 2.	
	dELY	Delayed switch on timer. This timer is used to switch on the output power after a set time. It will start timing as soon as the controller is powered up or when it is manually set to RUN. The controller remains in standby with heating and cooling off until the time has elapsed. After the time has elapsed, the instrument controls at the target setpoint. This type of timer may be used to implement a switch on delay, and often eradicates the need for a separate timer device.	SS	Soft start timer. This provides a power limit before switch on. It starts automatically on power up, and applies a power limit ('SS.op' set in Level 2) until the temperature reaches a set value ('SS.SP' set in Level 2). It is typically used, for example, to dry-out heaters in Hot Runner control systems before full power is allowed.	
P42	Select P42 to configure Timer resolution .				For further details see section 4.12 'Timer'.
	Not shown if P41 = none.				
	Hour	Hours HH:MM (factory default)	Min	Minutes MM:SS	
P43	Select P43 to configure Timer end type .				For further details see section 4.12 'Timer'.
	P43 is only applicable if the timer is a Dwell type.				
	P43 determines what action should take place when the timer has timed out. The Timer end event may be configured to operate an output, normally a relay.				
	OFF	When the timer completes its dwell, the instrument will be put into Standby mode. The output power will be set to 0%, and the standard home display will display PV and OFF instead of setpoint.	dLL	When the timer completes, the controller will continue to control at setpoint.	
	SP2	When the timer completes, the target setpoint will switch to setpoint 2. Setpoint 2 may be a lower or a higher temperature. If the setpoint rate limit is enabled, then the controller will ramp to the setpoint 2 at the SRL rate. During this ramp, the Timer status will indicate RUN. Once the setpoint 2 is reached the status will change to END. This can be used to provide a simple ramp/dwell/ramp/dwell sequence.	rES	The timer will reset on completion. It will revert to the setpoint used at the point it was started.	

5.2.16 Digital (Contact) Inputs

P51	Select P51 to configure Digital 1 Input Function		
	Digital Input 1 is a contact closure digital input. It may be operated from external switches or relays and is generally edge triggered on contact closure.		
	The input may be used to perform a number of functions as selected from the list below.		
	An open input is detected if the impedance between the terminals is greater than 500 ohms.		
	A closed input is detected if the impedance between the terminals is less than 200 ohms.		
Digital Input 1 is optionally available in all models.			
<i>nonE</i>	Input not used (factory default)	<i>AcAL</i>	Close the contact to acknowledge any active alarm
<i>SPSL</i>	Setpoint select. Close the contact to select setpoint 2. Open the contact to select setpoint 1.	<i>Locb</i>	Keylock. Close the contact to lock the front panel buttons. Open the contact to unlock the front panel buttons.
<i>trES</i>	Timer reset. Close the contact to reset a currently running timer sequence.	<i>trUn</i>	Timer run. Close the contact to start a timer sequence running.
<i>trrS</i>	Timer run/reset. Close the contact to run a timer sequence. Open the contact to reset the timer.	<i>tHLd</i>	Timer hold. Close the contact to stop the timer at its current time.
<i>MAN</i>	Select manual. If the controller is in Auto, make the contact permanently to select Manual. If the controller is already in Manual, make then break the contact to return to Auto.	<i>Sby</i>	Standby mode. In this mode control outputs go to zero demand.

P52	Select P51 to configure Digital 2 Input Function		
	Digital input 2 allows the same functions as listed for Digital Input 1 to be performed. Digital Input 2 is not available in P116 but it is optionally available in models P108 and P104.		
	Digital input 2 is generally edge triggered on contact closure.		
<i>nonE</i>	Input not used (factory default)	<i>AcAL</i>	Close the contact to acknowledge any active alarm
<i>SPSL</i>	Setpoint select. Close the contact to select setpoint 2. Open the contact to select setpoint 1.	<i>Locb</i>	Keylock. Close the contact to lock the front panel buttons. Open the contact to unlock the front panel buttons.
<i>trES</i>	Timer reset. Close the contact to reset a currently running timer sequence	<i>trUn</i>	Timer run. Close the contact to start a timer sequence running.
<i>trrS</i>	Timer run/reset. Close the contact to run a timer sequence. Open the contact to reset the timer.	<i>tHLd</i>	Timer hold. Close the contact to stop the timer at its current time.
<i>MAN</i>	Select manual. If the controller is in Auto, make the contact permanently to select Manual. If the controller is already in Manual, make then break the contact to return to Auto.	<i>Sby</i>	Standby mode. In this mode control outputs go to zero demand.

5.2.17 Digital Communications

Digital communications is orderable in all models. It uses Modbus protocol and EIA485 (RS485) 2-wire interface .

P61	Select P61 to configure Digital Communications Address . On a network of instruments the address is used to specify a particular instrument. Each instrument on a network should be set to a unique address from 1 to 254.	For further details see section 8 'Digital Communications'.
	1 to 254 (factory default = 1)	

P62	Select P62 to configure Digital Communications Baud Rate . The baud rate of a comms network specifies the speed at which data is transferred between the instrument and the master. As a rule, the baud rate should be set as high as possible to allow maximum throughput. This will depend to some extent on the installation and the amount of electrical noise the communications link is subject to, but the instruments are capable of reliably operating at 19,200 baud under normal circumstances and assuming correct line termination. Although the baud rate is an important factor, when calculating the speed of communications in a system it is often the 'latency' between a message being sent and a reply being started that dominates the speed of the network. This is the amount of time the instrument requires on receiving a request before being able to reply. For example, if a message consists of 10 characters (transmitted in 10msec at 9600 Baud) and the reply consists of 10 characters, then the transmission time would be 20 msec. However, if the latency is 20msec, then the transmission time has become 40msec. Latency is typically higher for commands that write to a parameter than those that read, and will vary to some degree depending on what operation is being performed by the instrument at the time the request is received and the number of variables included in a block read or write. As a rule, latency for single value operations will be between 5 and 20 msec, meaning a turnaround time of about 25-40msec. This compares very favourably with competing devices, which can often take as much as 200msec to turn around communications transactions. If throughput is a problem, consider replacing single parameter transactions with Modbus block transactions, and increase the baud rate to the maximum reliable value in the installation.	For further details see section 8 'Digital Communications'.			
	1200		1200 bps	9600	9600 bps (factory default)
	2400		2400 bps	1920	19200 bps
	4800		4800 bps		

P63	Select P63 to configure Digital Communications Parity . Parity is a method of ensuring that the data transferred between devices has not been corrupted. Parity is the lowest form of integrity in the message, it ensures that a single byte contains either an even or an odd number of ones or zeros in the data. In industrial protocols, there are usually layers of checking to ensure that first the byte transmitted is good and then that the message transmitted is good. Modbus applies a CRC (Cyclic Redundancy Check) to the data to ensure that the packet of data is not corrupted. Thus, there is usually no benefit in using odd or even parity, and since this also increases the number of binary bits transmitted for any messages, it decreases throughput.	For further details see section 8 'Digital Communications'.			
	nonE		No parity (factory default)	odd	Odd parity
	EuEn		Even parity		

5.2.17.1 Broadcast Communications

Broadcast master communications allows a Piccolo range controller to send a single value to a number of slaves. It uses function code 6 (write single value). This allows the controller to link with other products. A typical application is to send a setpoint from a master to a number of slave instruments.

P64	Select P64 to configure Digital Communications Slave/Master Transmission Slave/Master Transmission is available in all models		For further details see section 8.3 'Master/Slave Communications'.
	nonE	Master comms disabled (factory default)	
	.SP	The master working setpoint is retransmitted. Typically it would be sent to address 26 decimal in Piccolo slave units. This is the remote setpoint. A local trim can be added to the remote setpoint to compensate for desired temperature variations in a particular zone.	
	.PU	The measured value (PV) in the master is retransmitted. This might be used, for example, to log a temperature to a chart recorder.	
	.oP	The Output Power from the master control loop is transmitted. This may be used, for example, to drive a phase angle fired thyristor power controller.	
	.Err	Process Error (Temperature - Setpoint) is retransmitted.	
P65	Select P65 to configure Digital Communications Retransmission Address This variable selects the destination Modbus register address for the broadcast. For example, to retransmit the master working setpoint to a group of Piccolo slaves, you should select a Comms Retransmission Address of 26. This is the address of the remote setpoint in these slave units. Be very careful when selecting an address to broadcast to make sure that the receiving unit is capable of accepting large numbers of writes to the address you are sending to. Many low cost units, including the Piccolo range, have a limited number of writes permitted to their non-volatile memory - typically 100,000 - and can easily be damaged by a broadcast value sent too often. This typically becomes a problem when writing to setpoints when ramps are used. Use the Remote Setpoint at address 26 for Piccolo range slaves, and check with your equipment supplier if in doubt. Retransmission Address is available in all models		For further details see sections 8.3 'Master/Slave Communications' and section 8.4 'EEPROM Write Cycles'.
	0 to 9999	(factory default = 0)	

5.2.18 Pushbutton Functionality

P71	Select P71 to configure the functionality of Pushbutton F1	
	Function button F1 is an undedicated button which can be customised so that, when in operator level, it will directly select a specific parameter. Function button F1 is available in models P108 and P104 only.	
	<i>nonE</i>	Pushbutton not used. If F1 is pressed when the controller is in operator level, the button will be inoperative.
	<i>AcAL</i>	Alarm Acknowledge. The parameter <i>AcAL</i> will be promoted to function button F1 and <i>AcAL</i> will be removed from the Operator Level 2 list. F1 will then give direct access to the alarm acknowledge parameter. This can then be acknowledged in the normal way using the raise/lower buttons. The action which takes place depends on the Latching Type which has been configured. See also Note 1 below
	<i>SPSL</i>	Setpoint select The parameter <i>SPSL</i> will be promoted to function button F1 and <i>SPSL</i> will be removed from the Operator Level 2 list. F1 will give direct access to the setpoint select parameter. The required operating setpoint, SP1 or SP2, is then selected in the normal way using the raise/lower buttons.
	<i>A-M</i>	Auto/Manual status The parameter <i>A-M</i> will be promoted to function button F1 and will be removed from the Operator Level 2 list. F1 will give direct access to the Auto/Manual select parameter. Auto, Manual or Off mode is then selected in the normal way using the raise/lower buttons.
	<i>tSt</i>	Timer Status The timer status parameter, <i>tSt</i> , will be promoted to function button F1 and will be removed from the Operator Level 2 list. F1 will give direct access to the Timer Status parameter so that the timer may be Run, Reset or put into Hold mode using the raise/lower buttons. If no timer is configured the function buttons will not operate if this option is chosen.
<i>ErSt</i>	Reset Energy Counter. The parameter <i>ErSt</i> will be promoted to function button F1 and will be removed from the Operator Level 2 list. F1 will give direct access to the Energy Counter Reset parameter so that the Partial and Total energy totalisers can be reset using the raise/lower buttons.	
		For further information see section 4.4.3.
		For further information see section 4.7.2
		For further information see section 4.10
		For further information see section 4.12
		For further information see section 4.11.

P72	Select P72 to configure the functionality of Pushbutton F2	
	Function button F2 is an undedicated button which can be customised so that, when in operator level, it will directly select a specific parameter. Function button F2 is available in models P108 and P104 only.	
	<i>nonE</i>	Pushbutton not used
	<i>AcAL</i>	Alarm Acknowledge See also Note 1 below
	<i>SPSL</i>	Setpoint select
	<i>A-M</i>	Auto/Manual status
	<i>tSt</i>	Timer Status
<i>ErSt</i>	Reset Energy Counter	
		The functionality is the same as described above for Function button F1

P73	Select P73 to configure the functionality of the Page Pushbutton 	
	In addition to its normal function the Page button can be configured so that, when in operator level, it will directly select a specific parameter. This feature is available in all models.	
	<i>nonE</i>	Pushbutton not used
	<i>AcAL</i>	Alarm acknowledge See also Note 1 below
	<i>SPSL</i>	Setpoint select
	<i>A-M</i>	Auto/Manual status
	<i>tSt</i>	Timer Status
<i>ErSt</i>	Reset Energy Counter	
		The functionality is the same as described above for Function button F1

Note 1:

As stated in section 4.3 the Alarm Acknowledge parameter only appears in Level 1 if a latching alarm is configured. If a non-latching alarm is configured *AcAL* will NOT appear in Level 1 when the function button is pressed. It will only appear if Level 2 is selected.

5.2.19 Display Functionality

P74	Select P74 to configure the Second Line of the display . In operator level the upper line of the display always shows PV, the second line of the display may be customised from the following list of parameters.		
<i>Setd</i>	In Automatic mode the second line of the display will show setpoint. In Manual mode the second line of the display will show output power. In OFF mode it will show OFF . (<i>Setd</i> is the factory default for P74)		
<i>oP</i>	In Automatic mode the second line of the display will show output power demand (in %) and is read only. In Manual mode the second line of the display will show output power (in %) and is manually adjustable. In OFF mode the second line of the display will show output power and is fixed at 0.0 (in %).		
<i>trE</i>	Timer time remaining, in minutes or hours as configured		
<i>tEL</i>	Timer time elapsed, in minutes or hours as configured and is read only.		
<i>EPRr</i>	The second line will display an estimate of the energy usage over a given period. This parameter is a totaliser which is useful for estimating the energy usage for individual batches.		
<i>Etot</i>	The second line will display an estimate of the energy usage over a total period. This parameter is a totaliser which is useful for estimating the energy usage for a complete process.		
<i>nonE</i>	Second line not used (blank)		

P75	Select P75 to configure the Third Line of the display . The third line of the display is only available in models P108 and P104. It is always read only since only the second line can be written to. In operator level the upper line of the display always shows PV, the third line of the display may be customised from the following list of parameters.		
<i>oP</i>	Output power will be shown in both Automatic and Manual modes. In OFF mode the display will read 0.0 (%). (<i>oP</i> is the factory default for P75)		
<i>trE</i>	Timer time remaining, in minutes or hours as configured		
<i>tEL</i>	Timer time elapsed, in minutes or hours as configured		
<i>EPRr</i>	Energy counter (partial energy counter value)		
<i>Etot</i>	Energy counter (total energy counter value)		
<i>nonE</i>	Third line not used (blank)		

5.2.20 Passcodes

Passcodes are required to enter both Operator Level 2 and Configuration Level. They are set to default values during manufacture but they can be re-configured using P76 and P77.

P76	Select P76 to configure Level 2 Pass code . Default value: 2 . The passcode required to enter Level 2 can be set in the range 0 to 9999 . In the case of level 2 passcode being set to 0 , it will not be necessary to enter a passcode to access level 2 and the controller will enter level 2 directly.	☺ Make a record of any changes to the passcode
P77	Select P77 to configure Configuration Level Pass code . Default value: 4 . The passcode required to enter Configuration Level can be set in the range 0 to 9999 . In the case of the configuration level passcode being set to 0 , it will not be necessary to enter a passcode to access configuration level and the controller will enter CONF directly.	☺ Make a record of any changes to the passcode

5.2.21 Energy Meter Source

The controller can make an estimate of the energy used for a total process or, for example, for different batches in a process. This information is totalised and shown in parameters E_{PR} and E_{tot} .

P81	Select P81 to configure Energy Meter Source .	
	It is necessary to define the output in which to make the energy measurement. This would normally be the output which make the biggest demand on the power, for example, the output supplying heaters.	
	$nonE$	Function not enabled (factory default)
	$OP1$	OP1 Function linked to output 1
	$OP2$	OP2 Function linked to output 2.
	$OP3$	OP3 Function linked to output 3.
	$OP4$	OP4 Function linked to output 4
P82	Select P82 to enter Nominal Load Power in KW . This value is manually entered, normally when commissioning the controller, and is the rated power of the load (heater power).	

5.2.22 Recovery Point

Recovery Point is a way to initialize all parameter values to a previously saved state or to a factory default table stored in read only memory. This can act as a very useful 'Undo' feature. It is also possible to issue a cold-start command to initialise the whole instrument to a predefined condition.

5.2.22.1 Recovery Point Save

rEc.S	Select rEc.S to configure Recovery point save . This allows the current configuration and operational settings of the controller to be saved.		To Save Current Settings Select rEc.S Select SAuE . The display shows bU5Y indicating that the save operation is in progress. Followed by donE indicating that the values have been stored. If the save operation has been unsuccessful FRiL will be displayed
	nonE	Do nothing (factory default)	
	SAuE	Take a snapshot of current configuration (P Code) and operator settings (Level 2). If subsequent changes are made to settings in the controller it is then possible to revert to these stored values if required.	

5.2.22.2 Recovery Point Load

rEc.L	Scroll to rEc.L to select Recovery point load . This allows the configuration values saved using rEc.S to be restored. Alternatively, it allows the factory default values to be re-loaded. A cold start removes all previously stored values. If the controller is then power cycled it will start as though it were a new controller 'out of the box' showing the Quick Start Codes - see section 4.1.1.		To Restore the Saved Settings Select rEc.L Select LoAd . The display will show donE indicating that the stored snapshot has been re-loaded. To Restore the Factory Default Settings Select rEc.L Select FRct . The display will show donE indicating that the original settings when the controller was supplied new have been re-loaded. The Factory default settings are listed in Appendix A. A cold start will delete all configurations. It is recommended that a clone file (section 10.7) is taken of the controller before attempting a cold start. The controller will return to the 'Quick Configuration' mode, section 4.1.1.
	nonE	Do nothing (factory default)	
	LoAd	Load and restore the current parameter values stored in a table. If no valid table is available a FRiL indication is displayed. The stored settings may include configuration parameters and operating variables.	
	FRct	Load and restore the factory default settings. The configuration and parameter values loaded during manufacture may be restored.	
CoLd	Cold start. This operation should be used with care since it deletes all previous configurations. Following a cold start, the controller will re-start showing SET1 of the Quick Configuration codes. At this point it is possible to recover the factory default settings. Alternatively, the controller may be configured at this point as though it were new out of the box.		

PHAS	Select Calibration phase The instrument is calibrated in the factory before it is shipped. It is however possible to re-calibrate the instrument in the field if necessary. To calibrate the sensor input a known traceable reference source, is required. A millivolt source is required for mV (mA) and thermocouple inputs and resistance box for platinum resistance thermometers. Calibration phase also includes calibration of analogue (mA) outputs and current transformer input.	For further details see section 9 'Calibration'
-------------	--	---

6. Controller Block Diagram

The block diagram shows the simple function blocks which make up the controller. Where applicable, each block is represented by the 'P' code as described in the previous section.

The quick start code and the 'P' codes set the parameters to match the hardware.

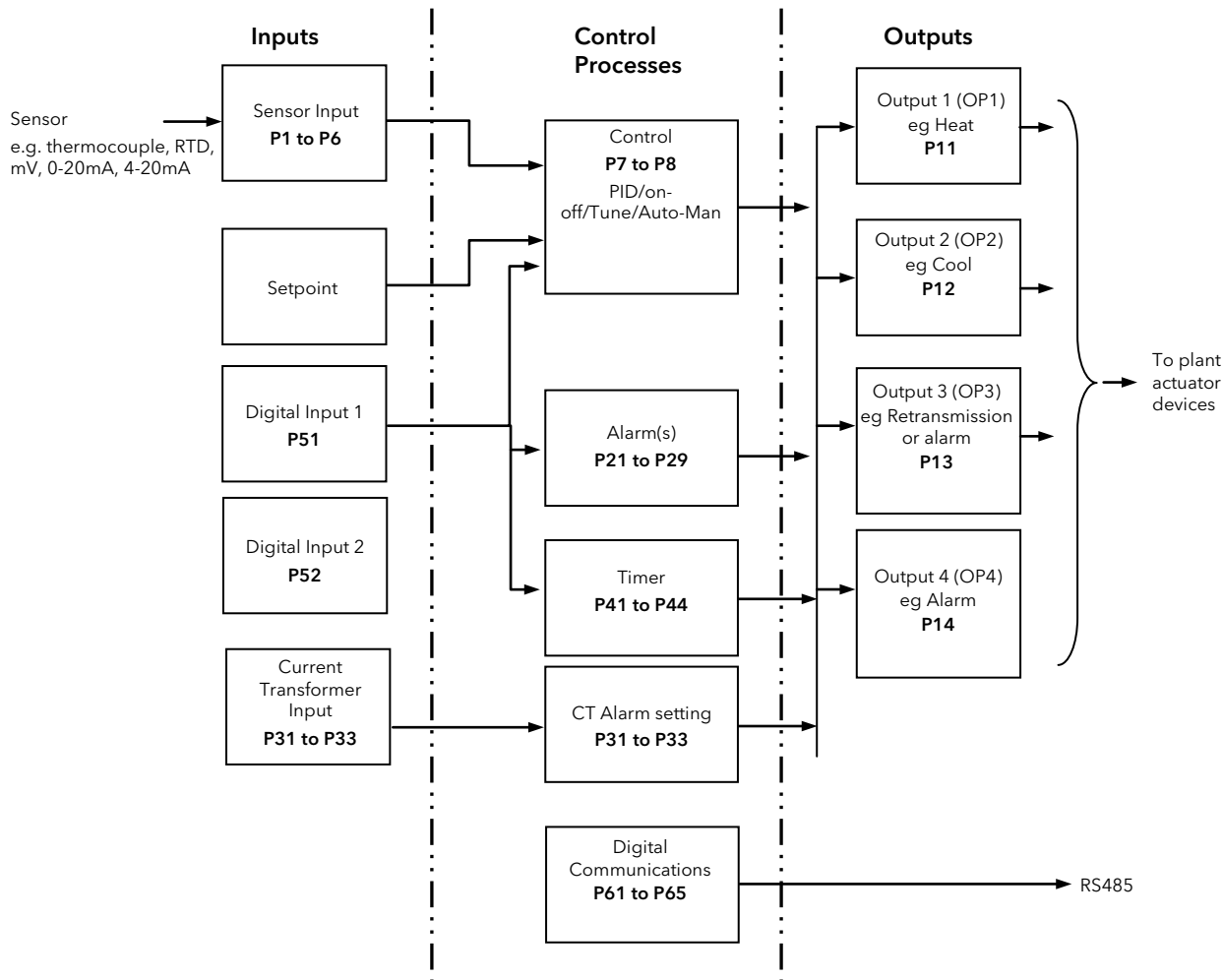

The Temperature (or Process Value, PV) is measured by the sensor and compared with a Setpoint (SP) set by the user.

The purpose of the control block is to reduce the difference between SP and PV (the error signal) to zero by providing a compensating output to the plant via the output driver blocks.

The timer and alarms blocks may be made to operate on a number of parameters within the controller, and digital communications provides an interface for data collection, monitoring and remote control.

The way in which each block performs is defined by its internal parameters. Some of these parameters are available to the user so that they can be adjusted to suit the characteristics of the process which is to be controlled.

These parameters are found in lists in both Operator Level 1 and Operator Level 2 where Level 1 is a sub-set of Level 2.

The above block diagram applies to P108 and P104 controllers.

For P116 Output 3 and Digital Input B are not present.

6.1 Input/Output

This section gives a summary of the I/O available in different models:-

- Digital Inputs
- Current Transformer Input
- Relay/Logic Outputs.

The availability of these is shown in the following table:-

Name	Availability			Typical Functions	Beacon (lit when active)	Terminal
	P116	P108	P104			
OP1	Relay Logic	Relay Logic	Relay Logic	Heat Cool Alarm Events (timer status)	OP1	1A, 1B
OP2	Relay Triac Analogue	Relay Triac	Relay Triac	Heat Cool Alarm Events (timer status) Retransmission (Setpoint, Process value, Output)	OP2	2A, 2B
OP3	Not available in P116	Relay Analogue	Relay Analogue	Heat Cool Alarm Events (timer status) Retransmission (Setpoint, Process value, Output)	OP3	3A, 3B
OP4	Relay (changeover)	Relay (changeover)	Relay (changeover)	Heat Cool Alarm Events (timer status)	OP4	AA, AB, AC
DI1	Contact input	Contact input	Contact input	Alarm acknowledge Setpoint 2 select Front keypad disable (Keylock) Timer reset Timer run Timer run/reset Timer hold Select manual Select standby mode		C, LA
DI2	Not available in P116	Contact input	Contact input	Alarm acknowledge Setpoint 2 select Front keypad disable (Keylock) Timer reset Timer run Timer run/reset Timer hold Select manual Select standby mode		LB, LC
CT	✓	✓	✓	Current measurement		C, CT
Digital Comms	✓	✓	✓	EIA485 (RS485)		HD, HE, HF

7. Control

Parameters in this section allow the control loop to be set up for optimum control conditions. An example of a temperature control loop is shown below:-

The actual temperature measured at the process (PV) is connected to the input of the controller. This is compared with a setpoint (or required) temperature (SP). If there is an error between the set and measured temperature the controller calculates an output value to call for heating or cooling. The calculation depends on the process being controlled but normally uses a PID algorithm. The output(s) from the controller are connected to devices on the plant which cause the heating (or cooling) demand to be adjusted which in turn is detected by the temperature sensor. This is referred to as the control loop or closed loop control.

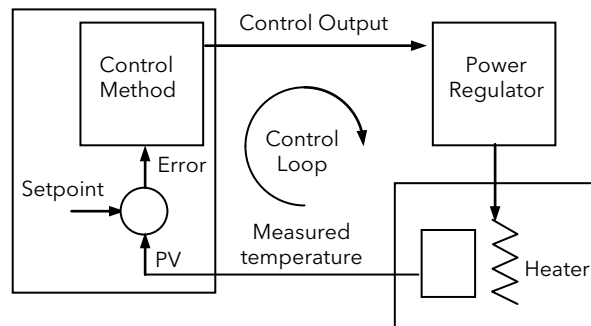

7.1 Types of Control

Two types of control loop may be configured. These are On/Off control, PID control.

7.1.1 On/Off Control

On/Off control is the simplest means of control and simply turns heating power on when the PV is below setpoint and off when it is above setpoint. As a consequence, On/Off control leads to oscillation of the process variable. This oscillation can affect the quality of the final product but may be used on non-critical processes. A degree of hysteresis must be set in On/Off control if the operation of the switching device is to be reduced and relay chatter is to be avoided. For heating, hysteresis is applied below the setpoint as shown in section 7.2.11.

If cooling is used, cooling power is turned on when the PV is above setpoint and off when it is below. For cooling, hysteresis is applied above the setpoint as shown in section 7.2.11.

It is suitable for controlling switching devices such as relays, contactors, triacs or digital (logic) devices.

7.1.2 PID Control

PID, also referred to as 'Three Term Control', is an algorithm which continuously adjusts the output, according to a set of rules, to compensate for changes in the process variable. It provides more stable control but the parameters need to be set up to match the characteristics of the process under control.

The three terms are:

Proportional band Pb

Integral time t_i

Derivative time t_d

The output from the controller is the sum of the contributions from these three terms. The combined output is a function of the magnitude and duration of the error signal, and the rate of change of the process value.

In Operator Level 2 it is possible to turn off integral and derivative terms and control on proportional only (P), proportional plus integral (PI) or proportional plus derivative (PD).

PI control might be used, for example, when the sensor measuring an oven temperature is susceptible to noise or other electrical interference where derivative action could cause the heater power to fluctuate wildly.

PD control may be used, for example, on servo mechanisms.

In addition to the three terms described above, there are other parameters which determine how well the control loop performs. These include Cutback terms, Relative Cool Gain, Manual Reset and are described in detail in following sections.

7.1.3 Proportional Band 'Pb'

This section describes the effect of the proportional term only, that is with the integral and derivative terms turned off. The proportional band, or gain, delivers an output which is proportional to the size of the error signal. It is the range over which the output power is continuously adjustable in a linear fashion from 0 to 100% (for a heat only controller) or $\pm 100\%$ for a heat/cool controller. Below the proportional band the output is full on (100), above the proportional band the output is full off (0) as shown in the diagram below. The proportional band is measured in engineering units (e.g $^{\circ}\text{C}$).

The width of the proportional band determines the magnitude of the response to the error. If it too narrow (high gain) the system oscillates by being over responsive. If it is too wide (low gain) the control is sluggish. The ideal situation is when the proportional band is as narrow as possible without causing oscillation.

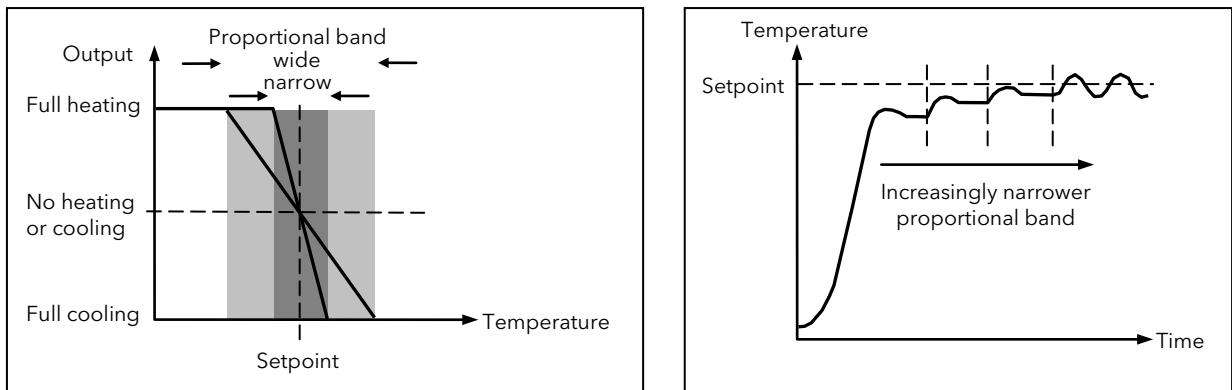

The diagram also shows the effect of narrowing proportional band to the point of oscillation. A very wide proportional band results in straight line control but with an appreciable initial error between setpoint and actual temperature. As the band is narrowed the temperature gets closer to setpoint. If the proportional band is very narrow the loop becomes unstable resulting in an oscillatory response.

The proportional band is set as a percentage of the controller range.

In practice this ideal situation, as shown in the diagram above is not fully achievable since there is always a loss of temperature. This can be compensated for in two ways, either by adding an integral term as described in section 7.1.4, below or by manually adjusting the power output as described in section 7.1.9.

7.1.4 Integral Term 'I'

In a proportional only controller, an error between setpoint and PV must exist for the controller to deliver power. Integral is used to achieve **zero** steady state control error.

The integral term slowly shifts the output level as a result of an error between setpoint and measured value. If the measured value is below setpoint the integral action gradually increases the output in an attempt to correct the error. If it is above setpoint integral action gradually decreases the output or increases the cooling power to correct the error.

The diagram below shows the result of introducing integral action.

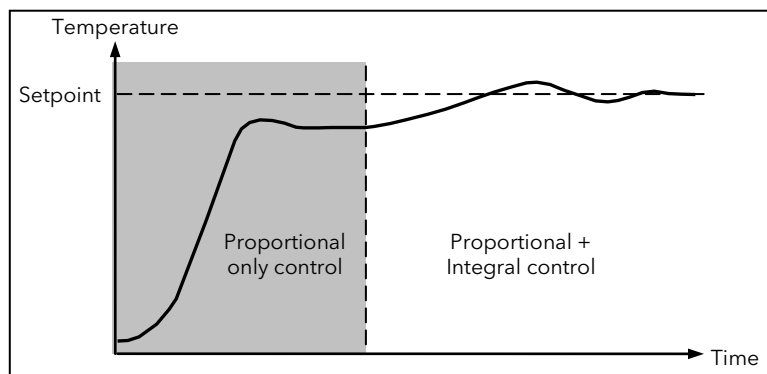

The units for the integral term are measured in time (1 to 9999 seconds). The longer the integral time constant, the more slowly the output is shifted and results in a sluggish response. Too small an integral time will cause the process to overshoot and even oscillate. The integral action may be disabled by setting its value to OFF.

7.1.5 Derivative Term ' t_d '

Derivative action, or rate, provides a sudden shift in output as a result of a rapid change in error. If the measured value falls quickly derivative provides a large change in output in an attempt to correct the perturbation before it goes too far. It is most beneficial in recovering from small perturbations.

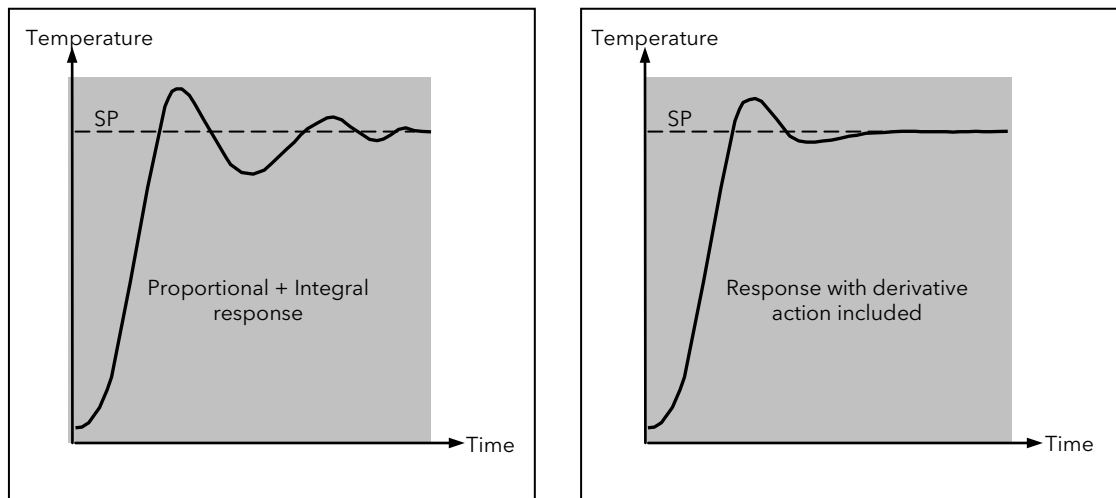

The derivative modifies the output to reduce the rate of change of error. It reacts to changes in the PV by changing the output to remove the transient. Increasing the derivative time will reduce the settling time of the loop after a transient change.

Derivative is often mistakenly associated with overshoot inhibition rather than transient response. In fact, derivative should not be used to curb overshoot on start up since this will inevitably degrade the steady state performance of the system. Overshoot inhibition is best left to the approach control parameters, High and Low Cutback, section 7.1.8.

Derivative is generally used to increase the stability of the loop, however, there are situations where derivative may be the cause of instability. For example, if the PV is noisy, then derivative can amplify that noise and cause excessive output changes, in these situations it is often better to disable the derivative and re-tune the loop.

If t_d is set to OFF no derivative action will be applied.

In the Piccolo range of controllers, derivative is calculated on change of PV. For applications such as furnace temperature control, it is common practice to use Derivative on PV to prevent thermal shock caused by a sudden change of output as a result of a change in setpoint.

7.1.6 Cooling Algorithm

The method of cooling may vary from application to application.

For example, an extruder barrel may be cooled by forced air (from a fan), or by circulating water or oil around a jacket. The cooling effect will be different depending on the method. The cooling algorithm may be set to linear where the controller output changes linearly with the PID demand signal, or it may be set to water, oil or fan where the output changes non-linearly against the PID demand. The algorithm provides optimum performance for these methods of cooling.

The type of cooling is set by 'P' code P8 - section 5.2.4.

7.1.7 Relative Secondary (Cool) Gain ' r_{2G} '

The proportional band parameter ' P_b ' adjusts the proportional band for the heating output. Relative cool gain adjusts the cooling proportional band relative to the heating proportional band. If the rate of heating and rate of cooling are widely different it may be necessary to manually adjust Relative Cool Gain to achieve the optimum settings for the cooling proportional band. A nominal setting of around 4 is often used.

Note: This parameter is set automatically when Auto-tune is used.

7.1.8 High and Low Cutback 'CBH' and 'CBL'

Cutback is a unique feature of the Eurotherm control algorithm which is used to avoid overshoot while allowing highly responsive control.

Cutback High and Cutback Low are values that modify the amount of overshoot, or undershoot, that occurs during large step changes in PV (for example, under start-up conditions). They are independent of the PID terms, which means that the PID terms can be set for optimal steady state response and the cutback parameters used to modify any overshoot which may be present.

Cutback involves moving the proportional band towards the cutback point nearest the measured value whenever the latter is outside the proportional band and the power is saturated (at 0 or 100% for a heat only controller). The proportional band moves downscale to the lower cutback point and waits for the measured value to enter it. It then 'escorts' the measured value with full PID control to the setpoint. In some cases it can cause a 'dip' in the measured value as it approaches setpoint, as shown in the diagram below, but generally decreases the time needed to bring the process into operation.

The action described above is reversed for falling temperature.

If cutback is set to Auto the cutback values are automatically configured to $3 \times PB$.

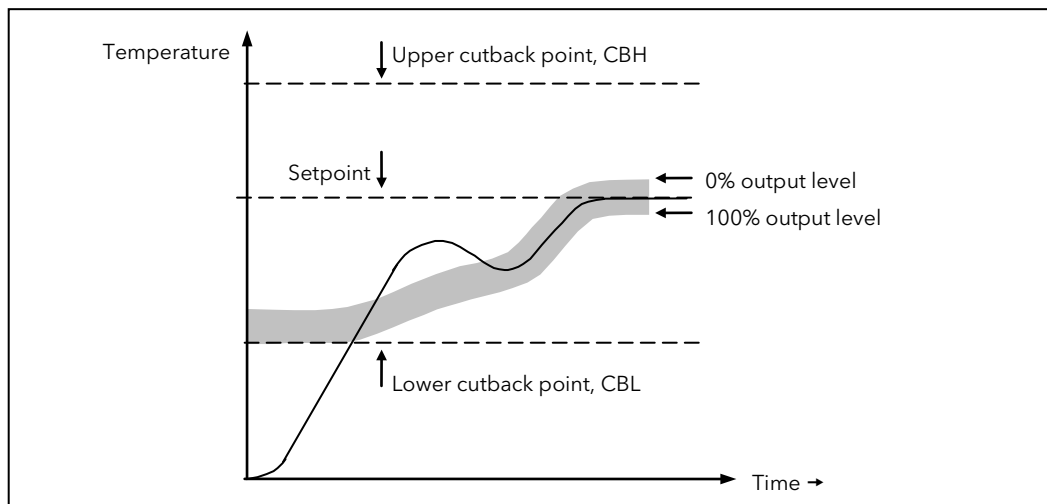

7.1.9 Manual Reset 'Mr'

In a full three-term controller (that is, a PID controller), the integral term automatically removes the steady state error from the setpoint. If the controller is set as a proportional only or PD controller, the integral term will be set to 'OFF'. Under these conditions the measured value will not settle precisely at setpoint due to the losses in temperature. The Manual Reset parameter (MR) represents the value of the power output that will be delivered when the error is zero. This value must be set manually in order to remove the steady state error.

7.1.10 Loop Break

A break in the control loop could be due to a number of factors such as a disconnection or open circuit of the control device (contactor, thyristor, etc). The loss of control could be catastrophic to the process. An early warning of the condition may be initiated by the controller as a **Loop Break Alarm** (**L.br** section 4.4.9.).

The loop is considered to be broken by the controller if the PV does not respond to the output in a given time.

Since the time of response will vary from process to process a **Loop Break Time** can be set manually or overridden by 'P' code parameter **P34**. This parameter can also be set automatically by the Autotune algorithm.

It is assumed that, so long as the requested output power is within the output power limits, set by **oP.Lo** and **oP.Hi** in Level 2, the loop is operating in linear control and is therefore not in a loop break condition.

However, if the output is in saturation and the PV has not moved by $>0.5 \cdot P_b$ in the loop break time and in the right direction, a loop break condition is considered to have occurred.

If an Auto Tune is performed the loop break time is automatically set to $T_i \cdot 2$ for a PI or PID loop or to $12 \cdot T_d$ for a PD loop. For an On/Off controller loop break detection is also based on loop break time as $0.1 \cdot \text{SPAN}$ where $\text{SPAN} = \text{Range High} - \text{Range Low}$. Therefore, if the output is in saturation and the PV has not moved by $0.1 \cdot \text{SPAN}$ in the loop break time a loop break will occur.

If the loop break time is OFF the loop break time is not set.

7.2 Tuning

In tuning, the PID parameters of the controller are matched to the process being controlled in order to obtain good control. Good control means:

- Stable, 'straight-line' control of the PV at setpoint without fluctuation
- No overshoot, or undershoot, of the PV setpoint
- Quick response to deviations from the setpoint caused by external disturbances, thereby rapidly restoring the PV to the setpoint value.

Tuning involves setting the following parameters in a PID controller:-

Proportional Band ' Pb ', Integral Time ' ti ', Derivative Time ' td ', Cutback High ' $CbHi$ ', Cutback Low ' $CbLo$ ', and Relative Cool Gain ' $r2G$ ' (applicable to heat/cool systems only). Loop Break Time ' Lbt ' is also set by the self tune algorithm provided that the integral time ' ti ' is not set to **OFF**.

The controller is shipped with these parameters set to default values (section 4.7.2 'Level 2 Parameters'). In many cases the default values will give adequate stable straight line control, however, the response of the loop may not be optimised. Because the process characteristics are fixed by the design of the process it is necessary to adjust the control parameters in the controller to achieve best match. To determine the optimum values for any particular loop or process it is necessary to carry out a procedure called loop tuning. If significant changes are later made to the process which affect the way in which it responds it may be necessary to retune the loop.

Users have the choice of tuning the loop automatically or manually. Both procedures require the loop to oscillate and both are described in the following sections.

7.2.1 Loop Response

If we ignore the situation of loop oscillation, there are three categories of loop performance:

Under Damped - In this situation the terms are set to prevent oscillation but generally lead to an overshoot of the Process Value followed by decaying oscillation to finally settle at the Setpoint. This type of response can give a minimum time to Setpoint but overshoot may cause problems in certain situations and the loop may be sensitive to sudden changes in Process Value. This will result in further decaying oscillations before settling once again.

Critically Damped - This represents an ideal situation where overshoot to small step changes does not occur and the process responds to changes in a controlled, non-oscillatory manner.

Over Damped - In this situation the loop responds in a controlled but sluggish manner which will result in a loop performance which is not ideal and unnecessarily slow.

The balancing of the P, I and D terms depends totally upon the nature of the process to be controlled.

In a plastics extruder, for example, a barrel zone will have a different response to a die, casting roll, drive loop, thickness control loop or pressure loop. In order to achieve the best performance from an extrusion line all loop tuning parameters must be set to their optimum values.

7.2.2 Initial Settings

In addition to the tuning parameters listed in section 7.2.2 above, there are a number of other parameters which can have an effect on the way in which the loop responds. Ensure that these are set before either manual or automatic tuning is initiated. Parameters include, but are not limited to:-

Setpoint. Set this as closely as practicable to the actual setpoint in normal operation.

Load Conditions. Set the load conditions as closely as possible to those which will be met in practice. For example, in a furnace or oven application a representative load should be included in the oven, an extruder should be running, etc.

Heat/Cool Limits. The minimum and maximum power delivered to the process may be limited by the parameters 'Output Low' ($OPLO$) and 'Output High' ($OPHi$) both of which are found in the Level 2 operator list. For a heat only controller the default values are 0 and 100%. For a heat/cool controller the defaults are -100 and 100%. Although it is expected that most processes will be designed to work between these limits there may be instances where it is desirable to limit the power delivered to the process. For example, if driving a 220V heater from a 240V source the heat limit may be set 80% to ensure that the heater does not dissipate more than its maximum power.

☺ The measured value *must* oscillate to some degree for the tuner to be able to calculate values. The limits must be set to allow oscillation about the setpoint.

☺ **Channel 2 Deadband.** In controllers fitted with a second (cool) channel a parameter $dbnd$ is also available in the Level 2 operator list, which sets the distance between the heat and cool proportional bands. The default value is 0% which means that heating will turn off at the same time as cooling turns on. The deadband may be set to ensure that there is no possibility of the heat and cool channels being on together, particularly when cycling output stages are installed.

Minimum Pulse Time. If either or both of the output channels is fitted with a relay, triac or logic output, the parameter ' $-PLS$ ' is available in the Level 2 operator list, section 4.7.2. This is the cycling time for a time proportioning output and should be set correctly before tuning is started.

Input Filter Time Constant. The parameter ' $FILT$ ' should be set before tuning the loop. It is found in the Level 2 operator list.

Other Considerations

- If a process includes adjacent interactive zones, each zone should be tuned independently.
- It is always better to start a tune when the PV and setpoint are far apart. This allows start up conditions to be measured and cutback values to be calculated more accurately.
- In a ramp/dwell controller tuning should only be attempted during dwell period and not during the ramp stage. If a ramp/dwell controller is tuned automatically put the controller into Hold during the dwell period whilst autotune is active. It may be worth noting that tuning, carried out in dwell periods which are at different extremes of temperature may give different results owing to non-linearity of heating (or cooling).

7.2.3 Automatic Tuning

Auto Tune automatically sets the following parameters:-

Proportional Band ' P_b '	
Integral Time ' t_i '	If ' t_i ' and/or ' t_d ' is set to OFF , because you wish to use PI, PD or P only control, these terms will remain off after an autotune.
Derivative Time ' t_d '	
Cutback High ' C_{bH} '	If ' C_{bH} ' and/or ' C_{bLo} ' is set to ' Auto ' these terms will remain at Auto after an autotune, i.e. $3 \cdot P_b$. For autotune to set the cutback values, ' C_{bH} ' and ' C_{bLo} ' must be set to a value (other than Auto) before autotune is started. Autotune will never return cutback values which are less than $1.6 \cdot P_b$.
Cutback Low ' C_{bLo} '	
Relative Cool Gain ' r_{2G} '	R2G is only calculated if the controller is configured as heat/cool. Following an autotune, ' r_{2G} ' is always limited to between 0.1 and 10. If the calculated value is outside this limit a 'Tune Fail' alarm is given.
Loop Break Time ' L_{bE} '	Following an autotune, ' L_{bE} ' is set to $2 \cdot t_i$ (assuming the integral time is not set to OFF). If ' t_i ' is set to OFF then ' L_{bE} ' is set to $12 \cdot t_d$.

Auto Tune uses the 'one-shot' tuner which works by switching the output on and off to induce an oscillation in the process value. From the amplitude and period of the oscillation, it calculates the tuning parameter values. The autotune sequence for different conditions is described in sections 7.2.5 to 7.2.7.

7.2.4 To Start Auto Tune

In operator level 2, set the AUTO-TUNE ENABLE parameter, ' A_{tUn} ' to '**on**'.

Press the Page and Scroll buttons together to return to the Home display. The display will flash ' t_{UnE} ' to indicate that tuning is in progress.

A One-shot Tune can be performed at any time, but normally it is performed only once during the initial commissioning of the process. However, if the process under control subsequently becomes unstable (because its characteristics have changed), it may be necessary to tune again for the new conditions.

The Auto Tune algorithm reacts in different ways depending on the initial conditions of the plant. The explanations given in this section are for the following conditions:-

1. Initial PV is below the setpoint and, therefore, approaches the setpoint from below for a heat/cool control loop
2. Initial PV is below the setpoint and, therefore, approaches the setpoint from below for a heat only control loop
3. Initial PV is at the same value as the setpoint. That is, within 0.3% of the range of the controller. Range is defined as 'High Scale Range Value' to 'Low Scale Range Value' for process inputs or the range defined in section 5.2.2 for temperature inputs.

- ☺ If the PV is just outside the range stated above the autotune will attempt a tune from above or below SP.
- ☺ If the controller is autotuning and sensor break occurs, the autotune will abort. Autotune must be re-started when the sensor break condition is no longer present.
- ☺ If an Autotune cannot be performed an error message, E_{tUn} , will be flashed in the display (this may take around 2 hours). At the same time the A_{tUn} parameter will show **FAIL**. It will be necessary to turn Autotune OFF and start again. Autotune will not work if the loop does not respond to changes or, of course, if it is left open.

7.2.5 Auto Tune from Below SP - Heat/Cool

The point at which Automatic tuning is performed (Tune Control Point) is designed to operate just below the setpoint at which the process is normally expected to operate (Target Setpoint). This is to ensure that the process is not significantly overheated or overcooled. The Tune Control Point is calculated as follows:-

$$\text{Tune Control Point} = \text{Initial PV} + 0.75(\text{Target Setpoint} - \text{Initial PV}).$$

The Initial PV is the PV measured at 'B' (after a 1 minute settling period)

Examples: If Target Setpoint = 500°C and Initial PV = 20°C, then the Tune Control Point will be 380°C.

If Target Setpoint = 500°C and Initial PV = 400°C, then the Tune Control Point will be 475°C.

This is because the overshoot is likely to be less as the process temperature is already getting close to the target setpoint.

The sequence of operation for a tune from below setpoint for a heat/cool control loop is described below:-

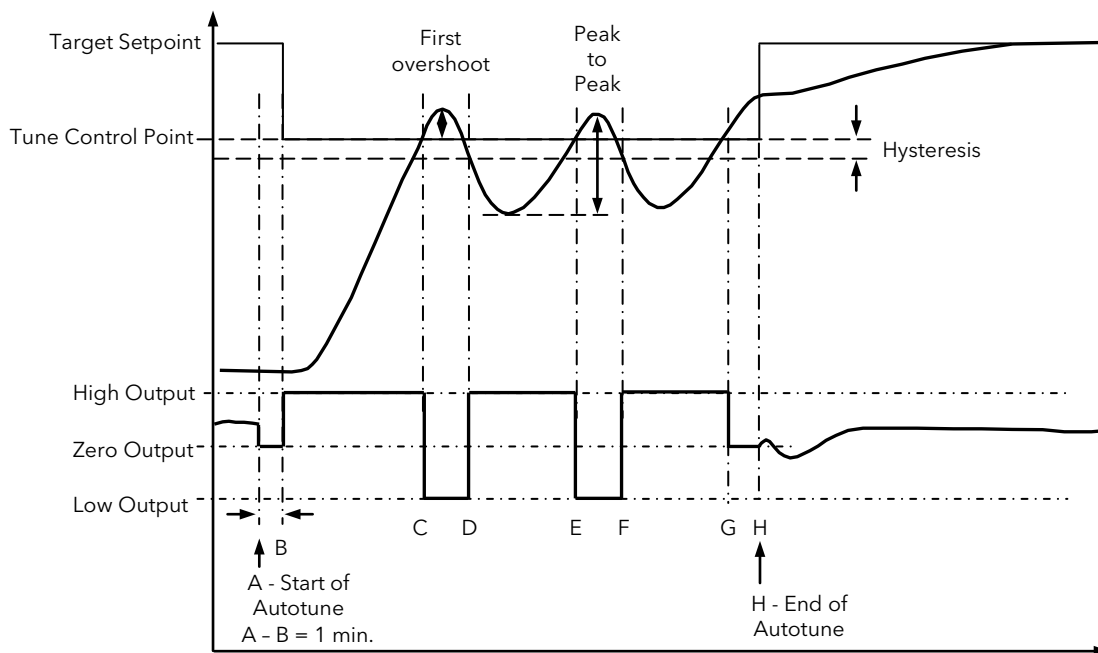

Period	Action
A	Start of Autotune
A to B	Both heating and cooling power remains off for a period of 1 minute to allow the algorithm to establish steady state conditions.
B to D	First heat/cool cycle to establish first overshoot. ' <i>cbLo</i> ' is calculated on the basis of the size of this overshoot (assuming it is not set to Auto in the initial conditions).
B to F	Two cycles of oscillation are produced from which the peak to peak response and the true period of oscillation are measured. PID terms are calculated
F to G	An extra heat stage is provided and all heating and cooling power is turned off at G allowing the plant to respond naturally. Measurements made during this period allow the relative cool gain ' <i>r2G</i> ' to be calculated. ' <i>cbHi</i> ' is calculated from <i>cbLo</i> * <i>r2G</i> .
H	Autotune is turned off at and the process is allowed to control at the target setpoint using the new control terms.

Autotune can also occur when the initial PV is above SP. The sequence is the same as tuning from below setpoint except that the sequence begins with full cooling applied at 'B' after the first one minute settling time.

7.2.6 Auto Tune From Below SP - Heat Only

The sequence of operation for a heat only loop is the same as that previously described for a heat/cool loop except that the sequence ends at 'F' since there is no need to calculate 'r_{CU}'.

At 'F' autotune is turned off and the process is allowed to control using the new control terms.

Relative cool gain, 'r_{CU}' is set to 1.0 for heat only processes.

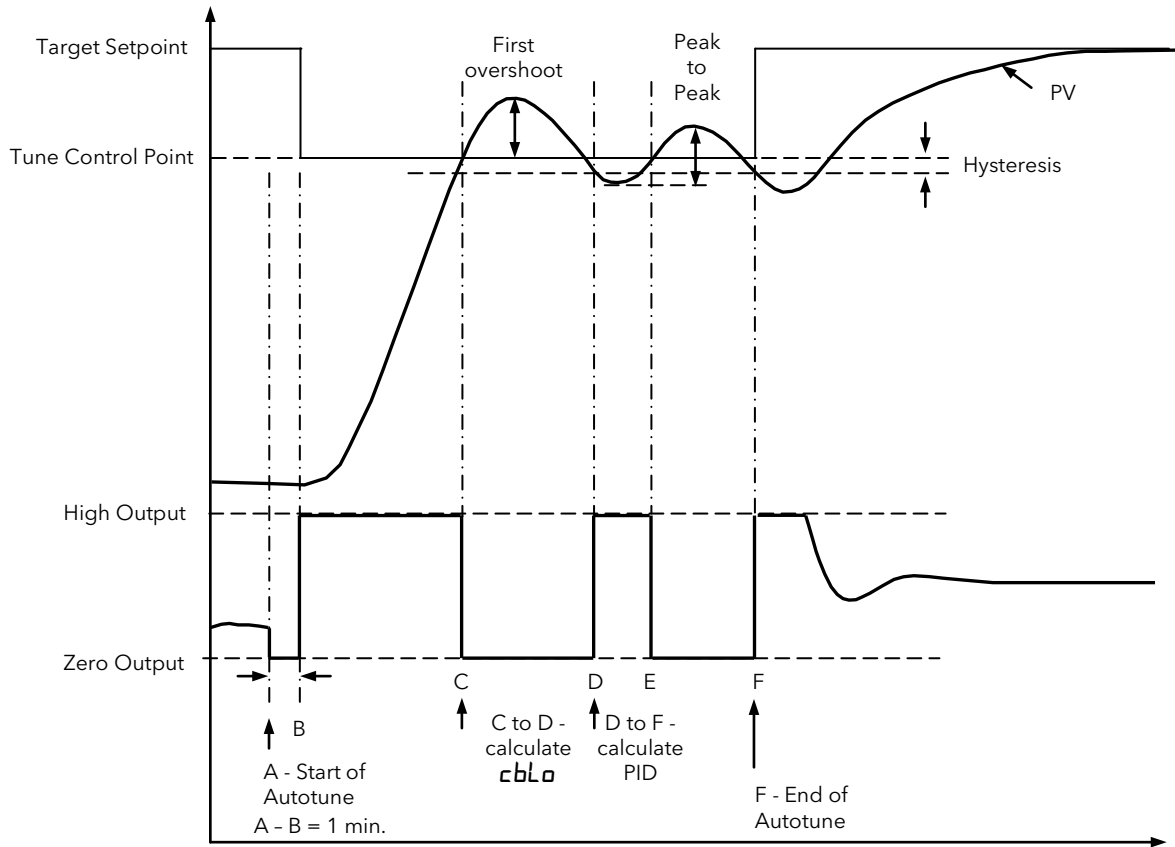

For a tune from below setpoint 'cbLo' is calculated on the basis of the size of the overshoot (assuming it was not set to Auto in the initial conditions). cbHi is then set to the same value as cbLo.

Note:- As with the heat/cool case, Autotune can also occur when the initial PV is above SP. The sequence is the same as tuning from below setpoint except that the sequence starts with natural cooling applied at 'B' after the first one minute settling time.

In this case cbHi is calculated - cbLo is then set to the same value as cbHi .

7.2.7 Auto Tune at Setpoint - Heat/Cool

It is sometimes necessary to tune at the actual setpoint being used. This is allowable in Piccolo range controllers and the sequence of operation is described below.

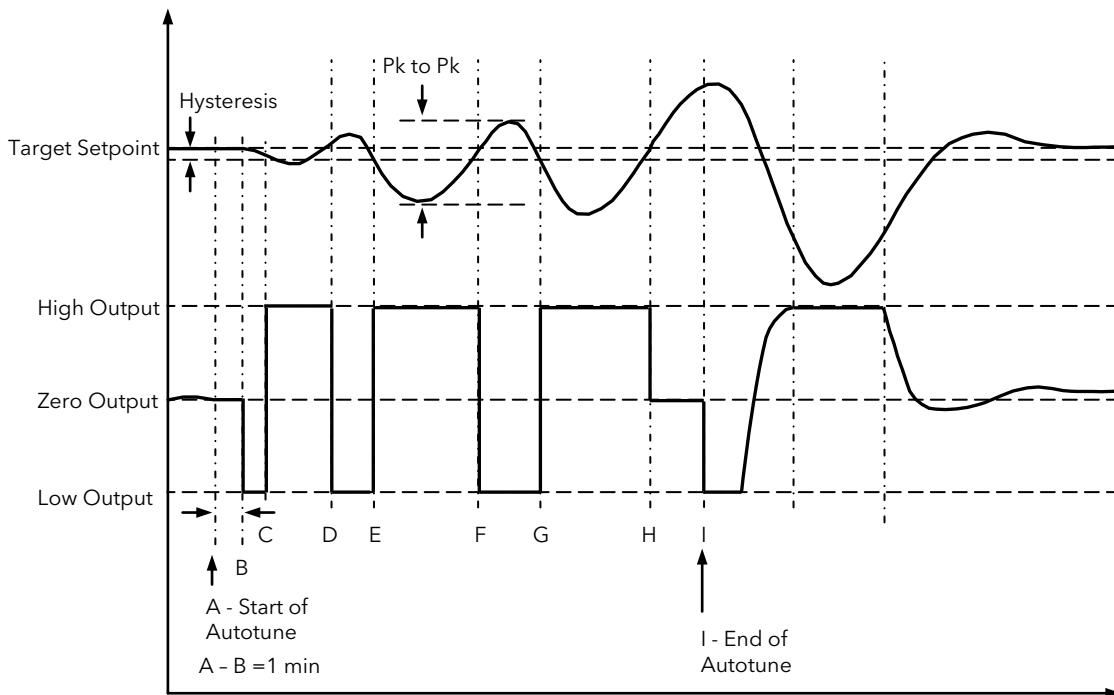

Period	Action
A	Start of Auto Tune. A test is done at the start of autotune to establish the conditions for a tune at setpoint. The conditions are that the SP must remain within 0.3% of the range of the controller. Range is defined as 'High Scale Range Value' - 'Low Scale Range Value' for process inputs or the range defined in section 1.5.2 for temperature inputs.
A to B	The output is frozen at the current value for one minute and the conditions are continuously monitored during this period. If the conditions are met during this period autotune at setpoint is initiated at B. If at any time during this period the PV drifts outside the condition limits a tune at setpoint is abandoned. Tuning is then resumed as a tune from above or below setpoint depending on which way the PV has drifted. Since the loop is already at setpoint there is no need to calculate a Tune Control Setpoint - the loop is forced to oscillate around the Target Setpoint
C to G	Initiate oscillation - the process is forced to oscillate by switching the output between the output limits. From this the period of oscillation and the peak to peak response is measured. PID terms are calculated
G to H	An extra heat stage is provided and all heating and cooling power is turned off at H allowing the plant to respond naturally. Measurements made during this period allow the relative cool gain ' r_{20} ' to be calculated.
I	Auto Tune is turned off and the process is allowed to control at the target setpoint using the new control terms.

For a tune at setpoint Auto Tune does not calculate cutback since there was no initial start-up response to the application of heating or cooling. The exception is that the cutback values will never be returned less than $1.6 \cdot P_b$.

7.2.8 Manual Tuning

If for any reason automatic tuning gives unsatisfactory results, or if you prefer, you can tune the controller manually. There are a number of standard methods for manual tuning. The one described here is the Ziegler-Nichols method.

Adjust the setpoint to its normal running conditions (it is assumed this will be above the PV so that heat only is applied)

Set the Integral Time ' t_i ' and the Derivative Time ' t_d ' to 'OFF'.

Set High Cutback ' cbH ' and Low Cutback ' cbL ' to 'Auto'.

Ignore the fact that the PV may not settle precisely at the setpoint.

If the PV is stable, reduce the proportional band so that the PV just starts to oscillate. Allow enough time between each adjustment for the loop to stabilise. Make a note of the proportional band value ' P_b ' and the period of oscillation ' T '. If PV is already oscillating measure the period of oscillation ' T ', then increase the proportional band until it just stops oscillating. Make a note of the value of the proportional band at this point.

Set the proportional band, integral time and derivative time parameter values according to the calculations given in the table below:-

Type of control	Proportional band (P_b)	Integral time (t_i) seconds	Derivative time (t_d) seconds
Proportional only	$2x P_b$	OFF	OFF
P + I control	$2.2x P_b$	$0.8xT$	OFF
P + I + D control	$1.7x P_b$	$0.5xT$	$0.12xT$

7.2.9 Manually Setting Relative Cool Gain

If the controller is fitted with a cool channel this should be enabled before the PID values calculated from the table above are entered.

Observe the oscillation waveform and adjust r_{CG} until a symmetrical waveform is observed.

Then enter the values from the table above.

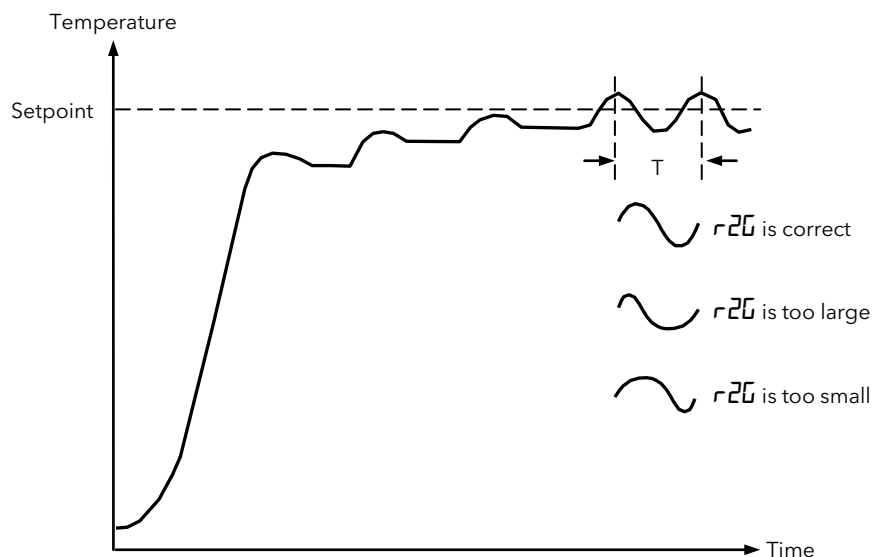

7.2.10 Manually Setting the Cutback Values

Enter the PID terms calculated from the table in the previous section before setting cutback values.

The above procedure sets up the parameters for optimum steady state control. If unacceptable levels of overshoot or undershoot occur during start-up, or for large step changes in PV, then manually set the cutback parameters.

Proceed as follows:

Initially set the cutback values to one proportional bandwidth.

If overshoot is observed following the correct settings of the PID terms increase the value of ' $cbLo$ ' by the value of the overshoot in display units. If undershoot is observed increase the value of the parameter ' $cbHi$ ' by the value of the undershoot in display units.

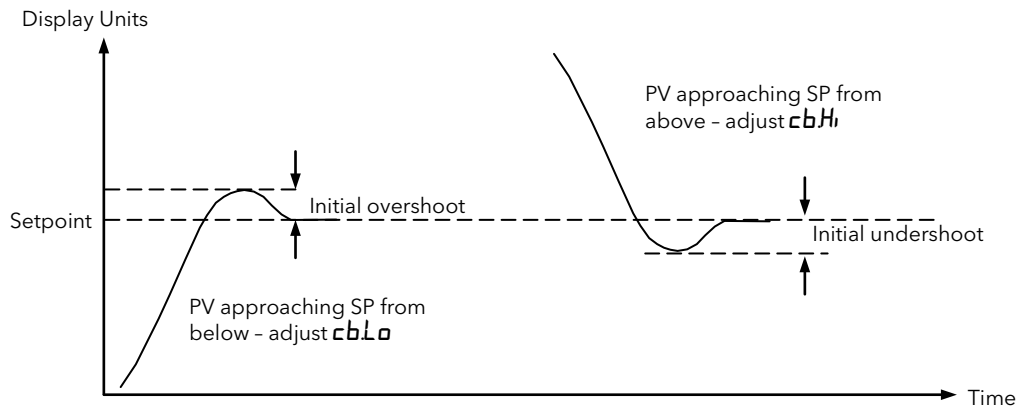

7.2.11 Effect of Control Action, Hysteresis and Deadband

For temperature control, the action is that the heater power decreases as the PV increases. For an on/off controller output 1 (usually heat) will be on (100%) when PV is below the setpoint and output 2 (usually cool) will be on when PV is above the setpoint

Hysteresis applies to on/off control only. It defines the difference in temperature between the output switching off and switching back on again. The examples below show the effect in a heat/cool controller.

Deadband can operate on both on/off control or PID control where it has the effect of widening the period when no heating or cooling is applied. However, in PID control its effect is modified by both the integral and derivative terms. Deadband might be used in PID control, for example, where actuators take time to complete their cycle thus ensuring that heating and cooling are not being applied at the same time. Deadband is likely to be used, therefore, in on/off control only. The second example below adds a deadband of 20 to the above example.

Deadband OFF

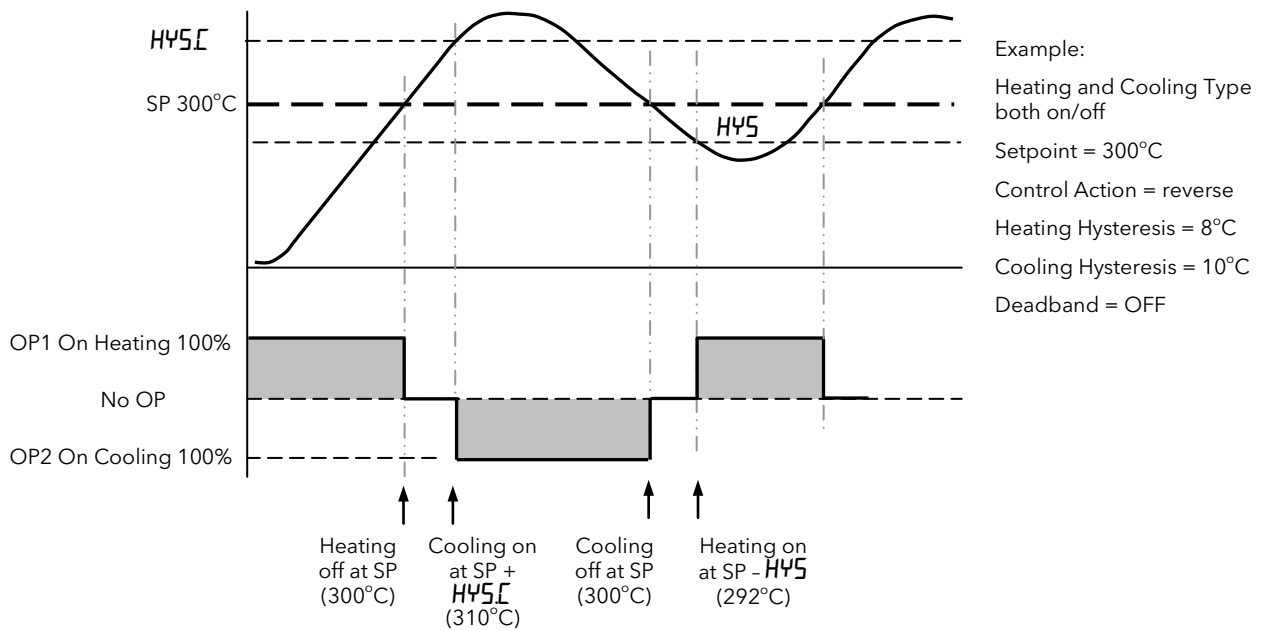

Deadband ON

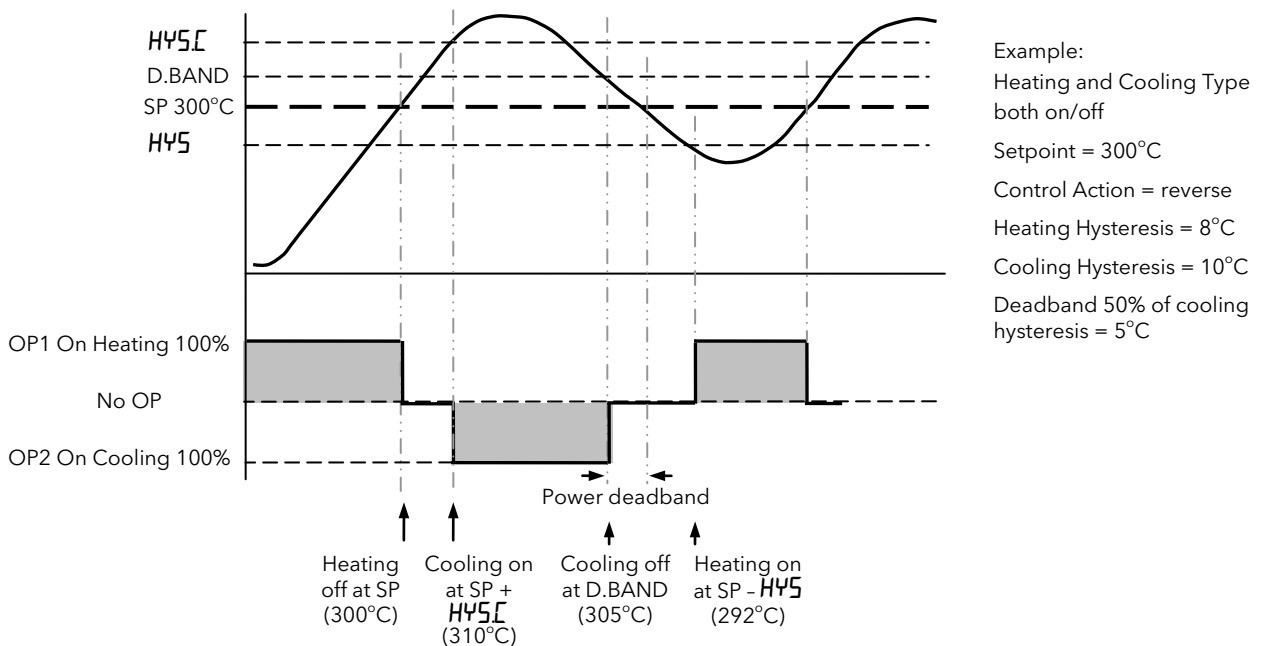

8. Digital Communications

Digital Communications (or 'comms' for short) allows the controller to communicate with a PC or a networked computer system.

This product conforms to MODBUS RTU protocol a full description of which can be found on www.modbus.org.

Two ports are available:-

1. An EIA232 (formerly RS232) configuration port - intended to communicate with a system to download the instrument parameters and to perform manufacturing tests and calibration
2. an optional EIA485 (formally RS485) port on terminals HD, HE and HF - intended for field communications using, for example, a PC running a SCADA package.

The two interfaces cannot operate at the same time.

For a further description of digital communications protocols (Modbus RTU) refer to the Communications Manual, part number HA026230, available on www.eurotherm.co.uk.

Each parameter has its own unique Modbus address. A list of these is given at the end of this section.

8.1 Configuration Port

This is an EIA232 port intended only to be used for configuring the instrument using a configuration clip and iTools, see section 10.2.1.

Do not use this port for any other purpose.

8.2 EIA485 Field Communications Port

To use EIA485, buffer the EIA232 port of the PC with a suitable EIA232/EIA485 converter. The Eurotherm Controls KD485 Communications Adapter unit is recommended for this purpose. The use of a EIA485 board built into the computer is not recommended since this board may not be isolated, which may cause noise problems, and the RX terminals may not be biased correctly for this application.

To construct a cable for EIA485 operation use a screened cable with one (EIA485) twisted pair plus a separate core for common. Although common or screen connections are not necessary, their use will significantly improve noise immunity.

The terminals used for EIA485 digital communications are listed in the table below.

Standard Cable Colour	PC Function *	Instrument Terminal	Instrument Function
White	Receive, RX+	HF (B) or (B+)	Transmit, TX
Red	Transmit, TX+	HE (A) or (A+)	Receive, RX
Green	Common	HD	Common
Screen	Ground		

* These are the functions normally assigned to socket pins. Please refer to your PC manual.

See section 2.14 for wiring diagrams.



Warning. The Piccolo Range has a limited number of writes to EEPROM. Please ensure that parameters which do not require updating on a regular basis (for example, setpoints, alarm trip levels, hysteresis, etc) are only written to when a change in the parameter value occurs. Failure to do this could result in permanent damage to the internal EEPROM.

See also the section 8.4.

8.3 Master/Slave (Broadcast) Communications

A simple but very powerful Master Communications Retransmission facility is provided that allows the construction of simple multi-zone temperature control systems. This uses the Modbus broadcast facility to retransmit values to other instruments ('slaves') so that, for example, they may be sent a programmed setpoint profile from the 'master' programmer device. It is also possible to use the facility to transmit output power demand to other devices, for example a phase angle thyristor power controller.

The broadcast sends 'scaled integer' values, which are integer representations of a floating point number with the decimal places removed. For example, a value of 12.3 would be sent as 123. It is important, therefore, that the receiving and transmitting units are set to use the same decimal resolution. Modbus Function 6 is used for the broadcast, and so the receiving device must support this function. The Modbus register address that the values are sent to is completely configurable between 1 and 9999.

Modbus Broadcasts do not permit feedback from slaves, but it is possible to use relays on the slave devices to close a contact closure digital input on the master. This can be used with a deviation event alarm and run/hold logic input, for example, to detect when the temperature measurements in the slave have not reached the programmed setpoint and to put the program in hold.

The retransmitted parameter can be selected from Setpoint, Process Variable, Output Demand or Error. The controller will cease broadcast when it receives a valid request from a Modbus master - this allows iTools to be connected for commissioning purposes.



Warning

In common with most instruments in its class, the Piccolo Range uses a non-volatile memory with a limited number of specified writes. Non-volatile memory is used to hold information that must be retained over a power cycle, and typically, this includes setpoint and status information, including alarm latch status.

Please ensure that parameters which do not require updating on a regular basis (for example, setpoints, alarm trip levels, hysteresis, etc) are only written to when a change in the parameter value occurs. Failure to do this could result in permanent damage to the internal EEPROM.

When using the Piccolo Range, use the 'AltSP' variable at Modbus address 26 if you need to write to a temperature setpoint. This has no write restrictions and may also have a local trim value applied using the 'SPTrim' parameter at Modbus address 27.

A further explanation is given in section 8.4 'EEPROM Write Cycles'.

Important Note: The Alternate Setpoint 'AltSP' and Setpoint Trim 'SPTrim' parameters are not available through the user interface of the controller. They are sourced externally via Modbus communications and may be found using iTools as follows. It may be necessary to refer to section 10 for information on the use of iTools.

In OPERATING list select STATUS tab

Set AltSPSelect (address 276) to YES

In OPERATING list select VARIABLES tab

It is now possible to write to AltSP (address 26)

If this is done manually the setpoint will be written for a few seconds. To update this on a continuous basis it will be necessary to send the value repeatedly.

To set a constant offset to the Alternate Setpoint:

In OPERATING list select SETTINGS tab

Enter an offset value to 'SPTrim' (address 27). A positive value adds to AltSP, a negative value subtracts from AltSP.

Limits may also be applied to AltSP using the parameters AltSPLo (address 279) and AltSPHi (address 278) also only available over comms in the SETTINGS tab in iTools.

8.4 EEPROM Write Cycles

By specification the EEPROM memory used in this range allows 100,000 changes (although typically much more). If this write cycle count is exceeded the instrument will display an **EEPROM** message. It will become unusable and must be returned for repair.

In order to provide the user with advanced warning of a potential problem a warning alarm is generated if a parameter write cycle approaches a threshold (section 4.4.11).

The following sections give examples of parameters which could cause this limit to be exceeded over a period of time.

Setpoint Ramping

Continuous changing of setpoint via digital communications – for example a ramping value – is the most common cause of EEPROM wear.

One solution, given in the section above ‘Master/Slave (Broadcast) Communications’, is to select “Remote Setpoint” in the Variables list in iTools, and write values to Modbus address 26 (hex 001A).

An approximately 5 second timeout is applied to writes to Modbus address 26 so that if values are not received within this period, a remote fail alarm will be generated (section 4.4.12) – this can also trigger a problem with EEPROM wear – see ‘Alarms and other Status Changes’ below.

To avoid this problem write to the Target Setpoint at address 02, but note that any value written to this parameter will not be retained over a power fail. In order to access the Target setpoint it is also necessary to enable the remote Setpoint (iTools STATUS list address 276).

It is **critically important** to select the remote setpoint if updating the setpoint on a regular basis otherwise the setpoint change will be saved to non-volatile memory and EEPROM wear will result.

Alarms and other Status Changes

Alarm status is saved in non-volatile memory and this includes status alarms such as sensor break, loop break, remote fail and individual alarm and alarm latching status. Every transition into and out of an alarm condition triggers an EEPROM write. Thus, if there is any fast toggling of an alarm status, EEPROM wear can result within the expected lifetime of an instrument.

An example of this is where event alarms are used to provide an on/off control loop. Piccolo instruments should, on no account, be used in this manner since the toggling of the output will rapidly use up the 100,000 writes. The On/Off control in the PID algorithm should be used instead. However, any situation where alarm states can change rapidly should be avoided.

Mode and Timer Changes

Rapid changes to instrument mode (Auto/Manual) or the Timer operation can cause EEPROM wear because the status (run/hold/reset) or the segment number are stored in EEPROM on each transition.

In normal use where segments or timer sequences are relatively long, it is unlikely that problems will be seen. However, in some applications where a sequence is run frequently, EEPROM wear will occur. An example of this is where a digital input is used in an application to trigger a timer sequence and the operation is performed as fast as possible by an operator, EEPROM wear occurred after a few years.

Digital Inputs

Care should be taken with any rapid cycling digital inputs. Typically a digital input triggering timer or mode changes (as above) should be carefully considered so that they do not switch more than 100,000 times during the expected lifetime of the instrument.

8.5 Broadcast Master Communications Connections

The Piccolo Range broadcast master can be connected to up to 31 slaves if no segment repeaters are used. If repeaters are used to provide additional segments, 32 slaves are permitted in each new segment. The master is configured by setting **P64** to *SP*, *Pu*, *oP* or *Err* (section 5.2.17).

Once the function has been enabled, the instrument will send this value out over the communications link every control cycle (250ms).

Notes:-

1. The parameter being broadcast must be set to the same decimal point resolution in both master and slave instruments.
2. If iTools, or any other Modbus master, is connected to the port on which the broadcast master is enabled, then the broadcast is temporarily inhibited. It will restart approximately 30 seconds after iTools is removed. This is to allow reconfiguration of the instrument using iTools even when broadcast master communications is operating.

8.5.1 Wiring

Connect A (+) in the master to A (+) of the slave

Connect B (-) in the master to B (-) of the slave

This is shown diagrammatically below. All instruments are shown as Piccolo Range but can be any instrument from the Eurotherm range.

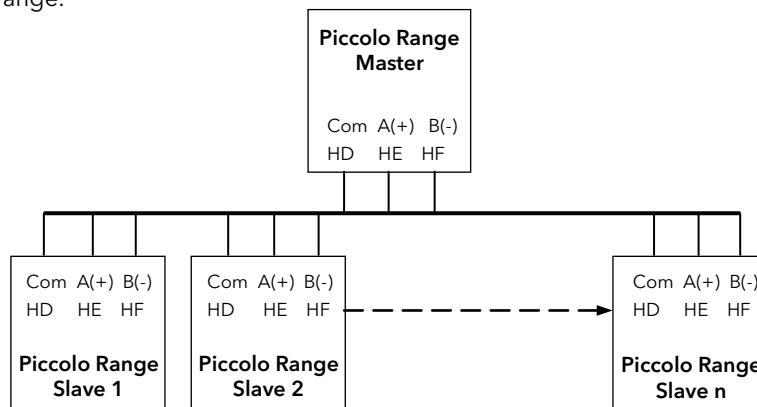

8.6 DATA ENCODING

☺ Note that the Eurotherm iTools OPC server provides a straightforward means of accessing any variable in the controller in the correct data format without the need to consider data representation. However if you wish to write your own communications interface software, you will need to take the format used by the Piccolo Range comms software into account.

Modbus data is normally encoded into a 16 bit signed integer representation.

Integer format data, including any value without a decimal point or represented by a textual value (for example 'off', or 'on'), is sent as a simple integer value.

For floating point data, the value is represented as a 'scaled integer', in which the value is sent as an integer which gives the result of the value multiplied by 10 to the power of the decimal resolution for that value. This is easiest to understand by reference to examples:

FP Value	Integer Representation
9.	9
-1.0	10
123.5	1235
9.99	999

It may be necessary for the Modbus master to insert or remove a decimal point when using these values.

It is possible to read floating point data in a native 32 bit IEEE format. This is described in the Digital Communications Manual Part Number HA026230 which can be downloaded from www.eurotherm.co.uk.

For **time** data, for example, the length of a dwell, the integer representation depends on the resolution. For 'hours' resolution, the value returned is the number of minutes the value represents, so for example a value of 2:03 (2 hours and three minutes) would be returned as an integer value of 123. For 'minutes' resolution, the value used is the number of seconds the value represents, so that 12:09 (12 minutes and 9 seconds) would be returned as 729.

It is possible to read time data in a native 32 bit integer format, in which case it returns the number of milliseconds the variable represents regardless of the resolution. This is described in the Digital Communications Manual Part Number HA026230.

8.7 Parameter Modbus Addresses

This is a complete list of parameters available in the Piccolo range, some of which are only available through comms. These addresses are also shown in iTools.

Parameter Mnemonic	Parameter Name		Modbus Address Decimal
PVInValue	PV (Temperature) Input Value		1
TargetSP	Target Setpoint.	<i>NB - do not write continuously changing values to this variable. The memory technology used in this product has a limited (100,000) number of write cycles. If ramped setpoints are required, consider using the internal ramp rate function or the Alternative Setpoint available over comms (Modbus address 26)in preference.</i>	2
OP	Manual Output Value		3
WorkingOP	Working Output		4
WorkingSP	Working Setpoint (Read Only)		5
Pb	Proportional Band		6
Ti	Integral Time	(0 = No Integral Action)	8
Td	Derivative Time	(0 = No Derivative Action)	9
AL1	Alarm 1 Threshold		13
AL2	Alarm 2 Threshold		14
SP.SL	Active Setpoint Select	(0 = Setpoint 1; 1 = Setpoint 2)	15
d.bnd	Channel 2 Deadband		16
cb.Lo	Cutback Low		17
cb.Hi	Cutback High		18
r2G	Relative Cool Gain		19
t.st	Timer Status	(0 = Reset; 1 = Run; 2 = Hold; 3 = End)	23
SP1	Setpoint 1	<i>NB - do not write continuously changing values to this variable. The memory technology used in this product has a limited (100,000) number of write cycles. If ramped setpoints are required, consider using the internal ramp rate function or the Alternative Setpoint (Modbus address 26)in preference.</i>	24
SP2	Setpoint 2		25
AltSP	Alternative setpoint (comms only parameter) may be used as a setpoint or to ramp the setpoint providing a value has been received within a window of about 5 seconds. This may be enabled using the AltSPSelect (address 276). If no value is received then the controller falls back to the currently selected setpoint (SP 1 or SP 2). The Alternative Setpoint may have a local trim (SP Trim, address 27) added to it to compensate for variations in temperature in a particular zone. This parameter is not saved when the instrument is switched off. It may be written to continuously over communications without risk of damage to the instrument non-volatile memory.		26
SPTrim	Local Trim - added to the remote setpoint to compensate for local temperature variations in a control zone.		27
Mr	Manual Reset		28
oP.Hi	Output High Limit		30
oP.Lo	Output Low Limit		31
SP.rr	Setpoint Rate Limit Value	(0 = no rate limit)	35
Error	Calculated Error (PV-SP)		39
AL1.H	Alarm 1 Hysteresis		47
AL2.H	Alarm 2 Hysteresis		68
AL3.H	Alarm 3 Hysteresis		69
InstStatus	Instrument Status. This is a bitmap: B0 - Alarm 1 Status B1 - Alarm 2 Status B2 - Alarm 3 Status B4 - Auto/Manual Status B5 - Sensor Break Status B6 - Loop Break Status B7 - CT Low load current alarm status B8 - CT High leakage current alarm status B9 - Timer End B10 - PV Over-range (by > 5% of span) B11 - CT Overcurrent alarm status		75

Parameter Mnemonic	Parameter Name	Modbus Address Decimal
	B12 - New Alarm Status B13 - Timer/Ramp Running B14 - Remote (comms) SP Fail B15 - Auto-tune Status In each case, a setting of 1 signifies 'Active', 0 signifies 'Inactive'.	
InverseStatus	Inverted Instrument Status. This is an inverted (bitwise) version of the preceding parameter and is provided so that scrolling messages can be triggered when a condition is not active. Bit mappings are as the "Instrument Status", Modbus address 75	76
InstStatus2	Instrument Status 2. This is a bitmap similar to InstStatus and provides a summary of the main instrument status indicators. B0 - EEPROM Write Frequency Warning Flag No further bits are used in the current firmware.	77
Ld.A	Load ON Current	80
AL3	Alarm 3 Threshold	81
HyS	Ch1 On/Off Hysteresis in Eng Units	86
DigiIPStatus	Digital Inputs Status. This is a bitmap: B0 - Not used B1 - Logic input LA B2 - Logic input LB B7 - Power has failed since last alarm acknowledge A value of 1 signifies the input is closed, otherwise it is zero. Values are undefined if options are not fitted or not configured as inputs.	87
HyS.C	Ch2 On/Off Hysteresis in Engineering Units	88
FiLt	Input Filter Time (0 = Off)	101
SP.Hi	Setpoint High Limit	111
SP.Lo	Setpoint Low Limit	112
oFS	PV Offset	141
C.Adj	Calibration Adjust	146
IM	Instrument Mode (0 = Operating mode - all algorithms and I/O are active 1 = Standby - control outputs are off 2 = Config Mode - all outputs are inactive)	199
MVInVal	Input value in millivolts (comms only parameter).	202
QuickCodeOptions	Quick code flags (0 = Quick code SETS 1 & 2 displayed; 1 = Quick code not being shown)	205
CJCTemp	CJC Temperature	215
SBrk	Sensor Break Status (0 = Off; 1 = Active)	258
NewAlarm	New Alarm Status (0 = Off; 1 = Active)	260
AlLatchStatus	Alarm Latch	261
LoopBreakAlarm	Loop Break (0 = Off; 1 = Active)	263
A.tUn	Auto-tune Enable (0 = Off; 1 = Enabled)	270
A-M	Mode of the Loop (0 = Auto; 1 = Manual)	273
Ac.AL	Acknowledge all alarms (1 = Acknowledge)	274
AltSPSelect	Alternate Setpoint enable (comms only parameter for the Alternative Setpoint).	276
AltSPPercent	Alternative setpoint in percent	277
AltSPHi	Alternative input high scalar - sets high range for setpoint input, corresponding to 20mA or 10V depending on the input type.	278
AltSPLo	Alternative input low scalar - sets low range for setpoint input, corresponding to 4mA or 0V depending on the input type.	279
AL1Out	Alarm 1 Status (0 = Off; 1 = Active)	294
AL2Out	Alarm 2 Status (0 = Off; 1 = Active)	295
AL3Out	Alarm 3 Status (0 = Off; 1 = Active)	296
Ld.AL	Low Load Current Threshold	304
LE.AL	High Leakage Current Alarm (0 = Off; 1 = Active)	305
Hc.AL	Over Current Alarm Threshold	306
LoadAlarmOut	Load Alarm Status (0 = Off; 1 = Active)	307
LeakAlarmOut	Leak alarm Status.	308
OverAlarmOut	Over Current alarm Status (0 = Off; 1 = Active)	309
Instantaneouscurr	Instantaneous current	310

Parameter Mnemonic	Parameter Name	Modbus Address Decimal
nt		
SS.SP	Soft Start Setpoint	322
SS.oP	Soft Start Power Limit	323
t.dUr	Requested Timer Duration	324
t.EL	Elapsed Time	325
t.rE	Time Remaining	326
t.thr	Timer Start threshold	327
Unit	Display Units (0 = Degrees C; 1 = Degrees F; 3 - None)	516
uCAL	User Calibration Enable (0 = Off; 1 - Lo; 2 = Hi; 3 = Reset)	533
DigOPStatus	Digital Outputs Status. This is a bitmap: B0 - Output 1 B1 - Output 2 B2 - Output 3 on P108 and P104 controllers B3 - Output 4 It is possible to write to this status word to use the digital outputs in a telemetry output mode. Only outputs whose function is set to 'none' are affected, and the setting of any bits in the Digital Output Status word will not affect outputs used for heat (for example) or other functions. Thus it is not necessary to mask in the settings of these bits when writing to this variable.	551
AdjustHighOffset	Adjust High Offset	560
AdjustLowOffset	Adjust Low Offset	561
AdjustHighPoint	Adjust High Point	562
AdjustLowPoint	Adjust Low Point	563
Goto	Select access level	7935
P1	Input Type and Range	9001
P2	Decimal Point Position	9002
P3	Low Scale Range Value	9003
P4	High Scale Range Value	9004
P5	Linear Input Low Millivolts	9005
P6	Linear Input High Millivolts	9006
P7	Control Output and Type	9007
P8	Non Linear Cooling Type	9008
P11	Output 1 Function	9011
P12	Output 2 Function	9012
P13	Output 3 Function	9013
P14	Output 4 Function	9014
P15	DC Out Range	9015
P16	Retransmission Initial Scale Value	9016
P17	Retransmission Full Scale Value	9017
P21	Alarm 1 Type	9021
P22	Alarm 1 Latching	9022
P23	Alarm 1 Blocking	9023
P24	Alarm 2 Type	9024
P25	Alarm 2 Latching	9025
P26	Alarm 2 Blocking	9026
P27	Alarm 3 Type	9027
P28	Alarm 3 Latching	9028
P29	Alarm 3 Blocking	9029
P31	Current Transformer Source	9031
P32	Current Transformer Range	9032
P33	Current Transformer Alarm Latching	9033
P34	Loop Break Alarm Time	9034
P35	Sensor Break Alarm Type	9035
P36	Sensor Break Safe Output Power	9036
P37	Break Alarms Output	9037

Parameter Mnemonic	Parameter Name	Modbus Address Decimal
P41	Timer Configuration	9041
P42	Timer Resolution	9042
P43	Timer End Type	9043
P44	Operative setpoint at start up	9044
P51	Logic input 1 function	9051
P52	Logic input 2 function	9052
P61	Digital communications address	9061
P62	Digital communications baud rate	9062
P63	Digital communications parity	9063
P64	Communications master retransmission parameter	9064
P65	Communications master retransmission address	9065
P71	F1 pushbutton functionality	9071
P72	F2 pushbutton functionality	9072
P73	Page pushbutton functionality	9073
P74	Home display second line content	9074
P75	Home display third line content	9075
P76	Level 2 passcode	9076
P77	Configuration level passcode	9077
rEc.S	Recovery point save	9101
rEc.L	Recovery point load	9102
PHAS	Calibration phase	9103
Go	Calibration start	9104
vAL	Calibration analogue output value	9105
IPAType	Logic Input 1 channel hardware type (0 = None; 1 = Logic Inputs)	12352
IPBType	Logic Input 2 channel hardware type (P108 and P104 only) (0 = None; 1 = Logic Inputs)	12368
CommsType	Digital Communications Module Type (0 = None; 1 = EIA485)	12544
CTType	Current Transformer (0 = None; 1 = CT in)	12608
OP1Type	IO channel 1 hardware type (0 = None; 1 = Relay; 2 = Logic I/O)	12672
1.PLS	IO1 Time proportioning Output minimum pulse time	12706
OP2Type	Output 2 Type (0 = None; 1 = Relay; 2 = Logic; 3 = DC OP [P116 only]; 4 = Triac [SSR])	12736
2.PLS	Output 2 Time proportioning Output minimum pulse time	12770
OP3Type	Output 3 Type (0 = None; 1 = Relay; 3 = DC OP [P108 and P104 only])	12800
3.PLS	Output 3 Time proportioning Output minimum pulse time	12834
OP4Type	Output 4 Type (0 = None; 1 = Relay)	13056
4.PLS	Output 4 Time proportioning Output minimum pulse time	13090
QC1A	Quick code Set 1 sensor type	15872
QC1B	Quick code Set 1 units	15873
QC1C	Quick code Set 1 OP1	15874
QC1D	Quick code Set 1 OP2	15875
QC2A	Quick code Set 2 OP3	15877
QC2B	Quick code Set 2 OP4	15878
QC2C	Quick code Set 2 Logic input 1	15879
QC2D	Quick code Set 2 Logic input 2	15880
QCExit	Quick code Set save and exit	15882

9. Calibration

The controller is calibrated during manufacture using traceable standards for every input range. It is, therefore, not necessary to calibrate the controller when changing ranges. Furthermore, the use of a continuous automatic zero correction of the input ensures that the calibration of the instrument is optimised during normal operation.

To comply with statutory procedures such as the Heat Treatment Specification AMS2750, the calibration of the instrument can be verified and re-calibrated if considered necessary in accordance with the instructions given in this chapter.

For example AMS2750 states:- "Instructions for calibration and recalibration of "field test instrumentation" and "control monitoring and recording instrumentation" as defined by the NADCAP Aerospace Material Specification for pyrometry AMS2750D clause 3.2.5 (3.2.5.3 and sub clauses), including Instruction for the application and removal of offsets defined in clause 3.2.4."

9.1 To Check Input Calibration

The PV Input may be configured as mV, mA, thermocouple or platinum resistance thermometer.

9.1.1 Precautions

Before checking or starting any calibration procedure the following precautions should be taken:-

1. When calibrating mV inputs make sure that the calibrating source output is set to less than 250mV before connecting it to the mV terminals. If accidentally a large potential is applied (even for less than 1 second), then at least one hour should elapse before commencing the calibration.
2. RTD and CJC calibration must not be carried out without prior mV calibration.
3. A pre-wired jig built using a spare instrument sleeve may help to speed up the calibration procedure especially if a number of instruments are to be calibrated.
4. Power should be turned on only after the controller has been inserted in the sleeve of the pre-wired circuit. Power should also be turned off before removing the controller from its sleeve.
5. Ten minutes should be allowed for the controller to warm up after switch on.

9.1.2 To Check mV Input Calibration

The input may have been configured for a process input of mV, Volts or mA and scaled in Level 2 as described in the example in section 5.2.3. This example assumes that the display is set up to read -1000.0 for an input of -5.0mV and 2000.0 for an input of 20.0mV.

To check this scaling, connect a milli-volt source, traceable to national standards, to terminals V+ and V- using copper cable as shown in the diagram below.

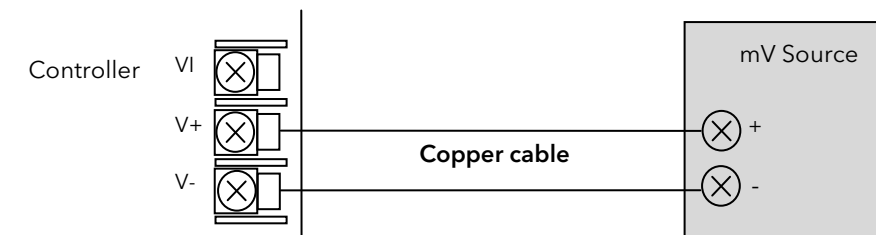

☺ Ensure that no offsets have been set in the controller (see sections 4.7.2. - parameter **aF5**).

Set the mV source to -5.00mV. Check the display reads -1000.0 $\pm 0.25\% \pm 1$ LSD (least significant digit).

Set the mV source to 20.00mV. Check the display reads 2000.0 $\pm 0.25\% \pm 1$ LSD.

9.1.3 To Check Thermocouple Input Calibration

Connect a milli-volt source, traceable to national standards, to terminals V+ and V- as shown in the diagram below. The mV source must be capable of simulating the thermocouple cold junction temperature. It must be connected to the instrument using the correct type of thermocouple compensating cable for the thermocouple in use.

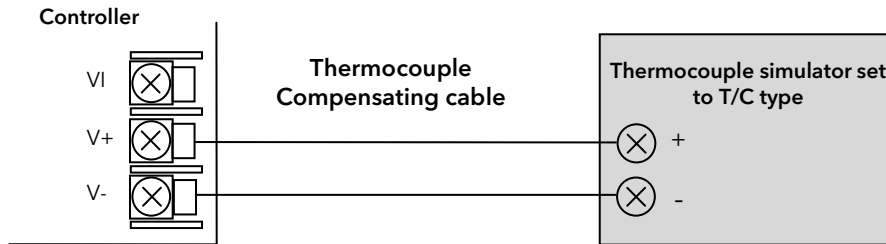

Set the mV source to the same thermocouple type as that configured in the controller.

Adjust the mV source for minimum range. For a type J thermocouple, for example, the minimum range is -210°C . However, if it has been restricted using the Range Low parameter then set the mV source to this limit. Check that the reading on the display is within $\pm 0.25\%$ of reading $\pm 1\text{LSD}$.

Adjust the mV source for to the maximum range. For a type J thermocouple, for example, the minimum range is 1200°C . However, if it has been restricted using the Range High parameter then set the mV source to this limit. Check that the reading on the display is within $\pm 0.25\%$ of reading $\pm 1\text{LSD}$.

Intermediate points may be similarly checked if required.

9.1.4 To Check RTD Input Calibration

Connect a decade box with a resolution to two decimal places in place of the RTD as indicated on the connection diagram below **before the instrument is powered up**. Make sure that the internal resistance of the box, the interconnection leads and any other connections are kept as low as possible - certainly less than 22ohms and preferably $<1\text{ohm}$. If at any instant the instrument was powered up without this connection then at least 10 minutes must elapse from the time of restoring this connection before RTD calibration check can take place.

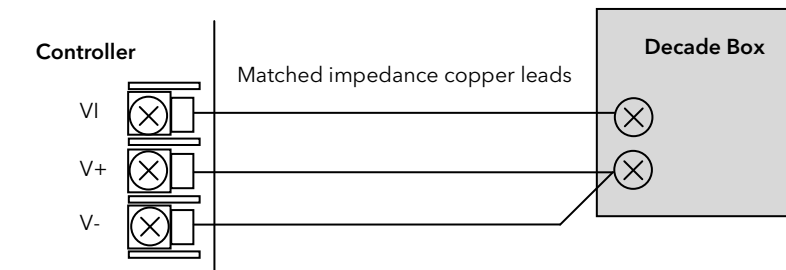

The RTD range of the instrument is -200 to 850°C . It is, however, unlikely that it will be necessary to check the instrument over this full range.

Set the resistance of the decade box to the minimum range. For example $0^{\circ}\text{C} = 100.00\Omega$. Check the calibration is within $\pm 0.25\%$ of reading $\pm 1\text{LSD}$.

Set the resistance of the decade box to the maximum range. For example $200^{\circ}\text{C} = 175.86\Omega$. Check the calibration is within $\pm 0.25\%$ of reading $\pm 1\text{LSD}$.

9.2 Input Calibration

Calibration can only be carried out in **Configuration Level**.

If the calibration is not within the specified accuracy follow the procedures in this section:-

In Piccolo Range instruments, inputs which can be calibrated are:-

- **mV Input.** This is a linear 0 - 80mV range calibrated at two fixed points. This should always be done before calibrating either thermocouple or resistance thermometer inputs. mA range calibration is included in the mV range.
- **Thermocouple** calibration involves calibrating the temperature offset of the CJC sensor only. Other aspects of thermocouple calibration are also included in mV calibration.
- **Resistance Thermometer.** This is also carried out at two fixed points - 150Ω and 400Ω.

Before any calibration is attempted, observe the precautions listed in section 9.1.1.

9.2.1 To Calibrate mV Input

Connect a 0 - 50mV source as shown in section 9.1.2. mA calibration is included in this procedure.

For best results 0mV should be calibrated by disconnecting the copper wires from the mV source and short circuiting the input to the controller.

Select **Configuration Level** as described in section 5.1.

Set P code 'P1' to mV range (ΠV), then:-

Operation	Do This	Display View	Additional Notes
Select calibration phase	1. Press or to select PHAS		This is found towards the end of the list of 'P' codes.
Set mV source for 0mV			
Select the low calibration point	2. Press or to choose '0'		
Calibrate the instrument to the low calibration point (0mV)	3. Press to select '00'		The controller automatically calibrates to the injected input mV. The display will show busy for approximately 3-10 seconds, then PASS , (if calibration is successful). If FAIL is shown this is because the reference measurement is unstable or outside +/-20% of expected mV input. If this should occur it will be necessary to go back to the beginning of the calibration, ensure that the correct mV are set and repeat the step that failed.
	4. Press or to choose 'YES'		
	5. Press to confirm		
	6. Press again to enter		
Set mV source for 50mV			
Select the high calibration point	7. Press to go back to 'PHAS'		The controller will again automatically calibrate to the injected input mV. If it is not successful then 'FAIL' will be displayed
	8. Press or to choose '50'		
	9. Press to enter		
	10. Press or to choose 'YES'		Note: PASS is displayed at the end of a calibration to indicate that the operation has been successful and has produced a value that appears to be within tolerance (+/- 20%) of expected values. It does not indicate that that the calibration is precisely correct, and the measured value must be verified in instrument operator mode against known sources to ensure calibration accuracy.
	11. Press to confirm		
	12. Press again to confirm and to exit from the calibration phase		

9.2.2 To Calibrate Thermocouple Input

Thermocouples are calibrated, firstly, by following the previous procedure for the mV ranges, then calibrating the CJC.

Connect a mV source as described in section 9.1.3. Set the mV source to '**internal compensation**' for the thermocouple in use and set the output of the mV source to **0mV**.

Set 'P1' to the required thermocouple type. Then:-

Operation	Do This	Display View	Additional Notes
Select calibration phase	1. Press or to select 'PHAS'		This is found towards the end of the list of 'P' codes
Select CJC calibration	2. Press or to select 'CJC'		
Calibrate CJC	3. Press to select 'GO' 4. Press or to choose 'YES' 5. Press to confirm 6. Press again to confirm and to exit from the calibration phase	 	The controller automatically calibrates to the CJC input at 0mV. The display will show <i>bUSY</i> then <i>PASS</i> , (if calibration is successful) or ' <i>FAI L</i> ' if not. Fail may be due to an incorrect input mV

9.2.3 To Calibrate RTD Input

The two points at which the RTD range is calibrated are 150.00Ω and 400.00Ω.

Before starting RTD calibration:

- Connect a decade box with a resolution to two decimal places in place of the RTD as indicated on the connection diagram below **before the instrument is powered up**. Make sure that the internal resistance of the box, the interconnection leads and any other connections are kept as low as possible – certainly less than 22ohms and preferably <1ohm, as indicated on the connection diagram in section 9.1.4. If at any time the instrument was powered up without this connection then at least 10 minutes should elapse from the time of restoring this connection before RTD calibration can take place.
- Before calibrating the RTD input the mV range must be calibrated first.

Set 'P1' to 'rEd'. Then:-

Operation	Do This	Display View	Additional Notes
Select the calibration phase	1. Press or to select 'PHAS'		This is found towards the end of the list of 'P' codes
Set the decade box for 150.00Ω			
Select the low calibration point (150Ω)	2. Press or to select '150r'		
Calibrate the low point	3. Press to select 'GO' 4. Press or to choose 'YES' 5. Press to confirm	 	The controller automatically calibrates to the injected 150.00Ω input. The display will show <i>busy</i> then <i>PASS</i> (if calibration is successful) or 'FAL L' if not. Fail may be due to an incorrect input resistance.
	6. Press again to confirm		
Set the decade box for 400.00Ω			
Select the high calibration point (400Ω)	7. Press or to select '400r'		
Calibrate the high point	8. Repeat 3 to 6 above to calibrate the high point	 	The controller will again automatically calibrate to the injected 400.00Ω input. If it is not successful then 'FAL L' will be displayed

9.2.4 To Calibrate mA Outputs

Output 2 (P116) and/or Output 3 (P108/P104) may be supplied as mA outputs. They may be calibrated as follows:-

Connect an ammeter to the output - terminals 2A/2B or 3A/3B as appropriate.

The example below is for Output 2 (P116).

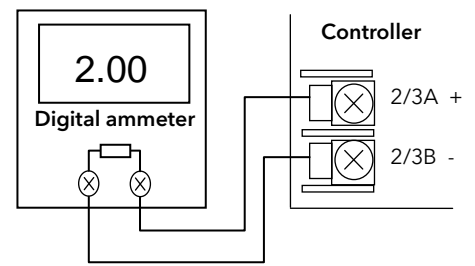

In configuration level:-

Operation	Do This	Display View	Additional Notes
Select the calibration phase	1. Press or to select 'PHAS'		This is found towards the end of the list of 'P' codes
Select low point calibration phase for the mA output to be calibrated (eg OP2)	2. Press or to select '2NAL'		
Calibrate the low point	3. Press to select 'uAL' 4. Press or to adjust this value so that it reads the same value as shown on the ammeter. For example if the meter reads 2.06 then set the controller reading for 206. The decimal point is not displayed on the controller so that 202 represents 2.02. 5. Press to confirm		
Select high point calibration phase for the mA output to be calibrated (eg OP2)	6. Press to go back to 'PHAS' 7. Press or to select '2NAH'		
Set the high point output	8. Press to select 'uAL' 9. Press or to adjust this value so that it reads the same value as shown on the ammeter. The value represents 18.00mA		
	10. Press again to confirm and to exit from the calibration phase		

The above procedure may be repeated for Output 3 if it is fitted with analogue output modules.

9.2.5 CT Calibration

To calibrate the current transformer input, connect the current transformer to terminals CT and C.

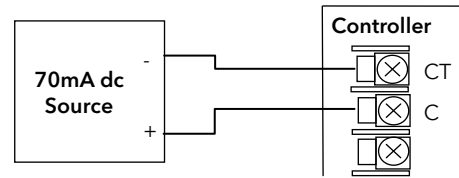













Then in configuration level

Operation	Do This	Display View	Additional Notes
Select the current transformer calibration phase	1. Press or to select 'PHAS'		This is found towards the end of the list of 'P' codes
Adjust the CT for no current applied to the input			
Select the CT low calibration point	2. Press or to select 'CT 0'		
Calibrate at 0mA	3. Press to select 'GO' 4. Press or to choose 'YES' 5. Press to enter	 	The controller automatically calibrates to the zero current input. As it does this the display will show <i>busy</i> then <i>PASS</i> , assuming a successful calibration. If it is not successful then 'FAIL' will be displayed. This may be due to an incorrect input current.
	6. Press again to confirm		
Adjust the CT for a current of 70mA			
Select the CT high calibration point	7. Press to return to 'PHAS' 8. Press or to select 'CT 70'		
Calibrate at 70mA	9. Press to select 'GO' 10. Press or to choose 'YES' 11. Press to enter	 	The controller automatically calibrates to the 70mA current input. As it does this the display will show <i>busy</i> then <i>PASS</i> , assuming a successful calibration. If it is not successful then 'FAIL' will be displayed. This may be due to an incorrect input current.
	12. Press again to confirm and to exit from the calibration phase		

9.2.6 To Return to Factory Calibration

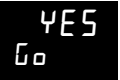
It is always possible to revert to the factory calibration as follows:-

Operation	Do This	Display View	Additional Notes
Select the calibration phase	1. Press  or  to select 'PHAS'		This is found towards the end of the list of 'P' codes
Select the Factory calibration values	2. Press  or  to select 'FRct'		
Confirm	3. Press  to select 'GO' 4. Press  or  to choose 'YES' 5. Press  to enter	 	The controller automatically returns to the factory values stored during manufacture.
	6. Press  again to confirm and to exit from the calibration phase		

9.3 Calibration Parameters

The following table gives a summary of the parameters available in the Calibration List.

Name	Parameter Description	Value	Default	Access Level
PHAS	Calibration phase	nonE	Not selected	Configuration only
		0	Select mV low calibration point	
		50	Select mV high calibration point	
		150r	Select PRT low cal point	
		400r	Select PRT high cal point	
		CJC	Select CJC calibration	
		CE 0	Select CT low cal point	
		CE 70	Select CT high cal point	
		FRct	Return to factory settings	
		2NAL	Low mA output from output 2	
		2NAH	High mA output from output 2	
		3NAL	Low mA output from output 3	
3NAH	High mA output from output 3			
GO	To start the calibration sequence	n0		Configuration only
		YES	Start	
		bUSY	Calibrating	
		PASS	Calibration successful	
		FR, L	Calibration unsuccessful	

10. Configuration Using iTools

iTools is a configuration and monitoring package which will edit, store and 'clone' complete controller configurations. It is a free downloadable package available from www.eurotherm.co.uk.

iTools can be used to configure all the functions of Piccolo Range controllers described in this manual. It is also possible using iTools to configure additional functions such as customised messages and parameter promotion. These features are described in this chapter.

Please refer to the iTools Help Manual Part No. HA028838 for further information on how to install, connect and generally operate iTools. This can be downloaded from www.eurotherm.co.uk.

10.1 Loading an IDM

An IDM is a software file which defines the parameter addresses of a particular build of instrument. This is normally included with your iTools CD and iTools will then recognize the software version of your instrument.

If the build of your instrument is a non-standard, it may be necessary for you to download the IDM from the Eurotherm web site www.eurotherm.co.uk. The file will be of the format IDxxx_v106.exe, where IDxxx is the instrument and v--- is the software version number of the instrument.

To register the new IDM

Copy the file to c:\Program Files\Eurotherm\iTools\Devices.

To load the IDM

Open iTools.

Select Options → Advanced → Show Server.

In the OPC Server, select Edit → IDM Manager → Install New IDM

Select the IDM. A list of these may be found in Program Files\Eurotherm\iTools\Devices.

10.1.1 Using the H Communications Port

Connect the controller to the EIA232 serial communications port of the PC shown in section 2.14.

10.2 Connecting a PC to the Controller

In these controllers this may be done using digital communications port H or by a configuration clip.

10.2.1 Configuration Clip

A Configuration Clip is available with iTools by quoting part number 3000CK in the iTools ordering code. The clip can be fitted into the side of a controller as shown and has a USB interface to a PC.

Ensure that the controller is powered down before the clip is attached.

The benefit of using this arrangement is that it is not necessary to power the controller, since the clip provides the power to the internal memory of the controller.

Note: An existing earlier version of this clip with a serial interface to a PC may also be used.



10.3 Starting iTools

Open iTools and, with the controller connected, press  on the iTools menu bar. iTools will search the communications ports and TCP/IP connections for recognisable instruments. Controllers connected with the configuration clip (CPI), will be found at address 255 regardless of the address configured in the controller.

When the instrument is detected a screen view similar to the one shown below will be displayed. The browser on the left shows the List Headers. To display parameters within a list double click the Header or select 'Parameter Explorer'. Click on a list header to display parameters associated with this list.

The instrument view may be turned on or off using the 'View' menu and selecting 'Panel Views'.

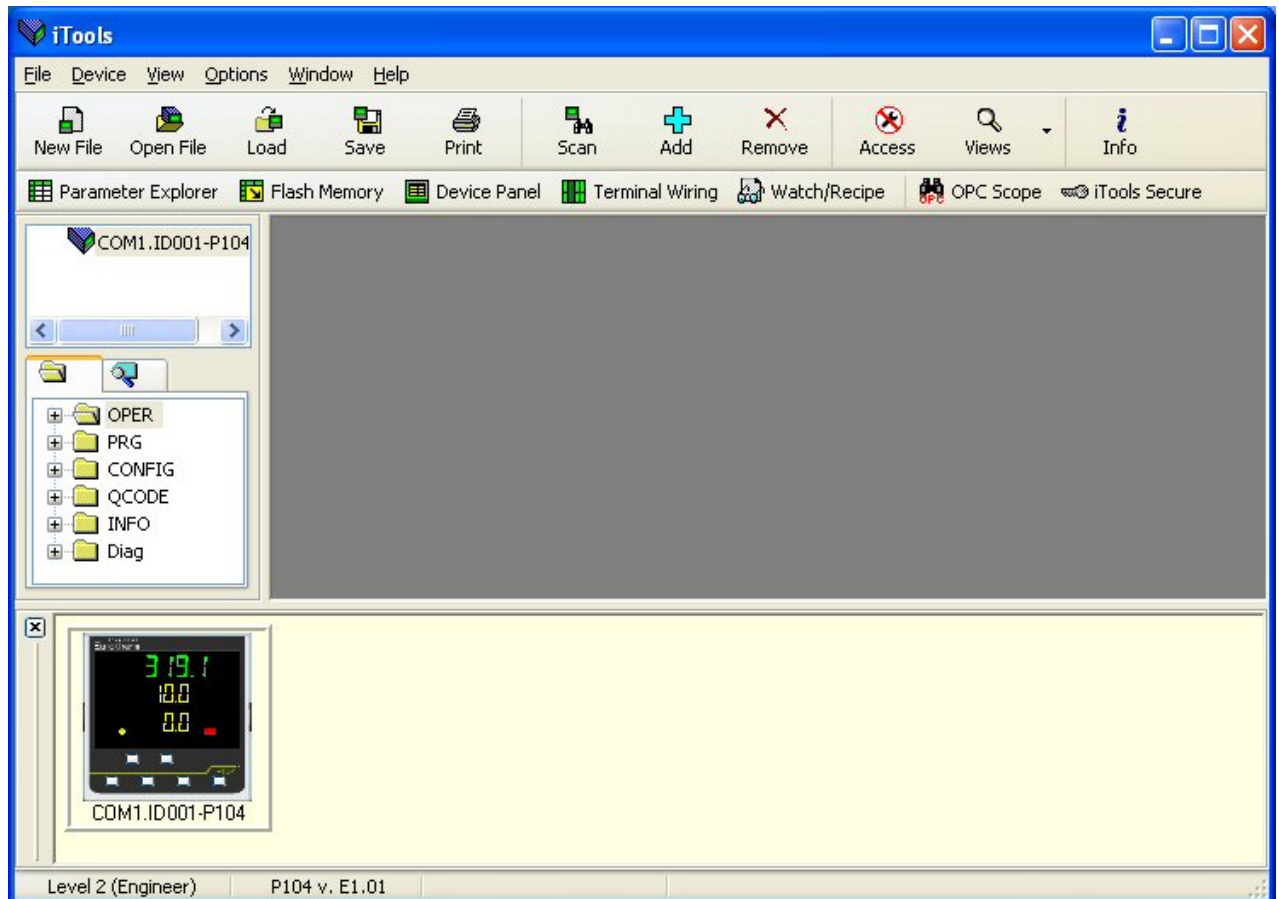

The instrument may be configured using a **Wizard** or from the **Browser** view above. The following pages show a number of examples of how to configure various functions using either of these features.

It is assumed that the user is generally familiar with iTools and has a general understanding of Windows.

10.4 Configuration using the Wizard

When a new instrument is detected, iTools will open showing the configuration Wizard.

It may also be opened at any time. From the opening view shown in the previous section press



The controller will be set to configuration level. Since it will not operate the process in configuration level a warning message appears. When this is accepted the Wizard start up screen is shown. This is an introductory screen with no configuration options.

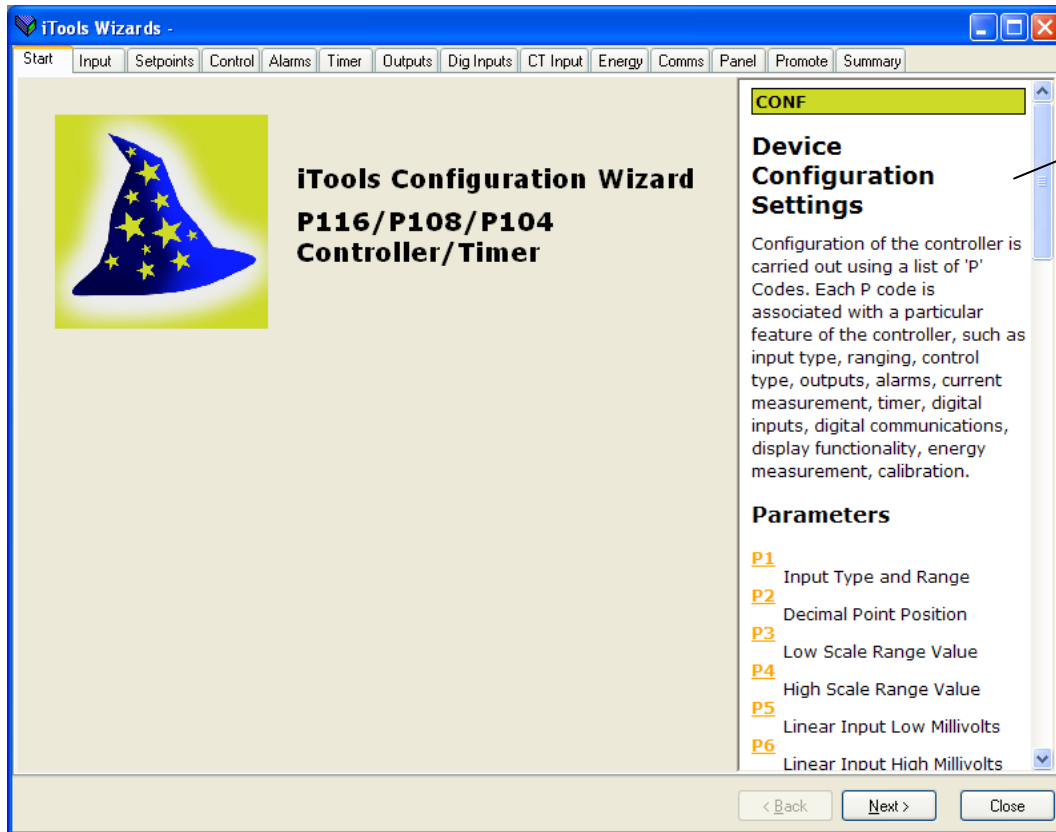

Help text is shown in the right hand side of every screen.

A series of tabs allows different functions to be configured. Alternatively use the Next> and <Back buttons.

Tab	Summary of Settings
Input	Sensor type, range limits, display units, number of decimal places, sensor break action, input filter time, PV offset and user calibration.
Setpoints	High and low limits for SP1 and SP2, select active setpoint, setpoint rate of change, setpoint trim
Control	Control type, output power limits, time proportioning limits, and manual setting of the control terms
Alarms	Alarm types 1, 2 and 3, latching mode, blocking mode, thresholds and hysteresis
Timer	Timer Type, Timer Resolution
Outputs	Outputs 1, 2, 3, 4, DC Output Range, Setpoint Retransmission
Dig In A-B	IP1 Function, IP2 Function
CT Input	Select Control Output, Set span of the current measurement, CT Alarm Latching Mode
Comms	Address, Baud Rate, Parity, Simple Master Comms - Transmitted and Destination Addresses
Panel	Pushbutton functionality, Default Display, Passcodes, Recovery Point Save and Load
Energy	Partial and Total Values
Promote	To make parameters Read/Write in Levels 1/2
Summary	Terminal allocations for modules fitted

If the controller is already configured the current configuration values are imported from the controller.

Select a tab to configure a function. The corresponding 'P' codes are shown in each tab.

Help text is available by clicking into each parameter value.

10.4.1 Sensor Input

Select the 'Input' tab to configure Input Type (P1); Decimal Places (P2); Low Range Limit (P3); High Range Limit (P4); Linear mV Input Low (P5): Linear mV Input High (P6).

Display Units; Input Filter Time Constant; PV Offset; User Calibration, can also be set in level 2.

Use the drop down boxes or enter values directly as appropriate.

This example configures the controller to read -100 for an input of 0mV and 300 for an input of 50mV.

Offsets are added to compensate for known measurement errors in the process.

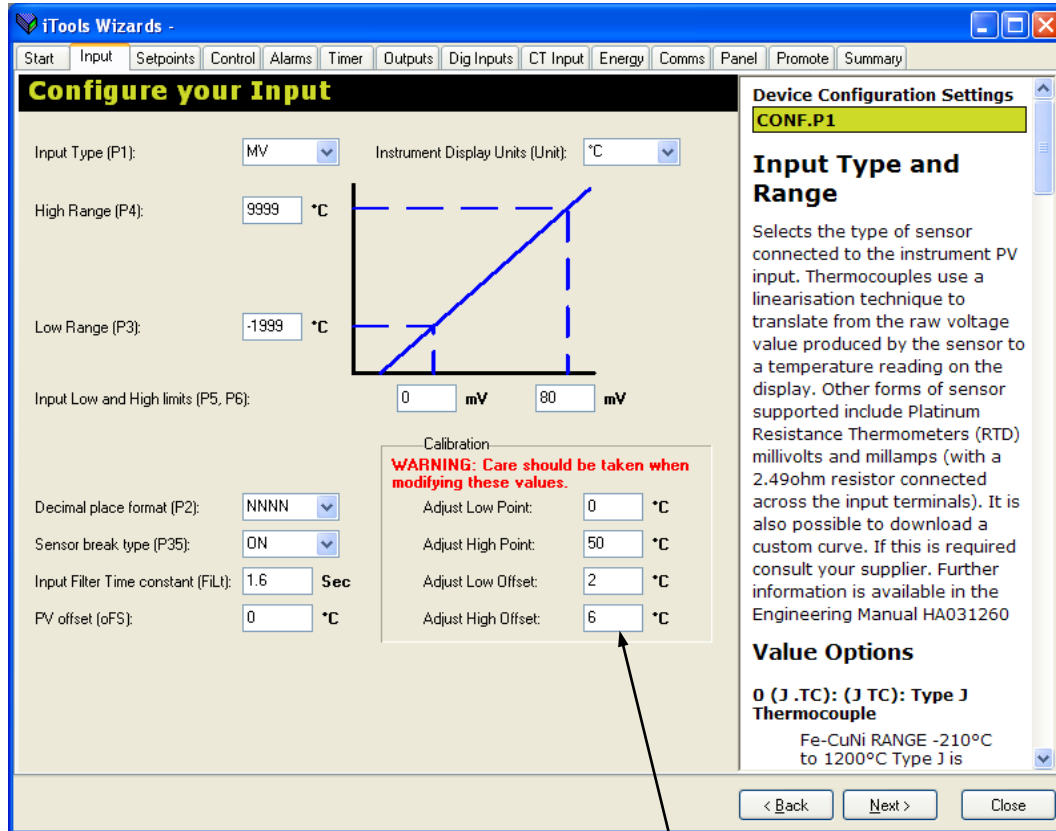

☺ The input type and range may also be configured using the Quick Codes section 4.1.1 or P Codes P1 to P6 section 5.2.2 and 5.2.3.

Click in any box to show more Help text

Operating User Calibration
OPERATING.USERCAL.AdjustHi

Adjust High Offset

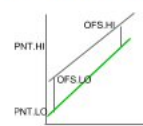

The adjust low and high point parameters are used in the user calibration algorithms. They are edited automatically by the ucal and adjust, the PNT.LO, PNT.HI and OFS.HI, OFS.LO can be edited by comms. However they do not usually require manual adjustment, as the user calibration sequence will automatically update them.

10.4.2 Setpoints

Select the 'Setpoints' tab to set up:- Low and high setpoint limits; Setpoint 1 and 2 values; the active setpoint; setpoint rate limit. These parameters can also be set in level 2.

It is also possible to set the Remote or Alternative setpoint conditions. These parameters are only available through digital communications - section 8.3.

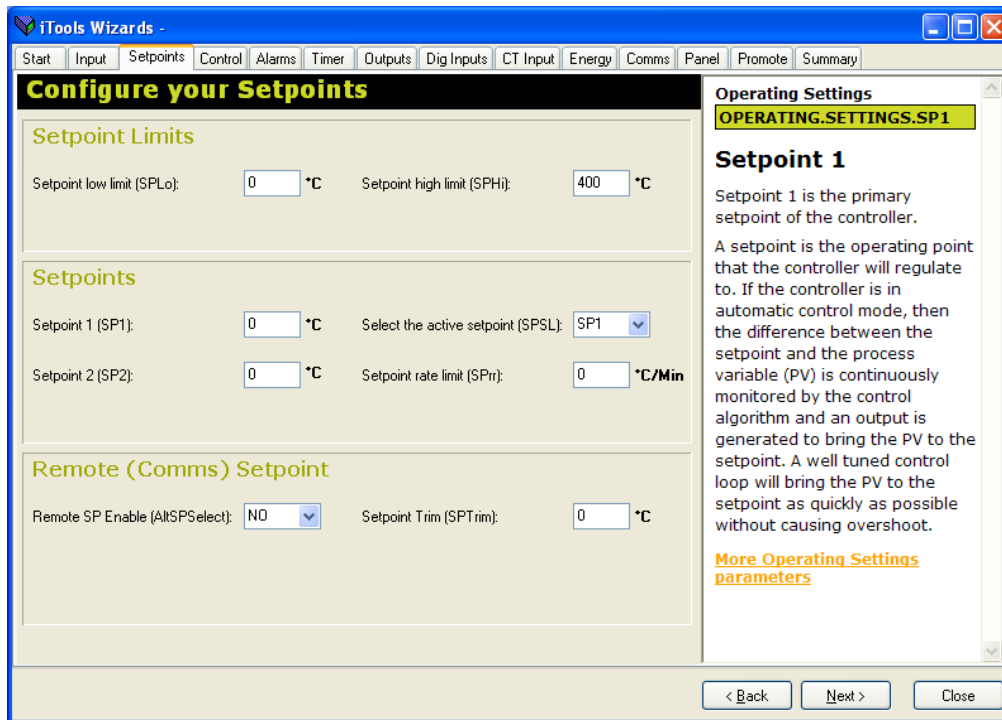

10.4.3 Control

Select the 'Control' tab to configure control type (P7); cooling algorithm (P8); safe output power (P36, sensor break and standby); loop break time (P34).

Autotune; the three term parameters; On/Off hysteresis; heat/cool deadband; time proportioning output rates; output limits; can also be set in level 2.

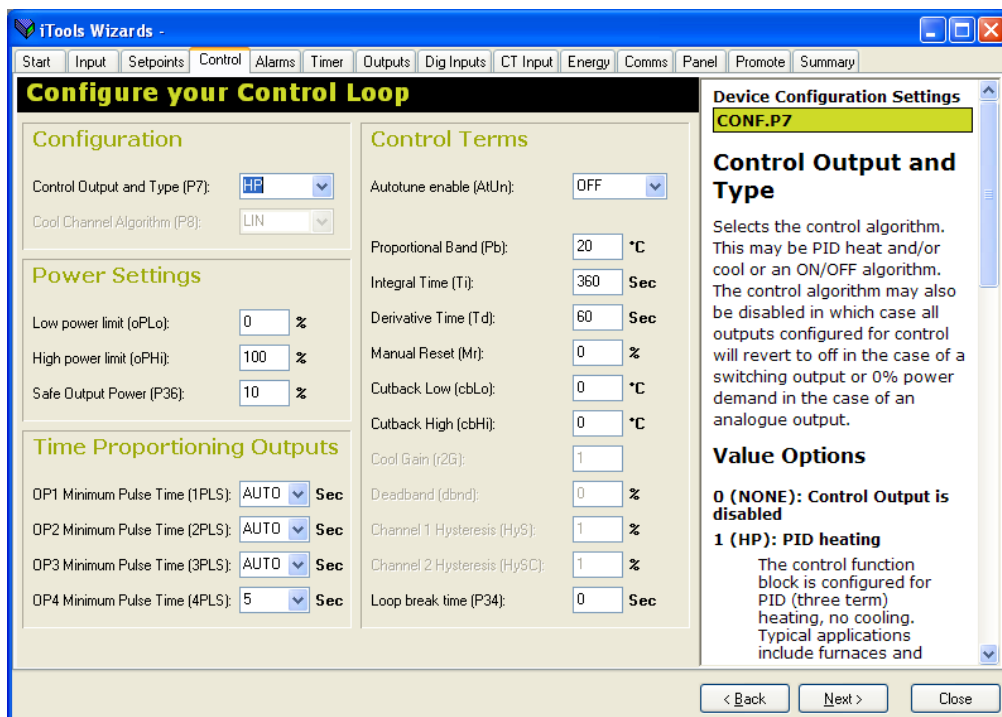

10.4.4 Alarms

Select the 'Alarms' tab to configure:- up to three alarm types; latching and blocking modes; alarm thresholds and hysteresis. Alarm Threshold and Alarm Hysteresis can be adjusted in operator level 2, section 4.7.2.

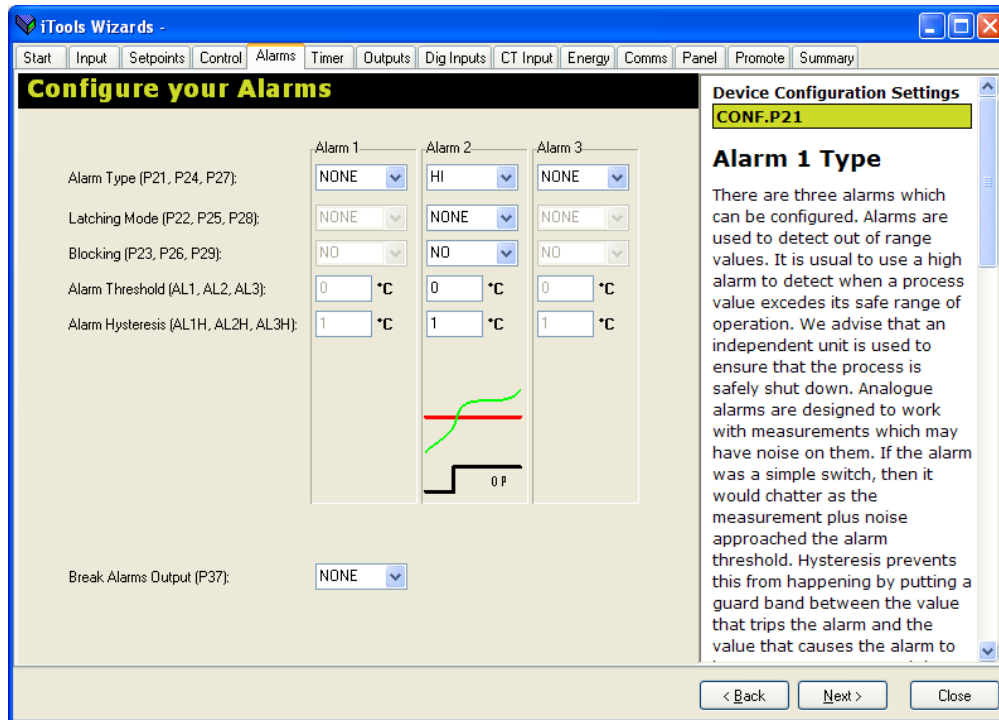

10.4.5 Timer

Select the 'Timer' tab to configure up timer types (P41) resolution (P42), end type (P43). An explanation of the different types of timer is given in section 4.12.

There are three types of timer:

10.4.5.1 Dwell Timer

Timer duration, start threshold, and controller setpoint can be adjusted in operator level 2, section 4.7.2.

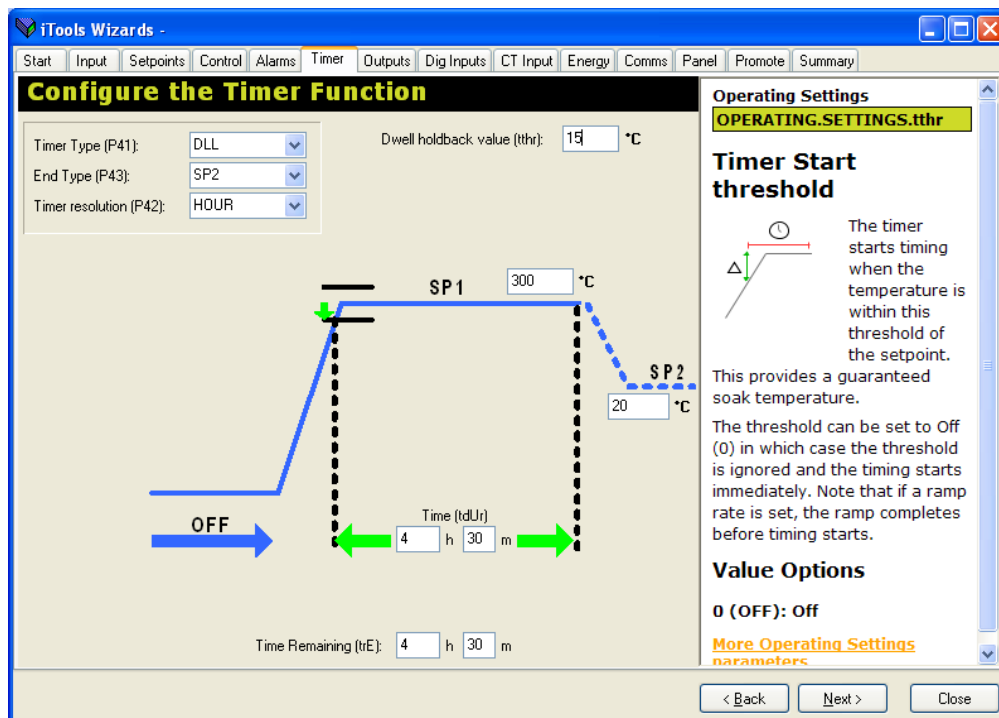

10.4.5.2 Delay Timer

Delay time and controller setpoint can also be set in operator level 2, section 4.7.2.

Configure the Timer Function

Timer Type (P41): DELY
 End Type (P43): SP2
 Timer resolution (P42): HOUR

300 °C SP1

OFF

Time (tdUr): 4 h 30 m

Time Remaining (trE): 4 h 30 m

3 (SS): Soft start timer
 This provides a power limit before switch on.

< Back Next > Close

10.4.5.3 Soft Start Timer

Timer duration, controller setpoint and soft start power limit can also be set in operator level 2, section 4.7.2.

Configure the Timer Function

Timer Type (P41): SS
 End Type (P43): SP2
 Timer resolution (P42): HOUR

SoftStart Setpoint (SSSP): 100 °C

300 °C SP1

Time (tdUr): 4 h 30 m

SoftStart Pwr Limit (SSoP): 50

Time Remaining (trE): 4 h 30 m

3 (SS): Soft start timer
 This provides a power limit before switch on. It starts automatically on power up, and applies a power limit ('SS.oP' set in Level 2) until the temperature reaches a set value ('SS.SP' set in Level 2). It is typically used, for example, to dry-out heaters in Hot Runner control systems before full power is allowed.

4 (P.1.08):
 5 (P.2.04):
 6 (P.4.02):

[More Device Configuration Settings parameters](#)

< Back Next > Close

10.4.6 Outputs

Select 'Outputs' tab to configure the functions of up to four outputs (output 3 is not available in P116). If an analogue output is fitted (to OP3 in P108 / P104 and OP2 in P116) it can be configured for 4-20 or 0-20mA (P15) as can the retransmission range (P16 and P17).

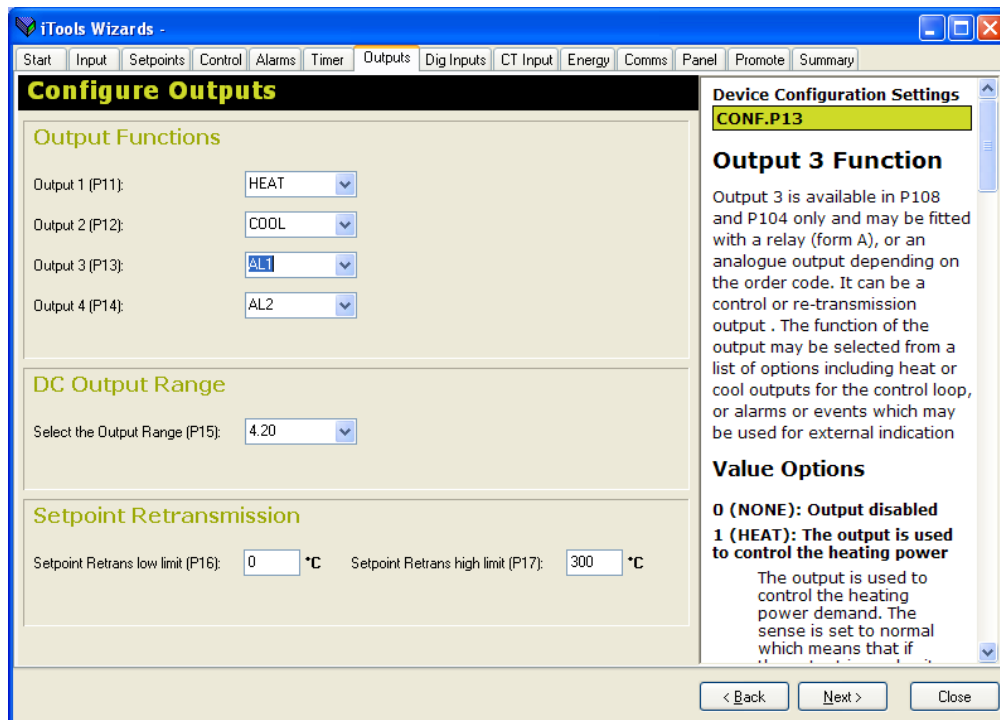

10.4.7 Digital Inputs

Select 'Dig Inputs' tab to configure the functionality of up to two digital inputs (Digital Input 2 is not available in P116).

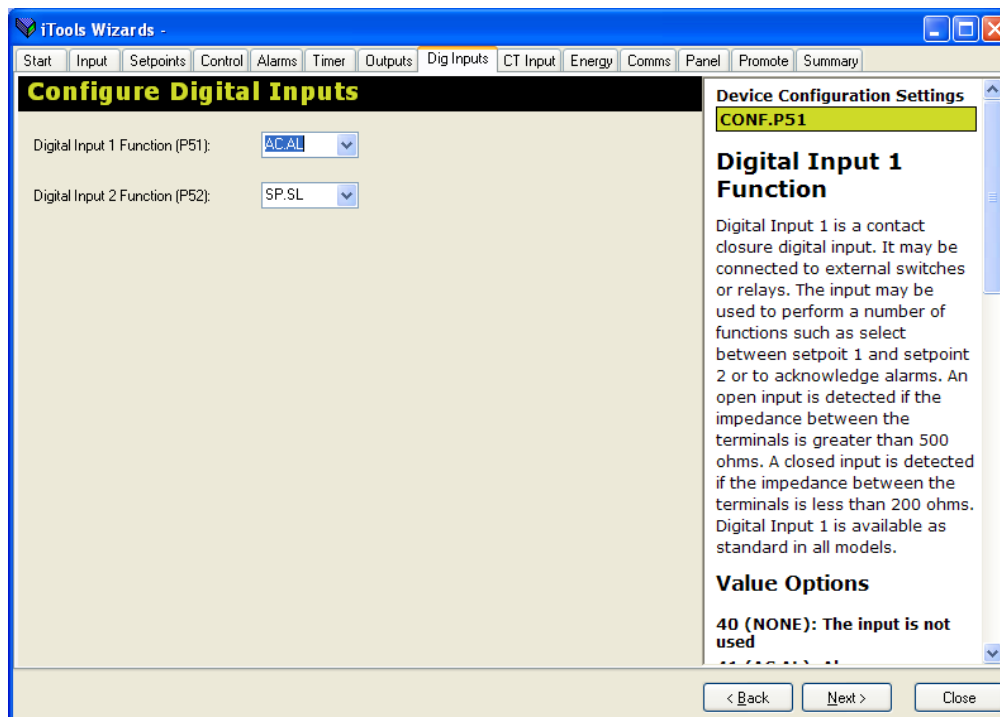

10.4.8 Current Transformer Input

Select 'CT Input' tab to configure which output is used to measure the load current (P31), the load current (P32) and the CT alarm latching mode (P33). The alarm thresholds of the current measurement can also be set up in level 2, section 4.7.2.

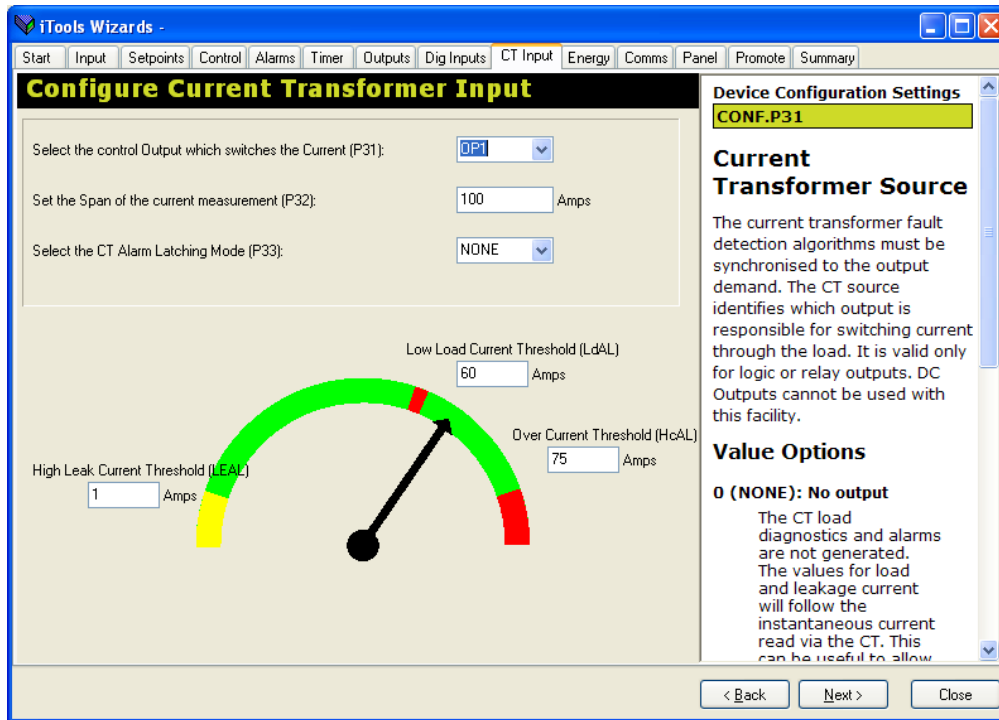

10.4.9 Energy

Select 'Energy' tab to configure the output source for the energy measurement and the nominal current rating of the load. The energy usage estimates can be read and reset on this screen. These parameters are also available in level 2.

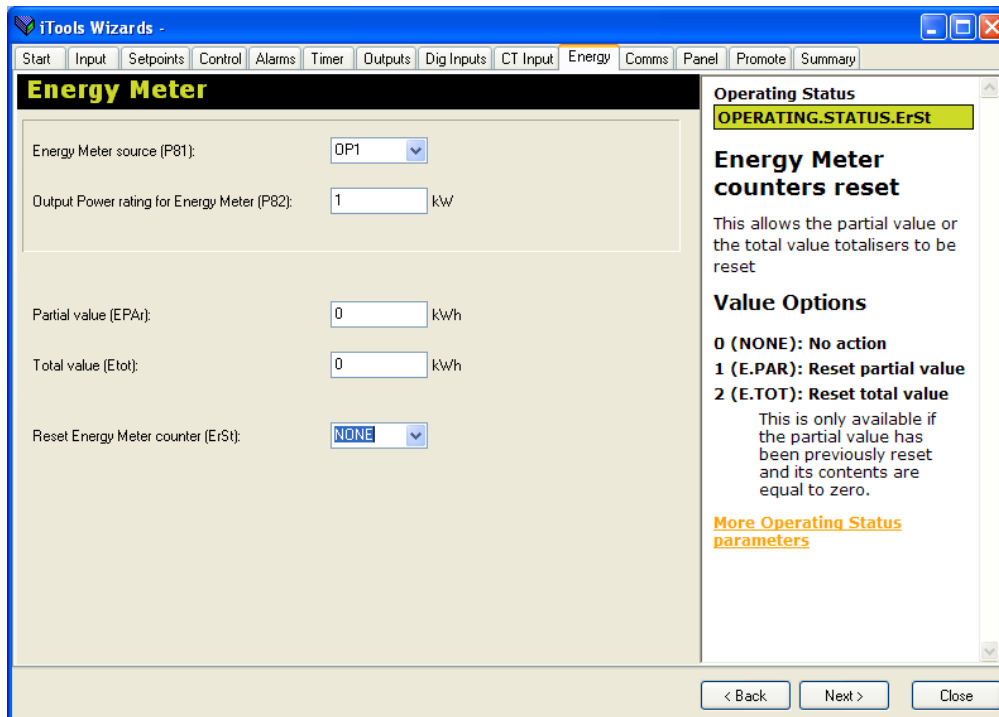

10.4.10 Digital Communications

Select 'Comms' tab to configure instrument address (P61), baud rate (P62) and parity (P63). Transmitted parameter (P64) and destination address (P65) can also be configured if the controller is to be used as a communications master (section 8.3).

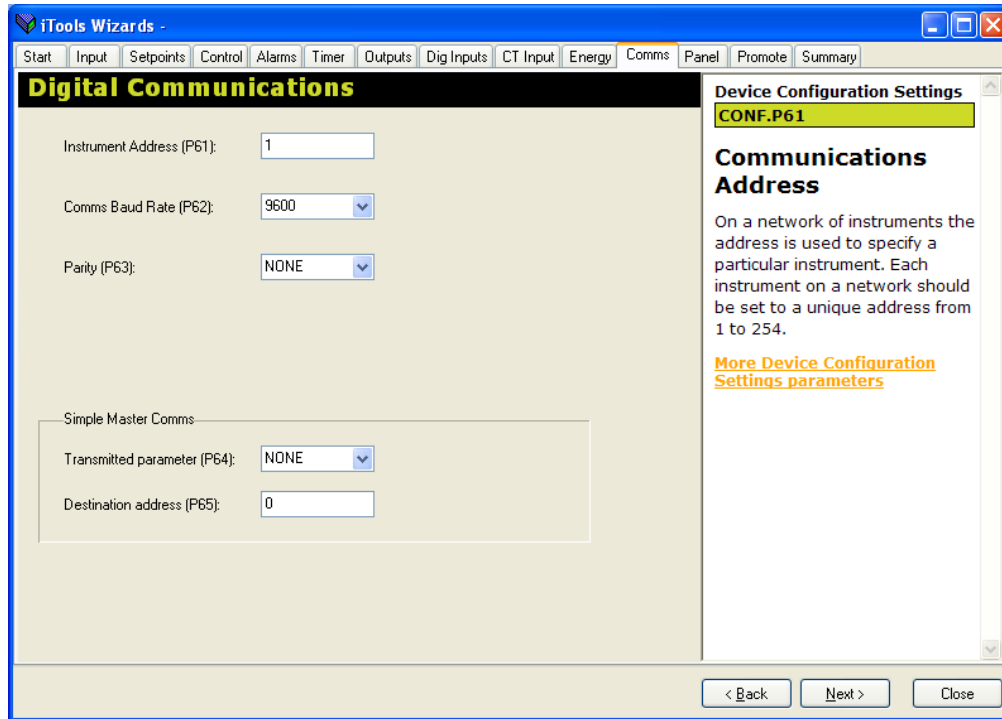

10.4.11 Pushbutton and Display Functionality

Select 'Panel' to configure the functionality of the  (P73), F1 (P71) and F2 buttons (P72); the display layout (P74, display line 2 and P75, display line 3); the passcodes (P76 level 2 and P77, configuration level) and the recovery point (rEcS and rEcL).

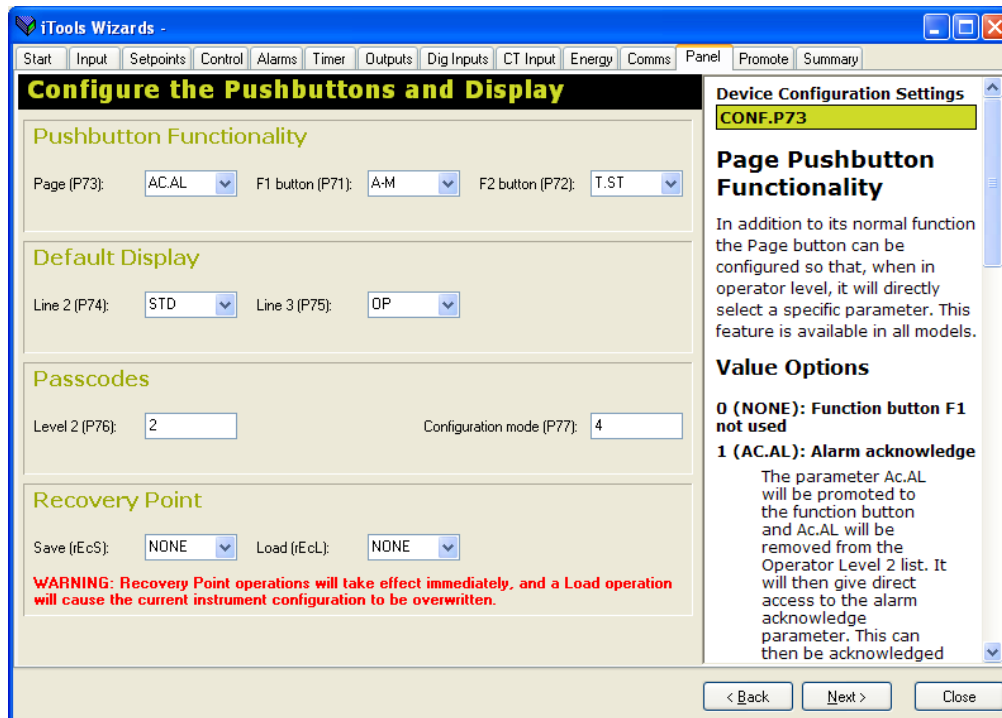

10.4.12 Promote

The list of parameters which are available in operator levels 1 or 2 can be changed using the 'Promote' tab. Access can be set to Read Only or Read/Write. This functionality is only available using iTools and cannot be configured in the controller itself.

Select 'Promote' tab

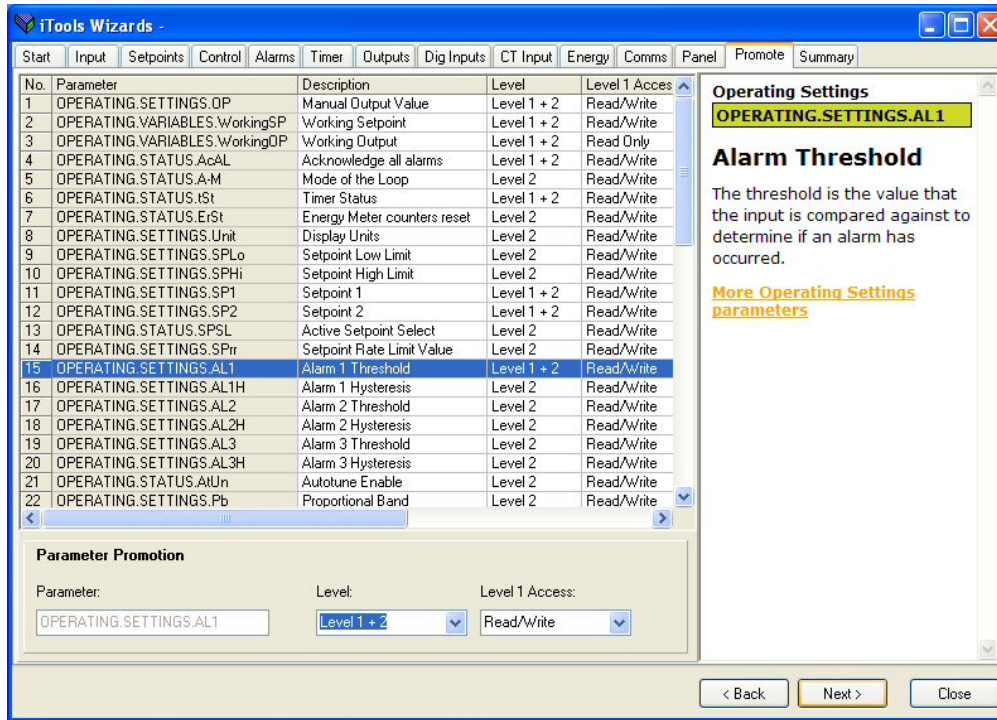

Highlight a parameter and, in the 'Level' drop down box, select the level of access you wish to be available to the operator and whether it should be Read/Write or Read only.

In this example Alarm 1 Threshold has been made available in both Levels 1 and 2.

10.4.13 Example: Summary

Select 'Summary' tab to show the terminal connections for the functions which have been configured together with a description of each function.

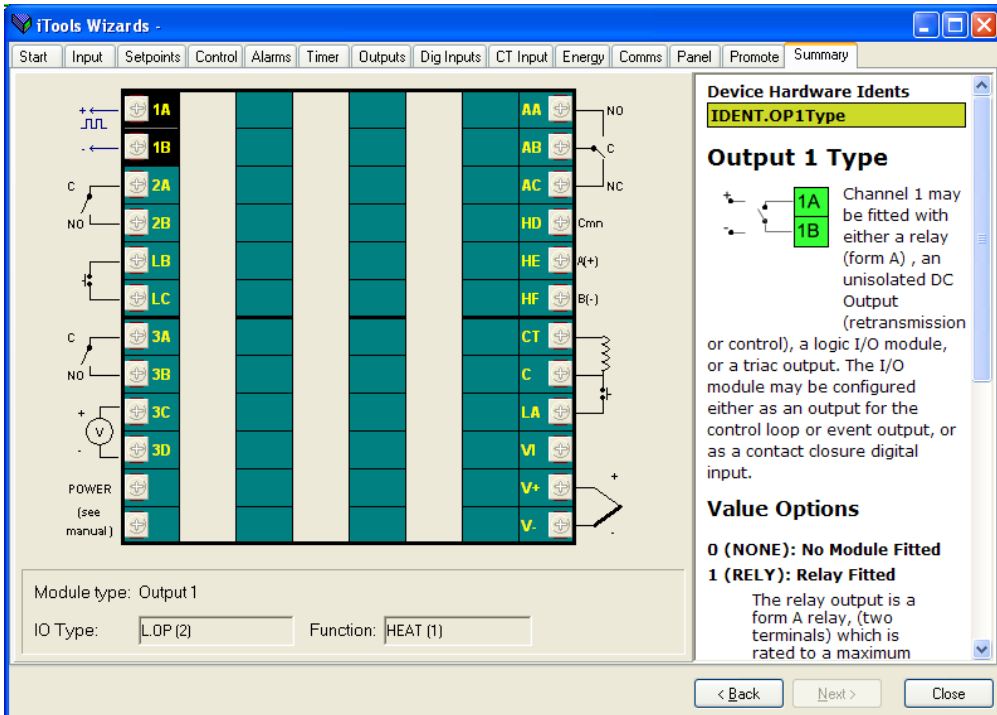

Click on the terminal numbers to show the I/O Type, Function and corresponding Help for that terminal. If no function is configured the small diagram showing connections on that output are removed.

The Wizard can be closed now or at any time. It can always be restarted again by selecting



in the menu bar.

10.5 The 'Browse' List

Parameters are available under list headings.

10.5.1 Operating List

The OPERATING list is divided into four sub headings.

To show the parameter list either double click the list header or select

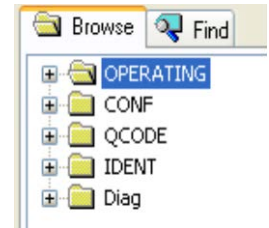

Each sub heading can be selected individually or is available under four tabs.

10.5.1.1 Settings

SETTINGS allow operating values to be set and are generally the same as those listed in the controller in operator level 2.

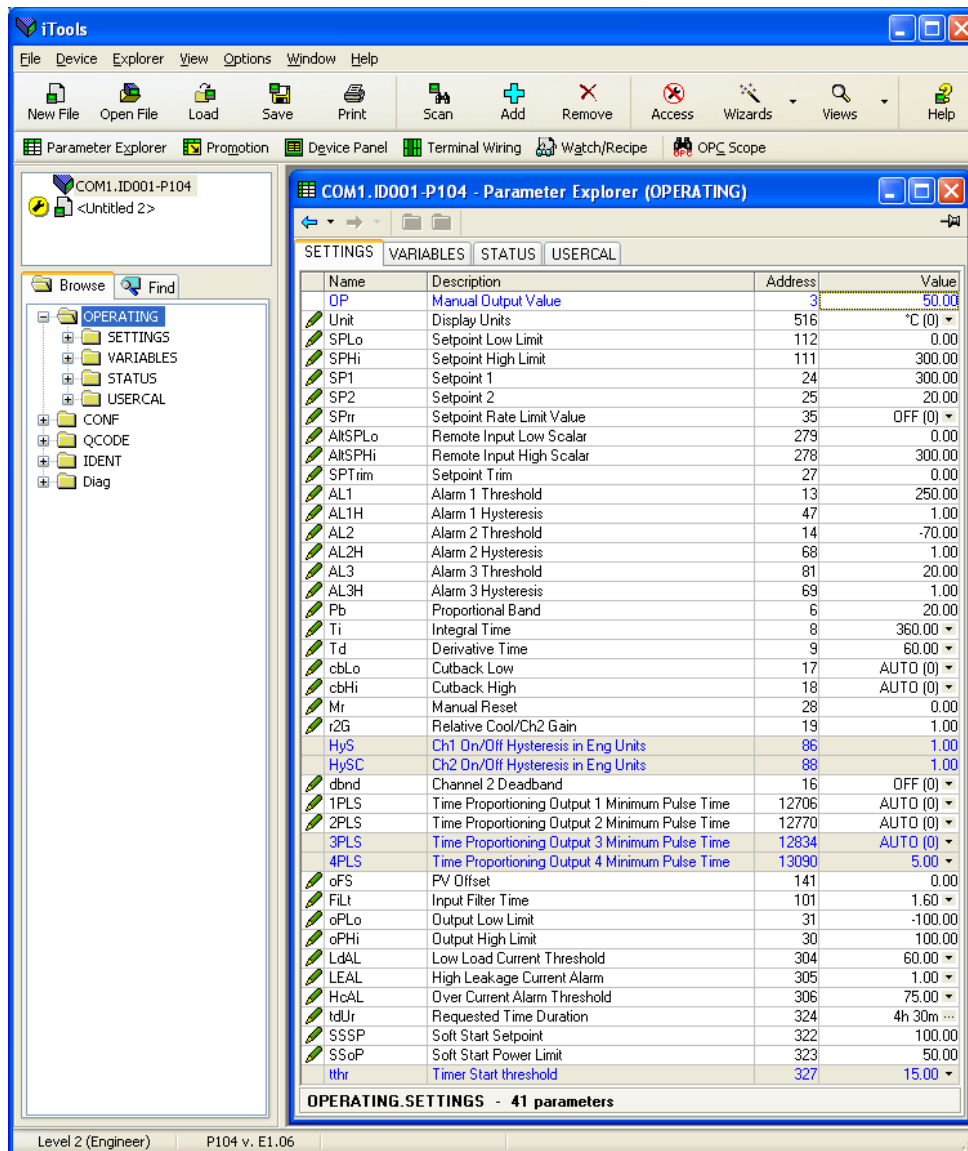

10.5.1.2 Variables

VARIABLES generally show read only values from the process being controlled.

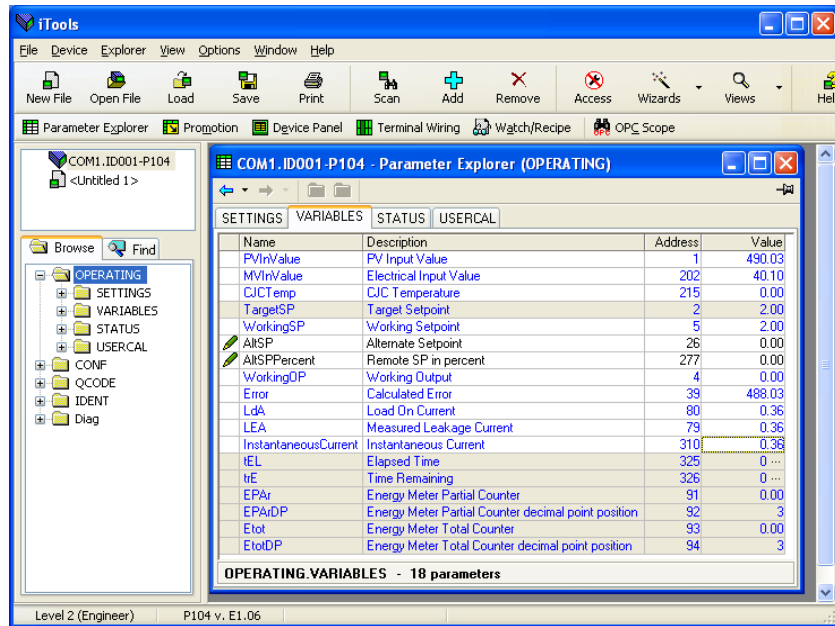

10.5.1.3 Status

STATUS show conditions such as alarm states and allow selections to be made such as those generally available in the Digital Inputs.

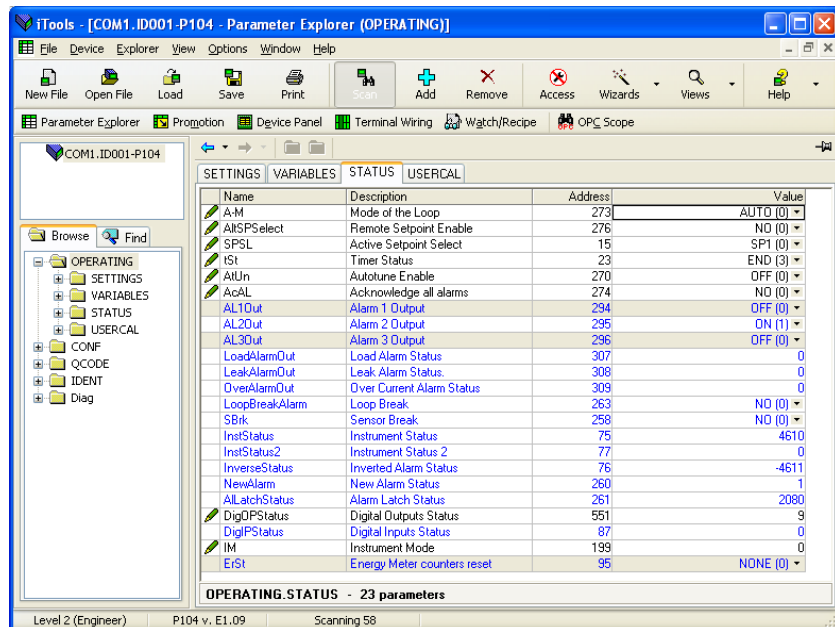

10.5.1.4 User Calibration

USERCAL allows high and low offsets to be made such as those shown in the example in section 4.8.

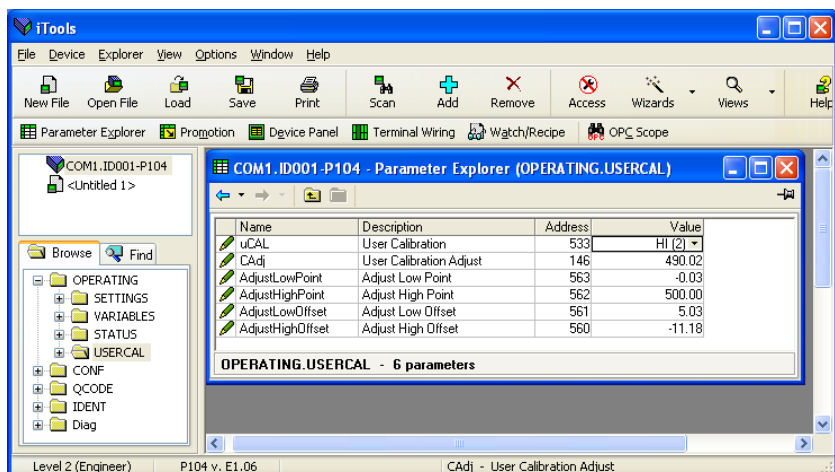

10.5.2 Configuration List

All of the examples listed in previous sections can also be configured directly using the CONF list. Opening the CONF list shows the P codes.

In all cases press  (if necessary) to put the controller into configuration level.

Some typical examples are given in below which configure the controller using the CONF list.

10.5.2.1 Example: To Configure the Sensor Input

In this example the input sensor will be a Type N thermocouple.

Select 'CONF'.

1. In 'P1' select input type N.TC from the drop down.
2. In 'P2', select the number of decimal places for the display, NNN.N.
3. In 'P3', select the minimum range limit. For Type N thermocouple the range can be set between -200.0 and the High Scale Range Value .
4. In 'P4', select the maximum range limit. For Type N thermocouple the range can be set between 1300.0 and the Low Scale Range Value .

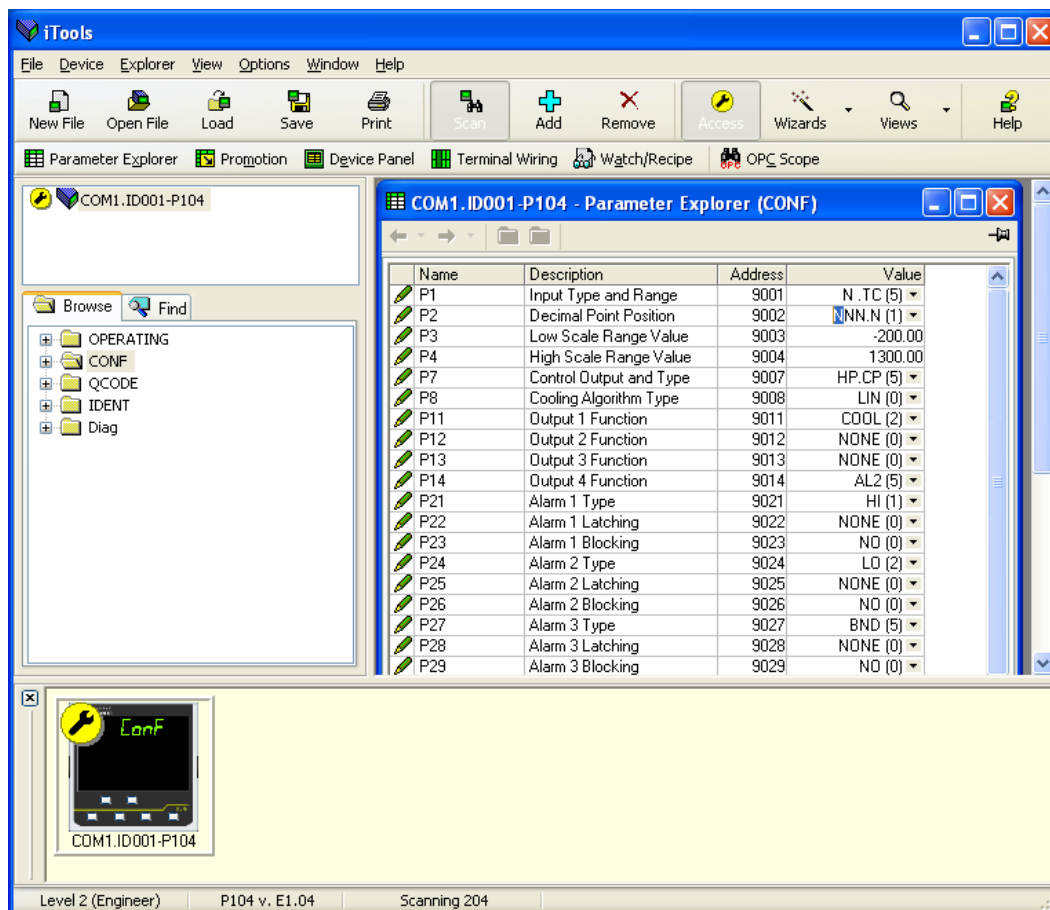

10.5.2.2 Example: To Configure Outputs for Control

In this example the control type will be configured as PID heat and cool. The heat output will be on OP1 and the cool output on OP2.

Select 'CONF'.

1. In 'P7' select control type from the drop down to HP.CP - PID heat, PID cool
2. In 'P8', select the cool algorithm.
3. In 'P11', select Output 1 Function for Heat.
4. In 'P12', select Output 2 Function for Cool.

It is possible to select any of the four outputs OP1, OP2, OP3 or OP4 for control using P11, P12, P13 or P14 respectively.

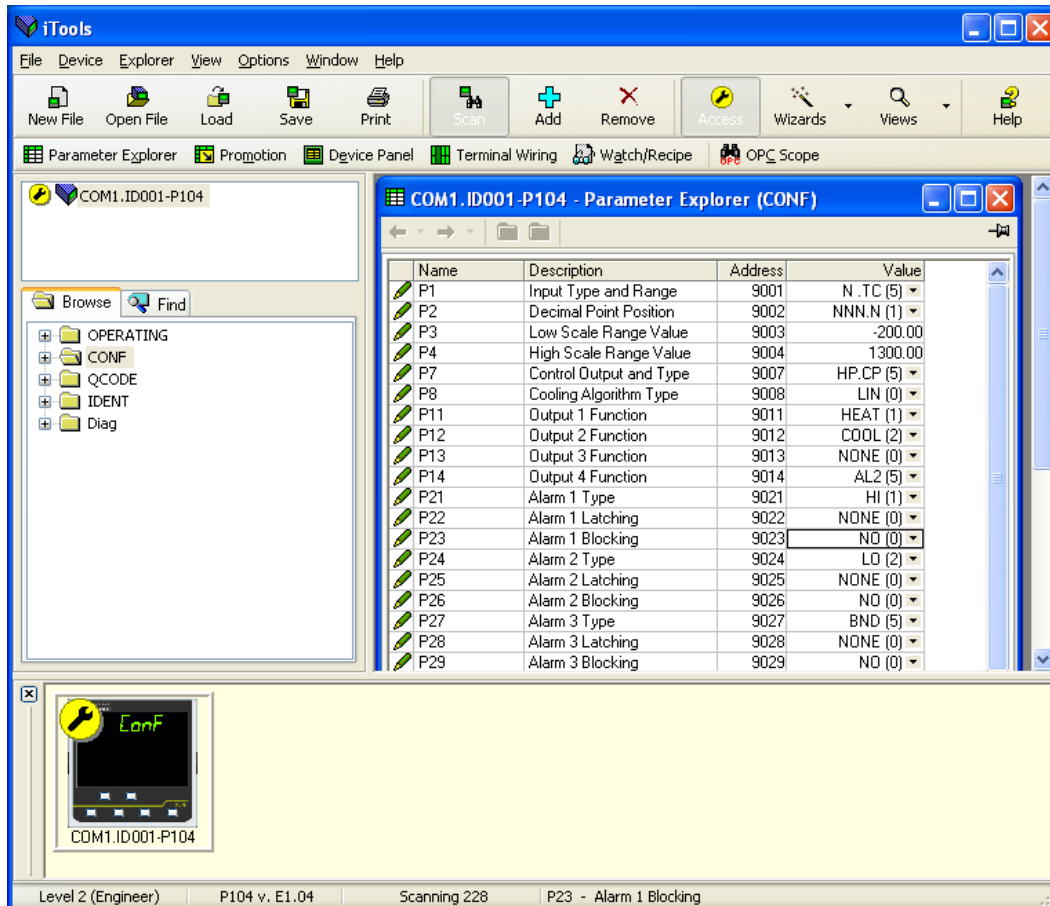

In the above view Output 4 is configured to operate when High Alarm 2 is active.

10.5.2.3 Example: To Configure Alarms

Alarms may be indication only, or they may be required to operate an output.

In this example AL1 will operate OP3, AL2 will operate OP4 and AL3 will be indication only. Select 'CONF'.

1. In 'P13' select AL1 from the drop down to activate OP3.
2. In 'P14', select AL2 from the drop down to activate OP4.
3. In 'P21', select the AL1 alarm type. In this example HI.
4. In 'P22', select the latching type. In this example AUTO.
5. In 'P23', select the blocking type. In this case no blocking (NO).
6. In 'P24', select the AL2 alarm type. In this example LO.
7. In 'P25', select the latching type. In this case NONE.
8. In 'P26', select the blocking type. In this case no blocking (NO).

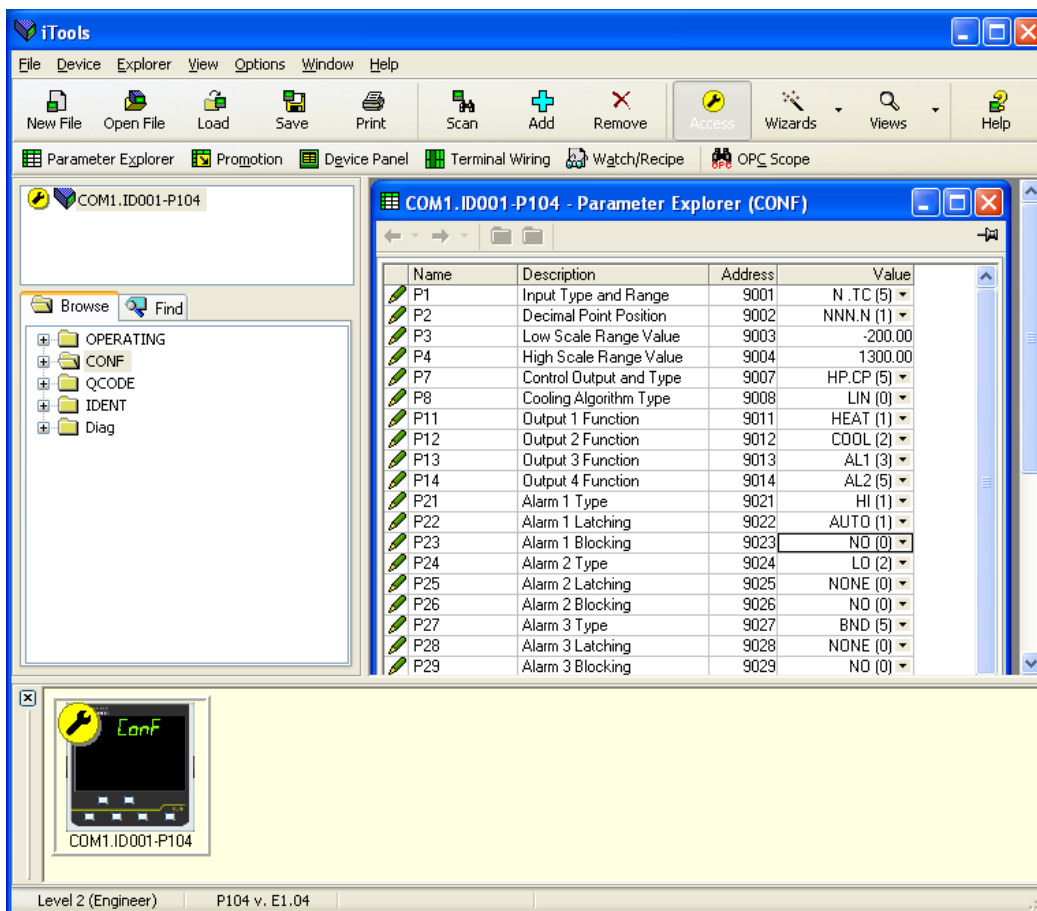

10.5.2.4 Example: To Store and Retrieve Current Settings in the Controller

The current configuration and parameter values can be stored in the controller using the Recovery Point Save 'rEcS' and retrieved using the Recovery Point Load 'rEcL'. This can also be done directly in the controller (section 5.2.22) or through iTools as follows.

Select 'CONF'

1. Select 'rEcS' and 'SAVE' from the drop down list. The parameter shows BUSY followed by DONE. The action is identical to that described in section 5.2.22.

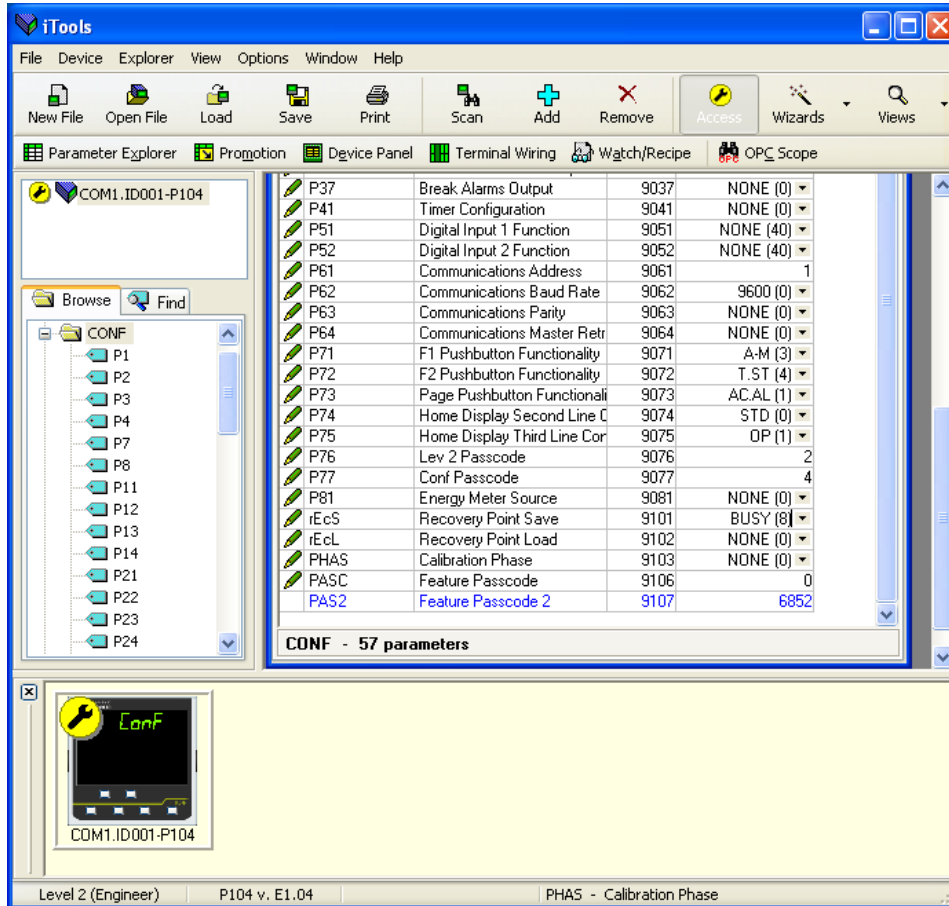

Note: Current configuration and parameter value settings can also be stored to file. This is explained in section 10.7 'Cloning'.

10.5.2.5 To Load Stored Settings in the Controller

1. Press  to put the controller into configuration mode
2. Open the CONF list
3. Select 'rEcL' and 'LOAD' from the drop down list. The parameter shows DONE when the download is successful. The action is identical to that described in section 5.2.22

10.5.2.6 To Return to Factory Settings

It is always possible to return to the settings which were originally loaded when the controller was first supplied.

1. Select 'rEcL' and 'FACT' from the drop down list. The parameter shows DONE when the download is successful. The action is identical to that described in section 5.2.22

10.5.2.7 To Return to Quick Start Configuration

This requires cold start but be aware that this removes all previous configurations in the controller.

1. Select 'rEcL' and 'COLD' from the drop down list. The controller will show Set1 as described in section 4.1.1. The Quick Code configuration may be done in the controller itself or by selecting QCODE in iTools and selecting the required parameter values from the drop down lists.

10.5.3 Summary.

In the 'Diagram' tab, the terminal wiring of the connected controller can be shown together with a list of hardware functions available.

Press  Terminal Wiring

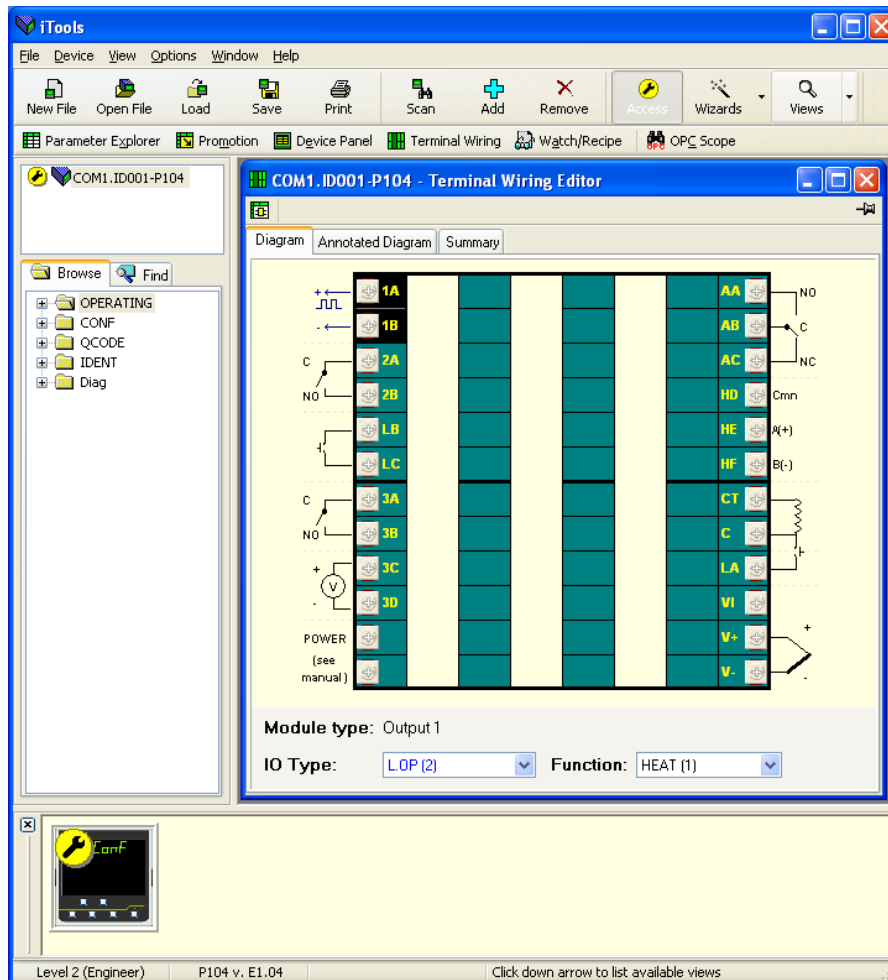

Click on the terminal numbers to show the type of output fitted and its function. The function can be changed using the drop down list. If no function is configured the small diagram showing connections on that output are removed.

A summary of the I/O may be displayed using the 'Summary' tab.

Diagram	Annotated Diagram	Summary	
Module Type		Ident / IOType	Function
Input/Output 1		[IDENT.OP1Type] - L.OP (2)	[CONF.P11] - HEAT (1)
Output 2		[IDENT.OP2Type] - SSR (4)	[CONF.P12] - COOL (2)
Logic Input B		[IDENT.IPBType] - L.IP (1)	[CONF.P52] - NONE (40)
Output 3		[IDENT.OP3Type] - RELY (1)	[CONF.P13] - AL1 (3)
Transmitter Power Supply			
Power Supply			
Output AA		[IDENT.OP4Type] - RELY (1)	[CONF.P14] - AL2 (5)
Digital Comms		[IDENT.CommsType] - R485 (1)	
CT Input		[IDENT.CTType] - CT.IN (1)	
Logic Input A		[IDENT.IPAType] - L.IP (1)	[CONF.P51] - NONE (40)
Sensor Input		[CONF.P1] - N.TC (5)	

This shows the IO fitted together with its function. In the above example the hardware fitted in OP1 is a Logic Output configured to control heating.

10.6 Configurations only available using iTools

There are some features which can only be configured using iTools. For example:



To 'Promote' parameters so that they are available in Level 1 or Levels 1 and 2. They may also be made read only or read/write in the chosen level.

To download Custom Inputs. In addition to the built in standard linearisation tables, custom tables can be downloaded from files.

10.6.1 Example: To Promote Parameters

In this example the parameter 'Alarm 1 Threshold' is to be added to the to the Level 1 list.

Note: the parameter will only be shown if it has been configured, i.e. in this example make sure that Alarm 1 Type \neq none in 'P' code P21.

1. Press  Promotion
2. Select the parameter to be promoted in the 'Promote' tab - Alarm 1 Threshold.
3. In the 'Level' drop down box select Level1 + 2.
4. In the 'Level 1 Access' drop down box select Read/Write or Read Only as required.
5. Press  'Update Device Flash Memory' (Ctrl+F) button to download to the controller.

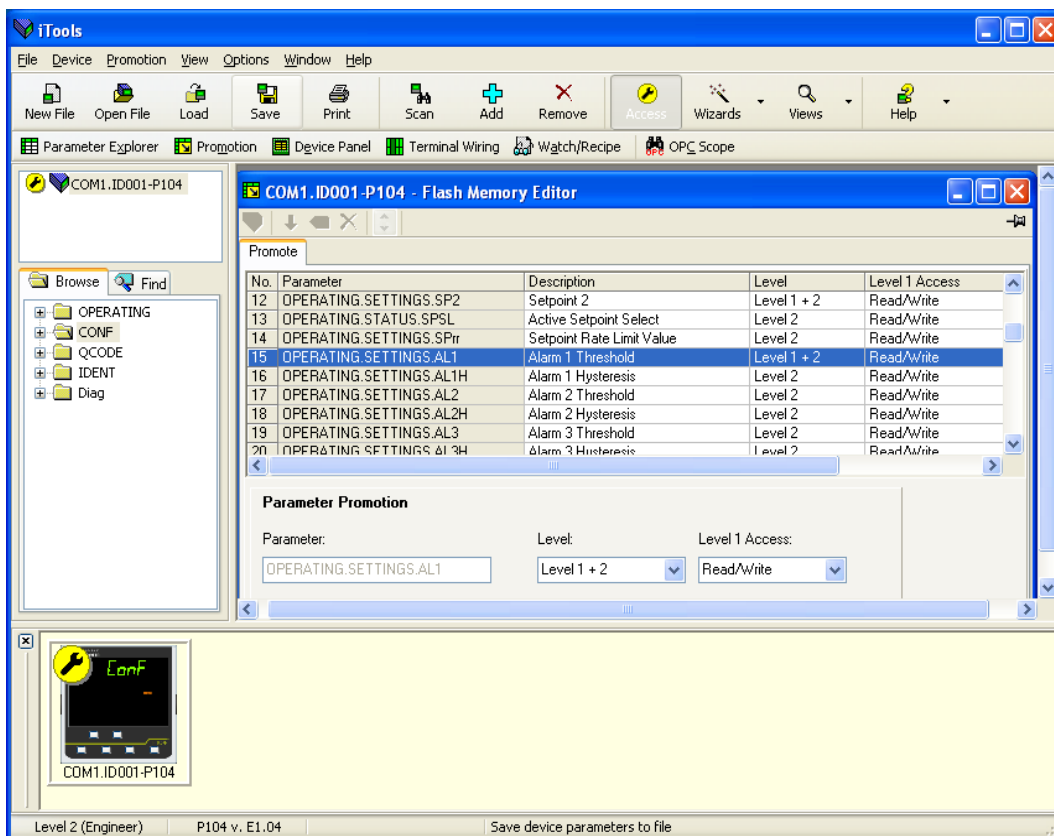

AL1 will now appear in the Level 1 list as well as the Level 2 list and will be read/write according to the selection in the above example.

Repeat for additional parameters.

10.6.2 To Load A Special Linearisation Table

1. Press  Load
2. Select the linearisation table to be loaded from files with the extension .mtb. Linearisation files for different sensor types are supplied with iTools and may be found in Program Files → Eurotherm → iTools → Linearisations → Thermocouple etc.
3. Double click or press Open to download the selected curve

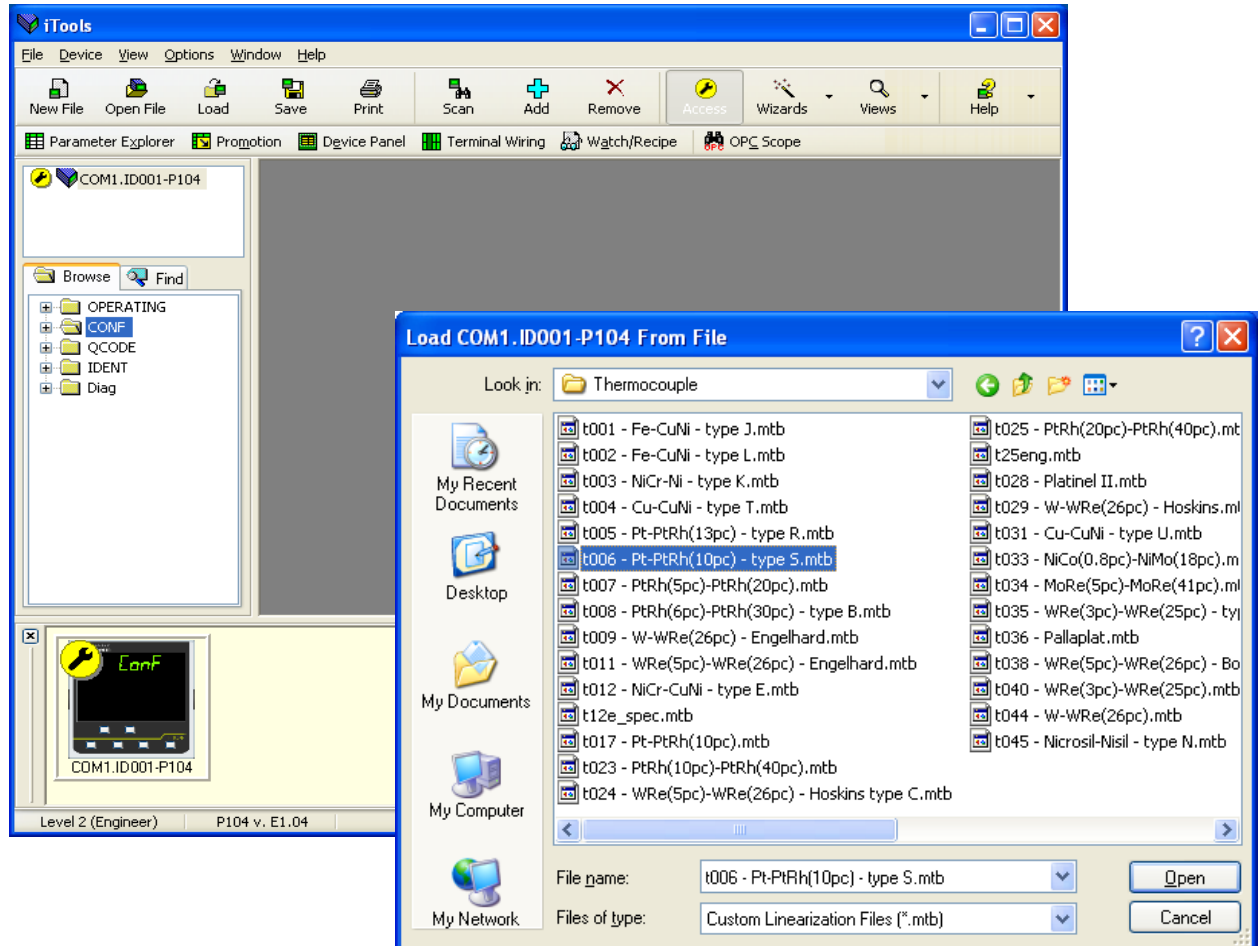

4. In this example a Pt-PtRh(10%) thermocouple has been loaded into the controller.

10.7 Cloning

The cloning feature allows the configuration and parameter settings of one instrument to be copied into another. Alternatively a configuration may be saved to file and this used to download to connected instruments. The feature allows new instruments to be rapidly set up using a known reference source or standard instrument. Every parameter and parameter value is downloaded to the new instrument which means that if the new instrument is used as a replacement it will contain exactly the same information as the original. Cloning is generally only possible if the following applies:

- The target instrument has the same hardware configuration as the source instrument
- The target instrument firmware (i.e. Software built into the instrument) is the same as or a later version than that of the source instrument. The instrument firmware version is displayed on the instrument when power is applied.
- Generally, cloning will copy all operational, engineering and configuration parameters that are writable. **The communications address is not copied.**

Every effort has been made to ensure that the information contained within the clone files is a replica of that configured in the instrument. It is the users responsibility to ensure that the information cloned from one instrument to another is correct for the process to be controlled, and that all parameters are correctly replicated into the target instrument.

Below is a brief description of how to use this feature. Further details are available in the iTools Manual.

10.7.1 Save to File

The configuration of the controller made in the previous sections may be saved as a clone file. This file can then be used to download the configuration to further instruments.

From the File menu use 'Save to File' or use the 'Save' button on the Toolbar.

10.7.2 To Clone a New Controller

Connect the new controller to iTools and Scan to find this instrument as described at the beginning of this chapter.

From the File menu select 'Load Values From File' or select 'Load' from the toolbar. Choose the required file and follow the instruction. The configuration of the original controller will now be transferred to the new controller.

10.7.3 Clone Error

A Message Log is produced during the cloning process. The log may show a message such as 'Cloning of device completed with 1 error'. This can be caused by writing a parameter using iTools which is outside of the resolution of a parameter. For example, the parameter Filter Time Constant is stored in the controller to one decimal place (1.6 seconds by default). If it is entered as an IEEE float value, using iTools, as, say, 1.66 it will be rounded up in the controller to 1.7 seconds. Under these circumstances it is possible that a Clone Error can occur because iTools expects a value of 1.66 and the instrument contains 1.7. Values should, therefore, be entered, when using iTools, within the resolution of the parameter.

This cannot happen from values entered via the front panel but only if entered over communications.

11. Appendix A Factory Default Settings

The following factory default settings are loaded if the controller is ordered pre-configured to order code 'F' - section 1.5.1. These settings are also loaded if Factory Default Data is selected in the Quick Codes - section 4.1.2.

11.1 Factory Default Configuration

P Code	Parameter Description	Default	P Code	Parameter Description	Default
P1	Input type	JEC	P35	Sensor break alarm type	on
P2	Decimal point position	nnnn	P36	Sensor break safe output power	0.0
P3	Low scale range	0.0	P37	Sensor break alarms output	nonE
P4	High scale range	400.0	P41	Timer type	nonE
P5	Linear input low mV	0.0	P42	Timer resolution	Hour
P6	Linear input high mV	80.0	P43	Timer end type	oFF
P7	Control type	HP			
P8	Cooling algorithm	L, n	P51	Logic 1 input function	nonE
P11	Output 1	HEALt	P52	Logic 2 input function	nonE
P12	Output 2	nonE	P61	Digital Comms address	1
P13	Output 3	nonE	P62	Digital Comms baud rate	9600
P14	Output 4	AL2	P63	Digital Comms parity	nonE
P15	DC output range	4-20mA	P64	Digital Comms master/slave	nonE
P16	Retransmission scale low value	0.0			
P17	Retransmission scale high value	400.0	P71	F1 pushbutton functionality	A-m
P21	Alarm 1 type	nonE	P72	F2 pushbutton functionality	t.St
P22	Alarm 1 latching	nonE	P73	Page pushbutton functionality	ALAL
P23	Alarm 1 blocking	no	P74	Content of second line display	Std
P24	Alarm 2 type	Hi	P75	Content of third line display	oP
P25	Alarm 2 latching	nonE	P76	Level 2 passcode	2
P26	Alarm 2 blocking	no	P77	Configuration level passcode	4
P27	Alarm 3 type	nonE			
P28	Alarm 3 latching	nonE	P81	Energy meter source	nonE
P29	Alarm 3 blocking	no	P82	Energy meter nominal load power	0.0
P31	Current transformer source	nonE			
P32	Current transformer range	100.0	rEcS	Recovery point save	nonE
P33	Current transformer alarm latching	nonE	rEcL	Recovery point load	nonE
P34	Loop break alarm time	oFF	PHAS	Calibration phase	nonE

11.2 Factory Default Parameter Settings

Mnemonic	Parameter Description	Default	Mnemonic	Parameter Description	Default
A-n	Loop Mode.	Auto	nr	Manual Reset	0.0
t.St	Timer Status	Reset	r2G	Relative Secondary (Cool) Gain	1.0
ErSt	Energy Counter Reset	None	HYS	Primary Output Hysteresis	1.0
Un,t	Display Units	°C	HYSL	Secondary Output Hysteresis	1.0
SPLo	Setpoint Low Limit.	0.0	dbnd	Dead Band	Off
SPHi	Setpoint High Limit.	400.0	1PLS	Output 1 Minimum Pulse Time	5.0
SP1	Setpoint 1.	0.0	2PLS	Output 2 Minimum Pulse Time	5.0
SP2	Setpoint 2	0.0	3PLS	Output 3 Minimum Pulse Time	5.0
SPSL	Setpoint Select	SP1	4PLS	Output 4 Minimum Pulse Time	5.0
SPrr	Setpoint Rate Limit.	Off	oFS	PV Offset	0.0
AL1	Alarm 1 Setpoint	0.0	F, Lt	PV Input Filter Time.	Off
AL1H	Alarm 1 Hysteresis	1.0	oPLo	Output Low Limit	0.0
AL2	Alarm 2 Setpoint	0.0	oPHi	Output High Limit	100.0
AL2H	Alarm 2 Hysteresis	1.0	LdAL	Load Current Alarm Threshold	Off
AL3	Alarm 3 Setpoint	0.0	LEAL	Leakage Current Alarm Threshold	Off
			HcAL	Overcurrent Alarm Threshold	Off
AL3H	Alarm 3 Hysteresis	1.0	t.dUr	Set Timer Duration	0
AtUn	Auto-Tune Enable.	Off	t.tHr	Timer Start Threshold	Off
Pb	Proportional Band.	20.0	SSSP	Soft Start Setpoint.	0.0
t, i	Integral Time	360.0	SSoP	Soft Start Output Power Limit.	0.0
t.d	Derivative Time	60.0			
cbHi	Cutback High	Auto			
cbLo	Cutback Low	Auto			

12. Appendix B TECHNICAL SPECIFICATION

General				Transmitter PSU (not P116)	
Environmental performance				Isolation	264Vac double insulated
Temperature limits	Operation: 0 to 55°C (32 to 131°F), Storage: -20 to 70°C (-4 to 158°F)			Output Voltage	24Vdc, >28mA, <33mA
Humidity limits	Operation: RH: 0 to 90% non-condensing Storage: RH: 5 to 90% non-condensing			Communications: serial communications option	
Panel sealing	IP66, NEMA Type 12			Protocol	Modbus RTU slave Modbus RTU Master broadcast (1 parameter)
Shock	10 x 15g pulses			Isolation	264Vac double insulated
Vibration	2g peak, 10 to 150Hz			Transmission standard	EIA485 2-wire
Altitude	<2000 metres			Process Variable Input	
Atmospheres	Not suitable for use in explosive or corrosive atmospheres.			Calibration accuracy	<±0.25% of reading ±1LSD ⁽¹⁾
Electromagnetic compatibility (EMC)				Sample rate	4Hz (250mS)
Emissions and immunity	EN61326-1 Suitable for domestic, commercial and light industrial as well as heavy industrial environments. (Class B emissions, Industrial Environment immunity. Low voltage versions are suitable for industrial environments only.			Isolation	264Vac double insulated from the PSU and communications
Electrical safety				Resolution (µV)	< 0.5µV with a 1.6 second filter
(BS EN61010)	Installation category II; Pollution degree 2			Resolution (effective bits)	>17 bits
Installation category II	The rated impulse voltage for equipment on nominal 230V supply is 2500V			Linearisation accuracy	<0.1% of reading
Pollution degree 2	Normally only non conductive pollution occurs. Occasionally, however, a temporary conductivity caused by condensation shall be expected.			Drift with temperature	<50ppm (typical) <100ppm (worst case)
Physical				Common mode rejection	48 - 62 Hz, >120dB
	P116	P108	P104	Series mode rejection	48 - 62 Hz, > 93dB
Panel mounting	1/16 DIN	1/8 DIN	1/4 DIN	Input impedance	100MΩ
Weight grams	250	350	420	Cold junction compensation	>30 to 1 rejection of ambient temperature
Panel cut-out dimensions mm	45 x 45	45 x 92	92 x 92	Cold junction accuracy	<±1°C at 25°C ambient
Panel depth	All 90 mm			Linear (process) input range	-10 to 80mV, 0 to 10V with 100KΩ/806Ω external potential divider module
Operator interface				Thermocouple Types	K, J, N, R, S, B, L, T, C, custom download ⁽²⁾
Type	LED			Resistance thermometer Type	3-wire, Pt100 DIN43760
Main PV display	4 digits green			Bulb current	0.2mA
Secondary display	4 digits amber			Lead compensation	No error for 22 ohms in all 3 leads
Third display	4 digits amber			Input filter	Off to 59.9 seconds
Status beacons	Units, outputs, alarms, active setpoint			Zero offset	User adjustable over the full display range
Power requirements				User calibration	2-point gain & offset
P116	100 to 230Vac, +/-15% 48 to 62Hz, max 6W 24Vac, -15%, +10% 24Vdc, -15%, +20%, ±5% ripple voltage, max 6W			Notes	
P108 and P104	100 to 230Vac, +/-15% 48 to 62Hz, max 9W 24Vac, -15%, +10% 24Vdc, -15%, +20%, ±5% ripple voltage, max 9W			(1) Calibration accuracy quoted over full ambient operating range and for all input linearisation types.	
Approvals				(2) Contact Eurotherm for details of availability of custom downloads for alternative sensors.	
CE, cUL listed (file E57766) Suitable for use in Nadcap and AMS2750D applications under Systems Accuracy Test calibration conditions. EN14597TR Approval Registration number TR1235. Other standards pending.					

OP4 relay		Software features	
Type	Form C (changeover)	Control	
Rating	Min: 100mA @ 12Vdc. Max: 2A @ 264Vac resistive	Number of loops	1
Functions	Control, alarms or events	Loop update	250mS
Current Transformer Input		Control types	PID, ON/OFF,
Input current	0 to 50mA rms 48/62Hz, 10Ω burden resistor fitted inside the module	Cooling types	Linear, fan, oil, water
Calibration accuracy	<1% of reading (typical) <4% of reading (worst case)	Modes	Auto, manual, standby (Off).
Isolation	By using external CT	Overshoot inhibition	High, low
Input impedance	<20Ω	Alarms	
Scale	10, 25, 50 or 100Amps	Number	3
Functions	Partial load failure, SSR fault	Type	Absolute high and low, deviation high, low or band
Digital input (DigIn 1 and 2, 2 not in P116)		Latching	Auto or manual latching, non-latching, event only
Contact	Contact open >600Ω Contact closed <300Ω	Output assignment	Up to three conditions can be assigned to one output
Input current	<13mA	Other Status Outputs	
Isolation	None from PV or system 264Vac double insulated from PSU and communications	Functions	Including sensor break, timer status, loop break, heater diagnostics
Functions	Include alarm acknowledge, SP2 select, manual, keylock, timer functions, standby select, RSP select	Timer	
Logic Output Channels		Modes	Dwell when SP reached. Delayed control action Soft start limits power below PV threshold
Rating	On/High 12Vdc at <44mA Off/Low <300mV at 100μA	Current monitor	
Isolation	None from PV or system 264Vac double insulated from PSU and communications	Alarm types	Partial load failure, over current, SSR short circuit, SSR open circuit
Functions	Control, alarms or events	Indication type	Flashing beacon
Relay Output Channels		Special features	
Type	Form A (normally open)	Features	Energy monitoring, Recovery point
Rating	Min: 12V, 100mA dc Max: 2A, 264Vac resistive		
Functions	Control, alarms or events		
Triac Output Channels			
Rating	0.75A rms 30 to 264V rms (resistive load)		
Isolation	264Vac double insulated		
Functions	Control, alarms or events		
Analogue Output Channels⁽³⁾ (OP2 P116 only)			
Rating	0-20mA into <500Ω		
Accuracy	± (<1% of reading + <100μA)		
Resolution	13.5 bits		
Isolation	264Vac double insulated from PSU and communications.		
Functions	Control, retransmission		
Analogue Output Channels⁽³⁾ (OP3 P108 and P104 only)			
Rating	0-20mA into <500Ω		
Accuracy	± (<0.25% of reading + <50μA)		
Resolution	13.5 bits		
Isolation	264Vac double insulated		
Functions	Control, retransmission		

Note (3) Voltage output can be achieved by external adaptor.

13. Index

Alarms

- Autotune error 31
- Calibration error 31
- EEPROM error 31, 80
- Invalid input type 31
- Leakage current alarm 28
- Load current alarm 28
- Non-vol memory error 31
- Output changed 31
- Overcurrent alarm 28
- Alarms:.. 30, 31, 33, 34, 35, 43, 45, 48, 49, 50, 51, 52, 53, 58, 66, 67, 68, 69, 70, 71, 99
- Ambient temperature 6, 18, 116
- Analogue 13, 14, 44, 48, 49
- Auto mode** 33, 37
- Cleaning 18
- Cloning 110, 114
- Cold Start 23
- Conductive pollution 19
- Configuration 8, 9, 21, 32, 42, 43, 59, 78, 94, 96, 107, 115
- Control Action 77
- Control Type** 42, 46
- Cooling Type** 46, 84
 - Forced air 46
 - Linear 46, 115
 - Oil 46
 - Water 46
- CT input** 15, 17, 52
- Current transformer 15, 52, 92
- DC 13, 14, 43, 50, 115
- DC Output 13, 14, 50
- Decimal Places** 45, 97
- Delayed Switch on 38, 40, 54
- Diagnostic mode 21, 24
- Diagnostic Alarms 31
- Digital communications 16, 43, 56, 79, 80, 81
- Digital Input 8, 9, 15, 55, 63, 80, 101
- Digital inputs**
 - Acknowledge alarm 26, 55, 58
 - Keylock 55
 - Select manual 37, 55
 - Setpoint select 55, 58, 115
 - Standby 55
 - Timer hold 39, 55
 - Timer reset 55
 - Timer run 47, 48, 49, 50, 55
 - Timer run/reset 39, 55
- Dimensions 5
- Dwell 35, 38, 39, 54, 99
- EIA485 16, 56, 63, 78, 85
- Electromagnetic compatibility 18
- Electrostatic 18
- EMC 6, 18, 20
- End 39, 40, 41, 47, 48, 49, 50, 54, 99
- Energy 25, 33, 35, 37, 58, 59, 60, 96, 102, 115, 117
- Error Codes (Diagnostic Alarms) 31
- F1 25, 58, 103
- F2 25, 58, 103
- Fuse 11
- Grounding 20
- High Range Limit** 33, 45, 97
- Humidity 6, 18
- Input 12, 15, 43, 44, 45, 55, 63, 86, 87, 88, 89, 90, 96, 102
- Input filter 35
- Input Type**
 - 0-20mA 44, 50
 - 4-20mA 44, 50
 - Pt100 42, 44
 - Type mV 12, 36, 43, 45, 61, 86, 87, 88, 89, 90, 97, 115
- Input/Output 63
- Installation 5, 6, 18, 19, 20
- Integral 34, 65, 115
- Internet Site**
 - UK 6, 78, 81, 94
- Isolation Boundaries 11
- Latching ears 6
- Leakage Current 28, 35, 83, 115
- Level 1 24, 25, 36, 112
 - Level 1 Parameters
 - Alarm acknowledge 25, 26, 33, 55, 58
 - Current setpoint 25, 33
 - Energy counter partial value 25
 - Energy counter total value 25
 - Output power 25
 - Setpoint 1 value 25, 29, 33, 41, 58, 96
 - Setpoint 2 value 25, 29, 33, 96
 - Status of timer 25, 33, 39, 40, 41, 58
 - Time elapsed 25
 - Time remaining 25, 39, 40, 41, 59
 - Level 2 Parameters
 - Alarm 1 Hysteresis 34, 82
 - Alarm 1 Setpoint 26, 27, 34, 109
 - Alarm 2 Hysteresis 34, 82
 - Alarm 2 Setpoint 26, 34, 109
 - Alarm 3 Hysteresis 34, 82
 - Alarm 3 Setpoint 26, 34, 109
 - Alarm Acknowledge 25, 26, 33, 55, 58
 - Auto-Tune Enable 34, 71
 - Calibration Adjust 35
 - Current setpoint 25, 33
 - Cutback High 34
 - Cutback Low 34
 - Dead Band 34, 70
 - Derivative Time 28, 34, 68, 71
 - Display Units 33, 84
 - Energy Counter Partial Value 33, 35
 - Energy Counter Reset 33
 - Energy Counter Total Value 25, 33, 35, 37, 59, 60
 - Integral Time 34, 65, 75
 - Leak Current 26, 28, 35, 53
 - Leakage Current Alarm Threshold 26, 28, 35, 53
 - Load Current 26, 28, 35, 53
 - Load Current Alarm Threshold 26, 28, 35, 53, 83, 115
 - Loop Mode 33, 58
 - Manual Reset 34, 67
 - Output 1 Minimum Pulse Time 13, 34
 - Output 2 Minimum Pulse Time 34
 - Output 3 Minimum Pulse Time 34
 - Output 4 Minimum Pulse Time 34
 - Output High Limit 35, 48, 49, 70
 - Output Low Limit 35, 48, 49, 70
 - Output power 25, 33, 35, 48, 49, 57, 59
 - Overcurrent Alarm Threshold 26, 28, 35
 - Primary Output Hysteresis 34
 - Proportional Band 28, 34, 68
 - PV Input Filter Time 35, 70
 - PV Offset 35
 - Relative Secondary (Cool) Gain 34, 66
 - Secondary Output Hysteresis 34, 83
 - Set Timer Duration 35, 39, 40, 41, 84
 - Setpoint 1 33, 38, 96
 - Setpoint 2 33, 38, 54
 - Setpoint High Limit 33
 - Setpoint Low Limit 33
 - Setpoint Rate Limit 33
 - Setpoint Select 33, 55, 58
 - Soft Start Output Power Limit 35, 41, 54
 - Soft Start Setpoint 35, 41, 54
 - Time Elapsed 35, 39, 40, 41, 59
 - Time Remaining 25, 35, 39, 40, 41, 59
 - Timer Start Threshold 35, 39, 40, 41
 - Timer Status 25, 33, 39, 40, 41, 58
 - User Calibration 35, 36
 - Linear 12, 45, 97
 - Load Current 28, 35, 83
 - Logic 10, 12, 13, 17, 19, 47, 48, 50, 63
 - Low Range Limit** 33, 45, 97
 - Manual 25, 27, 33, 34, 37, 55, 58, 59, 67, 75
 - Manual mode** 33, 37, 59
 - Modbus 16, 56, 57, 78, 79
 - Mounting 6
 - Off mode** 25, 37, 58
 - Order Code 7, 22
 - Overcurrent 19, 26, 28, 35
 - Over-temperature 20
 - P Codes 97
 - Panel 6
 - panel retaining clips 6
 - Passcodes 59, 96
 - Personnel 19

Pollution.....	19	Spacing.....	6
Power Supply.....	11, 15	Start up.....	21, 23, 24, 96
Protective cover.....	6	Terminal.....	10, 63, 78, 96
Quick Configuration.....	5, 21, 23, 61	Terminals.....	11, 12
Quick Start Code.....	8, 21, 22, 23	Thermocouple.....	12, 44, 87, 88, 89, 113
Recovery Point.....	61, 96, 110	Type b – b.tc.....	44
Relay.....	10, 13, 14, 34, 47, 48, 49, 50, 63	Type C – C.tc.....	44
Reset.....	25, 27, 33, 37, 38, 51, 52, 54, 55, 102	Type J – J.tc.....	44
Resistor.....	5, 12, 14, 15, 44	Type k – cA.tc.....	44
Retransmission.....	2, 43, 50, 57, 63, 79, 96	Type L – L.tc.....	44
RS485.....	16, 56, 63, 78	Type n – n.tc.....	44
RTD.....	12, 44, 86, 87, 90	Type r – r.tc.....	44
Run.....	38, 40, 47, 48, 49, 50, 55, 63	Type S – S.tc.....	44
Safety.....	17, 18, 19	Type t – t.tc.....	44
Scroll.....	36, 61, 71	Transmitter.....	12, 15
Sensor Input.....	12, 97, 107	Triac.....	10, 13, 48, 63, 85
Setpoint 'SP'.....	25	Tuning.....	3, 34, 69, 71, 74, 75
Sleeve.....	5, 6	User calibration.....	36
snubber.....	5, 14	Wire Sizes.....	11
Soft Start.....	35, 38, 41, 54, 84, 100	Wiring.....	10, 17, 19, 81
		Zener barriers.....	12

International sales and support
Eurotherm:
ERO Electronic:

www.eurotherm.com
www.eroelectronic.com

Contact Information

Eurotherm Head Office

Faraday Close,
Durrington,
Worthing, West Sussex,
BN13 3PL

Sales Enquiries

T +44 (01903) 695888
F 0845 130 9936

General Enquiries

T +44 (01903) 268500
F 0845 265982

ERO Electronic

Via XXIV Maggio, 2
22070 Guanzate (CO)
Italy

Sales Enquiries

sales@eroelectronic.com

General Enquiries

T +39 031 975 111
F +39 031 977 512

Worldwide Offices

www.eurotherm.com/global



Scan for local contacts

Represented by:

©Copyright Invensys Eurotherm Limited 2015

Invensys, Eurotherm, the Eurotherm logo, Chessell, EurothermSuite, Mini8, Eycon, Eyris, EPower, EPack nanodac, piccolo, versadac, optivis, Foxboro, and Wonderware are trademarks of Invensys plc, its subsidiaries and affiliates. All other brands may be trademarks of their respective owners.

All rights are strictly reserved. No part of this document may be reproduced, modified or transmitted in any form by any means, neither may it be stored in a retrieval system other than for the purpose to act as an aid in operating the equipment to which the document relates, without the prior written permission of Invensys Eurotherm Limited.

Eurotherm Limited pursues a policy of continuous development and product improvement. The specifications in this document may therefore be changed without notice. The information in this document is given in good faith, but is intended for guidance only.

Eurotherm Limited will accept no responsibility for any losses arising from errors in this document.

invensys
Operations Management