

Compact SCR Power Controller

EPack Single Phase

(Firmware version 6)

HA033538 Issue 02

03/2021



Eurotherm[®]

by **Schneider** Electric

Legal Information

The information provided in this documentation contains general descriptions and/or technical characteristics of the performance of the products contained herein. This documentation is not intended as a substitute for and is not to be used for determining suitability or reliability of these products for specific user applications. It is the duty of any such user or integrator to perform the appropriate and complete risk analysis, evaluation and testing of the products with respect to the relevant specific application or use thereof. Eurotherm Limited, Schneider Electric or any of its affiliates or subsidiaries shall not be responsible or liable for misuse of the information contained herein.

If you have any suggestions for improvements or amendments or have found errors in this publication, please notify us.

You agree not to reproduce, other than for your own personal, non-commercial use, all or part of this document on any medium whatsoever without permission of Eurotherm Limited, given in writing. You also agree not to establish any hypertext links to this document or its content. Eurotherm Limited does not grant any right or license for the personal and non-commercial use of the document or its content, except for a non-exclusive license to consult it on an "as-is" basis, at your own risk. All other rights are reserved.

All pertinent state, regional, and local safety regulations must be observed when installing and using this product. For reasons of safety and to help ensure compliance with documented system data, only the manufacturer should perform repairs to components.

When devices are used for applications with technical safety requirements, the relevant instructions must be followed.

Failure to use Eurotherm Limited software or approved software with our hardware products may result in injury, harm, or improper operating results.

Failure to observe this information can result in injury or equipment damage.

Eurotherm, EurothermSuite, ECAT, EFit, EPack, EPower, Eycon, Eyris, Chessell, Mini8, nanodac, optivis, piccolo and versadac are trademarks of Eurotherm Limited SE, its subsidiaries and affiliated companies. All other trademarks are the property of their respective owners.

© 2021 Eurotherm Limited. All rights reserved.

Table of Contents

- Table of Contents5
- Safety Information12
 - Important Information..... 12
- Safety Notes13
 - Reasonable use and responsibility 17
 - SELV 17
 - Symbols Used in the Instrument Labeling..... 18
 - Hazardous Substances 18
 - Cybersecurity 19
 - Introduction 19
 - Cybersecurity Good Practices 19
 - Comms Port and Channel Enabled by Default 19
 - Comms Port and Channel Disabled by Default 20
 - Achilles® Communications Certification 20
- Introduction21
 - Unpacking the Units 21
 - Order Code 22
 - Short-Wave Infrared Resistor (SWIR)..... 23
 - Basic Product Coding 25
 - Software Upgrade Options..... 26
- Installation28
 - Mechanical Installation 28
 - Mounting details 28
 - Mechanical installation requirements 29
 - Mounted clearance dimensions 30
 - Bulkhead Mounting 31
 - DIN Rail Mounting..... 31
 - Dimensions 33
 - 16A to 32A unit dimensions 33
 - 40A to 63A unit dimensions 34
 - 80A to 100A unit dimensions 35
 - 125A unit dimensions 36
 - Electrical Installation 37
 - Connection Details 38
 - Auxiliary supply 40
 - 24V ac/dc auxiliary supply 41
 - 85 to 550Vac auxiliary supply 41
 - Connections (Supply Power and Load) 43
 - 16A to 32A and 40A to 63A Units 45
 - 80A to 125A units 46
 - Signal wiring..... 47
 - Firing Enable..... 47
 - Alarm Acknowledge 47
 - Main Setpoint..... 48
 - Relay Output..... 48
 - I/O Input & Output Details 49
 - Network Communications 50
 - Ethernet Wiring 50
 - Communications Pinouts 50
 - Communications startup 50
 - Fuse Holders Contact Data (Fuse Ordering Code HSM)..... 53
- Operator Interface55
 - Display 55

- Status area..... 55
- Softkey icons..... 56
- Pushbuttons 57
 - Pushbutton functions 57
 - Menu item value selection 57
- Front Panel Event Indication 58
 - Instrument events 58
 - Indication alarms..... 58
 - System alarms 58
 - Process alarms 58
- Quickcode 59**
 - Quickcode Menu Parameters Description..... 60
 - Firing modes definitions 62
 - Logic 62
 - Burst Fixed Firing..... 62
 - Burst Variable Firing..... 63
 - Phase Angle Control 63
 - Intelligent Half-Cycle (IHC) Mode 63
 - 50% Duty Cycle 64
 - 33% Duty Cycle 64
 - 66% Duty Cycle 64
 - Feedback type 65
 - Transfer Mode..... 65
 - Limitation features..... 65
 - Firing Angle Limiting (in Phase Angle mode) 66
 - Firing Angle Limiting (in Burst mode) 66
 - Duty Cycle Limiting (in Burst mode) 66
 - Chop Off Definition..... 67
- Communications 69**
 - Field Device Tool (FDT) and Device Type Manager (DTM) Support..... 69
 - EtherNet/IP..... 71
 - Introduction 71
 - EPack Power Controller EtherNet/IP Features 72
 - CIP Object Support 73
 - Setting Up the EPack Power Controller Unit..... 73
 - Dynamic IP Addressing 74
 - Fixed IP Addressing 74
 - Default Gateway 75
 - Data Exchange Mapping..... 75
 - Configuring the Cyclic (Implicit) Data Exchange..... 76
 - Setting Up The Master 78
 - Cyclic (Implicit) Data Exchange 78
 - Establishing Communications 84
 - Data Formats 84
 - The EDS File..... 85
 - Troubleshooting 85
 - Modbus 86
 - Overview 86
 - Protocol Basics 86
 - Parameter Resolution 87
 - Reading of Large Numbers..... 88
 - Wait Period..... 88
 - Latency 88
 - Configuration Mode Parameters 88
 - Modbus Advanced Topics 89
 - Access to Full Resolution Floating Point and Timing Data 89
 - Data Types Used In EPack Power Controller Units 90
 - Enumerated, Status Word, and Integer parameters 90
 - Floating Point Parameters 90
 - Time Type Parameters..... 91
 - Ethernet (Modbus TCP) 92

- Instrument setup 92
- Dynamic IP Addressing 92
- Fixed IP Addressing 93
- Default Gateway 93
- Preferred Master 93
- iTools Setup 93
 - Automatic Configuration 93
 - Manual Configuration 94
- PROFINET 95
 - PROFINET Features 95
 - PROFINET Wiring 96
 - iTools Connection 97
 - Setting up the E-Pack Controller for PROFINET 97
 - Commissioning using DCP protocol 97
 - Commissioning using 'Fixed' IP Mode' 99
 - Setting up the IP configuration via iTools 99
 - Device Name 99
 - Device Name via the DCP protocol 99
 - Display of the Device Name on the E-Pack screen 100
 - Display of the Device Name in iTools 100
 - Other DCP Services 100
 - Flash LED (also called "Flash Once") 100
 - Reset to factory 100
 - E-Pack PN Modules 101
 - Commissioning directly 'out-of-the-box' 101
 - List of the standard PROFINET Modules used by E-Pack 101
 - Fieldbus I/O Gateway IOGW Modules (Generic Modules) 102
 - Reduced Fieldbus I/O Gateway RIOGW Modules (Generic Module) 103
 - E-Pack PROFINET Slots 104
 - General E-Pack's Slot organization 104
 - Configuring the Cyclic (IO Data) Data Exchange 104
 - Acyclic Data Exchange (Record Data) 105
 - PROFINET Acyclic Readings 106
 - Acyclic data exchanges, Step 7 (TIA Portal) program block 107
 - Data Formats 108
 - The GSD File 108
 - Alarm Notification 109
- Configuration from the Front Panel 113**
 - Menu Pages 114
 - Comms menu 114
 - Meas menu 116
 - Strat menu 117
 - Adjust menu 119
 - PLF menu 122
 - Info menu 123
 - Alarms menu 124
 - Alm Disable menu 125
 - Alm Latch Menu 126
 - Alm Stop menu 127
 - Alm Relay menu 128
 - DI Stat menu 129
 - PLF Adjust menu 129
 - Settings menu 130
 - Access menu 131
 - Access to Menus 132
- Configuration using iTools 133**
 - Introduction 133
 - Overview 133
 - Access Menu 134
 - Alarm Configuration 136
 - Communications Configuration 137

Control Configuration	140
Control setup menu.....	141
Parameters	141
Control Main menu.....	142
Parameters	142
Control limit configuration	143
Parameters	143
Control diagnostic menu	144
Parameters	144
Control Alarm disable menu	144
Parameters	144
Control Alarm Detection Parameters	145
Parameters	145
Control Alarm signaling parameters	145
Parameters	145
Control Alarm Latch parameters	146
Parameters	146
Control Alarm Acknowledgement parameters	146
Parameters	146
Control Alarm Stop parameters.....	147
Parameters	147
AlmRelay, Control Alarm Relay	147
Parameters	147
Counter Configuration.....	148
Parameters	148
Cascading Counters	149
Energy Configuration	150
Parameters	150
Resolution	151
Fault Detection Menu	152
Parameters	152
Firing Output Menu	154
Examples	155
Safety Ramps, Soft Start and Delayed Trigger, firing types.....	155
Input/Output (IO) Configuration.....	157
Analog Input configuration	158
Ai Main	158
AlmDis	159
AlmDet	159
AlmSig	159
AlmLat.....	159
AlmAck.....	159
AlmStop	160
AlmRelay	160
Digital Input configuration	161
Parameters	161
Relay status	162
Parameters	162
Instrument Configuration Menu.....	163
Instrument Display configuration.....	163
Parameters	163
Instrument Hardware configuration.....	164
Parameters	164
Instrument options	165
Parameters	165
Scaling Factor	166
SetProv Example	166
IP Monitor Configuration	167
Parameters	167
Lgc2 (Two Input Logic Operator) Menu	168
Lgc2 Parameters.....	168
Lgc8 (Eight-input Logic Operator) Configuration.....	170
Parameters	170

- LGC8 schematic 171
- Invert input decoding table 172
- LIN16 Input Linearization 173
 - Compensation for Sensor Non-Linearities 174
 - Input Linearization Parameters 175
- Math2 Menu 176
 - Math2 Parameters 176
- Modulator Configuration 178
 - Modulator parameters 178
- Network Configuration 179
 - Network Meas Menu 180
 - Parameters 180
 - Network Setup configuration 182
 - Parameters 182
 - Network Alarms 184
 - AlmDis 184
 - Network AlmDet Submenu 184
 - Network Almsig Submenu 184
 - Network AlmLat Submenu 184
 - Network Almack Submenu 185
 - Network Almstop Submenu 185
 - Network Almrelay Submenu 185
- Qcode 186
 - Parameters 186
- Setprov Configuration Menu 187
 - Setpoint provider parameters 187
- Timer Configuration 189
 - Parameters 189
 - Timer examples 190
- Totalizer Configuration 191
 - Parameters 191
- User Value Configuration Menu 192
 - User Value parameters 192
- Using iTools 193**
 - iTools connection 193
 - Automatic detection 193
 - Ethernet (Modbus TCP) communications 194
 - Direct Connection 197
 - Wiring 197
 - Scanning for Instruments 199
 - Graphical Wiring Editor 200
 - Toolbar 201
 - Wiring Editor Operating Details 201
 - Component Selection 201
 - Block Execution Order 202
 - Function Blocks 202
 - Wires 205
 - Wire Colors 207
 - Thick Wires 207
 - Comments 207
 - Monitors 208
 - Downloading 209
 - Colors 209
 - Diagram Context Menu 210
 - Compounds 211
 - Tool Tips 212
 - Parameter Explorer 213
 - Parameter Explorer Detail 214
 - Explorer Tools 215
 - Context Menu 215
 - Fieldbus Gateway 216
 - Watch/Recipe Editor 219

- Creating a Watch List..... 219
 - Adding Parameters to the Watch List 219
 - Data Set Creation 220
- Watch Recipe Toolbar Icons 221
- Watch/Recipe Context Menu 221
- Parameter Addresses (Modbus) 222**
 - Introduction 222
 - Parameter Types 222
 - Parameter Scaling..... 222
 - Parameter List..... 223
- Alarms 224**
 - Global System Monitoring 224
 - System Alarms 225
 - Missing mains 225
 - Thyristor short circuit..... 225
 - Over temperature 225
 - Network dips 225
 - Mains frequency fault detected 225
 - Chop Off alarm..... 225
 - Process Alarms 226
 - Total Load Failure (TLF) 226
 - Closed Loop alarm 226
 - External input alarm 226
 - Over current detection 226
 - Over Voltage Alarm 226
 - Under Voltage Alarm 226
 - Partial Load Failure (PLF)..... 227
 - Indication Alarms 227
 - Load Over-Current 227
- Maintenance 229**
 - Precautions 229
 - Reasonable use and responsibility 229
 - Preventive Maintenance..... 230
 - Fusing 231
 - Fuse Holders Contacts Kit 233
 - Fuse holder dimensions..... 234
 - Auxiliary supply fuse protection 238
 - Instrument upgrade 240
 - iTools upgrade..... 240
 - Firmware upgrade..... 241
 - Software upgrade..... 241
 - Obtaining a Passcode via Telephone..... 241
 - Obtaining a Passcode via iTools 242
 - EPack Licence Notice 243

Technical Specification	244
Standards.....	244
Installation Categories	244
Specification.....	245
Auxiliary supply	245
Power.....	246
Physical	246
Environment.....	246
Operator Interface.....	251
Inputs/Outputs	251
Digital Inputs	252
Relay Specification	253
Fuse Holders Contacts Kit Specification.....	253
Mains Network Measurements	254
Communications	254

Safety Information

Important Information

Read these instructions carefully and look at the equipment to become familiar with the device before trying to install, operate, service, or maintain it. The following special messages may appear throughout this manual or on the equipment to warn of potential hazards or to call attention to information that clarifies or simplifies a procedure.





The addition of either symbol to a “Danger” or “Warning” safety label indicates that an electrical hazard exists which will result in personal injury if the instructions are not followed.



This is the safety alert symbol. It is used to alert you to potential personal injury hazards. Obey all safety messages that follow this symbol to avoid possible injury or death.

 DANGER
DANGER indicates a hazardous situation which, if not avoided, will result in death or serious injury.

 WARNING
WARNING indicates a hazardous situation which, if not avoided, could result in death or serious injury.

 CAUTION
CAUTION indicates a hazardous situation which, if not avoided, could result in minor or moderate injury.

NOTICE
NOTICE is used to address practices not related to physical injury.

Safety Notes

DANGER

HAZARD OF ELECTRICAL SHOCK, EXPLOSION OR ARC FLASH

- Apply appropriate personal protective equipment (PPE) and follow safe electrical work practices. See applicable national standards e.g. NFPA70E, CSA Z462, BS 7671, NFC 18-510.
- This equipment must only be installed and serviced by qualified electrical personnel.
- Refer to manual for installation and servicing.
- The product is not suitable for isolation applications, within the meaning of EN60947-1. Turn off all power supplying this equipment before working on the loads of the equipment.
- Turn off all power supplying this equipment before working on equipment.
- Always use a properly rated voltage sensing device to confirm power is off.
- If on receipt, the unit or any part within is damaged, do not install but contact your supplier.
- Do not disassemble, repair or modify the equipment. Contact your supplier for repair.
- This product must be installed, connected and used in compliance with prevailing standards and/or installation regulations.
- Do not exceed the device's ratings.
- The unit must be installed in an enclosure or cabinet connected to the protective earth ground.
- Electrically conductive pollution must be excluded from the cabinet in which the product is mounted.
- Do not allow anything to fall through the case apertures and ingress the product.
- Before any other connection is made, the protective earth ground terminal must be connected to a protective conductor.
- Protective conductor must be sized in compliance with local and national regulatory requirements.
- Tighten all connections in conformance with the torque specifications. Periodic inspections are required.
- High speed fuses (supplemental fuses in addition to branch circuit protective device), as listed in fusing sections, are mandatory to protect EPack against load short circuit.
- If opening of either the branch circuit protective device or the high-speed fuses (supplemental fuses) occurs, the product must be examined by suitably qualified personnel and replaced if damaged.
- A High-speed fuse (supplemental fuses in addition to branch circuit protective device) or a double protection fuse as listed in fusing sections is mandatory for 85Vac to 550Vac auxiliary supply.
- If opening of any fuses or branch circuit protection device that supply the 85Vac to 550Vac auxiliary supply occurs, first check the wiring. If the wiring is not damaged, do not replace the fuse and contact the manufacturer's local service center.
- The maximum voltage between any pole of the 85Vac to 550Vac auxiliary supply and all other terminals must be lower than 550Vac.
- The "24V auxiliary supply" is an SELV circuit. The supply Voltage must be derived from a SELV or PELV circuit.
- The I/O Input & Output, the Communications ports are SELV circuit. They must be connected to SELV or PELV circuit.

Failure to follow these instructions will result in death or serious injury.

 **DANGER****HAZARD OF ELECTRICAL SHOCK, EXPLOSION OR ARC FLASH**

- The relay output and the fuse holders contacts are compliant to the SELV requirements; they can be connected to SELV, PELV circuit or to voltage up to 230V (maximum value of rated operational voltage to earth:230V)
- Ensure all cables and wiring harness are secured using a relevant strain relief mechanism.
- Respect electrical installation requirements to ensure optimum IP rating.
- Close doors and plug-in terminals before turning on power to this equipment.
- Use appropriate safety interlocks where personnel and/or equipment hazards exist.

Failure to follow these instructions will result in death or serious injury.

 **DANGER****HAZARD OF FIRE**

- WITHOUT Current limit function by phase angle reduction, if SWIR (Infrared) is NOT selected as Heater type, select the product current rating greater than or equal to the MAXIMUM current of the load.
- WITH Current limit function by phase angle reduction, select the product current rating greater than or equal to the nominal current of the load.
- Setting of current limit function by phase angle reduction must be lower or equal to product current rating.
- The current limit function by phase angle reduction is not available with Intelligent Half Cycle (IHC), Select the product current rating greater than or equal to the MAXIMUM current of the load.
- Duty cycle current limiting features (in burst mode), does not limit the peak current value. Select the product current rating greater than or equal to the MAXIMUM current of the load.
- With SWIR Load, if a fast response time is required, or if IHC firing mode has been selected, select SWIR (Infrared) as Heater type.
- If SWIR is selected as Heater type, select the product current rating greater than or equal to 125% of MAXIMUM current of the SWIR load WITHOUT taking in account the inrush current
- If SWIR is selected as Heater type, adjust the duration of the safety ramp (SafetyRamp), the cooling time of the load (SWIRLoadCoolingTime) and the value of SWIR Load Cooling Threshold, to limit the RMS load inrush current SWIR to less than 2.5 times the product current rating.
- This product does not contain any branch-circuit protection, the installer must add branch-circuit protection upstream of the unit.
- Branch circuit protection must be selected according to maximum current in each phase and must be rated in compliance with local and national regulatory requirements.
- Power connections: The cables must be rated 90°C stranded copper only, the cross section must be selected according to the branch circuit protection rating.
- The cables used to connect the EPack's auxiliary supply and voltage reference must be protected by branch-circuit protection. Such branch-circuit protection must comply with local and national regulatory requirements.
- Connection of two conductors in the same terminal is not permitted, partial or total loss of connection may create an overheat of the terminals.
- The conductor stripping length must be as stated in electrical installation.
- Respect mechanical installation requirements to allow heatsink to dissipate power.
- At commissioning ensure that under maximum load condition, the ambient temperature of the product will not exceed the limit stated in that manual.
- Heat-sink must be cleaned regularly. Periodicity depends on the local environment, but should not exceed 1 year.

Failure to follow these instructions will result in death or serious injury.

 **WARNING****UNINTENDED EQUIPMENT OPERATION**

- Do not use the product for critical control or protection applications where human or equipment safety relies on the operation of the control circuit.
- Signal and power voltage wiring must be kept separate from one another. Where this is impractical, all wires must be rated to the power voltage & shielded cables are recommended for signal wiring.
- This product has been designed for environment A (Industrial). Use of this product in environment B (domestic, commercial and light industrial) may cause unwanted electromagnetic disturbances in which cases the installer may be required to take adequate mitigation measures.
- For Electromagnetic Compatibility, panel or DIN rail to which product is attached must be grounded.
- Observe all electrostatic discharge precautions before handling the unit.
- At commissioning, ensure correct product configuration.
- Ensure physical access to the product is restricted to authorized people only.
- At commissioning, ensure cybersecurity robustness of the installation.

Failure to follow these instructions can result in death, serious injury or equipment damage.

 **CAUTION****HOT SURFACE RISK OF BURNS**

- Allow heatsink to cool before servicing.
- Do not allow flammable or heat-sensitive parts in the immediate vicinity of heatsink.

Failure to follow these instructions can result in injury or equipment damage.

NOTICE**UNINTENDED EQUIPMENT OPERATION**

- When ordering the product, select the appropriate communication protocol or make sure it is available as a software upgrade option.
- Non-volatile memory must not be accessed in write mode more than 10,000 times during the whole lifetime of the product.

Failure to follow these instructions can result in non-functional equipment.

NOTICE**NORTH AMERICA REGULATIONS**

- For USA & Canada EPack 125A fuse holder terminal capacity is rated UL 1/0AWG, this may decrease the maximum Load current according to standard, ambient temperature, wiring arrangement.

Failure to follow these instructions can result in non-compliance to North America regulations.

Reasonable use and responsibility

The information contained in this manual is subject to change without notice. While every effort has been made to ensure the accuracy of the information, your supplier shall not be held liable for errors contained herein.

EPack is an “AC semiconductor controller for non-motor loads” designed according to IEC60947-4-3 & UL60947-4-1, it meets the requirements of the Low voltage and EMC European Directives which covers safety and EMC aspects.

Use in other applications, or failure to observe the installation instructions of this manual may impair safety or EMC.

The safety and EMC of any system incorporating this product is the responsibility of the assembler/installer of the system.

Failure to use approved software/hardware with our hardware products may result in injury, harm, or improper operating results

Eurotherm shall not be held responsible for any damage, injury, losses or expenses caused by inappropriate use of the product (EPack), or failure to comply with these instructions.

SELV











SELV is defined (in IEC60947-1) as an electrical circuit in which the voltage cannot exceed 'ELV' under normal conditions or under single fault conditions, including earth ground faults in other circuits. The definition of ELV is complex as it depends on environment, signal frequency, etc. See IEC 61140 for further details.

The I/O connector (5-way) & auxiliary supply (24V ac/dc, 2-way) are compliant to the SELV requirements.

The alarm relay output and the fuse holder contacts are compliant with the SELV requirements; they can be connected to SELV or to voltage up to 230V (Rated insulation voltage U_i : 230V).

Symbols Used in the Instrument Labeling

One or more of the symbols below may appear as a part of the instrument labeling.

	Protective conductor terminal		Risk of electric shock
	AC supply only		Precautions against static electrical discharge must be taken when handling this unit.
	Underwriters laboratories listed mark, for Canada and the U.S.		Refer to the manual for instructions
	Do not touch heatsink Hot Surface		CE Mark. Indicates compliance with the appropriate European Directives and Standards
	EAC (EurAsian Conformity) customs union mark of conformity		Regulatory Compliance Mark (RCM) to Australian Communication and Media Authority

Hazardous Substances

This product conforms to European **R**estriction **o**f **H**azardous **S**ubstances (RoHS) (using exemptions) and **R**egistration, **E**valuation, **A**uthorisation and Restriction of **C**hemicals (REACH) Legislation.

RoHS Exemptions used in this product involve the use of lead. China RoHS legislation does not include exemptions and so lead is declared as present in the China RoHS Declaration.

Californian law requires the following notice:

 **WARNING:** This product can expose you to chemicals including lead and lead compounds which are known to the State of California to cause cancer and birth defects or other reproductive harm. For more information go to:

<http://www.P65Warnings.ca.gov>

Cybersecurity

Introduction

When utilizing EPack controllers’ range in an industrial environment, it is important to take ‘cybersecurity’ into consideration: in other words, the installation’s design should aim to prevent unauthorized and malicious access. This includes both physical access (for instance via the front fascia), and electronic access (via network connections and digital communications).

WARNING
<p>UNINTENDED EQUIPMENT OPERATION</p> <ul style="list-style-type: none"> • Ensure physical access to the product is restricted to authorized people only. • At commissioning, ensure cybersecurity robustness of the installation. <p>Failure to follow these instructions can result in death, serious injury or equipment damage.</p>

To minimize any potential loss of control when communicating across a network via a third-party device (i.e. controller, PLC or configuration tool), ensure all system hardware, software and network design are correctly configured and commissioned for maximum cybersecurity robustness.

Cybersecurity Good Practices

Overall design of a site network is outside the scope of this manual. The Cybersecurity Good Practices Guide, Part Number HA032968 provides an overview of principles to consider. This is available from www.eurotherm.com.

Typically, an industrial controller such as the EPack power controller should not be placed on a network with direct access to the public Internet. Rather, good practise involves locating these devices on a firewalled network segment, separated from the public Internet by a so-called ‘demilitarized zone’ (DMZ).

Comms Port and Channel Enabled by Default

EPack controllers’ range supports Ethernet connectivity by default (see Communications chapter), including the Bonjour™ service discovery protocol. Bonjour™ is an implementation of Zeroconf and it enables the controller to be automatically discovered by other devices on the network without the need for manual intervention. Bonjour™ is released under a terms-of-limited-use license by Apple.

By default, the following comms ports are opened to traffic:

Port	Service
5353	UDP Zeroconf
502	TCP ModbusTCP (see note)

Note: ModbusTCP access is restricted until a default Comms Password has been entered. See "Network Communications" on page 50.

If Ethernet/IP option is enabled (see "EtherNet/IP" on page 71, not available on EtherCAT products), the following additional comms ports are opened to traffic:

Port		Service
2222	UDP	
22112	UDP	Ethernet-IP-2
44818	TCP	
44818	UDP	

If PROFINET option is enabled,(not available on EtherCAT products), the following additional comms ports are opened to traffic:

Port		Service
34964	UDP	Profinet-cm
49152	UDP	Profinet RPC mapper

Comms Port and Channel Disabled by Default

By default, the following comms ports are closed to traffic, but can be temporarily opened:

Port		Service
80	TCP	http
69	UDP	tftp

In addition, if DHCP mode is used (see "Communications" on page 69), the following port can be opened:

Port		Service
68	UDP	bootp

Achilles[®] Communications Certification

The EPack series of Power Controllers have been certified to Level 1 under the Achilles[®] Communications Robustness Test Certification scheme. This is an established industry benchmark for the deployment of robust industrial devices recognized by the major automation vendors and operators.

Introduction

This document describes the installation, operation and configuration of a single phase EPack Power Controller. The unit includes the following analog and digital inputs and outputs, fitted as standard:

- Two digital inputs (contact closure or voltage level), of which one of the digital inputs can be configured as 10V user output.
- One analog input.
- One change-over relay under software control, configurable by the user.
- Also fitted are a pair of RJ45 Ethernet connectors for communications with a controlling PC or with other units.

Chapter [Installation](#) provides details on connector locations and pinouts.

The operator interface consists of a 1.44 inch square TFT display and four pushbuttons for navigation and data selection.

The single phase EPack comes in four versions with maximum load currents of: 32A, 63A, 100A and 125A.

The supply voltage for the units can be specified as either low voltage (24V ac/dc) or line voltage (85 to 550V ac). The choice is made at time of order and cannot be changed in the field.

Unpacking the Units



DANGER

HAZARD OF ELECTRICAL SHOCK, EXPLOSION OR ARC FLASH

- If on receipt, the unit or any part within is damaged, do not install but contact your supplier.

Failure to follow these instructions will result in death or serious injury.

The units are despatched in a special pack, designed to give adequate protection during transit. If any of the outer boxes show signs of damage, open them immediately and examine the instrument. If there is evidence of damage, do not operate the instrument and contact your local representative for instructions.

After the instrument has been removed from its packing, examine the packing to ensure that all accessories and documentation have been removed.

Store the packing for future transport requirements. Or please dispose of your packaging in a responsible and environmentally conscious manner. Where possible, reuse or recycle materials. Please ensure all disposal and recycling is undertaken in compliance with your local law and regulations.

Order Code

EPack power controller is ordered using 'Basic product coding' for hardware and chargeable 'Software Upgrade Options'.

 **DANGER**

HAZARD OF FIRE

- WITHOUT Current limit function by phase angle reduction, if SWIR (Infrared) is NOT selected as Heater type, select the product current rating greater than or equal to the MAXIMUM current of the load.

Failure to follow these instructions can result in death, serious injury or equipment damage.

Calculate the MAXIMUM current of the load by taking account of load resistive tolerance, load resistive variation due to temperature (inrush current) and voltage tolerance.

For example:

WITHOUT Current limit function by phase angle reduction

- Heater type: Resistive
- Voltage (U) tolerance: +10% -15%
- Load resistance (R) tolerance: ± 5%
- Load resistance (R) variation in temperature: ± 7%
- I load maximum = $U_{max}/R_{min} = 1,1 \times U / (R \times 0.95 \times 0.93)$
- I load maximum = $1.25 \times U / R = 1.25 \times I \text{ charge nominal}$
- Product rating $\geq 1.25 \times I \text{ Load nominal}$

Current limit function by phase angle reduction may be selected to limit the inrush current of the load and reduce the current rating of the product.

 **DANGER**

HAZARD OF FIRE

- WITH Current limit function by phase angle reduction, select the product current rating greater than or equal to the nominal current of the load
- Setting of current limit function by phase angle reduction must be lower or equal to product current rating.

Failure to follow these instructions can result in death, serious injury or equipment damage.

For example:

WITH Current limit function by phase angle reduction

- Product rating $\geq I \text{ Load nominal}$
- Setting of current limit \leq Product rating

 **DANGER****HAZARD OF FIRE**

- The current limit function by phase angle reduction is not available with Intelligent Half Cycle (IHC), Select the product current rating greater than or equal to the MAXIMUM current of the load.
- Duty cycle current limiting features (in burst mode), does not limit the peak current value. Select the product current rating greater than or equal to the MAXIMUM current of the load.

Failure to follow these instructions can result in death, serious injury or equipment damage.

Short-Wave Infrared Resistor (SWIR)

At cold start-up, Short-Wave Infrared Resistor (SWIR) load types have high inrush current up to 12 times the nominal current. Current limit function by phase angle reduction can be selected to limit the inrush current.

If a fast response time is required or if IHC firing mode has been selected, current limit function by phase angle reduction cannot be selected. Safety ramp (start in phase angle) must be activated by selecting SWIR as Heater type (select Infra-red for Heater in Quickcode).

If SWIR is selected as Heater type:

- Derating shall be applied to the current product rating.
Calculate the MAXIMUM current of the SWIR load by taking account of voltage tolerance and load resistive tolerance WITHOUT taking in account the inrush current due to temperature.
Select the product current rating greater than or equal to 125% of MAXIMUM current of the SWIR load WITHOUT taking in account the inrush current.
- Adjust the safety ramp duration (SafetyRamp), the cooling time of the load (SWIRLoadCoolingTime), and the value of SWIR Load Cooling Threshold to limit the RMS load inrush current SWIR to less than 2.5 times the product current rating.

⚠ DANGER

HAZARD OF FIRE

- With SWIR Load, if a fast response time is required, or if IHC firing mode has been selected, select SWIR (Infrared) as Heater type.
- If SWIR is selected as Heater type, select the product current rating greater than or equal to 125% of MAXIMUM current of the SWIR load WITHOUT taking in account the inrush current.
- If SWIR is selected as Heater type, adjust the duration of the safety ramp (SafetyRamp), the cooling time of the load (SWIRLoadCoolingTime) and the value of SWIR Load Cooling Threshold, to limit the RMS load inrush current SWIR to less than 2.5 times the product current rating.

Failure to follow these instructions can result in death, serious injury or equipment damage.

High inrush current may overstress the fuse and/or the thyristor, the thyristor may break in short circuit. A faulty thyristor in short circuit may dissipate more power which may cause fire.

For example:

WITHOUT Current limit function by phase angle reduction:

Heater type: SWIR

Voltage (U) tolerance +10% -15%

Load resistance (R) tolerance ± 10%

Load resistance (R) variation in temperature - 92% of nominal value (ratio R/Rcold =12)

I load maximum (WITHOUT inrush) = $U_{max}/R_{min} = 1.1 \times U / (R \times 0.9)$

I load maximum (WITHOUT inrush) = 1.22 x I Load nominal

Product rating ≥ 1.25 x 1.22 x I Load nominal

Product rating ≥ 1.53 x I Load nom

NOTICE

UNINTENDED EQUIPMENT OPERATION

- When ordering the product, select the appropriate communication protocol or make sure it is available as a software upgrade option.

Failure to follow these instructions can result in non-functional equipment.

EtherCAT communication is not available as software upgrade option. If EtherCAT is required, order EtherCAT communication together with the product. (See user manual HA033540).

PROFINET protocol and the EtherNet/IP protocol are not available as software upgrade option on product with EtherCAT communication. Do not order EtherCAT communication if PROFINET protocol or EtherNet/IP protocol are required.

The PROFINET protocol and the EtherNet/IP protocol cannot be used together. Select one of the appropriate protocols among the different options.

PROFINET protocol is available as software upgrade option on product with Modbus TCP communication protocol and EtherNet/IP protocol.

EtherNet/IP protocol is available as software upgrade option on product with Modbus TCP communication protocol and PROFINET protocol.

EPack supports the Modbus/TCP protocol. whatever the communication protocol is.

Basic Product Coding



Model	
EPACK-1PH	Power Controller
1 Maximum Current	
16A	16 amps
25A	25 amps
32A	32 amps
40A	40 amps
50A	50 amps
63A	63 amps
80A	80 amps
100A	100 amps
125A	125 amps
2 Auxillary Power Supply ^{**}	
500V	500V max
24V	24V ac/dc
3 Reserved	
XXX	Reserved
4 Control Option	
V2	V ² control
I2	I ² control
V2CL	V ² with current limitation by threshold (standard)
PWRCL	Power control with current limit
5 Transfer Option	
XXX	-
TFR	I ² Transfer
6 Energy Option	
XXX	-
EMS	Energy measurement

7 Comms Option	
TCP	Modbus TCP (standard)
IP	Ethernet IP
PN	ProfiNET
CAT ^{**}	EtherCAT
8 OEM Security	
XXX	-
OEM	OEM Security
9 Warranty	
XXXXXX	Standard Warranty
WL005	5 Year Warranty
USWL3	US Extended Warranty
10 Custom Labelling	
XXXXXX	Standard (Eurotherm)
FXXXX	Special Label
11 Graphical Wiring	
XXX	Standard configuration (no graphical edition)
GWE	Graphical Wiring Editor
12 Fuse	
XXX	Without fuse
HSP	High speed fuse without microswitch
HSM	High speed fuse with microswitch
13 Configuration	
XXXXXX	Default
LC	Long code
EEenn	Customer clone number

Optional Configuration	
14 Nominal Load Current	
NNNA	1 - Value field 1
15 Nominal Line Voltage	
100V	100 volts
110V	110 volts
115V	115 volts
120V	120 volts
127V	127 volts
200V	200 volts
208V	208 volts
220V	220 volts
230V	230 volts
240V	240 volts
277V	277 volts
380V	380 volts
400V	400 volts
415V	415 volts
440V	440 volts
460V	460 volts
480V	480 volts
500V	500 volts
16 Load Type	
XX	Resistive
TR	Transformer primary
17 Heater Type	
XX	Resistive
MOSI	Molybdenum
CSI	Silicon Carbide
SWIR	Short Wave Infra-Red
18 Firing Mode	
PA	Phase angle
IHC	Intelligent half cycle
BF	Variable Modulation
	Burst firing (default 16 cycles)
FX	Fix modulation period (default 2 seconds)
LGC	Logic mode
19 Analog Input Function	
XX	None - Setpoint via Comms
SP	Setpoint
HR	Setpoint limit
IL	Current limit
TS	Current transfer span
20 Analog Input Type	
0V	0-10 volts
1V	1-5 volts
2V	2-10 volts
5V	0-5 volts
0A	0-20 mA
4A	4-20mA
21 Digital Input 2 Function	
XX	None
LG	Setpoint for logic mode
AK	Alarm acknowledgement
RS	Remote setpoint selection
FB	Fuse blown
SU	10V supply
22 Reserved	
-	Default value for skype
XXX	Reserved

^{**}Hardware variant, not available as software upgrade option

Software Upgrade Options



1 Serial number instrument		5 Energy option	
nnnn	Serial number	XXX	No change
		TFR	Energy measurement
2 Current ratings		6 Comms option	
XXX	No change	XXX	No change
16A-25A	Upgrade 16A to 25A	IP	Ethernet/IP
16A-32A	Upgrade 16A to 32A	PN	Profinet
25A-32A	Upgrade 25A to 32A		
40A-50A	Upgrade 40A to 50A		
40A-63A	Upgrade 40A to 63A		
50A-63A	Upgrade 50A to 63A		
80A-100A	Upgrade 80A to 100A		
3 Control option		7 Graphical wiring	
XXX	no change	XXX	No change
V2-V2CL	Upgrade V ² to V ² CL	GWE	Graphical wiring editor
V2-PWRCL	Upgrade V ² to PWRCL		
V2CL-PWRCL	Upgrade I ² to PWR		
4 Transfer option		8 OEM security	
XXX	No change	XXX	No change
TFR	I ² Transfer	OEM	OEM security

NOTICE

UNINTENDED EQUIPMENT OPERATION

- When ordering the product, select the appropriate communication protocol or make sure it is available as a software upgrade option.

Failure to follow these instructions can result in non-functional equipment.

EtherCAT communication is not available as software upgrade option. If EtherCAT is required, order EtherCAT communication together with the product. (See user manual HA033540).

PROFINET protocol and the EtherNet/IP protocol are not available as software upgrade option on product with EtherCAT communication. Do not order EtherCAT communication if PROFINET protocol or EtherNet/IP protocol are required.

The PROFINET protocol and the EtherNet/IP protocol cannot be used together. Select one of the appropriate protocols among the different options.

PROFINET protocol is available as software upgrade option on product with Modbus TCP communication protocol and EtherNet/IP protocol.

EtherNet/IP protocol is available as software upgrade option on product with Modbus TCP communication protocol and PROFINET protocol.

EPack supports the Modbus/TCP protocol. whatever the communication protocol is.

Installation

Mechanical Installation

Mounting details

DANGER

HAZARD OF ELECTRICAL SHOCK, EXPLOSION OR ARC FLASH

- Apply appropriate personal protective equipment (PPE) and follow safe electrical work practices. See applicable national standards e.g. NFPA70E, CSA Z462, BS 7671, NFC 18-510.
- This equipment must only be installed and serviced by qualified electrical personnel.
- Turn off all power supplying this equipment before working on equipment.
- Always use a properly rated voltage sensing device to confirm power is off.
- If on receipt, the unit or any part within is damaged, do not install but contact your supplier.
- Do not disassemble, repair or modify the equipment. Contact your supplier for repair.
- This product must be installed, connected and used in compliance with prevailing standards and/or installation regulations.
- Do not exceed the device's ratings.

Failure to follow these instructions will result in death or serious injury.

DANGER

HAZARD OF ELECTRICAL SHOCK, EXPLOSION OR ARC FLASH

- The unit must be installed in an enclosure or cabinet connected to the protective earth ground.

Failure to follow these instructions will result in death or serious injury.

Notes:

1. CE: protective earth ground minimum size must be selected according to IEC 60364-5-54 table 54.2 or IEC61439-1 table 5 or applicable national standards.
2. U.L.: protective earth ground minimum size must be selected according to NEC table 250.122 or NFPA79 table 8.2.2.3 or applicable national standards.

 **DANGER**
HAZARD OF ELECTRICAL SHOCK, EXPLOSION OR ARC FLASH

- Electrically conductive pollution must be excluded from the cabinet in which the product is mounted.

Failure to follow these instructions will result in death or serious injury.

Notes:

1. The product has been designed for pollution degree 2 according to IEC60947-1 definition: Normally, only non-conductive pollution occurs. Occasionally, however, a temporary conductivity caused by condensation may be expected.
2. Electrically conductive pollution must be excluded from the cabinet in which the product is mounted. To ensure a suitable atmosphere in conditions of conductive pollution, fit adequate air conditioning/filtering/cooling equipment to the air intake of the cabinet, e.g. fitting fan-cooled cabinets with a fan failure detection device or a thermal safety cut-out.

 **DANGER**
HAZARD OF ELECTRICAL SHOCK, EXPLOSION OR ARC FLASH

- Do not allow anything to fall through the case apertures and ingress the product.

Failure to follow these instructions will result in death or serious injury.

Note: Conductive or non-conductive parts which ingress the product may reduce or short circuit the insulation barriers inside the product.

 **WARNING**
UNINTENDED EQUIPMENT OPERATION

- Observe all electrostatic discharge precautions before handling the unit.

Failure to follow these instructions can result in death, serious injury or equipment damage.

Mechanical installation requirements

 **DANGER**
HAZARD OF FIRE

- Respect mechanical installation requirements to allow heatsink to dissipate power.

Failure to follow these instructions can result in death or serious injury.

Notes:

1. The product is designed to be mounted vertically.
2. There must be no obstructions (above or below) which could reduce or hamper airflow.

3. If more than one instance of the product is in the same cabinet, they must be mounted in such a way that air from one unit is not drawn into another.
4. The gap between two E-Pack devices must be at minimum 10mm.
5. The gap between E-Pack and cable tray must be at least those defined in the table in Mounted clearance dimensions.

DANGER

HAZARD OF FIRE

- At commissioning ensure that under maximum load condition, the ambient temperature of the product will not exceed the limit stated in that manual.

Failure to follow these instructions can result in death or serious injury.

Notes:

1. E-Pack has been designed for a maximum temperature of 45°C (113°F) at 1000m (3281ft) altitude at nominal current & 40°C (104°F) at 2000m (6562ft) altitude at nominal current.
2. At commissioning ensure that the ambient temperature inside the cabinet does not exceed the limit under maximum load condition.

DANGER

HAZARD OF FIRE

- Heat-sink must be cleaned regularly. Periodicity depends on the local environment, but should not exceed 1 year.

Failure to follow these instructions can result in death or serious injury.

CAUTION

HOT SURFACE RISK OF BURNS

- Do not allow flammable or heat-sensitive parts in the immediate vicinity of heatsink.

Failure to follow these instructions can result in injury or equipment damage.

Mounted clearance dimensions

Phase:	single phase			
Amps:	16 - 32A	40 - 63A	80 - 100A	125A
E-Pack clearance dimensions mm (inches):				
between cable tray and E-Pack	70 (2.76)	100 (3.94)	150 (5.91)	150 (5.91)
between two cable trays	270 (10.6)	330 (13)	475 (18.7)	475 (18.7)
between or side by side another E-Pack	10 (.39)	10 (.39)	10 (.39)	10 (.39)

Figures 4 to 7 show dimensions for the various units.

The units are designed for DIN Rail or bulkhead mounting using the mounting fixings supplied.

Bulkhead Mounting

32A and 63A Units

For Bulkhead mounting, fit the upper bracket 'A' to the rear of the unit by removing screw 'B' and associated shakeproof washer, offering the bracket up to the unit, and then securing it by installing screw 'B' ensuring that the bracket is correctly oriented (as shown) and that the shakeproof washer is fitted between the screw head and the bracket.

Use a screwdriver with a 3mm AF hexagonal bit. The recommended tightening torque is 1.5 Nm (1.1 lb-ft).

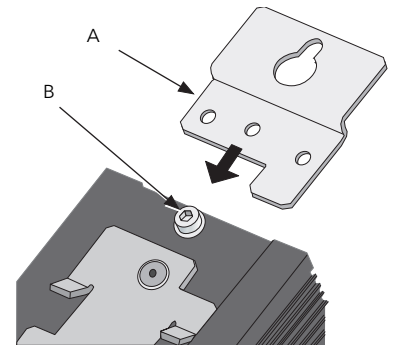

Figure 1 Fitting upper bulkhead mounting bracket (32A unit shown; 63A units similar)

80A, 100A and 125A Units

For bulkhead mounting, fit the upper bracket 'A' to the rear of the unit by removing screws 'B' and associated shakeproof washers, offering the bracket up to the unit, and then securing it using screws 'B' ensuring that the bracket is correctly oriented (as shown) and that the shakeproof washers are fitted between the screw heads and the bracket. The relevant screwdriver should have a 3mm AF hexagonal bit. The recommended tightening torque is 1.5Nm (1.1 lb-ft).

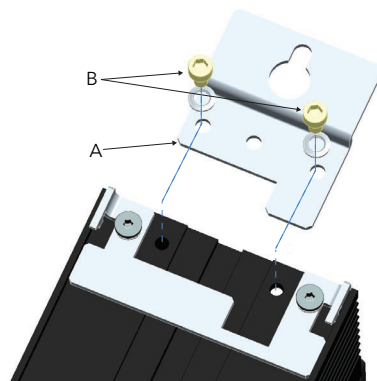

Figure 2 Bulkhead mounting 80A/100A unit shown (125A similar)

DIN Rail Mounting

32A and 63A Units

The 32A and 63A units can be mounted using a standard 7.5mm or 15mm DIN rail, mounted horizontally .

80A, 100A and 125A Units

These higher power units can be mounted, using two horizontal, parallel, 7.5mm or 15mm DIN rails, as shown below.

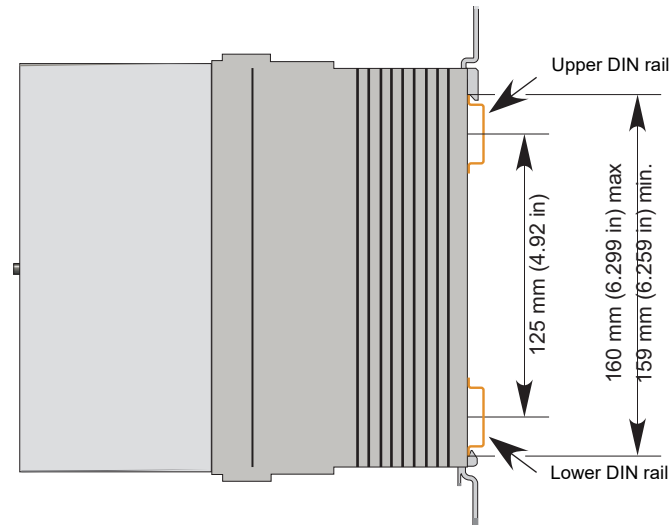

Figure 3 DIN rail mounting details for 80A, 100A and 125A units

Dimensions

16A to 32A unit dimensions

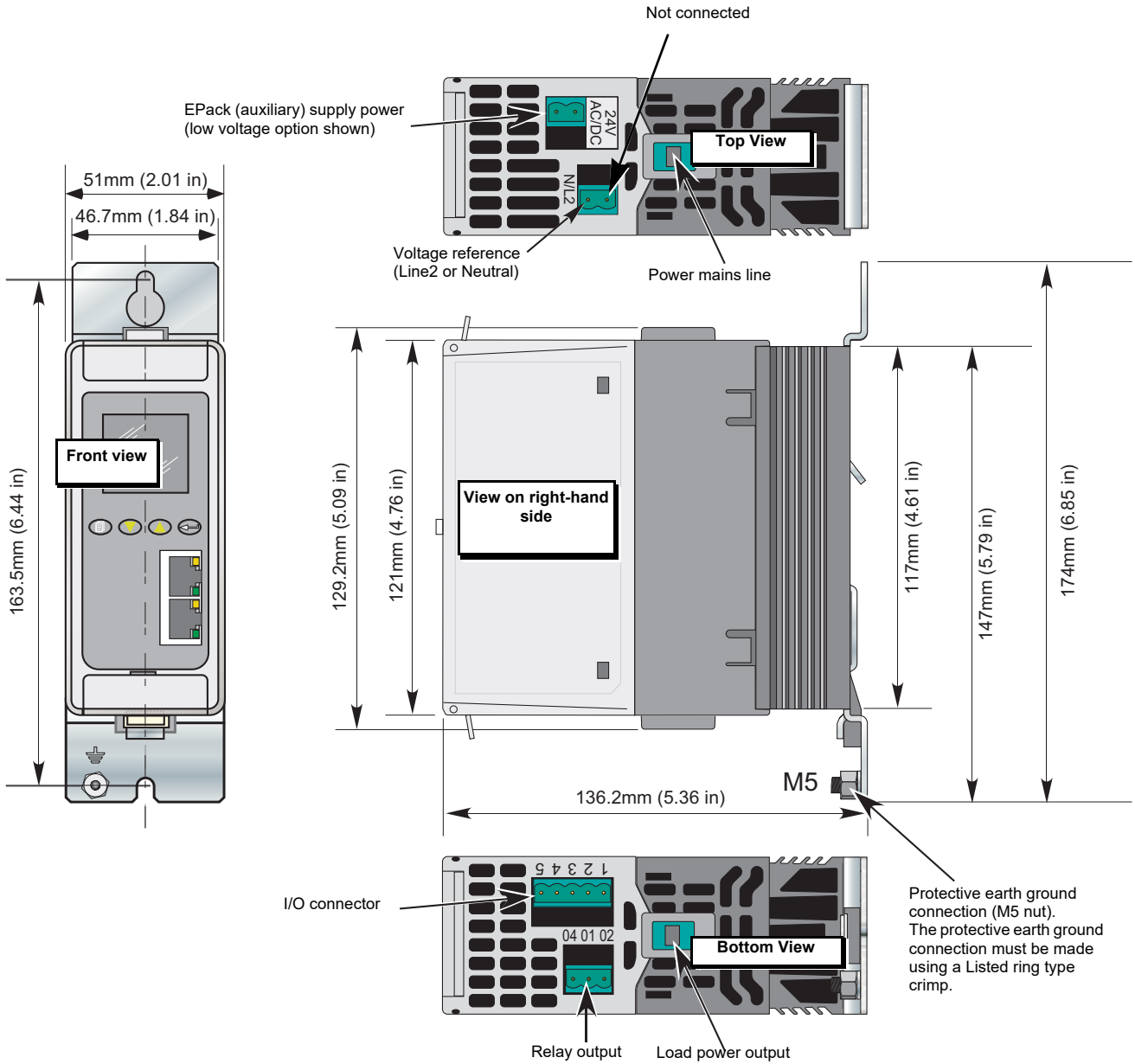

Figure 4 Mechanical installation details (16A to 32A units)

40A to 63A unit dimensions

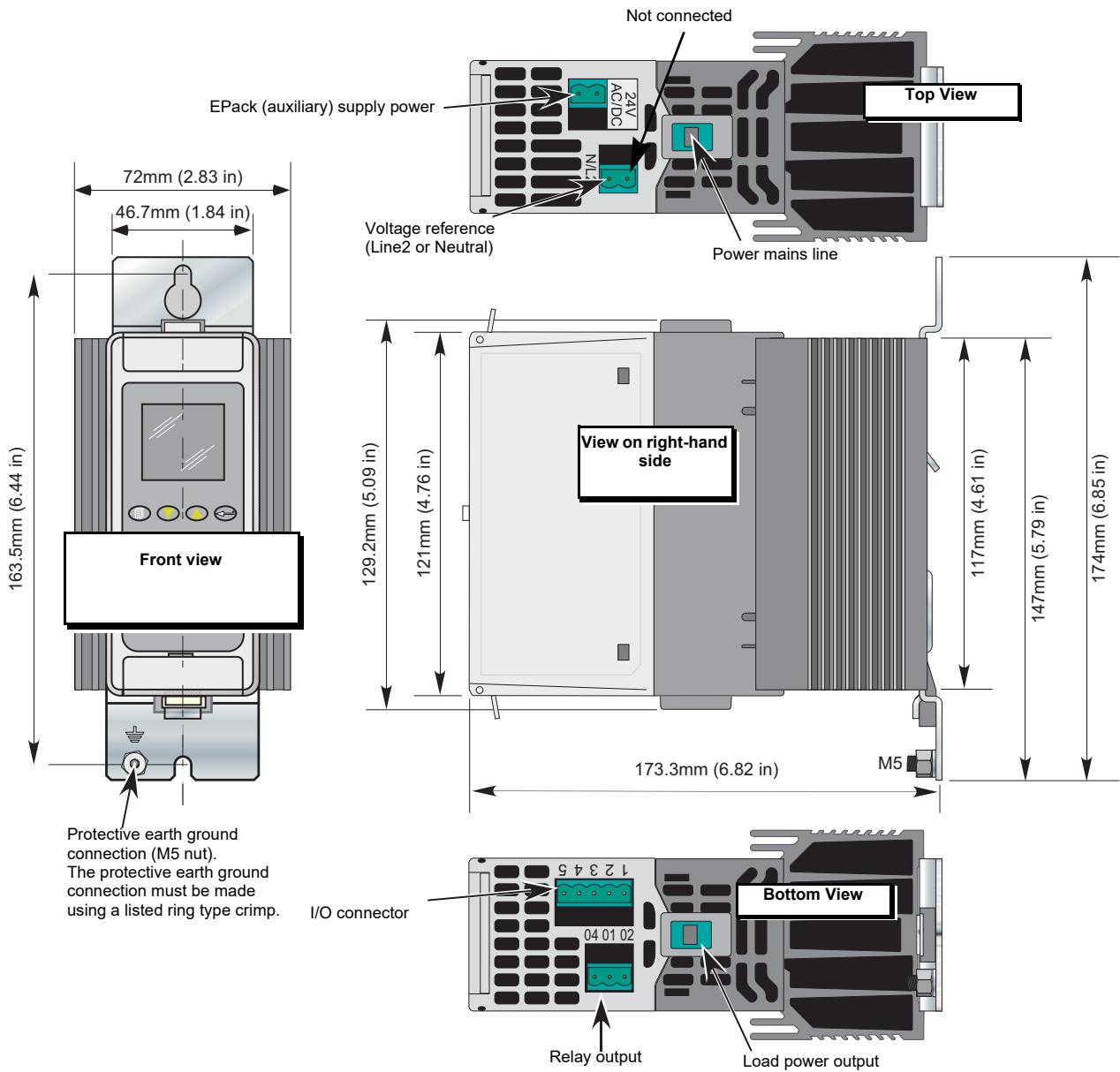

Figure 5 Mechanical installation details (40A to 63A units)

80A to 100A unit dimensions

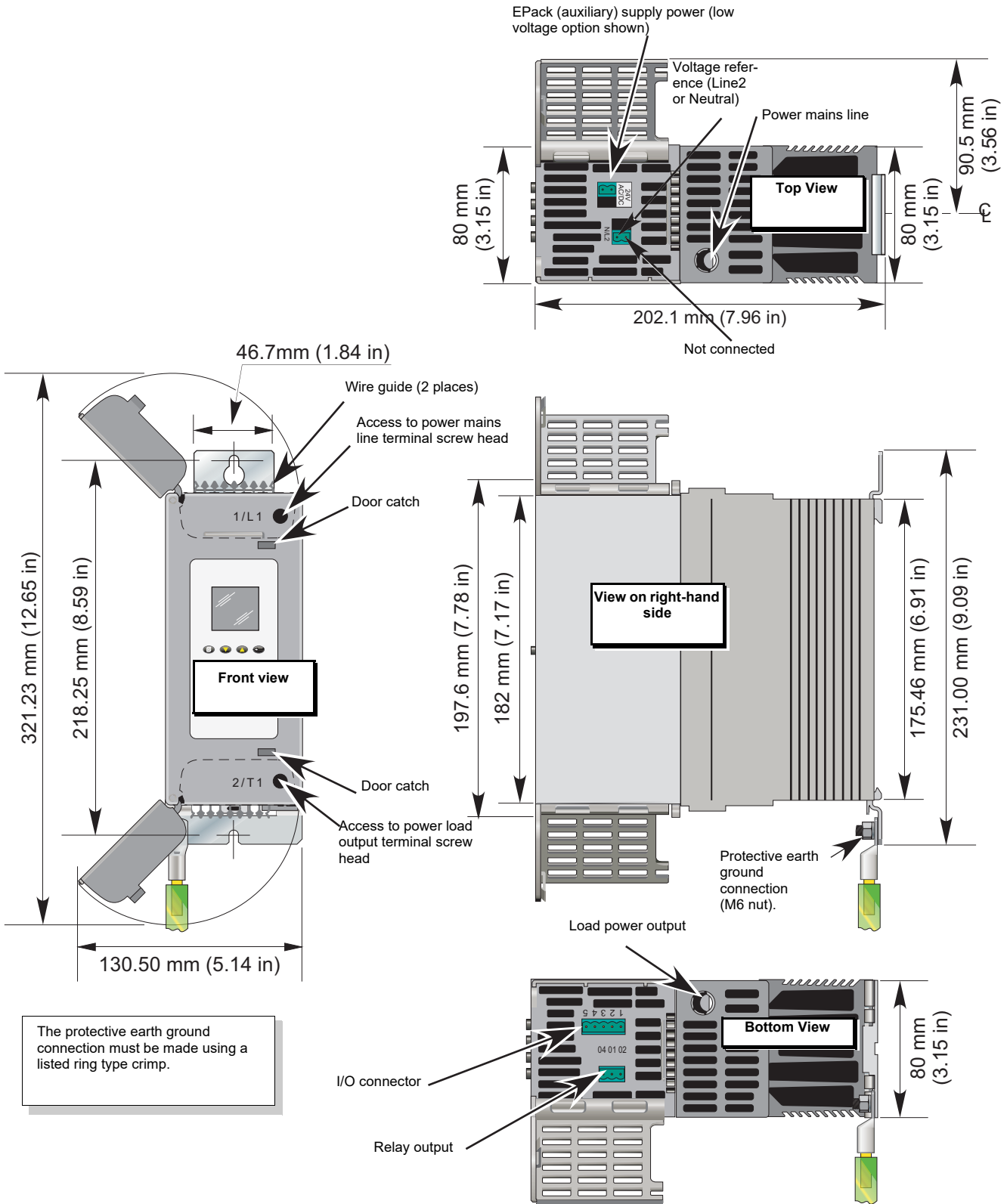

Figure 6 Mechanical installation details (80A to 100A units) (doors open).

125A unit dimensions

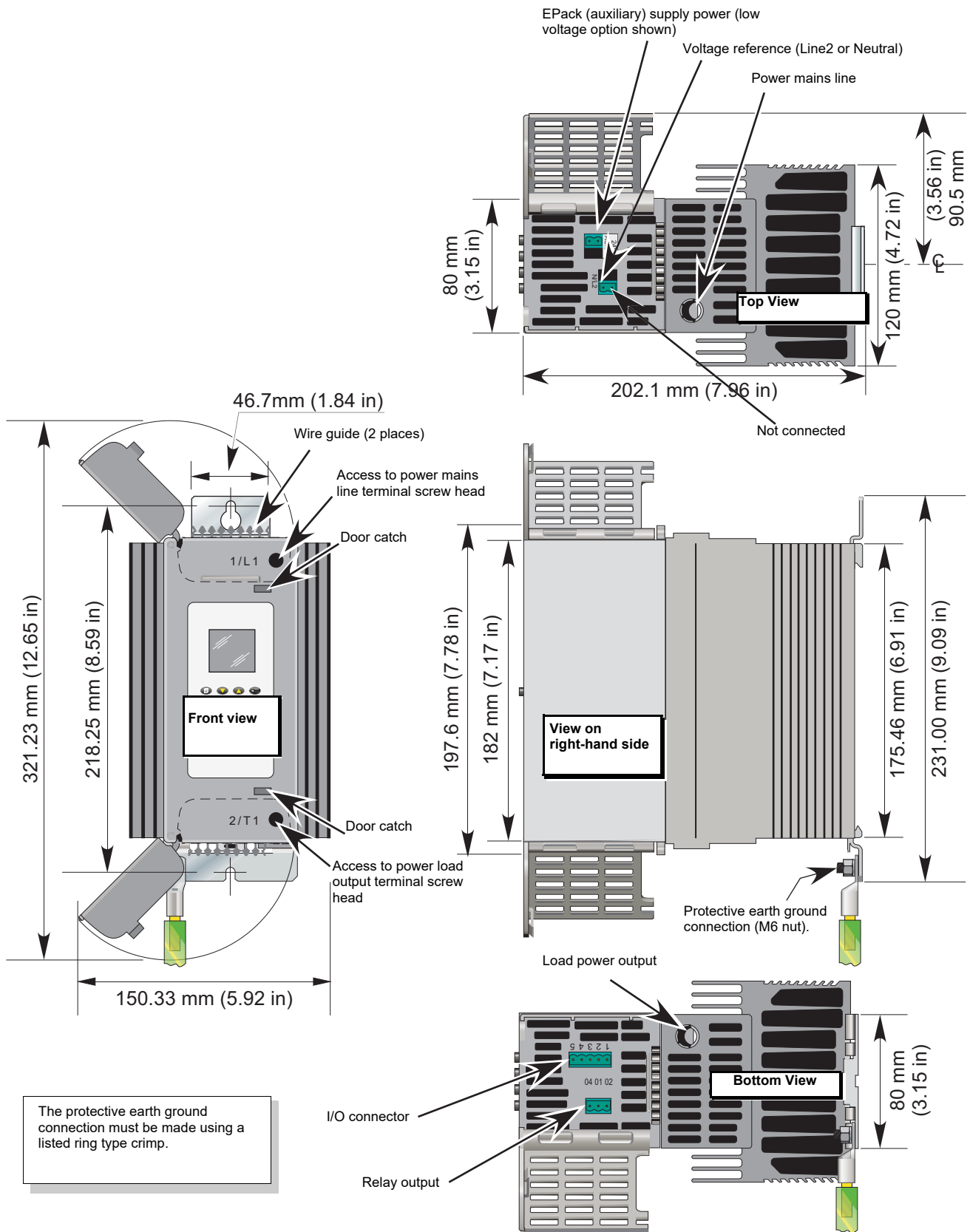

Figure 7 Mechanical installation details (125A units) (Doors open).

Electrical Installation

DANGER

HAZARD OF ELECTRICAL SHOCK, EXPLOSION OR ARC FLASH

- Apply appropriate personal protective equipment (PPE) and follow safe electrical work practices. See applicable national standards e.g. NFPA70E, CSA Z462, BS 7671, NFC 18-510.
- This equipment must only be installed and serviced by qualified electrical personnel.
- Turn off all power supplying this equipment before working on equipment.
- Always use a properly rated voltage sensing device to confirm power is off.
- If on receipt, the unit or any part within is damaged, do not install but contact your supplier.
- Do not disassemble, repair or modify the equipment. Contact your supplier for repair.
- This product must be installed, connected and used in compliance with prevailing standards and/or installation regulations.
- Do not exceed the device's ratings.

Failure to follow these instructions will result in death or serious injury.

DANGER

HAZARD OF ELECTRICAL SHOCK, EXPLOSION OR ARC FLASH

- Do not allow anything to fall through the case apertures and ingress the product.

Failure to follow these instructions will result in death or serious injury.

Note: Conductive or non-conductive parts which ingress product may reduce or short the insulations barriers inside the product.

DANGER

HAZARD OF ELECTRICAL SHOCK, EXPLOSION OR ARC FLASH

- Ensure all cables and wiring harness are secured using a relevant strain relief mechanism.

Failure to follow these instructions will result in death or serious injury.

Note: Wires may slip out of the terminals.

 **WARNING**

UNINTENDED EQUIPMENT OPERATION

- Observe all electrostatic discharge precautions before handling the unit.
- Signal and power voltage wiring must be kept separate from one another. Where this is impractical, all wires must be rated to the power voltage & shielded cables are recommended for signal wiring.
- For Electromagnetic Compatibility, panel or DIN rail to which product is attached must be grounded.

Failure to follow these instructions can result in death, serious injury or equipment damage.

Connection Details

 **DANGER**

HAZARD OF ELECTRICAL SHOCK, EXPLOSION OR ARC FLASH

- Before any other connection is made, the protective earth ground terminal must be connected to a protective conductor.
- Protective conductor must be sized in compliance with local and national regulatory requirements.

Failure to follow these instructions will result in death or serious injury.

The earth connection must be made by using a lug terminal of size as given in Table 1, "Connection Details". The cables must be rated 90°C stranded copper only.

- CE: The protective earth ground cable minimum size must be selected according to IEC 60364-5-54 table 54.2 or IEC61439-1 table 5 or applicable national standards. The protective earth ground connection must be made to the unit with a ring type crimp terminal, using the nut and shakeproof washer supplied (M5 for 16A to 63A units and M6 for 80A to 125A units).
- U.L.: The protective earth ground cable cross sectional area should be selected according to NEC table 250.122 or NFPA79 table 8.2.2.3 or applicable national standards. The protective earth ground connection must be made to the unit with a U.L. listed ring type crimp terminal, using the nut and shakeproof washer supplied (M5 for 16A to 63A units and M6 for 80A to 125A units).

 **DANGER**

HAZARD OF FIRE

- Power connections: The cables must be rated 90°C stranded copper only, the cross section must be selected according to the branch circuit protection rating.

Failure to follow these instructions will result in death or serious injury.

CE: Wire conductor cross sections must comply with IEC 60364-5-52 or applicable national standards.

U.L.: Wire conductor cross sections must comply with NEC Table 310.15(B)(16) (formerly Table 310.16) taking account of table 310.15(B)(2) for the ampacity correction factors or NFPA79 Table 12.5.1 taking account of Table 12.5.5(a) for the ampacity correction factors or applicable national standards.

Table 1, "Connection Details" gives details of tightening torques for the various supply power and signal wiring connections.

Table 1: Connection Details

Terminals	Product Rating	Terminal Capacity ¹		Wire Type	Torque	Comments
		mm ²	AWG			
Supply voltage (1/L1) and Load supply (2/T1)	16A to 63A	1.5mm ² to 16mm ²	AWG 14 to AWG 6 ²	Stranded copper Rated 90°C (194°F)	1.7Nm (15lb in)	Flat-bladed screwdriver 4 x 0.8mm (5/32in x 0.0315in) or 4.5 x 0.8mm
	80A to 125A	10mm ² to 50mm ²	AWG 8 to AWG 2/0		5.6Nm (50lb in)	Flat-bladed screwdriver 5.5 x 1mm (7/32in x 0.039in) or 6.5 x 1.2mm (1/4in x 0.047in)
Protective earth ground	16A to 63A	M5 ring-type crimp terminal			2.5Nm (22lb in)	U.L.: Listed ring-type crimp terminal must be used
	80A to 125A	M6 ring-type crimp terminal			5.6Nm (50lb in)	U.L.: Listed ring-type crimp terminal must be used
Neutral Reference (N/L2) (2-way/1 connected) Supply (24Vac/dc) (2-way) Supply (85V-550Vac)(3-way) I/O connector (5-way) Relay connector (3-way)	All	0.25mm ² to 2.5mm ²	AWG 24 to AWG 12	Stranded copper Rated 75°C (167°F)	0.56Nm (5lb in)	Flat-bladed screwdriver 3.5 x 0.6mm (1/8in x 0.0236in)

1. AWG (American Wire Gauge) for USA and Canada (according to cUL standard); section in mm² for IEC countries (according to IEC/EN standard).
2. Use U.L. listed crimp terminals YEV4CP20X75FX, from Burndy (E9498), to connect AWG 4 wire to terminal.

DANGER

HAZARD OF ELECTRICAL SHOCK, EXPLOSION OR ARC FLASH

- Tighten all connections in conformance with the torque specifications. Periodic inspections are required.

Failure to follow these instructions will result in death or serious injury.

See Table 1, "Connection Details".

Wires are not properly retained in terminals with insufficient torque.

Insufficient torque may increase the contact resistance:

- The protective earth ground connection may be too resistive. In case of short circuit between live parts and heatsink, the heatsink may reach a dangerous voltage.
- The power terminals will overheat.

Excessive torque may damage the terminal.

DANGER

HAZARD OF FIRE

- Connection of two conductors in the same terminal is not permitted.

Failure to follow these instructions will result in death or serious injury.

Partial or total loss of connection as a result of attempting to connect two or more conductors in the same terminal results in an overheat of the terminals.

See Table 1, "Connection Details".

NOTICE

NORTH AMERICA REGULATIONS

- For USA & Canada EPack 125A fuse holder terminal capacity is rated UL 1/0AWG, this may decrease the maximum Load current according to standard, ambient temperature, wiring arrangement.

Failure to follow these instructions can result in non-compliance to North America regulations.

For compliance with;

- UL508A (Industrial Control Panels) the continuous load shall not exceed 120A.
Note: As per UL508A, an ambient temperature of 40°C is assigned to all cabinet, cable stranded copper rated 90°C.
- NFPA79 (Electrical Standard for Industrial Machinery) full load current shall not exceed:
 - 125A at 35°C ambient temperature
 - 120A at 40°C ambient temperature
 - 115A at 45°C ambient temperature.

Note: According to NFPA79 sub article 12.5.2, NFPA70 (NEC) article 310.15 may be used to size conductor rated 90°C. Higher full load current may be achieved with NFPA70 (NEC) see below.

- NFPA 70 (NEC: National electric code), continuous load may be limited according to ambient temperature of the cabinet and wiring arrangement.

Note: Single-Insulated Conductors and NEC Table 310.15(B)(17) (formerly Table 310.17) may be use for continuous load up to 125A at 45°C.

Auxiliary supply

The auxiliary supply connections (to operate the product) are terminated using a 2-way (24V ac/dc version) or 3-way (85 to 550Vac version) connector, located on the upper side of the unit, as shown in Figure 8 and Figure 9.

24V ac/dc auxiliary supply

 **DANGER**

HAZARD OF FIRE

- The cables used to connect the EPack’s auxiliary supply and voltage reference must be protected by branch-circuit protection. Such branch-circuit protection must comply with local and national regulatory requirements.

Failure to follow these instructions will result in death or serious injury.

- CE: branch-circuit protection must be selected according to IEC 60364-4-43 or applicable local regulations.
- UL: branch-circuit protection must be selected according to NEC article 210.20, it is necessary for compliance with National Electric Code (NEC) requirements.

 **DANGER**

HAZARD OF ELECTRICAL SHOCK, EXPLOSION OR ARC FLASH

- The “24V auxiliary supply” is an SELV circuit. The supply Voltage must be derived from a SELV or PELV circuit.

Failure to follow these instructions will result in death or serious injury.

SELV is defined (in IEC60947-1) as an electrical circuit in which the voltage cannot exceed 'ELV' under normal conditions or under single fault conditions, including earth ground faults in other circuits.

The definition of ELV is complex as it depends on environment, signal frequency, etc. See IEC 61140 for further details.

85 to 550Vac auxiliary supply

 **DANGER**

HAZARD OF FIRE

- The cables used to connect the EPack’s auxiliary supply and voltage reference must be protected by branch-circuit protection. Such branch-circuit protection must comply with local and national regulatory requirements.

Failure to follow these instructions will result in death or serious injury.

Branch circuit protection is mandatory to protect the cable used to connect the auxiliary supply.

- CE: branch-circuit protection must be selected according to IEC 60364-4-43 or applicable local regulations.
- UL: branch-circuit protection must be selected according to NEC article 210.20, it is necessary for compliance with National Electric Code (NEC) requirements.

 **DANGER**

HAZARD OF ELECTRICAL SHOCK, EXPLOSION OR ARC FLASH

- A High-speed fuse (supplemental fuses in addition to branch circuit protective device) or a double protection fuse as listed in "Auxiliary supply fuse protection" on page 238 is mandatory for 85Vac to 550Vac auxiliary supply.

Failure to follow these instructions will result in death or serious injury.

This fuse is necessary to avoid the 85Vac to 550Vac auxiliary supply to emit flame or molten element in case of breakdown of a component.

High-speed fuse (supplemental fuse) does not protect the wiring, they must be fitted **(in addition to branch circuit protective device)**.

Double protection fuse comprises a branch circuit fuse and a high-speed fuse.

Double protection fuses must be selected according to applicable national standards

Branch circuit protection fuses standards in USA/Canada differ from IEC standards (e.g; Europe (CE)). Therefore:

- A fuse approved as branch circuit protection fuses in USA/Canada is not a branch circuit in all countries where IEC standards apply (e.g; Europe (CE)).
- A fuse approved as branch circuit protection fuses in all countries where IEC standards apply (e.g; Europe (CE)) is not a branch circuit in USA/Canada.

See tables in "Auxiliary supply fuse protection" on page 238.

 **DANGER**

HAZARD OF ELECTRICAL SHOCK, EXPLOSION OR ARC FLASH

- If opening of any fuses or branch circuit protection device that supply the 85Vac to 550Vac auxiliary supply occurs, first check the wiring. If the wiring is not damaged, do not replace the fuse and contact the manufacturer's local service center.

Failure to follow these instructions will result in death or serious injury.

If the wiring is not damaged a component inside the 85Vac to 550Vac auxiliary supply is broken and product must go back to service center.

 **DANGER**

HAZARD OF ELECTRICAL SHOCK, EXPLOSION OR ARC FLASH

- The maximum voltage between any pole of the 85Vac to 550Vac auxiliary supply and all other terminals must be lower than 550Vac.

Failure to follow these instructions will result in death or serious injury.

If the 85Vac to 550Vac auxiliary supply is supplied by a dedicated transformer the phasing must be checked to avoid overvoltage.

Connections (Supply Power and Load)

DANGER

HAZARD OF FIRE

- This product does not contain any branch-circuit protection, therefore the installer must add branch-circuit protection upstream of the unit.
- Branch circuit protection must be selected according to maximum current in each phase and must be rated in compliance with local and national regulatory requirements.

Failure to follow these instructions will result in death or serious injury.

Branch circuit protection is mandatory to protect the wiring.

- CE: branch-circuit protection must be selected according to IEC 60364-4-43 or applicable local regulations.
- UL: branch-circuit protection must be selected according to NEC article 210.20, it is necessary for compliance with National Electric Code (NEC) requirements.

DANGER

HAZARD OF FIRE

- Power connections: The cables must be rated 90°C stranded copper only, the cross section must be selected according to the branch circuit protection rating.

Failure to follow these instructions will result in death or serious injury.

CE: Wire conductor cross sections must comply with IEC 60364-5-52 or applicable national standards

U.L.: Wire conductor cross sections must comply with NEC Table 310.15(B)(16) (formerly Table 310.16) taking account of table 310.15(B)(2) for the ampacity correction factors or NFPA79 Table 12.5.1 taking account of Table 12.5.5(a) for the ampacity correction factors or applicable national standards.

DANGER

HAZARD OF ELECTRICAL SHOCK, EXPLOSION OR ARC FLASH

- High speed fuses (supplemental fuses in addition to branch circuit protective device), as listed in fusing sections, are mandatory to protect EPack against load short circuit.
- If opening of either the branch circuit protective device or the high-speed fuses (supplemental fuses) occurs, the product must be examined by suitably qualified personnel and replaced if damaged.

Failure to follow these instructions will result in death or serious injury.

See tables in "Fusing" on page 231.

 **DANGER**

HAZARD OF ELECTRICAL SHOCK, EXPLOSION OR ARC FLASH

- Respect electrical installation requirements to ensure optimum IP rating.

Failure to follow these instructions will result in death or serious injury.

Products rated 16A to 63A are rated IP10 according to EN60529.

Products rated 80A to 125A are rated IP20 according to EN60529.

If the conductor stripping lengths of the power cables are longer than the requirements, then IP20 is compromised.

If the conductor stripping lengths of the power cables are shorter than the requirements there is a potential risk of total loss of connection. Wires may slip out of the terminals.

For product rated 80A to 125A, if the plastic knockouts are removed, and cables with diameters lower than 9mm are used, then IP20 rating is compromised and the product is rated at IP10.

 **DANGER**

HAZARD OF FIRE

- The conductor stripping length must be as stated in Electrical Installation.

Failure to follow these instructions will result in death or serious injury.

If the conductor stripping lengths of the power cables are shorter than the requirements there is a potential risk of partial loss of connection which may create an overheat of the terminals.

 **DANGER**

HAZARD OF ELECTRICAL SHOCK, EXPLOSION OR ARC FLASH

- Close doors and plug-in terminals before turning on power to this equipment.

Failure to follow these instructions will result in death or serious injury.

For product rated 80A to 125A, if the upper and/or lower access door are open, the IP20 is compromised and the products are IP10.

Products rated 16A to 63A are rated IP10 according to EN60529, if the voltage reference connector (N/L2) remains connected the rating is improved to IP20.

16A to 32A and 40A to 63A Units

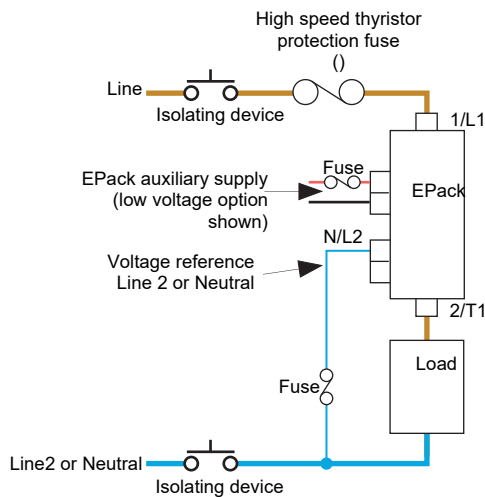
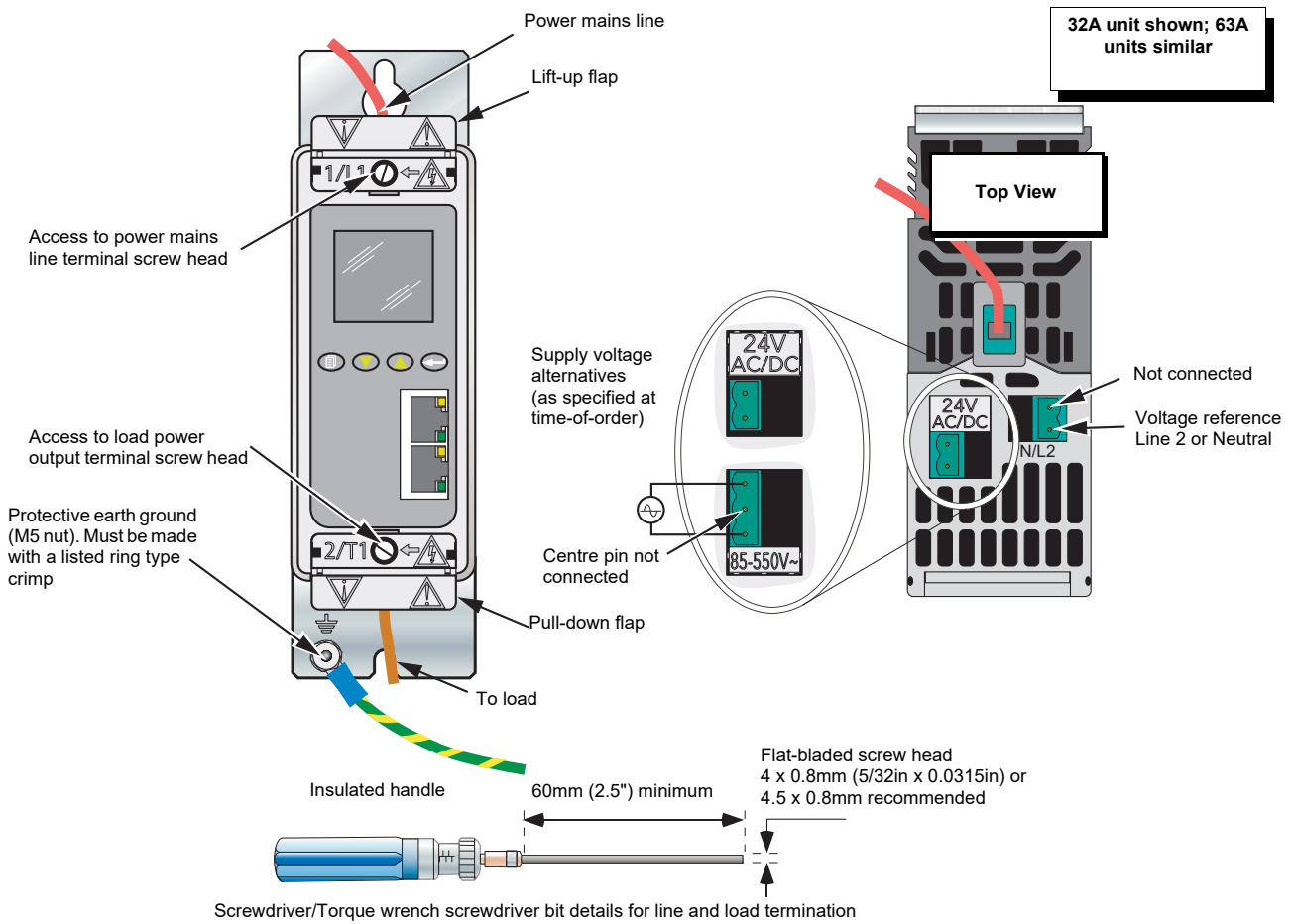

Figure 8 Supply power and Load connection details (16A to 63A units)

E-Pack rating (Amps)	Exposed conductor length mm (inch)	Cable diameter maximum mm (inch)
16A to 63A	9 to 11 (0.35 to 0.43)	8.5 (0.33)

Table 2: E-Pack single phase, 16A to 63A cable connection specification

80A to 125A units

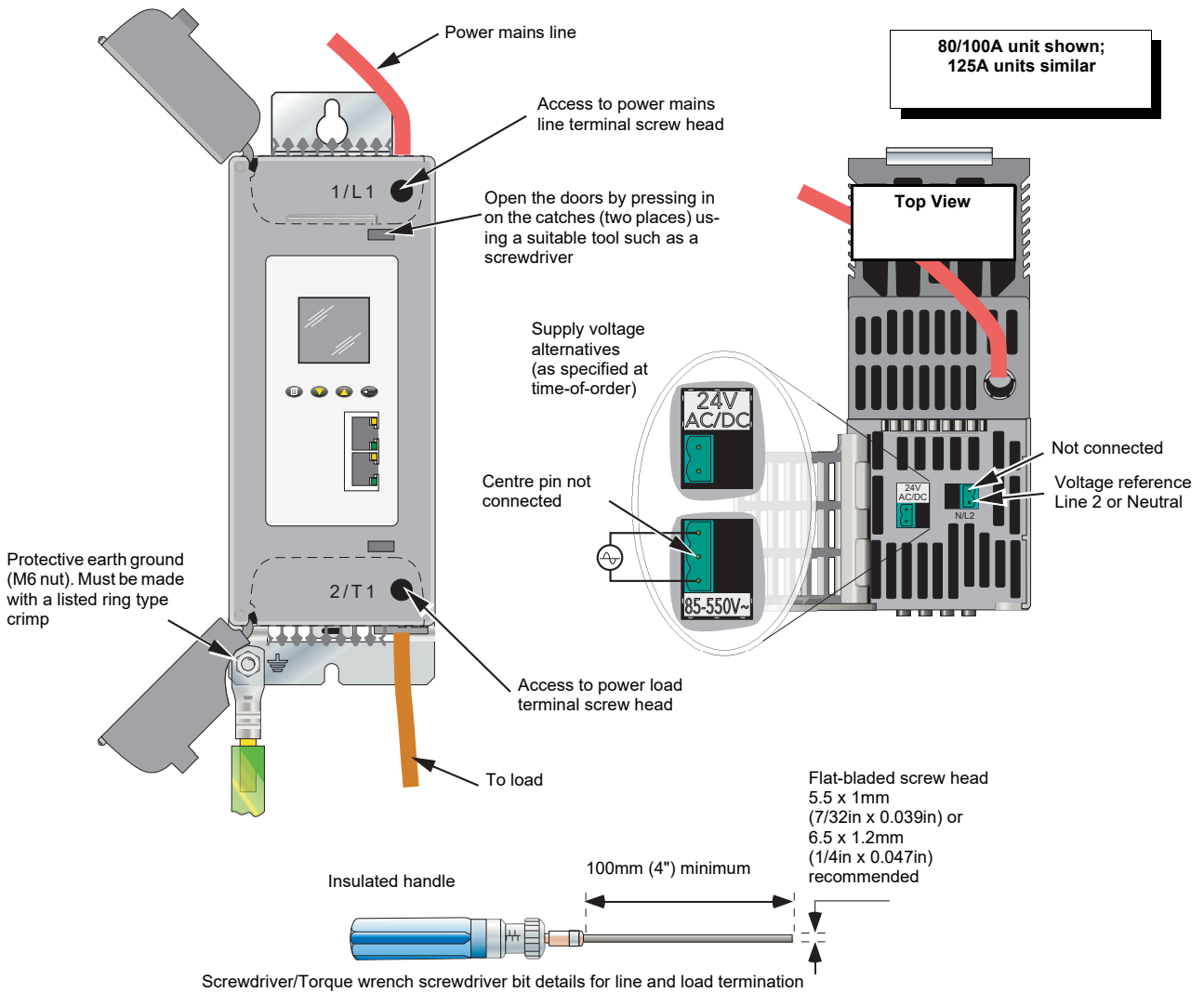

Figure 9 Supply power and Load connection details (80A to 125A units)

See Figure 8 or Figure 9 for basic wiring details.

EPack rating (Amps)	Exposed conductor length mm (inch)	Remove terminal housing plastic knockout? mm (inch) cable diameter	Cable diameter maximum mm (inch)
80A to 125A	20 - 23 (0.79 - 0.91)	Yes, for cables greater than 9 (0.35)	17.5 (0.69)

Table 3: EPack single phase 80A to 125A cable connection specification

Signal wiring

Figure 10 shows the connector location, on the underside of the unit, for the digital and analog inputs, and for the internal relay output.

Firing Enable

For the power module thyristors to operate, the Firing Enable must be enabled.

In the default configuration Digital input 1 is used to enable the firing and is configured in contact closure type. Therefore, Firing Enable is achieved by shorting pins 0V and DI1 of the I/O connector located on the underside of the unit (Digital input 1).

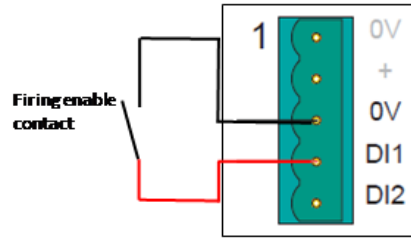

QuickCode menu allows the user to select Digital input 2 to Enable Firing. Digital input 2 is configured in contact closure type, therefore, Firing Enable is achieved by shorting pins 0V and DI2 of the I/O connector located on the underside of the unit (Digital input 2).

If none of them have been selected as firing enable function in the QuickCode menu therefore userval1 function block will be connected to the firing enable input of the firingOP function block.

Userval1 function block will be set to 1 which will enable the firing.

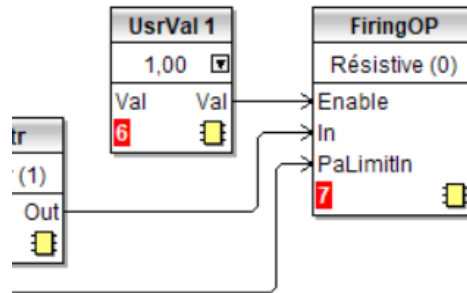

Alarm Acknowledge

In the default configuration, shorting pins 0V and DI2 of the I/O connector located on the underside of the unit (Digital input 2) acknowledges alarms. This can be done also using DI1.

DI can be configured as a voltage input (if required), and in this case it requires a high signal to be applied to DI with the relevant zero voltage connected to 0V.

Main Setpoint

In the default configuration, the analog input sets the main setpoint.

Relay Output

The relay is normally energized (Common and Normally Open pins shorted), and is de-energized (Common and Normally Closed pins shorted) when active. In the default configuration, the relay output is operated by the Fault detect 'Custom Alarm' becoming active.

By default, the Custom alarm is set up to be equivalent to 'AnySystemAlarm' which becomes active if any 'stop firing' conditions, such as those listed below, is detected.

1. Missing mains. Supply voltage line is missing.
2. Thyristor short circuit^a
3. Network dips. A reduction in supply voltage exceeding a configurable value (VdipsThreshold), causes firing to be inhibited until the supply voltage returns to a suitable value. VdipsThreshold represents a percentage change in supply voltage between successive half cycles.
4. Freq out of range. The supply frequency is checked every half cycle, and if the percentage change between successive half cycles exceeds a threshold value (max. 5%), a Mains Frequency System Alarm is generated.
5. Chop Off (page 225).
6. Analog input over current. For mA inputs this alarm is active if there is too high a current flowing through the shunt.

The relay is de-energized temporarily then re-energized at start-up. As the relay is wired in positive security, any auxiliary power supply failure will de-energize the relay.

In configuration mode, it is also possible to configure the relay using the Alarm Relay menu in the Operator Interface (page 55).

a. It is not possible to detect a thyristor short circuit when the unit is delivering 100% output power.

I/O Input & Output Details

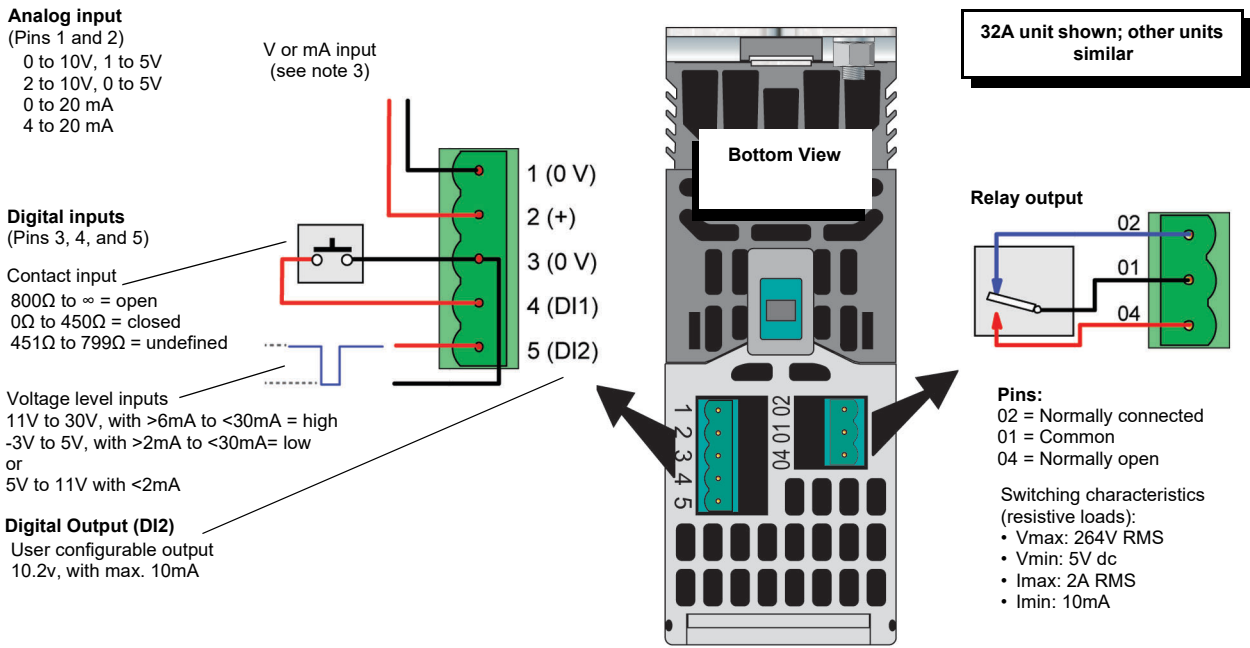

Figure 10 I/O details

Notes:

1. Diagram shows DI1 as a contact input and DI2 as a voltage level input.
2. DI1 can be configured as contact inputs or voltage inputs.
3. DI2 can be configured as contact inputs or voltage inputs or 10.2V output (with max. 10mA).
4. Analog input type (Volts or mA) is selected in I/O Analog IP configuration. When a mA range is selected, a suitable shunt resistor is automatically connected into circuit. It is thus unnecessary for the user to fit external components.

⚠ **DANGER**

HAZARD OF ELECTRICAL SHOCK, EXPLOSION OR ARC FLASH

- Do not exceed the device's ratings.
- The I/O Input & Output, the Communications ports are SELV circuit. They must be connected to SELV or PELV circuit.
- The relay output and the fuse holders contacts are compliant to the SELV requirements; they can be connected to SELV, PELV circuit or to voltage up to 230V (maximum value of rated operational voltage to earth:230V).

Failure to follow these instructions will result in death or serious injury.

SELV is defined (in IEC60947-1) as an electrical circuit in which the voltage cannot exceed 'ELV' under normal conditions or under single fault conditions, including earth ground faults in other circuits.

The definition of ELV is complex as it depends on environment, signal frequency, etc. See IEC 61140 for further details.

Network Communications

Ethernet Wiring

An Ethernet networking capability is provided by a pair of RJ45 connectors, located at the front of the E-Pack power controller unit.

Communications Pinouts

Each connector has a pair of LED indicators to indicate network connection (amber LED) and network Tx activity (flashing green).

The connection is 10/100 base T, autosensing.

Pin	Signal
8	Not used
7	Not used
6	Rx-
5	Not used
4	Not used
3	Rx+
2	Tx-
1	Tx+

LEDs:
Green = Tx activity
Yellow = Connected

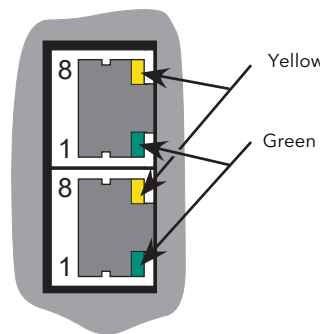

Figure 11 E-Pack Pinouts

Communications startup

E-Pack configuration over communication channel is protected by a password called 'Comms Password'. This password shall be provided each time config mode is to be entered from Comms.

Full communication is disabled by default until a proper Comms Password is defined. This can be done via two means: from product front fascia or from iTools.

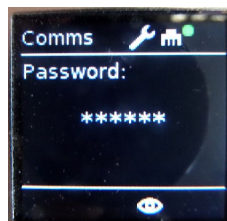

Enabling full communication from front fascia

When an Ethernet cable is connected, Comms Password page is displayed. A six-digit random numeric password is generated and obscured by default:

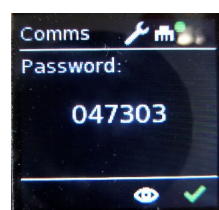

Keep pushing  button to display in clear text, then memorize this password.



After releasing  button, push  button within one second to validate this password. If the password is difficult to memorize, a new one can be generated by disconnecting and reconnecting Ethernet cable.

Notes:

1. Comms Password shall never be written down! It is therefore recommended to change it to a user-chosen one as soon as possible using iTools.
2. Once Comms Password has been set, product behaves as follows when an Ethernet cable is connected:
 - o If product in is Operator or Engineer mode, it is no longer possible to enter config mode from front fascia until cable is disconnected. Config mode can still be entered from comms, provided the correct Comms Password is provided.
 - o If Config mode has been entered from front fascia (that is, before Ethernet cable is connected), communication is restricted until Comms Password is provided via Comms or Config mode exited.

Enabling full communication from iTools

This can be done in two ways:

1. The user selects the “Add Devices” (using the “Add” button), the device will display a padlock icon to the left of the device description.

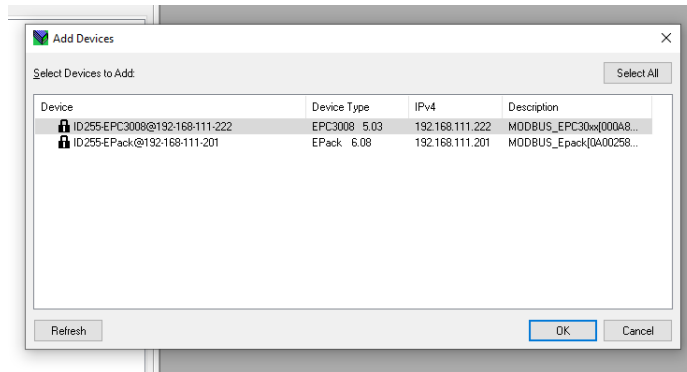

If they select to add the device, iTools will display a message informing them that they need to configure the Comms Configuration password before being able to proceed.

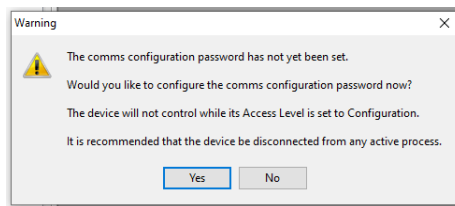

Selecting 'Yes' will automatically launch the iDevPWSetup tool.

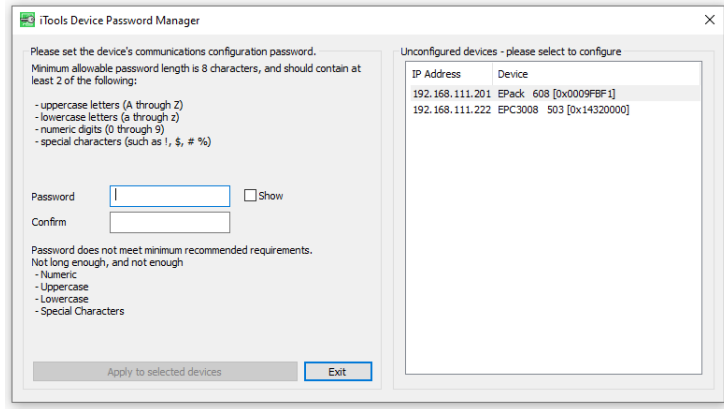

2. The user chooses to perform a network "Scan", on detecting the device, iTools will display a message:

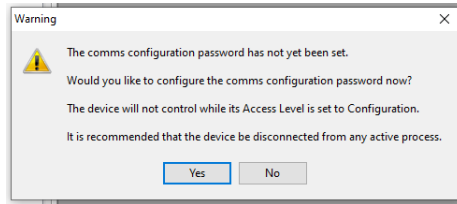

informing the user that they need to configure the Comms Configuration password before being able to proceed. Selecting 'Yes' will automatically launch the iDevPWSetup tool.

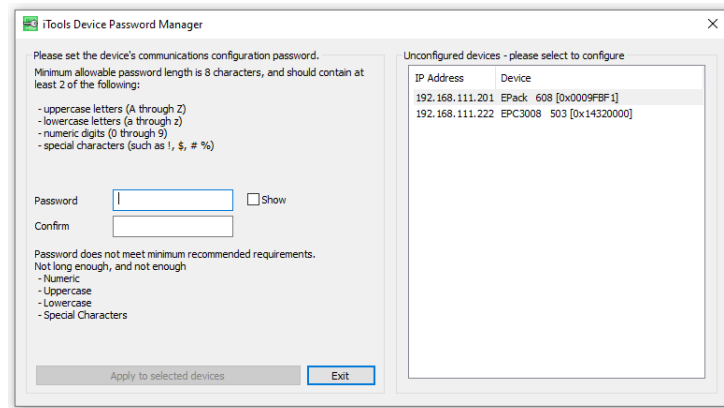

Note the following:

- The Comms Password is required to be at least eight characters in length
- It is required that the password uses two out of the four following character types:
 - UPPER CASE [A-Z]
 - lower case [a-z]
 - numeric [0-9]
 - special characters [! \$ # %, etc]

The Comms Password can be changed at any time assuming current Comms Password is provided (see "Access menu" on page 131).

Fuse Holders Contact Data (Fuse Ordering Code HSM)

⚠ **DANGER**

HAZARD OF ELECTRICAL SHOCK, EXPLOSION OR ARC FLASH

- Do not exceed the device's ratings.
- The relay output and the fuse holders contacts are compliant to the SELV requirements; they can be connected to SELV, PELV circuit or to voltage up to 230V (maximum value of rated operational voltage to earth:230V).

Failure to follow these instructions will result in death or serious injury.

SELV is defined (in IEC60947-1) as an electrical circuit in which the voltage cannot exceed 'ELV' under normal conditions or under single fault conditions, including earth ground faults in other circuits.

The definition of ELV is complex as it depends on environment, signal frequency, etc. See IEC 61140 for further details.

If fuse ordering code HSM has been selected, the fuses holder is delivered with a contact kit which provides indication if the fuse is blown or missing. This is shown locally on the fuseholder by a red handle which also activates microcontacts. These contacts may be wired to a digital input on the E-Pack as shown in the following diagrams.

Fuses Holders Contacts Kit are delivered with NO, NC contact.

Fuse in fuse holder and not blown
The handle and contacts are in the closed state

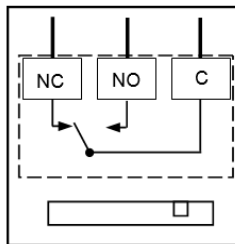

Fuse missing or fuse blown
The handle is open and shown red. The contacts are in open state

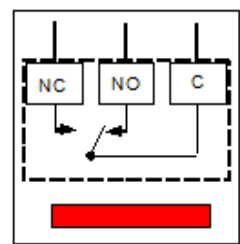

- Connection: Faston lugs 2.8 x 0.5mm (0.11 x 0.02in)
- Rated insulation voltage: 250VAC
- Rated operational current following IEC 60947-5 & -1
- Utilization category AC15: 4A/24V, 4A/48V, 3A/127V, 2.5A/240V
- Utilization category DC13: 3A/24V, 1A/48V, 0.2A/127V, 0.1A/240V

For contact kit reference according to product rating see Table 8 or Table 9.

Contact kit Mersen Y227928A, for fuse size 14x51 or Contact kit Mersen G227959A for fuse size 22x58.

Minimum operational current and voltage: 1mA/4V AC or DC.

- These contacts are compatible with Digital inputs configured in contact closure mode.

Recommended wiring:

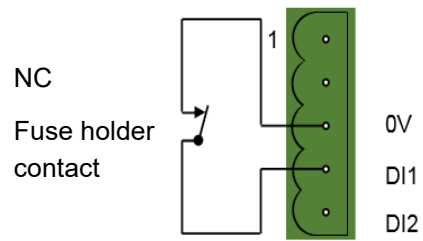

For contact kit Mersen E227612A, for fuse size 27x60

Minimum operational current and voltage: 100mA/20V AC or DC

- These contacts are not compatible with Digital inputs configured in contact closure mode.
- These contacts are compatible with Digital inputs configured in Voltage inputs with external dc power supply and load 100 mA dc minimum.

Recommended wiring:

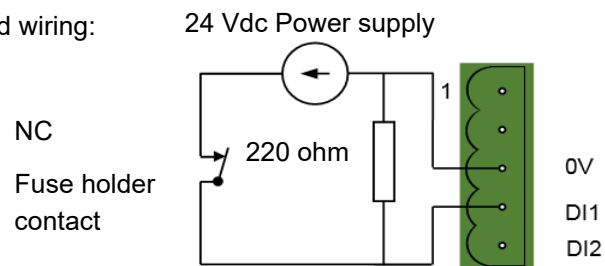

Operator Interface

Located at the front of the Driver Module, the operator interface consists of a square display, and four pushbutton switches.

Display

The display is divided vertically into three areas, which for the purposes of this manual are called the status area at the top, the data display, in the center, and the soft keys at the bottom. This display, together with the four pushbuttons allows full operation and configuration of the unit.

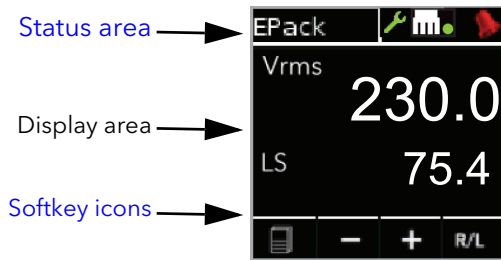

Figure 12 Operator interface

The figure above shows a typical operator mode screen. The other available screens are scrolled through using the return (page) pushbutton. The configuration of the unit defines which parameters actually appear.

The screens are displayed in the following order:

1. E-Pack Main Screen (as shown in the figure)
2. Meas menu
3. Alarms menu
4. Comms menu
5. DI Stat
6. Access menu

Notes:

1. The Alarms display appears only if there are any active alarms. The up/down arrow pushbuttons can be used to scroll through the alarm list, if there are more alarms active than can be displayed on one screen height.
2. The 'Goto' item allows the user to enter Engineer or Configuration mode, providing the passwords are known. [Access menu \(page 131\)](#) describes the procedure (although the screen displays are different because in that section, the unit is shown in configuration mode).

Status area

This area at the top of the screen contains text descriptive of the current operation, and a number of icons as follows



Configuration key. Displayed when the unit is in configuration mode.



Ethernet connection key. If upper connector on the front panel has an active network connection, then the upper of the two green dots is illuminated. If the lower connector has an active Ethernet connection, then the lower spot is illuminated.



Alarm symbol. Indicates that one or more alarms is active.

Softkey icons

A number of icons can appear at the bottom of the display, and each icon represents the action of the pushbutton immediately below it.



Menu. This appears in the bottom left corner, and operation of the Return pushbutton causes the top level menu to appear.



Return. This red cross icon appears in the bottom left corner, and operation of the Return pushbutton causes any configuration changes on the current page to be 'undone' or, if none, causes the display to 'go up' one level.



Plus and minus icons. Operation of the associated scroll up/down pushbutton causes the displayed value to increment or decrement.



Up/down arrows. Operation of the associated scroll up/down pushbutton causes the various menu items on display to be scrolled through.



Right/Left arrow. The right-pointing arrow appears in the bottom right-hand corner, and operation of the Enter pushbutton causes the cursor to shift right. Once this has been done, a left-pointing arrow appears in the bottom left-hand corner, allowing the user to shift the cursor to the left using the Return pushbutton.



Enter. This green tick appears in the bottom right corner, and operation of the Enter pushbutton causes any configuration change(s) on the display page to be confirmed.



Remote/Local. This appears in the bottom right corner, and operation of the Enter pushbutton toggles the setpoint selection between local and remote.

Pushbuttons

The functions of the four pushbuttons below the display depend on what is displayed in the softkey area. The leftmost pushbutton (Return) is associated with the leftmost soft key, the down arrow pushbutton is associated with the next soft key and so on. In the example above, the 'Return' key is used both to enter the Menu, and to return from it to the initial display.

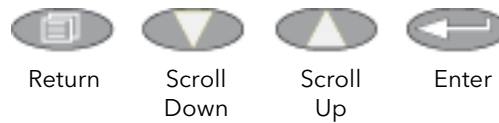

Pushbutton functions

Return	Returns to previous menu (while menus are displayed), cancels editing (during parameter editing), and performs screen cycling (during operator mode).
Scroll down/up	Allows the user to scroll through the available menu items or values.
Enter	Goes to next menu item. In parameter edit mode, this button confirms the changes.

Menu item value selection

Menu items are scrolled through using the up/down pushbuttons. Once the required item is displayed, the Enter pushbutton is used to select it for editing. Editing of the item's value is carried out by scrolling through the available choices, using the up and down scroll keys. Once the desired value is displayed, the Enter pushbutton is used to confirm the choice.

Where multiple changes have to be made (as in editing an IP address for example), the Enter pushbutton acts as a right cursor key, moving from the field just edited to the next field. (The Return pushbutton moves the cursor left). Once all fields have been edited, the Enter pushbutton is used a final time to confirm the choice.

Front Panel Event Indication

A number of instrument alarms and events can occur, and these are indicated by icons appearing on the display screen. The events and alarms are listed below. See [Alarms \(page 224\)](#) for a more details.

Instrument events

Conf Entry	The instrument has been placed in configuration mode (cogwheel symbol).
Conf Exit	The instrument has been taken out of configuration mode (no icon).
GlobalAck	A global acknowledgement of all latched alarms has been performed.
Quick Code Entry	The Quick Code menu is active (cogwheel icon + 'QCode' in display area).

The following alarms all cause a red bell icon to appear in the top right hand corner of the screen.

Indication alarms

LoadOverl	An over current alarm has become active in one or more Network blocks.
-----------	--

System alarms

ChopOff	The 'Chop-off' alarm has been detected.
FuseBlown	There is no internal fuse, but it is possible to use DI2 as a 'fuse-blown' input wired to the alarm block in iTools.
MainsFreq	Mains Frequency is outside the acceptable range.
Missmains	Supply power is missing.
NetwDip	The 'network dip' alarm has been detected.
Thyr SC	Thyristor short circuit. It is not possible to detect a thyristor short circuit when the unit is delivering 100% output power.

Process alarms

ClosedLp	The Control block 'Closed Loop' alarm has been detected.
Ana_In Over C	Over current in shunt. If this alarm is detected, firing is stopped by default and Analog Input type is automatically switched to 0-10V mode to avoid damage.
Under Volt	Line under voltage
Over Volt	Line over voltage (configurable between 2 and 10% of nominal voltage)
PLF	The 'Partial Load Failure' alarm has been detected.
TLF	The 'Total Load failure' alarm has been detected.

Quickcode

At first switch-on, the E-Pack unit enters the 'QuickCode' menu which allows the user to configure the major parameters without having to enter the full configuration menu structure of the unit. Figure 13 shows an overview of a typical QuickCode menu. The actual displayed menu items will vary according to the number of software features purchased. When 'Finish' is selected to 'Yes', the instrument cold starts after confirmation (Enter key); when set to 'Cancel' the instrument discards any changes and restarts with the previous configuration.

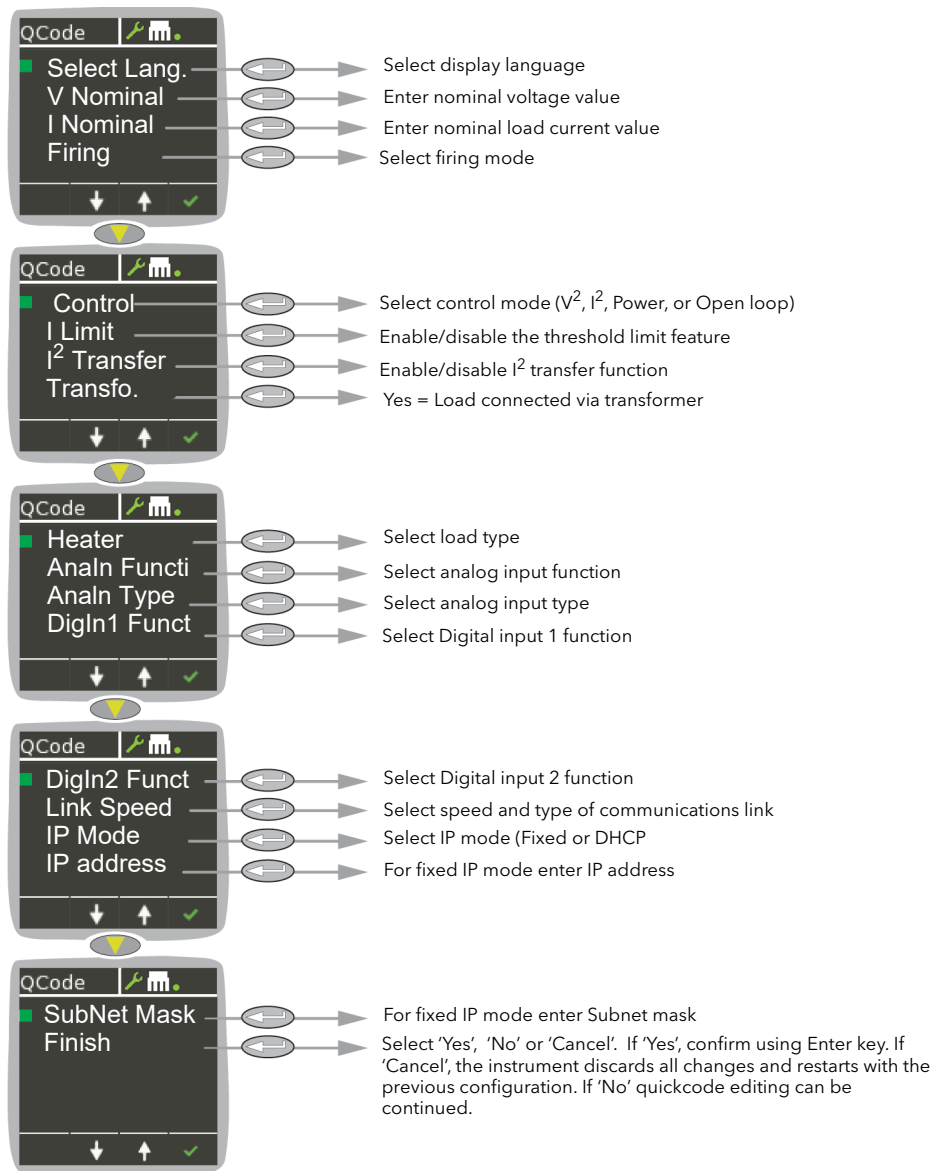

Figure 13 Typical QuickCode menu

Notes:

1. If the unit has been fully configured at the factory, the Quickcode menu will be skipped, and the unit will go into operation mode at first switch on.
2. Once quit, the Quickcode menu can be returned to at any time from the Access menu (described later in this document ([Configuration using iTools \(page 133\)](#))). Returning to the Quickcode menu cold-starts the unit.

Quickcode Menu Parameters Description

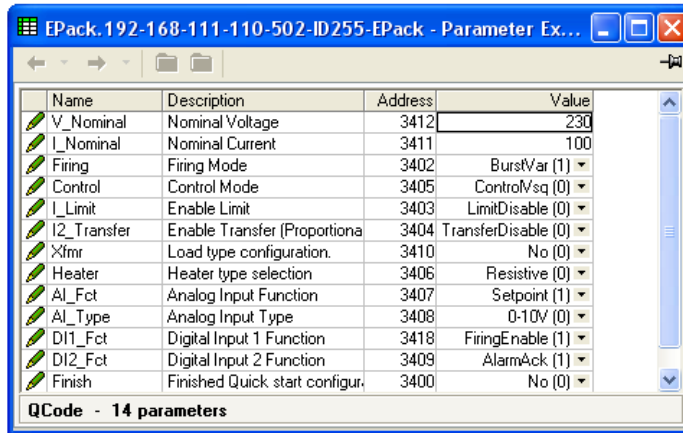

Figure 14 iTools Qcode page

- Language Select English, French, German, Italian or Spanish. Once confirmed all further displays appear in the selected language.
- V Nominal The nominal value of the supply voltage (valid entries are 20V to 500V). Default value appears. Use the up/down arrow buttons to edit.
- I Nominal The current flowing through the load according to the nominal load power. This current must not exceed the maximum current the unit has been designed for. Lower values are not recommended as in such cases, the resulting accuracy and linearity may not be within specification. Default value appears. Use up/down arrow buttons to edit.
- Firing Mode Select from IHC (Intelligent Half Cycle), Burst Var (Burst Variable), Burst Fix (Burst Fixed), Logic or Phase Angle.
- Control Select VSq (V²), Isq (I²), Power (P) or Open Loop
- ILimit This is used to enable/disable threshold limit. (By default the current limit function is enabled).

DANGER

HAZARD OF FIRE

- The current limit function by phase angle reduction is not available with Intelligent Half Cycle (IHC). Select the product current rating greater than or equal to the MAXIMUM current of the load.

Failure to follow these instructions will result in death or serious injury.

- I²Transfer This is used to enable/disable the transfer feature. Quick code configures squared current as the transfer process value.
- XFMR (Transfo.) No = Resistive load type; Yes = Transformer primary.

WARNING

UNINTENDED EQUIPMENT OPERATION

- At commissioning, ensure correct product configuration.

Failure to follow these instructions can result in death, serious injury or equipment damage.

For transformer Load, select XFMR as Load Type (select Yes for Transfo. in quick code).

For transformer Load, in burst firing mode, without soft start, adjust Delayed Triggering (DelayedTrigger) to minimize inrush current.

Heater Select from Resistive, (Short wave) Infra red, CSi (Silicon carbide) or MOSi2 (Molybdenum disilicide).

DANGER

HAZARD OF FIRE

- With SWIR Load, if a fast response time is required, or if IHC firing mode has been selected, select SWIR (Infrared) as Heater type.
- If SWIR is selected as Heater type, select the product current rating greater than or equal to 125% of MAXIMUM current of the SWIR load WITHOUT taking in account the inrush current.
- If SWIR is selected as Heater type, adjust the duration of the safety ramp (SafetyRamp), the cooling time of the load (SWIRLoadCoolingTime) and the value of SWIR Load Cooling Threshold, to limit the RMS load inrush current SWIR to less than 2.5 times the product current rating.

Failure to follow these instructions will result in death or serious injury.

AnaIn Function Select SP (setpoint), HR (setpoint limit), CL (current limit), TS (transfer limit) or None (no function) as Analog Input function.

Note: Setpoint is only available for AnaIn Function if DI1 or DI2 Fct are not set to 'Setpoint' while Firing Mode is set to 'Logic'.

AnaIn Type Select 0 to 10V, 1 to 5V, 2 to 10V, 0 to 5V, 0 to 20mA or 4 to 20 mA as analog input type.

DI1 Fct Select 'Firing Enable', Alarm ack(nowledge), RemSP sel (select remote setpoint), Fuse Blown, Setpoint (in logic mode) or none.

Notes:

1. The function is available if not set in DI2.
2. Setpoint is only available for DigIn1 Function if AnaIn or DI2 Fct is not set to 'Setpoint' whilst Firing Mode is set to 'Logic'.

DI2 Fct Select Firing Enable, Alarm ack(nowledge), RemSP sel (select remote setpoint), Fuse Blown, Setpoint, 10V user output, Firing Enable or none.

Notes:

1. Setpoint is only available for DI1 Fct or DI2 Fct if AnaIn Function is not set to 'Setpoint' while Firing Mode is set to 'Logic'.
2. DI1 Fct and DI2 Fct are mutually exclusive.

Link Speed Select from 'AutoNego', 100Mb, 100Mb Half duplex, 10Mb, 10Mb Half duplex.

IP Mode Choose 'Fixed', 'DHCP' or 'DCP' (if Profinet feature enabled).

IP Address For fixed mode, allows the IP address to be edited, one section at a time. Use the up-down arrow pushbuttons to edit the first section (XXX.xxx.xxx.xxx), then 'Enter' to move to the next section (xxx.XXX.xxx.xxx) and repeat until all four sections are as required

SubNetMask As for IP address above, but for the subnet mask.

Finish If 'Yes' is selected (and confirmed using the enter key),

quick code exits and the instrument restarts with the new configuration. If 'No' is selected then no action is taken and the user can continue to edit the quick code parameters. If 'Cancel' is selected then all changes are discarded, quick code exits and the instrument restarts with the previous (i.e. unedited) configuration.

Firing modes definitions

Logic

Power switches on, two or three zero crossings of the supply voltage after the logic input switches on. Power switches off, two or three zero crossings of current after the logic input switches off. For resistive loads, voltage and current cross zero simultaneously. With inductive loads, a phase difference exists between the voltage and current, meaning that they cross zero at different times. The size of the phase difference increases with increasing inductance.

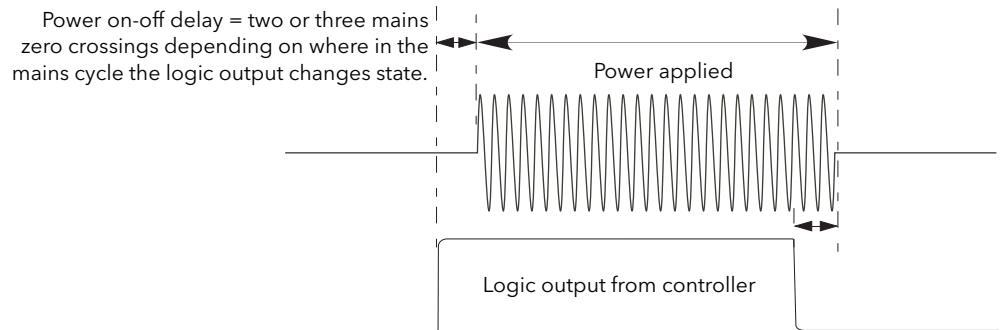

Figure 15 Logic firing mode

Burst Fixed Firing

This means that there is a fixed 'cycle time' equal to an integer number of supply voltage cycles as set up in the Modulator menu. Power is controlled by varying the ratio between the ON period and the OFF period within this cycle time (Figure 16).

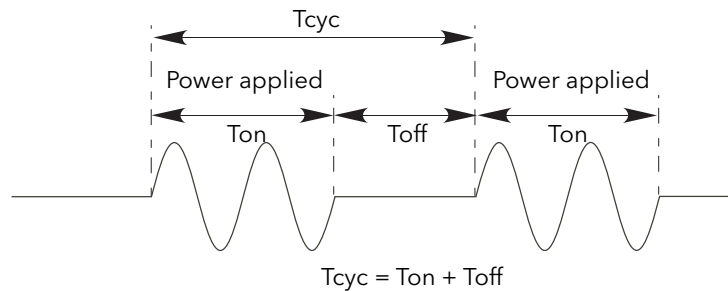

Figure 16 Burst Fixed mode

50% Duty Cycle

The firing and non-firing time corresponds to a single supply cycle (Figure 19).

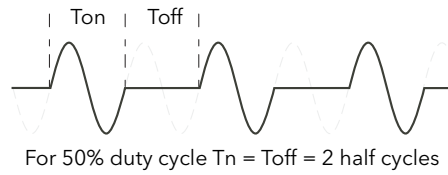

Figure 19 Intelligent half cycle mode: 50% duty cycle

33% Duty Cycle

For duty cycles less than 50%, the firing time is one half-cycle. For a 33% duty cycle, firing time is one half cycle; the non-firing time is two half-cycles (Figure 20).

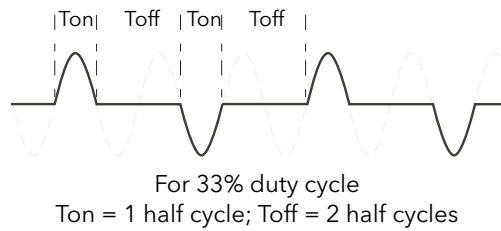

Figure 20 Intelligent half cycle mode: 33% duty cycle

66% Duty Cycle

For duty cycles of greater than 50%, the non-firing time is one half-cycle. For 66% duty cycle, the firing time is two half cycles; the non-firing time is one half cycle (Figure 21).

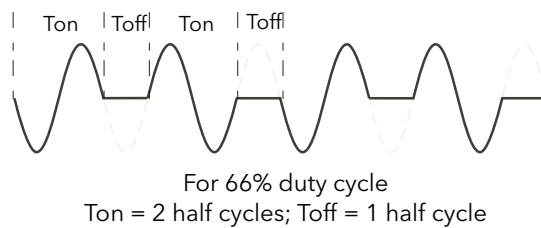

Figure 21 Intelligent half cycle mode: 66% duty cycle

Feedback type

All feedback types (except 'Open Loop') are based on real-time measurement of electrical parameters that are normalized to their equivalent Nominal values.

V^2	Feedback is directly proportional to the square of the RMS voltage measured across the load.
Power	Feedback is directly proportional to the total true power delivered to the load network.
I^2	Feedback is directly proportional to the square of the RMS current through the load. For two- or three-phase systems, feedback is proportional to the average of the squares of the individual RMS load currents.
Open loop	No measurement feedback. The thyristor firing angle in Phase angle mode, or the duty cycle in burst-firing mode, are proportional to the setpoint.

Note: V_{rms} and I_{rms} require a specific wiring, with iTools GWE, in Burst mode. Contact your local distributor.

Transfer Mode

The control system can use automatic transfer of certain feedback parameters. For example with loads with very low cold resistance, I^2 feedback should be used to limit inrush current, but once the load has started to warm up, Power feedback should be used; the control program can be configured to change feedback mode automatically.

The Transfer mode can be selected as I^2 to P as appropriate to the type of load being controlled.

None	No feedback parameter transfer to the control program.
I^2	Selects transfer mode: I^2 to the selected Feedback Mode (above).

Limitation features

This limiting is implemented using phase angle or duty cycle reduction depending on the type of control (e.g. phase angle, burst firing).

To prevent damage on some particular applications the 'chop off' function can be used.

Note: The limiting function 'Chop-Off' is considered an 'Alarm' in EPack.

In order, for example, to prevent potentially damaging inrush currents, it is possible to set a value for power or Current squared which is not to be exceeded during the mains period. For this case, limitation has to be configured to run by phase angle reduction.

For loads exhibiting a low impedance at low temperatures but a higher impedance at working temperature, the current drawn reduces as the load warms, and limiting gradually becomes unnecessary.

[Control limit configuration \(page 143\)](#) describes the configuration parameters which allow the user to enter a Process Variable (PV) and a setpoint (SP), where the PV is the value to be limited (e.g. I^2) and the SP is the value that the PV must not exceed.

Firing Angle Limiting (in Phase Angle mode)

For phase angle control, limiting is achieved by reducing the firing angle on each half mains cycle such that the limit value of the relevant parameter is not exceeded. Limiting is reduced, by the firing angle gradually increasing, until the target setting is achieved.

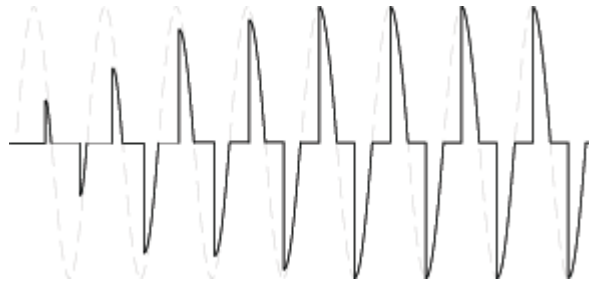

Firing Angle Limiting (in Burst mode)

In Burst Mode limiting can also be achieved by reducing firing Angle during the ON time such that the limit value of the relevant parameter is not exceeded.

In this way the PV must not exceed the limit SP during the ON time. We get 'Burst of Phase Angle'. See following figure.

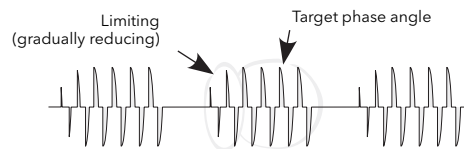

Duty Cycle Limiting (in Burst mode)

For Burst Firing only, limiting reduces the ON state of the burst firing driving the load. Load current, voltage and active power are calculated over the period of each (Ton + Toff) period.

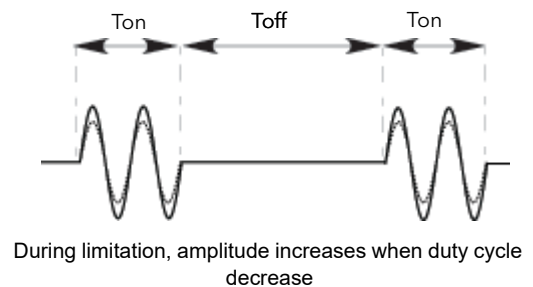
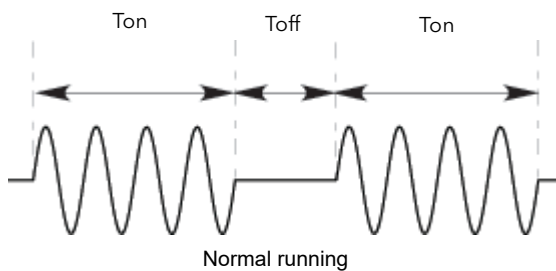

⚠ **DANGER**

HAZARD OF FIRE

- WITHOUT Current limit function by phase angle reduction, if SWIR (Infrared) is NOT selected as Heater type, select the product current rating greater than or equal to the MAXIMUM current of the load.

Failure to follow these instructions will result in death or serious injury.

Calculate the maximum current of the load by taking account of load resistive tolerance (tolerance and variation due to temperature) and voltage tolerance.

Current limit function by phase angle reduction may be selected to limit the inrush current of the load and reduce the current rating of the product (select "Enable" for "I Limit" In quick code).

DANGER

HAZARD OF FIRE

- WITH Current limit function by phase angle reduction, select the product current rating greater than or equal to the nominal current of the load .
- Setting of current limit function by phase angle reduction must be lower or equal to product current rating..
- The current limit function by phase angle reduction is not available with Intelligent Half Cycle (IHC). Select the product current rating greater than or equal to the MAXIMUM current of the load.
- Duty cycle current limiting features (in burst mode), does not limit the peak current value. Select the product current rating greater than or equal to the MAXIMUM current of the load.

Failure to follow these instructions will result in death or serious injury.

Chop Off Definition

This is a technique which detects an over-current alarm state and stops further thyristor firing for the duration of that alarm state. All the relevant parameters are to be found in the "Network Setup configuration" on page 182.

The conditions that trigger a Chop Off alarm are:

1. When the ChopOff Threshold exceeds the number of times specified in NumberChop Off parameter. (NumberChop Off can be specified to any value between 1 and 255 inclusive). See [page 182](#) for further details. The ChopOff Threshold is adjustable between 100% and 350% inclusive of INominal.

When the alarm is triggered the unit stops firing and raises a chop off alarm. Firing is not resumed until the operator acknowledges the Chop Off alarm, to restart.

Communications

Field Device Tool (FDT) and Device Type Manager (DTM) Support

EPack supports FDT/DTM feature. Therefore the unit can be managed by any FDT container:

1. Install the latest version of iTools, which will include the latest iTools DTMs.
2. Install a FDT container e.g. PACTware (<https://www.se.com/ww/en/download/document/FD-SOFT-M-026/>).
3. Install a ModbusTCP CommDTM (<https://www.se.com/ww/en/download/document/Modbus+Communication+DTM+Library/>).
4. Run FDT container and update DTM catalog to make latest products available:

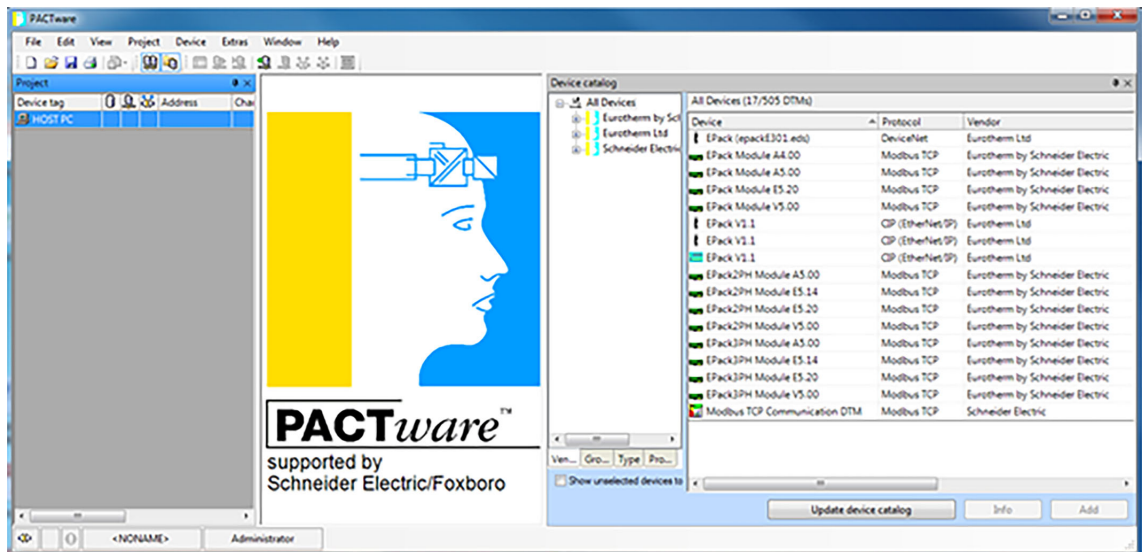

Note: For more information about installation of your FDT container refer to the user manual.

5. Drag and drop both ModbusTCP Communication DTM and the product you want to connect, EPack, from the product catalog to the Project window.

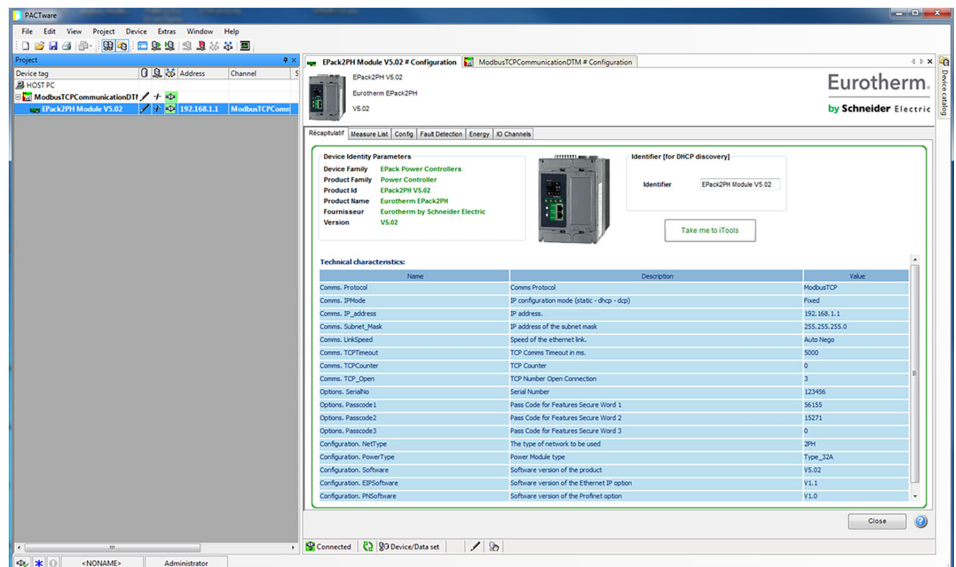

6. Set the IP address of your product in ModbusTCP communication DTM.

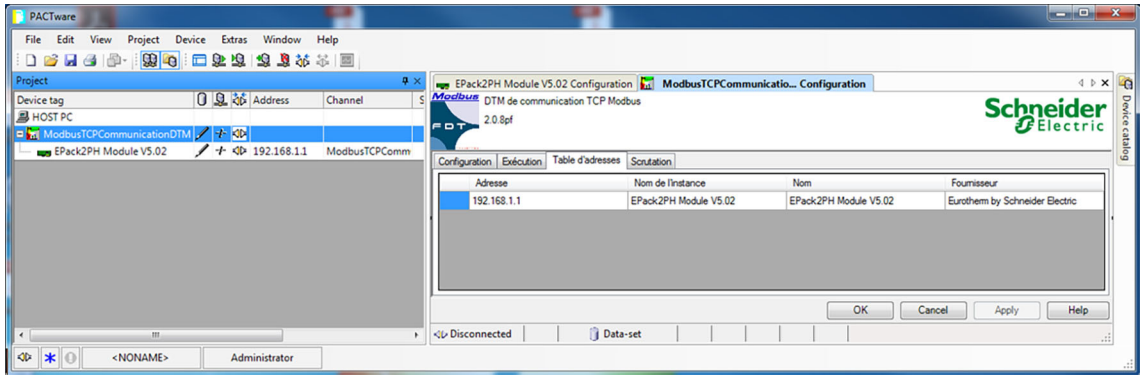

7. Ensure the Project DTM module i.e. (ModbusTCPCommunicationDTM) is selected, select right mouse button and click *Connect*.

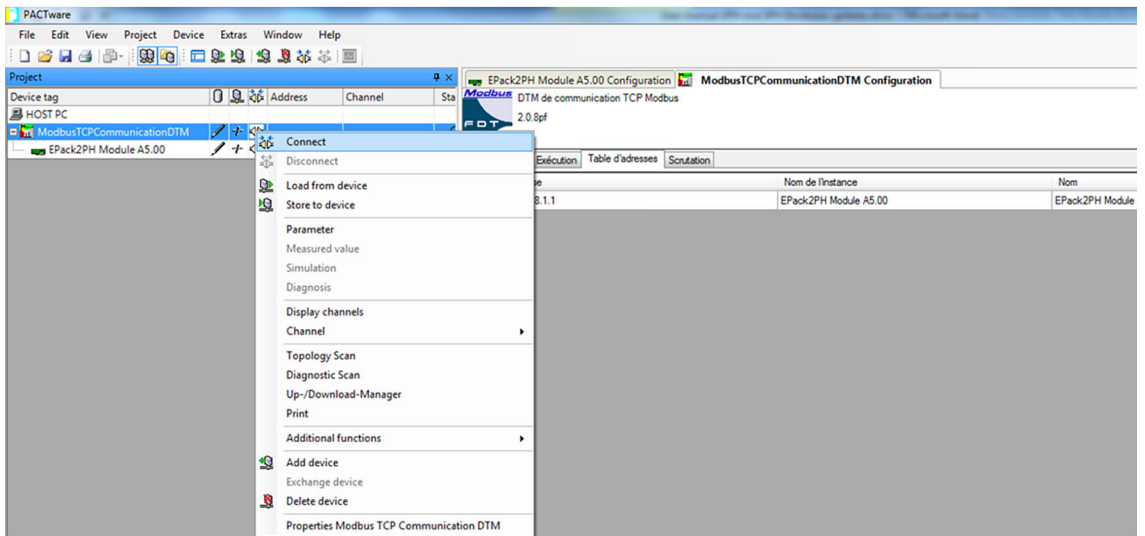

8. A batch of parameters can then be monitored from the FDT container and the *Take me to iTools* button can be used to open and configure parameter values using iTools.

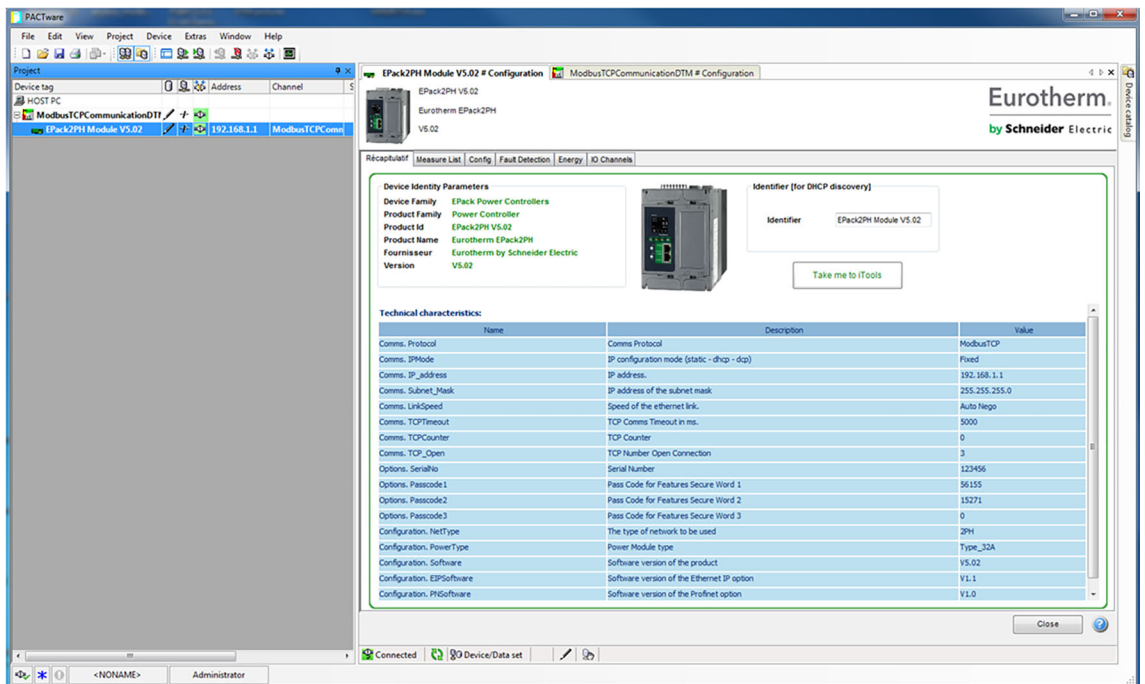

EtherNet/IP

Introduction

EPack EtherNet/IP (Ethernet/Industrial Protocol) is a 'producer-consumer' communication system used to allow industrial devices to exchange time-critical data. Such devices range from simple I/O devices such as sensors/actuators, to complex control devices such as robots and PLCs. The producer-consumer model allows the exchange of information between a single sending device (producer) and a large number of receiving devices (consumers) without having to send data multiple times to multiple destinations.

EtherNet/IP makes use of the CIP (Common Industrial Protocol), common network, transport and application layers currently implemented by DeviceNet and ControlNet. Standard Ethernet and TCP/IP technology is used to transport CIP communications packets. The result is a common, open application layer on top of Ethernet and TCP/IP protocols. The EPack power controller can be directly included in an Ethernet/IP configured installation, with the Ethernet/IP option enabled, (a chargeable feature), see [Network Communications \(page 50\)](#).

EPack Power Controller, in common with other Eurotherm controllers, has available a large number of potential parameters but practical systems are constrained by the total I/O space available in the master being used and by the amount of traffic permissible on the network. A limited number of predefined parameters have, therefore, been made available in EPack controller but it is possible to add non-defined parameters as required by a particular process. This is described in [Data Exchange Mapping \(page 75\)](#). Specific hardware must be used for the master such as an Allen-Bradley PLC.

NOTICE
<p>UNINTENDED EQUIPMENT OPERATION</p> <ul style="list-style-type: none">• When ordering the product, select the appropriate communication protocol or make sure it is available as a software upgrade option. <p>Failure to follow these instructions can result in non-functional equipment.</p>

EtherNet/IP protocol is not available as software upgrade option on product with EtherCAT communication. Do not order EtherCAT communication if EtherNet/IP protocol is required.

The PROFINET protocol and the EtherNet/IP protocol cannot be used together. Select one of the appropriate Protocol among the different options.

EtherNet/IP protocol is available as software upgrade option on product with ModbusTCP communication protocol and PROFINET protocol.

EPack supports the Modbus/TCP protocol whatever the communication protocol is.

EPack Power Controller EtherNet/IP Features

The EtherNet/IP implementation features in EPack power controller include:

- 10/100Mb, full / half duplex operation: auto sensing
- Galvanically isolated bus electronics
- A selectable software option, at configuration
- Implicit (Polled) I/O messaging connection

CIP Object Support

Class (hex)	Name
01	Identity Object
02	Message Router Object
04	Assembly Object (32 inputs / 16 outputs <=> E-Pack's Fieldbus I/O Gateway)
06	Connection Manager Object
0F	Parameter Object (Optional)
F5	TCP/IP Interface Object
F6	Ethernet Link Object (Optional)

Setting Up the E-Pack Power Controller Unit

It is recommended that the communications settings for each instrument are set up before connecting it to any EtherNet/IP network. This is not essential but network conflicts may occur if the default settings interfere with equipment already on the network.

For the EtherNet/IP instrument the IP address, subnet mask, default gateway and DHCP enable need to be configured.

Changing any one of these parameters may immediately move the instrument to a new state. For this reason, it is recommended that such changes are made offline, before connecting to an EtherNet/IP network.

IP Addresses are usually presented in the form "abc.def.ghi.jkl". In the E-Pack Comms folder IP is represented using this standard, see below;

Pr	Nom	Description	Adresse	Valeur	Connexion de
🚩	Hostname	Name of the device on the link-local network.	3136	epk000A8D390002	
🚩	SRVname	MBUS name	3118	MODBUS_Epack[000A8D390002]	
🚩	IPMode	IP configuration mode (static - dhcp)	3109	Fixe (0) ▾	
	IPStatus	Status of the IP address	3111	0	
	IP	Current IP of the instrument	3114	192.168.0.25	
	cSubNetMas	Current SubNet mask IP	3115	255.255.255.0	
	cDefault_Gat	Current Default Gateway IP address	3116	192.168.0.1	
	PrefMaster	Preferred Master IP address	3105	192.168.0.1	
	Address	Adresse Comms	3101	255	
🚩	IP_address	IP address.	3102	192.168.0.25	
🚩	Subnet_Mas	IP address of the subnet mask	3103	255.255.255.0	
🚩	Default_Gate	IP address of the default gateway	3104	192.168.0.1	
	MAC12	Adresse MAC 1	3106	2560	
	MAC34	Adresse MAC 2	3107	14733	
	MAC56	AdresseMAC3	3108	512	
	Timeout	Comms Timeout in ms.	3110	5000	
	Fallback1	Fallback1	3112	1	
	Fallback2	Fallback2	3113	0	
	EnTimeout	Timeout Enable	3117	Sans (0) ▾	
	Protocol	Protocole Comms	3100	ModbusTCP (0) ▾	
	IOgateway	IO Gateway Access	4744	0	
🚩	LinkSpeed	Speed of the ethernet link.	3149	Auto Nego (0) ▾	
	TCPTimeout	TCP Comms Timeout in ms	3150	5000	

They can also be entered using iTools under this form 'abc.def.ghi.jkl'.

This also applies to the SubNet Mask and Default Gateway IP Address.

In E-Pack controller units MAC addresses are shown as three separate hexadecimal values on an E-Pack instrument itself or decimal values in iTools. MAC1 shows the first address value (aa), MAC2 shows the second address value (bb) and so on.

Dynamic IP Addressing

IP addresses may be 'fixed' - set by the user, or dynamically allocated by a DHCP server on the network. When IP addresses are dynamically allocated the server uses the instrument MAC address to uniquely identify them.

To configure dynamic IP addressing, the user must first set the IPMode parameter to *DHCP*.

Once connected to the network and powered, the instrument will acquire its "IP address", "SubNet Mask" and "Default Gateway" from the DHCP Server automatically and display this information within a few seconds.

Note: If the DHCP server does not respond (in common with other Ethernet appliances in this situation) the unit will not be accessible via the network. Instead, the unit will default to an automatic IP mode with an IP address in the range of 169.254.xxx.xxx.

Fixed IP Addressing

IP addresses may be 'fixed' - meaning the user manually enters the IP address and SubNet Mask values, which will remain unchanged, before connecting the instrument to the network.

To configure fixed IP addressing, the instrument must be powered and the user must first set the IPMode parameter to *Fixed*.

Then set the IP address and SubNet Mask as required, to configure a fixed IP address, see [Comms menu \(page 114\)](#).

Default Gateway

The "Comms" folder also includes configuration settings for "Default Gateway". These parameters will be set automatically when Dynamic IP Addressing is used. When fixed IP addressing is used these settings are only required if the instrument needs to communicate wider than the local area network.

Figure 22 shows the appearance of Ethernet/IP User Comms configuration parameters in iTools:-

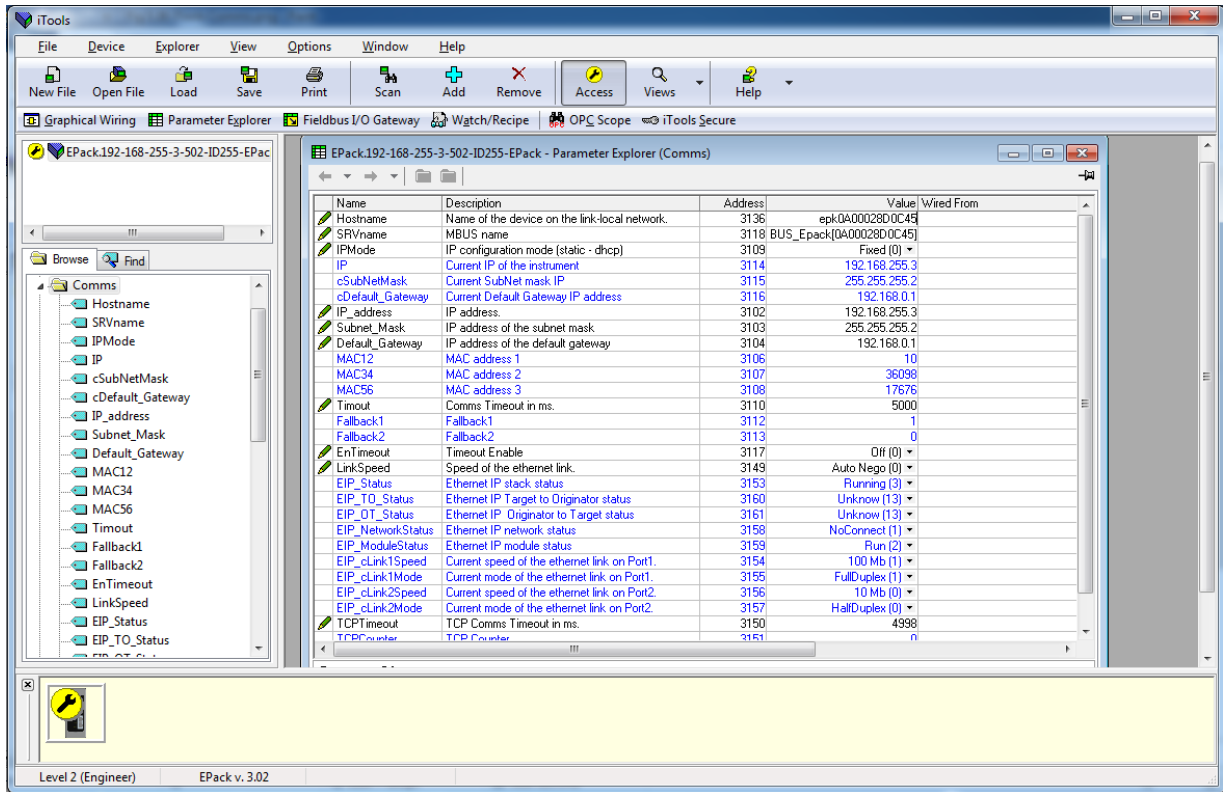

Figure 22 Ethernet/IP User Comms configuration parameters

Data Exchange Mapping

Up to 32 input and 16 output parameter variables may be included in the Ethernet/IP cyclic (implicit) data exchange.

By default, the most frequently used values are included, but it is possible to select other parameters within the unit. The default mapping is as follows:

Input Definition	Output Definition
FaultDetAnyAlarm	SetProv.Remote2
Control.Main.PV	
Control.Main.SP	
Network.Meas.I	
Network.Meas.V	

Input and Output Parameters are 16 bits (2 bytes) each.

To set up the EPack controller unit so that the desired parameters can be read and written involves setting up the INPUT and OUTPUT data tables. This is carried out using iTools.

Configuring the Cyclic (Implicit) Data Exchange

The Ethernet/IP master may be required to work with many diverse slaves from different manufacturers and with different functions. Furthermore, EPack controller units contain many parameters most of which will not be required by the network master for a particular application. It is, therefore, necessary for the user to define which Input and Output parameters are to be available on the Ethernet/IP network. The master may then map the selected device parameters into the PLC input/output registers.

Values from each slave, 'Input Data', are read by the master, which then runs a control program. The master then generates a set of values, 'Output Data', into a pre-defined set of registers to be transmitted to the slaves. This process is called an 'I/O data exchange' and is repeated continuously, to give a cyclical I/O data exchange.

The Input/Output definitions for Ethernet/IP are configured using iTools.

Select the 'Fieldbus I/O Gateway' tool from the lower toolbar, and an editor screen will appear similar to that shown in [Figure 23](#).

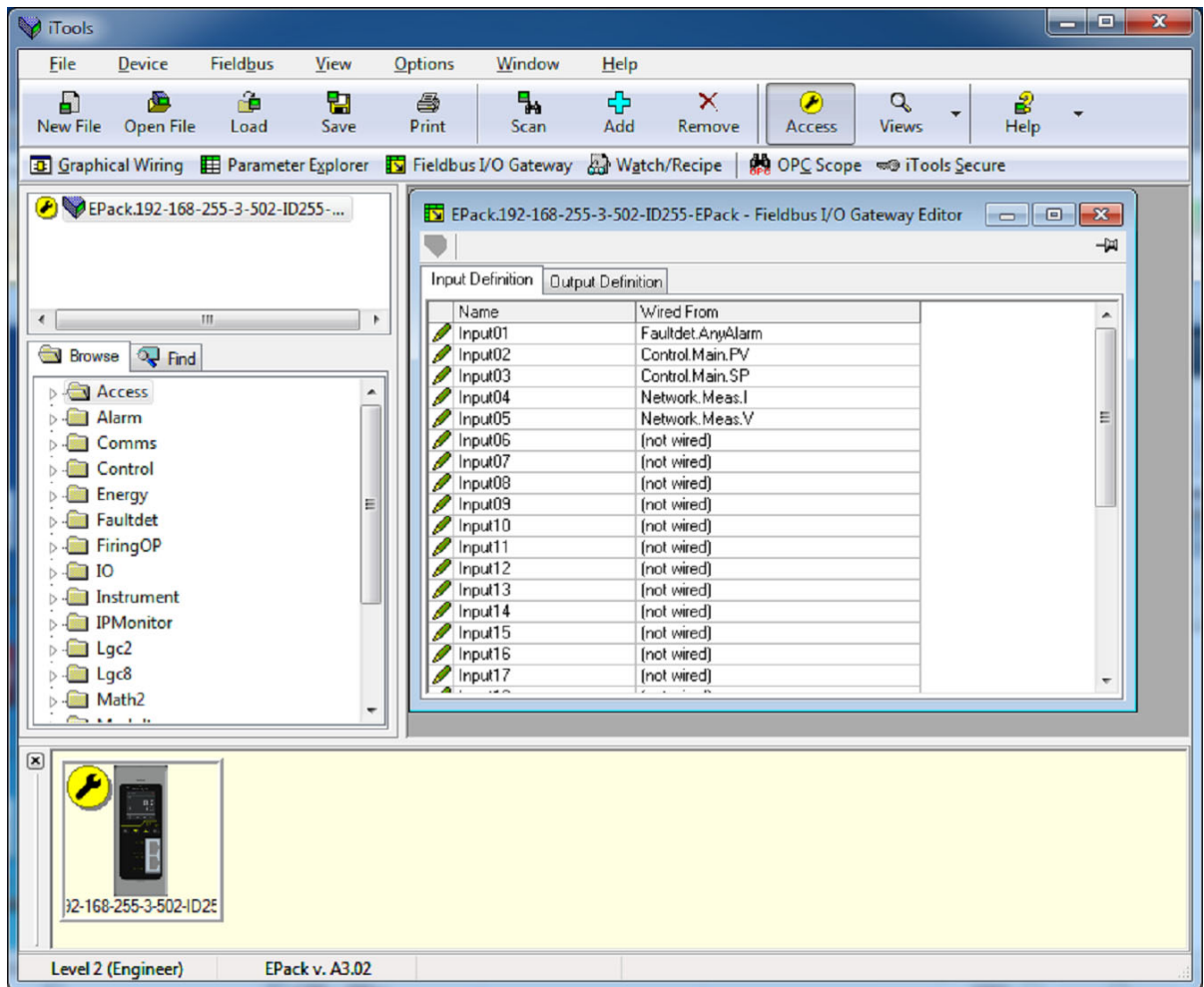

Figure 23 The I/O (Fieldbus I/O Gateway) Editor in iTools

There are two tabs within the editor, one for the definition of Inputs, and the other for Outputs. 'Inputs' are values sent from the EPack controller to the Ethernet/IP master, for example, alarm status information or measured values, i.e. they are readable values.

Note: The Input and Output buffer should not be empty. At least one parameter should be selected so the data cyclic exchange functions correctly.

'Outputs' are values received from the master and used by the EPack controller, for example, setpoints written from the master to EPack controller. Note that Outputs are written on every Ethernet/IP cycle, which is frequent (of the order of 100ms), and so values from Ethernet/IP will overwrite any changes made on the EPack controller keypad unless special measures are taken to prevent this.

The procedure for selecting variables is the same for both input and output tabs. Double click the next available position in the input or output data and select the variable to assign to it. A pop-up provides a browser from which a list of parameters can be opened. Double click the parameter to assign it to the input definition. Note that you should assign inputs and outputs contiguously, as a 'not wired' entry will terminate the list even if there are assignments following it.

Figure 24 shows an example of the pop-up and the input list produced.

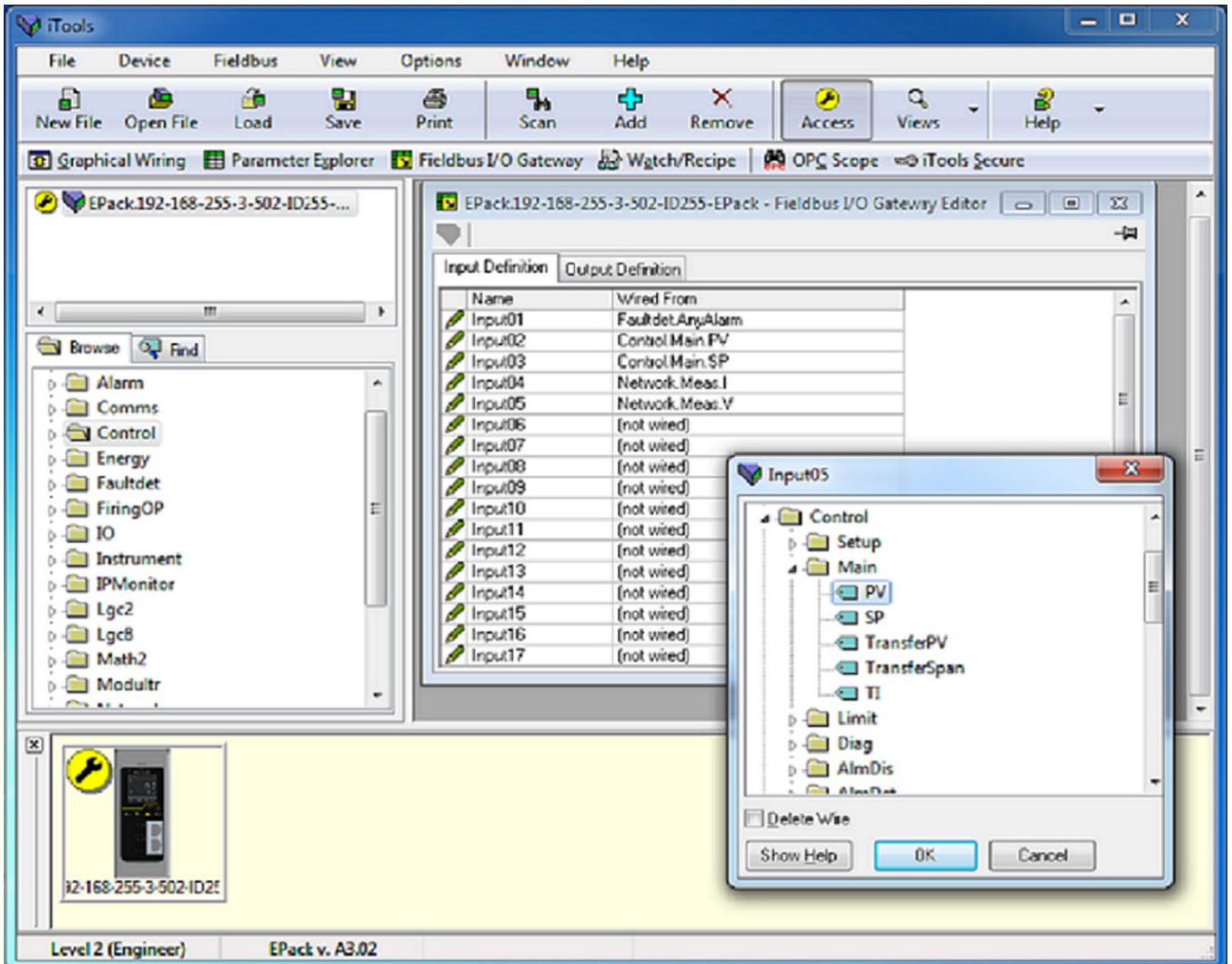



Figure 24 Selecting an Input Value and Example of an Input List

When the list is populated with the variables you require, record how many 'wired' entries are included in the input and output areas as this will be needed when setting up the Ethernet/IP Master. In the example above, there are five input values, each of two bytes in length, so a total of 10 bytes of data. Record this number, as it is required when setting the I/O length when configuring the Ethernet/IP master.

Note: No checks are made that output variables are writeable and if a read only variable is included in the output list, any values sent to it over Ethernet/IP will be ignored with no indication to the master.

Once the changes have been made to the I/O lists, they must be downloaded to the EPack controller unit.

This is done with the button on the top left of the I/O Editor marked .

The EPack controller Unit will need to be powered off and on again once this has been done for the changes to register.

The next step in the process is to configure the Ethernet/IP master.

Setting Up The Master

An example of a master may be a CompactLogix L23E QB1B PLC from Allen Bradley. With this example, there are two methods supplied to set up the PLC Ethernet/IP Master using;

- RSLinx (RSLinx Classic Lite & EDS Wizard)
- RSLogix 5000

Cyclic (Implicit) Data Exchange

Example: EDS file Import Wizard (RSLinx Tools)

It is necessary to import an EDS (Electronic Data Sheet) file. The EDS file is designed to automate the Ethernet/IP network configuration process by precisely defining the required device parameter information. Software configuration tools utilise the EDS file to configure an Ethernet/IP configuration.

It is available from your supplier, or electronically from EPack Power Controller Downloads.

EDS File Import

1. Connect EPack power controller to Rockwell Instrument.
2. Launch the EDS Hardware Installation Tool by selecting Start > All Programs > Rockwell Software > RSLinx > Tools.

The Rockwell Automation - Hardware Installation Tool displays.

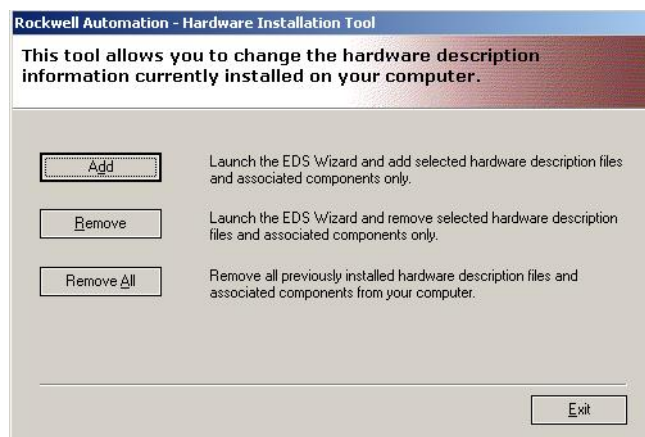

Figure 25 Hardware Installation Tool

3. Select *Add*.

- 4. Select *Register a single file* and click *Browse*.

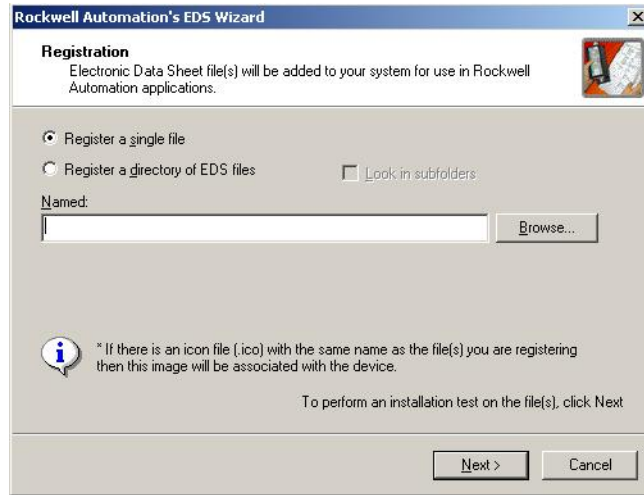

Figure 26 EDS file Registration

- 5. Navigate to and select file *EPack_V300.eds* stored locally, then click *Open*.

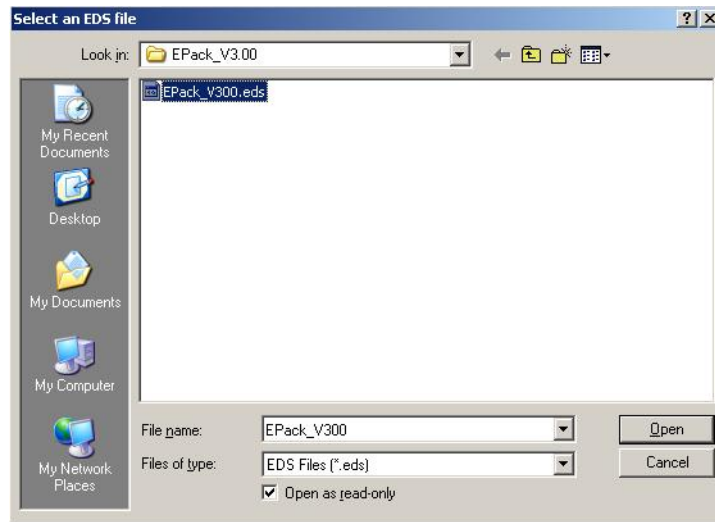

Figure 27 EDS file selection

- 6. Click *Next*. The EDS file installation test results are displayed, indicated by the green tick left of the file location in the below panel.

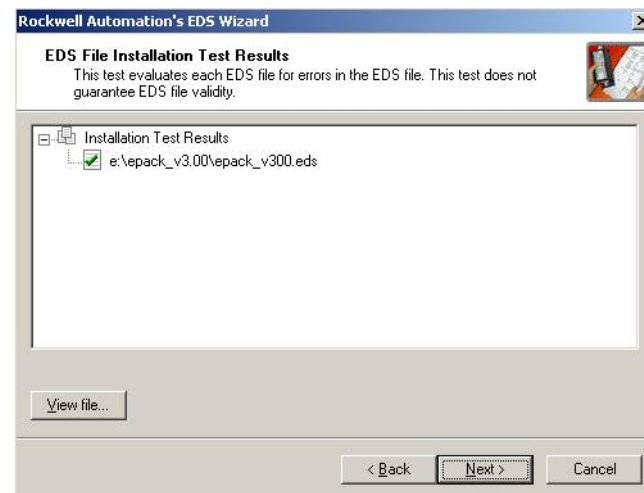

Figure 28 EDS file installation test results

7. Select *Next*.

The Change Graphic Image option appears. This stage allows user to change the icon associated with the device being set up. The EPack EDS file provides a default EPack icon, so no changes are required.

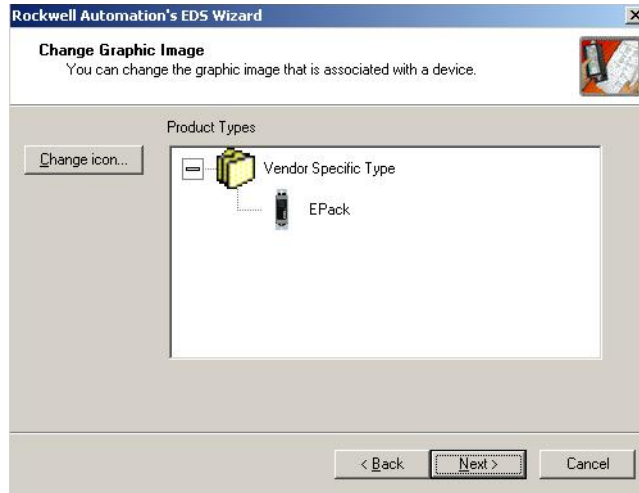

Figure 29 EDS wizard, change graphic image option

8. Select *Next*.

The Final Task Summary information appears, displaying a summary of the device being registered.



Figure 30 EDS wizard install summary

- Review, confirm device name is correct, then select *Next* to continue.

The final EDS wizard panel, appears confirming you have successfully completed the installing the EDS file for E-Pack.



Figure 31 EDS wizard successfully completed

- Select *Finish* to complete and close the EDS Wizard.

Network Driver - Configuration (using RSLinx Classic Lite)

- Start *RSLinx* program located in Start > All Programs > Rockwell Software.

The *RSLinx Classic Lite* program launches.

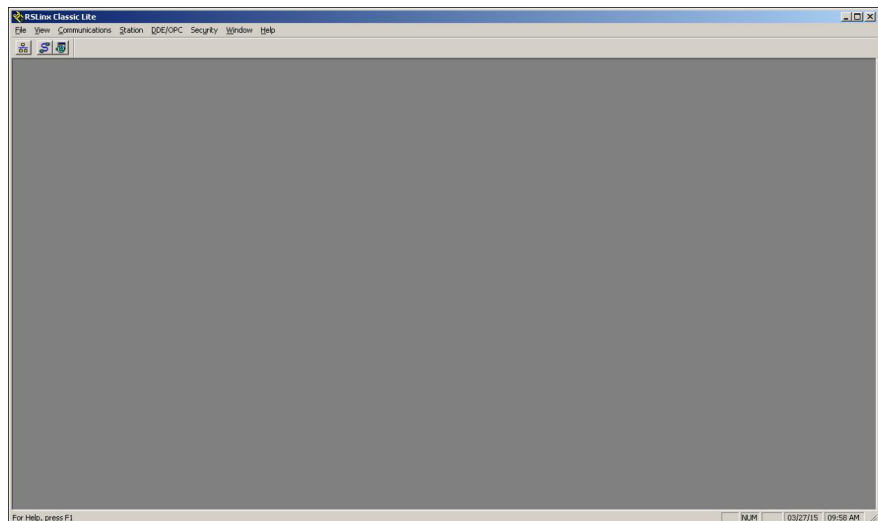

Figure 32 RSLinx Classic Lite

2. Select *RSWho*, from the *Communications* menu

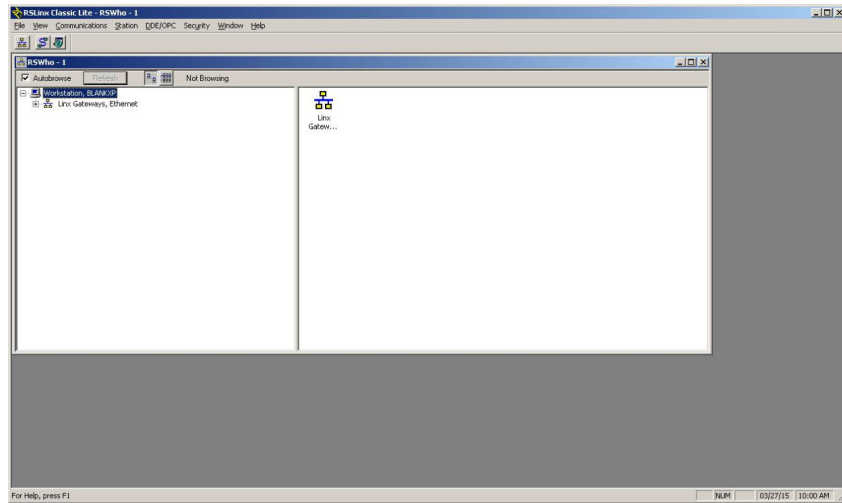

Figure 33 RSLinx Classic, Comms menu, RSWho selected

3. Launch the *Configure Drivers* panel.
The *Configure Drivers* panel appears.
4. From the *Available Driver Types* drop down menu, select *EtherNet/IP Driver*.
5. Click *Add New*, enter relevant name for driver, then click *Configure* button.

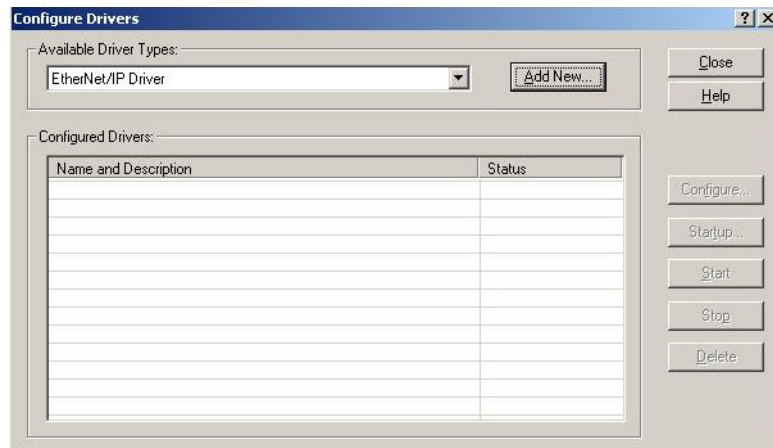

Figure 34 RSLinx Classic configure driver

The *Configure Driver*: panel is displayed.

6. To link the driver with your PC's Ethernet network connection, select the relevant driver option listed below the *Description* field, on the *Configure driver* panel.

7. Click *Apply*, then *OK* to complete the driver linking process.

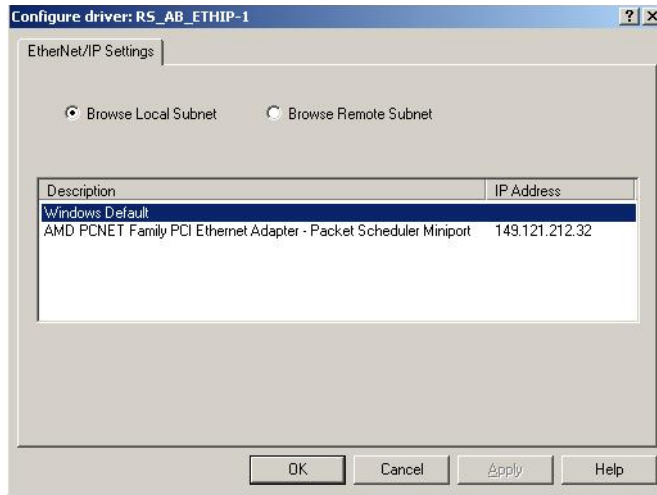

Figure 35 RSLinx Classic configure driver Ethernet/IP settings
Now you are in a position to browse your network and locate E-Pack.

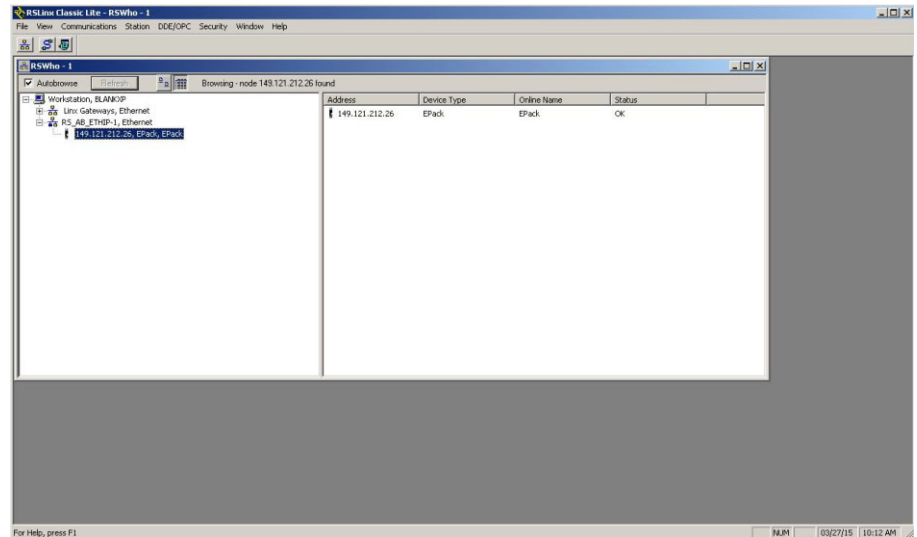

Figure 36 RSLinx Classic, E-Pack on network

Example: Using RSLogix 5000

In I/O configuration, select "New Module" and select "Generic Ethernet module"

In the next dialog window, RSLogix 5000 will ask for information regarding the communication to the E-Pack EtherNet/IP Slave module.

First enter a name for the E-Pack EtherNet/IP Slave module: eg 'E-Pack'.

This name will create a tag in RSLogix 5000, which can be used to access the memory location in the PLCs memory where the data for the E-Pack Slave module will be stored.

Next step is to select the "Comm Format", which tells RSLogix5000 the format of the data. Select Data-INT, which will represent the data as 16-bit values. (E-Pack I/O parameters, defined by the iTools Fieldbus I/O Gateway Editor, are 16 bit values).

I/O data is accessed in Input Instance 100 and Output Instance 150, so these values have to be entered as the instance values for input and output.

The size of the input connection and the output connection must correspond to the size that has been defined by the 'iTools Fieldbus I/O Gateway Editor' Input and Output Definitions for the EPack slave.

That is:-

Input size (5 parameters by default (10 bytes), maximum parameters 32) = Number of 'I/O Gateway' Input Parameter definitions.

Output size (1 parameter by default (2 bytes), maximum parameters 16) = Number of 'I/O Gateway' Output Parameter definitions.

The EPack Ethernet/IP Slave module does not have a configuration assembly instance, but RSLogix5000 requires a value for this anyway. An instance value of 0 is not a valid instance number, a typical value to use is 199, as shown in the table below. The data size of the configuration instance has to be set to 0, otherwise the configuration instance will be accessed and the connection will be refused.

As a final step enter the IP address that has been configured for the EPack Ethernet/IP slave module.

Summary: Cyclic (implicit) I/O Data Exchange setup information:-

	Assembly Instance	Data Size
INPUT	100	2 Bytes per "iTools Fieldbus I/O Gateway" Input Parameter Definition
OUTPUT	150	2 Bytes per "iTools Fieldbus I/O Gateway" Output Parameter Definition
CONFIGURATION	199	0

Establishing Communications

Communications will commence when the Ethernet/IP network is correctly cabled and powered, the Master (e.g. PLC) and Slave (EPack power controller) are configured with valid unique IP addresses and I/O parameter data definitions are setup.

The Input/Output definitions need to be matched with Master (e.g. PLC) data registers.

Parameters are either INPUT parameters read by the Ethernet/IP Master or OUTPUT parameters written by the Ethernet/IP Master.

Data Formats

Data is returned as 'scaled integers', such that 999.9 is returned or sent as 9999; 12.34 is encoded as 1234. The control program in the Ethernet/IP master converts the numbers into floating point values if required.

The EDS File

The Ethernet/IP EDS (Electronic Data Sheet) file for EPack controller is named:

EPACK_Vx.xx.eds (with Vx.xx representing the EPack software version).

It is available from your supplier, or electronically by going to web site www.eurotherm.com.

The EDS file is designed to automate the Ethernet/IP network configuration process by precisely defining the required device parameter information. Software configuration tools utilize the EDS file to configure an Ethernet/IP network.

Note: The EDS file is automatically installed when you upgrade your unit and is located in C:\Program files (x86)\EPack_Vx.xx.

Troubleshooting

No Communications:

- Check the cabling carefully, ensure that Ethernet plugs are fully located in the sockets.
- Check the 'Comms' list in configuration level and, check that the parameter 'Protocol' provides both options 'Modbus TCP and EIP' (Ethernet/IP). If not, your EPack power controller has not got the EIP option enabled, contact your local distributor.
- Check that the 'IP Address', 'Subnet Mask' and 'Gateway' in the 'Comms' list are correct and unique for the network configuration in use.
- Ensure that the Ethernet/IP Master Module Input and Output Parameter mapping is correctly matched. If the master is attempting to read (input) or write (output) more data than has been registered on the EPack slave, using the iTools I/O Gateway Editor, the EPack slave will refuse the connection.
- If possible, replace a non-working device with a duplicate and retest.

Modbus

It is not within the scope of this manual to describe the MODBUS/TCP network and for this, refer to the information which may be found at <http://www.modbus.org/>.

Also refer to HA179770 EPower Communication Manual.

Overview

EPack controller units support the Modbus/TCP protocol using Ethernet. This protocol embeds the standard Modbus protocol within an Ethernet TCP layer.

As most parameters are saved in the EPack controller unit’s memory, the interface board must retrieve these values before it can start communicating on Ethernet.

Changing any of the IP parameters will cause the interface board to reset in order to retrieve the new values. Any socket left with no data traffic for two minutes will be disconnected and made available for new connections.

Protocol Basics

A data communication protocol defines the rules and structure of messages used by all devices on a network for data exchange. This protocol also defines the orderly exchange of messages, and error detection.

Modbus requires a digital communication network to have only one MASTER and one or more SLAVE devices. Either a single or multi-drop network is possible. The two types of communications networks are illustrated in the diagram below;

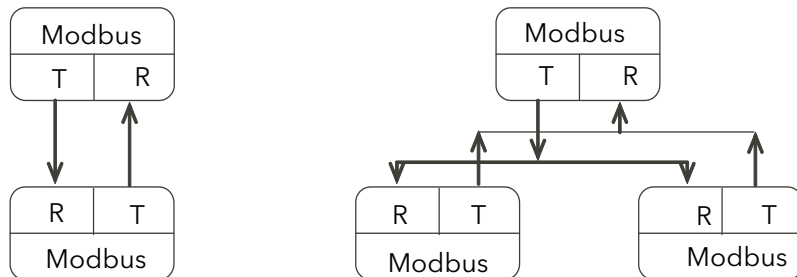

Figure 37 Single Serial Link and Multi Drop Serial Link

A typical transaction will consist of a request sent from the master followed by a response from the slave.

The message in either direction will consist of the following information;

Device Address	Function Code	Data	Checksum	End of Transmission
----------------	---------------	------	----------	---------------------

On a network of instruments this address is used to specify a particular instrument. Each instrument on a network must be set to a unique address, the available address range depending upon the network protocol.

As EPack supports only Modbus/TCP protocol and discrimination on the network is carried out using the IP addresses of the connected instruments, the Modbus addresses of the devices are not used.

Each slave has a unique 'device address':

- The device address 0 is a special case and is used for messages broadcast to all slaves. This is restricted to parameter write operations.
- EPack controller supports a subset of Modbus function codes.
- The data will include instrument parameters referenced by a 'parameter address'
- The Device Address is a single byte (8-bits) unique to each device on the network.
- Function Codes are a single byte instruction to the slave describing the action to perform.
- The Data segment of a message will depend on the function code and the number of bytes will vary accordingly.
- Typically the data segment will contain a parameter address and the number of parameters to read or write.
- The Cyclic Redundancy Check (CRC) is a checksum and is two bytes (16 bits) long.
- The End of Transmission segment (EOT) is a period of inactivity 3.5 times the single character transmission time. The EOT segment at the end of a message indicates to the listening device that the next transmission will be a new message and therefore a device address character.

Parameter Resolution

Modbus protocol limits data to 16 bits per parameter. This reduces the active range of parameters to 65536 counts. In EPack controller units this is implemented as -32767 (8001h) to +32767 (7FFFh).

The protocol is also limited to integer communication only. EPack controller units allow full resolution. In full resolution mode the decimal point position will be implied so that 100.01 would be transmitted as 10001. From this, and the 16 bit resolution limitation, the maximum value communicable with two decimal place resolution is 327.67. The parameter resolution will be taken from the slave user interface, and the conversion factor must be known to both master and slave when the network is initiated.

EPack controller units provide a special sub-protocol for accessing full resolution floating point data. This is described in "Access to Full Resolution Floating Point and Timing Data" on page 89.

Reading of Large Numbers

Large numbers being read over digital communications are scaled. For example, Setpoint can have the maximum value of 99,999 and is read as nnn.nK or 100,000 = 100.0K and 1,000,000 = 1000.0K.

EPack implements a dedicated scale parameter for each large parameter, allowing users to do specific scaling to suit their type of application.

Wait Period

There are several scenarios for which the slave devices on the network are unable to make a response:

- If the master attempts to use an invalid address then no slave device will receive the message.
- For a message corrupted by interference, the transmitted CRC will not be the same as the internally calculated CRC. The slave device will reject the command and will not reply to the master.

After a wait period, the master will re-transmit the command.

The wait period should exceed the instrument latency plus the message transmission time. A typical wait period, for a single parameter read, is 100ms.

Latency

The time taken for an EPack controller unit to process a message and start the transmission of a reply is called the latency. This does not include the time taken to transmit the request or reply.

The parameter functions read 1 word (function 03h), write 1 word (function 06h), and loopback (function 08h) are processed within a latency of between 20 and 120ms (typically 90).

For the parameter functions read n words (function 03h) and write n words (function 16h) the latency is indeterminate. The latency will depend on the instrument activity and the number of parameters being transferred and will take from 20 to 500ms.

Configuration Mode Parameters

To write parameters in this group, it is first necessary to set the 'Access.IM' parameter (Modbus 199 – 00C7_{hex}) to the value 2 to set the controller into configuration mode. Note this will disable all normal control action and the controller outputs will be switched to a default state.

It is not necessary to set any 'password' parameters to enter configuration mode.

To exit from configuration mode, simply write 0 to instrument mode. This will reset the controller, a process that takes several seconds. During this period it will not be possible to communicate with the controller.

Modbus Advanced Topics

Access to Full Resolution Floating Point and Timing Data

One of the main limitations of Modbus is that only 16 bit integer representations of data can normally be transferred. In most cases, this does not cause a problem, since appropriate scaling can be applied to the values without losing precision. Indeed all values displayable on the four-digit EPack controller front panel may be transferred in this way. However, this has the significant drawback that the scaling factor to be applied needs to be known at both ends of the communications link.

One further problem is that certain 'time' parameters, are always returned over the communications link in either 10th of seconds or 10th of minutes, configured via `Instrument.Configuration.TimerRes`. It is possible for long durations to overflow the 16 bit Modbus limit.

To overcome these problems, a sub protocol has been defined, using the upper portion of the Modbus address space (8000h and upwards), allowing full 32 bit resolution floating point and timer parameters. The upper area is known as the IEEE region.

This sub-protocol provides two consecutive Modbus addresses for all parameters. The base address for any given parameter in the IEEE region can easily be calculated by taking its normal Modbus address, doubling it, and adding 8000h. For example, the address in the IEEE region of the Target Setpoint (Modbus address 2) is simply:

$$2 \times 2 + 8000h = 8004h = 32772 \text{ decimal}$$

This calculation applies to any parameter that has a Modbus address.

Access to the IEEE area is made via block reads (Functions 3 & 4) and writes (Function 16). Attempts to use the 'Write a Word' (Function 6) operation will be rejected with a response. Furthermore, block reads and writes using the IEEE region should only be performed at even addresses, although no damage to the instrument will result in attempting access at odd addresses. In general, the 'number of words' field, in the Modbus frame, should be set to twice the value that it would have been for 'normal' Modbus.

The rules governing how the data in the two consecutive Modbus addresses are organized depending on the 'data type' of the parameter.

Data Types Used In EPack Power Controller Units

- Enumerated parameters are parameters which have a textual representation for their value on the user interface, for example, 'Parameter Status' – 'Good/Bad', 'Analog Operator Type' – 'Add', 'Subtract', 'Multiply', etc.
- Booleans are parameters which can have either a value '0' or a value '1'. Generally these parameters are enumerated. These are denoted as 'bool' in the table.
- Status words are generally only available over communications, and are used to group binary status information.
- Integer parameters are those that never include a decimal point however the instrument is configured, and do not refer to a time period or duration. These include such values as the instrument communications address and values used to set passwords, but not Process Variable and Setpoint related parameters, even if the display resolution of the instrument is set to no decimal places. These may be 8 or 16 bit and are denoted by 'uint8' or 'uint16' unsigned integers or 'int8' or 'int16' signed (+ or -) integers.
- Floating point parameters are those having a decimal point (or those which may be configured to have a decimal point), with the exception of parameters relating to time periods and duration. This includes Process Variable, Setpoints, Alarm Setpoints, etc and are denoted as type 'Float32' (IEEE 32-bit floating point parameters).
- Time Type parameters measure durations, for example, Alarm time above threshold, Timer elapsed time, etc. These are denoted by 'time32' in the parameter table.

Enumerated, Status Word, and Integer parameters

These use only the first word of the two Modbus addresses assigned to them in the IEEE area. The second word is padded with a value of 8000 hex.

Although 'Write a Word' (Function 6) is not permitted, this type of parameter may be written as a single 16 bit word using a Modbus 'Block Write' (Function 16). It is not necessary to add a padding value in the second address. Similarly, such parameters may be read using a Modbus 'Block Read' (Function 3 & 4) as single words, in which case the padding word will be omitted.

It is, however, necessary to pad the unused word when writing this sort of data types as part of a block containing other parameter values.

Floating Point Parameters

These use the IEEE format for floating point numbers, which is a 32 bit quantity. This is stored in consecutive Modbus addresses. When reading and writing to floats, it is necessary to read or write both words in a single block read or write. It is not possible, for example, to combine the results of two single word reads.

Ethernet (Modbus TCP)

Instrument setup

It is recommended that the communications settings for each instrument are set up before connecting it to any Ethernet network. This is not essential but network conflicts may occur if the default settings interfere with equipment already on the network.

For the Ethernet instruments, however, there are several more: IP address, subnet mask, default gateway and DHCP enable.

Changing any one of these parameters may immediately move the instrument to a new network address. For this reason, it is recommended that such changes are made offline.

IP Addresses are usually presented in the form "abc.def.ghi.jkl". In the instrument Comms folder each element of the IP Address is shown and configured separately such that IPAdd1 = abc, IPAddr2 = def, IPAddr3 = ghi and IPAdr4 = jkl.

This also applies to the SubNet Mask, Default Gateway and Preferred Master IP Address.

Each Ethernet module contains a unique MAC address, normally presented as a 12 digit hexadecimal number in the format "aa-bb-cc-dd-ee-ff".

In EPack controller units MAC addresses are shown as three separate **decimal** values in iTools. MAC1 shows the first pair of digits **in decimal**, MAC2 shows the second pair of digits and so on.

Dynamic IP Addressing

IP addresses may be 'fixed' - set by the user, or dynamically allocated by a DHCP server on the network. When IP addresses are dynamically allocated the server uses the instrument MAC address to uniquely identify them.

To configure dynamic IP addressing, the user must first set the IPMode parameter to *DHCP*.

Once connected to the network and powered, the instrument will acquire its "IP address", "SubNet Mask" and "Default Gateway" from the DHCP Server automatically and display this information within a few seconds.

Note: If the DHCP server does not respond (in common with other Ethernet appliances in this situation) the unit will not be accessible via the network. Instead, the unit will default to an automatic IP mode with an IP address in the range of 169.254.xxx.xxx.

Fixed IP Addressing

IP addresses may be 'fixed' - meaning the user manually enters the IP address and SubNet Mask values, which will remain unchanged, before connecting the instrument to the network.

To configure fixed IP addressing, the user must first set the IPMode parameter to *Fixed*.

Then set the IP address and SubNet Mask as required, to configure a fixed IP address, see "Comms menu" on page 114.

Default Gateway

The "**Comms**" folder also includes configuration settings for "**Default Gateway**", these parameters will be set automatically when Dynamic IP Addressing is used. When fixed IP addressing is used these settings are only required if the instrument needs to communicate wider than the local area network i.e. over the Internet.

Preferred Master

The "**Comms**" folder also includes configuration settings for "**Preferred Master**". Setting this address to the IP Address of a particular PC will help to ensure that one of the available Ethernet sockets will be reserved for that PC.

iTools Setup

iTools configuration package, version V7 or later, may be used to configure Ethernet communications.

The following instructions configure an Ethernet.

Automatic Configuration

Both EPack power controllers and iTools software support automatic discovery of network connected instruments. iTools software display all instruments connected to the network automatically. To connect and communicate with a selected instrument start iTools, click the *Add* button and select the relevant instrument.

Manual Configuration

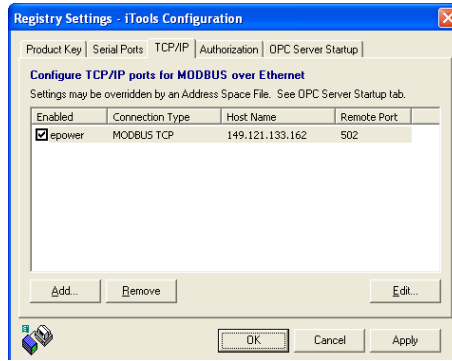

To include a Host Name/Address within the iTools scan:-

1. Ensure iTools is **NOT** running before taking the following steps
2. Within Windows, select **'Control Panel'**
3. In control panel select **'iTools'**
4. Within the iTools configuration settings select the **'TCP/IP'** tab
5. Click the **'Add'** button to add a new connection
6. Enter a name for this TCP/IP connection
7. Click the **'Add'** button to add the host name or IP address of the instrument in the **'Host Name/ Address'** section
8. Click **'OK'** to confirm the new Host Name/IP Address you have entered
9. Click **'OK'** to confirm the new TCP/IP port you have entered
10. You should now see the TCT/IP port you have configured within the TCP/IP tab of the iTools control panel settings

iTools is now ready to communicate with an instrument at the Host Name/IP Address you have configured.

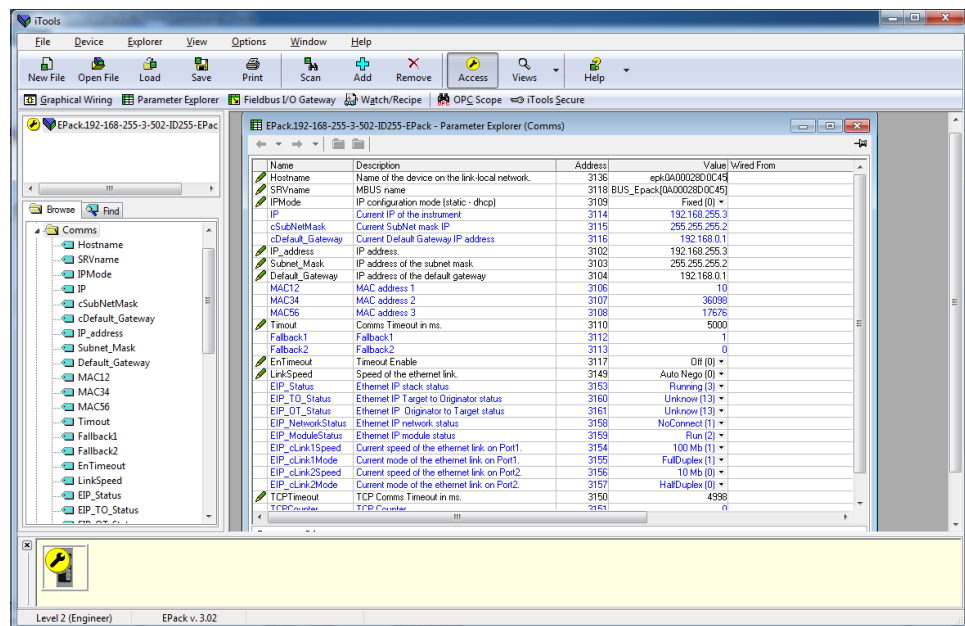

Figure 38 iTools - Ethernet Communications Parameter

PROFINET

PROFINET is the open industrial Ethernet based networking solution for automation. It is similar to PROFIBUS in that it enables distributed IO control from a PLC. PROFINET uses TCP/IP and IT standards, and is, in effect, real-time Ethernet. It enables the integration of existing Fieldbus systems like PROFIBUS, DeviceNet, and Interbus, without changes to existing devices.

PROFINET IO was developed for real time (RT) and isochronous real time (IRT) communication with the decentral periphery. The designations RT and IRT merely describe the real-time properties for the communication within PROFINET IO.

There are four stages to setting up a network:

- "PROFINET Wiring" on page 96
- "Setting up the EPack Controller for PROFINET" on page 97
- "Configuring the Cyclic (IO Data) Data Exchange" on page 104
- "Acyclic Data Exchange (Record Data)" on page 105

NOTICE

UNINTENDED EQUIPMENT OPERATION

- When ordering the product, select the appropriate communication protocol or make sure it is available as a software upgrade option.

Failure to follow these instructions can result in non-functional equipment.

PROFINET protocol is not available as software upgrade option on product with EtherCAT communication. Do not order EtherCAT communication if PROFINET protocol is required.

The PROFINET protocol and the EtherNet/IP protocol cannot be used together. Select one of the appropriate Protocol among the different options

PROFINET protocol is available as software upgrade option on product with Modbus TCP communication protocol and Ethernet/IP protocol.

EPack supports the Modbus/TCP protocol. whatever the communication protocol is.

PROFINET Features

- 10/100Mbps Auto-negotiation
- Galvanically isolated bus electronics
- Field pluggable option
- Polled and Explicit I/O messaging connection
- PROFINET IO Device version: V2.4
- Device Type: Compact field device
- Conformance class: CC-A
- Real Time class: RT-1
- Supported Net Load class: Class 1
- Number of slots: 17 (see description below)

- Minimum Device interval (cycle time): 16ms
Number of available modules: 43 (4 generic, 39 dedicated)

PROFINET Wiring

PROFINET capability is provided by the RJ45 Ethernet port, [Network Communications \(page 50\)](#).

The PROFINET port is a 100Mb, full duplex operation port and should be connected via an industrial switch to a Master device (eg PLC) with Cat5e (straight through) cable via the standard RJ45 connector (maximum length 100m).

The interconnecting cables should be fitted with plugs provided with an outer metallic shell with the shell connected to the wire screen of the cable.

Notes:

1. Although CC-A requirements can be met by the use of ordinary Ethernet Switches (supporting the VLANs), it is strongly recommended to use managed Industrial Switches (Managed Switches, e.g. MOXA EDS-408A-PN, Scalance X204IRT). This will allow future migration to the Conformance Class CC-B without the need to change your Network infrastructure (“Network Diagnostic” with SNMP, LLDP-MIB for the “Device Replacement without Engineering Tool”).
2. The MAC address of the device is stated on the label side, and on the Displays (Comms menu). To ensure the 'Neighborhood detection' functionality with LLDP, each physical Ethernet Port requires its own MAC address. Therefore, P1 uses the device MAC address incremented by one and by two for P2.

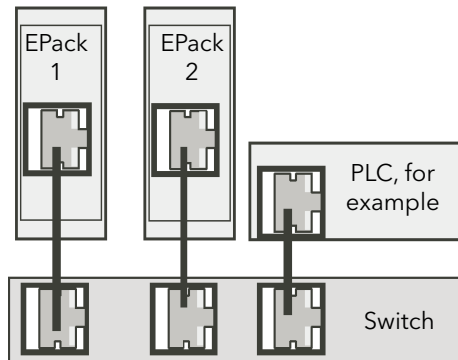

Figure 39 PROFINET Wiring - Multiple controllers

iTools Connection

Connect the EPack Controller to the PROFINET Configuration tool and to iTools (see example below).

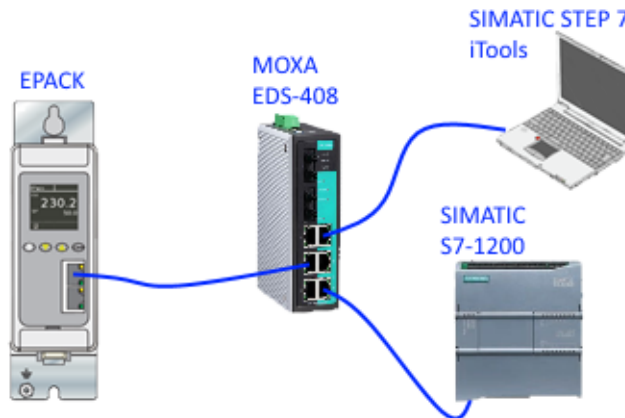

Figure 40 Configuration Tool Connections

Setting up the EPack Controller for PROFINET

A PROFINET IO Device, in this case EPack, is generally commissioned by using a PROFINET configuration tool (typically STEP 7 included in the SIEMENS TIA Portal). [Figure 40](#) shows a single controller but multiple controllers can be connected.

The first thing to do is to identify the PROFINET Device (EPack) on the Network. This is done automatically with the PROFINET tool which uses a specific DCP service for this purpose (DCP Identity Request).

Once done, you can affect the “Device Name” and the IP address configuration of a particular EPack controller. This is also done with the PROFINET tool by following the procedure below.

Commissioning using DCP protocol

This section describes ‘Device Name’ and ‘IP Configuration’ assignment.

A PROFINET Device is characterised by its ‘Device Name’ (named also ‘Station Name’) and its IP address.

The configuration of a PROFINET device is based on the DCP protocol which is used specifically to assign the ‘Device Name’ or to assign the IP configuration (IP address, Network Mask ...).

An EPack which is just ‘Out of the box’ has its ‘Device Name’ and its IP configuration address set to Null by default as shown in [Figure 43](#) (the MAC address is used initially by the DCP protocol for setting up the ‘Device Name’).

Note: EPack indicates that the ‘Device Name’ is reset by displaying ‘No Device Name !’.



Figure 41 EPack 'Comms' screen display 'as-delivered' (Device Name = "", IP Configuration = Null).

During the system set up, the PROFINET configuration tool first identifies the existing devices in the system (by sending out a 'DCPIdentity.req'), shown below in Figure 42. This example uses the © Siemens TIA Portal / STEP 7 ('Update accessible devices' function).

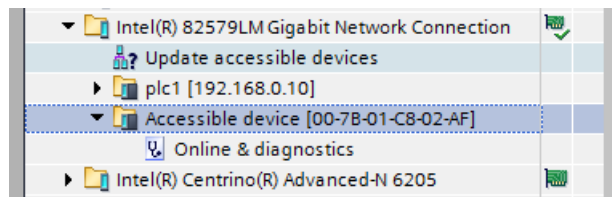

Figure 42 Example of EPack (not yet commissioned) MAC address using DCP. The next step assigns the 'IP Configuration' and the 'Device Name'. This operation can be performed by clicking on the 'Online & diagnostics' as shown in Figure 43.

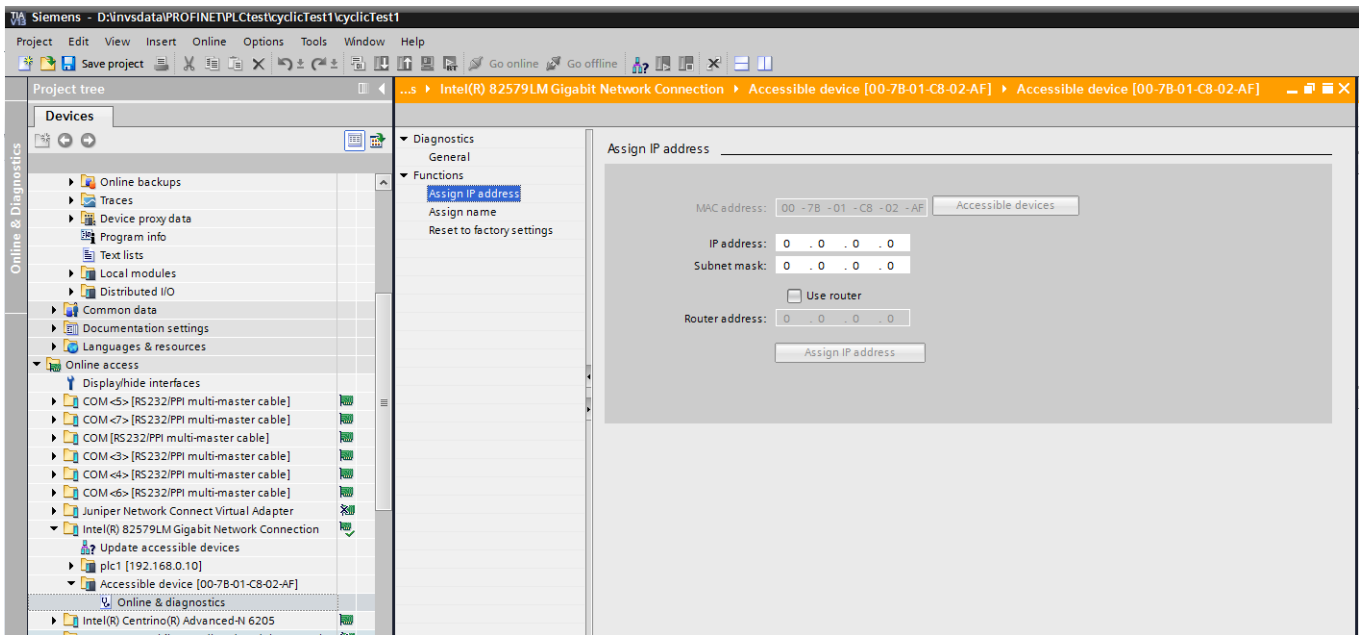

Figure 43 IP Configuration assignment and Device Name assignment with the "TIA Portal"

Note: The Default Gateway can be changed in the same way (named 'Router address' in this example).

Commissioning using 'Fixed' IP Mode'

This section describes setting of an IP address manually.

As mentioned above, the DCP Protocol is the basis of PROFINET.

However, in some cases, it could be useful to set an IP address and a Subnet Mask manually. For example, using 'iTools' configuration package without having previously configured your EPack with a PROFINET configuration tool see [Commissioning using DCP protocol \(page 97\)](#).

This can be done by selecting the 'Fixed' IP Mode instead the 'DCP' protocol on the front face of the device during the 'Quickcode' operation - see [Quickcode \(page 59\)](#).

Finally, the DCP protocol always stays active as it is a main part of PROFINET. This means that the next time that the DCP protocol re-allocates a new IP address, this one will overwrite the previous IP address manually set.

Note: The DHCP mode is not accessible when the PROFINET protocol is active on EPack.

Setting up the IP configuration via iTools

The IP configuration can be changed through 'iTools', but this method is not recommended with PROFINET, especially because the IO Controller/PLC or the Supervisor cannot be informed of these changes.

The PROFINET 'ecosystem' must be privileged for this type of operation (PROFINET Configuration tool using the DCP protocol).

Device Name

The Device Name is used to identify a Device on a PROFINET node.

Device Name via the DCP protocol

The Device Name is written to the Device by the PROFINET configuration tool via the DCP protocol (see "Setting up the EPack Controller for PROFINET" on page 97).

The length can not exceed 240 characters, only the lower case characters are authorized to be used (see [Figure 44](#)).

This field shall be coded as data type OctetString with 1 to 240 octets. The definition of RFC 5890 and the following syntax applies:

- 1 or more labels, separated by [.]
- Total length is 1 to 240
- Label length is 1 to 63
- Labels consist of [a-z0-9-]
- Labels do not start with [-]
- Labels do not end with [-]
- The first label does not have the form "port-xyz" or "port-xyz-abcde" with a, b, c, d, e, x, y, z = 0...9, to avoid wrong similarity with the field AliasNameValue
- Station-names do not have the form n.n.n.n, n = 0...999

Figure 44 Device Name encoding
(extract from the PROFINET Specification IEC 61158-6-10 & 4.3.1.4.15.2)

The Device Name respecting these rules can be read or written in EPack by using the PROFINET tool (e.g. with the TIA Portal/STEP 7).

Display of the Device Name on the EPack screen

The display of EPack allows the last eleven characters to be displayed (see Figure 45).

However, if the length of the “Device Name” is greater than eleven, the full “Device Name” is displayed by scrolling.

Note: If the length is greater than 64, only the last 61 characters are displayed followed by three dots.

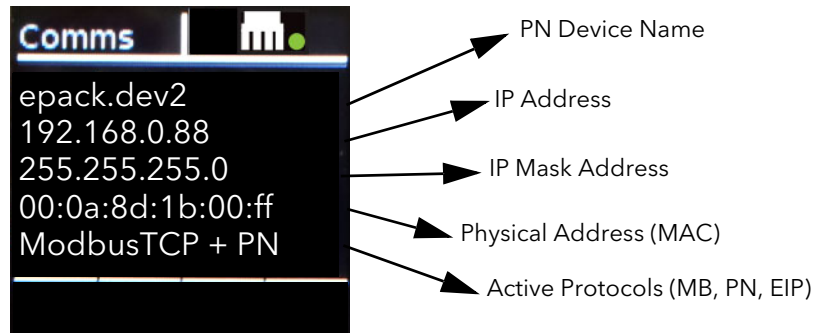

Figure 45 Display of the Device Name on EPack (e.g. “epack.dev2”).

Display of the Device Name in iTools

The last 64 characters of the Device Name are displayed in iTools in the ‘Comms Functional Block’ through the ‘PN_DevName’ parameter (read only).

Other DCP Services

In addition to the assignment of the ‘Device Name’ and the ‘IP Configuration’, the DCP protocol provides the following services for EPack.

Flash LED (also called “Flash Once”)

The DCP service provides easy visual identification of a Device among a group of Devices.

For this, the Ethernet LEDs and the EPack display (blink by inverted color) flash with a duration of three seconds and a frequency of 1Hz (500ms on, 500ms off).

Reset to factory

The DCP service allows the IP Configuration to be reset (to 0) and the Device Name (reset to “”) to its as-delivered condition, the device returns to its state shown in Figure 43.

EPack PN Modules

Commissioning directly 'out-of-the-box'

EPack is provided with a configuration tool named "iTools".

However, as not all PROFINET users are familiar with this kind of tool, but are familiar with their own PROFINET ecosystem tools (e.g. TIA Portal), particular attention has been paid so that the EPack's PROFINET Modules can be directly usable by the PROFINET configuration tool, and this for the most of applications.

The other applications, that need some specific EPack parameters, are covered by the IOGW and the new RIOGW PN's Modules (configured by 'iTools' in this case).

The use of the standard PN Modules instead of the IOGW present the following advantages:

- No need to use an additional 'non PROFINET' configuration tool,
- Ethernet Bandwidth optimization (only the desired IOData 'payload' is used during the cyclic exchanges),
- IO Controller resource optimization (only the useful IO Controller registers are employed).

List of the standard PROFINET Modules used by EPack

The following PROFINET Modules can be used directly to configure an EPack IO Device, the detailed definition of each parameter is provided in this Manual.

Module name (EPack parameter)	In / Out attribute (from PLC view)	EPack Type (Single, Two, Three Phase)	Size (Bytes)
FaultDet.AlarmStatus1	In	All	2
FaultDet.AlarmStatus2	In	All	2
FaultDet.AlarmAck	Out	All	2
Control.Main.PV	In	All	2
Control.Main.SP	In	All	2
Control.Diag.OP	In	All	2
Control.Diag.Status	In	All	2
Control.Limit.SP1	Out	All	2
Energy.Energy	In	All	2
Network.Meas.Vline	In	All	2
Network.Meas.Vline2	In	2PH & 3PH	2
Network.Meas.Vline3	In	2PH & 3PH	2
Network.Frequency	In	All	2
Network.Meas.I	In	All	2

Module name (EPack parameter)	In / Out attribute (from PLC view)	EPack Type (Single, Two, Three Phase)	Size (Bytes)
Network.Meas.I2	In	2PH & 3PH	2
Network.Meas.I3	In	2PH & 3PH	2
Network.Meas.Iavg	In	2PH & 3PH	2
Network.Meas.V	In	All	2
Network.Meas.V2	In	2PH & 3PH	2
Network.Meas.V3	In	2PH & 3PH	2
Network.Meas.Vavg	In	2PH & 3PH	2
Network.Meas.P	In	All	2
Network.Meas.PBurst	In	All	2
Network.Meas.Z	In	All	2
Network.Meas.Z2	In	2PH & 3PH	2
Network.Meas.Z3	In	2PH & 3PH	2
Network.Meas.Vsq	In	All	2
Network.Meas.VsqBurst	In	All	2
Network.Meas.Isq	In	All	2
Network.Meas.VsqBurst	In	All	2
SetProv.Remote1	In/Out	All	2 x 2
SetProv.Remote2	In/Out	All	2 x 2
SetProv.RemSelect	In/Out	All	2 x 2
SetProv.SPSelect	In	All	2
UsrVal1	Out	All	2
UsrVal2	Out	All	2

Notes:

1. The parameters with the double attribute 'In/Out' are broken down into two parameters 'In' and 'Out', to avoid confusion (Modules vs Slots assignment). They can be used simultaneously in the application.
2. The EPack parameters, named registers here, are comprised of two bytes by inheritance from the Modbus TCP protocol where they come from.

Fieldbus I/O Gateway IOGW Modules (Generic Modules)

As shown above, each time that it is possible, it is preferable to use the standard EPack PROFINET Modules.

However, as not all EPack parameters are available through the standard Modules, sometimes it is necessary to use the IOGW (or RIOGW), which allows the acquisition of some selected EPacks parameters by using the configuration tool named 'iTools' (see "Fieldbus Gateway" chapter for more details).

The two IOGW Modules are defined like this:

Module name (EPack IOGW)	In / Out attribute (from PLC view)	EPack Type (Single, Two, Three Phase)	Size (Bytes/Reg)
Fieldbus Input I/O Gateway	In	All	64/32
Fieldbus Output I/O Gateway	Out	All	32/16

Reduced Fieldbus I/O Gateway RIOGW Modules (Generic Module)

The reduced IOGW consists of the first quarter of a standard IOGW, the last three quarters is removed - cut short - to provide the reduction.

This 'truncated' IOGW allows the reduction of the Ethernet Bandwidth by reducing the data exchanged cyclically and to reduce the register footprint of the IO Controller (versus the standard IOGW).

The two RIOGW Modules are defined like this:

Module name (EPack RIOGW)	In / Out attribute (from PLC view)	EPack Type (Single, Two, Three Phase)	Size (Bytes/Reg)
Reduced Fieldbus Input I/O Gateway	In	All	16/8
Reduced Fieldbus Output I/O Gateway	Out	All	8/4

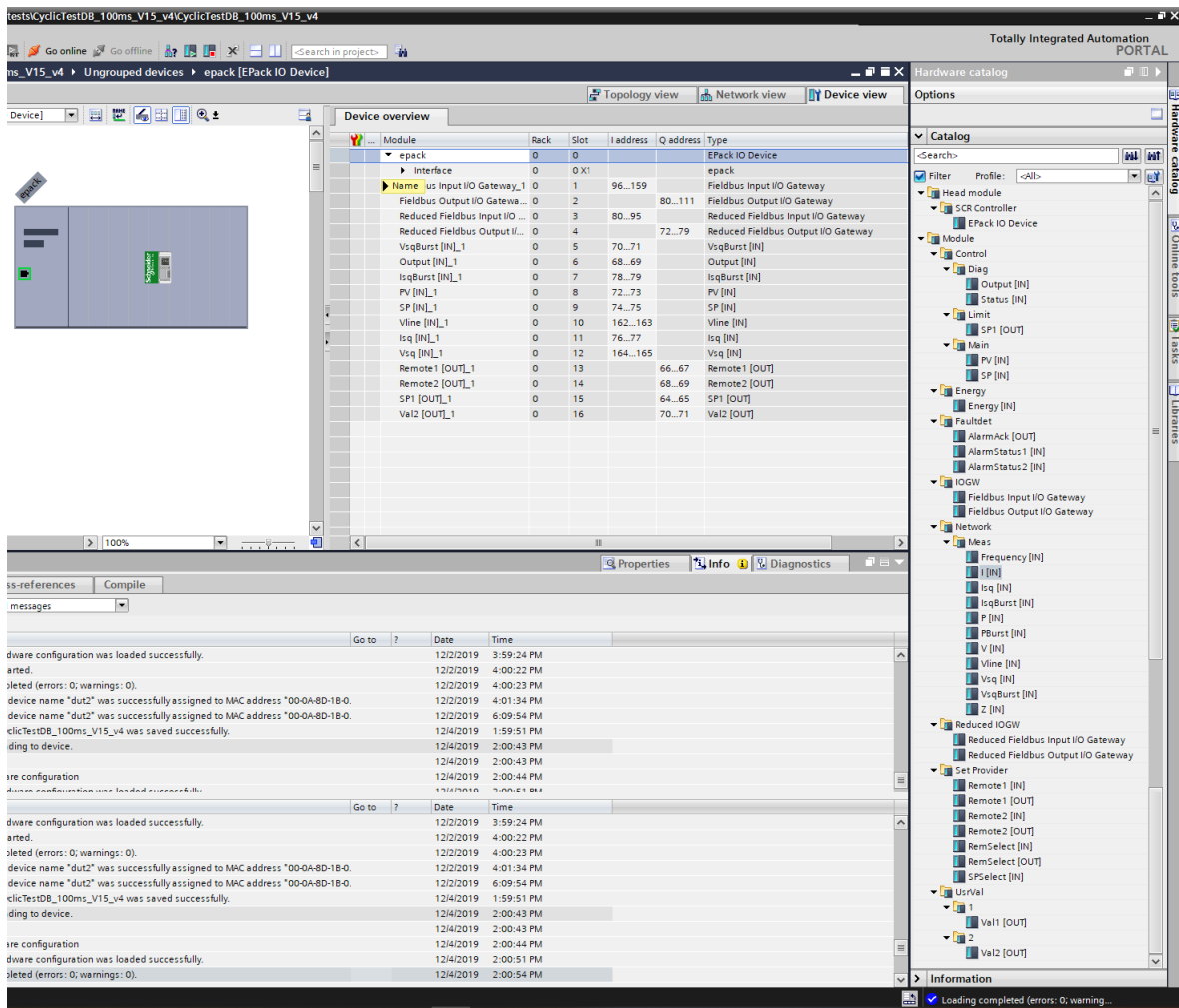

Figure 46 Siemens TIA Portal showing EPack modules and slots

EPack PROFINET Slots

General EPack’s Slot organization

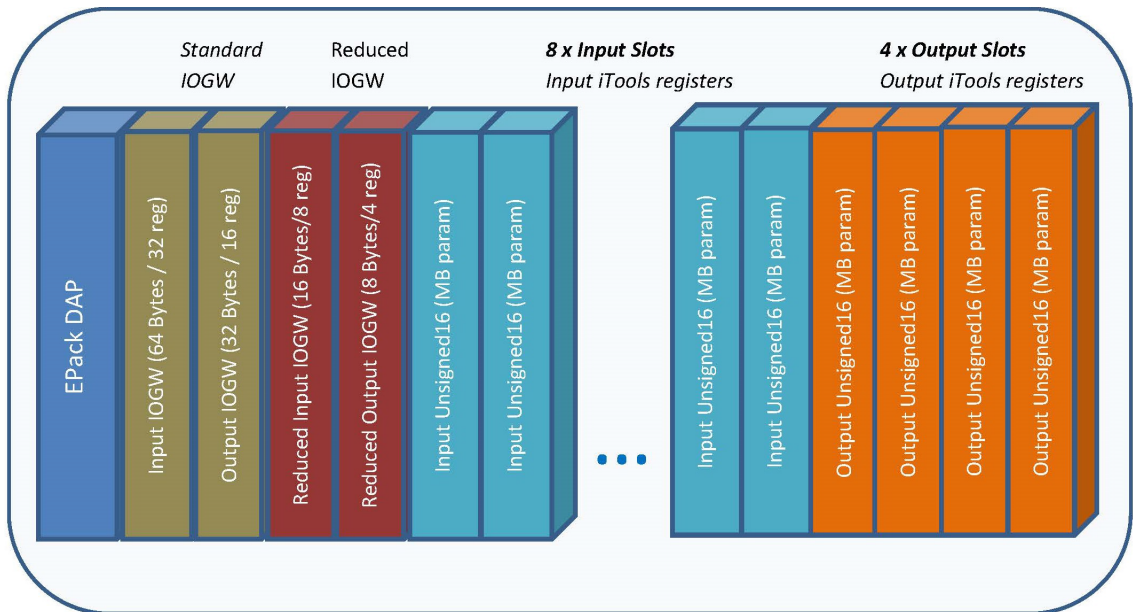

Figure 47 EPack Slots Configuration

EPack has 17 Slots, DAP comprised, they are organized as represented in the figure above.

The standard EPack Modules, which represent the more relevant iTools parameters, would be connected into the 8 Input Slots and 4 Output Slots having an “Unsigned16” format.

Two Slots are dedicated for the IOGW Modules and two others for the RIOGW Modules.

All Slots can be combined together, some holes can be left also, as long as the Slot ‘signature’ is respected (for instance, an IOGW Module can’t be connected to a standard Input Slot, the TIA Portal will forbid it anyway).

For Ethernet Bandwidth optimization and PLC resources optimization, it is recommended to use the IOGW or the RIOGW only when the standard Modules do not satisfy the requirement.

Configuring the Cyclic (IO Data) Data Exchange

During the PROFINET commissioning, the principle is to 'plug' the first module (representing the "Input I/O Gateway") into the slot 1 and the second one (representing the "Output I/O Gateway") into the slot 2 (at this stage, it is assumed that the 'Device Name' and the 'IP Configuration' has already been set up).

This operation is performed with the PROFINET configuration tool based on the GSDML file (e.g. with the TIA Portal/STEP 7, see [Figure 48](#) and [Figure 49](#)).

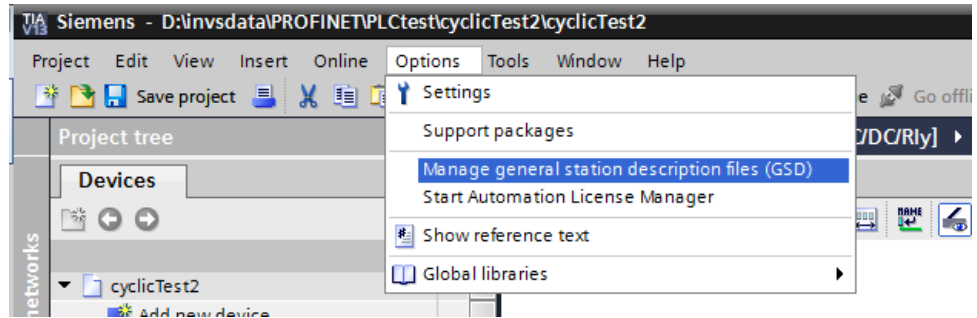

Figure 48 Loading the EPack GSDML file into STEP7

Figure 49 below shows "Drag and Drop" of the Input and Output Modules (Input and Output I/O Gateway image) respectively into Slot 1 and Slot 2 of EPack.

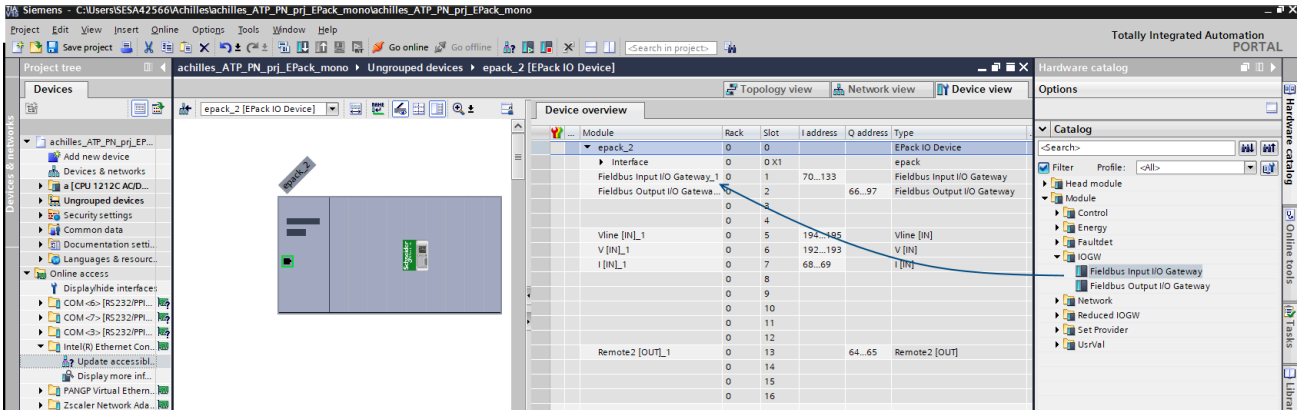

Figure 49 "Drag and Drop" I/O Modules

Once this has been completed, compile the configuration and download it to the IO Controller (PLC). The cyclic exchanges will then start with the IO Device, so with EPack (see Figure 50 below).

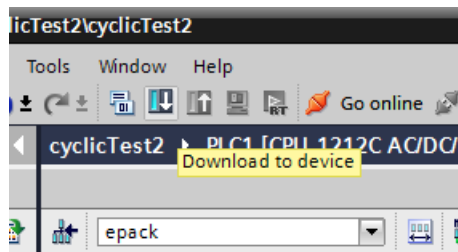

Figure 50 The compiled configuration is downloaded to EPack

Note: The IO cycle can be adjusted to 16ms (by default) up to 512ms.

Acyclic Data Exchange (Record Data)

Acyclic data exchange (or Record Data) is used to transfer data that does not require continuous updates.

It is possible to access any parameter in the EPack controller unit by this means, regardless of whether it has been included in the PROFINET input/output data assembly.

Acyclic data are transmitted via UDP/IP with the RPC protocol. For this, PROFINET provides "Read" and "Write" services of data.

For addressing Record Data services, the combination of API/Slot/Subslot/Index values is used. The Modbus address of the EPack parameter to read or write is passed through the Index value.

Modbus addresses are listed in the iTools Parameter Explorer.

PROFINET Acyclic Readings

This section describes how to access a variable using PROFINET in acyclic mode.

PROFINET uses the following parameter to access a variable in acyclic mode:

- API
- The Slot and Subslot
- Index

To access a parameter in acyclic mode, you first need to know its Modbus address. This may be accessed by selecting the parameter from the Parameter Explorer list shown in Address column.

The figure below shows an alternative way to access a parameter. This uses the Graphical Wiring Editor. The Modbus address is shown in Address column. Right click on the parameter to open the parameter help window.

Right click on the parameter to open the parameter help window.

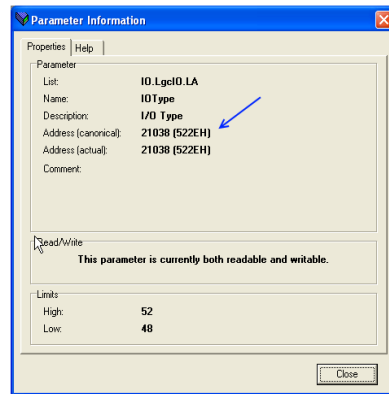

Figure 51 Parameter Access using the Graphical Wiring Editor

From this address, use the following conversion to get the PROFINET way of addressing a parameter:

- The API is always 0 (Zero)
- The Slot is always 1 (One)
- The Subslot is always 1 (One)
- The Index will be the Modbus-address you found previously in iTools

Acyclic data exchanges, Step 7 (TIA Portal) program block

The RDREC and the WRREC function blocks are used to respectively read and write the record data, which allows to access to the overall parameters of EPack.

The Modbus address of the parameter to be read is set in the INDEX entry, the ID value has to match with the Hardware ID of your device incremented by one.

See example below where the Modbus address is 3107 and the HW ID is 277.

The Hardware ID can be found in the Device View tab as shown in [Figure 53](#).

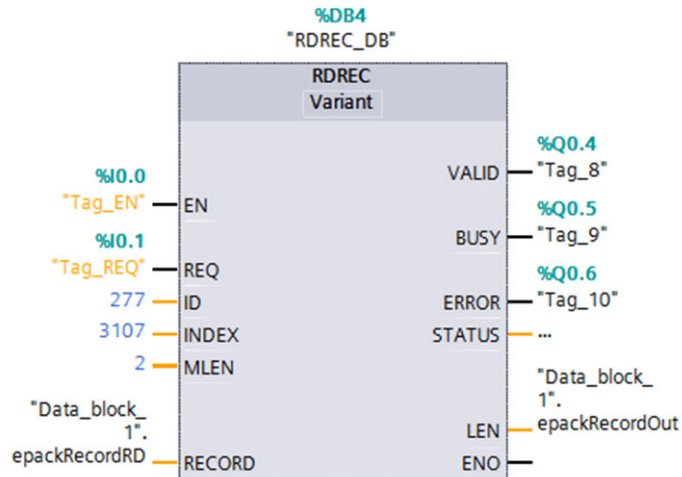

Figure 52 Reading one EPack parameter, using RDREC function block of STEP 7

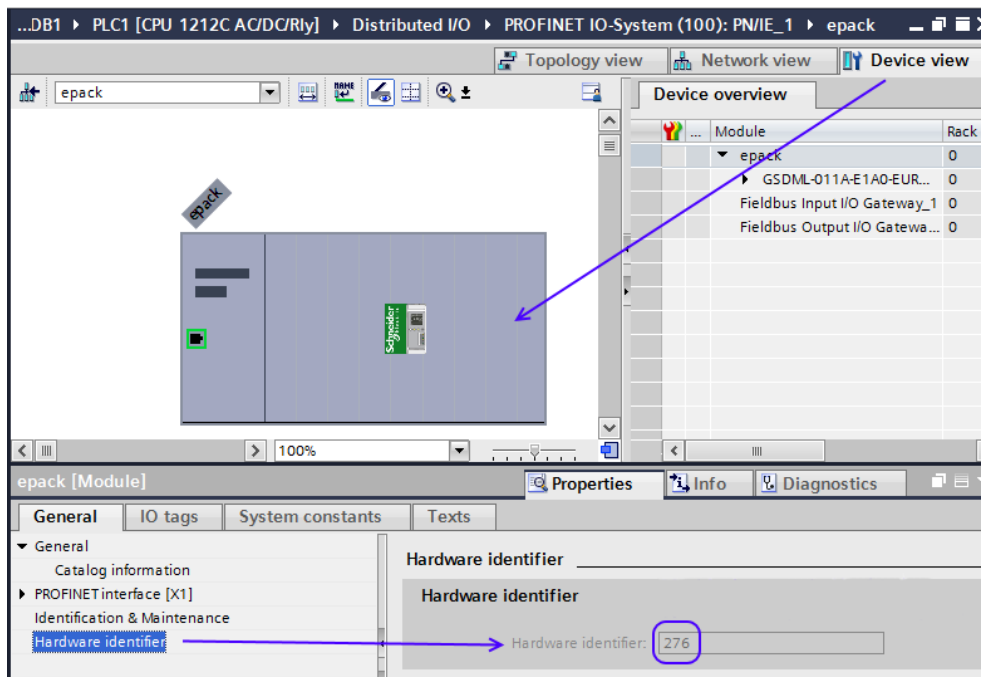

Figure 53 Hardware Identifier value

Constraints on the Parameters

The parameter in acyclic-mode follows the same limitation as the parameters in the Fieldbus I/O gateway: 16 bits length and they follow the same scaling, [Configuring the Cyclic \(IO Data\) Data Exchange \(page 104\)](#)

Data Formats

Data is returned as 'scaled integers', such that 999.9 is returned or sent as 9999; 12.34 is encoded as 1234. The control program in the PROFINET master must convert the numbers into floating point values if required.

The GSD File

The PROFINET GSDML (General Stations Description) file for EPack controller has the generic name GSDML-V[GsdVersion?]-Eurotherm-EPack-[dateOfCreation].xml and is available from your supplier, or electronically by going to Web site <https://www.eurotherm.com/en>.

The GSD file is designed to automate the PROFINET network configuration process by precisely defining the required device parameter information. Software configuration tools utilise the GSD file to configure an PROFINET network.

Alarm Notification

EPack has the ability to send "Alarm Notification" when an alarm is raised; the I/O Controller acknowledges this Alarm Notification request (e.g. "Missing Mains Indication" when the Mains [power supply] is off).

The alarms are generated by the first plugged module, in ascending slot order.

For instance, in the following example, the Alarm Notifications will be sent from the Slot number 5.

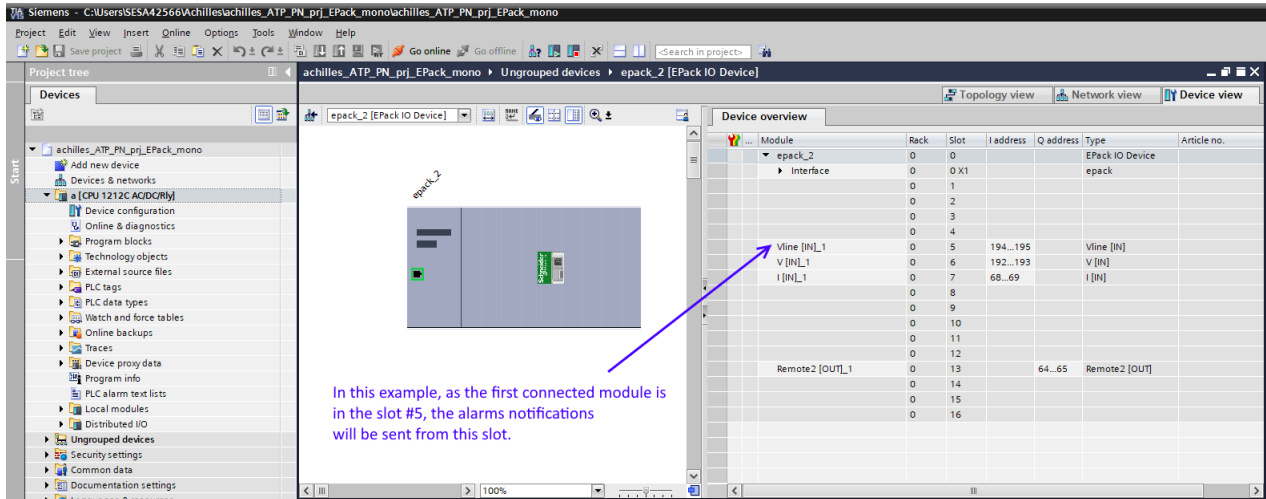

Figure 54 Alarm Notifications

EPack uses the "Channel Diagnosis" to transmit its Diagnosis Alarm, which is made of a single 16 Bit "ErrorType" for each alarm, defined in the "Manufacturer Specific" range (0x0100-0x7FFF), which starts at 0x0200 (512d) for EPack (e.g. 512 stands for "Missing Main", 513 for "Thyristor Short Circuit", and so on).

The definition of the different "ErrorType" is provided in the "human readable" format in the GSDML file and are summarized in the table below (Alarm Status Word 1/2).

When an Alarm Notification is raised, it is managed by the IO Controller which hands it over to its alarm buffer. If this alarm disappears, EPack sends a new request to the IO Controller to remove it from its alarm buffer.

EPack can treat several alarms simultaneously, but the Profinet Alarm Buffer size is limited to two entries, when an entry is freed and another alarm is still present in EPack, this second one is sent to the IO Controller.

As described above, the Alarms are explicitly described in the GSDML file, an additional field is used to provide the first level of suggested action to manage this alarm. This is illustrated below through the TIA Portal (Step 7) screenshot example.

The languages currently supported are English (default), German, Spanish and French (the TIA Portal is set up with the corresponding language).

EPack allows the possibility to disable the sending of user alarms through the Channel Diagnostics. See PNAIarmsEn parameter in "Communications Configuration" on page 137.

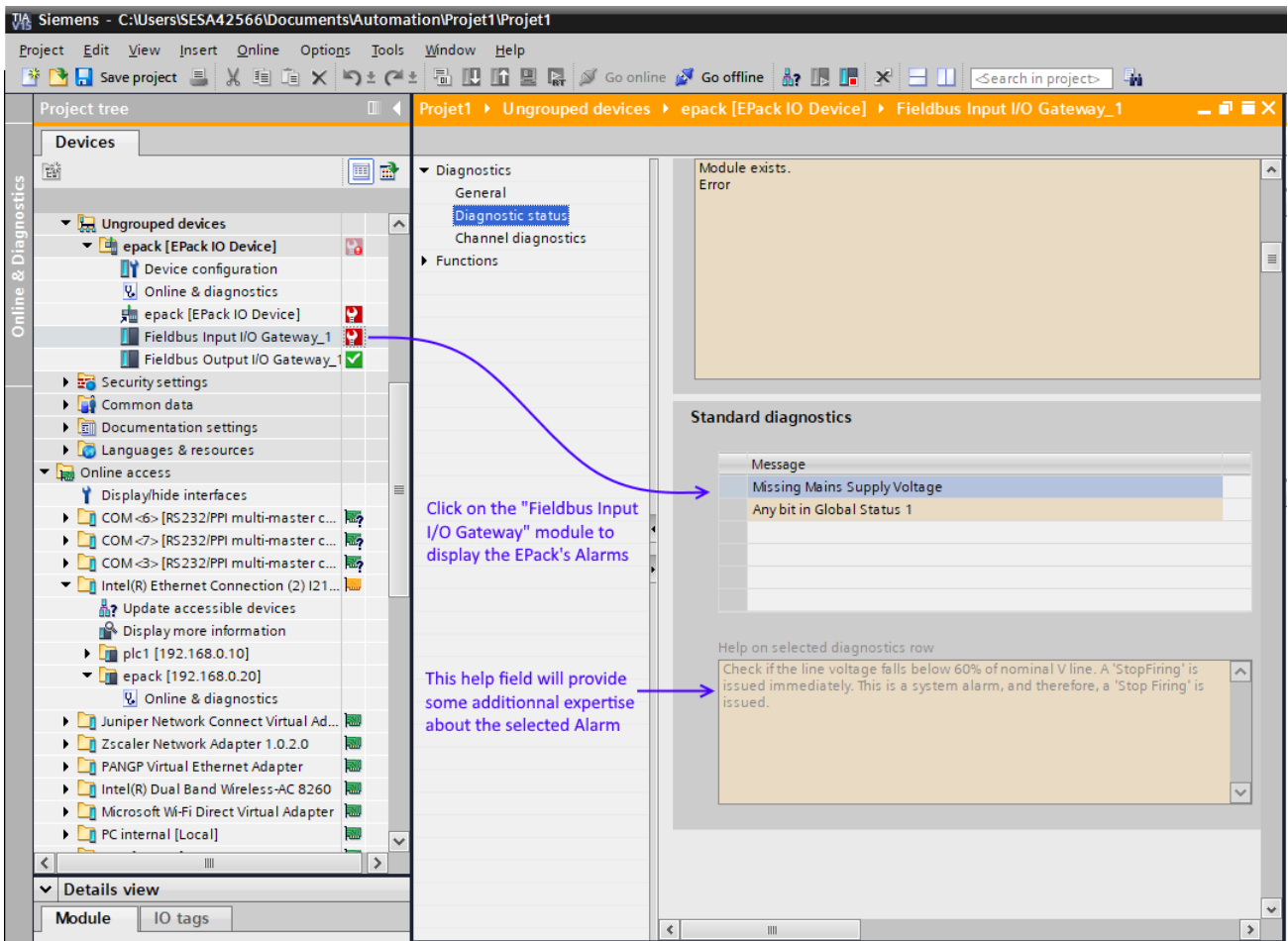

Figure 55 TIA Portal screenshot showing an EPack Alarm representation

Table 4: EPack's Profinet Alarm list (see GSDML file for details)

Alarm Status Word 1 (LSB)	
Bit	Alarm Origin
0	Missing Mains Indication
1	Thyristor Short Circuit Indication
2	Reserved
3	Networks dips Indication
4	Frequency out-of-range Indication
5	No longer used from V6.xx
6	Chop-Off Indication
7	No longer used from V6.xx
8	No longer used from V6.xx
9	No longer used from V6.xx
10	No longer used from V6.xx
11	No longer used from V6.xx
12	No longer used from V6.xx
13	Reserved
14	Analog IP Over Current Indication
15	External Input Indication

Alarm Status Word 2 (MSB)	
Bit	Alarm Origin
0	No longer used from V6.xx
1	No longer used from V6.xx
2	No longer used from V6.xx
3	No longer used from V6.xx
4 .. 7	Reserved
8	Any bit in Global Status 0
9	Any bit in Global Status 1
10	Any bit in Global Status 2
11	Any bit in Global Status 3
12 .. 15	Reserved

Configuration from the Front Panel

At power up or after quitting the Quickcode menu, the unit initializes and then enters the summary page (Figure 56) showing the real-time values of the two parameters configured, see "Instrument Display configuration" on page 163 for details.

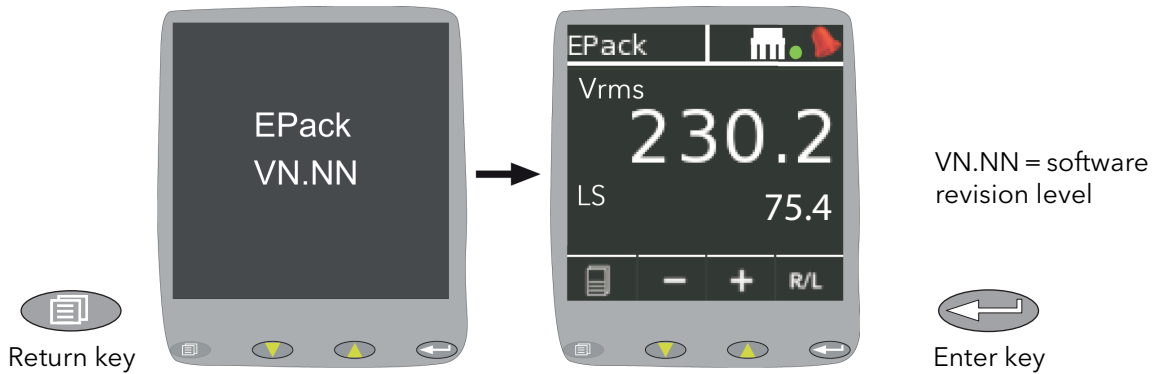

Figure 56 Initialization screens

Notes:

1. If any issues are detected during the initialization (e.g. supply voltage missing), then a message appears on the display screen.
2. Color of first parameter Real-time value in summary page will be orange if any Control alarm is signaled (see Control Alarm signaling parameters). It means Control loop can't currently reach its setpoint.

Menu Pages

Operating the return key opens the first page of the menu, the content of which depends on the current access level and on the number of options enabled.

The descriptions below assume 'Configuration' level access is selected. (Additional menu options appear when 'Engineering' level access is selected and are described in this section, in no specific order).

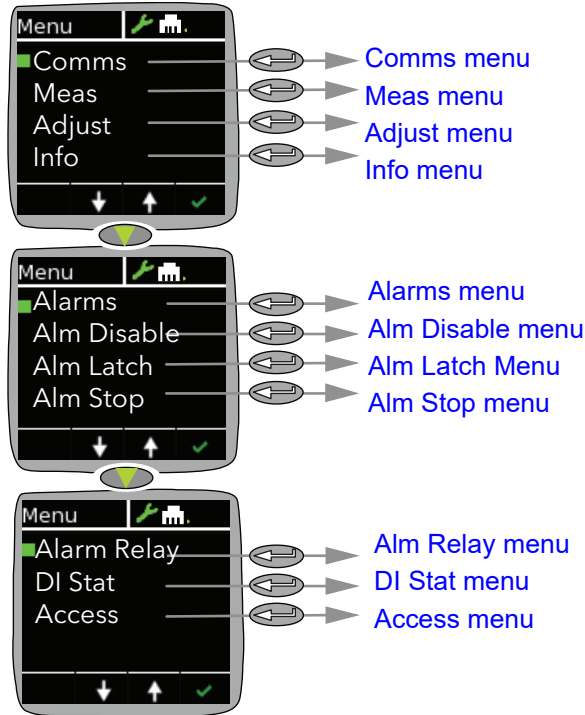

Comms menu

This allows the following communications parameters to be viewed or configured. In Engineer mode the Comms menu is read-only.

Comms	Displays (read only) the MAC address, current IP and Subnet mask addresses.
IP Mode	Allows the user to select 'Fixed', 'DHCP' or 'DCP' as the IP address source. If 'Fixed' is selected, then the IP address and Subnet Mask can be edited in the following fields. It must be ensured that the address is unique to the network. If DHCP ('Dynamic Host Configuration Protocol') is selected, the IP Address and SubNetMask parameters described below do not appear. DHCP will be successful only if there is a suitable DHCP server on the network to which the unit is connected. DCP ('Discovery and Configuration Protocol') is only used with the PROFINET protocol.
IP Address	Appears only if 'Fixed' is selected as IP Mode (above). Allows the user to edit the current IP address. Example: To set an IP address of 111.112.113.1, use the up and down arrow pushbuttons to set the first section of the address to 111. Use the enter key, and then the up and down pushbuttons to set the second section to 112. Use the enter key, and then the up and down pushbuttons to set the third section to 113. Use the enter key, and then the up and down pushbuttons to set the fourth section to 1 (not 01 or 001). Use the Enter key to quit Edit mode. If any

	section is already as required, it can be skipped by using the Enter key.
SubNetMask	Set the SubNet mask as described above for the IP address.
Link Speed	Select the required link type and speed.
TCPTimeout	Is used to set the timeout period, (measured in milliseconds) that is used to close any open TCP connections not being used by the master, which originally opened the connection.
	Adjust in Configuration mode. The default value is 5000ms.
TCP_Open	TCP Open displays the quantity of live, open connections.

Note: For details about subnet masks, see (iTools wiring).

Meas menu

This menu allows the user to view a number of measured values in real time. For further details, see 'Network Meas Menu' (page 180).

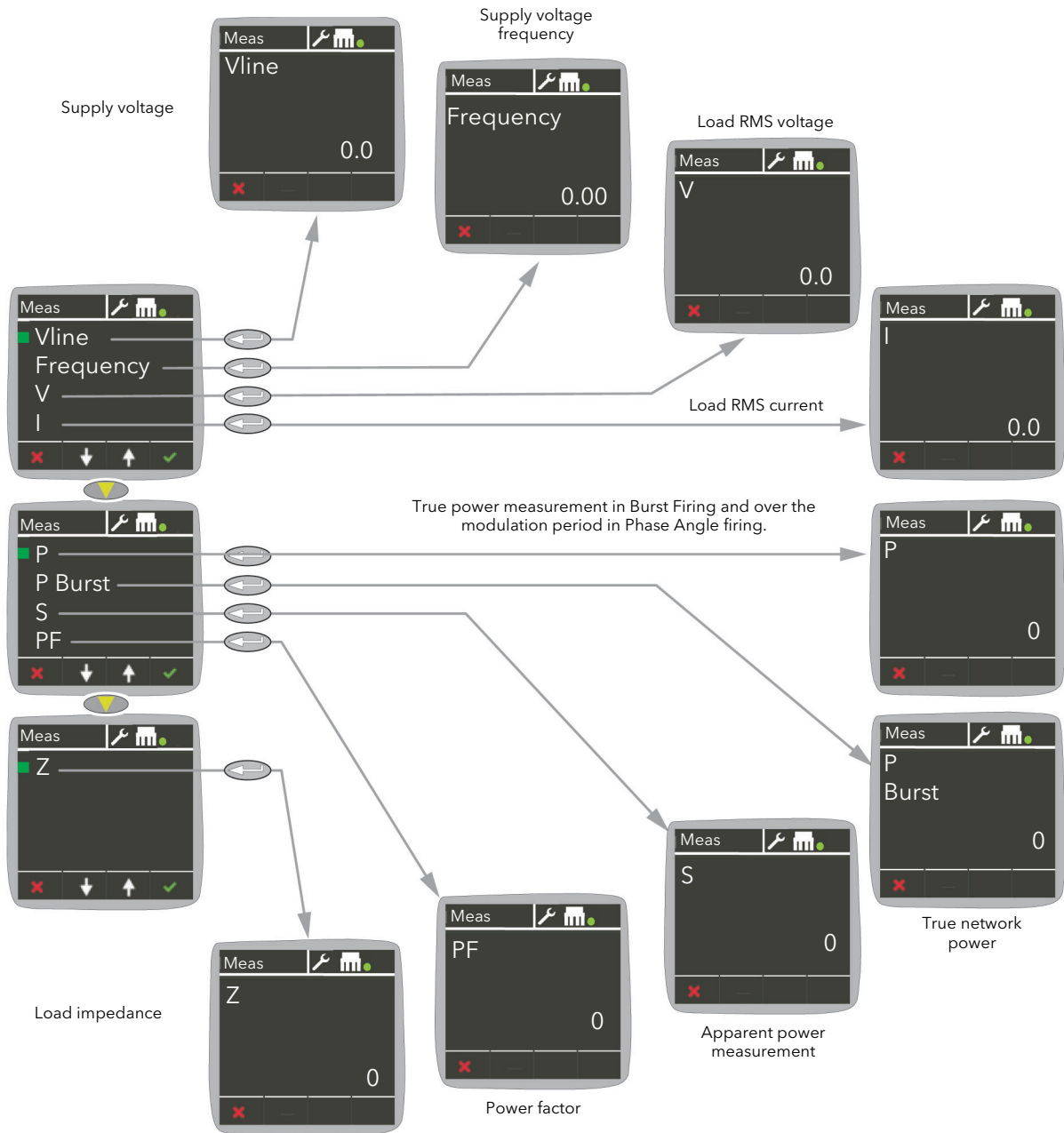

Figure 57 Meas menu

Strat menu

The Strat menu is only available in Engineer mode. It allows the user to view a number of control strategy parameters in real time.

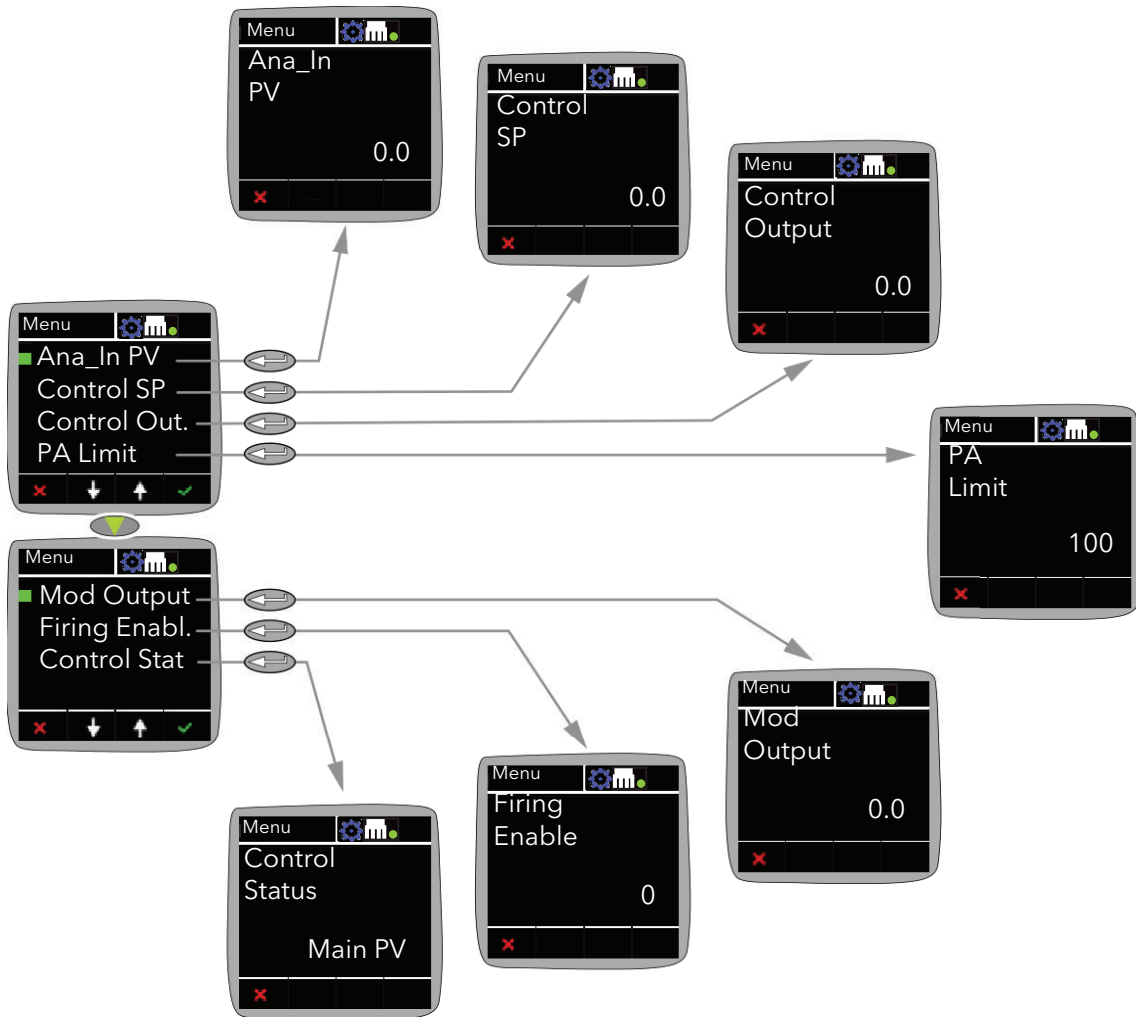

Figure 58 Strat menu

Ana_In PV	The scaled value in process units of the analog input. Clipped to the Range High or Range Low value if the signal goes over range or under range respectively, (see page 158).
Control SP	The Setpoint to control at, as a percentage of Nominal PV, (see page 142).
Control Out.	The instantaneous control output demand in percent, (see page 144).
PA Limit	Phase angle limit. This is a phase angle reduction output demand used in Burst Firing. If lower than 100% the power module delivers a burst of phase angle firing. Used, typically, to perform threshold current limiting in Burst Firing, (see page 154).
Mod Output	The output logic signal controlling the power module on and off times, normally wired to the input of the firing block. For Mode = Phase angle, this is a phase angle demand, (see page 178).
Firing Enabl.	Enables/disables firing. Must be wired to a non-zero value to enable firing, (see page 154).
Control Stat	Indicates the current operating state of the controller: (see page 144)
Main PV	The control strategy is using Main PV as the control input

Transfr

The transfer input is being used as the input to the control strategy.

Limit1(2)(3)Control limiting is currently active using limit PV1(2)(3) and limit SP 1(2)(3).

Adjust menu

This menu allows a number of network and firing output parameters to be set up, as well as Analog input type.

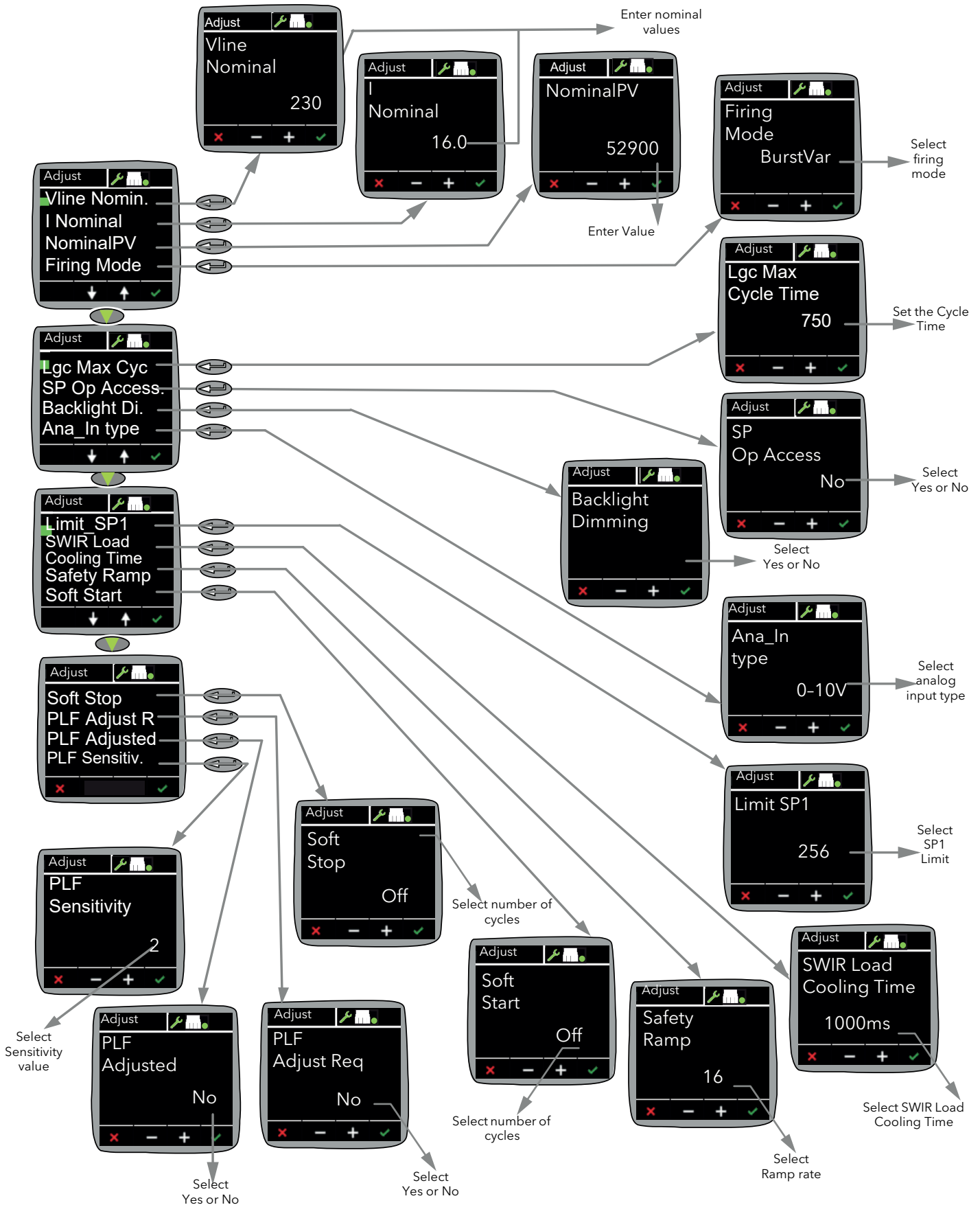



Figure 59 Adjust Menu

Vline Nominal	Line voltage nominal value (Line to neutral) or Line to L2 (phase to phase connection).
I Nominal	Nominal current supplied to the load.
NominalPV	Nominal Process Variable. Defines the nominal value for each control type. For example, for Vs _q control, you must wire Vs _q from the network block to the MainPV and set NominalPV to the nominal value you expect for Vs _q —typically this could be VloadNominal * VloadNominal.
Lgc Max Cyc	Max cycle time for Logic mode. This is set in mains periods. This is the equivalent to the modulation period and it is used to compute Network electrical quantities when there is no modulation shift. It is only available in Logic Mode.
Firing Mode	Firing Mode allows the firing mode to be selected as Burst Var, Burst Fix, or Logic, Phase Angle (PA) or Intelligent half cycle (IHC). See Firing Output Menu (page 154) for more details.
SP Op Access	Setpoint Operator Access: Allows the user setpoint access via the front panel, in operator configuration when enabled. To enable set to Yes. (The default setting is Yes).
Backlight Di.	Backlight Dimming: By default, the backlight on the EPack's display dims automatically to save power. Set this parameter to No if you want the backlight to always remain on. If set to Yes, the backlight dims 30 seconds after you last operate the buttons on the front panel.
Ana_in type	Select the Analog Input type as 0 to 10V, 1 to 5 V, 2 to 10V, 0 to 5V, 0 to 20mA, 4 to 20mA.
Limit SP1	This is the setpoint for the first Limit loop. For example, it can be used to perform Irms threshold limit: "I" measurement from network block shall be wired to the LimitPV1 of the control block (or current limit enabled in QuickStart). Limit.SP1 setpoint is set to the threshold current value (e.g. 100 for a current limitation at 100A). With this configuration output is control by MainSP but if LimitPV1 reaches LimitSP1 the controller will switch to limit control. It is only available if limit feature is enabled.
SWIR Load Cooling Time	0: No dedicated firing strategy is applied on SWIR load. 1-max: A Safety ramp is applied at next firing if no power is applied on SWIR load for more than this amount of time in ms. It is only available when Heater Type is SWIR.
'Safety Ramp'	Displays the startup ramp duration, in supply voltage cycles (0 to 255), to be applied at startup. The ramp is either a phase angle ramp from zero to the requested target phase angle or, for Burst Firing, from 0 to 100%. 'Safety Ramp' is not applicable to Half cycle Mode if Heater Type is different from SWIR.
Soft Start	For Burst Firing only, this is the soft start duration, in supply voltage cycles, applying a phase angle ramp at the beginning of each ON period. See Firing Output Menu (page 154) for more details.
Soft Stop	In Burst Firing, the soft stop duration, in supply voltage cycles, applying a phase angle ramp at the end of each ON period. See Firing Output Menu (page 154) for more details.

 WARNING
<p>UNINTENDED EQUIPMENT OPERATION</p> <ul style="list-style-type: none"> At commissioning, ensure correct product configuration. <p>Failure to follow these instructions can result in death, serious injury or equipment damage.</p>

For transformer Load, select XFMR as Load Type (select Yes for Transfo. in quick code).

For transformer Load, in burst firing mode, without soft start, adjust Delayed Triggering (DelayedTrigger) to minimize inrush current.

Delay Triggering	Appears only if Mode is Burst, Soft Start is Off, and Load Type is TxFormer. Delayed Trigger specifies the triggering delay, in phase angle, when delivering power into a transformer load. Used to minimize inrush current, the value is configurable between 0 and 90 degrees, inclusive.
PLF Adjust R	Partial Load Failure Adjustment Request: When the process has achieved a steady state condition the operator must set the PLFAdjustReq. This makes a load impedance measurement to be used as a reference for detecting a partial load failure. If the load impedance measurement is successful 'PLFAdjusted' is set. The measurement cannot be made if the load voltage (V) is below 30% of VNominal or if the current (I) is below 30% of INominal. The input is edge sensitive, so if the request is made from external wiring, and the input remains permanently at a high level, only the first 0 to 1 edge is taken into account.
PLF Adjusted	Partial Load Failure Adjusted: A successful load impedance measurement has been made (see PLF Adjust R above).
PLF Sensitivity	Partial load failure sensitivity. This defines how sensitive the partial load failure detection is to be as the ratio between the load impedance for a PLFadjusted load and the current impedance measurement. For example for a load of N parallel, identical elements, if the PLF Sensitivity (s) is set to 2, then a PLF alarm will occur if N/2, or more elements are broken (i.e. open circuit). If PLF Sensitivity is set to 3, then a PLF alarm occurs if N/3 or more elements are broken. If (N/s) is non-integer, then the sensitivity is rounded up. E.G. if the N = 6 and s= 4, then the alarm is triggered if 2 or more elements are broken.

PLF menu

The PLF (Partial Load Failure) menu is only available in Engineer mode.

Note: The default Engineer access level code is 2.

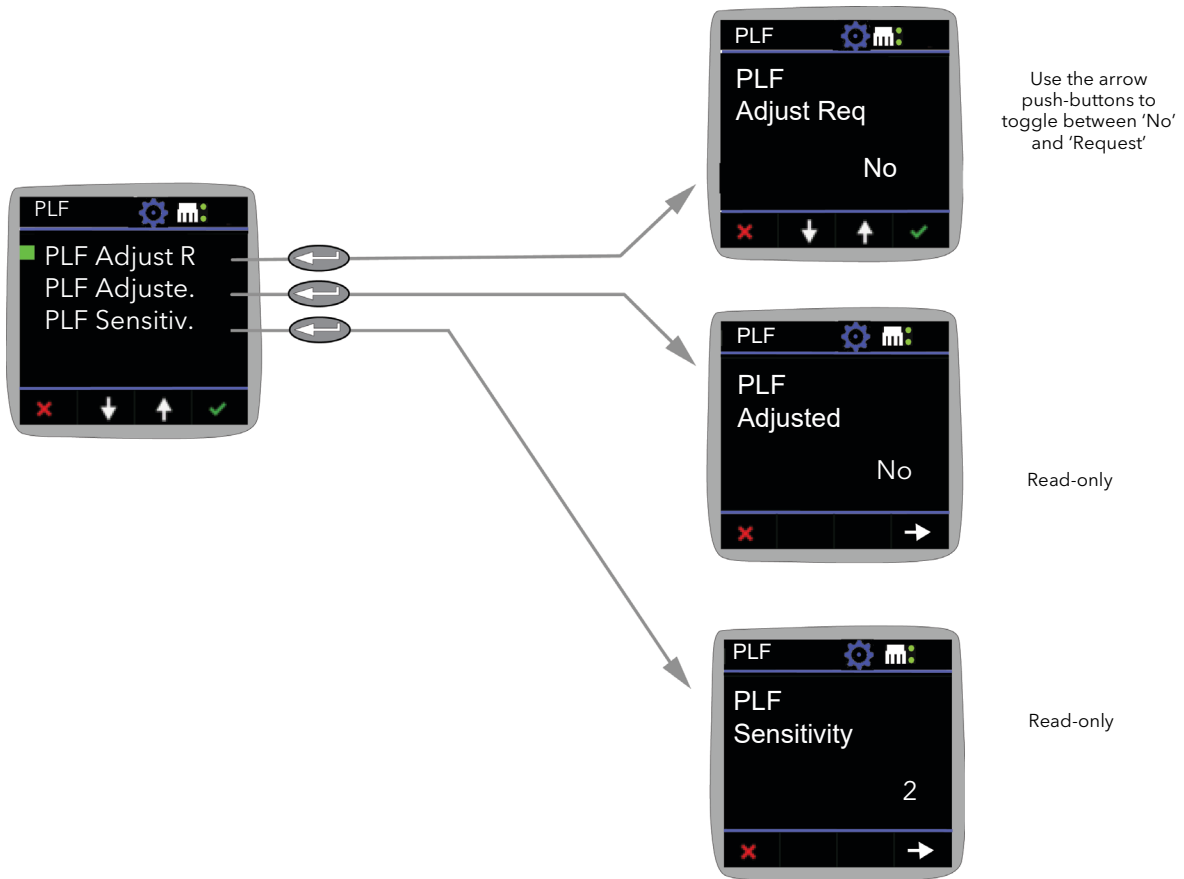

Figure 60 PLF menu

PLF Adjust R

Partial Load Failure Adjustment Request: When the process has achieved a steady state condition the operator must set the PLFAdjustReq. This makes a load impedance measurement to be used as a reference for detecting a partial load failure. If the load impedance measurement is successful 'PLFAdjusted' is set. The measurement cannot be made if the load voltage (V) is below 30% of VNominal or if the current (I) is below 30% of INominal. The input is edge sensitive, so if the request is made from external wiring, and the input remains permanently at a high level, only the first 0 to 1 edge is taken into account.

PLF Adjusted

Partial Load Failure Adjusted: Reports whether a successful load impedance measurement has been made (see PLF Adjust R above).

PLF Sensitivity

Partial load failure sensitivity. This defines how sensitive the partial load failure detection is to be as the ratio between the load impedance for a PLFadjusted load and the current impedance measurement. For example for a load of N parallel, identical elements, if the PLF Sensitivity (s) is set to 2, then a PLF alarm will occur if N/2, or more elements are broken (i.e. open circuit). If PLF Sensitivity is set to 3, then a PLF alarm occurs if N/3 or more elements are broken. If (N/s) is non-integer, then the sensitivity is rounded up. E.G. if the N = 6 and s= 4, then the alarm is triggered if 2 or more elements are broken.

Info menu

This display gives read only information about the unit.

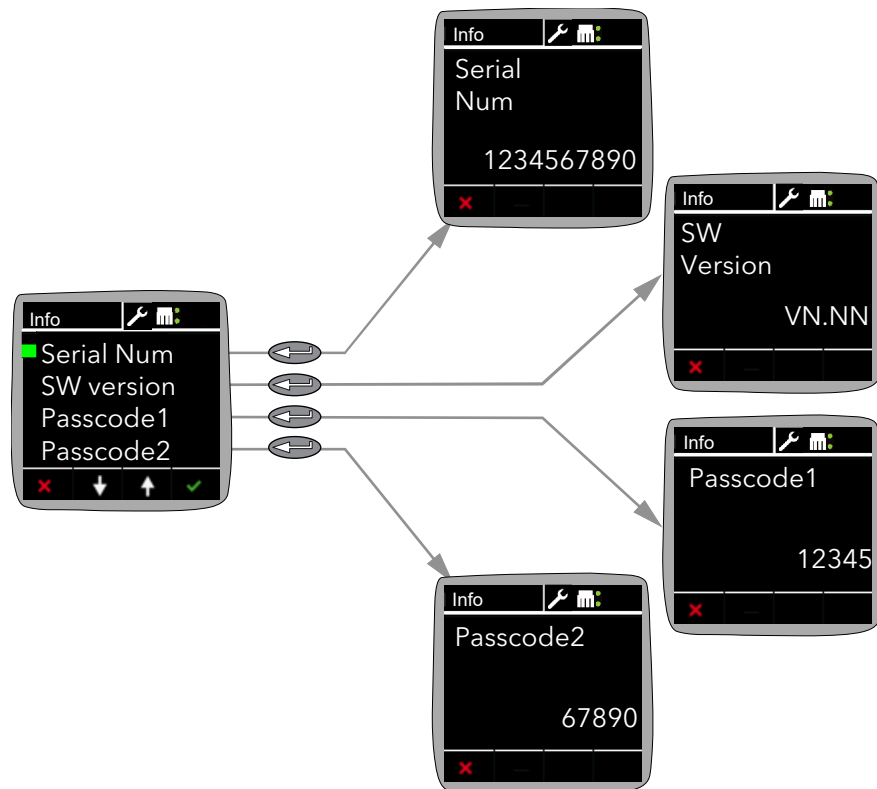

Figure 61 Info menu

Alarms menu

Allows the user to view Global acknowledgement enable status, and issues with calibration (if any). Any active alarms appear, and details can be found by highlighting the relevant alarm and using the Enter pushbutton.

Active alarms can be acknowledged, if applicable, by a further operation of the Enter button.

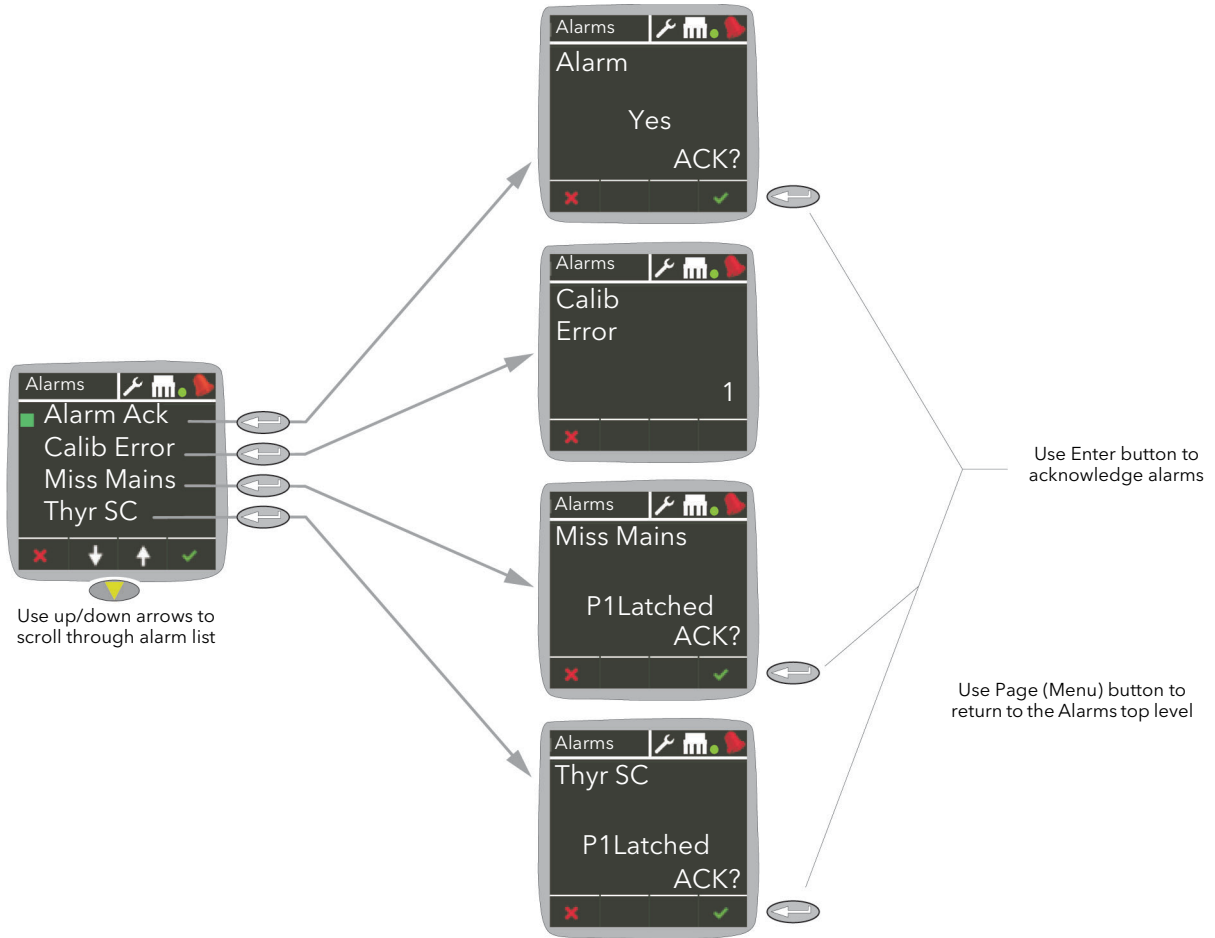

Figure 62 Alarms menu

Alm Disable menu

This menu allows the user to disable particular alarm types, so that they are no longer detected or acted upon. You can also do this using iTools.

By default all of the alarms are enabled.

To disable or re-enable an alarm, simply scroll through the list and select the alarm you want, then use the arrow keys to toggle its status between Disable and Enable as required.

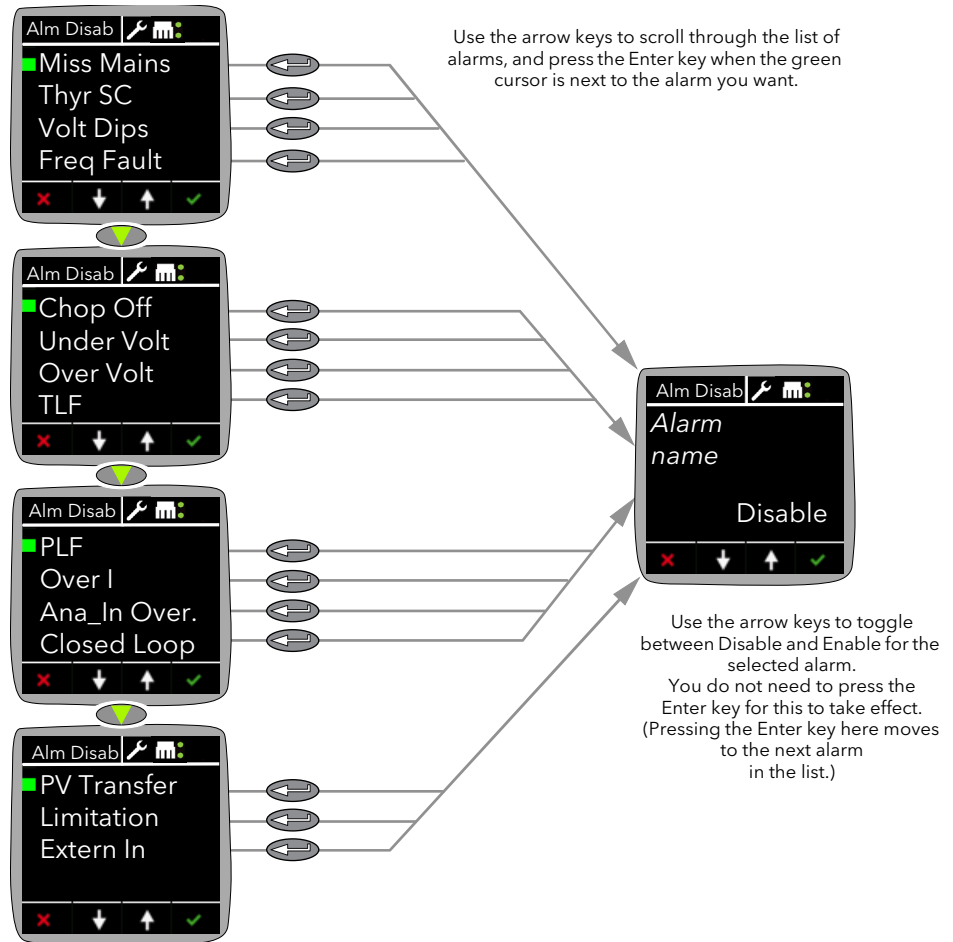

Figure 63 Alarm Disable menu

Alm Latch Menu

This menu allows the user to set latching or no latching to particular alarm types. To select the latching type, simply scroll through the list and select the alarm you want, then use the arrow keys to toggle its status between Latch and NoLatch as required.

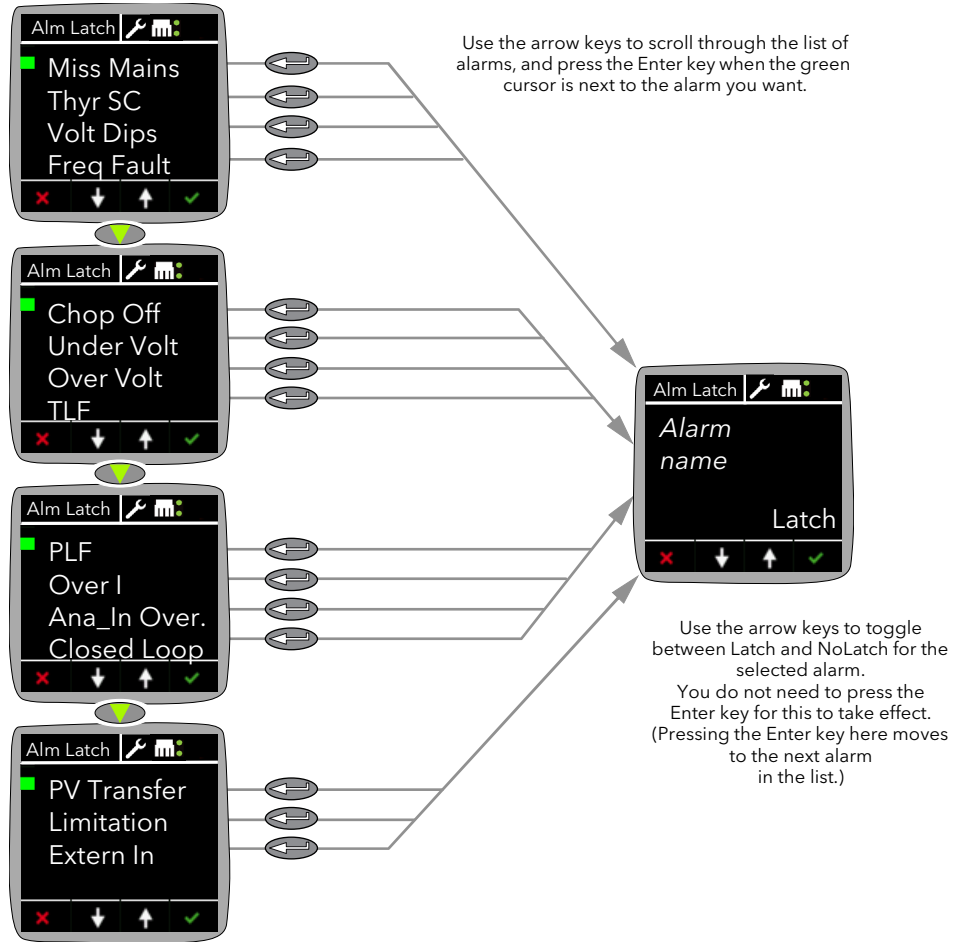

Figure 64 Alarm Latch Menu

Alm Stop menu

This menu allows the user to set which alarms will cause the EPack to stop firing. You can also do this using iTools.

By default, all of the system alarms are set to stop firing, but are customer configurable. Except for Missing Mains and Frequency Fault which are not user configurable.

To change whether an alarm causes the EPack to stop firing, simply scroll through the list and select the alarm you want, then use the arrow keys to toggle its status between Stop and NoStop as required.

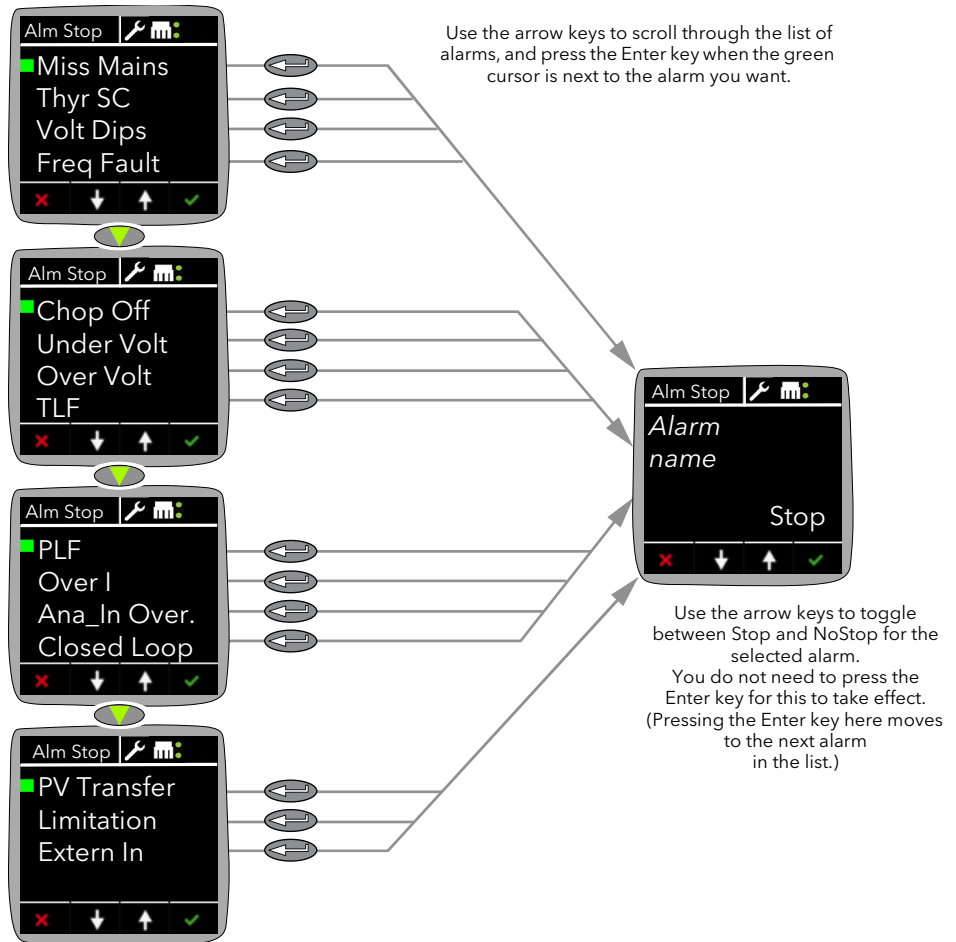

Figure 65 Alarm Stop menu

Alm Relay menu

This menu allows the user to select which alarms are to operate (de-energize) the EPack's relay. For each selected alarm, select 'Yes' or 'No'.

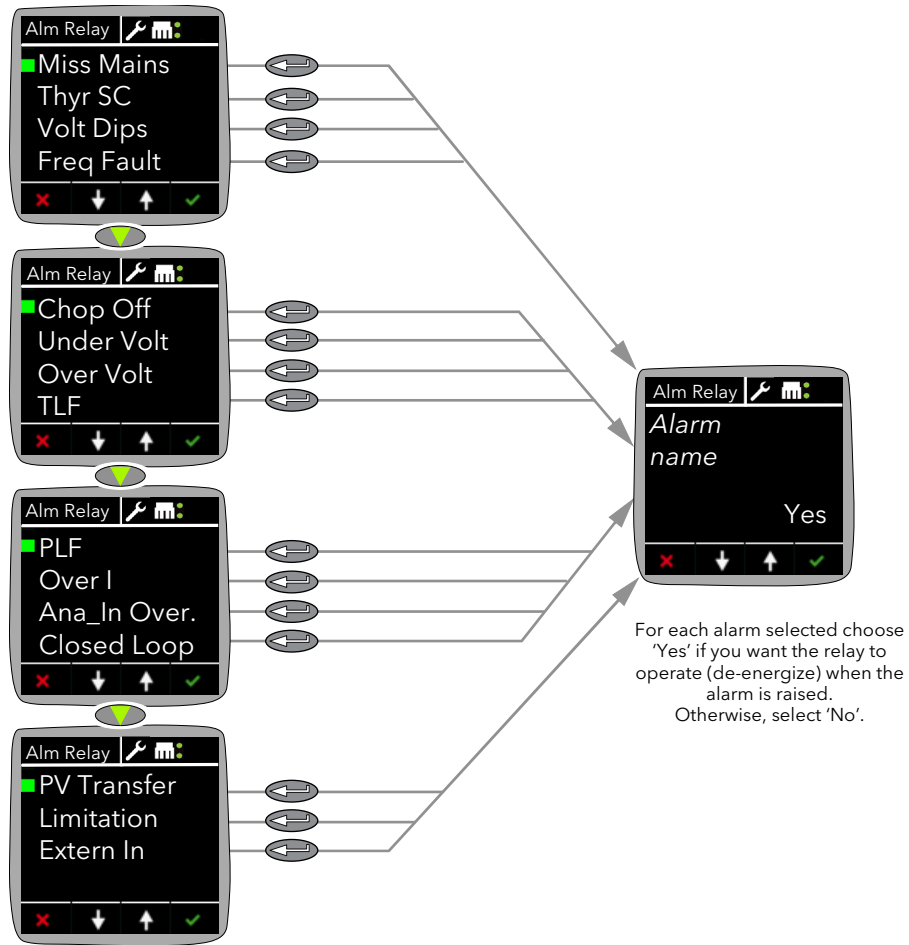

Figure 66 Alarm Relay menu

DI Stat menu

The DI Stat menu displays the status of the EPack's two digital inputs, DI1 and DI2.

'0' means a low level logic signal is being received at the input, '1' means a high level logic signal is being received at the input.

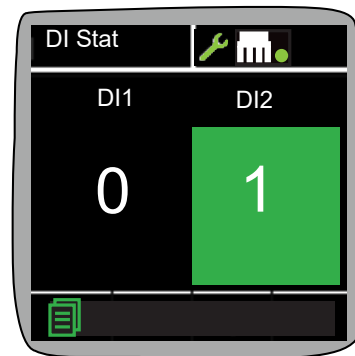

Figure 67 DI Stat menu

PLF Adjust menu

See "Adjust menu" on page 119.

Settings menu

The Settings menu is only available in Engineer mode. This menu is read-only, and lets you view the values of the parameters described below.

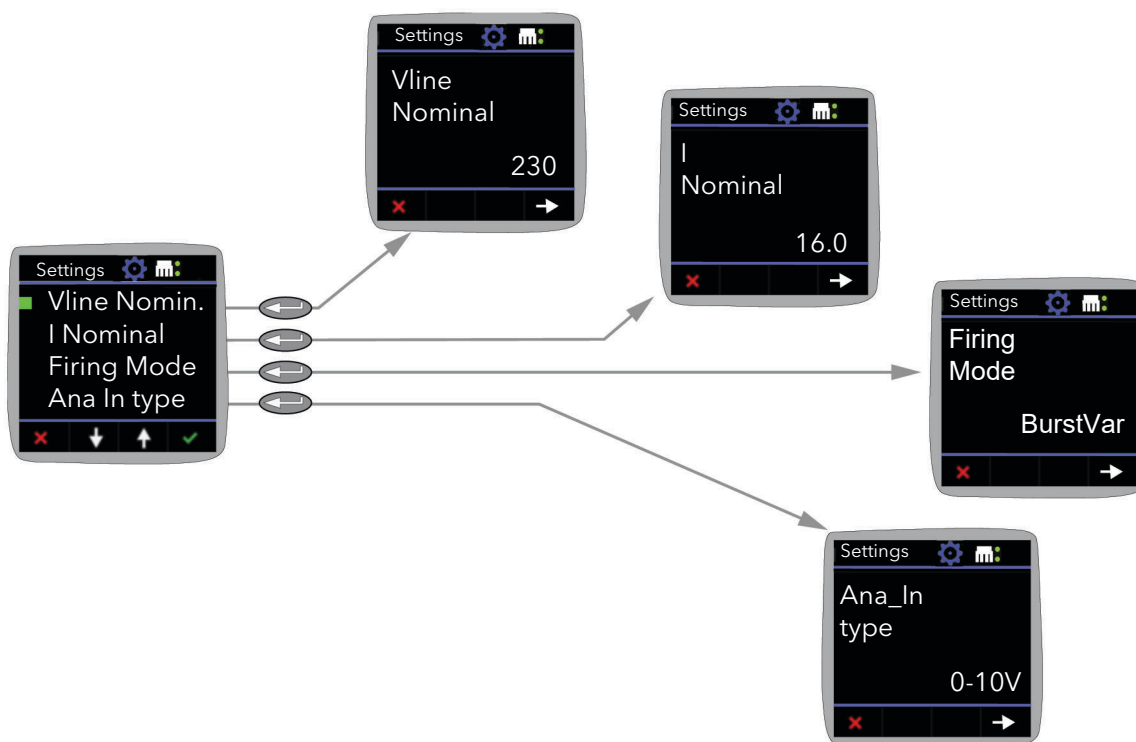
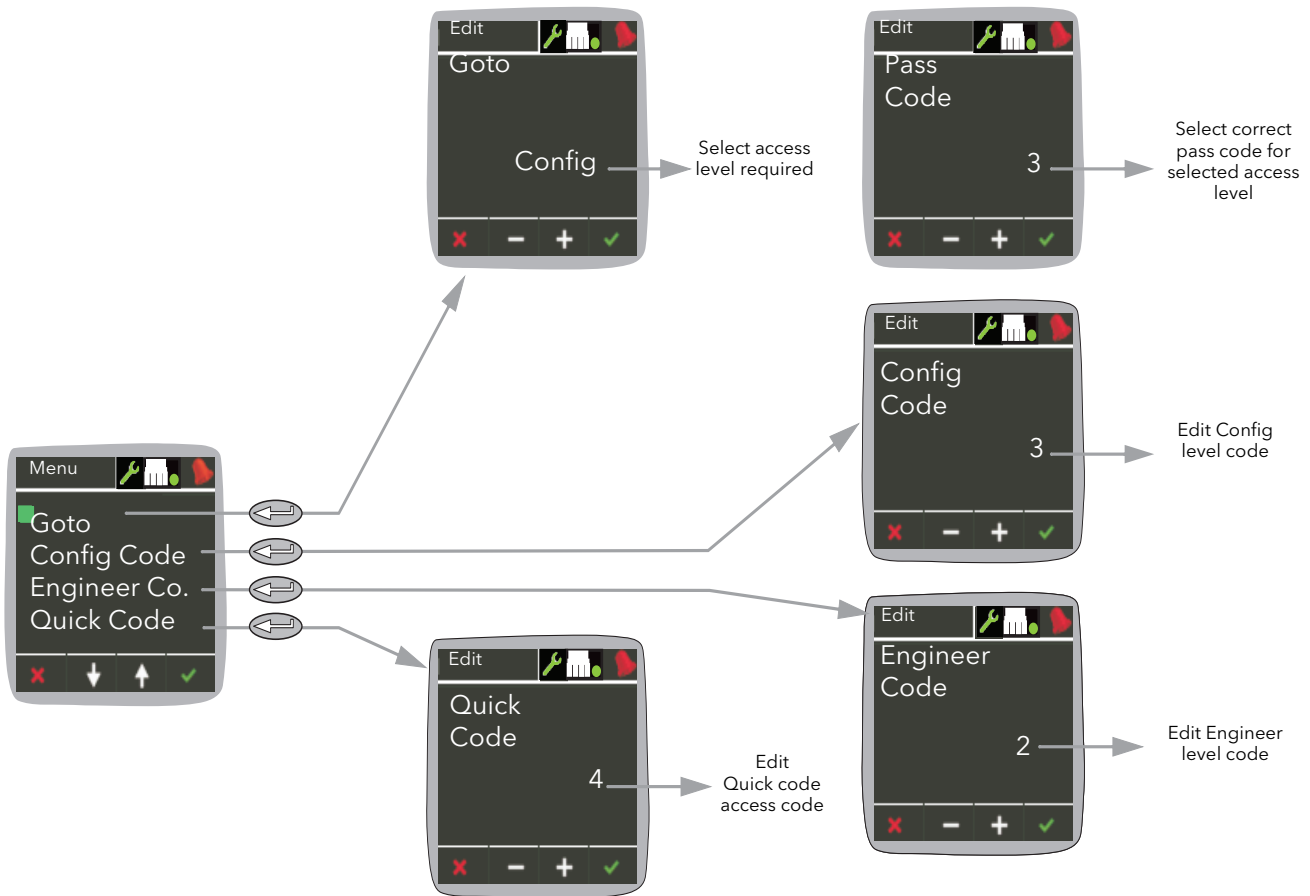

Figure 68 Settings menu

Vline Nominal	Line voltage nominal value (Line to neutral) or Line to L2 (phase to phase connection).
I Nominal	Nominal current supplied to the load.
Firing Mode	Reports the firing mode: Burst Var, Burst Fix, Logic, or Phase Angle (PA) or Intelligent half cycle (IHC).
Ana_in type	Reports the Analog Input type: 0 to 10V, 1 to 5 V, 2 to 10V, 0 to 5V, 0 to 20mA, or 4 to 20mA.

Access menu

Figure 69 Allows access to the Operator, Engineer, Configuration, and Quick Code menus and allows passwords to be set up. Access menu



Pass Code

Allows the user to enter the code for the access level required.

Config Code

Allows the user to edit the Configuration access level code

Engineer Code

Allows the user to edit the Engineer access level code

Quick Code

Allows the user to edit the Quick code access code

Note: The default access codes are Operator = 0, Engineer = 2, Config = 3, Quickcode = 4.

Access to Menus

1. Open the Access menu item.
2. Open the Goto menu item and select the access level required.
3. Enter the access code for the level required. If this access code is correct the relevant menu appears.

Note: The above applies only when the user attempts to access a higher level than that current. If accessing a lower level, the user needs only to open the Goto item and select the required level. After doing this, the instrument will probably restart.

Configuration using iTools

Introduction

Note: This chapter contains descriptions of all the menus which can appear. If an option or a feature is not fitted and/or enabled, then it does not appear in the top level menu.

This chapter details how to connect using iTools and gives details of the features available from this instrument.

Overview

The configuration of the unit is divided into a number of separate areas as follows:

- "Access Menu" on page 134
- "Alarm Configuration" on page 136
- "Communications Configuration" on page 137
- "Control Configuration" on page 140
- "Counter Configuration" on page 148
- "Energy Configuration" on page 150
- "Fault Detection Menu" on page 152
- "Firing Output Menu" on page 154
- "Input/Output (IO) Configuration" on page 157
- "Instrument Configuration Menu" on page 163
- "IP Monitor Configuration" on page 167
- "Lgc2 (Two Input Logic Operator) Menu" on page 168
- "Lgc8 (Eight-input Logic Operator) Configuration" on page 170
- "LIN16 Input Linearization" on page 173
- "Math2 Menu" on page 176
- "Modulator Configuration" on page 178
- "Network Configuration" on page 179
- "Qcode" on page 186
- "Setprov Configuration Menu" on page 187
- "Timer Configuration" on page 189
- "Totalizer Configuration" on page 191
- "User Value Configuration Menu" on page 192

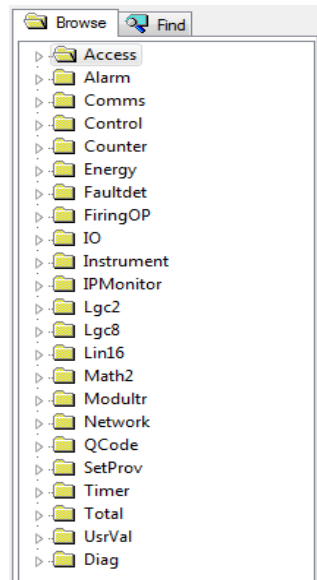

Figure 70 iTools tree

Note: Current rating, limitation, transfer control, power control, energy counter and the graphical wiring editor (GWE) are chargeable options. iTools secure can be used to upgrade units.

Access Menu

The Access menu allows the user to set the operating level (Operator, Engineer, Configuration or QuickStart) and define the access codes for these levels. It has to be also used to set a Comms Password used to protect Configuration data from being written via Comms. This password shall be provided each time config or QuickStart mode is to be entered from Comms. In addition, the Access menu allows the configuration of the optional 'OEM Security' feature.

'OEM security' helps to provide users, typically OEMs (original equipment manufacturers) the ability to protect their intellectual property by helping to prevent unauthorized access to configuration data.

An 'OEM security' access password can be configured to help prevent iTools from fully communicating with the instrument which helps to prevent specific parameters and their associated values from being copied or overwritten during iTools clone export/import.

In addition, when the OEM security feature is enabled, iTools has restricted access to Modbus addresses between 0x100 and 0x4744, graphical wiring and software upgrade functionality.

Note: The OEM security feature is a chargeable option, either when ordering or via the purchase of a secure feature pass code.

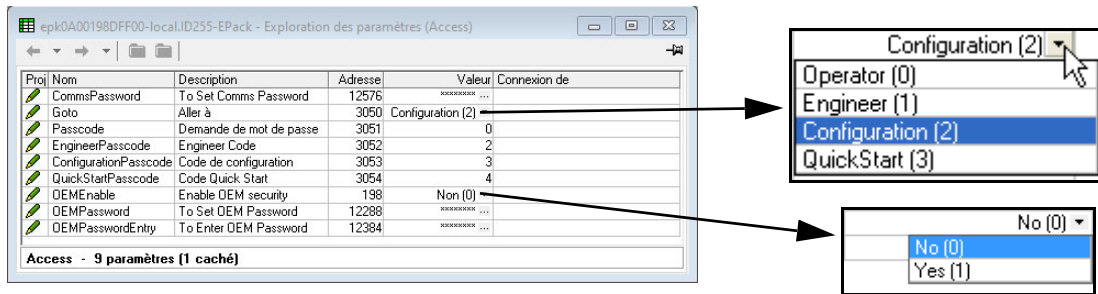

Figure 71 iTools Access menu

At commissioning when configuring I/O gateway it is NOT recommended to add the parameters 'Goto' and 'Passcode' in the list of data exchange, as CommsPassword will NOT be required before elevation of privilege (e.g. from operator mode to configuration mode).

WARNING

UNINTENDED EQUIPMENT OPERATION

- At commissioning, ensure cybersecurity robustness of the installation.

Failure to follow these instructions can result in death, serious injury or equipment damage.

To minimize any potential loss of control when communicating across a network via a third-party device (i.e. controller, PLC or configuration tool), ensure all system hardware, software and network design are correctly configured and commissioned for maximum cybersecurity robustness.

- CommsPassword Password used to enter config mode from Comms
- Goto Select access level
- Passcode Select relevant pass code for the access level required.
- EngineerPasscode Passcode for Engineer level access
- ConfigurationPasscode Passcode for Configuration level access
- QuickStartPasscode Passcode for Quickcode menu
- OEMEntry Password for OEM security access.
Provided the user enters the correct password, the OEM security feature will load and display the remaining OEM security parameters (and menus on the instruments front panel). (The OEMEntry password entered is compared to the OEMPassword parameter value, when identical access is provided and the OEM security feature loads).

Note: If five incorrect access codes are entered the OEMEntry menu will become non-editable for 30 minutes.

- OEMEnable OEM security parameter used to switch OEM security feature On (enable) or Off (disable).
This parameter is stored in non-volatile memory. The default value is Off (disable), after an initial Quickcode start.

OEMPassword	OEM security password parameter allows the user to edit the alphanumeric password. It shall be at least eight characters. This parameter is stored in non-volatile memory. If the OEMPassword parameter value is updated i.e. a new password entered the OEMEnable and OEMPassword parameters (and menus) disappear.
Clear memory	When available and set to 'yes', the device clears all configuration data (including the Comms Password), performs a cold-start and enters the Quickcode mode.

Alarm Configuration

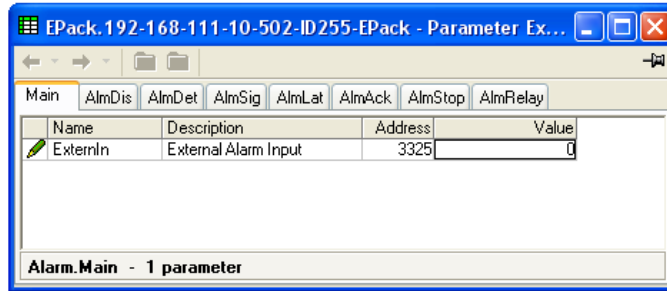

Figure 72 Alarm configuration

Main	'ExternIn' is the input of this block. When connected to digital input 2 (DI2) and DI2 connected to a fuse blown detection contact, this alarm is considered as a 'fuse blown' alarm.
AlarmDis	This allows the listed alarm to be enabled or disabled. 0 = Enable; 1 = Disable.
AlmDet	This parameter indicates whether the alarm has been detected and is currently active. 0 = Inactive; 1 = Active.
AlmSig	Signals that the alarm has occurred and is possibly latched by the Alarm Latch settings. If the user wishes to assign an alarm to, for example, a relay then it is the appropriate AlmSig parameter that should be wired. 0 = Not Latched; 1 = Latched.
AlmLat	The alarm can be configured as latching or non-latching, the latched state being shown in the Alarm Signal (AlmSig) register. 0 = Non-Latching; 1 = Latching.
AlmAck	Allows the alarm to be acknowledged. When an alarm is acknowledged, its related signaling (AlmSig) parameter is cleared. If the alarm is still active (as shown by the detection (AlmDet) parameter) then the alarm cannot be acknowledged. The acknowledge parameters automatically clear after being written. 0 = Do not acknowledge; 1 = Acknowledge.
AlmStop	Allows the alarm to be configured such that it stops the related power channel firing. AlmStop is activated by the signaling parameters and thus may be latching. 0 = Do not stop; 1 = Stop.
AlmRelay	This allows the listed alarm to operate and de-energize the alarm relay when set to active. No (0) = Inactive; Yes (1) = Active. (When utilizing AlmRelay function ensure FaultDet/CustomAlarm parameter remains wired to IO.Relay/PV).

Communications Configuration

The communications menu allows the user to view, and in some cases, to edit communications parameters associated with the communications option.

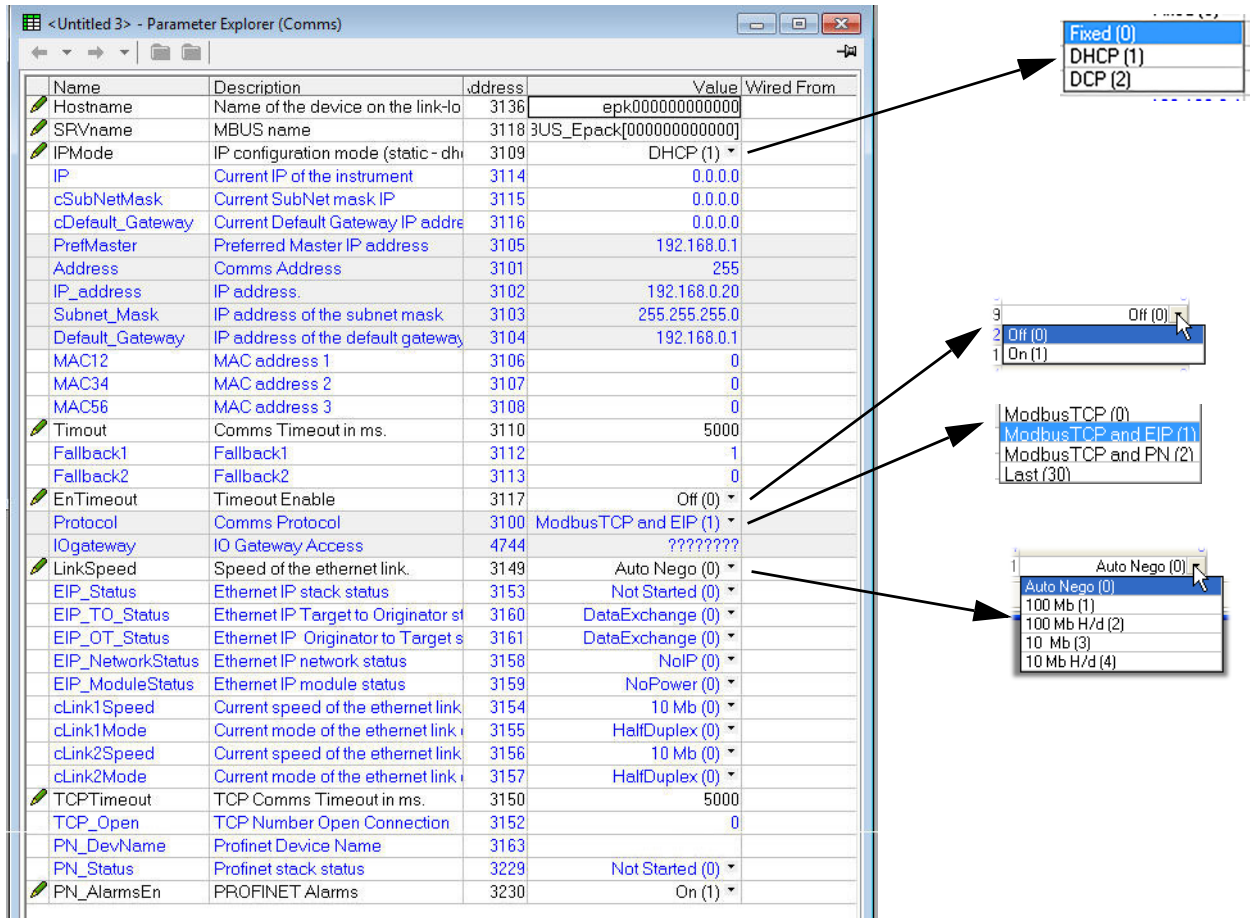

Figure 73 iTools comms page

Host name

The name of the device on the link-local network. For convenience, the device can declare itself on the pseudo-domain local. If the hostname of the device is changed, it must be ensured that the name is unique on the network. In this is not the case, the instrument will transparently try to find another unique name automatically.

The default value is related to the MAC address of the device and thus should already be unique.

SRV name

MBUS name. The name of the device, as shown by iTools

IP Mode

The IP configuration mode of the instrument. 0: Static. The IP parameters are taken from the parameter IPAddr, SubNetMark and NetGateway.

1: DHCP. The IP address of the instrument is automatically assigned by an external DHCP server. If the instrument does not acquire an IP address, the auto IP mechanism assigns an IP to the instrument in the range 169.254.xxx.xxx with subnet mask: 255.255.0.0.

2: DCP. The Discovery and Basic Configuration Protocol DCP is a protocol definition within the PROFINET context. It is a Data Link Layer based protocol to configure station names and IP addresses.

IP

This is the current IP address of the device which may be different from the configured IP address.

cSubnetMask

The current subnet mask associated with 'IP' above.

Default Gateway	The current default gateway associated with 'IP' above.
Pref Master	The IP address of the preferred host.
Address	On a network of instruments this address is used to specify a particular instrument. Each instrument on a network must be set to a unique address, the available address range depending upon the network protocol. As EPack supports only Modbus/TCP protocol, and discrimination on the network is carried out using the IP addresses of the connected instruments, the Modbus addresses of the devices are not used.
IP address	The configured IP address of the device
Subnet Mask	The subnet mask associated with 'IP address' above.
Default Gateway	The default gateway associated with 'IP address' above.
MAC12	First two Bytes of the MAC Address 11-22-33-44-55-66
MAC34	Second two Bytes of the MAC Address 11-22- 33-44-55-66
MAC56	Third two Bytes of the MAC Address 11-22-33-44- 55-66
Timeout	Comms timeout value in ms. If no usercomms request arrives within the time specified in this parameter, the Fallback values will change.
Fallback1	Set to 1 when a timeout occurs; set to 0 when communications are operating correctly.
Fallback2	Inverse value of the Fallback1 parameter.
EnTimeout	If set to ON (1), the timeout of the comms requests will be monitored. The outputs Fallback1 and Fallback2 will be adjusted accordingly. 0 =Off. 1= On
Protocol	Main communication protocol to access the instrument over Ethernet comms. 0 = ModbusTCP 1 = ModbusTCP and EIP (EtherNet/IP) 2 = ModbusTCP and PROFINET
IO gateway	IP address of IO gateway.
Link Speed	Select a link speed from Auto negotiate, 100MB, 100MB half duplex, 10 MB or 10MB 1/2 duplex.
EIP_Status	Displays the Ethernet/IP stack status, using one of the following values: 0: Ethernet/IP stack not started 1: Ethernet/IP stack ready 2: Ethernet/IP stack Standby 3: Ethernet/IP stack Running
EIP_TO_Status	Displays the Ethernet/IP Target to Originator status, using one of the following values: 0: Data Correctly Exchanged 1: Connection In progress 2: Connection Timeout 3: Connection Timeout 4: Unknown MAC Address 5: Consumption Timeout 6: Connection Closed by Forward Close 7: Module In Stop 8: Encapsulation Error 9: TCP Connection Error 10: No resources to handle connection 11: Bad Format 12: Idle mode 13: Unknown Status

EIP_OT_Status	<p>Displays the Ethernet/IP Originator to Target status, indicated by one of the following values:</p> <table border="0"> <tr> <td>0: Data Correctly Exchanged</td> <td>7: Module In Stop</td> </tr> <tr> <td>1: Connection In progress</td> <td>8: Encapsulation Error</td> </tr> <tr> <td>2: Connection Timeout</td> <td>9: TCP Connection Error</td> </tr> <tr> <td>3: Connection Timeout</td> <td>10: No resources to handle connection</td> </tr> <tr> <td>4: Unknown MAC Address</td> <td>11: Bad Format</td> </tr> <tr> <td>5: Consumption Timeout</td> <td>12: Idle mode</td> </tr> <tr> <td>6: Connection Closed by Forward Close</td> <td>13: Unknown Status</td> </tr> </table>	0: Data Correctly Exchanged	7: Module In Stop	1: Connection In progress	8: Encapsulation Error	2: Connection Timeout	9: TCP Connection Error	3: Connection Timeout	10: No resources to handle connection	4: Unknown MAC Address	11: Bad Format	5: Consumption Timeout	12: Idle mode	6: Connection Closed by Forward Close	13: Unknown Status
0: Data Correctly Exchanged	7: Module In Stop														
1: Connection In progress	8: Encapsulation Error														
2: Connection Timeout	9: TCP Connection Error														
3: Connection Timeout	10: No resources to handle connection														
4: Unknown MAC Address	11: Bad Format														
5: Consumption Timeout	12: Idle mode														
6: Connection Closed by Forward Close	13: Unknown Status														
EIP_Status	<p>Displays the status of the Ethernet/IP network, indicated by one of the following values:</p> <table border="0"> <tr> <td>0: No Power or No IP</td> <td>3: Time Out on Connection</td> </tr> <tr> <td>1: No connection Enabled Unit is On-line (IP address configured) but No connection enabled</td> <td>4: Critical error Unit is in Critical error (like duplicate address)</td> </tr> <tr> <td>2: Connection established Unit is On-line (IP address configured) and connection enabled</td> <td></td> </tr> </table>	0: No Power or No IP	3: Time Out on Connection	1: No connection Enabled Unit is On-line (IP address configured) but No connection enabled	4: Critical error Unit is in Critical error (like duplicate address)	2: Connection established Unit is On-line (IP address configured) and connection enabled									
0: No Power or No IP	3: Time Out on Connection														
1: No connection Enabled Unit is On-line (IP address configured) but No connection enabled	4: Critical error Unit is in Critical error (like duplicate address)														
2: Connection established Unit is On-line (IP address configured) and connection enabled															
EIP_ModuleStatus	<p>Displays the status of the Ethernet/IP module, indicated by one of the following values:</p> <table border="0"> <tr> <td>0: No power on the device</td> <td>3: Recoverable Fault</td> </tr> <tr> <td>1: Unit not configured Unit not configured or Scanner in Idle mode</td> <td>An incorrect or inconsistent configuration would be considered a minor fault</td> </tr> <tr> <td>2: Controlled by a scanner in Run state</td> <td>4: Major Fault</td> </tr> <tr> <td>Controlled by a scanner in Run state</td> <td>Major fault (Exception state, critical error etc.)</td> </tr> </table>	0: No power on the device	3: Recoverable Fault	1: Unit not configured Unit not configured or Scanner in Idle mode	An incorrect or inconsistent configuration would be considered a minor fault	2: Controlled by a scanner in Run state	4: Major Fault	Controlled by a scanner in Run state	Major fault (Exception state, critical error etc.)						
0: No power on the device	3: Recoverable Fault														
1: Unit not configured Unit not configured or Scanner in Idle mode	An incorrect or inconsistent configuration would be considered a minor fault														
2: Controlled by a scanner in Run state	4: Major Fault														
Controlled by a scanner in Run state	Major fault (Exception state, critical error etc.)														
EIP_cLink1Speed	Displays the current speed of the Ethernet link on Port1.														
EIP_clink1Mode	Displays the current mode of the Ethernet link on Port1.														
EIP_cLink2Speed	Displays the current speed of the Ethernet link on Port2.														
EIP_clink2Mode	Displays the current mode of the Ethernet link on Port2.														
TCPTimeout	<p>Timeout used to close an open TCP connection, which are not being used by Master that originally opened it - adjust in configuration mode.</p> <p>Default value is 5000 ms.</p>														
TCP_Open	TCP Open is the quantity of live, open connections.														
PN_DevName	Displays the Profinet device name.														
PN_Status	<p>This parameter gives the status of the Profinet stack;</p> <p>0 : Not started.</p> <p>1 : Ready.</p> <p>2 : Running.</p>														
PNAlarmsEn	Enables or disables the PROFINET Alarms (EPack's Alarms). See "Alarm Notification" on page 109.														

Control Configuration

The control menu provides the control algorithm to perform power control and transfer, threshold limiting and phase angle reduction (in the case of burst firing). [Figure 74](#), below, gives an overview of the menu, which is described in the following sections:

- Setup
- Main
- Limit
- Diag (Diagnostics)
- AlmDis (Alarm disable)
- AlmDet (Alarm detection)
- AlmSig (Alarm Signaling)
- AlmLat (Alarm latching)
- AlmAck (Alarm Acknowledgement)
- AlmStop (Stop firing on alarm)
- AlmRelay, Control Alarm Relay

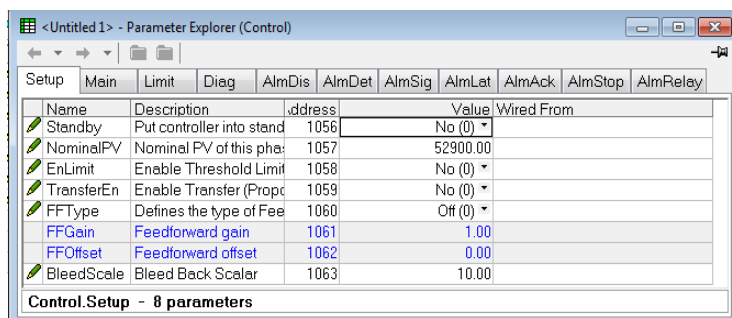

Figure 74 Control menu overview

Control setup menu

This contains parameters for setting the type of control to be performed.

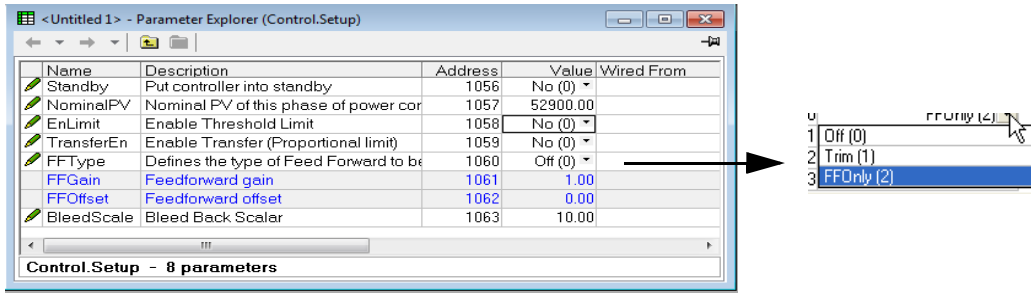

Figure 75 Control setup page

Parameters

- Standby** If Yes (1), the controller enters Standby mode and zero % power is demanded. When removed from Standby (0) the unit returns to operating mode in a controlled manner.
- Nominal PV** Normally the nominal value for each control type. For example, for feedback mode = V^2 , Vs_q should be wired to the Main PV, and Nominal PV set to the nominal value expected for V^2 (usually $V_{LoadNominal}^2$).
- En Limit** This is a software feature available at order stage (CL on field 3 of the product code) or upgradable afterward. If it is available it is used to enable/disable threshold limit (By default the current limit function is enabled).

Note: The current limiting function is not available with the firing mode; Intelligent Half Cycle (IHC).

- Transfer En** Select Transfer Enable (Proportional limit) as 'Yes' (enabled) or 'No' (not enabled).
- FF Type** Feedforward Type.
Off (0). Feedforward is disabled
Trim (1). Feedforward value is the dominant element of the output. Trimmed by the control loop based on the Main PV and setpoint.
FFOnly (2). The feedforward value is the output from the controller. Open loop control may be configured by this means.
- FF Gain** The entered gain value is applied to the Feedforward input.
- FF Offset** The entered value is applied to the Feedforward input after the Gain value has been applied to it.
- Bleed Scale** Internal parameter for use by service personnel.

Control Main menu

This menu contains all the parameters associated with the Main control loop.

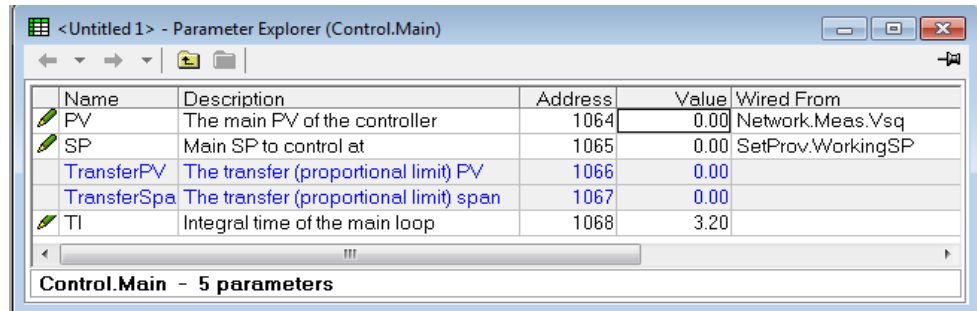

Figure 76 Control 'Main' menu

Parameters

- PV** Displays the main Controller Process Variable (PV). Wired to the measurement which it is to be controlled. For example, to perform V² control. Vs_q should be wired to this (PV) parameter and Nominal PV configured appropriately.
- SP** The Setpoint to control at, as a percentage of Nominal PV (the upper range of the loop in engineering units). For example, if Vs_q = 193600, and SP is set to 20%, the controller attempts to regulate at 193600 x 20/100 = 38720.
- Trans PV** Transfer PV. This is the PV measurement for transfer. For example, if a V₂ to I₂ transfer is required, the Vs_q should be wired to MainPV and Is_q to TransferPV. Appears only if Trans Enable ([Control setup menu](#)) is set to 'Yes'.
- Trans SP** The span of operation for transfer. Appears only if Trans Enable ([Control setup menu](#)) is set to 'Yes'.
- TI** Allows the user to define an integral time for the main PI control loop.

Control limit configuration

This area configures parameters relating to the limit control loop.

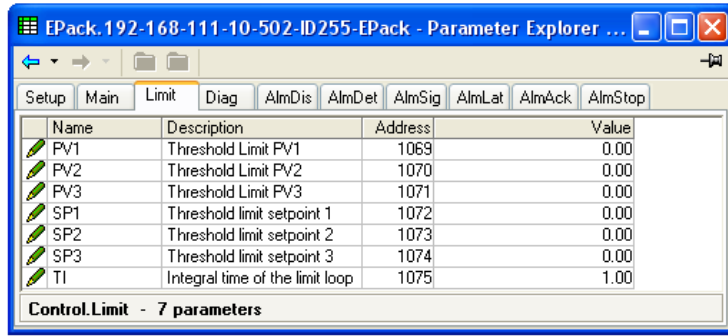

Figure 77 Control limit menu

Parameters

- PV1 to PV3 Process value for limit loops 1 to 3 respectively. This is the value to perform threshold limit control. 'Limit Enable' must be set to 'Yes' in the Setup menu ([Control setup menu](#)).
- SP1 to SP3 The Threshold Setpoint for limit loops 1 to 3 respectively.
- TI The integration time for the limit PI control loop. The default value is firing mode dependent.

Example:

If I² threshold limiting is required, Isq is wired to PV1, and the required threshold value is entered at SP1. In phase angle configuration, the phase angle is reduced to achieve the limit setpoint; in burst firing, the unit continues to fire in bursts, but these bursts are of phase angle in order to achieve the limit setpoint. The modulation continues to attempt to reach the main setpoint.

Also known as phase angle reduction burst firing.

Control diagnostic menu

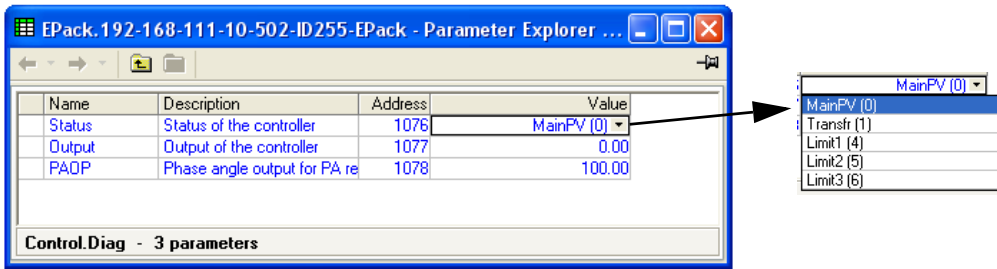

Figure 78 iTools diagnostic menu

Parameters

Status	Indicates the current operating state of the controller:
Main PV	The control strategy is using Main PV as the control input
Transfer	The transfer input is being used as the input to the control strategy.
Limit1(2)(3)	Control limiting is currently active using limit PV1(2)(3) and limit SP 1(2)(3).
Output	The current output demand in percent. Normally wired to Modulator.In or FiringOP.In
PAOP	Applies only to Burst Firing control modes. If this parameter is wired to Firing.limitIn, the power module will deliver bursts of phase angle firing depending both on the Main Setpoint and on the Limit Setpoint.

Control Alarm disable menu

Allows each alarm of the control block to be disabled, individually.

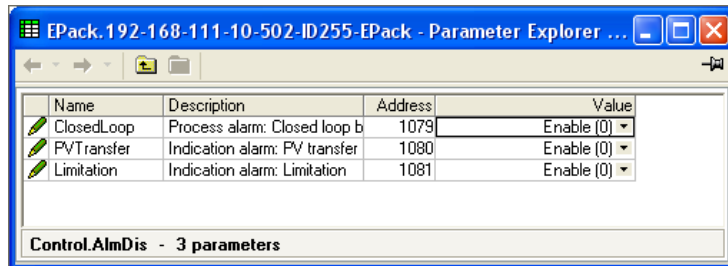

Figure 79 Alarm disable page

Parameters

Closed Loop	Select Enable (0) or Disable (1) for loop break alarm.
PV Transfer	As for Closed Loop, but for the 'Transfer active' alarm.
Limitation	As for Closed Loop, but for the 'Control limit active' alarm.

Control Alarm Detection Parameters

Indicates whether each alarm has been detected and whether or not it is currently active.

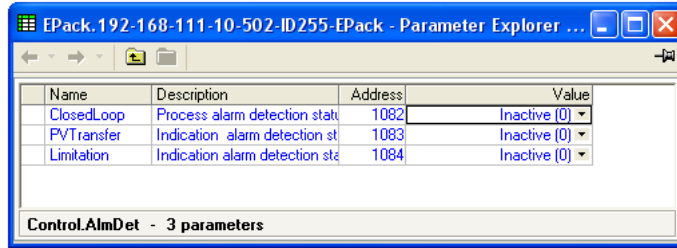

Figure 80 Control Alarm detection page

Parameters

- Closed Loop** Displays whether or not the closed loop alarm is currently active.
- PV Transfer** As for Closed Loop, but for the 'Transfer Active' alarm.
- Limitation** As for Closed Loop, but for the 'Control limit active' alarm.

Control Alarm signaling parameters

Signals that an alarm has occurred and has been latched (if so configured in 'Alarm Latch' (page 146). If it is required that an alarm is to be assigned to a relay (for example), then the appropriate alarm signaling parameter should be used.

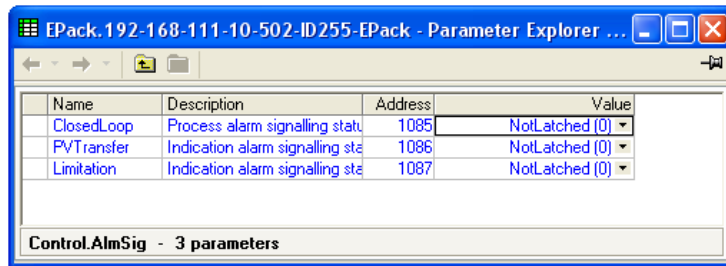

Figure 81 Control Alarm Signaling page

Parameters

- Closed Loop** Indicates whether the closed loop break alarm is currently active.
- PV Transfer** As for Closed Loop, but for the 'Transfer Active' alarm.
- Limitation** As for Closed Loop, but for the 'Control limit active' alarm.

Control Alarm Latch parameters

Allows each alarm to be configured as latching or not latching.

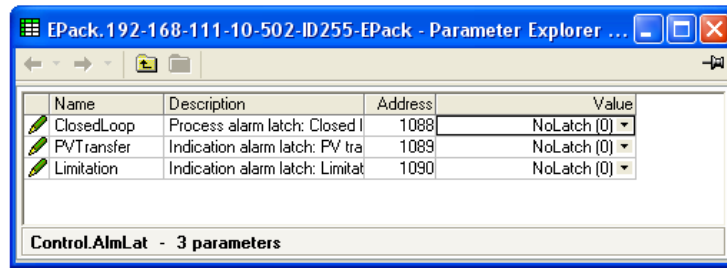

Figure 82 Control Alarm latching page

Parameters

- Closed Loop Set the latching status of the alarm.
- PV Transfer As for Closed Loop, but for the 'Transfer Active' alarm.
- Limitation As for Closed Loop, but for the 'Control limit active' alarm.

Control Alarm Acknowledgement parameters

This menu allows individual alarms to be acknowledged. On acknowledgement, the related signaling parameter is cleared. The Acknowledge parameters automatically clear after being written.

If the alarm is still active (as shown by the Alarm Detection display) it cannot be acknowledged.

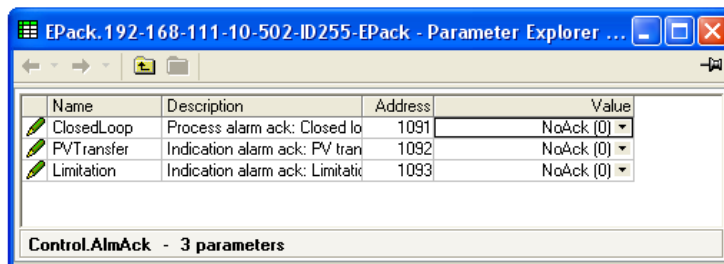

Figure 83 Control Alarm Acknowledge page

Parameters

- Closed Loop Displays whether the closed loop alarm has been acknowledged or not.
- PV Transfer As for Closed Loop, but for the 'Transfer Active' alarm.
- Limitation As for Closed Loop, but for the 'Control limit active' alarm.

Control Alarm Stop parameters

Allows individual channels to be configured such that it will stop the associated power channel from firing whilst the alarm is active. This feature is activated by the signaling parameters, so the alarm stop may be latching.

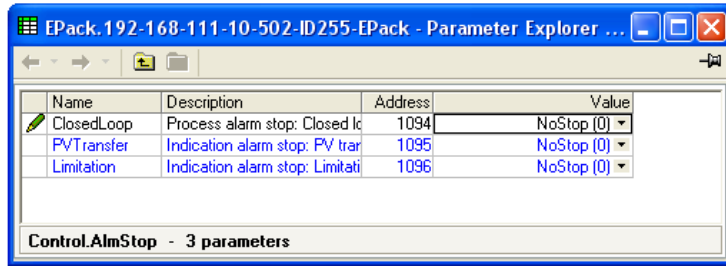

Figure 84 iTools Control Alarm Stop page

Parameters

- Closed Loop Shows whether the closed loop alarm has been configured to disable firing or not.
- PV Transfer As for Closed Loop, but for the 'Transfer Active' alarm.
- Limitation As for Closed Loop, but for the 'Control limit active' alarm.

AlmRelay, Control Alarm Relay

Allows each individual alarm to be configured, so the alarm relay is de-energized (or not), whilst the alarm is active.

Note: When utilizing AlmRelay function ensure FaultDet/CustomAlarm parameter remains wired to IO.Relay/PV.

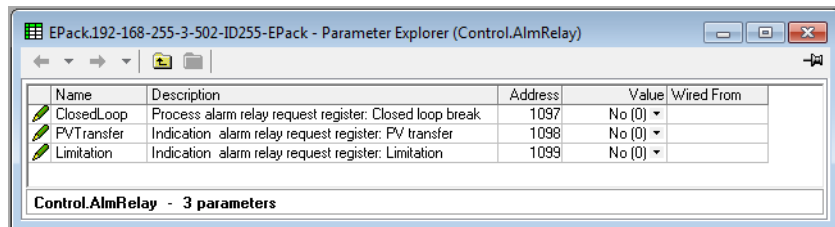

Figure 85 iTools Control Alarm Relay page

Parameters

- Closed Loop Shows whether the closed loop alarm has been configured to de-energize alarm relay firing, or not.
- PV Transfer As for Closed Loop, but for the 'Transfer Active' alarm.
- Limitation As for Closed Loop, but for the 'Control limit active' alarm.

Counter Configuration

The counter output is a 32-bit integer the value of which is recalculated every sample period. When a clock state change from 0 (false) to 1 (true) is detected, the counter value is incremented if the count direction is 'up' or decremented if the direction is 'down'.

At reset, the counter value is set to 0 for count up counters or to the 'Target' value for count down counters.

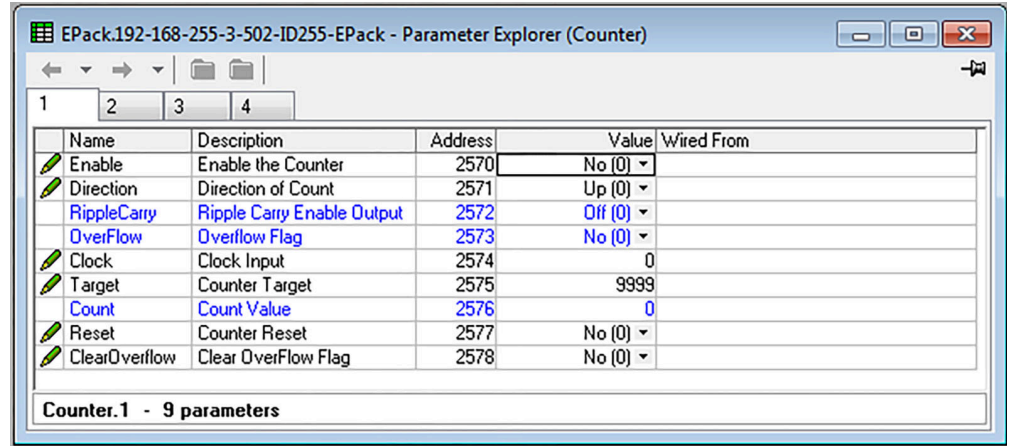

Figure 86 iTools Counter page

Parameters

- Enable** The counter responds to clock transitions when enabled; the count is frozen when disabled.
- Direction** Select up or down as the direction of count. Up counters start at (and are reset to) zero; down counters start from (and are reset to) the Target value (below).
- Ripple Carry** The Ripple carry output of one counter can act as the enabling input for the next counter in a cascade. Ripple carry is set 'true' when the counter is enabled and its value is either zero (for count down timers) or equal to the Target value (count up counters).
- Overflow** Overflow becomes 'true' when the value of the counter is either zero (for count down timers) or equal to the Target value (count up counters).
- Clock** The counter increments or decrements on a positive going edge (0 to 1; False to true).
- Target** Up counters: Start at zero and count towards the Target value. When this value is reached, Overflow and Ripple-carry are set true (value = 1).
Down counters: Start at the Target value and count towards zero. When zero is reached, Overflow and Ripple-carry are set true (value = 1).
- Count** The current value of the counter. This is a 32-bit integer which accumulates clock transitions. Minimum value is zero.
- Reset** Resets up-counters to zero or down-counters to the Target value. Reset also sets Overflow to False (i.e. Overflow = 0)
- Clear Overflow** Sets Overflow to False (i.e. Overflow = 0)

Cascading Counters

As implied above, it is possible to 'wire' counters in cascade mode. Details for an 'up' counter are shown in [Figure 87](#). Down counter configuration is similar.

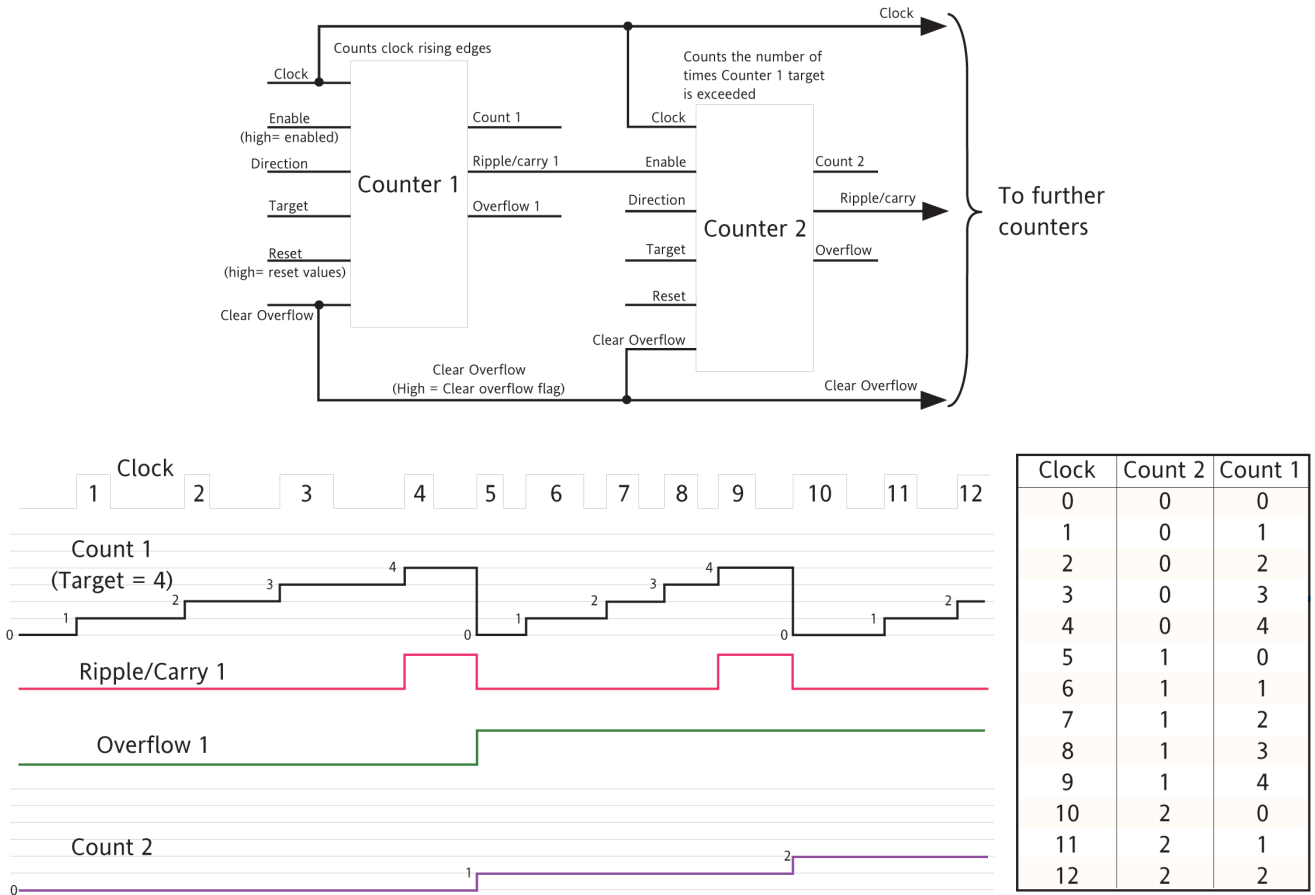

Figure 87 Cascading up counters

Note: Counter 2 above counts the number of times that Counter 1 target is exceeded. By permanently enabling counter 2, and wiring counter 1 'Ripple Carry' output to counter 2 'Clock' input (replacing the connection to the clock pulse stream), counter 2 will indicate the number of times counter 1 target is reached, rather than exceeded.

Energy Configuration

Provides a number of energy counters to totalize consumed energy. The power consumed can be displayed in one of a number of units, ranging from Wh to GWh.

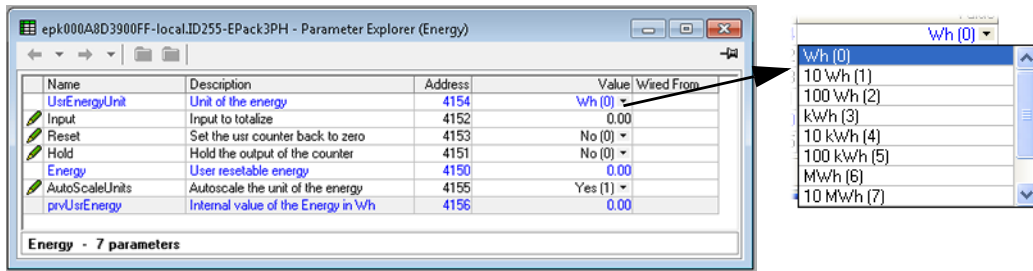

Figure 88 Energy configuration page

Parameters

- UsrEnergyUnit** Allows a scaling units value to be entered for the energy display. Selectable as '1Wh', '10Wh', '100Wh', '1kWh', '10kWh', '100kWh', '1MWh', '10MWh', '100MWh' or '1GWh'.
- Input** Shows the instantaneous power input from the measuring source. Normally wired to the Meas.P output of the block.
- Reset** 1 = Energy counter output goes to zero and immediately starts accumulating.
0 = Energy counter not reset.
- Hold** 1 = Hold output value. This freezes the output value for the block at the current value. The input continues to be totalized, so when the Hold input returns to 0, the output value is instantaneously updated to the new current value.
0 = output value is not held, and represents the current accumulated Energy value.
- Energy** Shows the current value for the selected Energy Counter block.
- Autoscale** No = Use UsrUnit setting.
Yes = Autoscale power value display (Table 5).

Table 5: Scaler values

Power range (Watt-hours)	Scaler value
0 to 65535	1
65,535 to 65,535,000	1k
65,535,000 to 655,350,000	10k
655,350,000 to 6,553,500,000	100k
6,553,500,000 to 65,535,000,000	1M
65,535,000,000 to 655,350,000,000	10M
655,350,000,000 to 6,553,500,000,000	100M
6,553,500,000,000 upwards	1G

Resolution

The resolution of the stored energy value varies according to the totalized value, as shown in Table 6. For example, for stored values between 33,554,432 watt-hours and 67,108,863 watt-hours, the value increases in 4 watt-hour increments.

Table 6: Energy counter resolution

Power range (Watt-hours)	Resolution (Wh)	Power range (Watt-hours)	Resolution (Wh)
0 to 16,777,215	1	17,179,869,184 to 34,359,738,367	2048
16,777,216 to 33,554,431	2	34,359,738,368 to 68,719,476,736	4096
33,554,432 to 67,108,863	4	68,719,476,736 to 137,438,953,471	8192
67,108,864 to 134,217,727	8	137,438,953,472 to 274,877,906,943	16384
134,217,728 to 268,435,455	16	274,877,906,944 to 549,755,813,887	32768
268,435,456 to 536,870,911	32	549,755,813,888 to 1,099,511,627,776	65536
536,870,912 to 1,073,741,823	64	1,099,511,627,776 to 2,199,023,255,551	131072
1,073,741,824 to 2,147,483,647	128	2,199,023,255,552 to 4,398,046,511,103	262144
2,147,483,648 to 4,294,967,295	256	4,398,046,511,104 to 8,796,093,022,207	524288
4,294,967,296 to 8,589,934,591	512	8,796,093,022,208 to 17,592,186,044,415	1048576
8,589,934,592 to 17,179,869,183	1024		

Fault Detection Menu

This manages Alarm logging and provides an interface for the General Alarm Acknowledgement.

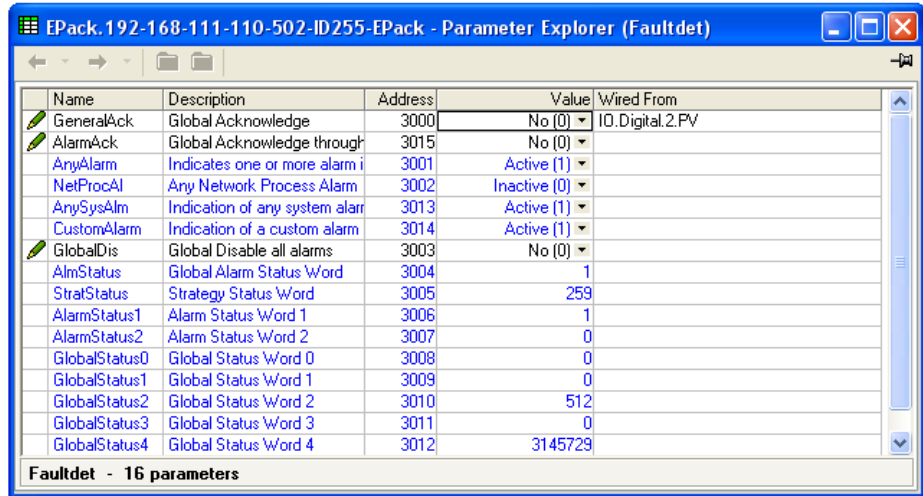

Figure 89 Fault detection menu page

Parameters

General Ack	Performs a global acknowledgement of alarms. Latched alarms are cleared if their trigger sources are no longer in an alarm state. Wired by default from Digital input 2.
AlarmAck	Enables global alarm acknowledgement from front fascia.
Any Alarm	'Active' indicates that there is one or more System, Process or 'Chop Off' alarm active. If the relevant alarms are enabled, System alarms and Chop Off alarms always cause the power module to stop firing. Process alarms can also be configured to prevent firing in 'Alarm stop'.
NetProcAl	Indicates that a process alarm has occurred in the power network.
AnySysAlm	Indicates that a systems alarm is active. By default, this is wired to Custom Alarm, see below.
Custom Alarm	Indicates that an alarm using rules defined by user, is active. By default, this is wired to IO Relay.PV. (See AlmRelay tab in corresponding function block)
Global Disable	Allows the user to disable/enable all alarms.

StratStatus A coded status word giving strategy information as shown in Table 7.

Table 7: Strategy status

Bit	Value	Description
0	1	Not firing
1	2	Not synchronising
2	4	Reserved
3	8	Reserved
4	16	Reserved
5	32	Reserved
6	64	Reserved
7	128	Strategy in standby mode
8	256	Strategy in Telemetry mode
9	512	Reserved
10	1024	Reserved
11	2048	Reserved
12	4096	Reserved
13	8192	Reserved
14	16384	Reserved
15	32768	Reserved

Alarm Status 1(2) Two 16-bit words containing alarm status information as shown in Table 8.

Table 8: Alarm status word 1

Alarm status word 2

Bit	Value	Description	Bit	Value	Description
0	1	Missing mains	0	1	Closed loop
1	2	Thyristor short circuit	1	2	Transfer active
2	4	Over temp*	2	4	Limit active
3	8	Dips	3	8	Reserved
4	16	Frequency out of range	4	16	Reserved
5	32	Total Load Failure	5	32	Reserved
6	64	Chop off	6	64	Reserved
7	128	Partial load failure	7	128	Reserved
8	256	Partial load unbalance	8	256	Any bit in Global Status 0
9	512	Over voltage	9	512	Any bit in Global Status 1
10	1024	Under voltage	10	1024	Any bit in Global Status 2
11	2048	Pre temp*	11	2048	Any bit in Global Status 3
12	4096	Over current	12	4096	Reserved
13	8192	Reserved	13	8192	Reserved
14	16384	Analogue input over C	14	16384	Reserved
15	32768	External input	15	32768	Reserved

Note: * These alarms not applicable at this release but are reserved for future development.

Firing Output Menu

This forms the link between the control strategy and the physical load. This block also supplies Phase-Angle Ramp (Soft start) and Safety Ramp.

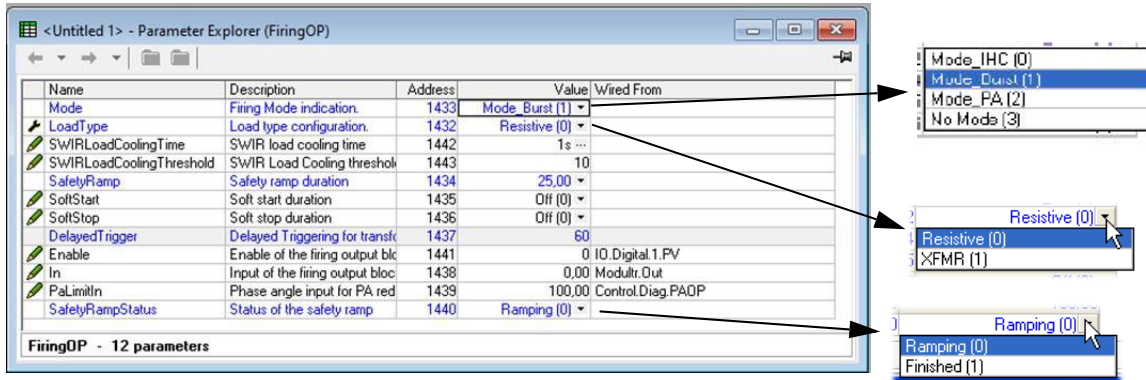

Figure 90 iTools configuration firing output page

Mode Displays the current firing mode as Intelligent Half Cycle (IHC), Burst firing, Phase angle firing or No Mode. Configured in the 'Modulator', menu described below.

⚠ **WARNING**

UNINTENDED EQUIPMENT OPERATION

- At commissioning, ensure correct product configuration.

Failure to follow these instructions can result in death, serious injury or equipment damage.

For transformer Load, select XFMR as Load Type (select Yes for Transfo. in QuickCode). For transformer Load, in burst firing mode, without soft start, adjust Delayed Triggering (DelayedTrigger) to minimize inrush current.

Load Type Allows the load type to be selected as 'Resistive' or 'Transformer'. For Load type = Resistive, the load must be connected directly to the power module and only resistive loads may be so connected. For Load Type = Transformer, the load is connected to the power module via a transformer, and may be resistive or reactive.

SWIR Load Cooling Time: Appears only if Heater Type is SWIR.
 0: No dedicated firing strategy is applied on SWIR load
 1-max: A Safety ramp is applied at next firing if no power is applied on SWIR load for more than this amount of time in ms if Heater Type different from SWIR.

SWIR Load Cooling Threshold: Appears only if Heater Type is SWIR and SWIR Load Cooling Time is different from zero.
 This is the Firing angle in percent below which SWIR load is considered unpowered (cold).
 This threshold can be adjust between 0 and 25%.

'Safety Ramp' Displays the startup ramp duration, in supply voltage cycles (0 to 255), to be applied at startup. The ramp is either a phase angle ramp from zero to the requested target phase angle or, for Burst Firing, ranges from 0 to 100%, see Figure 91. Safety Ramp is not applicable to Intelligent Half Cycle (IHC) Mode if Heater Type is different from SWIR.

Soft Start	For Burst Firing only, this is the soft start duration, in supply voltage cycles, applying a phase angle ramp at the beginning of each on period (Figure 92).
Soft Stop	In Burst Firing, the soft stop duration, in supply voltage cycles, applying a phase angle ramp at the end of each on period.
Delayed Trigger	Appears only if Mode = Burst, Soft Start = Off, and Load Type = TxFormer. Delayed Trigger specifies the triggering delay, in phase angle, when delivering power into a transformer load. Used to minimize inrush current. the value is configurable between 0 and 90 degrees inclusive (Figure 93).
Enable	Enables/disables firing. Must be wired to a non-zero value to enable firing (typically a digital input).
In	Displays the input power demand value that the power module is to deliver.
PA Limit	Phase angle limit. This is a phase angle reduction factor used in Burst Firing. If lower than 100% the power module will deliver a burst of phase angle firing. Used, typically, to perform threshold current limiting in Burst Firing.
Ramp Status	Displays the safety ramp status as 'Ramping' or 'Finished'.

Examples

Safety Ramps, Soft Start and Delayed Trigger, firing types

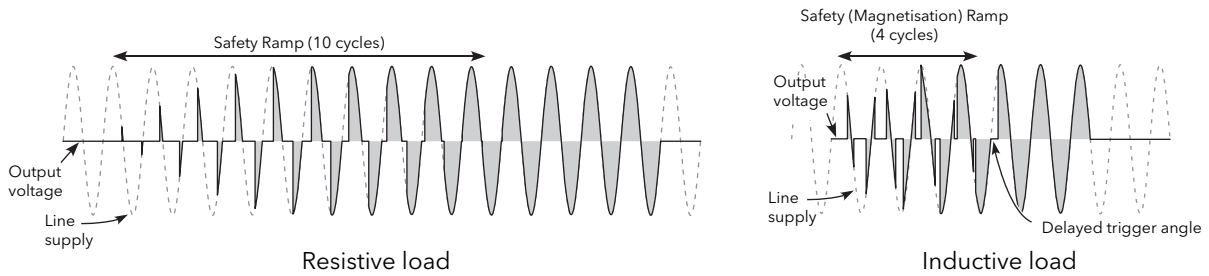

Figure 91 Safety ramp (burst firing) examples

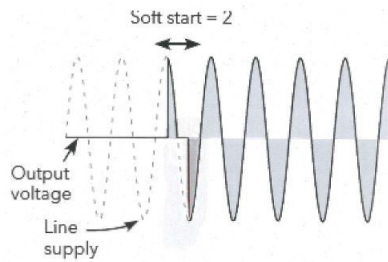

Figure 92 Soft start example

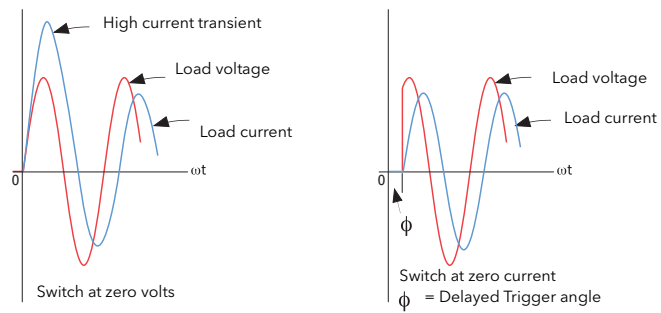

Figure 93 Delayed trigger definition

Note: Waveforms have been idealized for clarity.



WARNING

UNINTENDED EQUIPMENT OPERATION

- At commissioning, ensure correct product configuration.

Failure to follow these instructions can result in death, serious injury or equipment damage.

For transformer Load, select XFMR as Load Type (select Yes for Transfo. in QuickCode). For transformer Load, in burst firing mode, without soft start, adjust Delayed Triggering (DelayedTrigger) to minimize inrush current.

Input/Output (IO) Configuration

This area of configuration allows the user to configure the analog and digital inputs and to view the status of the Relay output. The configuration is separated into the following areas:

- "Analog Input configuration" on page 158.
- "Digital Input configuration" on page 161.
- "Relay status" on page 162.

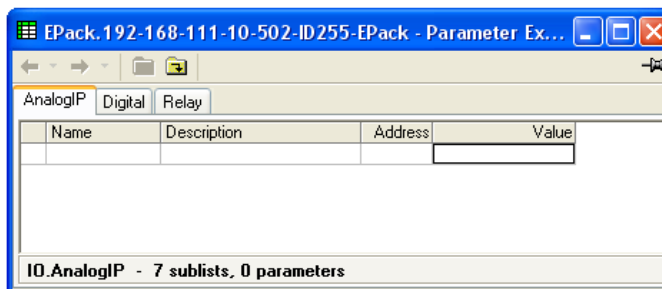

Figure 94 Top level IO menu

Analog Input configuration

The configuration for the analog input is divided into a number of areas:

- Ai Main,
- AlmDis,
- AlmDet,
- AlmSig,
- AlmLat,
- AlmAck,
- AlmStop
- AlmRelay

Ai Main

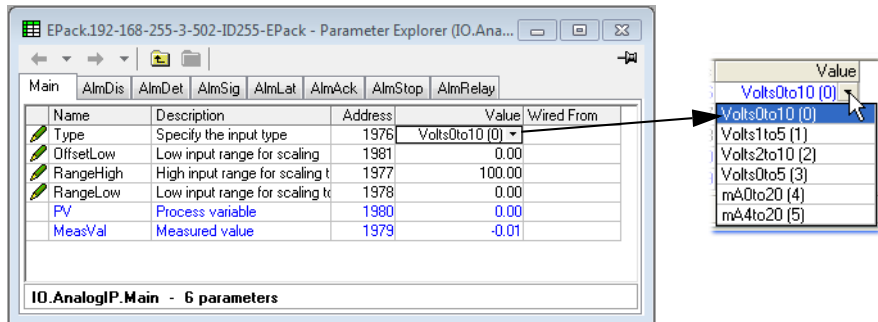

Figure 95 iTools analog input page

Parameters

- Type** Allows the type of input to be set as one of: 0 to 10V, 1 to 5V, 2 to 10V, 0 to 5V, 0 to 20mA, 4 to 20mA. For pinout details, see [Figure 10](#).
- OffsetLow** An offset, which is used to adjust measured value. The parameter value can be set from -1 to 1 in electrical units (depending on input type) and is added to MeasVal. This can be used to compensate for any accuracy issues or electrical noise on the analog input.
- RangeHigh** High range of input for scaling from measurement units to process units. PV is clipped to range high if input goes over range.
- RangeLow** Low range of input for scaling from measurement units to process units. PV is clipped to range low if input goes under range.
- PV** The scaled value in process units. Clipped to the Range High or Range Low value if the signal goes over range or under range respectively.
- MeasVal** The value at the instrument terminals, including the OffsetLow parameter value in electrical units.

AlmDis

Allows the user to enable or disable alarms individually.

Example

Figure 96 shows an iTools page for AlmDis. Pages for the other Alm parameters are similar.

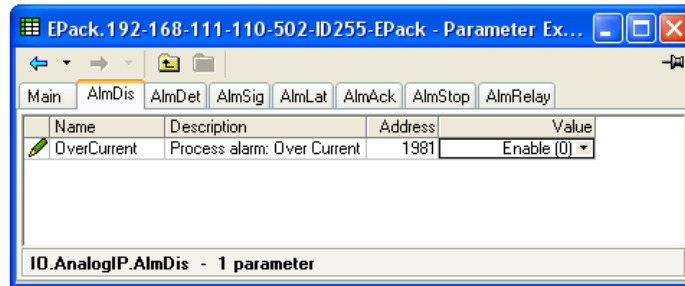

Figure 96 AlmDis example

AlmDet

Indicates whether each individual alarm has been detected and is currently active. This alarm becomes active if the input current goes higher than 25mA, in this case the Analog Input type is automatically switched to 0-10V to avoid damage.

AlmSig

Signals that an alarm has occurred, and whether or not it is a latched. If the user wishes to assign an alarm to for example a relay then the appropriate signaling parameter should be wired.

AlmLat

Allows each individual alarm to be configured as latching, the latched state is shown in the alarm signaling parameter.

AlmAck

Allows each individual alarm to be acknowledged. On an alarm being acknowledged the related signaling parameter (Almsig) is cleared. If the alarm is still active as shown by the detection parameter (Almdet) the alarm may not be acknowledged. The acknowledge parameters automatically clear after being written.

AlmStop

Allows each individual alarm type to be configured to stop the power channel firing. ALMSTOP is activated by the signaling parameter (Almsig) and may be latching or not according to the AlmLat setting for the alarm.

AlmRelay

Causes the relay to be controlled by this alarm

Note: When utilizing Almrelay function ensure FaultDet/CustomAlarm parameter remains wired to IO.Relay/PV.

Digital Input configuration

This allows the user to configure each of the digital inputs.

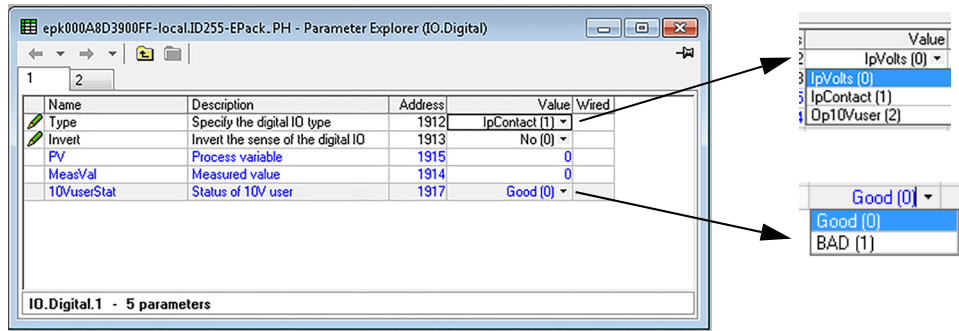

Figure 97 iTools Digital Input configuration page, (digital input 2 displayed)

Parameters

- Type** Select to configure the Logic Input type:
 0 = IpVolts.
 1 = IpContact.
 2 = Op10Vuser.
 For pinout details, see [Figure 10](#).
- Invert** Sets the inversion status to 'No' or 'Yes'.
 When set to 'No', there is no inversion (e.g. if MeasVal = 0 then PV = 0).
 When set to 'Yes', an inversion takes place (e.g. if MeasVal = 0 then PV = 1)
- PV** The current state of the input, after any inversion has been applied.
- MeasVal** For inputs, this shows the value measured at the instrument terminals, in electrical units.
- 10VuserStat** Displays the 10V user output status;
 Good (0) = No issue can deliver 10V
 Bad (1) = No 10V output, possible short circuit or excessive current requirement.
 Example: The 10V user output would typically be used to connect a potentiometer located on a cabinet's front fascia, which would be used to adjust setpoint values via analog input.

Note: The 10V user output is available using digital input 2.

Relay status

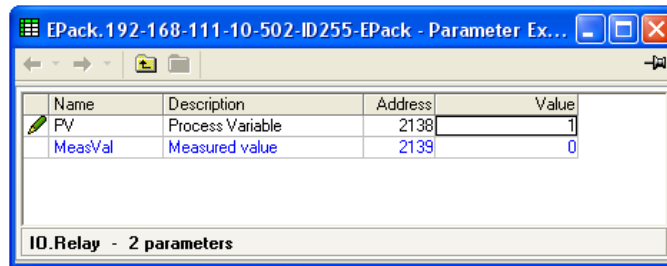

The screenshot shows a window titled "EPack.192-168-111-10-502-ID255-EPack - Parameter Ex...". It contains a table with the following data:

Name	Description	Address	Value
PV	Process Variable	2138	1
MeasVal	Measured value	2139	0

Below the table, it says "IO.Relay - 2 parameters".

Figure 98 iTools relay status page

Parameters

PV	This shows the status of the input to the relay as either 'On' (True) or 'Off' (False).
Meas Val	Shows the current state of the relay coil. 1 = energized; 0 = de-energized, where 'energized' is 'off' and 'de-energized' is 'on'. For pinout details, see Figure 10 . For specification, see Relay Specification (page 253) .

Instrument Configuration Menu

Instrument configuration is divided into the following sections:

- "Instrument Display configuration" on page 163
- "Instrument Hardware configuration" on page 164
- "Instrument options" on page 165
- "Scaling Factor" on page 166

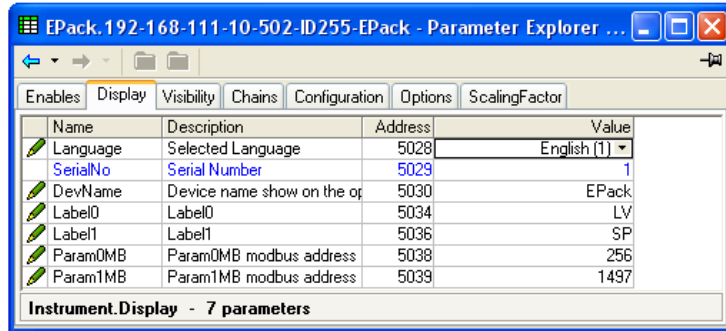

Figure 99 Top level instrument configuration page

Instrument Display configuration

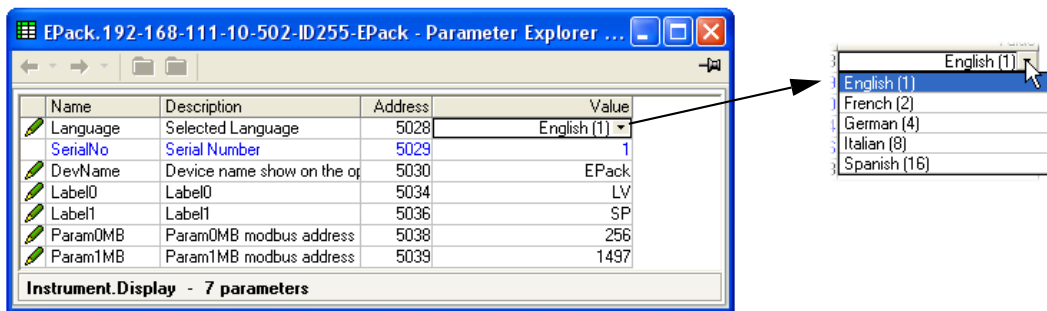

Figure 100 Instrument display configuration page

Parameters

- Language: Select required language for subsequent displays.
- Serial No: Read only. Displays the factory-set Serial number of the unit.
- Dev Name: The device name as it appears at the user display.
- Label 0(1): The text that appears on the home page for the two parameters defined by the addresses listed in Param0 and Param1. User-definable 3 characters (maximum).
- Param0(1)MB: This is the Modbus address of the first (second) parameter to be displayed in the home screen of the instrument.

Instrument Hardware configuration

The current hardware configuration.

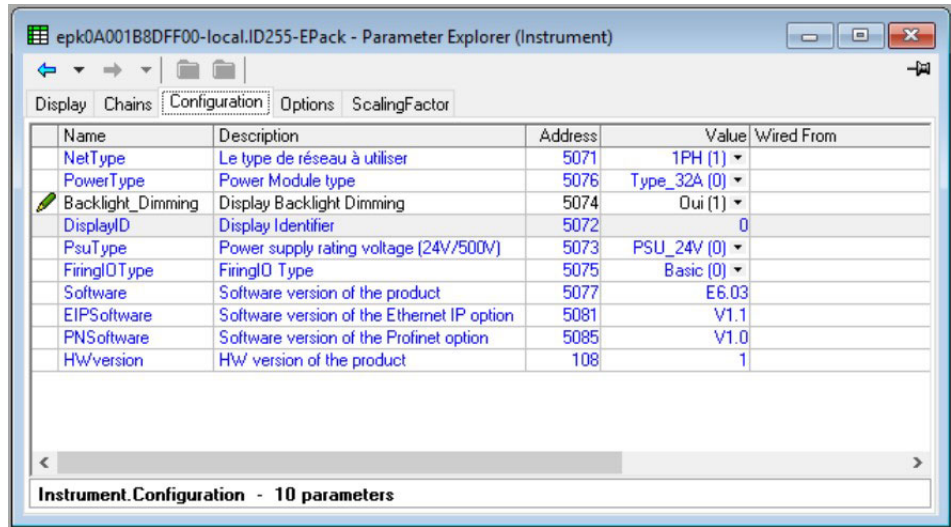

Figure 101 Instrument configuration

Parameters

- Net Type** Network type. This is set at the factory and cannot be changed by the user.
0 = 3 phase
1 = Single phase
2 = 2 phase
- Power Type** This is set at the factory and cannot be changed by the user,
(0 = 32A, 1 = 63A, 2 = 100A, 3 = 125A)
- Timer Res** Resolution of time parameters
0 = 10ths of seconds (100ms); 1 = 10ths of minutes (6 seconds)
- Backlight_Dimming** Option to control the display's backlight by switching dimming on to reduce power consumption:
0 = No (deactivate dimming)
1 = Yes (activates dimming)
- PsuType** Power Supply rating Voltage
0 = 24V
1 = 500V
- DisplayID** Displays details of the manufacturer display (screen) type:
0 = Tianma
1 = Densitron
2 = Jinghua
- Software** Software version of the product.
- EIPSoftware** Software version of the Ethernet/IP option.
- PNSoftware** Software version of the Profinet option.
- HWversion** Displays product hardware version set at factory (read-only parameter).

Instrument options

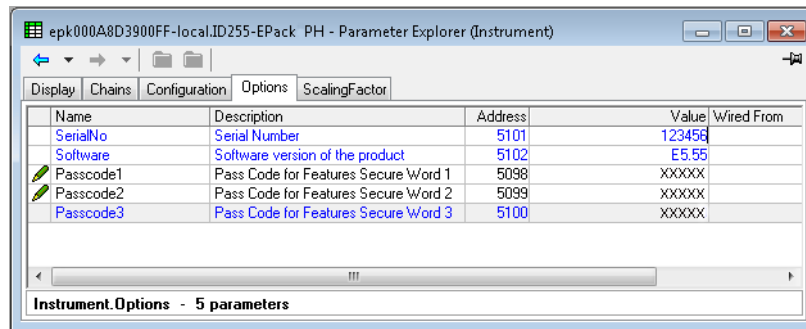

Figure 102 Instrument configuration page

Parameters

SerialNo	The instrument serial number.
Software	The version of software running on this instrument
Passcode1 (2)(3)	Pass Code for 'Features Secure Word' 1(2)(3).

Scaling Factor

Allows scaling factors to be entered for a number of parameters. In iTools, the scaling factors are arranged in 'tabs' of which, for the sake of clarity, this document depicts only one (SetProv).

These scaling factors are applied in Modbus transactions when access to relevant parameters is made using low range address (i.e. not the IEEE region), and also by default on parameters defined in I/O gateway for cyclic exchange in Profinet and EthernetIP. See Fieldbus Gateway section for configuration.

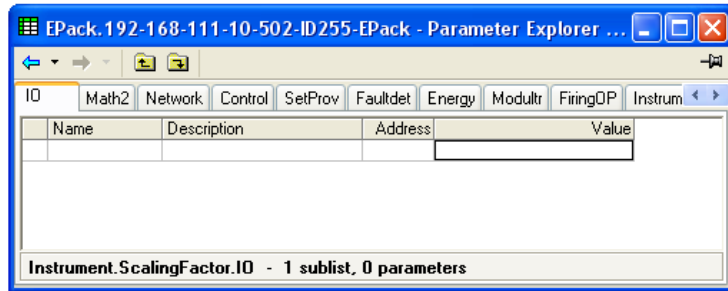
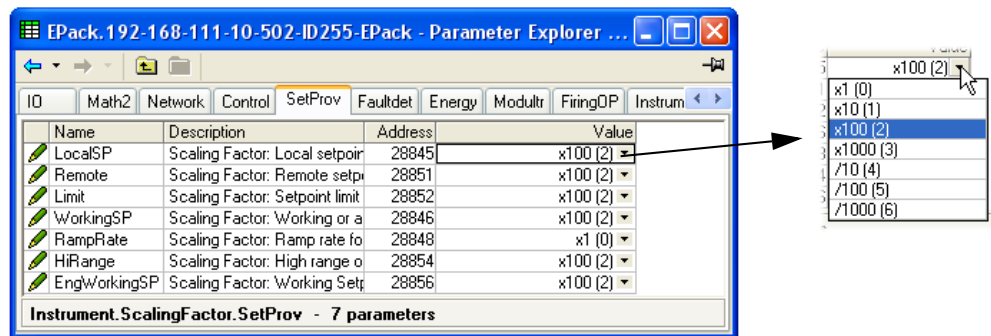

Figure 103 Scaling factor top level menu.

SetProv Example



In the above example it can be seen that all the Set point provider parameters are scaled x100, except for Ramp Rate which is not scaled (i.e. the scaling factor = 1). As can also be seen, the scaling factors available are x1, x10, x100, x1000, ÷10, ÷100, ÷1000.

If the LocalSP, for example, has a scaling factor of x100, as above, then a value of say 5000 means in fact that the real value is 50.00.

Notes:

1. The above example shows the default scaling formats set - they are User configurable.
2. Values are rounded up/down.

IP Monitor Configuration

This monitors a wired parameter and records its maximum value, minimum value and the cumulative time that its value spends above a configurable threshold. An alarm can be set up to become active when the time-over-threshold exceeds a further threshold.

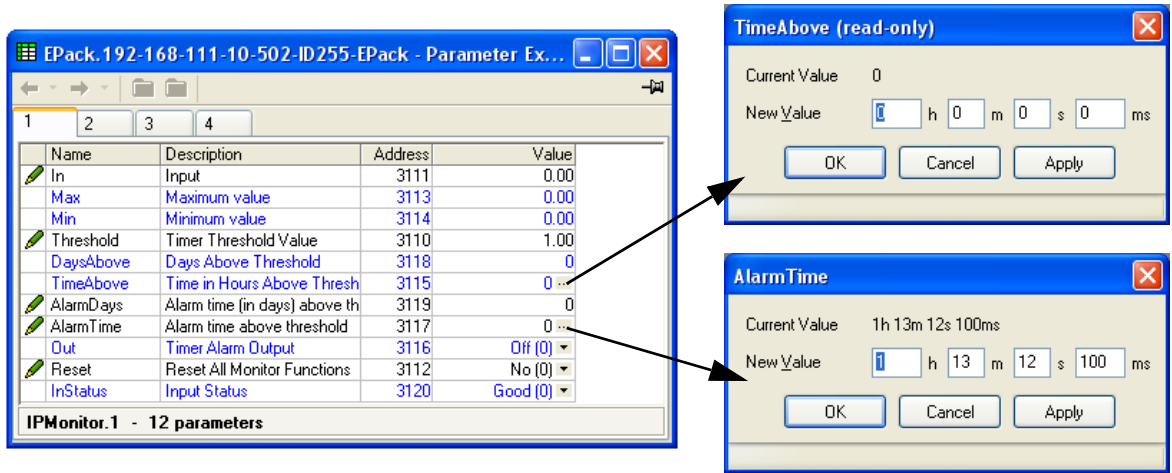

Figure 104 iTools input monitor page (IPMon1)

Parameters

- In** The parameter to be monitored. Normally wired (using iTools) to a parameter, but a numeric entry can be made for testing purposes.
- Max** The maximum value reached by the parameter since last reset.
- Min** The minimum value reached by the parameter since last reset.
- Threshold** This value acts as a trigger for the 'Time Above' measurement.
- Days above** Shows how many complete days the parameter value has spent above the Threshold value (continuously or intermittently) since last reset. The 'Time Above' value should be added to 'Days Above' in order to find the total time.
- Time Above** Shows how many hours, minutes and tenths of minutes that the parameter value has spent above the threshold value (continuously or intermittently) since last reset, or since the last complete day. (once the value exceeds 23:59.9, the 'Days Above' value is incremented and 'Time Above' is reset to 00:00.0.) The 'Time Above' value should be added to 'Days Above' in order to find the total time.
- Alarm Days** Together with 'Alarm Time' this defines a 'total time above threshold' value, which, when exceeded, sets the Alarm out parameter 'On'.
- Alarm Time** See 'Alarm Days' above.
- Reset** Resetting causes the Max. and Min. values to be set to the current value, sets the 'Days Above' value to zero, and the 'Time Above' value to 00:00.0.
- Status** Shows the status of the input parameter as either 'Good' or 'Bad'.

Lgc2 (Two Input Logic Operator) Menu

This logic operator block provides a number of two-input logic operations. The output is always a 'Boolean' (logic 0 or 1) no matter whether the inputs are analog or digital. For analog inputs, any value below 0.5 is deemed to be logic 0 (off). A value equal to or greater than 0.5 is treated as a logic 1 (on).

Either input can be 'inverted' as a part of the configuration (that is, a high input is treated as a low input and *vice-versa*.)

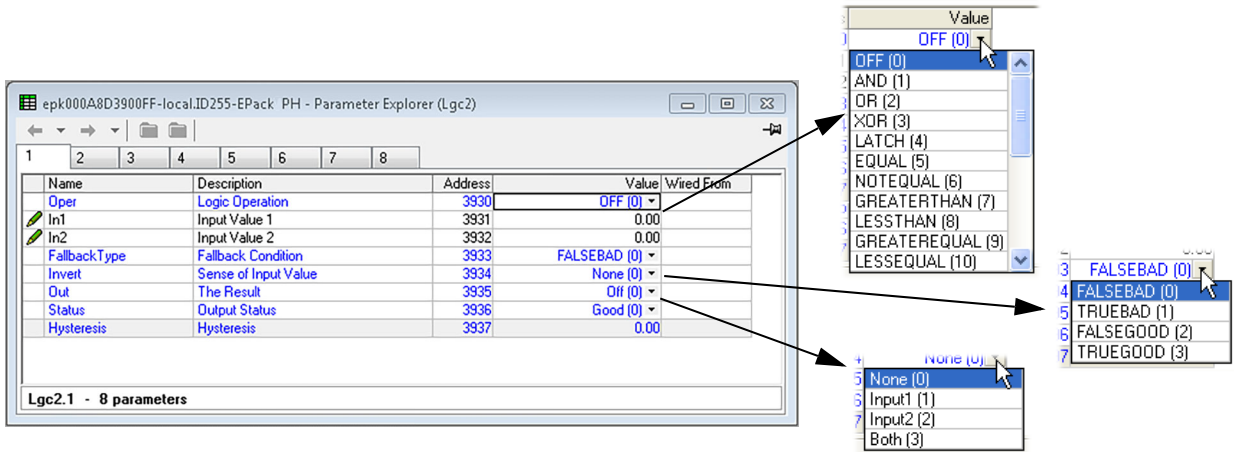

Figure 105 Lgc2 page (Lgc2 1)

Lgc2 Parameters

Oper	Allows the user to select a logic operation for the block. The descriptions below assume neither input is inverted. High = 1 or on; Low = 0 or off.
Off	No logic operation selected.
AND	Out is high if both inputs high, otherwise Out is low.
OR	Out is high if either or both inputs high, otherwise Out is low.
XOR	Output high if either (but not both) inputs high. Low if neither or both inputs are high.
Latch	If In2 low, Out latches next transition of In1. Value remains latched until In2 goes low, when Out = In1 (see figure 106).
Equal	Out high if both inputs are equal, otherwise output is low.
Not Equal	Out is high if inputs are unequal. Out is low if inputs are equal.
Greater than	Out is high if In1 value greater than In2 value, otherwise Out is low.
Less than	Out is high if In1 value less than In2 value, otherwise Out is low.
GreaterEqual	Out is high if In1 value is equal to or greater than In2 value, otherwise Out is low.
LessEqual	Out is high if In1 value is less than or equal to In2 value, otherwise Out is low.
In1	If wired, shows the value of In1; if not, allows the user to enter a value.
In2	If wired, shows the value of In2; if not, allows the user to enter a value.

Fallback type	Allows a fallback type to be selected. This defines the output value and status displays if the status of one or both inputs is 'bad'. FalseBadOutput value displays 'False' ; Status displays 'Bad' TrueBadOutput value displays 'True' ; Status displays 'Bad' FalseGoodOutput value displays 'False' ; Status displays 'Good' TrueGoodOutput value displays 'True' ; Status displays 'Good'.
Invert	Allows none, either or both inputs to be inverted.
Out	Shows the current output value
Status	Shows the status of the output ('Good' or 'Bad').
Hysteresis	For comparison operators only (e.g. Greater than) this allows a hysteresis value to be entered. For example, if the operator is 'Greater than' and hysteresis is H, then the output goes high when In1 exceeds In2, and remains high until In1 falls to a value less than (In2 - H). Not applicable to the 'Equal' function.

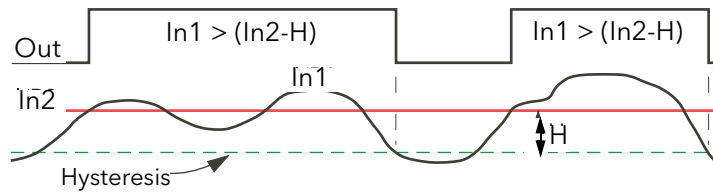
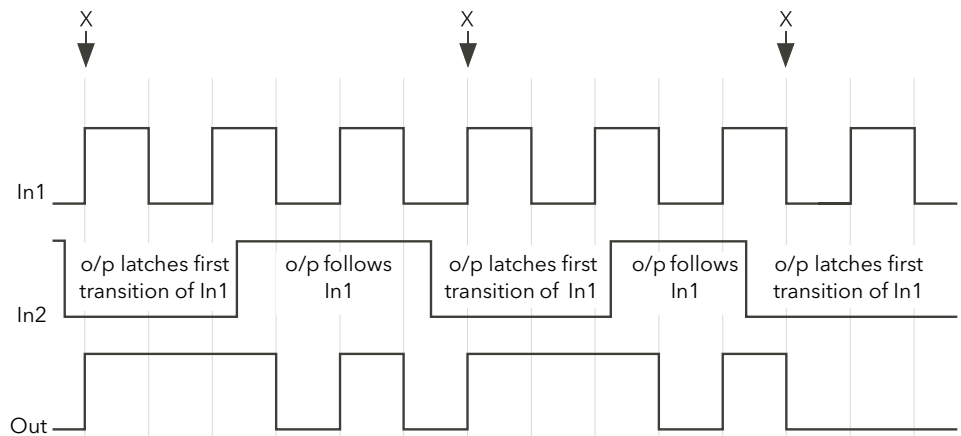

Figure 106 Hysteresis



When In2 goes low, Out follows the next positive or negative transition of In1 (points 'X') and latches at this value until In2 goes high. When In2 is high, Out follows In1.

Figure 107 Latch operation

Lgc8 (Eight-input Logic Operator) Configuration

This allows between two and eight inputs to be combined using an AND, OR or Exclusive OR (EXOR) logic function. The inputs may be individually inverted, and the output can also be inverted, thus allowing the full range of logic functions to be implemented.

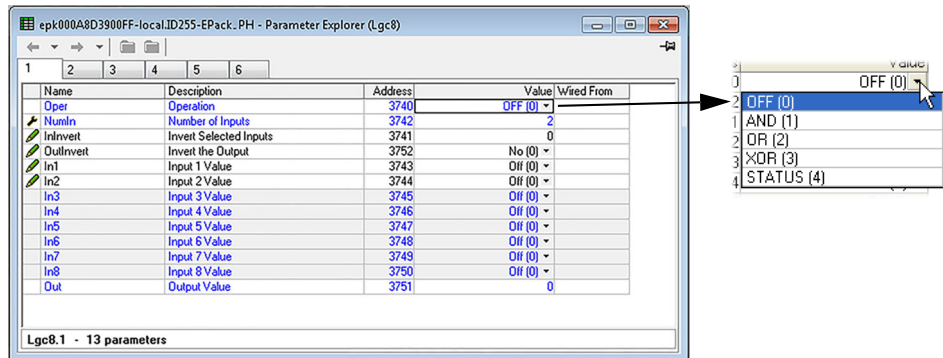

Figure 108 Lgc8 configuration page

Parameters

- Oper** Allows selection of AND, OR or Exclusive OR functions (or OFF).

 - AND = output is high only if all inputs are high
 - OR = output is high if any or all inputs are high
 - XOR = output is high if an odd number of inputs are high, and low if an even number of inputs are high. Logically, a cascaded XOR function: $(((((In1 \oplus In2) \oplus In3) \oplus In4) \dots \oplus In8))$
- NumIn** Status = Bit to bit OR of the inputs concatenated into a word.
Set the number of inputs to between two and eight inclusive. This number defines how many invert keys appear in 'Invert', and how many Input value pages appear.
- InInvert** Allows the user to invert individual inputs prior to operation. This is a status word with one bit per input, the left-hand bit inverts input 1. When configuring over comms, the invert parameter is interpreted as a bitfield where:

 - 0x1 - input 1
 - 0x2 - input 2
 - 0x3 - input 3
 - 0x4 - input 4
 - 0x5 - input 5
 - 0x6 - input 6
 - 0x7 - input 7
 - 0x8 - input 8
- Out Invert** No = normal output; 'Yes' means that the output is inverted, allowing NAND and NOR functions to be implemented.
- In1** The state (on or off) of the first input
- In2 onwards** The state of the remaining inputs
- Out** The Output value of the function (i.e. On or Off)

LGC8 schematic

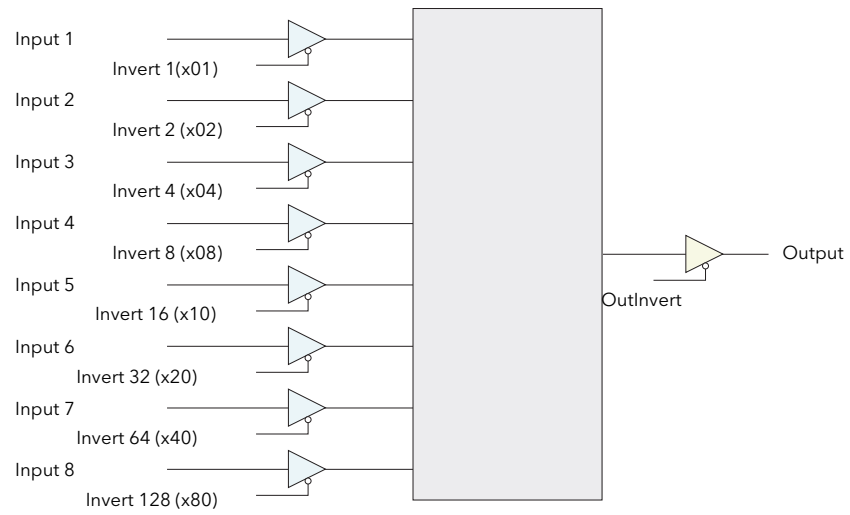

Figure 109 LGC8 Schematic

Invert input decoding table

The inversion status can be encoded/decoded using the following table.

Input			Hex	Dec	Input			Hex	Dec	Input			Hex	Dec	Input			Hex	Dec																					
8	7	6	5	4	3	2	1	Hex	Dec	8	7	6	5	4	3	2	1	Hex	Dec	8	7	6	5	4	3	2	1	Hex	Dec	8	7	6	5	4	3	2	1	Hex	Dec	
N	N	N	N	N	N	N	N	00	0	N	7	N	N	N	N	N	N	40	64	8	N	N	N	N	N	N	N	80	128	8	7	N	N	N	N	N	N	C0	192	
N	N	N	N	N	N	N	1	01	1	N	7	N	N	N	N	N	1	41	65	8	N	N	N	N	N	N	1	81	129	8	7	N	N	N	N	N	1	C1	193	
N	N	N	N	N	N	N	2	02	2	N	7	N	N	N	N	2	42	66	8	N	N	N	N	N	N	2	82	130	8	7	N	N	N	N	N	2	C2	194		
N	N	N	N	N	N	N	2	03	3	N	7	N	N	N	N	2	43	67	8	N	N	N	N	N	N	2	83	131	8	7	N	N	N	N	N	2	C3	195		
N	N	N	N	N	N	3	N	04	4	N	7	N	N	N	3	N	44	68	8	N	N	N	N	3	N	N	84	132	8	7	N	N	N	N	3	N	C4	196		
N	N	N	N	N	N	3	N	05	5	N	7	N	N	N	3	N	45	69	8	N	N	N	N	3	N	1	85	133	8	7	N	N	N	N	3	N	C5	197		
N	N	N	N	N	N	3	2	06	6	N	7	N	N	N	3	2	46	70	8	N	N	N	N	3	2	N	86	134	8	7	N	N	N	N	3	2	N	C6	198	
N	N	N	N	N	N	3	2	07	7	N	7	N	N	N	3	2	47	71	8	N	N	N	N	3	2	1	87	135	8	7	N	N	N	N	3	2	1	C7	199	
N	N	N	N	N	N	4	N	08	8	N	7	N	N	4	N	N	48	72	8	N	N	N	4	N	N	N	88	136	8	7	N	N	4	N	N	N	N	C8	200	
N	N	N	N	N	N	4	N	09	9	N	7	N	N	4	N	N	49	73	8	N	N	N	4	N	N	1	89	137	8	7	N	N	4	N	N	1	N	C9	201	
N	N	N	N	N	N	4	2	0A	10	N	7	N	N	4	2	N	4A	74	8	N	N	N	4	2	N	N	8A	138	8	7	N	N	4	2	N	N	N	CA	202	
N	N	N	N	N	N	4	2	0B	11	N	7	N	N	4	2	1	4B	75	8	N	N	N	4	2	1	N	8B	139	8	7	N	N	4	2	1	N	CB	203		
N	N	N	N	N	N	4	3	0C	12	N	7	N	N	4	3	N	4C	76	8	N	N	N	4	3	N	N	8C	140	8	7	N	N	4	3	N	N	N	CC	204	
N	N	N	N	N	N	4	3	0D	13	N	7	N	N	4	3	1	4D	77	8	N	N	N	4	3	1	N	8D	141	8	7	N	N	4	3	1	N	CD	205		
N	N	N	N	N	N	4	3	0E	14	N	7	N	N	4	3	2	4E	78	8	N	N	N	4	3	2	N	8E	142	8	7	N	N	4	3	2	N	CE	206		
N	N	N	N	N	N	4	3	0F	15	N	7	N	N	4	3	2	4F	79	8	N	N	N	4	3	2	1	8F	143	8	7	N	N	4	3	2	1	N	CF	207	
N	N	N	N	N	N	5	N	10	16	N	7	N	5	N	N	N	50	80	8	N	N	5	N	N	N	N	90	144	8	7	N	5	N	N	N	N	N	D0	208	
N	N	N	N	N	N	5	N	11	17	N	7	N	5	N	N	N	51	81	8	N	N	5	N	N	N	1	91	145	8	7	N	5	N	N	N	1	N	D1	209	
N	N	N	N	N	N	5	N	12	18	N	7	N	5	N	N	2	52	82	8	N	N	5	N	N	2	N	92	146	8	7	N	5	N	N	2	N	N	D2	210	
N	N	N	N	N	N	5	N	13	19	N	7	N	5	N	N	2	53	83	8	N	N	5	N	N	2	1	93	147	8	7	N	5	N	N	2	1	N	D3	211	
N	N	N	N	N	N	5	N	14	20	N	7	N	5	N	3	N	54	84	8	N	N	5	N	3	N	N	94	148	8	7	N	5	N	3	N	N	N	D4	212	
N	N	N	N	N	N	5	N	15	21	N	7	N	5	N	3	1	55	85	8	N	N	5	N	3	1	N	95	149	8	7	N	5	N	3	1	N	N	D5	213	
N	N	N	N	N	N	5	N	16	22	N	7	N	5	N	3	2	56	86	8	N	N	5	N	3	2	N	96	150	8	7	N	5	N	3	2	N	N	D6	214	
N	N	N	N	N	N	5	N	17	23	N	7	N	5	N	3	2	57	87	8	N	N	5	N	3	2	1	97	151	8	7	N	5	N	3	2	1	N	D7	215	
N	N	N	N	N	N	5	N	18	24	N	7	N	5	4	N	N	58	88	8	N	N	5	4	N	N	N	98	152	8	7	N	5	4	N	N	N	N	D8	216	
N	N	N	N	N	N	5	N	19	25	N	7	N	5	4	N	1	59	89	8	N	N	5	4	N	1	N	99	153	8	7	N	5	4	N	1	N	N	D9	217	
N	N	N	N	N	N	5	N	1A	26	N	7	N	5	4	2	N	5A	90	8	N	N	5	4	2	N	N	9A	154	8	7	N	5	4	2	N	N	N	DA	218	
N	N	N	N	N	N	5	N	1B	27	N	7	N	5	4	2	1	5B	91	8	N	N	5	4	2	1	N	9B	155	8	7	N	5	4	2	1	N	N	DB	219	
N	N	N	N	N	N	5	4	1C	28	N	7	N	5	4	3	N	5C	92	8	N	N	5	4	3	N	N	9C	156	8	7	N	5	4	3	N	N	N	DC	220	
N	N	N	N	N	N	5	4	1D	29	N	7	N	5	4	3	1	5D	93	8	N	N	5	4	3	1	N	9D	157	8	7	N	5	4	3	1	N	N	DD	221	
N	N	N	N	N	N	5	4	1E	30	N	7	N	5	4	3	2	5E	94	8	N	N	5	4	3	2	N	9E	158	8	7	N	5	4	3	2	N	N	DE	222	
N	N	N	N	N	N	5	4	1F	31	N	7	N	5	4	3	2	5F	95	8	N	N	5	4	3	2	1	9F	159	8	7	N	5	4	3	2	1	N	DF	223	
N	N	N	N	N	N	6	N	20	32	N	7	6	N	N	N	N	60	96	8	N	6	N	N	N	N	N	A0	160	8	7	6	N	N	N	N	N	N	N	E0	224
N	N	N	N	N	N	6	N	21	33	N	7	6	N	N	N	1	61	97	8	N	6	N	N	N	1	N	A1	161	8	7	6	N	N	N	N	1	N	N	E1	225
N	N	N	N	N	N	6	N	22	34	N	7	6	N	N	N	2	62	98	8	N	6	N	N	2	N	N	A2	162	8	7	6	N	N	N	2	N	N	N	E2	226
N	N	N	N	N	N	6	N	23	35	N	7	6	N	N	2	1	63	99	8	N	6	N	N	2	1	N	A3	163	8	7	6	N	N	N	2	1	N	N	E3	227
N	N	N	N	N	N	6	N	24	36	N	7	6	N	N	3	N	64	100	8	N	6	N	N	3	N	N	A4	164	8	7	6	N	N	N	3	N	N	N	E4	228
N	N	N	N	N	N	6	N	25	37	N	7	6	N	N	3	1	65	101	8	N	6	N	N	3	1	N	A5	165	8	7	6	N	N	N	3	1	N	N	E5	229
N	N	N	N	N	N	6	N	26	38	N	7	6	N	N	3	2	66	102	8	N	6	N	N	3	2	N	A6	166	8	7	6	N	N	N	3	2	N	N	E6	230
N	N	N	N	N	N	6	N	27	39	N	7	6	N	N	3	2	67	103	8	N	6	N	N	3	2	1	A7	167	8	7	6	N	N	N	3	2	1	N	E7	231
N	N	N	N	N	N	6	N	28	40	N	7	6	N	4	N	N	68	104	8	N	6	N	4	N	N	N	A8	168	8	7	6	N	4	N	N	N	N	N	E8	232
N	N	N	N	N	N	6	N	29	41	N	7	6	N	4	N	1	69	105	8	N	6	N	4	N	1	N	A9	169	8	7	6	N	4	N	1	N	N	N	E9	233
N	N	N	N	N	N	6	N	2A	42	N	7	6	N	4	2	N	6A	106	8	N	6	N	4	2	N	N	AA	170	8	7	6	N	4	2	N	N	N	N	EA	234
N	N	N	N	N	N	6	N	2B	43	N	7	6	N	4	2	1	6B	107	8	N	6	N	4	2	1	N	AB	171	8	7	6	N	4	2	1	N	N	N	EB	235
N	N	N	N	N	N	6	N	2C	44	N	7	6	N	4	3	N	6C	108	8	N	6	N	4	3	N	N	AC	172	8	7	6	N	4	3	N	N	N	N	EC	236
N	N	N	N	N	N	6	N	2D	45	N	7	6	N	4	3	1	6D	109	8	N	6	N	4	3	1	N	AD	173	8	7	6	N	4	3	1	N	N	N	ED	237
N	N	N	N	N	N	6	N	2E	46	N	7	6	N	4	3	2	6E	110	8	N	6	N	4	3	2	N	AE	174	8	7	6	N	4	3	2	N	N	N	EE	238
N	N	N	N	N	N	6	N	2F	47	N	7	6	N	4	3	2	6F	111	8	N	6	N	4	3	2	1	AF	175	8	7	6	N	4	3	2	1	N	N	EF	239
N	N	N	N	N	N	6	5	30	48	N	7	6	5	N	N	N	70	112	8	N	6	5	N	N	N	N	B0	176	8	7	6	5	N	N	N	N	N	N	F0	240
N	N	N	N	N	N	6	5	31	49	N	7	6	5	N	N	1	71	113	8	N	6	5	N	N	1	N	B1	177	8	7	6	5	N	N	1	N	N	N	F1	241
N	N	N																																						

LIN16 Input Linearization

The Lin16 function block converts an input signal into an output PV using a series of up to 15 straight lines to characterize the conversion.

The function block provides the following behaviour.

1. The Input values must be monotonic and constantly rising.
2. To convert the MV to the PV, the algorithm will search the table of inputs until the matching segment is found. Once found, the points either side will be used to interpolate the output value.
3. If during the search, a point is found which is not above the previous (below for inverted) then the search will be terminated and the segment taken from the last good point to the extreme (In Hi-Out Hi) see following diagram.

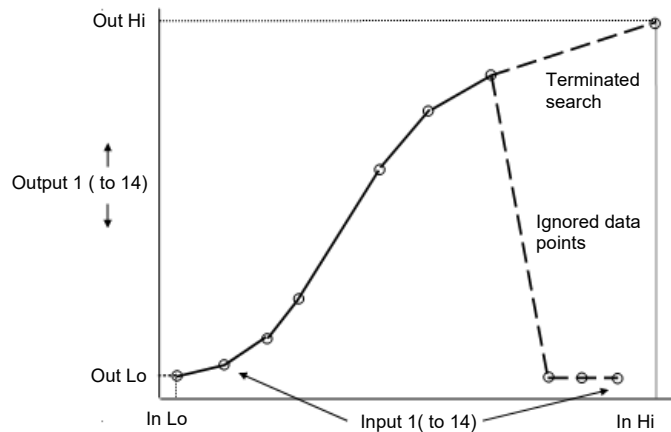

Figure 110 Linearization Example

1. If the input value is outside the translated range then the output status will indicate Bad, and the value will be limited to the nearest output limit.
2. The units and resolution parameters will be used for the output values. The input values resolution and units will be specified by the source of the wire.
3. If the 'Out Low' is higher than the 'Out High' then the translation will be inverted

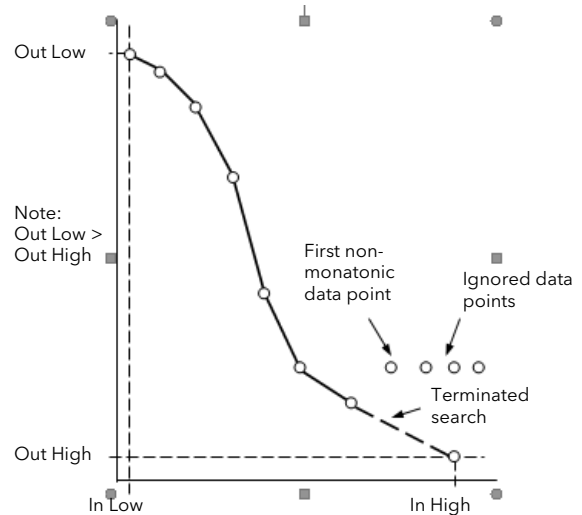

Figure 111 How an Inverted Curve will Terminate its search when it detects non-monotonic data

Notes:

1. The linearization block works on rising inputs/rising outputs or rising inputs/falling outputs. It is not suitable for outputs which rise and fall on the same curve.
2. Input Lo/Output Lo and Input Hi/Output Hi are entered first to define the low and high points of the curve. It is not necessary to define all 15 intermediate points if the accuracy is not required. Points not defined will be ignored and a straight line fit will apply between the last point defined and the Input Hi/Output Hi point. If the input source has a bad status (sensor break, or over-range) then the output value will also have a bad status.

Input Linearization Parameters

Name	Description	Address	Value	Wired From
Units	Units of the Linearised Output	4251	None (0)	
Resolution	Resolution of the Linearised Output	4252	X (0)	
In	Input Measurement to Linearise	4253	0.00	
FallbackType	Fallback Type	4287	ClipBad (0)	
FallbackValue	Fallback Value	4288	0.00	
Out	Linearisation Result	4254	0.00	
InLowLimit	Input Low Limit	4255	0.00	
OutLowLimit	Output Low Limit	4256	0.00	
InHighLimit	Input High Limit	4285	0.00	
OutHighLimit	Output High Limit	4286	0.00	
In1	Input Point 1	4257	0.00	
Out1	Output Point 1	4258	0.00	
In2	Input Point 2	4259	0.00	
Out2	Output Point 2	4260	0.00	
In3	Input Point 3	4261	0.00	
Out3	Output Point 3	4262	0.00	
In4	Input Point 4	4263	0.00	
Out4	Output Point 4	4264	0.00	
In5	Input Point 5	4265	0.00	
Out5	Output Point 5	4266	0.00	
In6	Input Point 6	4267	0.00	
Out6	Output Point 6	4268	0.00	
In7	Input Point 7	4269	0.00	
Out7	Output Point 7	4270	0.00	
In8	Input Point 8	4271	0.00	
Out8	Output Point 8	4272	0.00	
In9	Input Point 9	4273	0.00	
Out9	Output Point 9	4274	0.00	
In10	Input Point 10	4275	0.00	
Out10	Output Point 10	4276	0.00	
In11	Input Point 11	4277	0.00	
Out11	Output Point 11	4278	0.00	
In12	Input Point 12	4279	0.00	
Out12	Output Point 12	4280	0.00	
In13	Input Point 13	4281	0.00	
Out13	Output Point 13	4282	0.00	
In14	Input Point 14	4283	0.00	
Out14	Output Point 14	4284	0.00	
Status	Status of The Block	4250	Good (0)	

Lin16 - 39 parameters

- Units** Units of the linearized output.
- Resolution** Resolution of the output value
- In** Input measurement to linearise between InLowLimit and InHighLimit. Wire to the source for the custom linearization.
- FallbackType** Fallback Type
The fallback strategy will come into effect if the status of the input value is bad or if the input value is outside the range of input high scale and input low scale.
- Fallback Value** In the event of a bad status, the output may be configured to adopt the fallback value. This allows the strategy to dictate a known output in the event of a fallback type being indicated.
- Out** Result of the linearization
- InLowLimit** Adjust to the low input value
- OutLowLimit** Adjust to correspond to the low input value
- InHighLimit** Adjust to the high input value
- OutHighLimit** Adjust to correspond to the high input value
- In1** Adjust to the first break point
- Out1** Adjust to correspond to input 1
- In14** Adjust to the last break point
- Out14** Adjust to correspond to input 14
- Status** Status of the block. A value of zero indicates a healthy conversion.

The 16 point linearization does not require all 16 points to be used. If fewer points are required, then the curve can be terminated by setting the first unwanted value to be less than the previous point.

Conversely if the curve is a continuously decreasing one, then it may be terminated by setting the first unwanted point above the previous one.

Math2 Menu

This feature allows a range of two-input mathematical functions to be performed. The available functions are listed below.

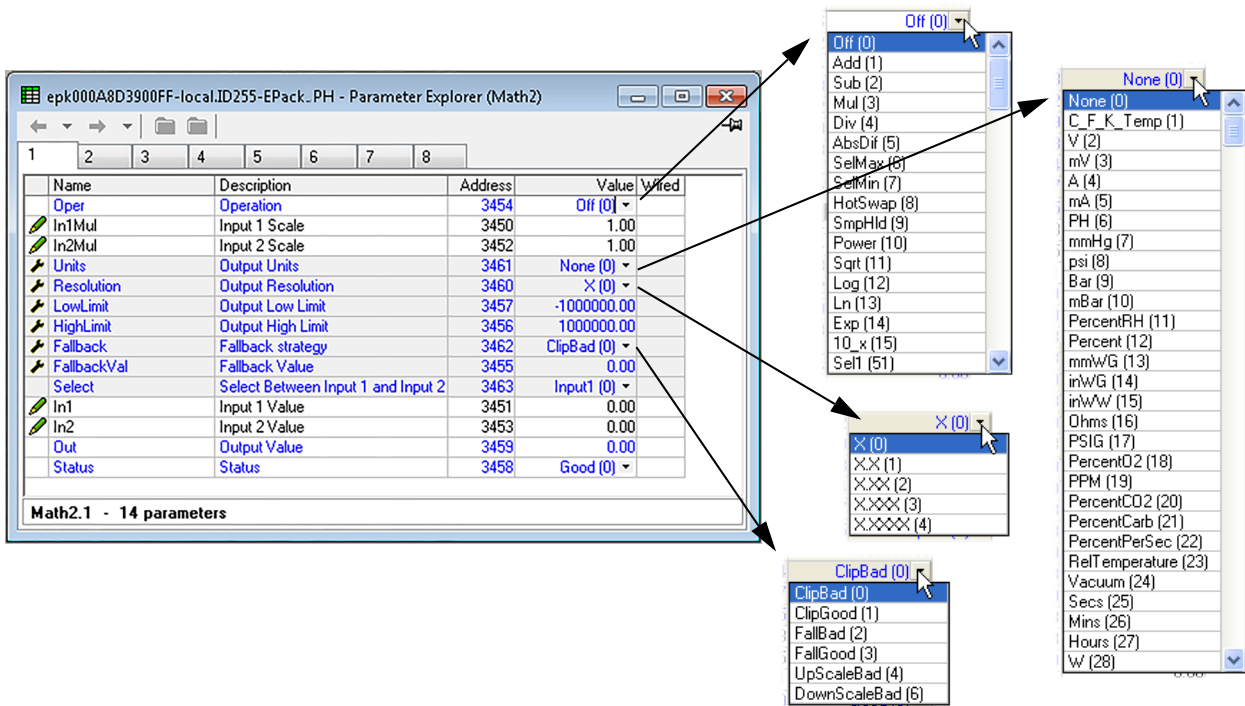

Figure 113 Math2 configuration page

Math2 Parameters

Note: For the sake of this description, ‘High’, ‘1’ and ‘True’ are synonymous, as are ‘Low’, ‘0’ and ‘False’.

Oper	Defines the mathematical function to be applied to the inputs
None	No operation.
Add	Adds input one to input two.
Sub	Subtracts input two from input one.
Mul	Multiplies inputs one and two together.
Div	Divides input one by input two.
AbsDif	The difference in value between inputs one and two, ignoring sign.
SelMax	Output = the higher of inputs one and two.
SelMin	Output = the lower of inputs one and two.
HotSwap	Input one appears as the output for as long as input one is ‘good’. If input one status is bad, input two appears as the output instead.
SmpHld	Sample and Hold. The output follows input one, for as long as input two is high (sample). When input two goes low (hold), the output is held, at the value current when the output went low, until input two goes high again. Input two is normally a digital value (low = 0 or high = 1); when it is an analog value, then any positive non-zero value is interpreted as a high.
Power	Output = Input one raised to the power of input two ($In1^{In2}$). For example if input one has the value 4.2, and the value of input two is 3, then output = $4.2^3 = 74.09$ (approx.).

Sqrt	The output is the square root of input one. Input two is not used.
Log	Log base 10: Output = $\{\text{Log}_{10}(\text{In } 1)\}$. Input two is not used.
Ln	Log base e: Output = $\{\text{Log}_e(\text{In } 1)\}$. Input two is not used.
Exp	Output = $e^{(\text{input one})}$. Input two is not used.
10_x	Output = $10^{(\text{input one})}$. Input two is not used.
Sel1	If the Select input is high, input two appears at the output; if the Select input is low, input one appears at the output.
In1(2) Mul	The scaling factor to be applied to input one (two).
Units	Allows the user to choose units for the output (see figure 113).
Resolution	Use the up and down arrows to position the decimal point as required.
Low Limit	The low limit for all inputs to the function and for the fallback value.
High Limit	The high limit for all inputs to the function and for the fallback value.
Fallback	The fallback strategy comes into play if the status of the input value is 'Bad', or if its value lies outside the range (High limit- Low limit).
Clip Bad	The output is set to the high or low limit as appropriate; output status is set to 'Bad'.
Clip Good	The output is set to the high or low limit as appropriate; output status is set to 'Good'.
Fall Bad	The output is set to the fallback value (below); output status is set to 'Bad'.
Fall Good	The output is set to the fallback value (below); output status is set to 'Good'.
Upscale Bad	The output is set to the high limit and Status is set to 'Bad'.
Downscale Bad	The output is set to the low limit and Status is set to 'Bad'.
Fallback value	Allows the user to enter the value to which the output is set for Fallback = Fall Good, or Fall Bad.
Select	Editable only if Oper = Select. Allows input one or input two to be selected for output.
In1	Input one value
In2	Input two value
Out	The output value resulting from the configured mathematical operation. If either input is 'Bad', or if the result is out of range, the fallback strategy is adopted.
Status	Indicates the status of the operation as 'Good' or 'Bad'. Used to flag conditions and can be used as an interlock for other operations.

Modulator Configuration

This function implements the modulation type firing modes such as fixed and variable period modulation.

Note: For the sake of completeness, all Modulator parameters are shown in the figure below. Normally, for the sake of clarity, non-relevant (shaded) parameters should be hidden using the '>Parameter Availability Settings...>Hide Parameters and Lists when Not Relevant' menu item.

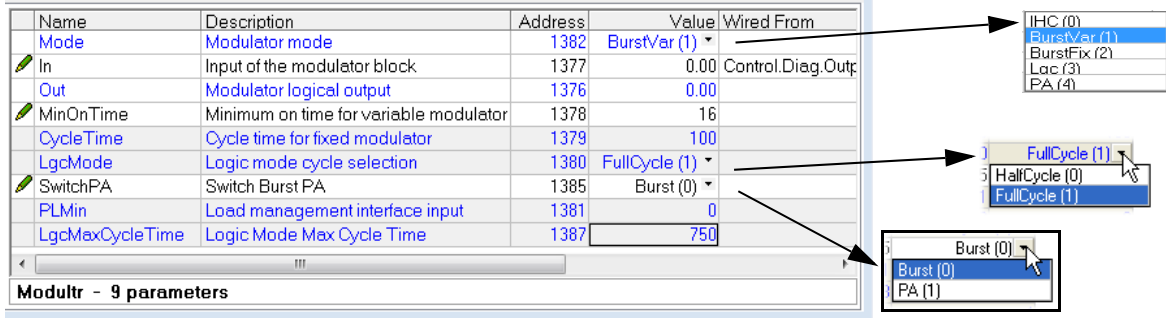

Figure 114 Modulator menu page

Modulator parameters

- Mode** Select the required firing mode from 'Logic', 'PA' (Phase angle) 'Intelligent Half Cycle', 'BurstVar' (Burst firing - minimum on time) or 'BurstFix' (Burst firing - cycle time).
- In** This is the value that the modulator is required to deliver.
- Out** The output logic signal controlling the power module on and off times, normally wired to the input of the firing block. For Mode = Phase angle, this is a phase angle demand.
- Min On Time** For Variable Period Modulation, this sets the minimum on time in supply voltage periods. At 50% demand from the modulator, Ton = Toff = Minimum on time, and Cycle time is 2 x Minimum on time = Modulation period. The minimum off time is equal to 'Min on time'.
- Cycle Time** For Fixed Period Modulation, this is the cycle time in supply voltage periods.
- Logic Mode** For Logic Firing Modulation, Half cycle sets firing stop to the next zero crossing; Full cycle sets firing stop at the zero crossing of the next full cycle.
- Switch PA** Allows the user to impose Phase Angle firing, overriding the configured Burst Mode as displayed in 'Mode', above.
- PLMin** Not applicable to this software release.
- LgcMaxCycleTime** Max cycle time for Logic mode. This is set in mains periods. This is the equivalent to the modulation period and it is used to compute Network electrical quantities when there is no modulation shift.

Network Configuration

This identifies the type of electrical network to be controlled, and this, in turn defines how the network's electrical measurements are presented. The configuration is divided into a number of areas:

- Meas
- Setup
- AlmDis
- AlmDet
- AlmSig
- AlmLat,
- AlmAck,
- AlmStop
- AlmRelay

Network Meas Menu

Name	Description	Address	Value
Frequency	Frequency of the line	267	0.00
Vline	Line voltage measurement	256	0.00
I	Irms of the load	257	0.00
IsqBurst	Average square value of load	258	0.00
Isq	Square value of the load cur	259	0.00
V	Vrms of the load	260	0.00
VsqBurst	Average square value of the	268	0.00
Vsq	Square value of load voltage	261	0.00
PBurst	True Power measurement in	262	0.00
P	True power measurement.	263	0.00
S	Apparent power measuremer	264	0.00
PF	Power Factor	265	0.00
Z	Load impedance	266	0.00
HSinkTemp	Heatsink 1 temperature	269	0.00

Network.Meas - 14 parameters

Figure 115 Network, Meas configuration panel

Parameters

This submenu presents power network measurements, according to the network type. All available measurements are listed below, but which values actually appear depends on the network configuration.

- Frequency** Displays the calculated frequency of the supply voltage of the power channel associated with this network.
- Vline** Displays supply line voltage.
- I** Displays load RMS current.
- IsqBurst** The time base measurement is the main period in Phase Angle, and the modulation period in Burst Mode.
Is the average square value of the load current (Isq) in burst firing. The average is taken over the duration of the burst period. This is typically used for monitoring and alarming over the burst period.
- Isq** Square value of load current over the mains period in Burst and Phase Angle modes.
- V** Displays load voltage (V_{RMS}).
The time base measurement is the main period in phase angle, and the modulation period in burst mode.
- VsqBurst** Average square value of load voltage in burst firing taken over the duration of the burst period. Typically used for monitoring and alarm strategies over the burst period.
- Vsq** Square value of load voltage over the mains period in Burst and Phase Angle modes. Typically used for V^2 control.
- P Burst** Measurement of true power on the network. This is calculated over the modulation period in Burst Firing mode. Typically used for monitoring and alarm strategy.
- P** True power measurement over the mains period in Burst and Phase Angle modes. Typically used for true power control.
- S** Apparent power measurement. For phase angle firing $S = V_{line} \times I_{RMS}$; for burst firing $S = V_{RMS} \times I_{RMS}$
- PF** Calculation of power factor. Defined as Power Factor = True Power / Apparent Power. In phase angle this is $PF = P/S$; in burst firing $PF = PBurst/S = \cos\phi(\text{Load})$
- Z** Displays load impedance.

	Defined as: $Z=V_{rms}/I_{rms}$. Measurement uses line current and load voltage.
HSink Temp	Reserved for future development.

Network Setup configuration

This displays the setup of the network and associated functions.

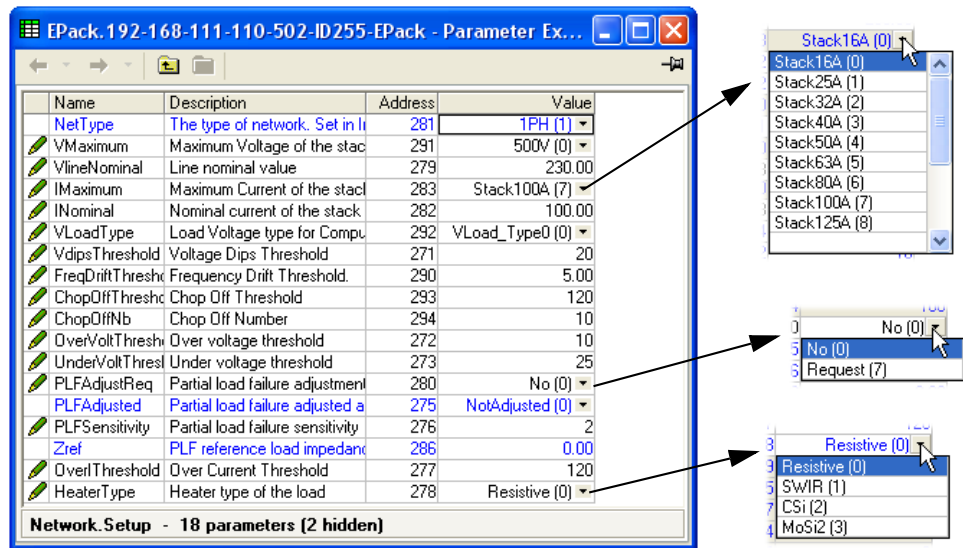

Figure 116 Network setup menu page

Parameters

- NetType** The type of network to which the unit can be connected. This is set at the factory and cannot be changed.
- VMaximum** Indicates the maximum voltage (physical rating) of the stack (500V).
- Vline Nominal** Line voltage nominal value.
- IMaximum** Indicates the maximum current of the stack (16A, 25A, 40A, 63A, 100A, 125A). Further values are reserved for future development.
- INominal** Nominal current supplied to the load (limited by IMaximum).
- VLoadType** Defines the computation method for load voltage (Vload).
 0: Vload = Vline as long as I > Ithreshold (internal definition)
 1: Compute Vload using the formula $V^2_{load} = P^2 / I^2$.
 2: Vload = Vline as long as thyristor firing order
- Heatsink Tmax** Reserved for future development.
- VdipsThreshold** Voltage dips threshold. This is a percentage difference (relative to Vline Nominal) between two consecutive half cycles. Each half cycle voltage measurement is integrated and at the end of each half cycle the last two voltage integrals are compared.
- FreqDriftThold** The supply frequency is checked every half cycle, and if the percentage change between 1/2 cycles exceeds this threshold value, a Mains Frequency System Alarm is generated. The threshold may be set to a maximum of 5% to cater for the effects of heavily inductive networks.
- ChopOffThreshold** The 'Chop-off' alarm becomes active if load current exceeds this threshold for more than a pre-defined number of mains periods (Number Chop Off parameter). Threshold values lie between 100% and 350% of the unit's nominal current (INominal).

NumberChopOff	Definition of the number of mains periods in which Chop Off events can occur before a Chop Off alarm is enabled. Only used with Chop Off Threshold.
OverVoltThreshold	The threshold for detecting an over voltage condition as a percentage of VLineNominal. If Vline rises above the threshold an OverVolt alarm is set.
UnderVoltThreshold	This is the threshold for detecting an under voltage condition as a percentage of VLineNominal. If Vline falls below the threshold an UnderVolt alarm is set
Heatsink PreTemp	Reserved for future development.
PLFAdjustReq	Partial load failure adjustment request. To make the Partial Load Failure (PLF) alarm operate correctly, the normal steady-state condition must be known to the instrument. This is done by activating the PLF Adjust Req once the controlled process has achieved a steady state condition. This causes a load impedance measurement to be made which is used as a reference for detecting a partial load failure. If the load impedance measurement is successful PLFAdjusted (below) is set. The measurement cannot be made if the load voltage (V) is below 30% of (VNominal) or the current (I) is below 30% of (INominal). The PLF alarm becomes active as setup in 'PLF Sensitivity', below.
PLFAdjusted	Partial load failure adjusted acknowledge. Indicates that the user requested a PLF adjustment and that the adjustment was successful.
PLFSensitivity	Partial load failure sensitivity. This defines how sensitive the partial load failure detection is to be as the ratio between the load impedance for a PLFadjusted load and the current impedance measurement. For example for a load of N parallel, identical elements, if the PLF Sensitivity (s) is set to 2, then a PLF alarm will occur if N/2, or more elements are broken (i.e. open circuit). If PLF Sensitivity is set to 3, then a PLF alarm occurs if N/3 or more elements are broken. If (N/s) is non-integer, then the sensitivity is rounded up. E.G. if N = 6 and s= 4, then the alarm is triggered if 2 or more elements are broken.
Zref	Reference load impedance, as measured when PLF adjust is requested.
OverIThreshold	The threshold for detecting an over current condition as a percentage of INominal. If I is above the threshold a Mains Current Alarm occurs (DetoverCurrent).
HeaterType	Shows the type of heater used in the load as: 'Resistive', 'SWIR' (Short wave infra-red), 'CSi' (Silicon Carbide), 'MoSi2' (Molybdenum Disilicide).

DANGER

HAZARD OF FIRE

- With SWIR Load, if a fast response time is required, or if IHC firing mode has been selected, select SWIR (Infrared) as Heater type.
- If SWIR is selected as Heater type, select the product current rating greater than or equal to 125% of MAXIMUM current of the SWIR load WITHOUT taking in account the inrush current
- If SWIR is selected as Heater type, adjust the duration of the safety ramp (SafetyRamp), the cooling time of the load (SWIRLoadCoolingTime) and the value of SWIR Load Cooling Threshold, to limit the RMS load inrush current SWIR to less than 2.5 times the product current rating.

Failure to follow these instructions will result in death or serious injury.

Network Alarms

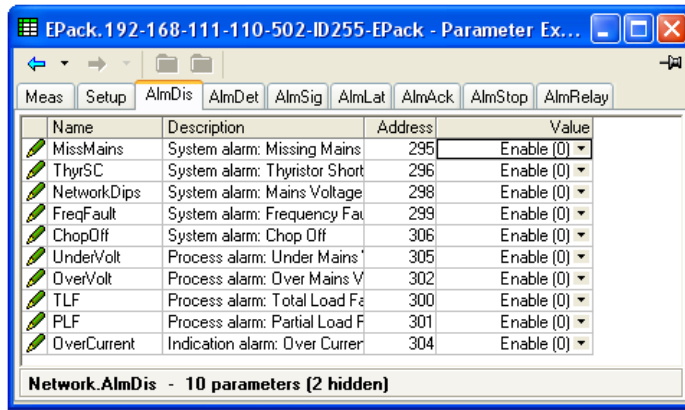

Figure 117 Network alarms page

AlmDis

This menu allows individual network block alarms (listed below) to be enabled/disabled.

- | | | |
|-------------------------------|--------------------------------|------------------------------|
| Missing Mains | Mains frequency fault detected | Total load failure |
| Thyristor short circuit | Chop Off | Partial load failure |
| Over-temperature ¹ | Under voltage | Pre-temperature ¹ |
| Mains voltage (Network) dips | Over voltage | Over current |

1.Reserved for future development

Network AlmDet Submenu

As for 'Alarm Disable', above, but this Alarm detect submenu indicates whether any of the network alarms has been detected and is currently active.

Network Almsig Submenu

These displays show whether an alarm has occurred and also contains latching information. The relevant AlarmSig parameter is used when wiring (to a relay for example). The alarm list is as given above.

Network Almlat Submenu

As for 'Alarm Disable', above, but this Alarm Latch submenu allows each individual network block alarm to be defined as latching or non-latching.

Network Almack Submenu

As for 'Alarm Disable', above, but this Alarm Acknowledge submenu allows each individual network block alarm to be acknowledged. Once acknowledged, the associated signaling parameter is cleared. Acknowledge parameters automatically clear after being written.

Note: Alarms may not be acknowledged whilst the trigger source is still active.

Network Almstop Submenu

Allows each individual alarm type to be configured to stop the related power module from firing. Activated by the related signaling parameter. The alarm list is as given above.

Network Almrelay Submenu

Allows each individual alarm to be selected to activate (or not) the relay.

Note: When utilizing Almrelay function, ensure FaultDet/CustomAlarm parameter remains wired to IO.Relay/PV.

Qcode

Quick code parameters are also settable when in Quickcode configuration mode.

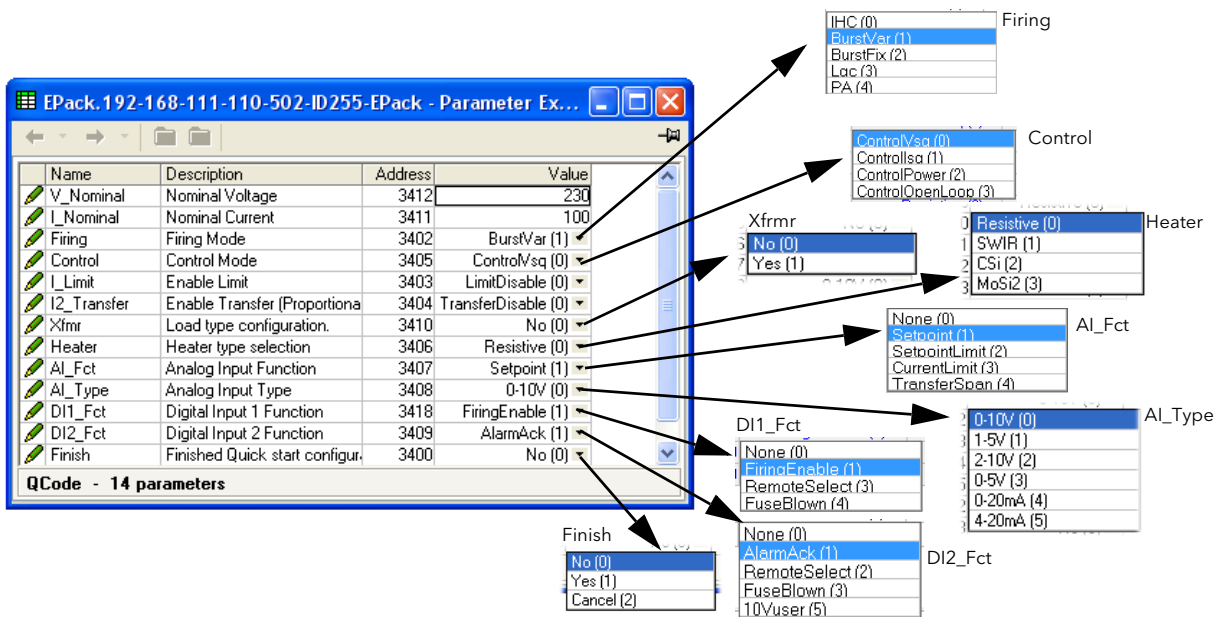

Figure 118 Quick code parameters

Parameters

- V_Nominal** The nominal output voltage to be supplied.
- I_Nominal** The nominal output current expected to be drawn.
- Firing** Select firing mode from IHC (Intelligent Half Cycle), Burst firing (fixed or variable), Logic or Phase angle.
- Control** Select 'Vsq' (V^2), 'Isq' (I^2), 'Power' or 'Open Loop' as the control mode.
- I_Limit** This is used to Enable or disable threshold limit. (By default the current limit function is enabled).
- I2_Transfer** Enable or disable transfer (Proportional limit). This is only available if ordered.
- XFmr** Select output as suitable for resistive loads (No) or for transformer primary loads (Yes).
- Heater** Select Resistive, Short wave infra red (SWIR), Silicon carbide (CSi) or Molybdenum disilicide (MoSi2) as the heating element type.
- AI_Fct** Select the Analog Input function as 'None', 'Setpoint' or 'Setpoint limit'.
- AI_Type** Select the required Volt or mA range (as shown above) for the analog input.
- DI1_Fct** Select the function of Digital Input 1 as 'None', 'Firing Enable', Alarm acknowledge ('AlarmAck'), Select remote setpoint ('RemoteSelect'), Fuse Blown ('Fuse Blown') or Setpoint.
- DI2_Fct** Select the function of Digital Input 2 as; 'None', Alarm acknowledge ('AlarmAck'), Select remote setpoint ('RemoteSelect') or Fuse Blown ('FuseBlown), or Setpoint, providing Firing is set too 'Logic', and AI_Type is not set too 'Setpoint'), or a configurable User Input ('10Vuser').
- Finish** Yes = quit quick code (after confirmation) and restart the unit with the new configuration; No = continue configuration editing; Cancel = ignore all changes and restart the unit with the previous (unedited) configuration.

Setprov Configuration Menu

The Setpoint provider supplies one local and two remote setpoints. It also allows users to manage a setpoint ramp, a setpoint limit (re-linearization) and the possibility to select between percentage and engineering for setpoint unit.

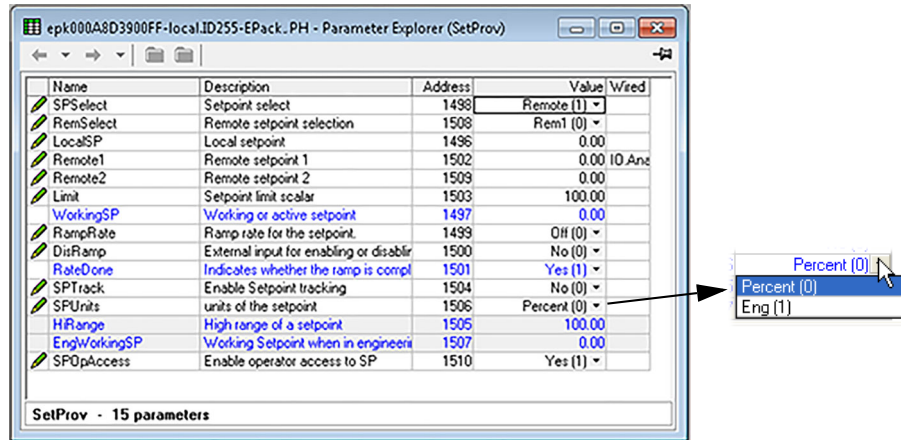

Figure 119 SetProv configuration page

Setpoint provider parameters

- SPSelect Allows the user to select between Remote or Local as the setpoint source.
- RemSelect Select Remote1 or Remote2 as the remote setpoint.
- LocalSP Allows entry of a setpoint value to be used when SPSelect (above) is set to 'Local'.
- Remote1 The Remote setpoint value (normally wired from an analog input) for use when SPSelect = Remote and RemSelect = Remote1.
- Remote2 The Remote setpoint value (normally wired from an analog input) for use when SPSelect = Remote and RemSelect = Remote2.
- Limit Allows the working setpoint to be scaled such that 'scaled working SP' = (working SP x limit)/100. Thus, when limit = 100, the setpoint is unscaled.
- WorkingSP The active value being provided as a setpoint output. This might be the current target setpoint or the rate-limited target setpoint.
- RampRate This applies a rate limit to the working setpoint, until the target setpoint has been achieved. The 'RateDone' parameter (below) is set to 'No' for the duration of the rate limiting, then set to 'Yes' when rate limiting is complete.
- DisRamp This is an external control used to enable/disable ramp rate limiting and to write the target setpoint directly to the working setpoint. The 'RateDone' parameter (below) is set to 'Yes' when DisRamp is 'Yes'.
- RateDone Set to 'No' if ramp rate limiting (above) is in operation. Otherwise set to 'Yes'.
- SPTrack If enabled ('Yes') the local setpoint tracks the remote setpoints, so that if the setpoint is subsequently set to 'Local', the local setpoint will be the same as the last known value of the remote setpoint, thus helping to ensure a bumpless transfer.

SPOpAccess	<p>The SetPoint operational access parameter is used to allow or hide access to a local setpoint.</p> <p>Yes (1) = Enables access.</p> <p>No (0) = Disables (hides) access.</p> <p>Setpoint remains adjustable from a remote input whatever value of this parameter</p>
SPUnits	<p>Allows the user to select % or 'Eng' (Engineering units) as Setpoint units. If 'Eng' is selected, 'HiRange' and 'Eng workingSP' appear at the user interface.</p>
HiRange	<p>Appears only if SP units set to 'Eng'. This value is the high range of the setpoint used to scale the setpoint into % of High Range.</p>
EngWorkingSP	<p>Appears only if SP units set to 'Eng'. This value is an indication of the working setpoint in Engineering units. The parameter must not be used for control because control loops accept setpoints only as % values.</p>

Timer Configuration

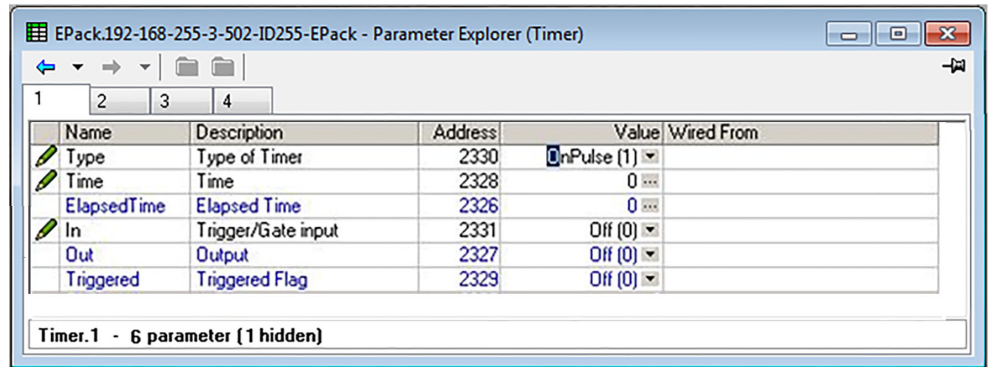

Figure 120 iTools Timer configuration

Parameters

- Type
 - Off
Timer is off
 - On Pulse
The timer output switches on when 'In' changes from Off to On, and it remains on until the time period ('Time' - see below) has elapsed. If the input is re-triggered before 'Time' has elapsed, the timer re-starts. 'Triggered' (below) follows the state of the output.
 - On delay
After the input changes from Off to On, the timer output remains off until the time period defined in 'Time' (below) has elapsed. Once this period has elapsed, if the input is still on, the output switches on and remains on until the input goes Off. Elapsed time is set to zero when the input goes off. 'Triggered' follows the state of the input.
 - One Shot
If the input is On, then as soon as a value is entered into the 'Time' parameter (below) the output goes on, and remains on until the Time period has elapsed, or the input goes off. If the input is off, the output is set off and the time countdown is inhibited until input goes on again. 'Triggered' goes On as soon as the time value is edited, and remains on until the output goes Off. The Time value may be edited whilst active. Once the time period has elapsed, the Time value must be re-edited in order to re-start the timer.
 - Min On
The output remains 'On' as long as the Input is on, plus the 'Time' period (below). If the input returns to the on state before the time period has elapsed, the elapsed time is reset to zero, so that the full time period is added to the On period when the input switches off again. 'Triggered' is On whilst the elapsed time is greater than zero.
- Time
Allows the user to set a time period for use as described in 'Type' above. Initially, the value displayed under iTools is in the form Minutes:seconds.10ths of seconds, but as the input value increases the format changes first to Hours:Mins:Secs, then to Hrs:Mins. (Holding the up arrow key continuously operated causes the speed at which the value increments to increase. Minimum entry is 0.1 seconds; maximum is 500 hours.
- ElapsedTime
Shows how much of the time period has passed so far.
- In
The timer trigger input. The function of this input varies according to timer type, as described above.
- Out
Shows the timer on/off status.
- Triggered
Function depends on timer type, as described above.

Timer examples

Figure 121 shows some timing examples for the different types of timer available.

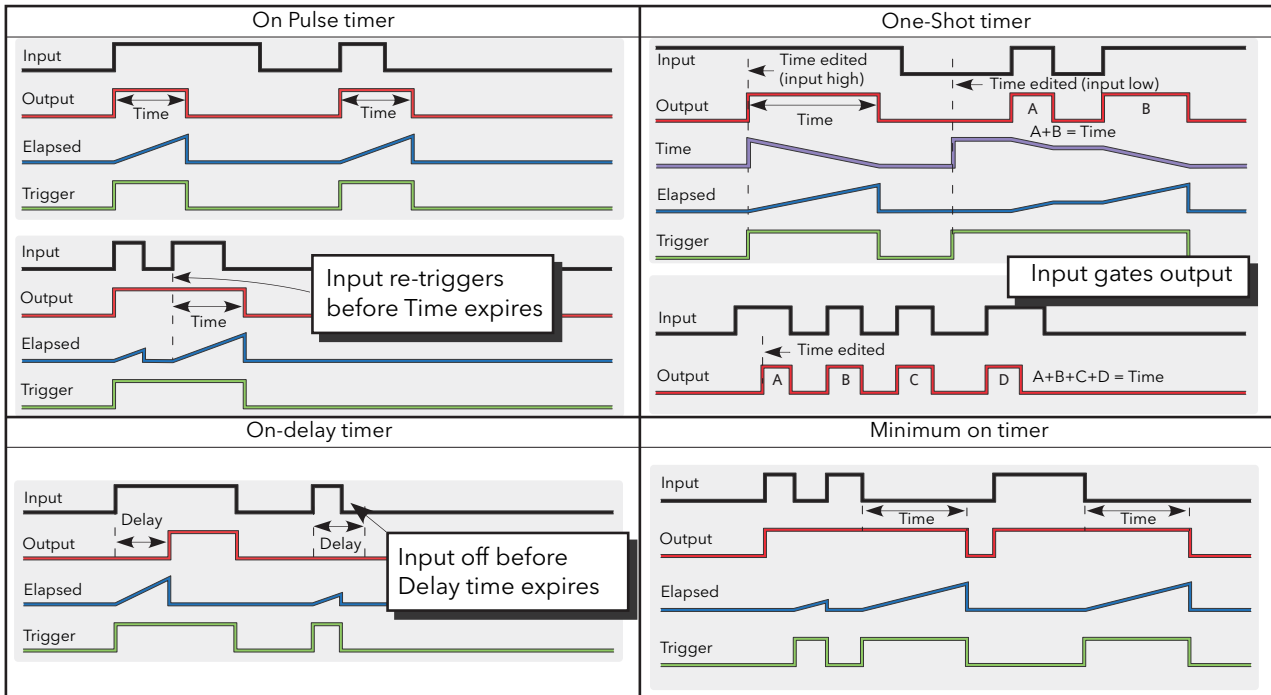

Figure 121 Timer examples

Totalizer Configuration

The totalizer is an instrument function used to calculate a total quantity by integrating a flow rate input over time. The maximum value of the totalizer is +/- 9,999,999,999. The outputs from a totalizer are its integrated value, and an alarm state.

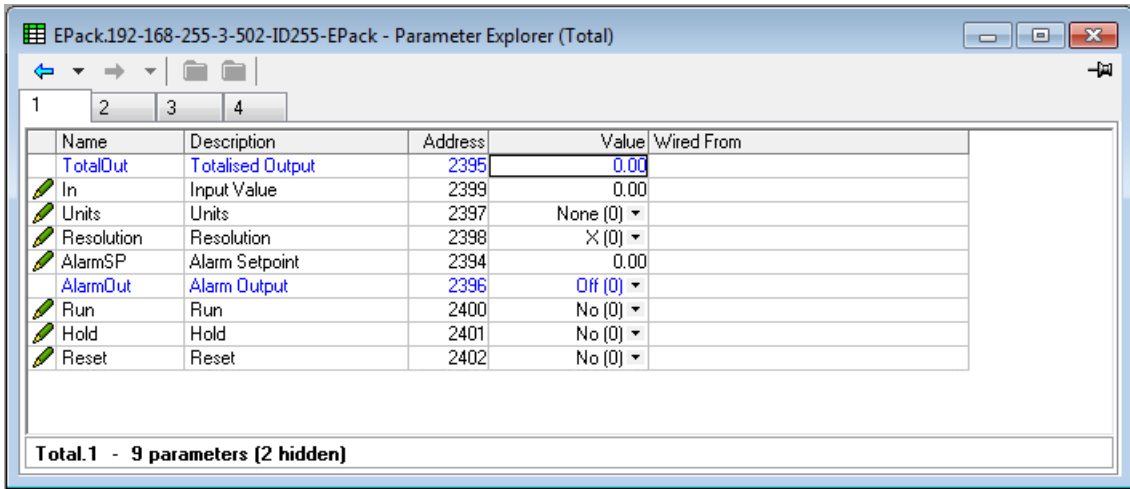

Figure 122 iTools Totalizer page

Parameters

- Total Out The integrated total between -9,999,999,999 and +9,999,999,999
- In The parameter to be totalized.
- Units Units of the totalized measurement.
- Resolution Set the number of decimal places for the totalizer value.
- AlarmSP Totalizer alarm setpoint. This threshold is applied to the totalized measurement. When totalizing positive values, a positive AlarmSP value must be entered; the totalizer alarm being triggered when the totalizer value reaches or exceeds AlarmSP. When totalizing negative values, a negative value must be entered; the totalizer alarm being triggered when the totalizer value reaches or goes more negative than AlarmSP. If set to zero, the alarm is disabled.
- AlarmOut The on/off status of the totalizer alarm.
- Run Yes initiates integration; No inhibits integration.
- Hold Yes suspends integration; No restarts integration.
- Reset Yes resets the totalizer value to zero and resets the totalizer alarm.

User Value Configuration Menu

This provides storage for up to four user-defined constants. Typical uses are as a sources for maths functions, or as storage for values written over the communications link.

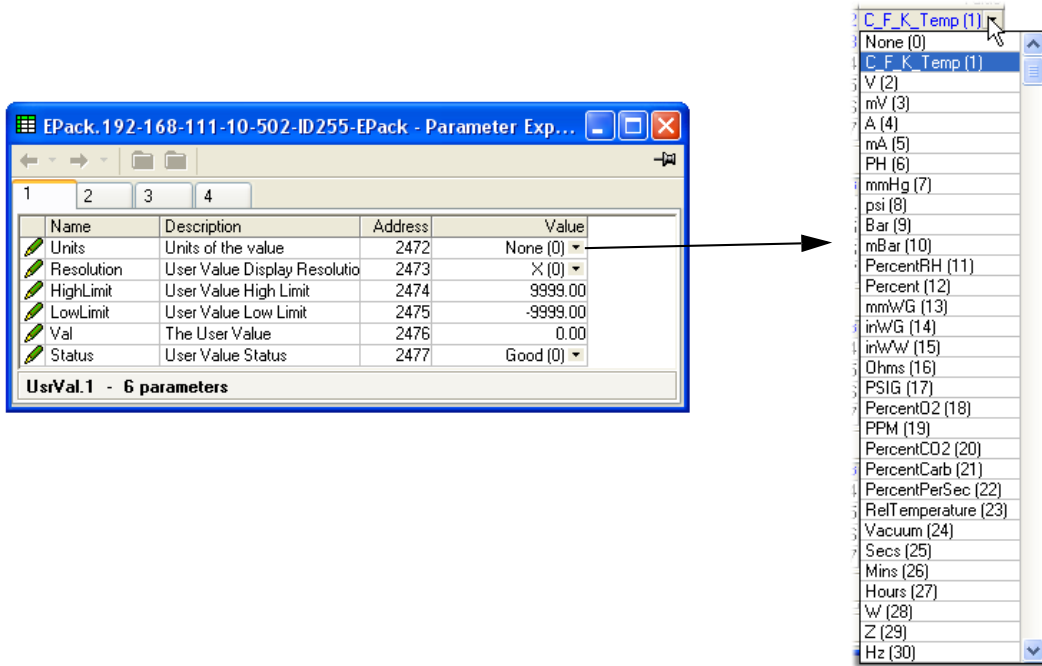

Figure 123 Top level UseVal page

User Value parameters

- Units** Allows the selection of User Value units.
- Resolution** Set the number of decimal places for the User Value.
- High/Low Limit** Allows the user to set limits to help prevent the User Value from being set out-of-bounds.
- Value** Allows the user to enter a value, or the value if wired to a suitable parameter.
- Status** If this parameter is wired, it can be used to force a Good or Bad status onto the User Value for test purposes (e.g. fallback strategy).
If not wired, it reflects the status of the Value input if this input is wired.

Using iTools

iTools software running on a PC allows quick and easy access to the configuration of the unit. The parameters used are the same as those described in "Configuration using iTools" on page 133, with the addition of various diagnostic parameters.

iTools also gives the user the ability to create software wiring between function blocks, something that is not possible from the operator interface. Such wiring is carried out using the Graphical wiring Editor feature.

In addition to the guidance given here, there are two on-line Help systems available within iTools: Parameter help and iTools help. Parameter help is accessed by clicking on 'Help' in the toolbar (opens the complete parameter help system), by right-clicking on a parameter and selecting 'Parameter Help' from the resulting context menu, or by clicking on the Help menu and selecting 'Device Help'. iTools help is accessed by clicking on the Help menu, and selecting 'Contents'. iTools help is also available in manual format under part number HA028838, either as a physical manual or as a PDF file.

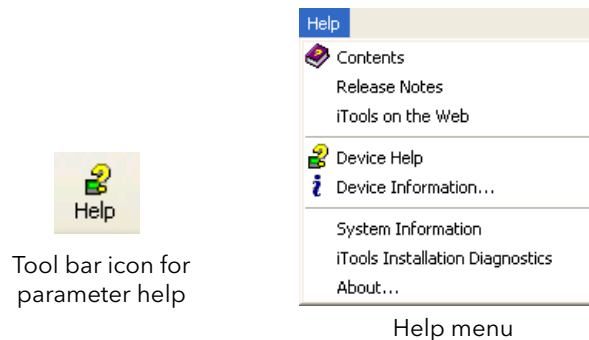

Figure 124 Help access

iTools connection

Automatic detection

The following descriptions assume that the latest version iTools software has been correctly installed on the PC.

For E-Pack units only (at time of publication), if the desktop/laptop and E-Pack are IP compatible (same subnet mask) then Plug & Play allows easy connection as follows.

1. Set correct IP mode and or IP address to the instrument and PC.
2. Launch iTools, click on the button 'Add' a popup window appears showing you all E-Pack instruments on the network.
3. Double click on one or more units to add them to iTools.

Note: 'Eurotherm discovery' mechanism is based on 'Zero Configuration Networking' which is generic name used to group protocols together in order to create communication networks automatically (Plug & Play).

Alternatively, if there is a mix of E-Pack and other instruments on the network, the following procedure can be used.

Ethernet (Modbus TCP) communications

Note: The following description is given as an example. Images could be different depending on the version of Windows being used.

It is first necessary to determine the IP address of the unit, as described in "Communications Configuration" on page 137. This can be done from either the Config or Quickcode menu.

Once the Ethernet link has been correctly installed, carry out the following actions at the PC:

1. Click on 'Start'
2. Click on 'Control Panel'. (If Control Panel opens in 'Category View' select 'Classic View' instead.)
3. Double-click on 'iTools'.
4. Click on the TCP/IP tab in the Registry settings configuration.
5. Click on Add... The 'New TCP/IP Port' dialog box opens.
6. Type-in a name for the port, then click Add...
7. Type the IP address of the unit in the 'Edit Host' box which appears. Click OK.
8. Check the details in the 'New TCP/IP Port' box, then click on 'OK'.
9. Click on 'OK' in the 'Registry settings' box to confirm the new port.

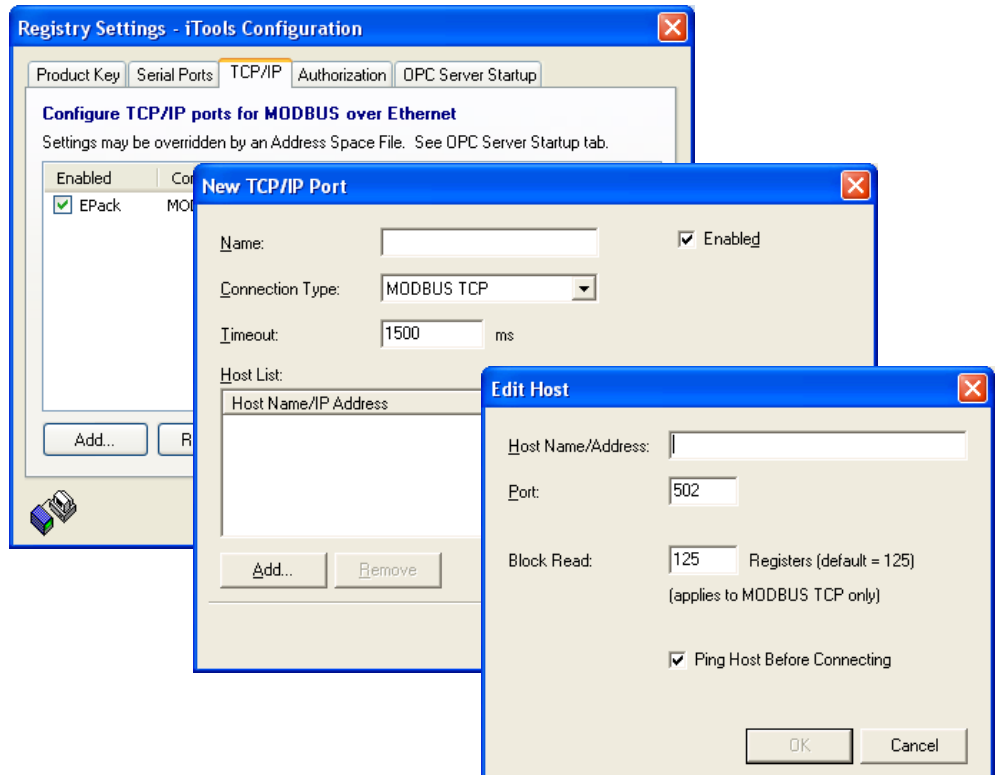

Figure 125 Adding a new Ethernet port

To check that the PC can now communicate with the instrument, Click 'Start', 'All Programs', 'Accessories', 'Command Prompt', when the Command Prompt box appears, type in : Ping<Space>IP1.IP2.IP3.IP4<Enter> (where IP1 to IP4 are the IP address of the instrument).

If the Ethernet link to the instrument is operating correctly, the 'successful' reply arrives. Otherwise, the 'Ping request could not find host' reply arrives, in which case, the Ethernet link, IP address, and PC port details should be verified.

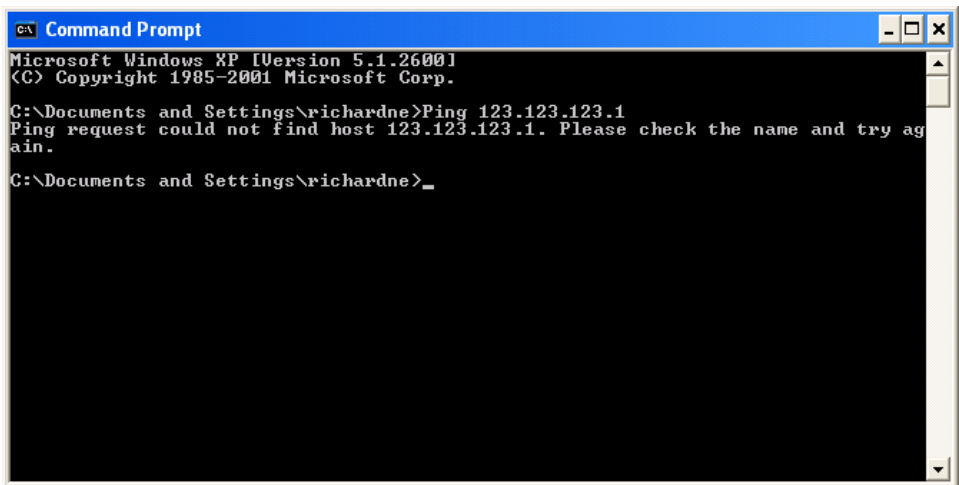
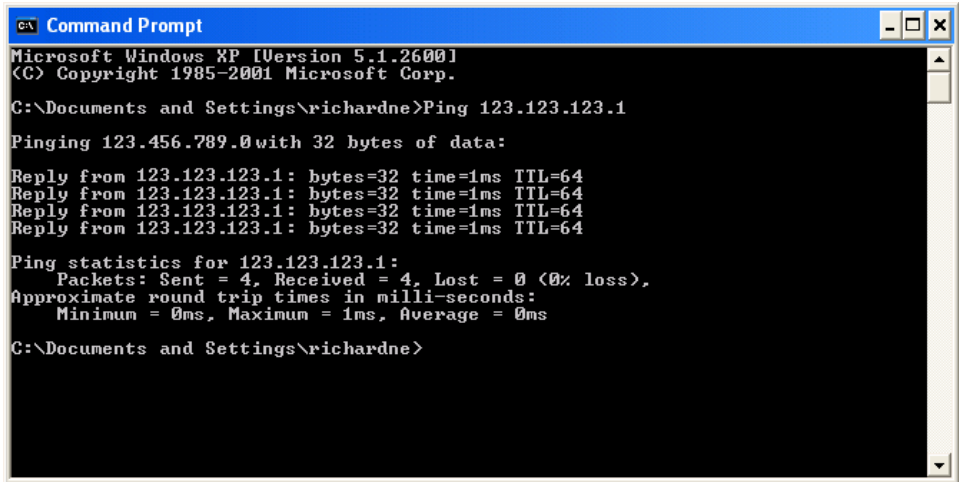

Figure 126 Command prompt 'Ping' screens (typical)

Another way to check connection is to use OPC server to perform verification.

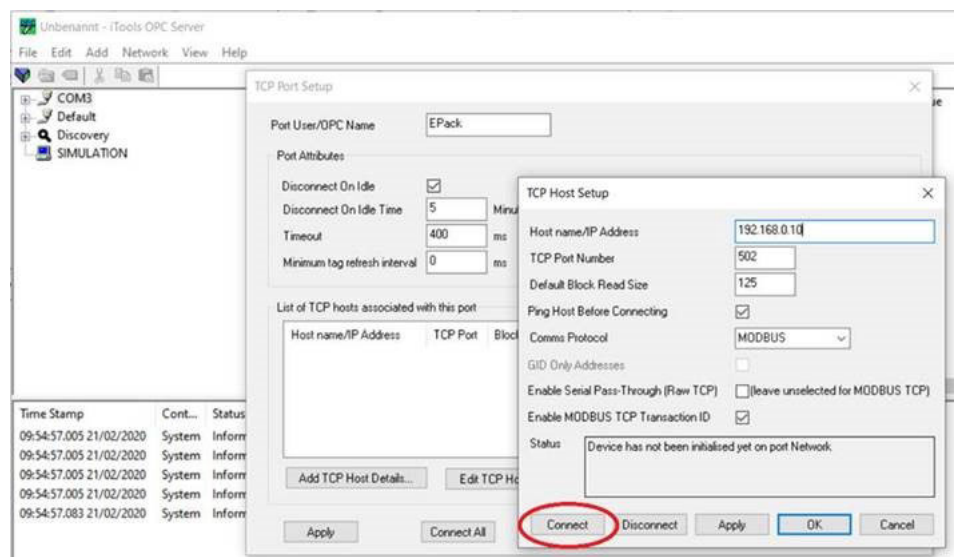

Figure 127 Ethernet Connection Checking using OPC Server

After adding the port details, test the connection by pressing 'Connect. The status should be "Device is functioning correctly".

Once the Ethernet link to the instrument has been verified, iTools can be started (or shut down and restarted), and the Scan toolbar icon used, to 'find' the instrument. The scan can be stopped at any time by clicking on the Scan icon a second time.



See "Scanning for Instruments" on page 199 for more details of the scan procedure.

Direct Connection

This section describes how to connect a PC directly to a Driver Module which, for this purpose, must be fitted with the Ethernet communications option.

Wiring

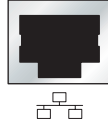

PC Ethernet connector.

Connection is made from the Ethernet connector on the front of the Driver Module to an Ethernet RJ45 connector, usually located at the rear of the PC.

Once wired correctly, and powered up, it is necessary to enter a suitable IP address and subnet mask into the Comms configuration. This information can be found as follows:

1. At the PC, click 'Start'. 'All Programs', 'Accessories', 'Command Prompt'
2. When the Command Prompt box appears, type in :IPConfig<Enter>
3. The response is a display, such as that shown below, giving the IP address and Subnet mask of the PC.
Choose an address in the range covered by these two values.
4. A subnet mask element of 255 means that the equivalent element of the IP address must be used unchanged. A subnet mask element of 0 means that the equivalent element of the IP address may take any value between 1 and 255 (0 is not allowed). In the example below, the range of IP addresses which may be chosen for the Driver Module is 123.123.123.2 to 123.123.123.255. (123.123.123.0 is not allowed and 123.123.123.1 is the same as the PC's address, and may therefore not be used.)

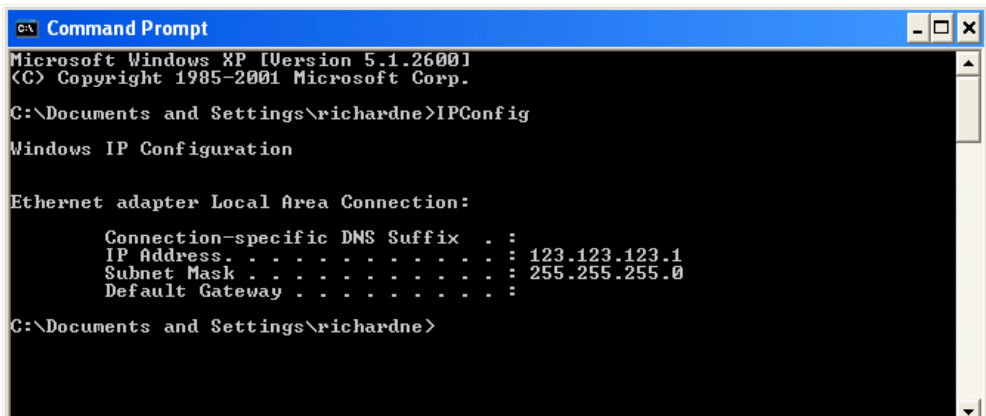

Figure 128 IP Config command

5. In Comms configuration (see page137), enter the selected IP address and the subnet mask (as it appears in the command prompt window) in the relevant parts of the configuration menu.
6. Check communications by 'pinging' as described in Ethernet (Modbus TCP) communications (page 194).

Once the link to the instrument has been verified, iTools can be started (or shut down and re-started), and the 'Add' button used to add the instrument. Alternatively, the Scan toolbar icon can be used, to 'find' the instrument. The scan can be stopped at any time by clicking on the Scan icon a second time.



See Scanning for Instruments (page 199), for more details of the scan procedure.

Subnet Masks and IP addresses.

Subnet Masks are most readily understood when looked at in binary format. For example, a mask of 255.255.240.10 can be re-written as: 11111111.11111111.11110000.00001010. In such a case, IP addresses 11111111.11111111.1111xxxx.xxx1x1x would be recognised (where x can be either a 0 or a 1).

Subnet mask	→	1 1 1 1 1 1 1 1	1 1 1 1 1 1 1 1	1 1 1 1 0 0 0 0	0 0 0 0 1 0 1 0
IP addresses (Binary)	→	1 1 1 1 1 1 1 1	1 1 1 1 1 1 1 1	1 1 1 1 x x x x	x x x x 1 x 1 x
IP addresses (decimal)	→	255	255	240 to 255	10, 11, 14, 15, 26, 27, 30, 31, 42, 43, 46, 47 etc.

Scanning for Instruments

Clicking on the 'Scan' toolbar icon causes a dialog box (shown below) to appear. This allows the user to define a search range of addresses.

Notes:

1. Scanning is necessary only when the 'Plug & Play' is not available for the instrument type being searched for.
2. E-Pack units with software version 2.03 onwards, answer to any request made to their IP addresses independently of any Modbus address setting.
3. The default selection (Scan all device addresses...) will detect any instrument on the serial link, which has a valid address. The 'Scan for Eurotherm devices only' and 'Terminate Scan when first device found' tick boxes can be used to modify the scan process.

As the search progresses, any instruments detected by the scan appear as thumbnails (faceplates) in the 'Panel Views' area, normally located at the bottom of the iTools screen. (options/Panel Views position allows this area to be moved to the top of the window, or the Close icon  can be used to close it. Once closed it can be re-opened by clicking on 'Panel Views' in the 'View' menu.)

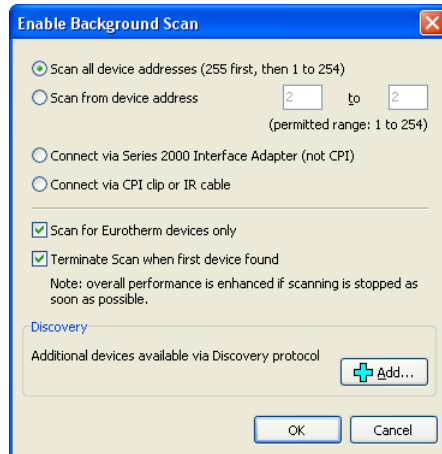

Figure 129 Scan range enable

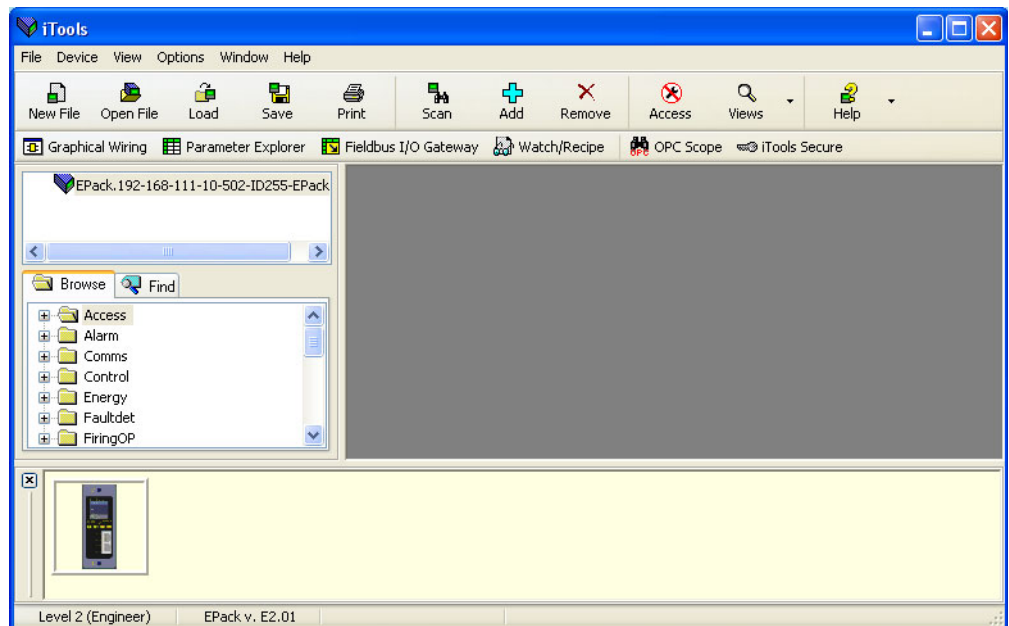

Figure 130 iTools initial window with one instrument detected

Graphical Wiring Editor Graphical Wiring

Note: The Graphical Wiring Editor is a chargeable option, and the toolbar icon appears only if the option has been purchased and is enabled.

Clicking on the Graphical Wiring Editor (GWE) toolbar icon causes the Graphical wiring window for the current instrument configuration to open. Initially, this reflects the preset factory default block wiring.

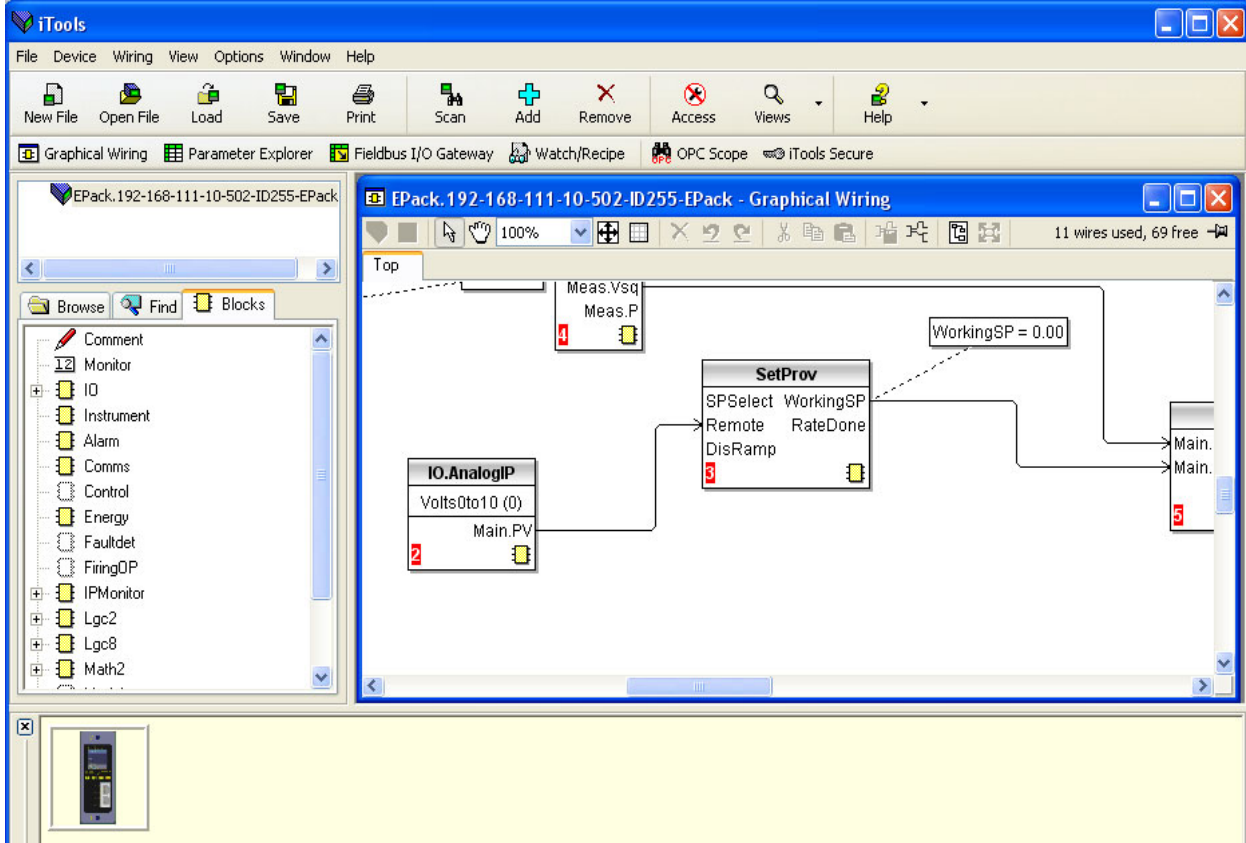
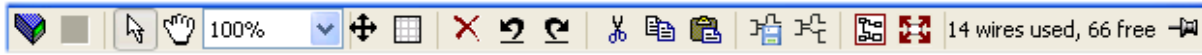





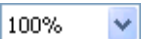





Figure 131 Graphical wiring Editor

The graphical wiring editor allows:

1. Function blocks, notes, comments etc. to be 'dragged and dropped' into the wiring diagram from the tree list (left pane).
2. Parameters to be wired to one another by clicking on the output, the clicking on the required input.
3. Viewing and/or editing of parameter values by right-clicking on a function block and selecting 'Function Block View'.
4. The user to select parameter lists and to switch between parameter and wiring editors.
5. Completed wiring to be downloaded to the instrument (function blocks and wiring items with dashed outlines are new, or have been edited since the last download).

Toolbar



	Download wiring to Instrument.
	Mouse Select. Select normal mouse operation. Mutually exclusive with 'Pan', below.
	Mouse Pan. When active, this causes the mouse cursor to become a hand-shaped icon. Allows the graphical wiring diagram to be click-dragged within the GWE window aperture.
	Zoom. Allows the magnification of the wiring diagram to be edited.
	Pan tool. Whilst left-clicked, the cursor appears as a rectangle, representing the position of GWE window aperture over the whole wiring diagram. Click-dragging allows this aperture to be moved freely about the diagram. Rectangle size depends on Zoom (magnification) factor.
	Show/Hide grid. This icon toggles a background alignment grid on and off.
	Undo, Redo. Allows the user to undo the last action, or once an undo action has taken place, to undo the undo. Short cuts are <Ctrl>+<Z> for undo; <Ctrl>+<R> for re-do.
	Cut, Copy, Paste. Normal Cut (copy and delete), Copy (copy without delete) and Paste (insert into) functions. Short cuts are <Ctrl>+<X> for cut; <Ctrl>+<C> for copy and <Ctrl>+<V> for Paste.
	Copy diagram fragment; Paste diagram fragment. Allows a part of the wiring diagram to be selected, named and saved to file. The fragment may then be pasted into any wiring diagram, including the source diagram.
	Create compound; Flatten compound. These two icons allow compounds to be created and 'uncreated' respectively.

Wiring Editor Operating Details

Component Selection

Single wires are shown with boxes at 'corners' when selected. When more than one wire is selected, as part of a group, the wire color changes to magenta. All other items have a dashed line drawn round them when selected.

Clicking on a single item selects it. An Item can be added to the selection by holding down the control key (Ctrl) whilst clicking on the item. (A selected item can be deselected in the same way.) If a block is selected, then all its associated wires are also selected.

Alternatively, the mouse can be click-dragged on the background to create a 'rubber band' round the relevant area; anything within this area being selected when the mouse is released.

<Ctrl>+<A> selects all items on the active diagram.

Block Execution Order

The order in which the blocks are executed by the instrument depends on the way in which they are wired. The order is automatically worked out so that the blocks use the most recent data. Each block displays its place in its sequence in a colored square in the bottom left-hand corner (Figure 132).

Function Blocks

A Function Block is an algorithm which may be wired to and from other function blocks to make a control strategy. Each function block has inputs and outputs. Any parameter may be wired **from**, but only parameters that are alterable in Operator Mode may be wired **to**. A function block includes any parameters that are needed to configure or operate the algorithm. The inputs and outputs which are considered to be of most use are always shown. In most cases all of these need to be wired before the block can perform a useful task.

If a function block is not faded in the tree (left hand pane) it can be dragged onto the diagram. The block can be dragged around the diagram using the mouse.

A Maths block is shown below as an example. When block type information is alterable (as in this case) click on the box with the down arrow in it to display a dialog box allowing the value to be edited.

If it is required to wire from a parameter, which is not shown as a recommended output, click on the 'Click to Select Output' icon in the bottom right hand corner to display a full list of parameters in the block (Figure 134, below). Click on one of these to start a wire.

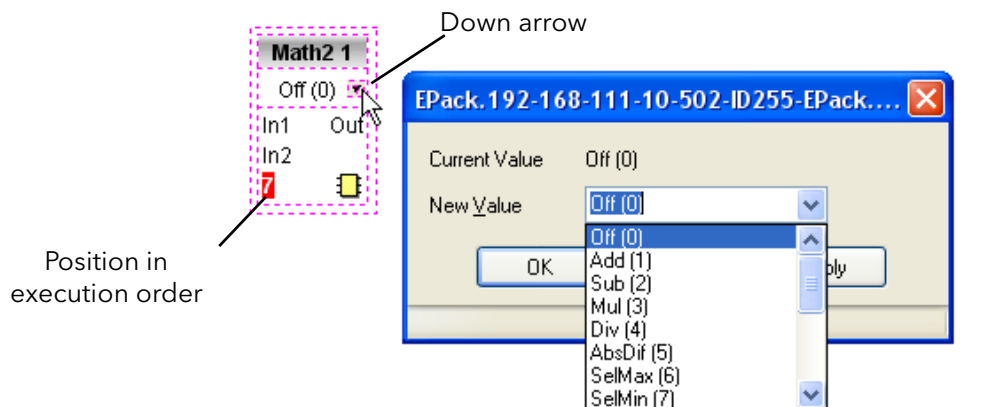

Figure 132 Function block example

Function Block Context Menu

Right-click in the function block to display the context menu.

Function block View Displays a list of parameters associated with the function block. 'Hidden' parameters can be displayed by de-selecting 'Hide Parameters and Lists when not Relevant' in the Options menu 'Parameter availability Settings...' item.

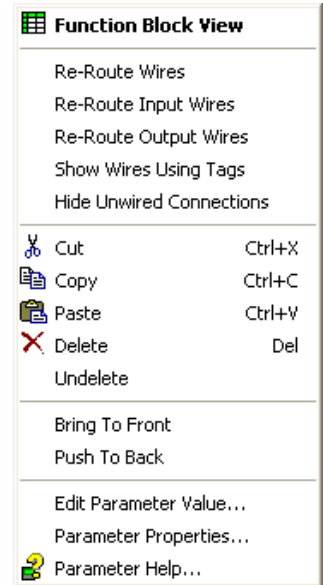
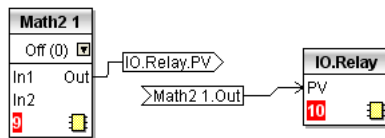

Figure 133 Function block context menu

Re-Route wires Redraws all wiring associated with the function block.
Re-Route Input wires Redraws all Input wiring associated with the function block.
Re-Route Output wires Redraws all Output wiring associated with the function block.
Show Wires Using Tags Wires are not drawn, but their Start and End destinations are indicated by tags instead. Reduces wire 'clutter' in diagrams, where source and destination are widely separated.



Hide Unwired Connections

Displays only those parameters which are wired.

Cut Allows one or more selected items to be moved to the Clipboard ready for pasting into another diagram or compound, or for use in a Watch window, or OPC scope. The original items are grayed out, and function blocks and wires are shown dashed until next download, after which they are removed from the diagram. Short cut = <Ctrl>+<X>. Cut operations carried out since the last download can be 'undone' by using the 'Undo' toolbar icon, by selecting 'Undelete' or by using the short cut <Ctrl>+<Z>.

Copy Allows one or more selected items to be copied to the Clipboard ready for pasting into another diagram or compound, or for use in a Watch window, or OPC scope. The original items remain in the current wiring diagram. Short cut = <Ctrl>+<C>. If items are pasted to the same diagram from which they were copied, the items will be replicated with different block instances. Should this result in more instances of a block than are available, a message appears showing details of which items couldn't be copied.

Paste Copies items from the Clipboard to the current wiring diagram. <Ctrl>+<V>. If items are pasted to the same diagram from which they were copied, the items will be replicated with different block instances. Should this result in more instances of a block than are available, a Paste message log display appears showing details of which items couldn't be copied.

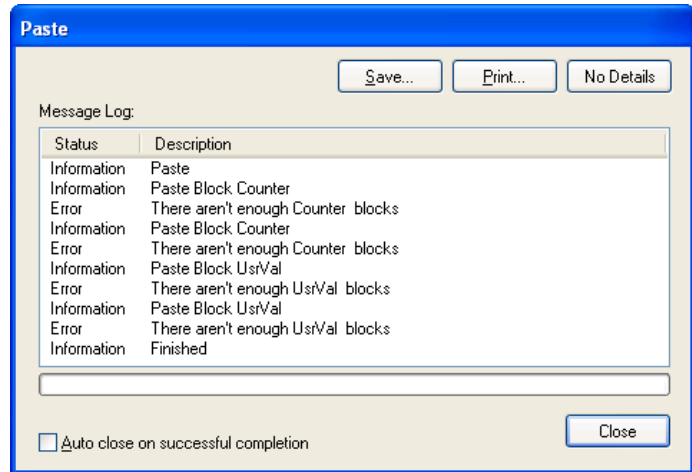

Delete Marks all selected items for deletion. Such items are shown dashed until next download, after which they are removed from the diagram. Short cut = .

Undelete Reverses 'Delete' and 'Cut' operations carried out on selected item(s) since the last download.

Bring To Front Brings selected items to the front of the diagram.

Push To back Sends the selected items to the back of the diagram.

Edit Parameter Value...
This menu item is active if the cursor is hovering over an editable parameter. Selecting this menu item causes a pop-up window to appear, which allows the user to edit the parameter value.

Parameter Properties...
This menu item is active if the cursor is hovering over an editable parameter. Selecting this menu item causes a pop-up window to appear, which allows the user to view the parameter properties, and also, to view the parameter Help (by clicking on the 'Help' tab).

Parameter Help... Produces Parameter Properties and Help information for the selected function block or parameter, depending on the hover position of the cursor, when the right-click occurs.

Wires

To make a wire

1. Drag two (or more) blocks onto the diagram from the function block tree.
2. Start a wire by either clicking on a recommended output or clicking on the 'Click to Select output' icon at the bottom right corner of the block to bring up the connection dialog, and clicking on the required parameter.
Recommended connections are shown with a green plug symbol; other parameters which are available being shown in yellow. Clicking on the red button causes all parameters to be shown. To dismiss the connection dialog either press the escape key on the keyboard, or click the cross at the bottom left of the dialog box.
3. Once the wire has started a dashed wire is drawn from the output to the current mouse position. To complete the wire click on the required destination parameter.
4. Wires remain dashed until they are downloaded

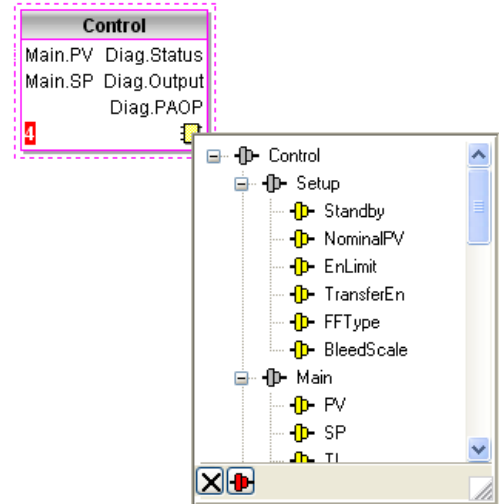

Figure 134 Output selection dialog box



Routing Wires

When a wire is placed it is auto-routed. The auto routing algorithm searches for a clear path between the two blocks. A wire can be auto-routed again using the context menus or by double clicking the wire. A wire segment can be edited manually by click-dragging. If the block to which it is connected is moved, the end of the wire moves with it, retaining as much of the path as possible.

If a wire is selected by clicking on it, it is drawn with small boxes on its corners.

Wire Context Menu

Right click on a wire to display the wire block context menu:

Force Exec Break	When wires form a loop, a break point must be introduced, where the value written to the block comes from a source which was last executed during the previous cycle. A break is automatically placed by iTools, and appears in red.  Force Exec Break allows the user to define where a break must be placed. Surplus breaks appear in black. 
Re-Route wire	Replaces the current wire route with a new route generated from scratch.
Use Tags	Toggles between wire and tag mode between parameters. Tag mode is useful for sources and destinations which are widely separated.
Find Start	Goes to the source of the wire.
Find End	Goes to the destination of the wire.
Cut, Copy, Paste	Not used in this context.
Delete	Marks the wire for deletion. The wire is redrawn as a dashed line (or dashed tags) until next download. Operation can be reversed until after next download.
Undelete	Reverses the effect of the Delete operation up until the next download, after which, Undelete is disabled.
Bring to Front	Brings the wire to the front of the diagram.
Push to Back	Sends the wire to the back of the diagram.

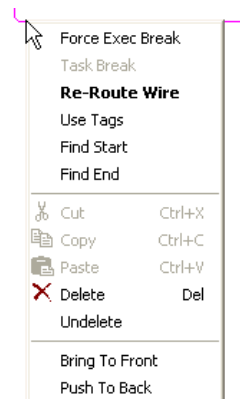

Figure 135 Wire context menu

Wire Colors

Black	Normal functioning wire
Red	The wire is connected to a non-changeable parameter. Values are rejected by the destination block.
Magenta	A normal functioning wire is being hovered-over by the mouse cursor.
Purple	A red wire is being hovered-over by the mouse cursor.
Green	New Wire (dashed green wire changes to solid black after being downloaded.)

Thick Wires

When attempting to wire between blocks which are located in different tasks, if no task break is inserted, then all the affected wires are highlighted by being drawn with a much thicker line than usual. Thick wires still execute, but the results are unpredictable, as the unit cannot resolve the strategy.

Comments

Comments are added to a wiring diagram by click-dragging them from the Function Block tree onto the diagram. As soon as the mouse is released, a dialog box opens to allow comment text to be entered.

Carriage returns are used to control the width of the comment. Once text entry is complete, 'OK' causes the comment to appear on the diagram. There are no restrictions on the size of a comment. Comments are saved to the instrument along with the diagram layout information.

Comments can be linked to function blocks and wires by clicking on the chain icon at the bottom right-hand corner of the comment box and then clicking again on the required block or wire. A dashed line is drawn to the top of the block or to the selected wire segment (Figure 137).

Note: Once the comment has been linked, the Chain icon disappears. It re-appears when the mouse cursor is hovered over the bottom right-hand corner of the comment box, see Figure 137.

Comment Context Menu

Edit	Opens the Comment dialog box to allow the comment text to be edited.
Unlink	Deletes the current link from the comment.
Cut	Moves the comment to the Clipboard, ready to be pasted elsewhere. Short cut = <Ctrl>+<X>.
Copy	Copies the comment from the wiring diagram to the Clipboard, ready to be pasted elsewhere. Short cut = <Ctrl>+<C>.
Paste	Copies a comment from the Clipboard to the wiring diagram. Short cut = <Ctrl>+<V>.
Delete	Marks the comment for deletion at next download.
Undelete	Undoes the Delete command if download has not taken place since.

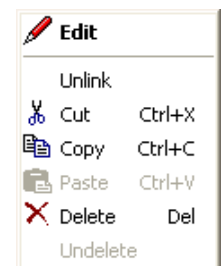

Figure 136 Comment context menu

Monitors

Monitor points are added to a wiring diagram by click-dragging them from the Function Block tree onto the diagram. A monitor shows the current value (updated at the iTools parameter list update rate) of the parameter to which it is linked. By default the name of the parameter is shown. To hide the parameter name either double click on the monitor box or 'Show Names' in the context (right-click) menu can be used to toggle the parameter name on and off.

Monitors are linked to function blocks and wires by clicking on the chain icon at the bottom right-hand corner of the box and then clicking again on the required parameter. A dashed line is drawn to the top of the block or the selected wire segment.

Note: Once the monitor has been linked, the Chain icon disappears. It re-appears when the mouse cursor is hovered over the bottom right-hand corner of the monitor box

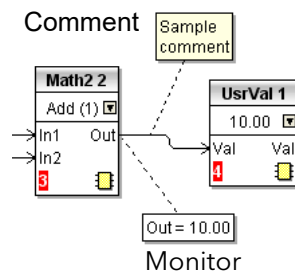

Figure 137 Comment and Monitor appearance

Monitor Context Menu

Show names	Toggles parameter names on and off in the monitor box.
Unlink	Deletes the current link from the monitor.
Cut	Moves the monitor to the Clipboard, ready to be pasted elsewhere. Short cut = <Ctrl>+<X>.
Copy	Copies the monitor from the wiring diagram to the Clipboard, ready to be pasted elsewhere. Short cut = <Ctrl>+<C>.
Paste	Copies a monitor from the Clipboard to the wiring diagram. Short cut = <Ctrl>+<V>.
Delete	Marks the monitor for deletion at next download.
Undelete	Undoes the Delete command if download has not taken place since.
Bring to Front	Moves the item to the 'top' layer of the diagram.
Push to Back	Moves the item to the 'bottom' layer of the diagram.
Parameter Help	Shows parameter help for the item.

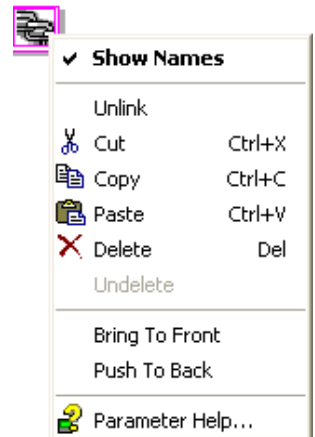

Figure 138 Monitor context menu

Downloading

When the wiring editor is opened the current wiring and diagram layout is read from the instrument. No changes are made to the instrument function block execution or wiring until the download button is pressed. Any changes made using the operator interface after the editor is opened are lost on download.

When a block is dropped onto the diagram, instrument parameters are changed to make the parameters for that block available. If changes are made and the editor is closed without saving them there is a delay while the editor clears these parameters.

During download, the wiring is written to the instrument which then calculates the block execution order and starts executing the blocks. The diagram layout including comments and monitors is then written into instrument flash memory along with the current editor settings. When the editor is reopened, the diagram is shown positioned as it was when it was last downloaded.

Colors

Items on the diagram are colored as follows:

Red	Items which totally or partially obscure other items and items which are totally or partially obscured by other items. Wires that are connected to unalterable or non-available parameters. Execution breaks. Block execution orders for Task 1.
Blue	Non-available parameters in function blocks. Block execution orders for Task 4. Task breaks.
Green	Items added to the diagram since last download are shown as green dashed lines. Block execution orders for Task 2.
Magenta	All selected items, or any item over which the cursor is hovering.
Purple	Red wires when being hovered over by the mouse cursor.
Black	All items added to the diagram before the last download. Block execution orders for Task 3. Redundant execution breaks. Monitor and comment text.

Diagram Context Menu

Cut	Active only when the right click occurs within the bounding rectangle which appears when more than one item is selected. Moves the selection off the diagram to the Clipboard. Short cut = <Ctrl>+<X>.
Copy	As for 'Cut', but the selection is copied, leaving the original on the diagram. Short cut = <Ctrl>+<C>.
Paste	Copies the contents of the Clipboard to the diagram. Short cut = <Ctrl>+<V>.
Re-Route wires	Reroutes all selected wires. If no wires are selected, all wires are re-routed.
Align Tops	Aligns the tops of all blocks in the selected area.
Align Lefts	Aligns the left edges of all blocks in the selected area.
Space Evenly	Spaces selected items such that their top left corners are spaced evenly across the width of the diagram. Click on the item which is to be the left-most item, then <Ctrl>+<left click> the remaining items in the order in which they are to appear.
Delete	Marks the item for deletion at next download time. Can be 'Undeleted' up until download occurs.
Undelete	Reverses the action of 'Delete' on the selected item.
Select All	Selects all items on the current diagram.
Create Compound	Active only when the right click occurs, in the top level diagram, within the bounding rectangle which appears when more than one item is selected. Creates a new wiring diagram as described in 'Compound', below.
Rename	Allows a new name to entered for the current wiring diagram. This name appears in the relevant tab.
Copy Graphic	Copies the selected items (or the whole diagram if no items are selected) to the clipboard as a Windows metafile, suitable for pasting into a documentation application. Wiring entering/leaving the selection (if any) are drawn in tag mode.
Save Graphic...	As for 'Copy Graphic' above, but saves to a user-specified file location instead of the clipboard.
Copy Fragment To File...	Copies selected items to a user-named file in folder 'My iTools Wiring Fragments' located in 'My Documents'.

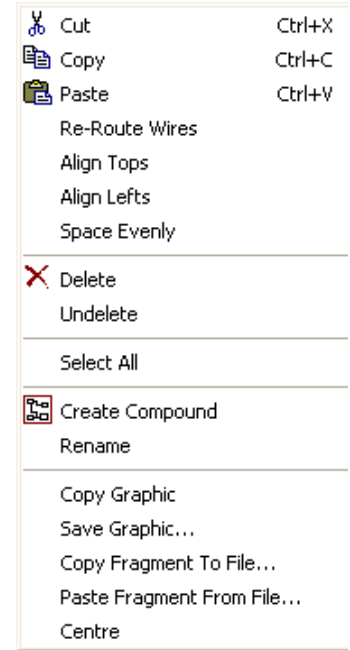

Figure 139 Diagram context menu

Paste Fragment From File	Allows the user to select a stored fragment for inclusion in the wiring diagram.
Centre	Places the display window at the centre of the selected items. If 'Select All' has previously been clicked-on, then the display widow is placed over the centre of the diagram.

Compounds

Compounds are used to simplify the top level wiring diagram, by allowing the placing of any number of function blocks within one 'box', the inputs and outputs of which operate in the same way as those of a normal function block.

Each time a compound is created, a new tab appears at the top of the wiring diagram. Initially compounds and their tabs are named 'Compound 1', 'Compound 2', etc. but they can be renamed by right clicking either on the compound in the top level diagram, or anywhere within an open Compound, selecting 'Rename' and typing in the required text string (16 characters max.).

Compounds cannot contain other compounds (i.e. they can be created only in the top level diagram).

Compound creation

1. Empty compounds are created within the top level diagram by clicking on the 'Create Compound' toolbar icon.
2. Compounds can also be created by highlighting one or more function blocks in the top level diagram and then clicking on the 'Create Compound' toolbar icon. The highlighted items are moved from the top level diagram into a new compound.
3. Compounds are 'uncreated' (flattened), by highlighting the relevant item in the top level menu and then clicking on the 'Flatten Compound' toolbar icon. All the items previously contained within the compound appear on the top level diagram.
4. Wiring between top level and compound parameters is carried out by clicking on the source parameter, then clicking on the compound (or the compound tab) and then clicking on the destination parameter. Wiring from a compound parameter to a top level parameter or from compound to compound is carried out in similar manner.
5. Unused function blocks can be moved into compounds by dragging from the tree view. Existing blocks can be dragged from the top level diagram, or from another compound, onto the tab associated with the destination compound. Blocks are moved out of compounds to the top level diagram or to another compound in a similar way. Function blocks can also be 'cut and pasted'.
6. Default compound names (e.g. 'Compound 2') are used only once, so that if, for example, Compounds 1 and 2 have been created, and Compound 2 is subsequently deleted, then the next compound to be created will be named 'Compound 3'.
7. Top level elements can be click-dragged into compounds.

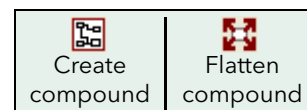

Tool Tips

Hovering the cursor over the block displays 'tooltips' describing that part of the block beneath the cursor. For function block parameters the tooltip shows the parameter description, its OPC name, and, if downloaded, its value. Similar tooltips are shown when hovering over inputs, outputs and over many other items on the iTools screen.

A Function Block is enabled by dragging the block onto the diagram, wiring it, and finally downloading it to the instrument. Initially blocks and associated wires are drawn with dashed lines, and when in this state the parameter list for the block is enabled but the block is not executed by the instrument.

The block is added to the instrument function block execution list when the 'Download' icon is operated and the items are redrawn using solid lines.

If a block which has been downloaded is deleted, it is shown on the diagram in a ghosted form until the download button is pressed. (This is because it and any wires to/from it are still being executed in the instrument. On download it will be removed from the instrument execution list and the diagram.) A ghosted block can be 'undeleted' as described in 'Context menu', above.

When a dashed block is deleted it is removed immediately.

Parameter Explorer

This view is displayed:

1. by clicking on the 'Parameter Explorer' toolbar icon,  Parameter Explorer
2. by double clicking on the relevant block in the tree pane or in the Graphical Wiring Editor
3. by selecting 'Function Block View' from the Function block context menu in the Graphical Wiring Editor.
4. by selecting 'parameter Explorer from the 'View' menu
5. by using the short cut <Alt>+<Enter>

In each case the function block parameters appear in the iTools window in tabular form, such as the example in Figure 140.

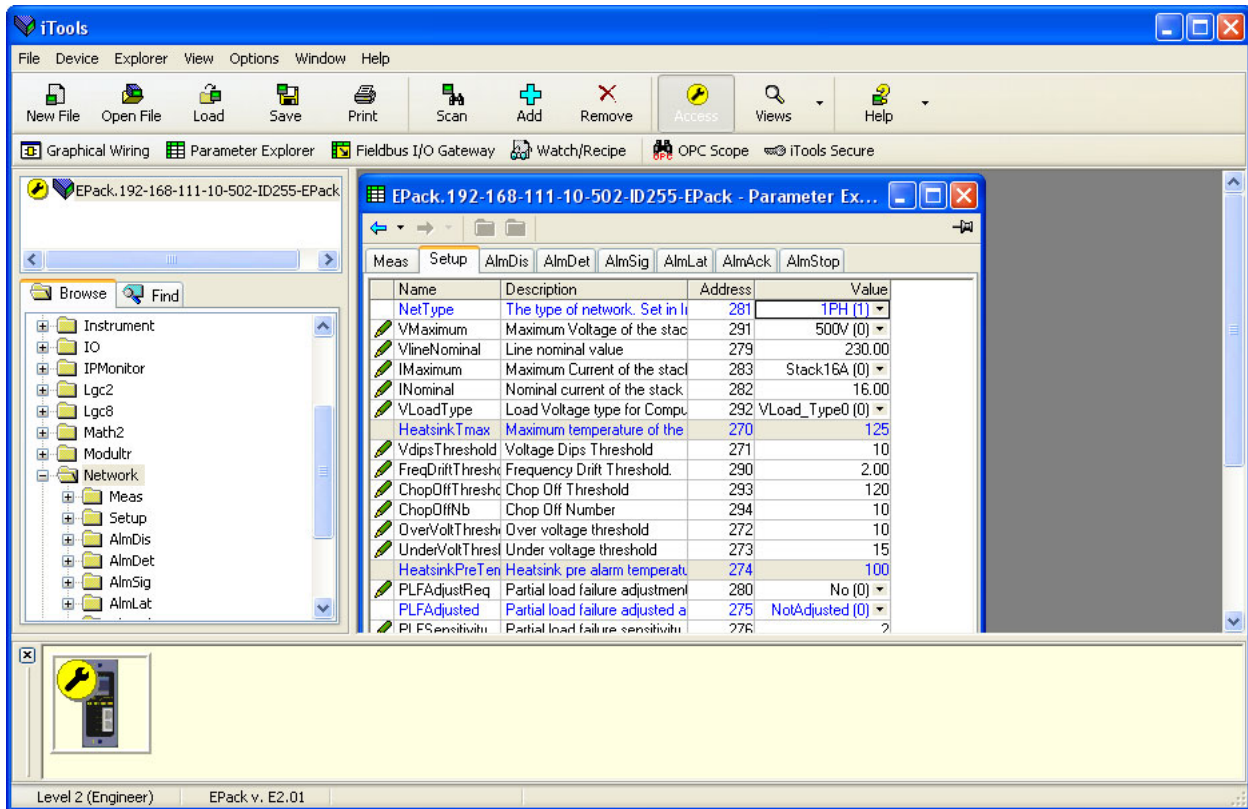

Figure 140 Parameter table example

The figure above shows the default table layout. Columns can be added/deleted from the view using the 'Columns' item of the Explorer or context menus (Figure 141).

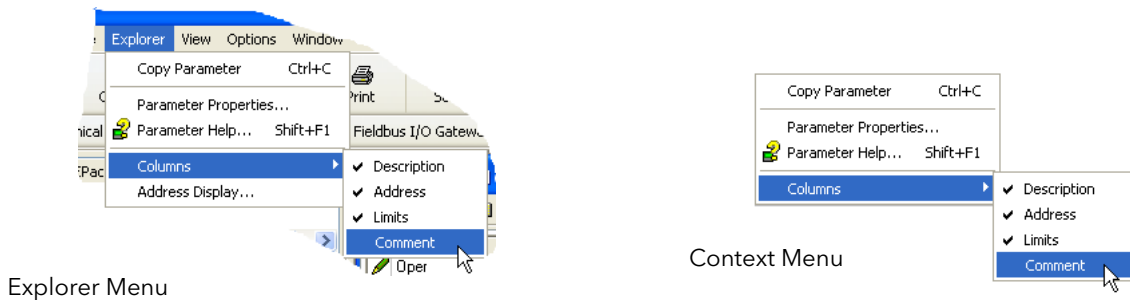

Figure 141 Column enable/disable

Parameter Explorer Detail

Figure 142 shows a typical parameter table. This function block has a number of subfolders associated with it for the configuration (setup) and for the alarms. Each of these is represented by a 'tab' across the top of the table.

Name	Description	Address	Value	Low Limit	High Limit
Frequency	Frequency of the line	267	0.00	-10000000000.00	10000000000.00
Vline	Line voltage measurement	256	0.00	-10000000000.00	10000000000.00
I	Irms of the load	257	0.00	-10000000000.00	10000000000.00
IsqBurst	Average square value of load	258	0.00	-10000000000.00	10000000000.00
Isq	Square value of the load curri	259	0.00	-10000000000.00	10000000000.00
V	Vrms of the load	260	0.00	-10000000000.00	10000000000.00
VsqBurst	Average square value of the	268	0.00	-10000000000.00	10000000000.00
Vsq	Square value of load voltage	261	0.00	-10000000000.00	10000000000.00
PBurst	True Power measurement in	262	0.00	-10000000000.00	10000000000.00
P	True power measurement.	263	0.00	-10000000000.00	10000000000.00
S	Apparent power measuremer	264	0.00	-10000000000.00	10000000000.00
PF	Power Factor	265	0.00	-10000000000.00	10000000000.00
Z	Load impedance	266	0.00	-10000000000.00	10000000000.00
HtSink Temp	Heatsink 1 temperature	269	0.00	-10000000000.00	10000000000.00

Figure 142 Typical parameter table

Notes:

- Parameters in blue are non-editable (Read only). In the example above all the parameters are read only. Read/write parameters are in black and have a 'pencil' symbol in the 'read/Write access column at the left edge of the table. A number of such items are shown in Figure 140, above.
- Columns. The default explorer window (Figure 140) contains the columns 'Name', 'Description', 'Address' and 'Value'. As can be seen from Figure 143, above, the columns to be displayed can be selected, to a certain extent, using either the 'Explorer' menu or the context menu. 'Limits' have been enabled for the example above.
- Hidden Parameters. By default, iTools hides parameters which are considered irrelevant in the current context. Such hidden parameters can be shown in the table using the 'Parameter availability' settings item of the options menu (Figure 143). Such items are displayed with a shaded background.
- The full pathname for the displayed parameter list is shown at the bottom left hand corner of the window.

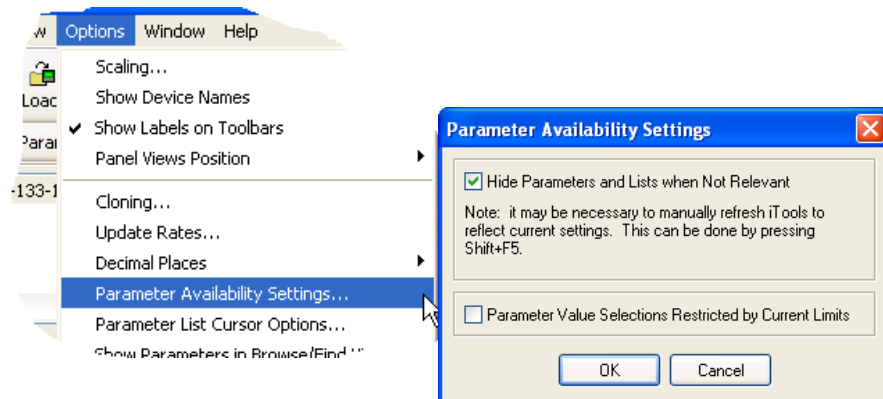

Figure 143 Show/Hide parameters

Explorer Tools

A number of tool icons appear above the parameter list:



Back to: and Forward to:



The parameter explorer contains a history buffer of up to 10 lists that have been browsed in the current instance of the window. The 'Back to: (list name)' and 'Forward to: (list name)' icons allow easy retracing or repeating of the parameter list view sequence. If the mouse cursor is hovered over the tool icon, the name of the parameter list which will appear if the icon is clicked-on appears. Clicking on the arrow head displays a pick list of up to 10 previously visited lists which the user can select. Short cut = <Ctrl>+ for 'Back to' or <Ctrl>+<F> for 'Forward to'.



Go Up a Level, Go Down a Level. For nested parameters, these buttons allow the user to navigate 'vertically' between levels. Short cut = <Ctrl>+<U> for 'Go



Up a Level' or <Ctrl>+<D> for 'Go Down a Level'.



Push pin to give the window global scope. Clicking on this icon causes the current parameter list to be permanently displayed, even if another instrument becomes the 'current device'.



Context Menu

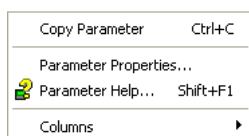

Copy Parameter

Copies the clicked-on parameter to the clipboard

Parameter properties

Displays parameter properties for the clicked-on parameter

Parameter Help...

Displays help information for the clicked-on parameter

Fieldbus Gateway Fieldbus I/O Gateway

At commissioning when configuring I/O gateway it is NOT recommended to add the parameters 'Goto' and 'Passcode' in the list of data exchange, as CommsPassword will NOT be required before elevation of privilege (e.g. from operator mode to configuration mode).

WARNING

UNINTENDED EQUIPMENT OPERATION

- At commissioning, ensure cybersecurity robustness of the installation.

Failure to follow these instructions can result in death, serious injury or equipment damage.

To minimize any potential loss of control when communicating across a network via a third-party device (i.e. controller, PLC or configuration tool), ensure all system hardware, software and network design are correctly configured and commissioned for maximum cybersecurity robustness.

E-Pack controller units contain a great number of parameters, so it is necessary for the user to define which Input and Output parameters are to be available for block read and write. The Input/Output definitions are configured using the 'Fieldbus I/O Gateway'.

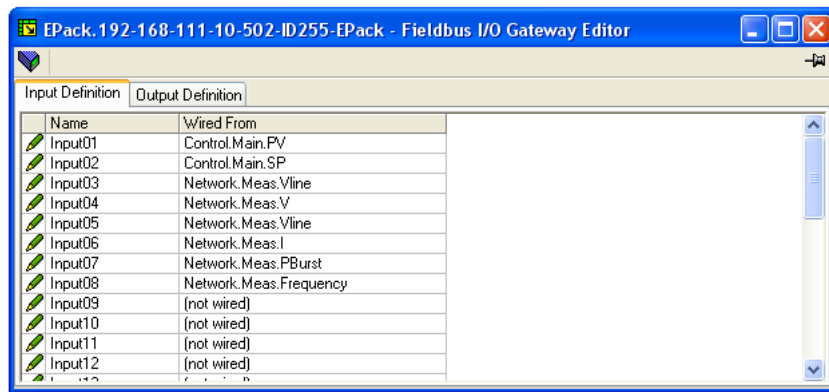

Figure 144 Typical Fieldbus Gateway Parameter list

As shown in Figure 144, there are two tabs within the editor, called 'Input definition' and 'Output definition'. 'Inputs' are values sent from the controller to the master. 'Outputs' are values received from the master and used by the controller, (e.g. set points written from the master).

The procedure for selecting variables is the same for both input and output definition tabs:

1. Double click the next available position in the input or output data table and select the variable to assign to it. A pop-up (Figure 145) provides a browser from which a list of parameters can be opened.

2. Double click the parameter to assign it to the input definition.

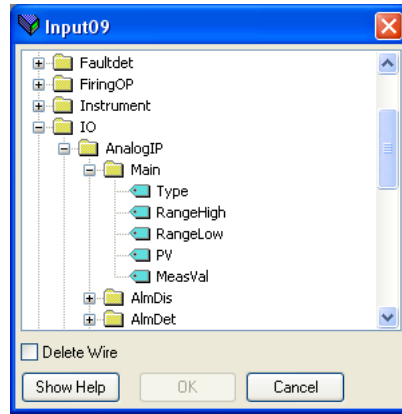

Figure 145 Browser window

Notes:

1. By setting the same parameter contiguously (e.g. main.sp for inputs 2 and 3) the data will be sent in IEEE format.
2. The Master must request the same number of parameters as there are in the table.
3. The tables are saved to Flash memory when the user quits configuration mode and returns to Operator mode.

When all the required parameters have been added to the lists, notes of how many 'wired' entries are included in the input and output areas should be made as this information is needed when setting up the Master.

Notes:

1. A maximum of 32 input and 16 output parameters may be set using the Gateway Editor.
2. No checks are made that output variables are writeable, and if a read only variable is included in the output list any values sent to it will be ignored with no indication.
3. For Modbus only:
As shown in Figure 146, 'Block Read' and 'Block Write' requests both access the same memory location (Dec:4744; hex:1288), which 'points' to the relevant input definition table or output definition table according to whether the instruction is a read or a write. The value for a parameter in the input table may differ from the value of the same parameter in the output table.

Once the changes have been made to the Input and Output definition lists, they must be downloaded to the controller unit. This is done (for both tables simultaneously) by clicking on the 'Update device Flash Memory' button on the top left of the Fieldbus Gateway Editor window. The controller performs a restart after this operation.

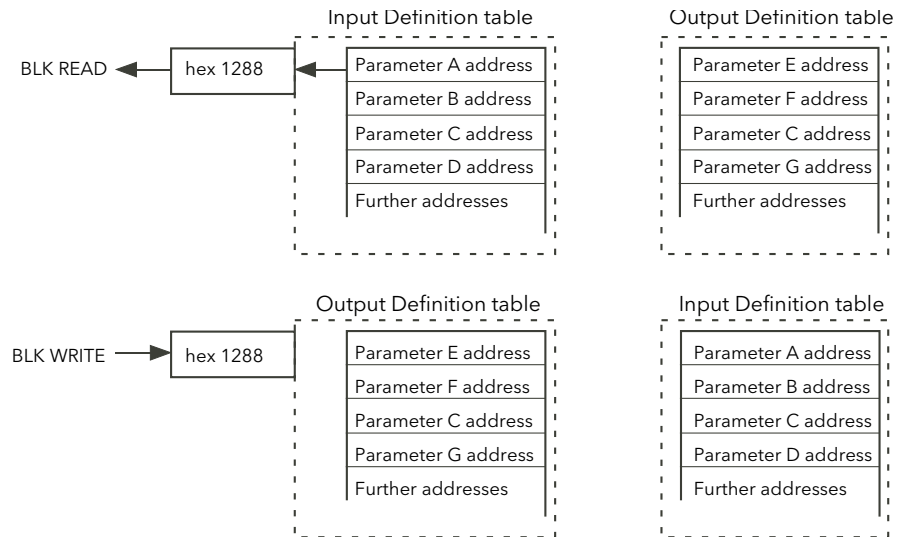

Figure 146 Block read and block write (note 3)

Watch/Recipe Editor Watch/Recipe

The watch/recipe editor is opened by clicking on the Watch/Recipe tool icon, by selecting 'Watch/Recipe' in the 'Views' menu or by using the short cut <Ctrl>+<A>. The window is in two parts: the left part containing the watch list; the right-hand part containing one or more data sets, initially empty and unnamed.

The Watch/Recipe window is used:

1. To monitor a list of parameters. This list can contain parameters from many different, and otherwise unrelated parameter lists within the same device. It cannot contain parameters from different devices.
2. To create 'data sets' of parameter values which can be selected and downloaded to the device in the sequence defined in the recipe. The same parameter may be used more than once in a recipe.

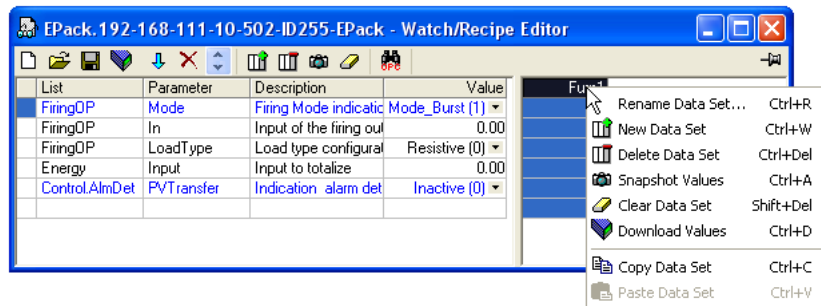



Figure 147 Watch/Recipe Editor window (with context menu)

Creating a Watch List

After opening the window, parameters can be added to it as described below. The values of the parameters update in real-time, allowing the user to monitor a number of values simultaneously.

Adding Parameters to the Watch List

1. Parameters can be click-dragged into the watch list from another area of the iTools window (for example, the parameter explorer window, the graphical wiring editor, the browse tree). The parameter is placed either in an empty row at the bottom of the list, or if it is dragged on top of an already existing parameter, it is inserted above this parameter, with the remaining parameters being moved down one place.
2. Parameters can be dragged from one position in the list to another. In such a case, a copy of the parameter is produced, the source parameter remaining in its original position.
3. Parameters can be copied <Ctrl>+<C> and pasted <Ctrl>+<V> either within the list, or from a source external to it, for example the parameter browse window or the Graphical Wiring Editor.
4. The 'Insert item...' tool button  the 'Insert Parameter' item in the Recipe or context menu or the short cut <Insert> can be used to open a browse window from which a parameter is selected for insertion above the currently selected parameter.

Data Set Creation

Once all the required parameters have been added to the list, select the empty data set by clicking on the column header. Fill the data set with current values using one of the following methods:

1. Clicking on the 'Capture current values into a data set' tool icon  (also known as the 'Snapshot Values' tool).
2. Selecting 'Snapshot Values' from the Recipe or Context (right-click) menu.
3. Using the short cut <Ctrl>+<A>.

Individual data values can now be edited by typing directly into the grid cells. Data values can be left blank or cleared, in which case, no values will be written for those parameters at download. Data values are cleared by deleting all the characters in the cell then either moving to a different cell or typing <Enter>.

The set is called 'Set 1' by default, but it can be renamed by either by using the 'Rename data set...' item in the Recipe or context menus, or by using the short cut <Ctrl>+<R>.













New, empty data sets can be added using one of the following:

1. Clicking on the 'Create a new empty data set' toolbar icon. 
2. Selecting 'New Data Set' in the Recipe or context menus
3. Using the short cut <Ctrl>+<W>

Once created, the data sets are edited as described above.

Finally, once all the required data sets have been created, edited and saved, they can be downloaded the instrument, one at a time, using the Download tool, the 'Download Values' item in the Recipe or context menus, or the short cut <Ctrl>+<D>. 

Watch Recipe Toolbar Icons

-  Create a new watch/recipe list. Creates a new list by clearing out all parameters and data sets from an open window. If the current list has not been saved, confirmation is requested. Short cut <Ctrl>+<N>
-  Open an existing watch/recipe file. If the current list or data set has not been saved, confirmation is requested. A file dialog box then opens allowing the user to select a file to be opened. Short cut <Ctrl>+<O>
-  Save the current watch/recipe list. Allows the current set to be saved to a user specified location. Short cut <Ctrl>+<S>.
-  Download the selected data set to the device. Short cut <Ctrl>+<D>
-  Insert item ahead of selected item. Short cut <Insert>.
-  Remove recipe parameter. Short cut <Ctrl>+<Delete>.
-  Move selected item. Up arrow moves selected parameter up the list; down arrow move the selected parameter down the list.
-  Create a new empty data set. Short cut <Ctrl>+<W>.
-  Delete an empty data set. Short cut <Ctrl>+<Delete>
-  Capture current values into a data set. Fills the selected data set with values. Short cut <Ctrl>+<A>.
-  Clear the selected data set. Removes values from the selected data set. Short cut <Shift>+<Delete>.
-  Open OPC Scope. Opens a separate utility that allows trending, data logging and Dynamic Data Exchange (DDE). OPC Scope is an OPC explorer program that can connect to any OPC server that is in the windows registry. (OPC is an acronym for 'OLE for Process Control, where OLE stands for 'Object Linking and Embedding'.)

Watch/Recipe Context Menu

The Watch/Recipe Context menu items have the same functions as described above for toolbar items.

Parameter Addresses (Modbus)

Introduction

The iTools address fields display each parameter's Modbus address to be used when addressing integer values over the serial communications link. In order to access these values as IEEE floating point values, the calculation: IEEE address = {(Modbus address x 2) + hex 8000} should be used.

Notes:

1. Certain parameters may have values which exceed the maximum value that can be read from or written to using a 16-bit integer communications. Such parameters have a scaling factor applied to them as described in Parameter Scaling.
2. When using 16-bit scaled integer Modbus addressing, time parameters can be read from or written to in 10ths of minutes, or in 10ths of seconds as defined in the parameter [Instrument.config.TimerRes](#).

Parameter Types

The following parameter types are used:

bool	Boolean
uint8	Unsigned 8-bit integer
int16	Signed 16-bit integer
uint16	Unsigned 16-bit integer
int32	Signed 32-bit integer
uint32	Unsigned 32-bit integer
time32	Unsigned 32-bit integer (time in milliseconds)
float32	IEEE 32-bit floating point
string	String - an array of unsigned 8-bit integers.

Parameter Scaling

Some parameters might have values which exceed the maximum value (32767) that can be read/written via 16-bit scaled integer comms. Such parameters are assigned a scaling factor as described in "[Scaling Factor](#)" on page 166.

Parameter List

The full list of parameters available via the communications link is to be found in the SCADA table supplied as a part of the iTools help system. Individual parameter addresses also appear in each iTools configuration page along with 'enumerations' showing all the possible values that the parameter can take.

To display the parameters list load the Parameter Help file (*Phelp_Epack_Vx.xx.chm*) from the iTools menu;

1. Select Help, Device Help from the iTools menu bar.
2. The Parameter Help file will display.
3. Select the topic Scada from the Content tab.
4. Scroll to the heading List of Parameters in the main window, click EPack parameters.

The EPack Parameters table will be displayed.

Alarms

DANGER

HAZARD OF ELECTRICAL SHOCK, EXPLOSION OR ARC FLASH

- Use appropriate safety interlocks where personnel and/or equipment hazards exist.

Failure to follow these instructions will result in death or serious injury.

EPack alarms protect thyristors and loads against abnormal operation, and provide the user with valuable information regarding the type of fault.

Under no circumstances must these alarms be regarded as a replacement for proper personnel protection.

Global System Monitoring

At power-up and in running for some functionalities EPack performs a check of most of electronic parts (power supply, digital memory, and so on). In case of failure, EPack reports a status in the Global Status Parameters available using communication and displays a message on its front fascia.

There are four types of message described below:

- The first one is related to a detected failure on displays microcontroller board and EPack displays 'CONFIG ERROR'. For this kind of problem it is recommended to send the unit back to a repair center. EPack also displays a code in hexadecimal for a technician. This code is also available in decimal through iTools in Global Status 0.
- The second one reports issues related to a hardware problem detected by the microcontroller. Issues can be located on the different boards. In this situation EPack displays 'HW Problem'. For this kind of problem it is recommended to send the unit back to a repair center or contact your local representative. EPack also displays a code in hexadecimal for a technician. This code is also available in decimal through iTools in Global Status 1.
- The third one is more related to configuration data set on production line, or during upgrade. In this case EPack displays 'INVALID DATA'. For this kind of problem it is recommended to send the unit back to a repair center. EPack also displays a code in hexadecimal for a technician. This code is also available in decimal through iTools in Global Status 2.
- The fourth one concerns detection of an internal malfunction mainly on the display microcontroller board. For this event EPack displays 'INTERNAL FAILURE'. For this kind of problem it is recommended to send the unit back to a repair center. EPack also displays a code in hexadecimal for a technician. This code is also available in decimal through iTools in Global Status 3.

System Alarms

System alarms are considered to be 'Major Events' which help prevent proper operation of the system, and the unit is placed in standby mode.

The following subsections describe each of the possible system alarms.

Missing mains

Supply power is missing.

Thyristor short circuit

A thyristor short circuit leads to current flow even when not firing.

Over temperature

Reserved for future development.

Network dips

This detects a reduction in supply voltage, and if this reduction exceeds a configurable measured value (VdipsThreshold), firing will be inhibited until the supply voltage returns to a suitable value. VdipsThreshold represents a percentage change in supply voltage between successive half cycles

Mains frequency fault detected

Triggered if the supply voltage frequency strays out of the range 47 to 63Hz, or if the mains frequency changes, for one cycle to the next, by more than the threshold defined in the Network

Chop Off alarm

Chop-off alarm will be active when a current threshold is exceeded for more than a pre-defined number of mains periods. This current threshold is user-adjustable from 100% to 350% of unit's nominal current. (to be found in the Network.setup area of configuration "[Network Setup configuration](#)" on page 182.

Process Alarms

Process Alarms are related to the application and can be configured either to stop the unit firing (Standby Mode) or to allow operation to continue. Process alarms can also be configured to be latched and if so, they have to be acknowledged before the alarm is considered to be non-active. Alarms cannot be acknowledged until the trigger source has returned to a non-active state.

Total Load Failure (TLF)

No load is connected.

Closed Loop alarm

Closed loop break alarm is currently active.

External input alarm

The external input alarm associated with the alarm block is active.

Over current detection

The analog input over current detection alarm is active.

Over Voltage Alarm

An 'OverVoltThreshold' can be configured in the Network.Setup area of configuration ("[Network Setup configuration](#)" on page 182) as a percentage of VLineNominal. If the VLine voltage rises above this threshold the OverVoltage alarm is set.

Note: This Alarm is returned FALSE if the MissingMains Alarm is set.

Under Voltage Alarm

An 'UnderVoltThreshold' can be configured in the Network.Setup area of configuration ("[Network Setup configuration](#)" on page 182) as a percentage of VLineNominal. If the VLine voltage falls below this threshold the UnderVoltage alarm is set.

Note: This Alarm is returned FALSE if the MissingMains Alarm is set.

Partial Load Failure (PLF)

This alarm detects a static increase in load impedance by comparing the reference load impedance (as configured by the user) with the actual measured load impedance over a mains cycle (for phase angle firing) and over the burst period (for burst and logic firing).

Non-inductive loads, for example resistance furnaces, resistive loads with low temperature coefficient or short wave infrared loads can be monitored using this function. For other load types, for example AC51 slightly inductive loads or AC56a primary of transformer, please consult Eurotherm.

The sensitivity of the partial load failure measurement can be set to any value between 2 to 6 inclusive, where an entry of 2, for example, means that one half of the elements (or more) must be open circuit in order to trigger the alarm; an entry of 3 means that one third of the elements (or more) must be open circuit in order to trigger the alarm, and so on down to one sixth. All elements must have identical characteristics and identical impedance values and must be connected in parallel).

The relevant parameters (PLFAdjustReq, and PLFSensitivity) are both to be found in

Indication Alarms

Indication Alarms signal events for operator action if required. Indication alarms cannot be configured to stop power module firing, but they may be latched if required, and if latched, they must be acknowledged for the Signalling Status to return to the normal (non-alarm) state.

Load Over-Current

Indicates when a configurable RMS load current threshold (Overlthreshold) is reached or exceeded.

Maintenance

Precautions

DANGER

HAZARD OF ELECTRICAL SHOCK, EXPLOSION OR ARC FLASH

- Apply appropriate personal protective equipment (PPE) and follow safe electrical work practices. See applicable national standards e.g. NFPA70E, CSA Z462, BS 7671, NFC 18-510.
- This equipment must only be installed and serviced by qualified electrical personnel.
- Refer to manual for installation and servicing.
- The product is not suitable for isolation applications, within the meaning of EN60947-1 Turn off all power supplying this equipment before working on the loads of the equipment.
- Turn off all power supplying this equipment before working on equipment.
- Always use a properly rated voltage sensing device to confirm power is off.
- Do not disassemble, repair or modify the equipment. Contact your supplier for repair.
- This product must be installed, connected and used in compliance with prevailing standards and/or installation regulations.

Failure to follow these instructions will result in death or serious injury.

Reasonable use and responsibility

The information contained in this manual is subject to change without notice. While every effort has been made to ensure the accuracy of the information, your supplier shall not be held liable for errors contained herein.

EPack is an “AC semiconductor controllers for non-motor loads” designed according to IEC60947-4-3 & UL60947-4-1, it meets the requirements of the Low voltage and EMC European Directives which covers safety and EMC aspects.

Use in other applications, or failure to observe the installation instructions of this manual may impair safety or EMC.

The safety and EMC of any system incorporating this product is the responsibility of the assembler/installer of the system.

Failure to use approved software/hardware with our hardware products may result in injury, harm, or improper operating results.

Eurotherm shall not be held responsible for any damage, injury, losses or expenses caused by inappropriate use of the product (EPack), or failure to comply with these instructions.

Under some circumstances, the EPack heatsink temperature may rise by more than 50°C and it can take up to 15 minutes to cool after the product is shut down.

 CAUTION
<p>HOT SURFACE RISK OF BURNS</p> <ul style="list-style-type: none"> • Allow heatsink to cool before servicing. • Do not allow flammable or heat-sensitive parts in the immediate vicinity of heatsink. <p>Failure to follow these instructions can result in injury or equipment damage.</p>

Preventive Maintenance

 DANGER
<p>HAZARD OF ELECTRICAL SHOCK, EXPLOSION OR ARC FLASH</p> <ul style="list-style-type: none"> • Tighten all connections in conformance with the torque specifications. Periodic inspections are required. <p>Failure to follow these instructions will result in death or serious injury.</p>

See Table 1, "Connection Details" on page 39.

Wires are not properly retained in terminals with insufficient torque.

Insufficient torque may increase the contact resistance:

- The protective earth ground connection may be too resistive. In case of short circuit between live parts and heatsink, the heatsink may reach a dangerous voltage.
- The power terminals will overheat.

Excessive torque may damage the terminal.

 DANGER
<p>HAZARD OF ELECTRICAL SHOCK, EXPLOSION OR ARC FLASH</p> <ul style="list-style-type: none"> • Do not allow anything to fall through the case apertures and ingress the product. <p>Failure to follow these instructions will result in death or serious injury.</p>

Conductive or non-conductive parts which ingress product may reduce or short the insulations barriers inside the product.

 DANGER
<p>HAZARD OF FIRE</p> <ul style="list-style-type: none"> • Heat-sink must be cleaned regularly. Periodicity depends on the local environment, but should not exceed 1 year. <p>Failure to follow these instructions will result in death or serious injury.</p>

Fusing

DANGER

HAZARD OF FIRE

- This product does not contain any branch-circuit protection, the installer must add branch-circuit protection upstream of the unit.
- Branch circuit protection must be selected according to maximum current in each phase and must be rated in compliance with local and national regulatory requirements.

Failure to follow these instructions will result in death or serious injury.

Branch circuit protection are mandatory to protect the wiring.

- CE: branch-circuit protection must be selected according to IEC 60364-4-43 or applicable local regulations.
- UL: branch-circuit protection must be selected according to NEC article 210.20, it is necessary for compliance with National Electric Code(NEC) requirements.

DANGER

HAZARD OF ELECTRICAL SHOCK, EXPLOSION OR ARC FLASH

- High speed fuses (supplemental fuses in addition to branch circuit protective device), as listed in fusing sections, are mandatory to protect EPack against load short circuit.
- If opening of either the branch circuit protective device or the high-speed fuses (supplemental fuses) occurs, the product must be examined by suitably qualified personnel and replaced if damaged.

Failure to follow these instructions will result in death or serious injury.

The power circuit must be protected by a supplementary fuse, which should be used in conjunction with suitable fuse holders (and contact kits, if required) as shown in Table 8 or Table 9.

Note: With a supplementary fuse (high speed fuse), EPack is suitable for use on a circuit capable of delivering not more than 100kA RMS symmetrical amperes, 500 Volts Maximum (coordination Type 1).

Table 9: Details of high-speed fuses (WITHOUT microswitch) and fuse holders required for EPack with order code HSP

EPack current rating	Fuse rating	Fuse manufacturer & catalog number	Qty	Fuse body size (mm)	Fuse holder		Contact kit
					Manufacturer & catalog number	Qty	Qty
≤25A	30A or 32A	Mersen FR10GR69V30 Mersen FR10GR69V32	1	10×38	Mersen US101 or Mersen CUS101	1	0
32A	40A	Mersen FR14GR69V40 Mersen FR14GC69V40 Cooper-Bussmann FWP-40A14F		14×51	Mersen US141		
40A	50A	Mersen FR14UC69V50 Cooper-Bussmann FWP-50A14F					
50A	63A	Mersen FR22UD69V63		22×58	Mersen US221		
63A	80A	Mersen FR27UQ69V80T Mersen FR27UB10C80T		27×60	Mersen US271		
80A to 125A	200A	Mersen FR27UQ69V200T					

Table 10: Details of high-speed fuses (WITH microswitch) and fuse holders required for E-Pack with order code HSM

E-Pack current rating	Fuse rating	Fuse manufacturer & catalog number	Qty	Fuse body size (mm)	Fuse holder		Contact kit	
					Manufacturer & catalog number	Qty	Manufacturer & catalog number	Qty
≤25A	32A	Mersen FR14GR69V32T Mersen FR14GC69V32T Cooper-Bussmann FWP-32A14FI	1	14×51	Mersen US141	1	Mersen Y227928A	1
32A	40A	Mersen FR14GR69V40T Mersen FR14GC69V40T Cooper-Bussmann FWP-40A14FI						
40A	50A	Mersen FR14UD69V50T Cooper-Bussmann FWP-50A14FI						
50A	63A	Mersen FR22UD69V63T		22×58	Mersen US221		Mersen G227959A	
63A	80A	Mersen FR27UQ69V80T Mersen FR27UB10C80T		27×60	Mersen US271		Mersen E227612A	
80A & 125A	200A	Mersen FR27UQ69V200T						

DANGER

HAZARD OF ELECTRICAL SHOCK, EXPLOSION OR ARC FLASH

- Tighten all connections in conformance with the torque specifications. Periodic inspections are required.

Failure to follow these instructions will result in death or serious injury.

Unless otherwise mentioned on the side of the fuse holders, torque fuse holders terminals at 2Nm (18lb in).

Wires are not properly retained in terminals with insufficient torque. Insufficient torque may increase the contact resistance, causing the power terminals to overheat.

Excessive torque may damage the terminal.

Fuse Holders Contacts Kit

For technical specification and recommended wiring, see "Fuse Holders Contact Data (Fuse Ordering Code HSM)" on page 53.

Fuse holder dimensions

Figures 148 to 152 show dimensional details for the various fuse holders listed in Table 8 and Table 9 (not all shown to the same scale).

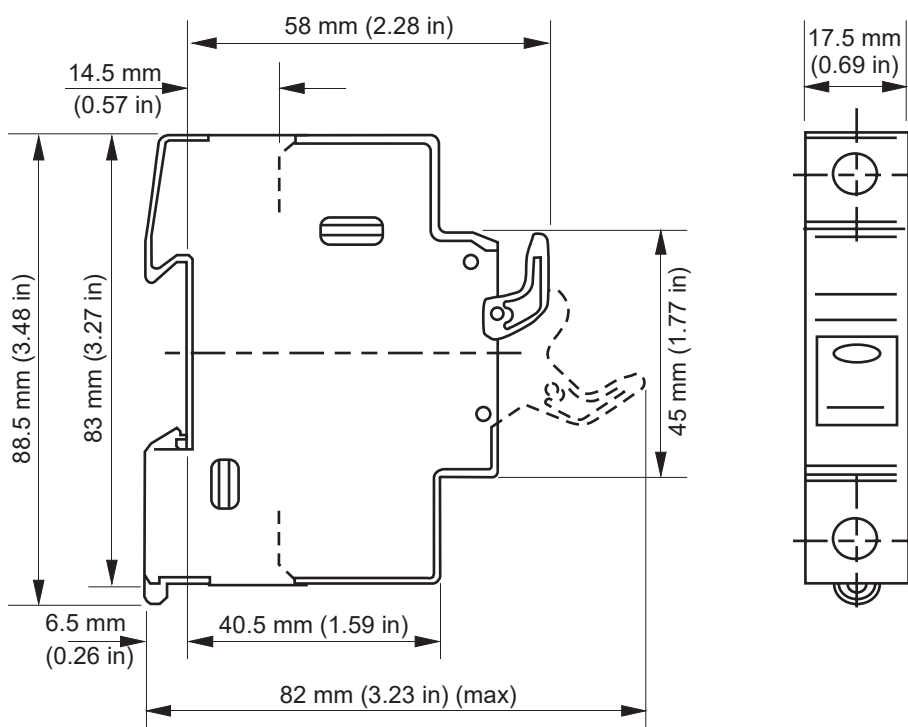

Figure 148 Fuse holder dimensions: US101 (10x38mm)

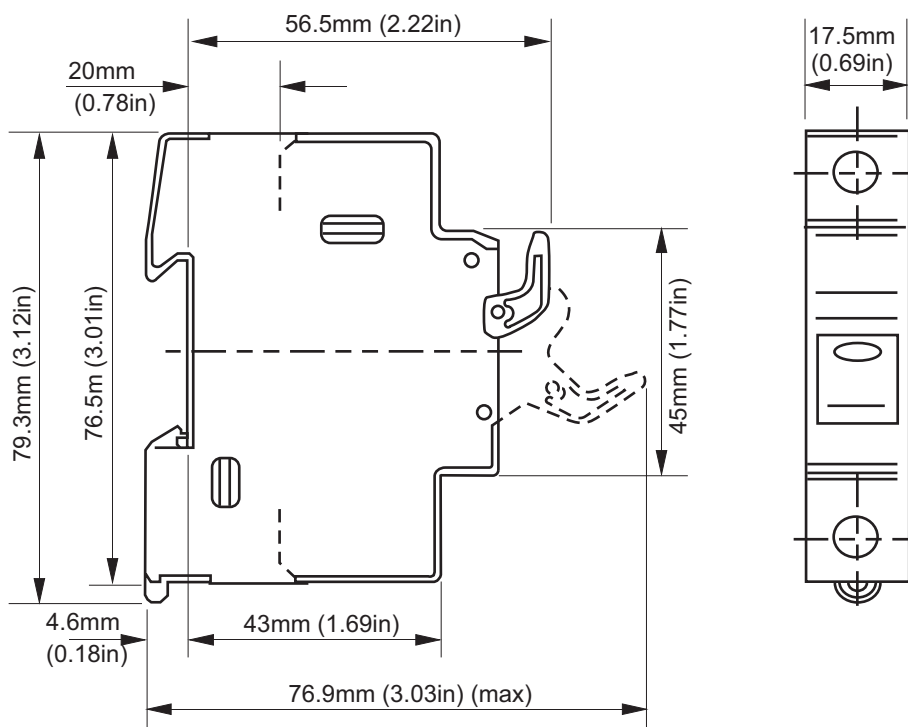

Figure 149 Fuse holder dimensions: CUS101 (10x38mm)

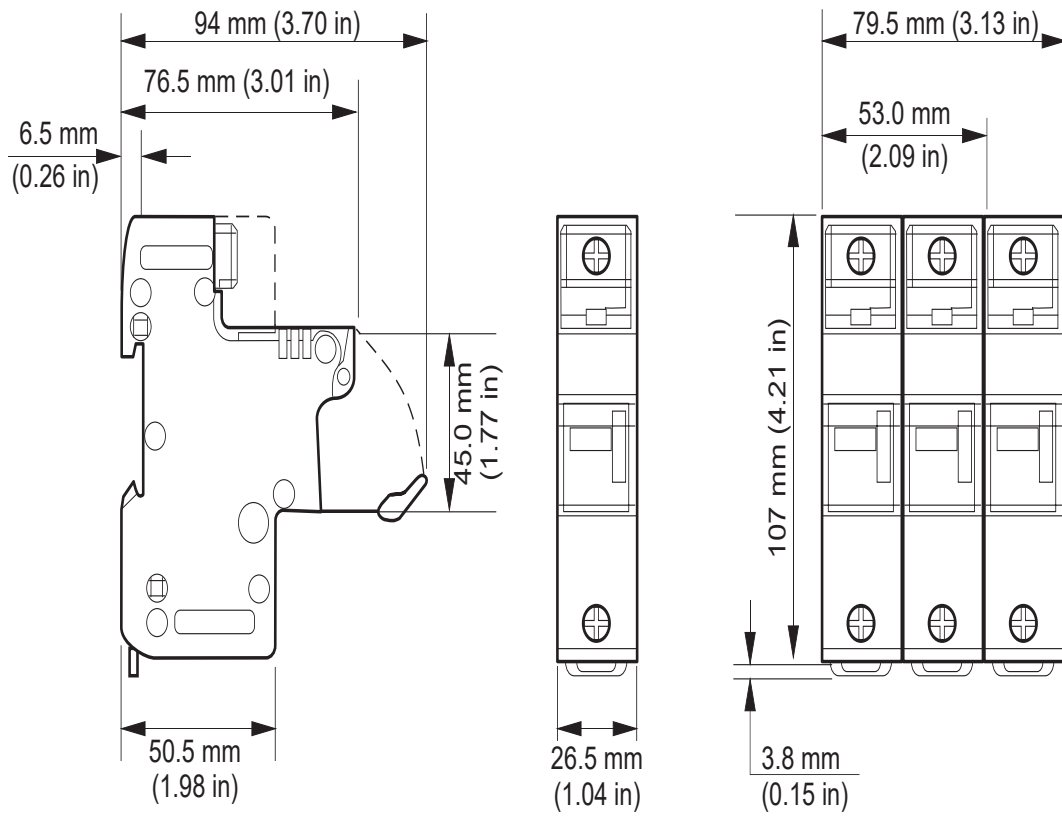

Figure 150 Fuse holder dimensions: US141 (14x51mm)

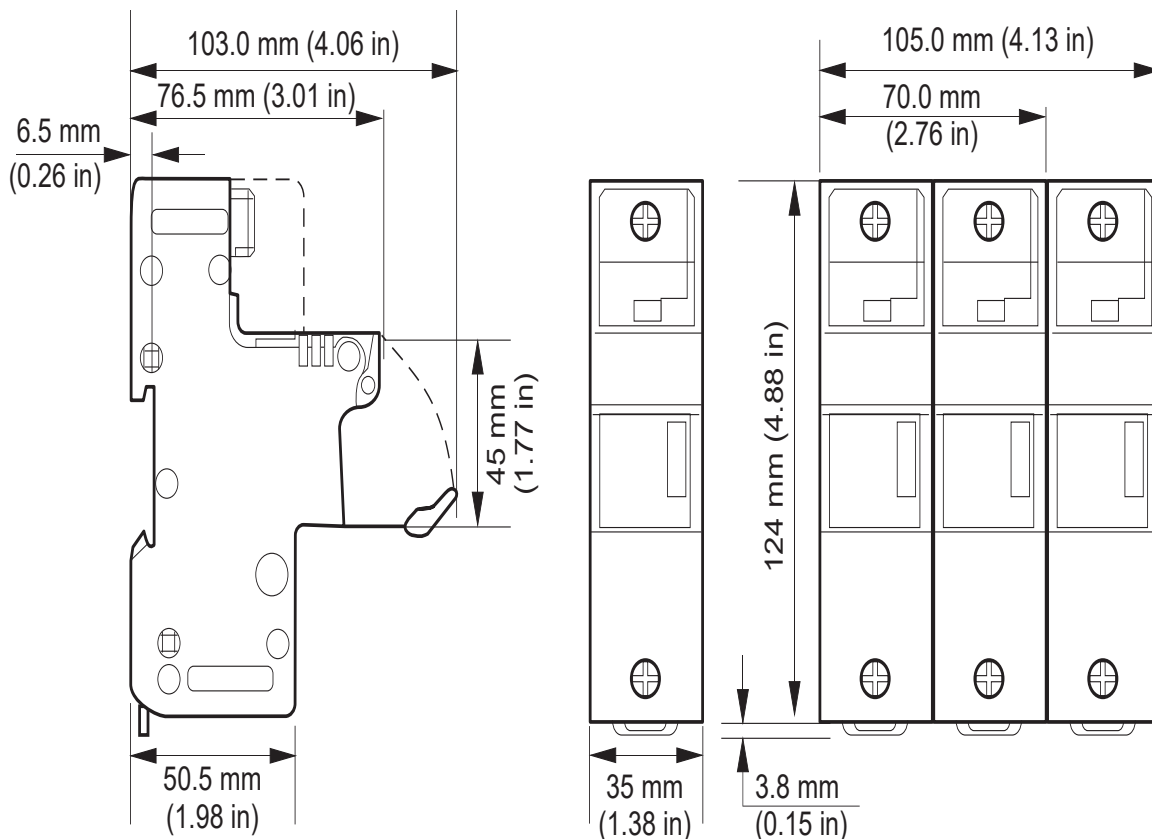

Figure 151 Fuse holder dimensions: US221 (22x58mm)

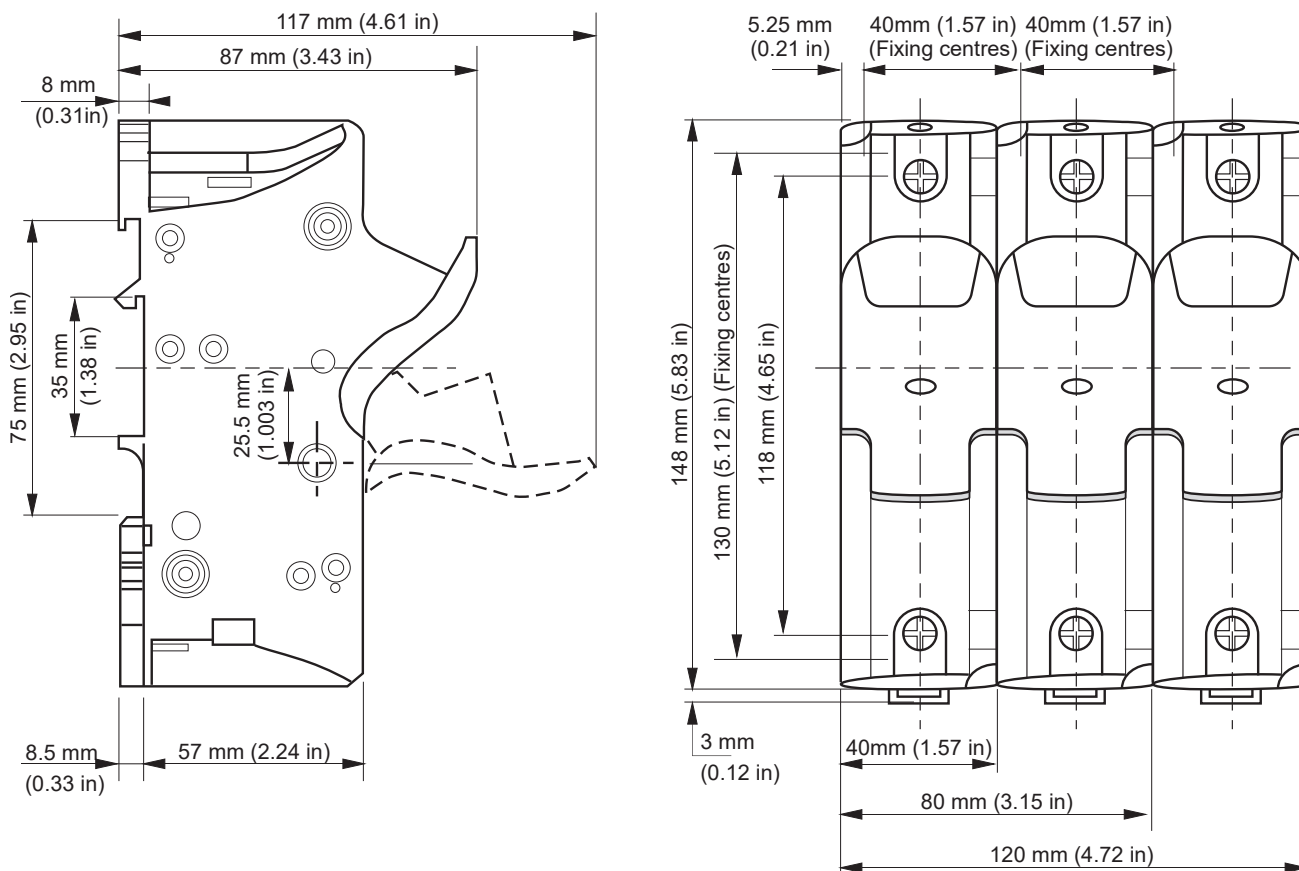

Figure 152 Fuse holder dimensions: US271 (27x60mm)

NOTICE**NORTH AMERICA REGULATIONS**

- For USA & Canada EPack 125A fuse holder terminal capacity is rated UL 1/0AWG, this may decrease the maximum Load current according to standard, ambient temperature, wiring arrangement.

Failure to follow these instructions can result in non-compliance to North America regulations.

For compliance with;

- UL508A (Industrial Control Panels) the continuous load shall not exceed 120A.

Note: As per UL508A, an ambient temperature of 40°C is assigned to all cabinet, cable stranded copper rated 90°C.

- NFPA79 (Electrical Standard for Industrial Machinery) full load current shall not exceed:
 - 125A at 35°C ambient temperature
 - 120A at 40°C ambient temperature
 - 115A at 45°C ambient temperature.

Note: According to NFPA79 sub article 12.5.2, NFPA70 (NEC) article 310.15 may be used to size conductor rated 90°C. Higher full load current may be achieved with NFPA70 (NEC) see below.

- NFPA 70 (NEC: National electric code), continuous load may be limited according to ambient temperature of the cabinet and wiring arrangement.

Note: Single-Insulated Conductors and NEC Table 310.15(B)(17) (formerly Table 310.17) may be use for continuous load up to 125A at 45°C.

Auxiliary supply fuse protection

 DANGER
HAZARD OF FIRE <ul style="list-style-type: none">The cables used to connect the EPack’s auxiliary supply and voltage reference must be protected by branch-circuit protection. Such branch-circuit protection must comply with local and national regulatory requirements. Failure to follow these instructions will result in death or serious injury.

Branch circuit protection is mandatory to protect the cable used to connect the auxiliary supply.

- CE: branch-circuit protection must be selected according to IEC 60364-4-43 or applicable local regulations.
- UL: branch-circuit protection must be selected according to NEC article 210.20, it is necessary for compliance with National Electric Code(NEC) requirements.

 DANGER
HAZARD OF ELECTRICAL SHOCK, EXPLOSION OR ARC FLASH <ul style="list-style-type: none">A High-speed fuse (supplemental fuses in addition to branch circuit protective device) or a double protection fuse as listed in fusing sections is mandatory for 85Vac to 550Vac auxiliary supply. Failure to follow these instructions will result in death or serious injury.

This fuse is necessary to avoid the 85Vac to 550Vac auxiliary supply to emit flame or molten element in case of breakdown of a component.

High-speed fuse (supplemental fuse) does not protect the wiring they must be fitted in addition to branch circuit protective device).

Double protection fuse combines a branch circuit fuse and a high-speed fuse. Double protection fuse must be selected according to applicable national standards. Branch circuit protection fuses Standard in USA/Canada differ from IEC standards (e.g; Europe (CE)). Therefore:

- A fuse approved as branch circuit protection fuses in USA/Canada is not a branch circuit in all countries where IEC standards apply (e.g; Europe (CE)).
- A fuse approved as branch circuit protection fuses in all countries where IEC standards apply (e.g; Europe (CE)) is not a branch circuit in USA/Canada.

Table 11: Auxiliary supply fuse protection

UL Fuse Category	CE Fuse Category	Fuse (Make and Type)
Supplemental fuse (Does NOT protect the wiring)	Supplemental fuse (Does NOT protect the wiring)	ATM2-type fuse rated 2A, 600Vac/dc: Mersen/Ferraz Shawmut (UL file: E33925)
Double protection fuse (Combines a Branch circuit fuse and a High-speed fuse)	Supplemental fuse (Does NOT protect the wiring)	J-type fuse rated 3A/600Vac: HSJ3 by Mersen/Ferraz Shawmut (UL file: E2137; CSA class: 1422-02 LR12636) or DFJ-3 by Eaton/Cooper Bussman (UL file: E4273; CSA class: 1422-02 LR53787)
Supplemental fuse (Does NOT protect the wiring)	Double protection fuse (Combines a Branch circuit fuse and a High-speed fuse)	gR-type fuses rated 3A /700V: FR10GR69V3 (V1014571) by Mersen/Ferraz Shawmut (UL file: E76491)

**DANGER****HAZARD OF ELECTRICAL SHOCK, EXPLOSION OR ARC FLASH**

- If opening of any fuses or branch circuit protection device that supply the 85Vac to 550Vac auxiliary supply occurs, first check the wiring. If the wiring is not damaged, do not replace the fuse and contact the manufacturer's local service center.

Failure to follow these instructions will result in death or serious injury.

If the wiring is not damaged a component inside the 85Vac to 550Vac auxiliary supply is broken and product must go back to service center.

Instrument upgrade

Instrument upgrade is done in two steps: upgrading iTools to the latest version and upgrading software.

iTools upgrade

On the www.eurotherm.com website, locate the 'Downloads' section, and click the 'Quick search' button for ITOOLS. A list of the latest available iTools software and documentation is displayed. Click on the links to download and install the latest version.

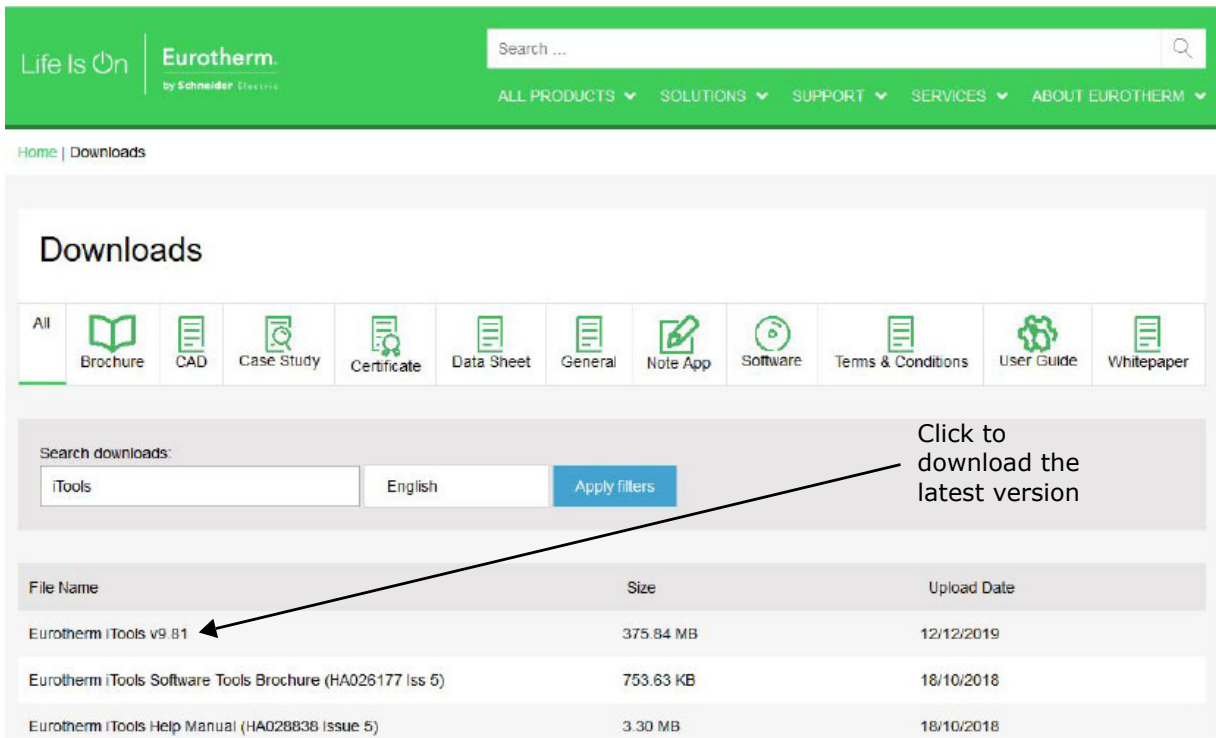

Life Is On | Eurotherm
by Schneider Electric

Search ...

ALL PRODUCTS ▾ SOLUTIONS ▾ SUPPORT ▾ SERVICES ▾ ABOUT EUROTHERM ▾

Home | Downloads

Downloads

All | Brochure | CAD | Case Study | Certificate | Data Sheet | General | Note App | Software | Terms & Conditions | User Guide | Whitepaper

Search downloads:
iTools English Apply filters

Click to download the latest version

File Name	Size	Upload Date
Eurotherm iTools v9.81	375.84 MB	12/12/2019
Eurotherm iTools Software Tools Brochure (HA026177 Iss 5)	753.63 KB	18/10/2018
Eurotherm iTools Help Manual (HA028838 Issue 5)	3.30 MB	18/10/2018

Downloads section

Firmware upgrade

With the relevant instrument selected in iTools, click on the Help menu and select 'Check for Updates...'.
Click on 'Firmware Upgrade Tool...' and follow the instructions.

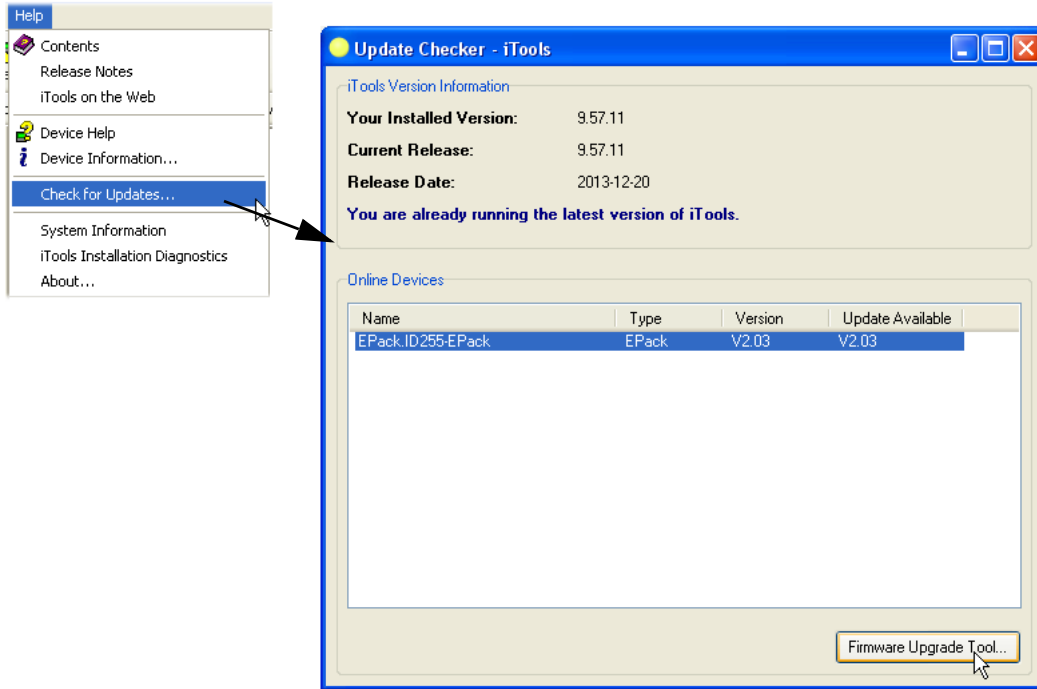

Figure 153 Check for updates

Software upgrade

Software upgrade can be carried out by one of two methods, as follows:

Obtaining a Passcode via Telephone

1. Telephone the local Eurotherm Sales/Service agent with the serial number of the instrument to be updated, and the current software version. All required information (Serial Number, Software version, current features codes) can be found in Instrument Option folder using iTools (see Figure 154 below). This information can also be found through HMI in configuration mode 'Info' menu.
2. Place an order for the required new functionality.
3. A new passcode will be provided which is to be entered in the Info menu available from the front panel whilst in Configuration mode or in the Instrument Options configuration using iTools.

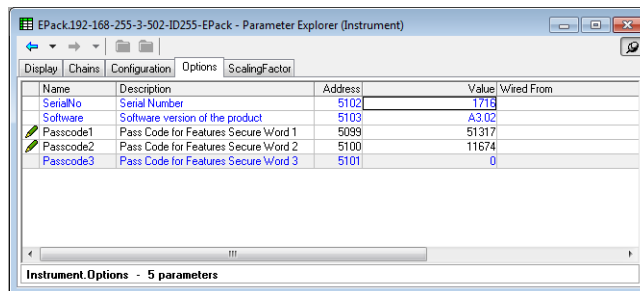
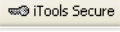

Figure 154 Instrument options configuration

Obtaining a Passcode via iTools

1. Click on the 'iTools Secure' tool button .
2. Accept the warning message.
3. Select the functions required from the displayed list (figure 155).
4. Click on 'Proceed...'. This sends an email requesting the option passcode. Follow the instructions.
5. Enter the new passcode as described in step three above.

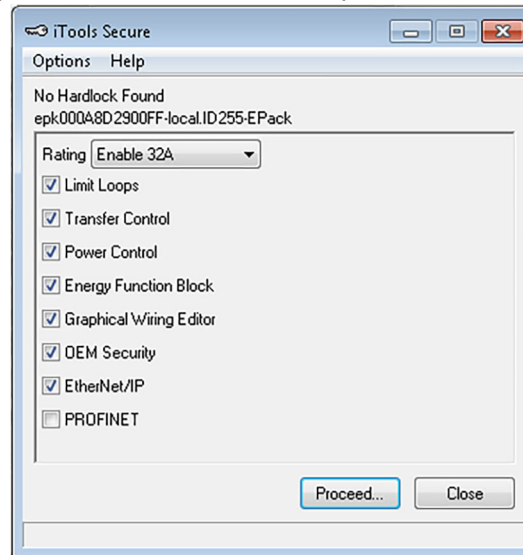

Figure 155 iTools secure

EPack Licence Notice

FreeRTOS

EPack is powered by an original FreeRTOS from version v7.1.0.

FreeRTOS is available at <http://www.freertos.org>

EtherNet/IP

EPack uses an embedded MOLEX Ethernet/IP stack.

PROFINET

EPack uses an embedded PROFINET PORT stack.

/* microutf8

Copyright © 2011 by Tomasz Konojacki

Permission is hereby granted, free of charge, to any person obtaining a copy of this software and associated documentation files (the "Software"), to deal in the Software without restriction, including without limitation the rights to use, copy, modify, merge, publish, distribute, sublicense, and/or sell copies of the Software, and to permit persons to whom the Software is furnished to do so, subject to the following conditions:

The above copyright notice and this permission notice must be included in all copies or substantial portions of the Software.

THE SOFTWARE IS PROVIDED "AS IS", WITHOUT WARRANTY OF ANY KIND, EXPRESS OR IMPLIED, INCLUDING BUT NOT LIMITED TO THE WARRANTIES OF MERCHANTABILITY, FITNESS FOR A PARTICULAR PURPOSE AND NONINFRINGEMENT. IN NO EVENT SHALL THE AUTHORS OR COPYRIGHT HOLDERS BE LIABLE FOR ANY CLAIM, DAMAGES OR OTHER LIABILITY, WHETHER IN AN ACTION OF CONTRACT, TORT OR OTHERWISE, ARISING FROM, OUT OF OR IN CONNECTION WITH THE SOFTWARE OR THE USE OR OTHER DEALINGS IN THE SOFTWARE.

/*

lwip

/*

* Copyright © 2001, 2002 Swedish Institute of Computer Science.

* All rights reserved.

* Redistribution and use in source and binary forms, with or without modification, are permitted provided that the following conditions are met:

* 1. Redistributions of source code must retain the above copyright notice, this list of conditions and the following disclaimer.





* 2. Redistributions in binary form must reproduce the above copyright notice, this list of conditions and the following disclaimer in the documentation and/or other materials provided with the distribution.

* 3. The name of the author may not be used to endorse or promote products derived from this software without specific prior written permission.

Technical Specification

Standards

The product is designed and produced to comply with:

Countries	Standard/ Certification symbol	Standard/Certification details
European community		EN60947-4-3:2014. (identical to IEC60947-4-3:2014) Low-voltage switchgear and controlgear - Part 4-3: Contactors and motor-starters - AC semiconductor controllers and contactors for non-motor loads. Declaration of conformity available on request.
USA & Canada		USA: UL60947-4-1 Canada: CAN/CSA C22.2 NO.60947-4-1-14 Low-Voltage Switchgear and Controlgear - Part 4-1: Contactors and Motor-Starters - Electromechanical Contactors and Motor-Starters U.L. File N° E86160
Australia		Regulatory Compliance Mark (RCM) to Australian Communication and Media Authority. Based on compliance to EN60947-4-3:2014.
China	/	Product not listed in catalog of products subject to China Compulsory Certification (CCC)
ALL		ODVA declaration of conformity
		Cybersecurity certification to Achilles® CRT Level 1

Installation Categories

 **DANGER**

HAZARD OF ELECTRICAL SHOCK, EXPLOSION OR ARC FLASH

- Do not exceed the device's ratings.

Failure to follow these instructions will result in death or serious injury.

The insulation barriers of the equipment have been designed for the rating as defined in the table below at an altitude of 2000m maximum.

Table 12: Installation categories

	Installation Category	Rated impulse withstand voltage (U _{imp})	Rated insulation voltage (U _i)	Maximum value of rated operational voltage to earth
Communications	II	0.5kV	50V	50V
Standard IO	II	0.5kV	50V	50V
Relays	III	4kV	300V	300V
Power terminals	III	6kV	500V	500V

Specification

Auxiliary supply

Frequency range:	47 to 63Hz
Power requirement:	24V dc 12W 24V ac 18VA 500V ac 20VA
Rated control supply voltage (U _s):	24V ac/dc (+20%, -20%) or 100 to 500V (+10%, -15%)

DANGER

HAZARD OF ELECTRICAL SHOCK, EXPLOSION OR ARC FLASH

- The maximum voltage between any pole of the 85Vac to 550Vac auxiliary supply and all other terminals must be lower than 550Vac.

Failure to follow these instructions will result in death or serious injury.

If the 85Vac to 550Vac auxiliary supply is supplied by a dedicated transformer the phasing must be checked to avoid overvoltage.

DANGER

HAZARD OF ELECTRICAL SHOCK, EXPLOSION OR ARC FLASH

- The "24V auxiliary supply" is an SELV circuit. The supply voltage must be derived from a SELV or PELV circuit.

Failure to follow these instructions will result in death or serious injury.

SELV is defined (in IEC60947-1) as an electrical circuit in which the voltage cannot exceed 'ELV' under normal conditions or under single fault conditions, including earth ground faults in other circuits.

The definition of ELV is complex as it depends on environment, signal frequency, etc. See IEC 61140 for further details.

Power

Frequency range	47 to 63Hz
Rated operational voltages (Ue):	100 to 500V (+10%, -15%)
Rated operational currents (Ie)	16 to 125 Amps
Power Dissipation	1.3 Watts per Ampere, per phase
Duty cycle	Uninterrupted duty / continuous operation
Device form designation	Form 4 (Semiconductor controller)
Short circuit protection	By external supplemental fuses (high speed fuse) - see "Fusing" on page 231.
Rated conditional short-circuit current	100kA (Coordination Type 1)
Utilization categories	AC-51: Non-inductive or slightly inductive loads, resistance furnaces AC-55b: Switching of incandescent lamps AC-56a: Transformer Primary
Heater Type	Low/high temperature coefficient and non-aging/aging types: MOSI Molybdenum Silicide, Silicon Carbide, Carbon.
Overload conditions	AC-51: 1 x Ie continuous AC-55b: 1 x Ie continuous AC-55b: 2.5 x Ie - 100ms AC-56a: 1 x Ie continuous
Load Power factor	0.85 for Loads from 32A up to 125A

DANGER

HAZARD OF ELECTRICAL SHOCK, EXPLOSION OR ARC FLASH

- Do not exceed the device's ratings.

Failure to follow these instructions will result in death or serious injury.

Only SLIGHTLY inductive loads are allowed, contact Eurotherm for advice for Loads lower than 32A.

Physical

Dimensions and mounting centers	See Figure 4, Figure 5, Figure 6 and Figure 7 for details
Weight:	
16 to 32A units	+ user connectors
40 to 63A units	+ user connectors
80A and 100A units	+ user connectors
125 A units	+ user connectors

Environment

Temperature limits:	
Operating:	0°C to 45°C at 1000m 0°C to 40°C at 2000m
Storage:	-25°C to +70°C
Altitude:	1000m maximum at 45°C 2000m maximum at 40°C

⚠ DANGER

HAZARD OF ELECTRICAL SHOCK, EXPLOSION OR ARC FLASH

- Do not exceed the device's ratings.

Failure to follow these instructions will result in death or serious injury.

The insulations barriers of the equipment have been designed for an altitude of 2000m maximum.

⚠ DANGER

HAZARD OF FIRE

- At commissioning ensure that under maximum load condition, the ambient temperature of the product will not exceed the limit stated in that manual.

Failure to follow these instructions will result in death or serious injury.

Enclosure type ratings (UL)

All units: Open type

Degree of Protection (CE)

16A to 63A units: IP10 (EN60529)

80A to 125A units IP20 (EN60529)

⚠ DANGER

HAZARD OF ELECTRICAL SHOCK, EXPLOSION OR ARC FLASH

- Respect electrical installation requirements to ensure, improve the IP rating.

Failure to follow these instructions will result in death or serious injury.

If the conductor stripping lengths of the power cables are longer than the requirements IP20 is compromised.

If the conductor stripping lengths of the power cables are shorter than the requirements there is a potential risk of total loss of connection. Wires may slip out of the terminals.

For product rated 80A to 125A, if the plastic knockouts are removed, and cables with diameter lower than 9mm are used, the IP20 is compromised and the product is IP10.

Humidity limits: 5% to 95% RH (non-condensing)

Atmosphere Non-explosive, non-corrosive, non-conductive

Pollution degree: Pollution degree 2

⚠ DANGER

HAZARD OF ELECTRICAL SHOCK, EXPLOSION OR ARC FLASH

- Electrically conductive pollution must be excluded from the cabinet in which the product is mounted.

Failure to follow these instructions will result in death or serious injury.

The product has been designed for pollution degree 2 according to IEC60947-1 definition: Normally, only non-conductive pollution occurs. Occasionally, however, a temporary conductivity caused by condensation may be expected.

Electrically conductive pollution must be excluded from the cabinet in which the product is mounted. To ensure a suitable atmosphere in conditions of conductive pollution, fit adequate air conditioning/filtering/cooling equipment to the air intake of the cabinet, e.g. fitting fan-cooled cabinets with a fan failure detection device or a thermal safety cut-out.

External wiring

IEC/CE: Must comply with IEC60364-1 and IEC60364-5-54 and all applicable local regulations.

UL: Wiring must comply with NEC and all applicable local regulations. Cross sections must comply with NEC, Article 310 Table 310-16. (See [Table 1](#) of this manual for temperature ratings).

Shock

According to EN60068-2-27 and IEC60947-1 (Annex Q, Category E)

Vibration

According to EN60068-2-6 and IEC60947-1 (Annex Q, Category E)

EMC Standard:

EN60947-4-3:2014.

See [Table 13](#) and [Table 14](#) for EMC emission and immunity levels attained.

Table 13: EMC Immunity Tests

EMC immunity tests (According to EN60947-4-3:2014)				
	Level		Criteria	
	Requested	Achieved	Requested	Achieved
Electrostatic discharge (test method of IEC 61000-4-2)	Air discharge mode 8kV Contact discharge mode 4kV	Air discharge mode 8kV Contact discharge mode 4kV	2	2
Radiated radio-frequency electromagnetic field test (test method of EN 61000-4-3)	10V/m from 80MHz to 1GHz and from 1.4GHz to 2GHz	10V/m from 80MHz to 1GHz and from 1.4GHz to 2GHz	1	1
Fast transient/burst test (5/50ns) (test method of EN 61000-4-4)	Power ports 2kV / 5kHz Signal ports 1kV / 5kHz	Power ports 4kV / 5 kHz Signal ports 2kV / 5 kHz	2	2
Surge Voltage test (1,2/50µs - 8/20µs) (test method of EN 61000-4-5)	2kV line to earth 1kV line to line	2kV line to earth 1kV line to line	2	2
Conducted radio-frequency test (test method of EN 61000-4-6)	10V (140dBµV) from 0.15MHz to 80 MHz	15V (143.5dBµV) from 0.15MHz to 80 MHz	1	1
Voltage dips test (test method of EN 61000-4-11)	0% during 0.5 cycle & 1 cycle	0% during 0.5 cycle & 1 cycle	2	2
	40% during 10/12 cycles	40% during 10/12 cycles	3	2
	70% during 25/30 cycles	70% during 25/30 cycles	3	2
	80% during 250/300 cycles	80% during 250/300 cycles	3	2
Short interruptions test (test method of EN 61000-4-11)	0% during 250/300 cycles	0% during 250/300 cycles	3	2

Table 14: EMC Emission Tests

EMC emission tests (According to EN60947-4-3:2014)				
Test	Frequency (MHz)	Limit level for class A industrial		Comments
		Quasi peak dB (µV)	Average dB (µV)	
Radiated radio frequency emission test According to EN60947-4-3:2014 (test method of CISPR11)	30 to 230	40 at 10m	N/A	Pass
	230 to 1000	47 at 10m	N/A	
Conducted radio frequency emission test According to EN 60947-4-3:2014 for rated power <20kVA (test method of CISPR11)	0.15 to 0.5	79	66	The conducted emissions can meet the requirement of IEC60947-4-3:2014 with an external filter added on the line connections.
	5 to 30	73	60	
Conducted radio frequency emission test According to EN 60947-4-3:2014 for rated power >20kVA (test method of CISPR11)	0.15 to 0.5	100	90	
	0.5 to 5	86	76	
	5 to 30	90 to 73 ¹	80 to 60 ¹	This is in line with the rest of the industry ²

1. Decrease with log of frequency emissions.

2. Technical note TN1618 (available upon customer request) describes the recommended filter structures which reduce conducted radio-frequency emissions.

 WARNING
<p>UNINTENDED EQUIPMENT OPERATION</p> <ul style="list-style-type: none"> • Do not use the product for critical control or protection applications where human or equipment safety relies on the operation of the control circuit. • Signal and power voltage wiring must be kept separate from one another. Where this is impractical, all wires must be rated to the power voltage & shielded cables are recommended for signal wiring. • This product has been designed for environment A (Industrial). Use of this product in environment B (domestic, commercial and light industrial) may cause unwanted electromagnetic disturbances in which cases the installer may be required to take adequate mitigation measures. • For Electromagnetic Compatibility, the panel or DIN rail to which the product is attached must be grounded. • Observe all electrostatic discharge precautions before handling the unit. • At commissioning, ensure correct product configuration. <p>Failure to follow these instructions can result in death, serious injury or equipment damage.</p>

To reach EMC immunity levels and criteria as stated in [Table 13](#), Nominal current parameter (INominal) must be set between 25% & 100% of product current rating.

 DANGER
<p>HAZARD OF ELECTRICAL SHOCK, EXPLOSION OR ARC FLASH</p> <ul style="list-style-type: none"> • The I/O Input & Output, the Communications ports are SELV circuit. They must be connected to SELV or PELV circuit. • The relay output and the fuse holders contacts are compliant to the SELV requirements; they can be connected to SELV, PELV circuit or to voltage up to 230V (maximum value of rated operational voltage to earth:230V) <p>Failure to follow these instructions will result in death or serious injury.</p>

SELV is defined (in IEC60947-1) as an electrical circuit in which the voltage cannot exceed 'ELV' under normal conditions or under single fault conditions, including earth ground faults in other circuits.

The definition of ELV is complex as it depends on environment, signal frequency, etc. See IEC 61140 for further details.

Operator Interface

Display	1.44" square TFT colour display allowing viewing of selected parameter values in real time, plus configuration of instrument parameters for users with adequate access permission.
Push buttons	Four push buttons provide page and item entry and scroll facilities.

Inputs/Outputs

All figures are with respect to 0V, unless otherwise stated.

Number of inputs/outputs	1 Analog input; 2 Digital inputs (DI1 and DI2); 1 Relay output
Update rate	See I/O Input & Output Details (page 49) Twice the mains frequency. Defaults to 55Hz (18 ms) if the supply frequency lies outside the range 47 to 63Hz.)
Termination	Removable 5-way connector. Located as shown in Figure 10 .

Analog Input

Performance	See Table 15 and Table 16
Input type	Configurable as one of: 0 to 10V, 1 to 5V, 2 to 10V, 0 to 5V, 0 to 20mA, 4 to 20mA
Absolute input maxima	-0.6V to +16V and ± 40 mA

Table 15: Analog input specification (voltage inputs)

Analog input: Voltage input performance		
Parameter	Typical	Max/Min
Total voltage working input span		0V to +10V
Resolution (electrical noise free) (note 1)	11 bits	
Calibration accuracy (notes 2, 3)	<0.1%	<0.1%
Linearity accuracy (note 2)		±0.1%
Ambient temperature deviation (note 3)		<0.01%/°C
Input resistance (terminal to 0V)	142kΩ	±0.2%

Note 1: w.r.t. total working span
 Note 2: % of effective range (0 to 5V, 0 to 10V)
 Note 3: After warm up. Ambient = 25 °C

Table 16: Analog input specification (current inputs)

Analog input: Current input performance		
Parameter	Typical	Max/Min
Total current working input span		0 to +25mA
Resolution (electrical noise free) (note 1)	11 bits	
Calibration accuracy (notes 2, 3)		<0.2%
Linearity accuracy (note 2)		±0.1%
Ambient temperature deviation (note 2)		±0.01%/°C
Input resistance (terminal to 0v)	<102Ω	±1%

Note 1: w.r.t. total working span
 Note 2: % of effective range (0 to 20mA)
 Note 3: After warm up. Ambient = 25 °C

Digital Inputs

Voltage inputs

Active level (high): $11V < V_{in} < 30V$ with $6mA < \text{input current} < 30mA$

Non-active level (low): $-3V < V_{in} < 5V$ with $2mA < \text{input current} < 30mA$

Or

$5V < V_{in} < 11V$ with input current $< 2mA$

Contact closure inputs

Source current: 10mA min - 15mA max

Open contact (non active)

resistance: $> 800\Omega$

Closed contact (active)

resistance: $< 450\Omega$

Absolute Maxima: $\pm 30V$ or $\pm 25mA$

Note: Absolute maximum ratings refer to externally applied signals

Digital Output

User configured output (DI2): $\pm 2\%$ 10.2V, 10mA

For example; To supply a potentiometer between $2k\Omega$ - $10k\Omega$ ($\pm 20\%$) used to drive the Analog Input when set to Voltage mode - see [Inputs/Outputs \(page 251\)](#).

Relay Specification

The relay has gold plated contacts suitable for 'dry circuit' (low current) use. See "I/O Input & Output Details" on page 49.

Contact life

Resistive loads: 100,000 operations

Inductive loads: Derate as per accompanying graph (Figure 156)

High power use

Current: 2A (resistive loads)

Voltage: <264V RMS (UL: voltage 250Vac.)

Low power use

Current: >10 mA

Voltage: >5V

Contact configuration:

Single pole change-over (one set of Common, Normally Open and Normally Closed contacts)

Termination

Removable 3-way connector. Located as shown in [Figure 10](#).

Installation Category

Installation category III, assuming that nominal phase to earth ground voltage is $\leq 300V$ RMS.

Absolute max. switching capability

<2A at 240V RMS (resistive loads)

Note: 'Normally Closed' and 'Normally Open' refer to the relay when the coil is not energized.

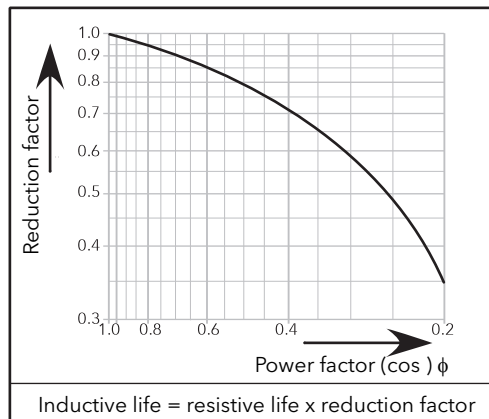

Figure 156 Relay derating curves

Fuse Holders Contacts Kit Specification

Fuse Holders Contacts Kit are delivered with NO, NC contact

Connection: Faston lugs 2.8 X 0.5 mm

Rated insulation voltage: 250VAC

Rated operational current following IEC 60947-5 & -1

Utilization category AC15: 4A/24V, 4A/48V, 3A/127V, 2.5A/240V

Utilization category DC13: 3A/24V, 1A/48V, 0.2A/127V, 0.1A/240V

Minimum operational current and voltage:

(For contact kit reference according to product rating see [Table 9](#) and [Table 10](#))

Contact kit Mersen Y227928A, for fuse size 14x51, or,

Contact kit Mersen G227959A for fuse size 22x58.

1mA/4V AC or DC

Contact kit Mersen E227612A, for fuse size 27x60

100mA/20V AC or DC

Mains Network Measurements

All network measurements are calculated over a full mains cycle, but internally updated every half-cycle. For this reason, power control and alarms all run at the mains half-cycle rate. The calculations are based on waveform samples taken at a rate of 20kHz. The phase voltage referred to is the line voltage referenced to N/L2 input potential.

The parameters below are directly derived from measurements for each phase.

Accuracy (20 to 25°C)

- Line frequency (F): $\pm 0.02\text{Hz}$
- Line RMS voltage (Vline): $\pm 2\%$ of Nominal Vline.
- Load RMS voltage (V): $\pm 2\%$ of Nominal V for voltage readings $> 1\%$ of Nominal V. Unspecified for readings lower than $1\%V_{nom}$.
- Load current (I_{RMS}): $\pm 2\%$ of Nominal I_{RMS} for current readings $> 3.3\%$ of Nominal I_{RMS}. Unspecified for readings $\leq 3.3\%$ of Nominal. I_{RMS}.
- Load RMS voltage squared (Vs_q): $\pm 2\%$ of (Nominal V)²
- Thyristor RMS current squared (Is_q): $\pm 2\%$ of (Nominal I)²
- Frequency resolution: 0.1 Hz
- Measurement resolution: 11 bits of Nominal value
- Measurement drift with ambient temp.: $< 0.02\%$ of reading / °C

Further parameters (Z, IsqBurst, Vs_q Burst) are derived from the above, for the network (if relevant).

 WARNING
<p>UNINTENDED EQUIPMENT OPERATION</p> <ul style="list-style-type: none"> • At commissioning, ensure correct product configuration. <p>Failure to follow these instructions can result in death, serious injury or equipment damage.</p>

To reach accuracy as stated above, Nominal current parameter (INominal) must be set between 25% & 100% of product current rating.

Communications

- Connection: Dual port Ethernet - RJ45
- Cable type: Shielded RJ45 CAT5+
- Protocol: Modbus TCP, Ethernet/IP, or PROFINET (both, a chargeable option)
- Baud rate: 10/100 full or half duplex
- Indicators: Tx activity (green) and communications activity (yellow)



Scan for local contacts

Eurotherm Ltd

Faraday Close
Durrington
Worthing
West Sussex
BN13 3PL
Phone: +44 (0)1903 268500
www.eurotherm.com

As standards, specifications, and designs change from time to time, please ask for confirmation of the information given in this publication.

© 2021 Eurotherm Limited. All Rights Reserved.

HA033538 Issue 02 (CN38980)



* H A 0 3 3 5 3 8 *