

EFit Power Controller

User Guide

HA031980ENG Issue 3
July 2017

Eurotherm[®]

by **Schneider** Electric

部件名称 Part Name	有害物质 - Hazardous Substances					
	铅 (Pb)	汞 (Hg)	镉 (Cd)	六价铬 (Cr (VI))	多溴联苯 (PBB)	多溴二苯醚 (PBDE)
金属部件 Metal parts	0	0	0	0	0	0
塑料部件 Plastic parts	0	0	0	0	0	0
电子件 Electronic	X	0	0	0	0	0
触点 Contacts	0	0	0	0	0	0
线缆和线缆附件 Cables & cabling accessories	0	0	0	0	0	0

本表格依据SJ/T11364的规定编制。

O: 表示该有害物质在该部件所有均质材料中的含量均在GB/T 26572规定的限量要求以下。

X: 表示该有害物质至少在该部件的某一均质材料中的含量超出GB/T 26572规定的限量要求。

This table is made according to SJ/T 11364.

O: indicates that the concentration of hazardous substance in all of the homogeneous materials for this part is below the limit as stipulated in GB/T 26572.

X: indicates that concentration of hazardous substance in at least one of the homogeneous materials used for this part is above the limit as stipulated in GB/T 26572.

Signed (Kevin Shaw, R&D Director):



Date:

24th June 2016

Thyristor power controllers

EFit Series

For the control of heating elements up to 25kW

User Manual

Before installation, please read this manual thoroughly. Eurotherm cannot be held responsible for any damage to persons or property, or for any financial loss or costs arising from incorrect use of the product or failure to observe the instructions given in this manual.

In order to maintain its 'leading edge' Eurotherm may have to make changes to its specifications without advance notice.

For any further information, or if in doubt, please contact Eurotherm, where qualified staff are available to advise or assist you with the commissioning of your installation.

Guarantee

Two years parts and labour guarantee

Contents List

1. Safety Information	5	7. Control wiring	25
1.1 Important Information	5	7.1 Input signal wiring	25
2. Safety notes	6	7.1.1 Remote Control	25
2.1 SELV	12	7.1.2 Local control by potentiometer	26
2.2 Symbols used on the instrument labelling	12	7.1.3 Local control by contacts	26
3. Technical specifications	13	7.2 Auxiliary power supply (option)	27
4. Codification	19	8. Current limit option	28
4.1. Ordering code	19	8.1. Operations	28
4.2. Fuses	20	8.2. Adjustment	28
5. Mechanical installation	21	9. Thyristors firing modes	29
5.1. Dimensional details	21	9.1 Fast cycle	29
6. Electrical Installation	22	9.2 Single-cycle	30
6.1 Terminals & connectors	22	9.3 Advanced Single-cycle	31
6.2 Connectors	24	9.4 Phase angle	32
6.2.1. View on lower face	24	10. Power Control	33
6.2.2. View on upper face	24	10.1 Description	33
		10.2 Compensation of power supply fluctuations	33
		11. Current derating	34

1. Safety Information

1.1 Important Information

Read these instructions carefully and look at the equipment to become familiar with the device before trying to install, operate, service, or maintain it. The following special messages may appear throughout this manual or on the equipment to warn of potential hazards or to call attention to information that clarifies or simplifies a procedure.



The addition of either symbol to a “Danger” or “Warning” safety label indicates that an electrical hazard exists which will result in personal injury if the instructions are not followed.



This is the safety alert symbol. It is used to alert you to potential personal injury hazards. Obey all safety messages that follow this symbol to avoid possible injury or death.

DANGER

DANGER indicates a hazardous situation which, if not avoided, will result in death or serious injury.

WARNING

WARNING indicates a hazardous situation which, if not avoided, could result in death or serious injury.

CAUTION

CAUTION indicates a hazardous situation which, if not avoided, could result in minor or moderate injury.

NOTICE

NOTICE is used to address practices not related to physical injury.

2. Safety notes



BRANCH-CIRCUIT PROTECTION AND SAFETY OVERLOAD PROTECTION

1. This product does not contain any branch-circuit protection or internal safety overload protection. It is the responsibility of the user to add branch-circuit protection upstream of the unit. It is also the responsibility of the user to provide external or remote safety overload protection to the end installation. Such branch-circuit and safety overload protection must comply with applicable local regulations.

UL: The above mentioned branch-circuit protection is necessary for compliance with National Electric Code (NEC) requirements.

2. The cable use to connect auxiliary supply should be correctly protected by a branch-circuit protection. It is the responsibility of the user to add branch circuit protection. Such branch-circuit must comply with applicable local regulations.

HAZARD OF ELECTRICAL SHOCK, EXPLOSION OR ARC FLASH

3. Eurotherm shall not be held responsible for any damage, injury, losses or expenses caused by inappropriate use of the product or failure to comply with these instructions.
4. If the product is used in a manner not specified by the manufacturer the protection provided by the product might be impaired.
5. Disassembling the product is strictly forbidden.
6. The product must be installed and maintained by suitably qualified personnel, authorized to work in an industrial low voltage environment.

 **DANGER**

HAZARD OF ELECTRICAL SHOCK, EXPLOSION OR ARC FLASH

7. This product is not suitable for isolation applications, within the meaning of EN60947-1.
8. It is strongly recommended that the installing authority includes independent, system-safety mechanisms to protect both personnel and equipment against injury or damage, and that such safety mechanisms be regularly inspected and maintained. Consult the EFit supplier for advice.
9. The product is designed to be installed in a cabinet connected to the protective earth ground according to IEC60364-1 and IEC60364-5-54 or applicable national standards.
10. Electrically conductive pollution must be excluded from the cabinet in which the product is mounted. To ensure a suitable atmosphere in conditions of conductive pollution, fit adequate air conditioning/filtering/cooling equipment to the air intake of the cabinet, e.g. fitting fan-cooled cabinets with a fan failure detection device or a thermal safety cut-out.
11. Before carrying out any wiring to the product, it must be ensured that all relevant power and control cables, leads or harnesses are isolated from voltage sources.
12. Before any other connection is made, the protective earth ground terminal shall be connected to a protective conductor. Wire conductor cross sections must comply with table 9 of IEC60947-1 or NEC Article 310 Table 310-16.
U.L.: The earth connection must be made using a UL-listed ring type crimp. The cable used must be rated 90°C stranded copper only.

 **DANGER**

13. The protective earth ground connections and power terminals must be tightened according to the torque values listed in table(s), see *6.1 Terminals and connectors, page 22*. Appropriate regular inspections must be performed.
14. Any interruption of the protective earth ground conductor inside or outside the product, or disconnection of the protective earth ground terminal is likely to make the product dangerous under some conditions. Intentional interruption is prohibited. Whenever it is likely that protection has been impaired, the unit shall be made inoperative and secured against accidental operation. The manufacturers nearest service centre must be contacted for advice.
15. Power connections: wire conductor cross sections must comply with table 9 of IEC60947-1 or NEC Article 310 Table 310-16. The cables used must be rated 90°C stranded copper only.
16. If fitted, the 115Vac or 230Vac auxiliary supply must be in phase with the line and shall be protected by a supplemental fuse ATM2 fuse rated 600Vac/dc, 2A, 100kA.
17. According to the CE and UL certifications, high speed fuses (supplemental fuses) are mandatory for compliant installation and protection of the EFit controller against short circuit. See paragraph 4.2 for details.
18. With supplemental fuse (high speed fuse) the product's rated short-circuit conditional current is 100kA for co-ordination type 1. If opening of either the branch circuit protective or the supplemental (high speed) fuses occurs, the product must be examined by suitably qualified personnel and replaced if damaged.

 **DANGER**

19. Connection of two conductors in the same terminal is not permitted.

Failure to follow these instructions will result in death or serious injury.

 **WARNING**

1. Signal and power voltage wiring must be kept separate from one another. Where this is impractical, all wires have to be rated to the power voltage & shielded cables are recommended for signal wiring.
2. The instrument shall have one of the following as a disconnecting device, fitted within easy reach of the operator and labelled as the disconnecting device:
 - A switch or circuit breaker which complies with the requirements of IEC60947-1 and IEC60947-3
 - A separable coupler which can be disconnected without the use of a tool
3. The product is designed to be mounted vertically. There must be no obstructions (above or below) which could reduce or hamper airflow. If more than one instance of the product is located in the same cabinet, they must be mounted in such a way that air from one unit is not drawn into another.
4. To reach the thermal performance the gap between two EFit power controllers must be at minimum 10mm.
5. Under some circumstances, the heatsink temperature may rise by more than 50°C and it can take up to 15 minutes to cool after the product is shut down. Give consideration to additional warnings and barriers to prevent injury.
6. This product has been designed for environment A (Industrial). Use of this product in environment B (domestic, commercial and light industrial) may cause unwanted electromagnetic disturbances in which case the installer may be required to take adequate mitigation measures.

 **WARNING**

7. To ensure that EFit complies with Electromagnetic Compatibility requirements, ensure that the panel or DIN rail to which it is attached is correctly grounded. The ground connection, designed to ensure ground continuity, is not in any way a substitute for the protective earth ground connection.
8. IP20: In order to maintain IP20 protection, the stripped length of the power cables from the supply and to the load must be adapted according to the insulation thickness.









Failure to follow these instructions can result in death, serious injury or equipment damage.

2.1 SELV

Safety Extra Low Voltage. This is defined (in IEC60947-1) as an electrical circuit in which the voltage cannot exceed 'ELV' under normal conditions or under single fault conditions, including earth faults in other circuits. The definition of ELV is complex as it depends on environment, signal frequency etc. See IEC 61140 for further details. The input connector (pin 5 to 7) is compliant to the SELV requirements.

2.2 SYMBOLS USED IN THE INSTRUMENT LABELLING

One or more of the symbols below may appear as a part of the instrument labelling.

	Protective conductor terminal		Risk of electric shock
	AC supply only		Precautions against static electrical discharge must be taken when handling this unit
	Underwriters Laboratories listed mark for Canada and the US		Refer to the manual for instructions
	Do not touch Heatsink Hot Surface		CE Mark. Indicates compliance with the appropriate European Directives and Standards
	EAC (EurAsian Conformity) customs union mark of conformity		

3. Technical specifications

General	
Device form designation	Form 4: Semiconductor controller
Rated Duty	Uninterrupted duty/continuous operation
Directive	EMC Directive 2014/30/EU Low Voltage Directive 2014/35/EU RoHS Directive 2011/65/EU
Safety specification	EN60947-4-3:2014 (Low-voltage switchgear and controlgear - Part 4-3: Contactors and motor-starters).AC semiconductor controllers and contactors for non-motor loads (identical to IEC60947-4-3:2014) Class A product
EMC emissions specification	
EMC immunity specification	
Vibration tests	EN60947-1 annex Q category E
Shock tests	EN60947-1 annex Q category E
Approvals	
cUL	UL60947-4-1 CAN/CSA C22.2 NO.60947-4-1-14 Low-Voltage Switchgear and Controlgear - Part 4-1: Contactors and Motor-Starters - Electromechanical Contactors and Motor-Starters
CE	EN60947-4-3:2014 (Low-voltage switchgear and controlgear - Part 4-3: Contactors and motor-starters - AC semiconductor controllers and contactors for non-motor loads (identical to IEC60947-4-3:2014)
	EAC (EurAsian Conformity) customs union mark of conformity
Protection	CE: IP20 According to EN60529 UL: Open type

Condition of use	
Atmosphere	Non-corrosive, non-explosive, non-conductive
Usage temperature	1000m maximum at 45°C 2000m maximum at 40°C Please see paragraph 10 for derating information
Storage temperature	-25°C to 70°C (maximum)
Altitude	1000m maximum at 45°C 2000m maximum at 40°C Please refer to paragraph 10 for more details
Degree of pollution	Degree 2
Humidity limits	5% to 95% RH (non-condensing)
Mechanical Details	
Dimensions	Height x Width x Depth
Model 16 amps	115mm x 52.5mm x 92.5mm
Model 25 amps	115mm x 70mm x 92.5mm
Model 40 amps	115mm x 105mm x 92.5mm
Model 50 amps	115mm x 122.5mm x 92.5mm
Mounting	DIN rail
Power	
Nominal current	16 to 50A
Nominal voltage	100V to 500V (+10%/–15%). Refer to 'Codification' for more details
Frequency	47Hz to 63Hz
Rated short-circuit conditional current	100kA (coordination type 1) (see 3.2)
Type of loads:	
AC51	Non-inductive or slightly inductive loads, resistance furnaces
AC-56a	Transformer Primary (Phase Angle product only with current limit)

Installation category					
	Rated impulse withstand voltage (U imp)		Rated insulated voltage (Ui)	Installation Category	
	CE	UL		CE	UL
Control	0.5kV	0.8kV	50V	II	III
Auxiliary Supply	2.5kV	4kV	230V	II	III
Power terminals	4kV	6kV	500V	II	III

Control	
Supply of electronics	Self powered product: 100Vac to 500Vac Auxiliary supply: 115Vac or 230Vac. Auxiliary supply must be in phase with the line. The control circuit must have supplemental fuse protection rated at ATM2 fuse rated 600Vac/dc, 2A, 100kA
Control setpoint	Either analogue (analogue input or potentiometer) or logic
Analogue input signal	DC voltage: 0-5V, or 0-10V (maximum 15V), Input impedance 100k ohms. DC current: 4-20mA, Burden resistor 250 ohms
Potentiometer	A '5V user' voltage is available between terminals 5 and 7 to be used with an external potentiometer of 10kohm. One potentiometer per unit should be used
Logic	Contact for On/Off logic operation
Overload current profile	AC51: 1xle continuous

Control Performance

Linearity	Better than $\pm 2\%$ of the full range
Stability	Better than $\pm 2\%$ of the full range with constant resistance Automatic compensation for supply fluctuation (variation: between -10% and $+10\%$ of the nominal voltage).
Firing modes	Burst - Burst variable (16 periods) - Single cycle - Advanced single cycle Phase angle - With or Without current limit

EMC immunity tests (According to EN60947-4-3:2014)				
Tests	Level		Criteria	
	Requested	Achieved	Requested	Achieved
Electrostatic discharge (test method given in IEC 61000-4-2)	Air discharge mode 8kV Contact discharge mode 4kV	Air discharge mode 8kV Contact discharge mode 4kV	2	1
Radiated radio-frequency electromagnetic field test (test method of EN 61000-4-3)	10V/m from 80MHz to 1GHz and 1.4GHz to 2GHz	10V/m from 80MHz to 3GHz	1	1
Fast transient/burst test (5/50 ns) (test method of EN 61000-4-4)	Power ports 2kV / 5kHz	Power ports 3kV / 5kHz	2	2
	Signal ports 1kV / 5kHz	Signal ports 3kV / 5kHz	2	1
Surge Voltage test (1,2/50 μ s – 8/20 μ s) (test method of EN 61000-4-5)	2kV line to earth 1kV line to line	2kV line to earth 1kV line to line	2	2
Conducted radio-frequency test (test method of EN 61000-4-6)	10V (140dB μ V) from 0.15MHz to 80MHz	13V (142 dB μ V) from 0.15MHz to 80MHz	1	1
Voltage dips test (test method of EN 61000-4-11)	0% during 0.5 cycle & 1 cycle	0% during 0.5 cycle & 1 cycle	2	2
	40% during 10/12 cycles	40% during 10/12 cycles	3	2
	70% during 25/30 cycles	70% during 25/30 cycles	3	2
	80% during 250/300 cycles	80% during 250/300 cycles	3	2
Short interruptions test (test method of EN 61000-4-11)	0% during 250/300 cycles	0% during 250/300 cycles	3	2

Table A2a1 EMC immunity tests

EMC emission tests (According to EN60947-4-3:2014)				
Test	Frequency (MHz)	Limit level for class A industrial		Comments
		Quasi peak dB (µV)	Average dB (µV)	
Radiated radio frequency emission test According to EN60947-4-3:2014 (Test method CISPR11)	30 to 230	50 at 3m	N/A	Pass
	230 to 1000	57 at 3m	N/A	Pass
Conducted radio frequency emission test According to EN 60947-4-3:2014 for rated power <20kVA (test method of CISPR11)	0.15 to 0.5	79	66	The conducted emissions can meet the requirement of IEC60947-4-3:2014 with an external filter added on the line connections.
	5 to 30	73	60	
Conducted radio frequency emission test According to EN 60947-4-3:2014 for rated power >20kVA (test method of CISPR11)	0.15 to 0.5	100	90	This is in line with the rest of the industry ¹
	0.5 to 5	86	76	
	5 to 30	90 to 73	80 to 60	
Note: This product has been designed for environment A (Industrial). Use of this product in environment B (domestic, commercial and light industrial) may cause unwanted electromagnetic disturbances in which cases the user may be required to take adequate mitigation measures.				

1. Technical note TN1618 (available upon customer request) describes the recommended filter structures which reduce conducted radio-frequency emissions.

Table A2a2 EMC Radiated Emissions test

4. Codification

4.1 Ordering Code

Model /Current/Voltage/Input /Firing /Manual language/Supply Current limit /Fuse/00

Model	
EFit	EFIT
Nominal Current	
16 amps	16A
25 amps	25A
40 amps	40A
50 amps	50A
Nominal Voltage	
100 volts	100V
115 volts	115V
200 volts	200V
230 volts	230V
240 volts	240V
277 volts	277V
380 volts	380V
400 volts	400V
415 volts	415V
440 volts	440V
480 volts	480V
500 volts	500V
Input	
0-5Vdc	0V5
4-20mA	4mA20
0-10V	0V10

Firing mode	
Burst Variable	FC
Single cycle	FC1
Advanced single cycle	SCA
Phase angle	PA
Language	
English	ENG
French	FRA
German	GER
Supply	
Self-powered	SELF
Aux power supply 115 volts	115V
Aux power supply 230 volts	230V
Current limit	
Without current limit	XX
With current limit (only with PA)	CL
Fuse	
Without fuse ⁽¹⁾	NOFUSE
With fuse without microswitch	FUSE
With fuse with microswitch	MSFUSE

⁽¹⁾ See 4.2 Fuses, page 20

4.2 Fuses

This product does not contain any branch-circuit protection or internal safety overload protection. Please refer to *DANGER*, page 6.

Danger: According to the CE and UL certifications, high speed fuses (supplemental fuses) are mandatory for compliant installation and protection of the EFit controller against short circuit.

The power circuit shall be protected by a supplemental fuse as described in the table below. These should be used in conjunction with suitable fuse holders and contact kits (if required) as shown in this table.

With supplemental fuse (high speed fuse), EFit is suitable for use on a circuit capable of delivering not more than 100kA rms symmetrical amperes, 500 Volts Maximum (coordination Type 1).

Danger: If opening of the branch circuit protective or the supplemental fuse (high speed fuse) EFit shall be examined and replaced if damaged.

		Fuse body size (mm)	Fuse holder part no.	Fuse part no.	Contact kit part no.
16A	w/o MS	10x38	CP018525	CS031505U002	
	with MS	14x51	CP171480	CS031506U002	CP177220
25A	w/o MS	10x38	CP018525	CS031505U002	
	with MS	14x51	CP171480	CS031506U002	CP177220
40A	w/o MS	14x51	CP171480	CS031509U002	
	with MS	14x51	CP171480	CS031510U002	CP177220
50A	w/o MS	22x58	CP173083	CS031511U002	
	with MS	22x58	CP173083	CS031512U002	CP177221

5. Mechanical installation

5.1 Dimensional details

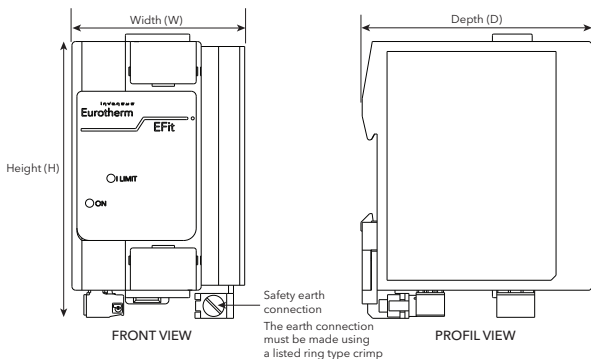

Model	Height (mm)	Width (mm)	Depth (mm)
16A	115	52,5	92,5
25A	115	70	92,5
40A	115	105	92,5
50A	115	122,5	92,5

Warning: To reach the thermal performance the gap between two EFit power controllers must be at minimum 10mm.

Warning: To ensure that EFit complies with Electromagnetic Compatibility requirements, ensure that the panel or DIN rail to which it is attached is correctly grounded. The ground connection, designed to ensure ground continuity, is not in any way a substitute for the protective earth ground connection.

6. Electrical Installation

6.1 Terminals and connectors

Danger: Before carrying out any wiring to the product, it must be ensured that all relevant power and control cables, leads or harnesses are isolated from voltage sources.

Tables below, give details of wire sizes and tightening torques for both power and signal wiring connection.

Danger: The protective earth ground connections and power terminals must be tightened according to the torque values listed in tables below. Appropriate regular inspections must be performed.

Danger: Wire conductor cross sections must comply with table 9 of IEC60947-1 (or NEC, Article 310 Table 310-16). Where a range of wire sizes is given it is up to the user to select the correct cross sectional area required for the application.

The protective earth ground cable should be, as a minimum, of the same cross sectional area as the cables used for the Mains and Load cables (i.e. the cables terminated at the 1/L1, 3/L2, 2/T1 and 4/T2 terminals).

Note: The protective earth ground connection must be made using a UL Listed ring type crimp.

POWER TERMINALS

Terminal	Function	Terminal type	Cable	Stripping	Tightening torque	Screw driver details
1/L1	Mains - Controlled phase	Cage	1.5mm ² to 16mm ² (14 to 6 AWG) rated 90°C	16mm	2.3 N.m (20.4 lb.inch)	1 x 5.5mm
3/L2	Mains - Direct phase/ Neutral					
2/T1	Load - Controlled phase					
4/T2	Load - Direct phase/ Neutral					
	Protective earth ground	M5 screw	Same section as Mains and Load cables minimum rated 90°C	The protective earth ground connection must be made using a UL Listed ring type crimp		

CONTROL BOARD CONNECTORS

Terminal	Function	Connector type	Cable	Stripping	Tightening torque	Screw driver details
5	0V of control signal	Plug-in	0.5 to 2.5mm ² (24 to 12 AWG) rated 75°C	7mm	0.6Nm (5.31 lb in)	0.6 x 3.5mm
6	+ of control signal					
7	User 5V					
8 & 10	Auxiliary power supply (option)	Plug-in	0.5 to 1.5mm ² (24 to 14AWG) rated 75°C	7mm	0.25Nm (2.25 lb in)	0.4 x 2.5mm
9	Not used					

Danger: Connection of two conductors in the same terminal is not allowed. **Failure to follow these instructions will result in death, serious injury or equipment damage.**

Warning: Signal and power voltage wiring must be kept separate from one another. Where this is impractical, all wires have to be rated to the power voltage & shielded cables are recommended for signal wiring.

6.2 Connectors

6.2.1 View on lower face

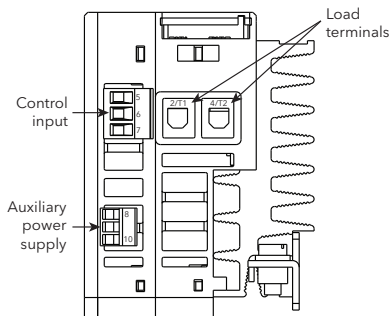

6.2.2 View on upper face

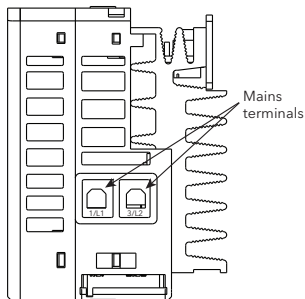

7. Control wiring

7.1 Input signal wiring

7.1.1 Remote Control

Example with an EFit driven by an analogue signal coming from the temperature controller

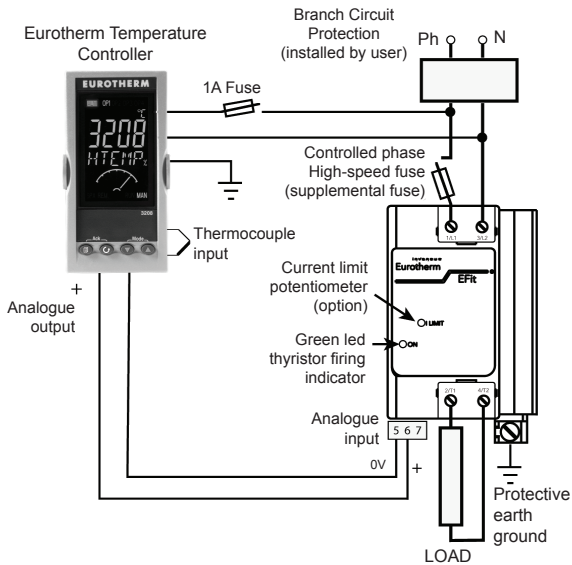

7.1.2 Local control by potentiometer

The input must be configured as 0 to 5V (code 0V5).

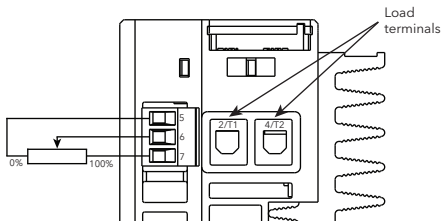

Wiring of the External potentiometer
(view on lower face)

7.1.3 Local control by contacts

The input must be configured as 0 to 5V (code 0V5).

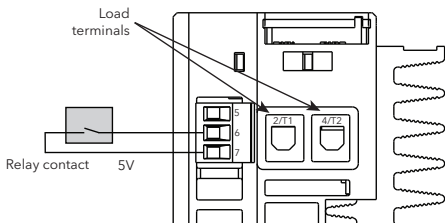

Wiring of the Relay Contact input
(view on lower face)

7.2 Auxiliary power supply (option)

In the case of non-standard mains, the auxiliary power supply must be in phase with the power supply voltage.

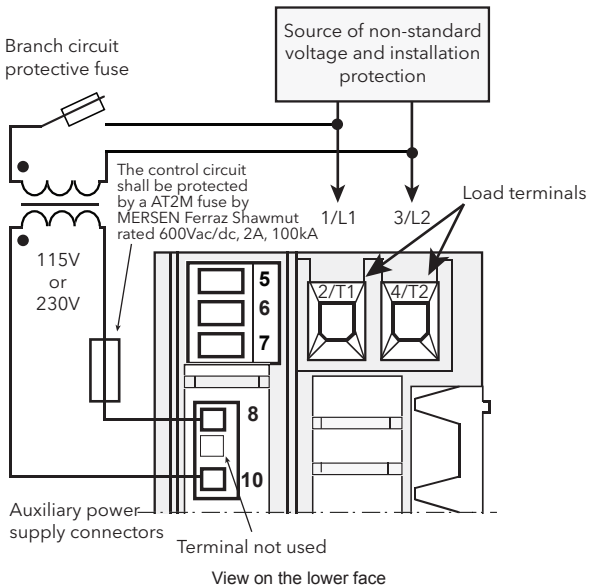

8. Current limit option (only available with phase angle firing mode)

8.1 Operation

The EFit controller features an adjustable rms load current limit. This function enables the user to limit the load current to a desired value independent of variation in load resistance. The current limit threshold can be set from 30% to 100% of the nominal current of the controller using the potentiometer labelled 'LIMIT' on the front facia.

8.2 Adjustment

Danger: This operation must be performed by a suitably qualified and trained personnel, authorized to work in an industrial low voltage environment.

Current limit adjustment is achievable if the rms load current is greater than or equal to 30% of the nominal current of the power controller. For this adjustment, use a flat bladed screw driver 2.5x0.4mm and a true rms ammeter in order to minimise errors, which could otherwise amount to as much as 50% of the value of the current. For current limit adjustment, proceed as follows:

- Check that the load circuit is connected but not supplied
- Turn the potentiometer (labelled 'LIMIT' on the front fascia) fully anti-clockwise (minimum position)
- Apply a 0% setpoint to the controller input
- If you have the 'Auxiliary power supply' option, switch on the auxiliary power supply
- Switch on the power circuit.
- Set the input signal at 100%.
- Turn slowly the current limit potentiometer clockwise and check that the current increases
- Adjust the potentiometer in order to reach the current limit value in the load.

9. Thyristors firing modes

Four firing modes are proposed: Variable burst (or Fast cycle), Single-cycle, advanced Single-cycle and Phase Angle. For the burst modes (FC, FC1 and SCA codes), Thyristor firing and quenching occurs at zero voltage which reduce the interferences on the supply network.

9.1 Variable burst (or Fast cycle)

Variable burst (or Fast cycle) mode consists in supplying series of whole mains cycles to the load.

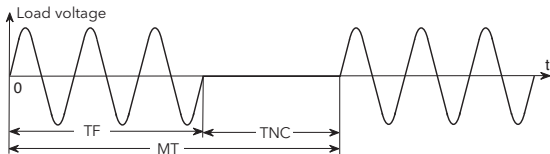

The load power is proportional to the ratio of the firing time (TF) to the modulation time (TM). The OFF time (TNF) is also a series of whole mains cycles. $TM = TF + TNF$

The period of modulation is variable according to the output power demand.

- At 50% of nominal power the thyristors are on for 16 periods and are off for 16 periods
- For a setpoint less than 50%, the non-firing period increases, and the firing period is fixed (16 periods)
- For a setpoint greater than 50%, the firing period increases, and it is the non-firing period which is fixed (16 periods)

9.2 Single-cycle

The mode of firing with only one firing or non-firing mains cycle is called Single-cycle.

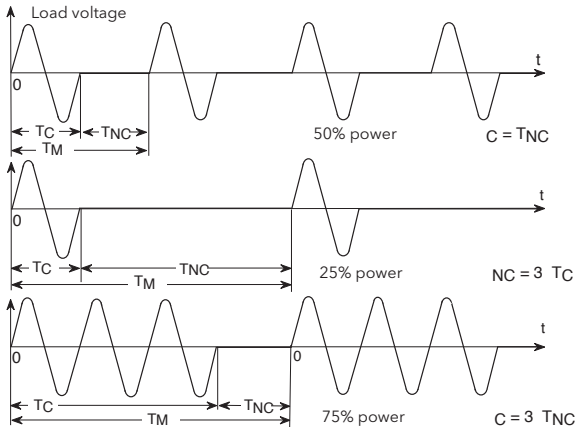

- At 50% of nominal power the thyristors are on for 20ms and are off for 20ms (at 50Hz)
- For a setpoint less than 50% the non-firing period increases and the firing period is fixed at 20ms
- For a setpoint greater than 50% the firing period increases and it is the non-firing period which is fixed at 20ms

9.3 Advanced Single-cycle

In order to minimise power fluctuation during the modulation period, the advanced Single-cycle mode uses half-cycles for non-firing duration.

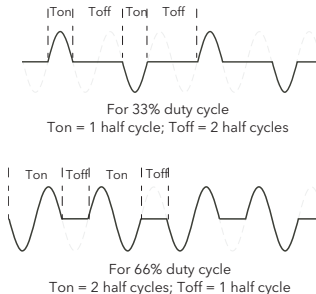

Examples of firing in Single-cycle (a) and in advanced Single-cycle (b) modes at 66.6% of nominal power.

- For a setpoint less than 50%, firing is effected on mains halfcycles. The firing time is fixed at one cycle (20ms at 50Hz)
- For a setpoint greater than 50%, non-firing is reduced to one halfcycle. Firing is effected over whole cycles.

The use of half-cycles for non-firing allows the reduction in flicker and brightness of infrared elements compared with Single-cycle.

9.4 Phase angle

In 'phase angle' thyristor firing mode the power transmitted to the load is controlled by firing the thyristors over part of the supply voltage half cycles.

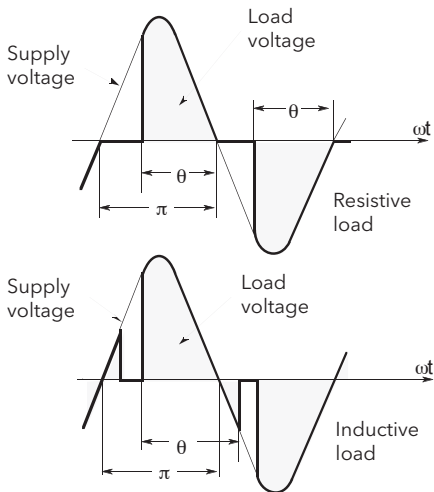

Load voltage in 'phase angle' firing mode (θ : thyristor firing angle)

10. Power control

10.1 Description

EFit controls on the square of the rms load voltage. Control precision is guaranteed at $\pm 2\%$ of the maximum voltage.

The power controlled varies linearly from 0% to 100% of maximum power for an input signal variation from 4% to 96% of full scale. Linearity is better than $\pm 2\%$ of full scale.

10.2 Compensation of power supply fluctuations

Automatic compensation of supply variation is effective for fluctuations between +10 and -10% of the nominal voltage of the controller.

Control with this compensation device enable constant output power to be maintained on a constant load, despite variations in supply voltage.

Without compensation for supply variations, a reduction, for example, of 10% in supply voltage would result in a reduction of 20% in load power. Thanks to this compensation device the variation will be less than $\pm 2\%$.

11. Current derating

Warning: To reach the thermal performance the gap between two EFit power controllers must be at minimum 10mm.

Warning: The product is designed to be mounted vertically. There must be no obstructions (above or below) which could reduce or hamper airflow. If more than one instance of the product is located in the same cabinet, they must be mounted in such a way that air from one unit is not drawn into another.

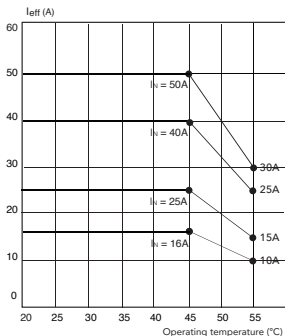

Current derating curves as a function of ambient temperature, (I_N = nominal current at 45°C) for an altitude up to 1000m.

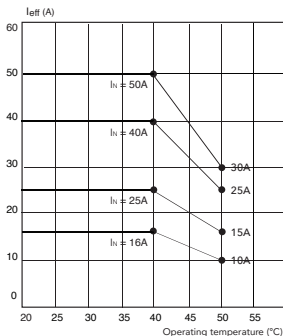

Current derating curves as a function of ambient temperature (I_N = nominal current at 40°C) for an altitude up to 2000m.



* H A 0 3 1 9 8 0 E N G *

Eurotherm Limited
Faraday Close, Durrington, Worthing
West Sussex BN13 3PL United Kingdom
Phone: +44 (0)1903 268500
www.eurotherm.co.uk

©2017 Schneider Electric. All Rights Reserved. All trademarks are owned by Schneider Electric Industries SAS
or its affiliated companies.

HA031980ENG Issue 3

CN35707