

Operating Instructions

Micropilot FMR63B

Free space radar
HART

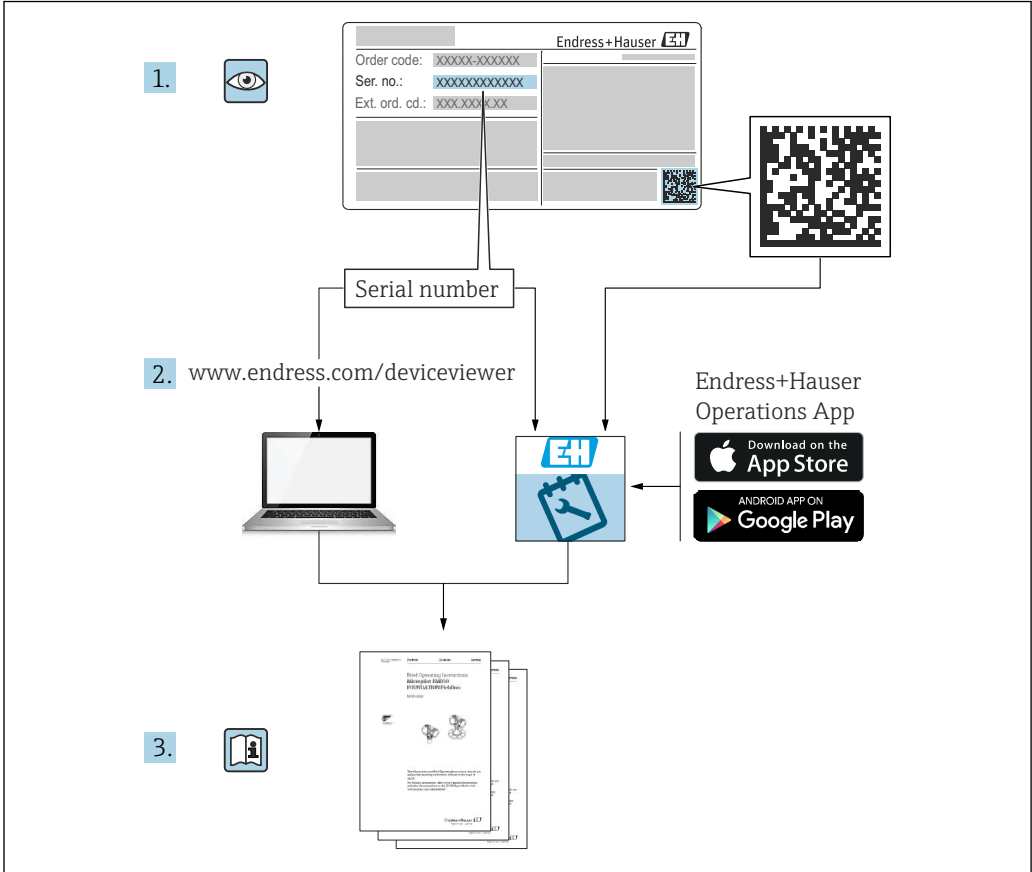



- Make sure the document is stored in a safe place such that it is always available when working on or with the device
- Avoid danger to individuals or the facility: read the "Basic safety instructions" section carefully, as well as all other safety instructions in the document that are specific to working procedures

The manufacturer reserves the right to modify technical data without prior notice. The Endress+Hauser sales organization will supply you with current information and updates to these instructions.

Table of contents

1	Document information	5		
1.1	Purpose of this document	5		
1.2	Symbols	5		
1.2.1	Safety symbols	5		
1.2.2	Symbols for certain types of information and graphics	5		
1.3	Documentation	6		
1.3.1	Technical Information (TI)	6		
1.3.2	Brief Operating Instructions (KA)	6		
1.3.3	Safety Instructions (XA)	6		
1.3.4	Functional Safety Manual (FY)	6		
1.4	List of abbreviations	6		
1.5	Registered trademarks	7		
2	Basic safety instructions	8		
2.1	Requirements for personnel	8		
2.2	Intended use	8		
2.3	Workplace safety	9		
2.4	Operational safety	9		
2.5	Product safety	9		
2.6	Functional Safety SIL (optional)	9		
2.7	IT security	9		
2.8	Device-specific IT security	10		
3	Product description	11		
3.1	Product design	11		
4	Incoming acceptance and product identification	12		
4.1	Incoming acceptance	12		
4.2	Product identification	12		
4.2.1	Nameplate	12		
4.2.2	Manufacturer address	13		
4.3	Storage and transport	13		
4.3.1	Storage conditions	13		
4.3.2	Transporting the product to the measuring point	13		
5	Installation	14		
5.1	General instructions	14		
5.2	Mounting requirements	14		
5.2.1	Internal vessel fittings	14		
5.2.2	Avoiding interference echoes	15		
5.2.3	Vertical alignment of antenna axis	15		
5.2.4	Radial alignment of the antenna	15		
5.2.5	Optimization options	15		
5.3	Mounting the measuring device	15		
5.3.1	Integrated antenna, PEEK 20 mm (0.75 in)	15		
5.3.2	Antenna, PTFE clad, flush mount 50 mm (2 in)	16		
5.3.3	Antenna, PTFE clad, flush mount 80 mm (3 in)	16		
5.3.4	Turning the housing	17		
5.3.5	Turning the display module	17		
5.3.6	Changing the installation position of the display module	18		
5.3.7	Closing the housing covers	20		
5.4	Post-mounting check	20		
6	Electrical connection	21		
6.1	Connecting requirements	21		
6.1.1	Cover with securing screw	21		
6.1.2	Potential equalization	21		
6.2	Connecting the device	22		
6.2.1	Supply voltage	22		
6.2.2	Cable specification	23		
6.2.3	4 to 20 mA HART	23		
6.2.4	Overvoltage protection	24		
6.2.5	Wiring	24		
6.2.6	Terminal assignment	25		
6.2.7	Cable entries	26		
6.2.8	Available device plugs	26		
6.3	Ensuring the degree of protection	27		
6.3.1	Cable entries	27		
6.4	Post-connection check	28		
7	Operation options	29		
7.1	Overview of operating options	29		
7.2	Operating keys and DIP switches on the HART electronic insert	29		
7.3	Structure and function of the operating menu	29		
7.3.1	User roles and related access authorization	29		
7.4	Access to the operating menu via the local display	30		
7.4.1	Device display (optional)	30		
7.4.2	Operation via Bluetooth® wireless technology (optional)	31		
7.5	Access to the operating menu via the operating tool	31		
7.6	DeviceCare	32		
7.6.1	Function scope	32		
7.7	FieldCare	32		
7.7.1	Function scope	32		
8	System integration	33		
8.1	Overview of device description files	33		
8.2	Measured variables via HART protocol	33		
9	Commissioning	34		
9.1	Preliminaries	34		
9.2	Function check	34		

9.3	Establishing a connection via FieldCare and DeviceCare	34	13.3	Replacement	49
9.3.1	Via HART protocol	34	13.3.1	HistoROM	50
9.3.2	Via service interface (CDI)	35	13.4	Return	50
9.4	Configuring the device address via software ..	35	13.5	Disposal	50
9.5	Setting the operating language	35	14	Accessories	51
9.5.1	Local display	35	14.1	Weather protection cover 316L	51
9.5.2	Operating tool	35	14.2	Plastic weather protection cover	51
9.6	Device configuration	36	14.3	M12 socket	52
9.6.1	Level measurement in liquids	36	14.4	Remote display FHX50B	52
9.6.2	Commissioning with the Commissioning wizard	36	14.5	Gas-tight feedthrough	53
9.7	Recording the Echo curve	36	14.6	Process adapter M24	53
9.8	"Simulation" submenu	36	14.7	Commubox FXA195 HART	53
10	Operation	37	14.8	HART Loop Converter HMX50	54
10.1	Reading off the device locking status	37	14.9	FieldPort SWA50	54
10.2	Reading off measured values	37	14.10	Wireless HART adapter SWA70	54
10.3	Adapting the device to process conditions	37	14.11	Fieldgate FXA42	54
10.4	Heartbeat Technology (optional)	37	14.12	Field Xpert SMT70	54
10.4.1	Heartbeat Verification	37	14.13	DeviceCare SFE100	54
10.4.2	Heartbeat Verification/Monitoring ..	37	14.14	FieldCare SFE500	54
11	Diagnostics and troubleshooting ...	38	14.15	Memograph M	55
11.1	General troubleshooting	38	14.16	RN42	55
11.1.1	General errors	38	15	Technical data	56
11.2	Error - SmartBlue operation	38	15.1	Input	56
11.3	Diagnostic information on local display	39	15.2	Output	62
11.3.1	Diagnostic message	39	15.3	Environment	66
11.4	Diagnostic event in the operating tool	41	15.4	Process	73
11.5	Adapting the diagnostic information	41	Index	76	
11.6	Queued diagnostic messages	41			
11.7	Diagnostic list	42			
11.8	List of diagnostic events	42			
11.9	Event logbook	44			
11.9.1	Event history	44			
11.9.2	Filtering the event logbook	44			
11.9.3	Overview of information events	45			
11.10	Resetting the device	45			
11.10.1	Resetting the device via the operating tool	45			
11.10.2	Resetting the device via keys on the electronic insert	46			
11.11	Device information	46			
11.12	Firmware history	47			
11.12.1	Version 01.00.zz	47			
12	Maintenance	48			
12.1	Exterior cleaning	48			
12.2	Seals	48			
13	Repair	49			
13.1	General information	49			
13.1.1	Repair concept	49			
13.1.2	Repair of Ex-certified devices	49			
13.2	Spare parts	49			

1 Document information

1.1 Purpose of this document

These Operating Instructions contain all the information that is required in the various phases of the life cycle of the device: from product identification, incoming acceptance and storage, to mounting, connection, operation and commissioning through to troubleshooting, maintenance and disposal.

1.2 Symbols

1.2.1 Safety symbols

DANGER

This symbol alerts you to a dangerous situation. Failure to avoid this situation will result in serious or fatal injury.

WARNING

This symbol alerts you to a dangerous situation. Failure to avoid this situation can result in serious or fatal injury.

CAUTION

This symbol alerts you to a dangerous situation. Failure to avoid this situation can result in minor or medium injury.

NOTICE

This symbol contains information on procedures and other facts which do not result in personal injury.

1.2.2 Symbols for certain types of information and graphics

Permitted

Procedures, processes or actions that are permitted

Preferred

Procedures, processes or actions that are preferred

Forbidden

Procedures, processes or actions that are forbidden

Tip

Indicates additional information



Reference to documentation



Reference to graphic



Notice or individual step to be observed

1, 2, 3

Series of steps



Result of a step



Operation via local display



Operation via operating tool



Write-protected parameter

1, 2, 3, ...

Item numbers

A, B, C, ...

Views



Safety instructions

Observe the safety instructions contained in the associated Operating Instructions

1.3 Documentation

The following types of documentation are available in the Download Area of the Endress +Hauser website (www.endress.com/downloads):



For an overview of the scope of the associated Technical Documentation, refer to the following:

- *Device Viewer* (www.endress.com/deviceviewer): Enter serial number from nameplate.
- *Endress+Hauser Operations app*: Enter serial number from nameplate or scan matrix code on nameplate.

1.3.1 Technical Information (TI)

Planning aid

The document contains all the technical data on the device and provides an overview of the accessories and other products that can be ordered for the device.

1.3.2 Brief Operating Instructions (KA)

Guide that takes you quickly to the 1st measured value

The Brief Operating Instructions contain all the essential information from incoming acceptance to initial commissioning.

1.3.3 Safety Instructions (XA)

Depending on the approval, the following Safety Instructions (XA) are supplied with the device. They are an integral part of the Operating Instructions.



The nameplate indicates the Safety Instructions (XA) that are relevant to the device.

1.3.4 Functional Safety Manual (FY)

Depending on the SIL approval, the Functional Safety Manual (FY) is an integral part of the Operating Instructions and applies in addition to the Operating Instructions, Technical Information and ATEX Safety Instructions.



The different requirements that apply for the protective function are described in the Functional Safety Manual (FY).

1.4 List of abbreviations

BA

Document type "Operating Instructions"

KA

Document type "Brief Operating Instructions"

TI

Document type "Technical Information"

SD

Document type "Special Documentation"

XA

Document type "Safety Instructions"

PN

Nominal pressure

MWP

Maximum working pressure

The MWP is indicated on the nameplate.

ToF

Time of Flight

FieldCare

Scalable software tool for device configuration and integrated plant asset management solutions

DeviceCare

Universal configuration software for Endress+Hauser HART, PROFIBUS, FOUNDATION Fieldbus and Ethernet field devices

DTM

Device Type Manager

 ϵ_r (Dk value)

Relative dielectric constant

Operating tool

The term "operating tool" is used in place of the following operating software:

- FieldCare / DeviceCare, for operation via HART communication and PC
- SmartBlue app, for operation using an Android or iOS smartphone or tablet

BD

Blocking Distance; no signals are analyzed within the BD.

PLC

Programmable logic controller (PLC)

1.5 Registered trademarks

HART®

Registered trademark of the FieldComm Group, Austin, Texas, USA

Bluetooth®

The *Bluetooth*® word mark and logos are registered trademarks owned by the Bluetooth SIG, Inc. and any use of such marks by Endress+Hauser is under license. Other trademarks and trade names are those of their respective owners.

Apple®

Apple, the Apple logo, iPhone, and iPod touch are trademarks of Apple Inc., registered in the U.S. and other countries. App Store is a service mark of Apple Inc.

Android®

Android, Google Play and the Google Play logo are trademarks of Google Inc.

KALREZ®, VITON®

Registered trademarks of DuPont Performance Elastomers L.L.C., Wilmington, DE USA

TRI-CLAMP®

Registered trademark of Ladish & Co., Inc., Kenosha, USA

2 Basic safety instructions

2.1 Requirements for personnel

The personnel for installation, commissioning, diagnostics and maintenance must fulfill the following requirements:

- ▶ Trained, qualified specialists must have a relevant qualification for this specific function and task.
- ▶ Personnel must be authorized by the plant owner/operator.
- ▶ Be familiar with federal/national regulations.
- ▶ Before starting work: personnel must read and understand the instructions in the manual and supplementary documentation as well as the certificates (depending on the application).
- ▶ Personnel must follow instructions and comply with general policies.

The operating personnel must fulfill the following requirements:

- ▶ Personnel are instructed and authorized according to the requirements of the task by the facility's owner-operator.
- ▶ Personnel follow the instructions in this manual.

2.2 Intended use

Application and media

The measuring device described in these Operating Instructions is intended for continuous, non-contact level measurement in liquids, pastes and sludges. The operating frequency is approx. 80 GHz with a maximum radiated peak power of 6.3 mW and an average output power of 63 μ W. Operation does not pose any danger whatsoever to humans and animals.

If the limit values specified in the "Technical data" and the conditions listed in the instructions and additional documentation are observed, the measuring device may be used for the following measurements only:

- ▶ Measured process variables: level, distance, signal strength
- ▶ Calculable process variables: volume or mass in any shape of vessel

To ensure that the measuring device remains in proper condition for the operation time:

- ▶ Use the measuring device only for media against which the process-wetted materials are adequately resistant.
- ▶ Observe the limit values in the "Technical data".

Incorrect use

The manufacturer is not liable for damage caused by improper or non-intended use.

Avoid mechanical damage:

- ▶ Do not touch or clean device surfaces with pointed or hard objects.

Clarification of borderline cases:

- ▶ For special fluids and fluids for cleaning, Endress+Hauser is glad to provide assistance in verifying the corrosion resistance of fluid-wetted materials, but does not accept any warranty or liability.

Residual risks

Due to heat transfer from the process as well as power loss in the electronics, the temperature of the electronics housing and the assemblies it contains (e.g. display module, main electronics module and I/O electronics module) may rise to 80 °C (176 °F). When in operation, the sensor may reach a temperature close to the medium temperature.

Danger of burns from contact with surfaces!

- ▶ For elevated fluid temperatures, ensure protection against contact to prevent burns.

2.3 Workplace safety

When working on and with the device:

- ▶ Wear the required personal protective equipment according to federal/national regulations.
- ▶ Switch off the supply voltage before connecting the device.

2.4 Operational safety

Risk of injury!

- ▶ Operate the device only if it is in proper technical condition, free from errors and faults.
- ▶ The operator is responsible for the interference-free operation of the device.

Modifications to the device

Unauthorized modifications to the device are not permitted and can lead to unforeseeable dangers:

- ▶ If modifications are nevertheless required, consult with the manufacturer.

Repair

To ensure continued operational safety and reliability:

- ▶ Carry out repairs on the device only if they are expressly permitted.
- ▶ Observe federal/national regulations pertaining to the repair of an electrical device.
- ▶ Use only original spare parts and accessories from the manufacturer.

Hazardous area

To eliminate danger to persons or the installation when the device is used in the hazardous area (e.g. explosion protection, pressure vessel safety):

- ▶ Check the nameplate to verify whether the ordered device can be put to its intended use in the hazardous area.
- ▶ Observe the specifications in the separate supplementary documentation, which is an integral part of this manual.

2.5 Product safety

This device is designed in accordance with good engineering practice to meet state-of-the-art safety requirements, has been tested, and left the factory in a condition in which it is safe to operate.

It meets general safety standards and legal requirements. It also complies with the EC directives listed in the device-specific EC Declaration of Conformity. Endress+Hauser confirms this by affixing the CE mark to the device.

2.6 Functional Safety SIL (optional)

The Functional Safety Manual must be strictly observed for devices that are used in functional safety applications.

2.7 IT security

We only provide a warranty if the device is installed and used as described in the Operating Instructions. The device is equipped with security mechanisms to protect it against any inadvertent changes to the device settings. IT security measures in line with operators' security standards and designed to provide additional protection for the device and device data transfer must be implemented by the operators themselves.

2.8 Device-specific IT security

The device offers specific functions to support protective measures by the operator. These functions can be configured by the user and guarantee greater in-operation safety if used correctly. An overview of the most important functions is provided in the following section:

- Write protection via hardware write protection switch
- Access code (applies for operation via display, Bluetooth or FieldCare, DeviceCare, ASM, PDM)

3 Product description

3.1 Product design

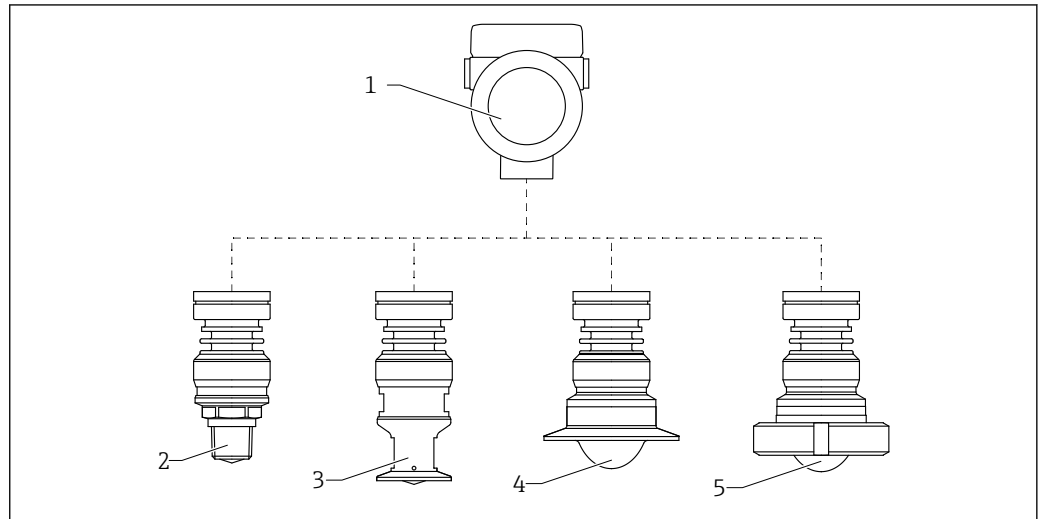

A0046663

1 Design of the Micropilot FMR63B

- 1 Electronics housing
- 2 Integrated antenna, PEEK, 20 mm (0.75 in), thread
- 3 Integrated antenna, PEEK, 20 mm (0.75 in), M24 adapter
- 4 Antenna, cladded flush mount, PTFE, with Tri-Clamp ISO2852
- 5 Antenna, cladded flush mount, PTFE, slotted nut DIN11851

4 Incoming acceptance and product identification

4.1 Incoming acceptance

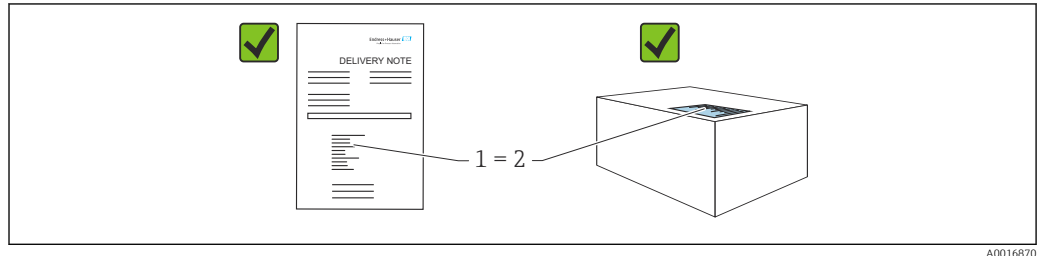

Check the following during incoming acceptance:

- Is the order code on the delivery note (1) identical to the order code on the product sticker (2)?
- Are the goods undamaged?
- Do the data on the nameplate correspond to the order specifications and the delivery note?
- Is the documentation provided?
- If required (see nameplate): are the Safety Instructions (XA) provided?

 If one of these conditions is not met, please contact the manufacturer's sales office.

4.2 Product identification

The following options are available for the identification of the measuring device:

- Nameplate specifications
- Extended order code with breakdown of the device features on the delivery note
- ▶ *Device Viewer* (www.endress.com/deviceviewer); manually enter the serial number from the nameplate.
 - ↳ All the information about the measuring device is displayed.
- ▶ *Endress+Hauser Operations app*; manually enter the serial number indicated on the nameplate or scan the 2D matrix code on the nameplate.
 - ↳ All the information about the measuring device is displayed.

4.2.1 Nameplate

The information that is required by law and is relevant to the device is shown on the nameplate, e.g.:

- Manufacturer identification
- Order number, extended order code, serial number
- Technical data, degree of protection
- Firmware version, hardware version
- Approval-related information, reference to Safety Instructions (XA)
- DataMatrix code (information about the device)

4.2.2 Manufacturer address

Endress+Hauser SE+Co. KG
Hauptstraße 1
79689 Maulburg, Germany
Place of manufacture: See nameplate.

4.3 Storage and transport

4.3.1 Storage conditions

- Use the original packaging
- Store the device in clean and dry conditions and protect from damage caused by shocks

Storage temperature range

See Technical Information.

4.3.2 Transporting the product to the measuring point

WARNING

Incorrect transport!

The housing or sensor can be damaged or pull off. Risk of injury!

- ▶ Transport the device to the measuring point in its original packaging or by the process connection.
- ▶ Always secure lifting equipment (slings, eyes, etc.) at the process connection and never lift the device by the electronic housing or sensor. Pay attention to the center of gravity of the device so that it does not tilt or slip unintentionally.

5 Installation

5.1 General instructions

⚠ WARNING

Loss of protection rating if the device is opened in a wet environment.

- ▶ Only open the device in a dry environment!

1. Install the device or turn the housing so that the cable entries do not point upwards.

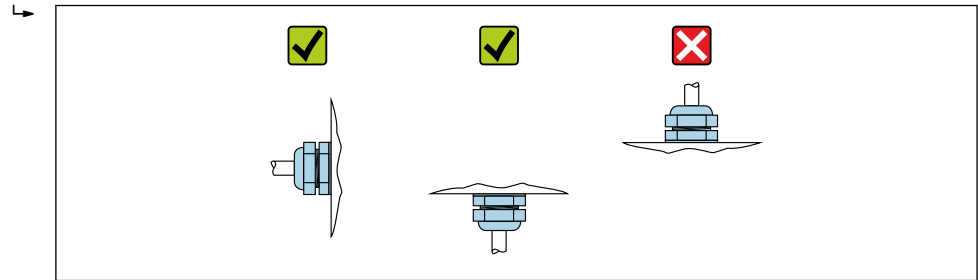

A0029263

2. Always firmly tighten the housing cover and the cable entries.
3. Counter-tighten the cable entries.
4. A drip loop must be provided when laying the cables.

5.2 Mounting requirements

5.2.1 Internal vessel fittings

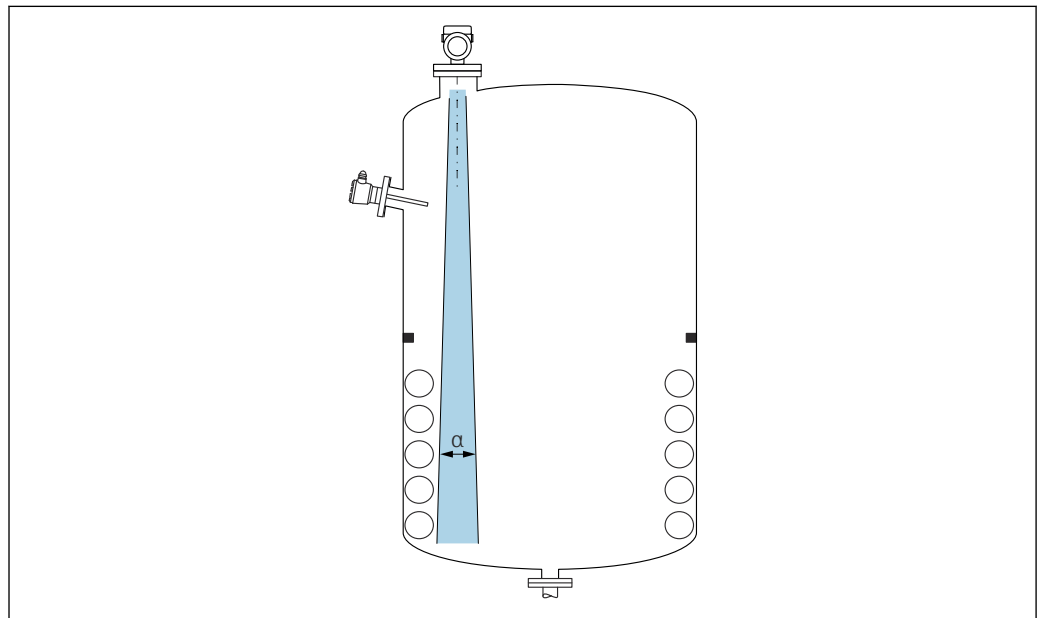

A0031777

Avoid internal fittings (point level switches, temperature sensors, struts, vacuum rings, heating coils, baffles etc.) inside the signal beam. Pay attention to the beam angle α .

5.2.2 Avoiding interference echoes

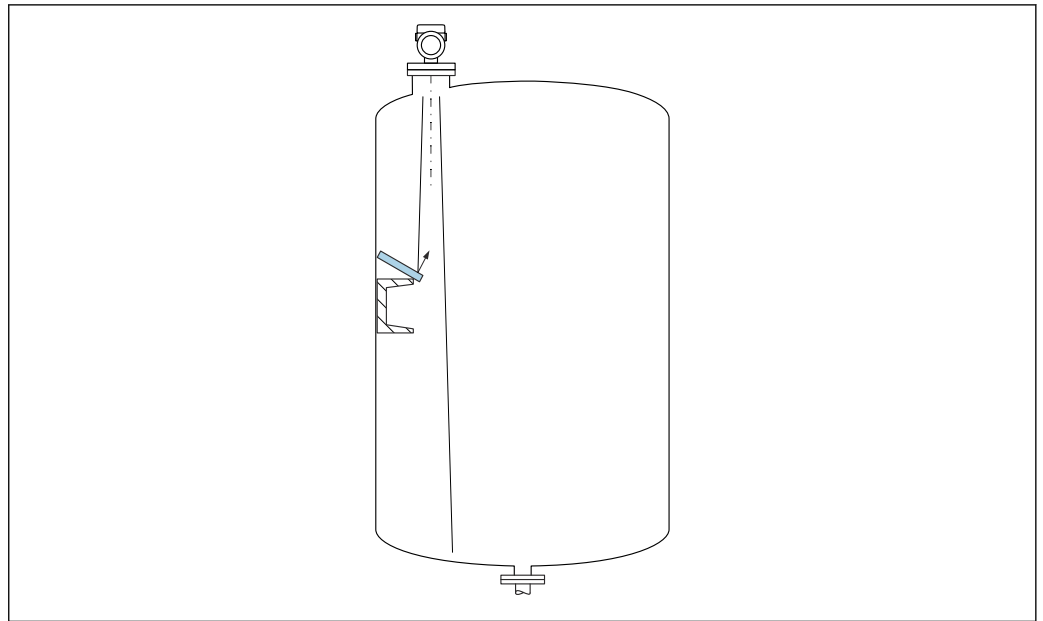

A0031813

Metal deflector plates, installed at an angle to scatter the radar signals, help prevent interference echoes.

5.2.3 Vertical alignment of antenna axis

Align the antenna so that it is perpendicular to the product surface.

i The maximum reach of the antenna can be reduced, or additional interference signals can occur, if the antenna is not installed perpendicular to the product.

5.2.4 Radial alignment of the antenna

Based on the directional characteristic, radial alignment of the antenna is not necessary.

5.2.5 Optimization options

Mapping

Measurement can be optimized by electronically suppressing interference echoes. See the **Confirm distance** parameter.

5.3 Mounting the measuring device

5.3.1 Integrated antenna, PEEK 20 mm (0.75 in)

Information concerning threaded connections

- When screwing in, turn by the hex bolt only.
- Tool: open-ended wrench 36 mm
- Maximum permissible torque: 50 Nm (36 lbf ft)

Information about the mounting nozzle

The maximum nozzle length H_{max} depends on the nozzle diameter D .

Maximum nozzle length H_{max} as a function of the nozzle diameter D

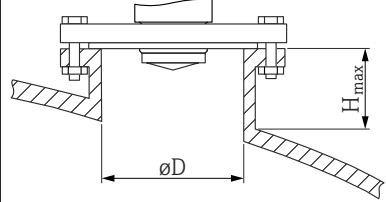
	ϕD	H_{max}
	40 to 50 mm (1.6 to 2 in)	200 mm (8 in)
	50 to 80 mm (2 to 3.2 in)	300 mm (12 in)
	80 to 100 mm (3.2 to 4 in)	450 mm (18 in)
	100 to 150 mm (4 to 6 in)	550 mm (22 in)
	≥ 150 mm (6 in)	850 mm (34 in)

i In the case of longer nozzles, reduced measuring performance must be expected.

Please note the following:

- The end of the nozzle must be smooth and free from burrs.
- The edge of the nozzle should be rounded.
- Mapping must be performed.
- Please contact the manufacturer's support department for applications with nozzles that are higher than indicated in the table.

5.3.2 Antenna, PTFE clad, flush mount 50 mm (2 in)

i The cladding on the antenna also acts as a process seal. An additional seal is not required for installation.

Information about the mounting nozzle

The maximum nozzle length H_{max} depends on the nozzle diameter D .

The maximum length of the nozzle H_{max} depends on the nozzle diameter D

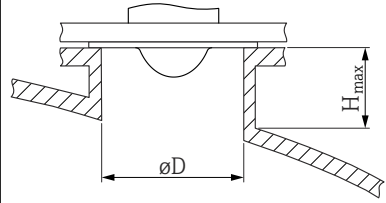
	ϕD	H_{max}
	50 to 80 mm (2 to 3.2 in)	600 mm (24 in)
	80 to 100 mm (3.2 to 4 in)	1000 mm (40 in)
	100 to 150 mm (4 to 6 in)	1250 mm (50 in)
	≥ 150 mm (6 in)	1850 mm (74 in)

i In the case of longer nozzles, reduced measuring performance must be expected.

Please note the following:

- The end of the nozzle must be smooth and free from burrs.
- The edge of the nozzle should be rounded.
- Mapping must be performed.
- Please contact the manufacturer's support department for applications with nozzles that are higher than indicated in the table.

5.3.3 Antenna, PTFE clad, flush mount 80 mm (3 in)

i The cladding on the antenna also acts as a process seal. An additional seal is not required for installation.

Information about the mounting nozzle

The maximum nozzle length H_{max} depends on the nozzle diameter D .

The maximum length of the nozzle H_{max} depends on the nozzle diameter D

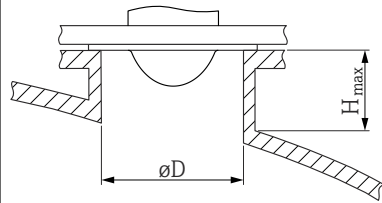
	ϕD	H_{max}
	80 to 100 mm (3.2 to 4 in)	1750 mm (70 in)
	100 to 150 mm (4 to 6 in)	2200 mm (88 in)
	≥ 150 mm (6 in)	3300 mm (132 in)

i In the case of longer nozzles, reduced measuring performance must be expected.

Please note the following:

- The end of the nozzle must be smooth and free from burrs.
- The edge of the nozzle should be rounded.
- Mapping must be performed.
- Please contact the manufacturer's support department for applications with nozzles that are higher than indicated in the table.

5.3.4 Turning the housing

The housing can be rotated up to 380° by loosening the locking screw.

Your benefits

- Easy installation due to optimum alignment of housing
- Easily accessible device operation
- Optimum readability of the local display (optional)

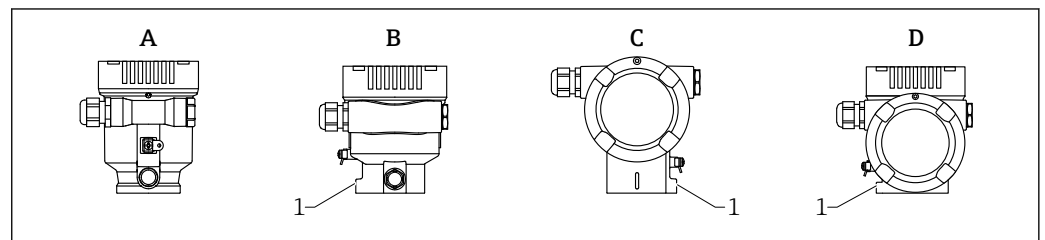

- A Plastic single compartment housing (no locking screw)
- B Aluminum single compartment housing
- C Dual compartment housing
- D Dual compartment housing, L-form
- 1 Locking screw

NOTICE

The housing cannot be unscrewed fully.

- ▶ Loosen the external locking screw by a maximum of 1.5 turns. If the screw is unscrewed too much or completely (beyond the screw anchor point), small parts (counter disk) can become loose and fall out.
- ▶ Tighten the securing screw (hexagon socket 4 mm (0.16 in)) with maximum 3.5 Nm (2.58 lbf ft) \pm 0.3 Nm (0.22 lbf ft).

5.3.5 Turning the display module

⚠ WARNING

Supply voltage switched on!

Risk of electric shock and/or explosion!

- ▶ Switch off the supply voltage before opening the measuring device.

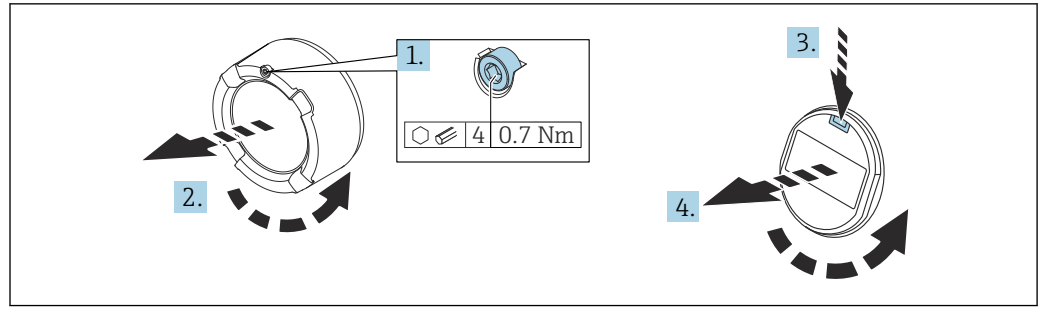

A0038224

1. If fitted: release the screw of the cover lock for the electronics compartment cover using the Allen key.
2. Unscrew the electronics compartment cover from the transmitter housing and check the cover seal.
3. Press the release mechanism and remove the display module.
4. Turn the display module to the desired position: maximum $4 \times 90^\circ$ in each direction. Fit the display module on the electronics compartment in the desired position until it clicks into place. Screw the electronics compartment cover back onto the transmitter housing. If fitted: tighten the screw of the cover lock using the Allen key 0.7 Nm (0.52 lbf ft) $\pm 0.2 \text{ Nm}$ (0.15 lbf ft).

5.3.6 Changing the installation position of the display module

The installation position of the display can be changed in the case of the dual compartment housing, L-form.

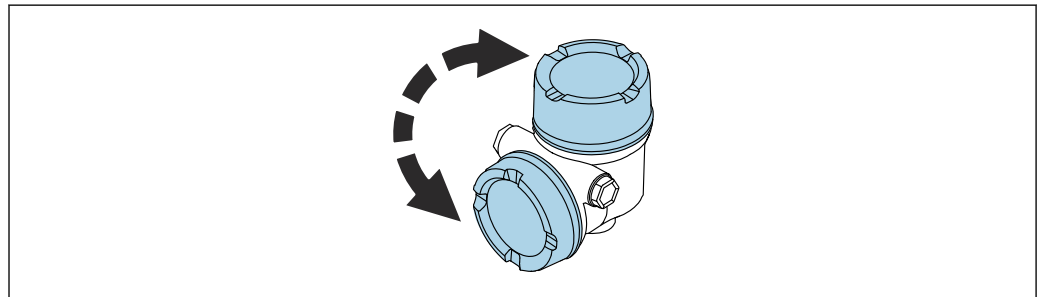

A0048401

⚠ WARNING

Supply voltage switched on!

Risk of electric shock and/or explosion!

- ▶ Switch off the supply voltage before opening the measuring device.

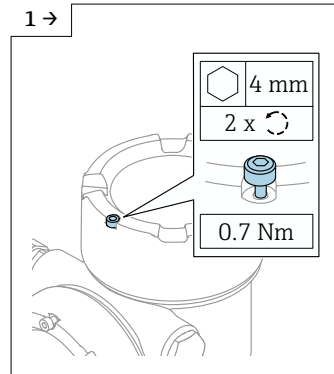

A0046831

- ▶ If fitted: release the screw of the cover lock for the display cover using the Allen key.

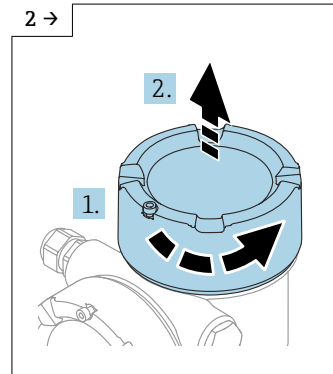

A0046832

- ▶ Unscrew the display cover and check the cover seal.

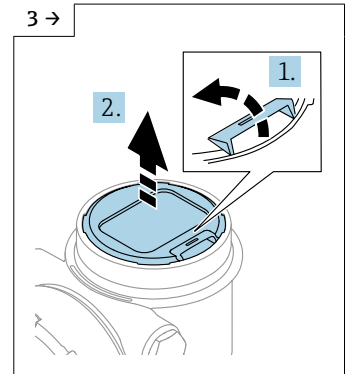

A0046833

- ▶ Press the release mechanism, remove the display module.

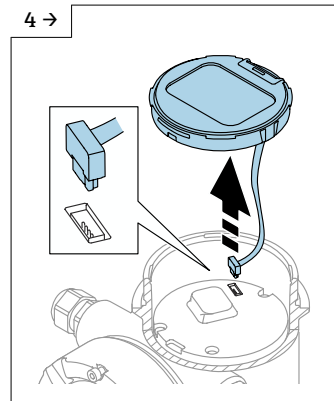

A0046834

- ▶ Release the connection.

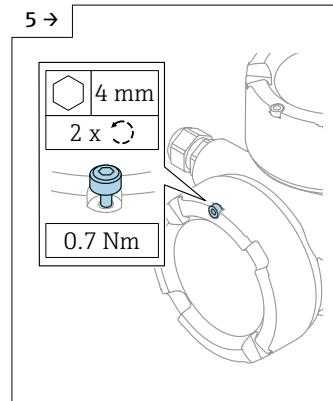

A0046923

- ▶ If fitted: release the screw of the cover lock for the connection compartment cover using the Allen key.

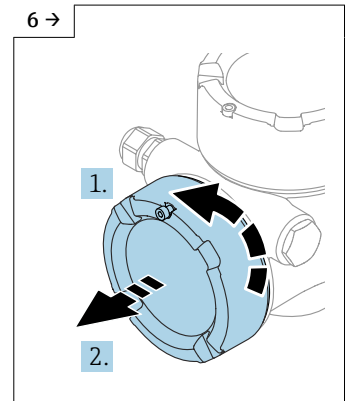

A0046924

- ▶ Unscrew the connection compartment cover, check the cover seal. Screw this cover onto the electronics compartment instead of the display cover. If fitted: tighten the screw of the cover lock using the Allen key

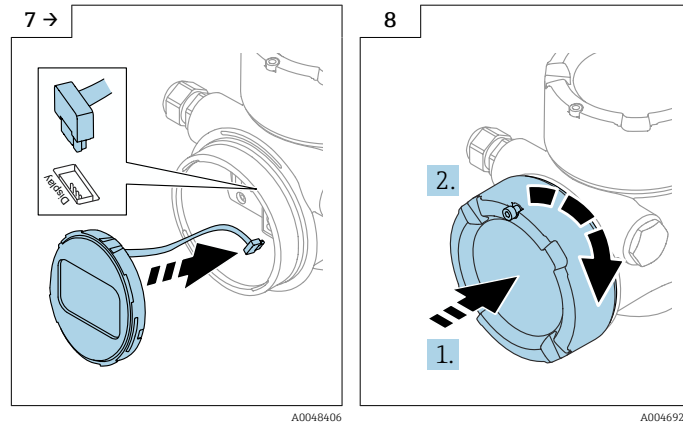

- ▶ Plug in the connection for the display module in the connection compartment.
- ▶ Fit the display module in the desired position until it clicks into place.
- ▶ Screw the display cover firmly back onto the housing. If fitted: tighten the screw of the cover lock using the Allen key 0.7 Nm (0.52 lbf ft).

5.3.7 Closing the housing covers

NOTICE

Thread and housing damaged from dirt!

- ▶ Remove dirt (e.g. sand) on the cover and housing thread.
- ▶ If you encounter resistance when closing the cover, check the thread for dirt and clean it.

i Housing thread

The thread of the electronics and connection compartment is coated with lubricant varnish.

- ✘ Avoid additional lubrication.

5.4 Post-mounting check

- Is the device free from damage (visual inspection)?
- Are the measuring point identification and labeling correct (visual inspection)?
- Is the measuring device protected against precipitation and sunlight?
- Are the securing screws and cover lock tightened securely?
- Does the measuring device comply with the measuring point specifications?

For example:

- Process temperature
- Process pressure
- Ambient temperature
- Measuring range

6 Electrical connection

6.1 Connecting requirements

6.1.1 Cover with securing screw

In the case of devices for use in the hazardous area with a certain type of protection, the cover is sealed by a securing screw.

NOTICE

If the securing screw is not positioned correctly, the cover cannot provide secure sealing.

- ▶ Open the cover: slacken the screw of the cover lock with a maximum of 2 turns so that the screw does not fall out. Fit the cover and check the cover seal.
- ▶ Close the cover: screw the cover securely onto the housing, making sure that the securing screw is positioned correctly. There should not be any gap between the cover and housing.

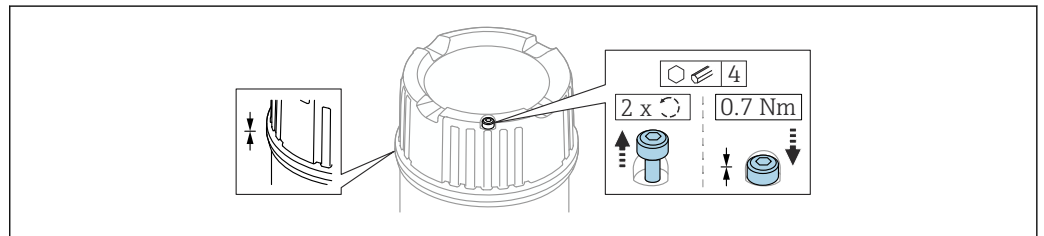

A0039520

2 Cover with securing screw

6.1.2 Potential equalization

The protective ground on the device must not be connected. If necessary, the potential matching line can be connected to the outer ground terminal of the transmitter before the device is connected.

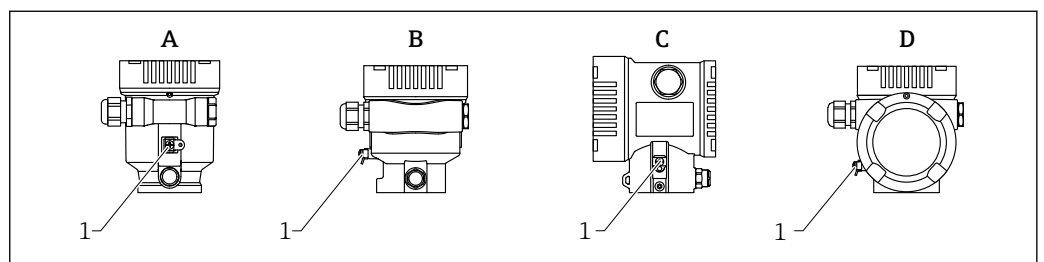

A0046583

- A Single compartment housing, plastic
- B Single compartment housing, aluminum
- C Dual compartment housing
- D Dual compartment housing, L-form
- 1 Ground terminal for connecting the potential matching line

⚠ WARNING

Explosion Hazard!

- ▶ Please refer to the separate documentation on applications in hazardous areas for the safety instructions.



For optimum electromagnetic compatibility:

- Keep the potential matching line as short as possible
- Observe a cross-section of at least 2.5 mm² (14 AWG)

6.2 Connecting the device

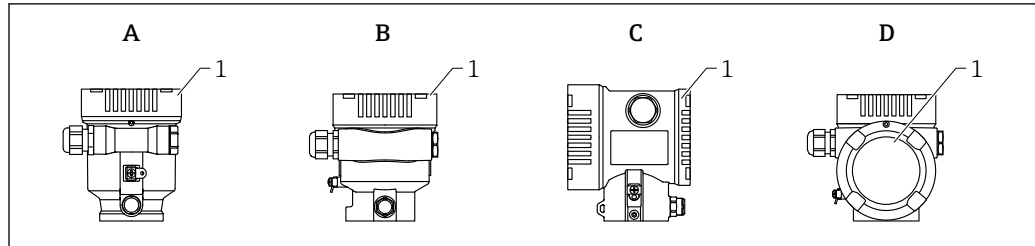

- A Plastic single compartment housing
 B Aluminum single compartment housing
 C Dual compartment housing
 D Dual compartment housing, L-form
 1 Connection compartment cover



Housing thread

The thread of the electronics and connection compartment is coated with lubricant varnish.

- Avoid additional lubrication.

6.2.1 Supply voltage

The supply voltage depends on the selected type of device approval

Non-hazardous, Ex d, Ex e	10.5 to 35 V _{DC}
Ex i	10.5 to 30 V _{DC}
Nominal current	4 to 20 mA



The power unit must be tested to ensure it meets safety requirements (e.g., PELV, SELV, Class 2) and must comply with the relevant protocol specifications.

A suitable circuit breaker must be provided for the device in accordance with IEC/EN61010-1

Device display and Bluetooth

Depending on the supply voltage and current consumption (see the chart)

- the background lighting is switched on or off
- the Bluetooth function (order option) can be switched on or off optionally

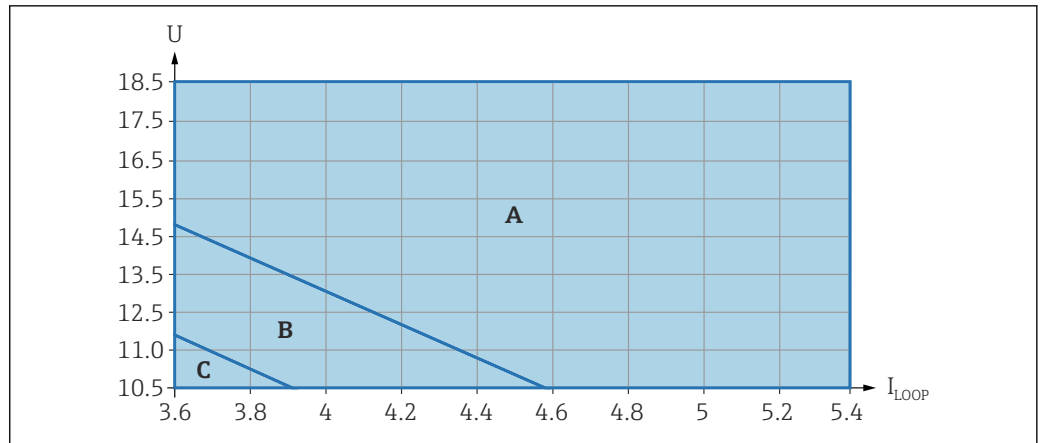

A0047056

- A Display lighting switched on, Bluetooth can be switched on optionally
- B Display lighting switched off, Bluetooth can be switched on optionally
- C Display lighting switched off and Bluetooth not active

6.2.2 Cable specification

Rated cross-section

- Supply voltage
0.5 to 2.5 mm² (20 to 13 AWG)
- Protective earth or grounding of the cable shield
> 1 mm² (17 AWG)
- External ground terminal
0.5 to 4 mm² (20 to 12 AWG)

Cable outer diameter

The cable outer diameter depends on the cable gland used

- Coupling, plastic:
Ø5 to 10 mm (0.2 to 0.38 in)
- Coupling, nickel-plated brass:
Ø7 to 10.5 mm (0.28 to 0.41 in)
- Coupling, stainless steel:
Ø7 to 12 mm (0.28 to 0.47 in)

6.2.3 4 to 20 mA HART

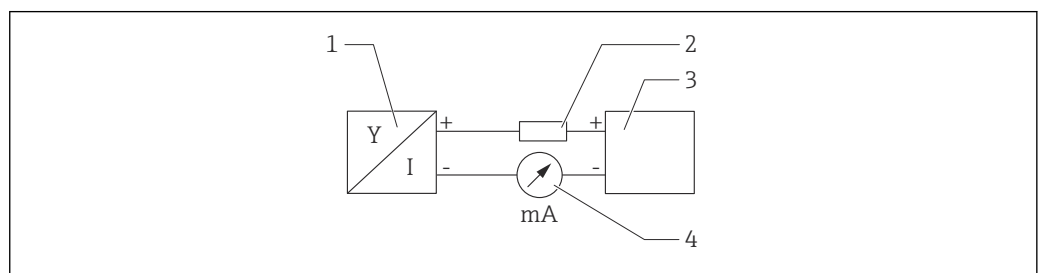

A0028908

3 Block diagram of HART connection

- 1 Device with HART communication
- 2 HART communication resistor
- 3 Power supply
- 4 Multimeter or ammeter

i The HART communication resistor of 250 Ω in the signal line is always necessary in the case of a low-impedance power supply.

Take the voltage drop into consideration:

Maximum 6 V for a 250 Ω communication resistor

6.2.4 Overvoltage protection

The overvoltage protection can optionally be ordered as a "Mounted accessory" via the product structure

Devices without optional overvoltage protection

Equipment from Endress+Hauser fulfills the requirements of the product standard IEC / DIN EN 61326-1 (Table 2 Industrial Environment).

Depending on the type of port (DC power supply, input/output port) different testing levels according to IEC / DIN EN 61326-1 against transient overvoltages (Surge) are applied (IEC / DIN EN 61000-4-5 Surge):

Test level on DC power ports and input/output ports is 1 000 V line to earth

Devices with optional overvoltage protection

- Spark-over voltage: min. 400 V_{DC}
- Tested according to IEC / DIN EN 60079-14 sub chapter 12.3 (IEC / DIN EN 60060-1 chapter 7)
- Nominal discharge current: 10 kA

Overvoltage category

Overvoltage category II

6.2.5 Wiring

WARNING

Supply voltage might be connected!

Risk of electric shock and/or explosion!

- ▶ If the device is used in hazardous areas, make sure to comply with national standards and the specifications in the Safety Instructions (XAs). The specified cable gland must be used.
- ▶ The supply voltage must match the specifications on the nameplate.
- ▶ Switch off the supply voltage before connecting the device.
- ▶ If necessary, the potential matching line can be connected to the outer ground terminal of the device before the power supply lines are connected.
- ▶ A suitable circuit breaker should be provided for the device in accordance with IEC/EN 61010.
- ▶ The cables must be adequately insulated, with due consideration given to the supply voltage and the overvoltage category.
- ▶ The connecting cables must offer adequate temperature stability, with due consideration given to the ambient temperature.
- ▶ Only operate the measuring device with the covers closed.

Connect the device in the following order:

1. Release the cover lock (if provided).
2. Unscrew the cover.
3. Guide the cables into the cable glands or cable entries.
4. Connect the cables.
5. Tighten the cable glands or cable entries so that they are leak-tight. Counter-tighten the housing entry.
6. Screw the cover securely back onto the connection compartment.
7. If provided: tighten the screw of the cover lock using the Allen key 0.7 Nm (0.52 lbf ft) ±0.2 Nm (0.15 lbf ft).

6.2.6 Terminal assignment

Single compartment housing

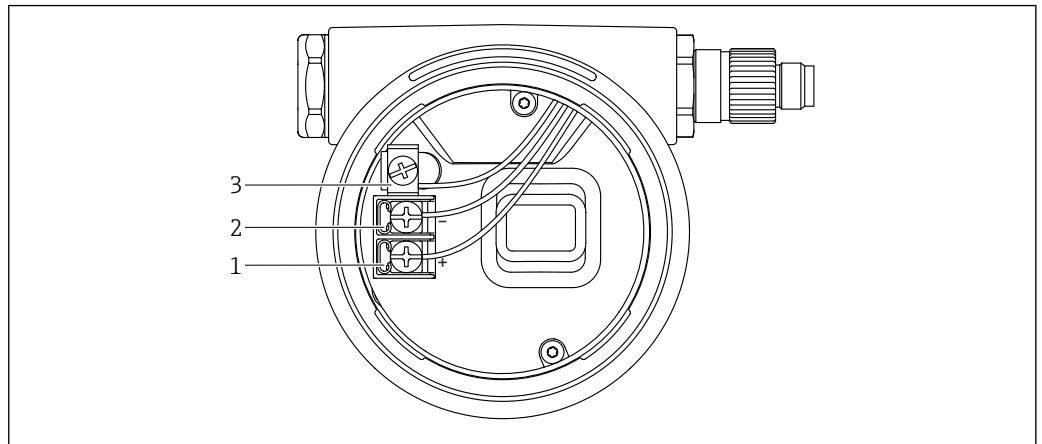

A0042594

4 Connection terminals and ground terminal in the connection compartment

- 1 Positive terminal
- 2 Negative terminal
- 3 Internal ground terminal

Dual compartment housing

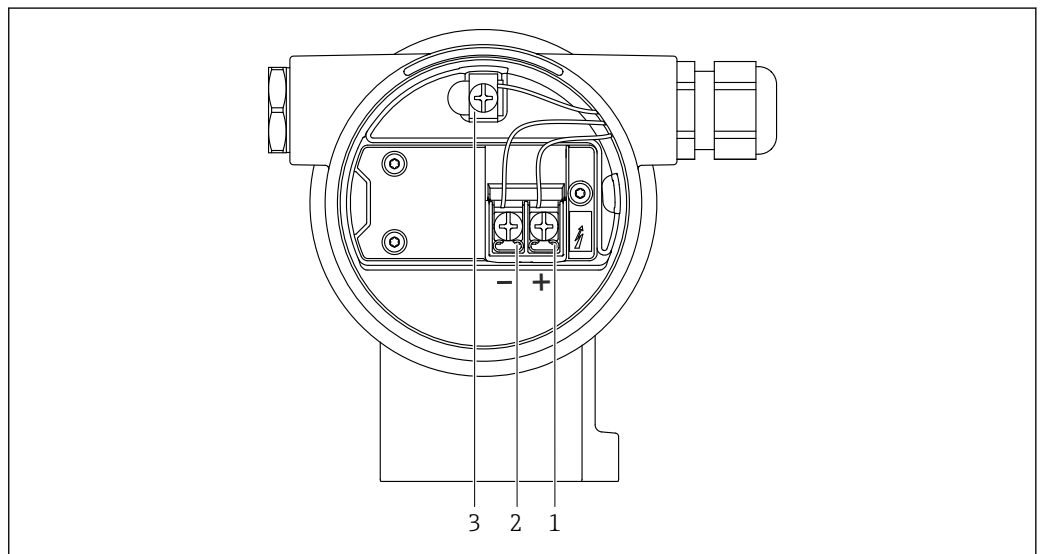

A0042803

5 Connection terminals and ground terminal in the connection compartment

- 1 Positive terminal
- 2 Negative terminal
- 3 Internal ground terminal

Dual compartment housing, L-form

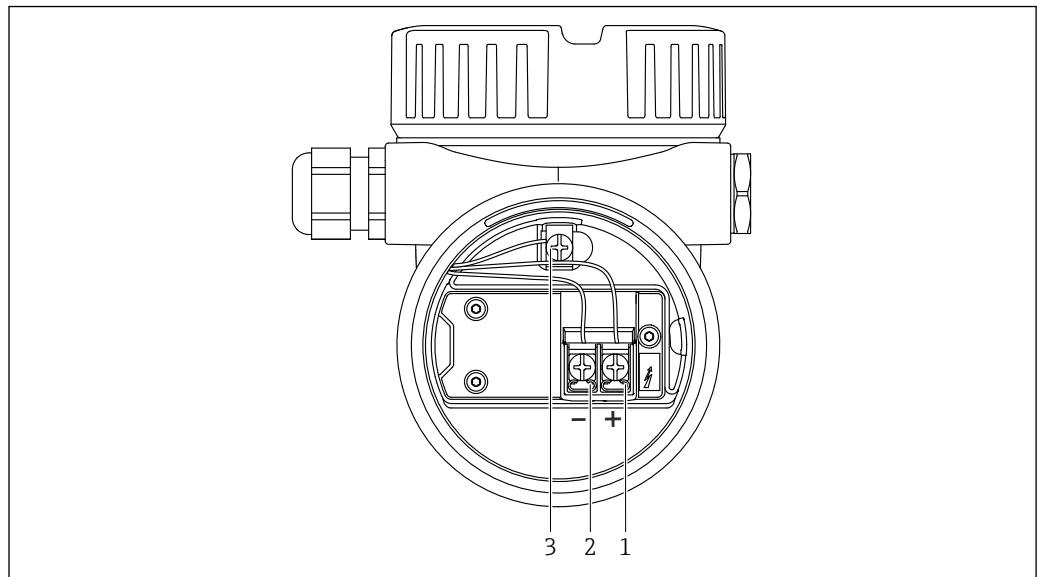

A0046584

6 Connection terminals and ground terminal in the connection compartment

- 1 Positive terminal
- 2 Negative terminal
- 3 Internal ground terminal

6.2.7 Cable entries

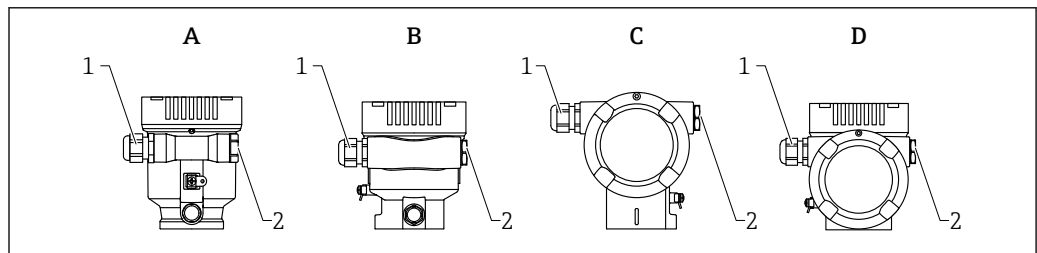

A0046584

- A Single compartment housing, plastic
- B Single compartment housing, aluminum
- C Dual compartment housing
- D Dual compartment housing, L-form
- 1 Cable entry
- 2 Dummy plug

The type of cable entry depends on the device version ordered.

i Always route connecting cables downwards so that moisture cannot penetrate the connection compartment.

If necessary, create a drip loop or use a weather protection cover.

6.2.8 Available device plugs

i In the case of devices with a plug, it is not necessary to open the housing for connection purposes.

Use the enclosed seals to prevent the penetration of moisture into the device.

Devices with M12 plug

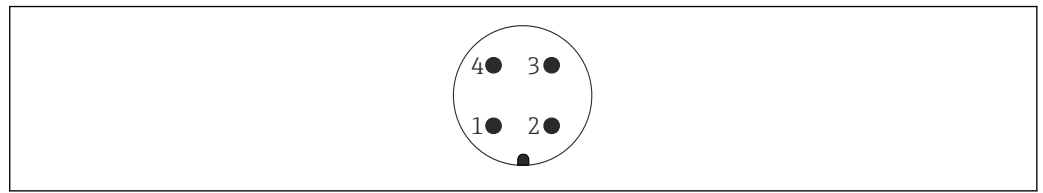

A0011175

- 1 Signal +
- 2 Not assigned
- 3 Signal -
- 4 Ground

Measuring devices with Harting plug Han7D

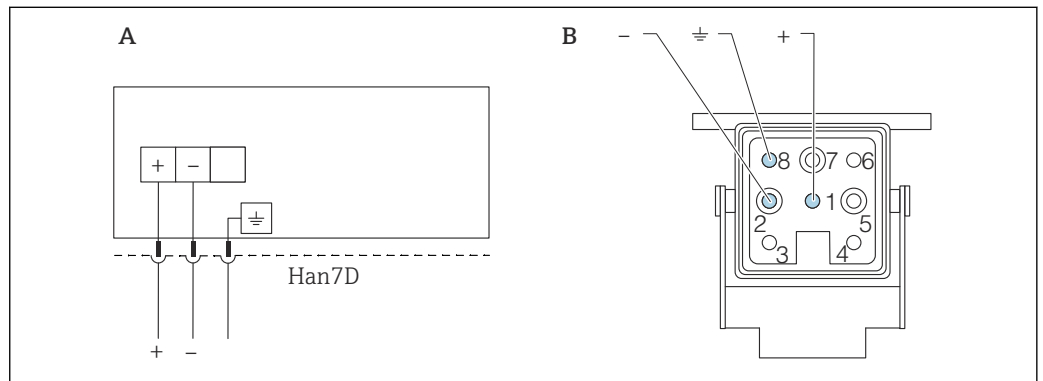

A0041011

- A Electrical connection for devices with Harting plug Han7D
- B View of the plug-in connection on the device
- Brown
- ⊕ Green/yellow
- + Blue

Material

CuZn, gold-plated plug-in jack and plug contacts

6.3 Ensuring the degree of protection

6.3.1 Cable entries

- Gland M20, plastic, IP66/68 NEMA TYPE 4X/6P
- Gland M20, nickel-plated brass, IP66/68 NEMA TYPE 4X/6P
- Gland M20, 316L, IP66/68 NEMA TYPE 4X/6P
- Thread M20, IP66/68 NEMA TYPE 4X/6P
- Thread G1/2, IP66/68 NEMA TYPE 4X/6P

If the G1/2 thread is selected, the device is delivered with an M20 thread as standard and a G1/2 adapter is included with the delivery, along with the corresponding documentation

- Thread NPT1/2, IP66/68 TYPE 4X/6P
- Dummy plug transport protection: IP22, TYPE 2
- HAN7D plug, 90 degrees, IP65 NEMA Type 4X
- M12 plug
 - When housing is closed and connecting cable is plugged in: IP66/67, NEMA Type 4X
 - When housing is open or connecting cable is not plugged in: IP20, NEMA Type 1

NOTICE**Plug M12 and plug HAN7D: incorrect mounting can invalidate the IP protection class!**

- ▶ The degree of protection only applies if the connecting cable used is plugged in and screwed tight.
- ▶ The degree of protection only applies if the connecting cable used is specified according to IP67, NEMA Type 4X.
- ▶ The IP protection classes are only maintained if the dummy cap is used or the cable is connected.

6.4 Post-connection check

- Are the device or cables undamaged (visual inspection)?
- Do the cables used comply with the requirements?
- Do the mounted cables have strain relief?
- Cable glands mounted, securely tightened and leak-tight?
- Does the supply voltage correspond to the specifications on the nameplate?
- No reverse polarity, terminal assignment correct?
- Cover screwed down correctly?
- Cover lock tightened correctly?

7 Operation options

7.1 Overview of operating options

- Operation via operating keys and DIP switches on the electronic insert
- Operation via optical operating keys on the device display (optional)
- Operation via Bluetooth® wireless technology (with optional device display with Bluetooth) with Smartblue app or FieldXpert, DeviceCare
- Operation via operating tool (Endress+Hauser FieldCare/DeviceCare, handheld terminal, AMS, PDM, ...)

7.2 Operating keys and DIP switches on the HART electronic insert

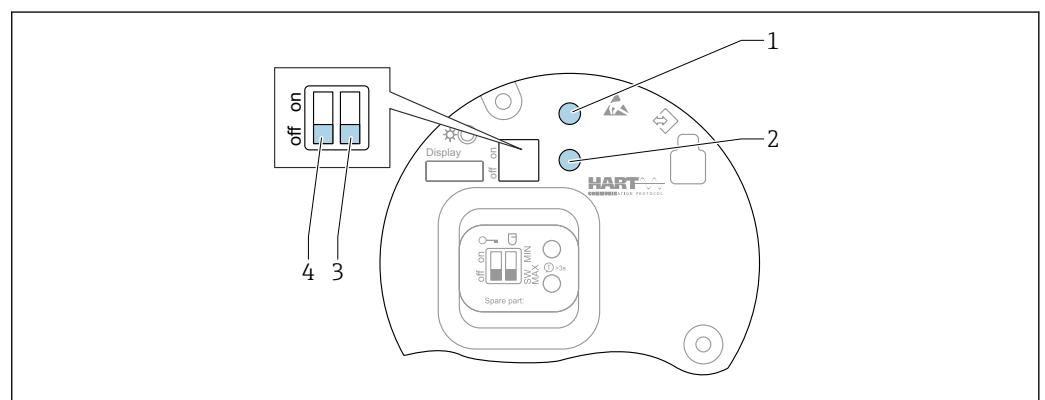

A0046129

 7 Operating keys and DIP switches on the HART electronic insert

- 1 Operating key for reset password (for Bluetooth login and Maintenance user role)
- 1+2 Operating keys for device reset (as-delivered state)
- 2 Operating key II (only for factory reset)
- 3 DIP switch for alarm current
- 4 DIP switch for locking and unlocking the device

 The setting of the DIP switches on the electronic insert has priority over the settings made via other operation methods (e.g. FieldCare/DeviceCare).

7.3 Structure and function of the operating menu

The differences between the structure of the operating menus of the local display and the Endress+Hauser FieldCare or DeviceCare operating tools can be summarized as follows:

The local display is suitable for configuring simple applications.

The operating tools (FieldCare, DeviceCare, SmartBlue, AMS, PDM, ...) can be used to configure the parameters of wide-ranging applications.

Wizards help the user to commission the various applications. The user is guided through the individual configuration steps.

7.3.1 User roles and related access authorization

The two user roles **Operator** and **Maintenance** (as-delivered state) have different write access to the parameters if a device-specific access code has been defined. This access code protects the device configuration from unauthorized access.

If an incorrect access code is entered, the user obtains the access rights of the **Operator** role.

7.4 Access to the operating menu via the local display

7.4.1 Device display (optional)

Possible to operate the optical operating keys through the cover. No need to open the device.

Functions:

- Display of measured values and fault and notice messages
 - Background lighting, which switches from green to red in the event of an error
 - The device display can be removed for easier operation
- i** Backlighting is switched on or off depending on the supply voltage and the current consumption.
- i** The device display is also optionally available with Bluetooth® wireless technology.

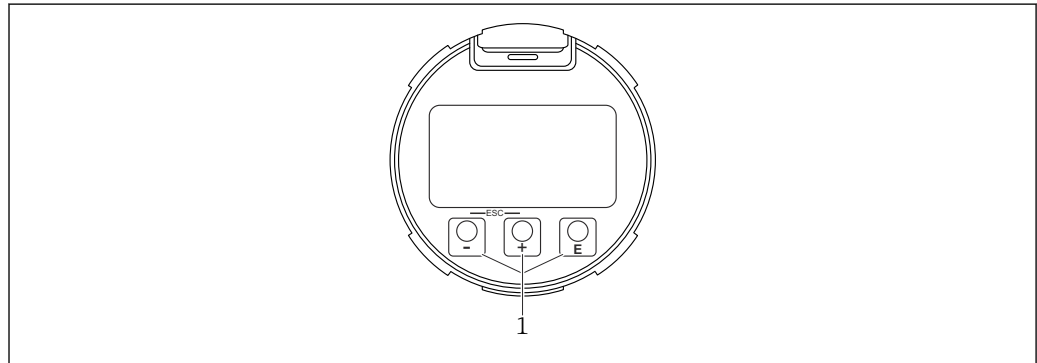

8 Graphic display with optical operating keys (1)

A0039284

- Key **+**
 - Navigate downwards in the picklist
 - Edit the numerical values or characters within a function
- Key **-**
 - Navigate upwards in the picklist
 - Edit the numerical values or characters within a function
- Key **E**
 - Change from main display to main menu
 - Confirm entry
 - Jump to the next item
 - Select a menu item and activate the edit mode
 - Unlock/lock the display operation
 - Press and hold the **E** key to display a short description of the selected parameter (if available)
- **+** key and **-** key (ESC function)
 - Exit edit mode for a parameter without saving the changed value
 - Menu at a selection level: pressing the keys simultaneously takes the user back up a level in the menu
 - Press and hold the keys simultaneously to return to the upper level

7.4.2 Operation via Bluetooth® wireless technology (optional)

Requirement

- Device with device display including Bluetooth
- Smartphone or tablet with Endress+Hauser SmartBlue app or PC with DeviceCare from version 1.07.05 or FieldXpert SMT70

The range of the connection is up to 25 m (82 ft). The range can vary depending on environmental conditions such as attachments, walls or ceilings.

i The operating keys on the display are locked as soon as the device is connected via Bluetooth.

A flashing Bluetooth symbol indicates that a Bluetooth connection is available.

SmartBlue app

1. Scan the QR code or enter "SmartBlue" in the search field of the App Store or Google Play.

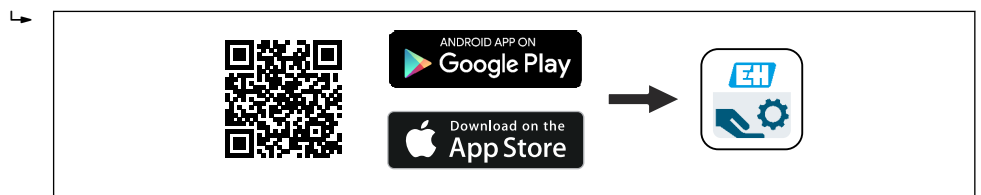

A0039186

2. Start the SmartBlue app.
3. Select device from livelist displayed.
4. Login:
 - ↳ Enter the user name: admin
 - Password: serial number of the device.
5. Change the password after logging in for the first time!

Prerequisites

System requirements

The SmartBlue app is available to download for smartphones or tablets.

- Devices with iOS: iPhone 5S or higher as of iOS11; iPad 5th generation or higher as of iOS11; iPod Touch 6th generation or higher as of iOS11
- Devices with Android: from Android 6.0 and *Bluetooth*® 4.0

Initial password

The serial number of the device serves as the initial password when the connection is established for the first time.

i Please note the following

- If the Bluetooth display is removed from one device and installed in another device:
- All the log-in data are only saved in the Bluetooth display and not in the device
 - The password changed by the user is also saved in the Bluetooth display

7.5 Access to the operating menu via the operating tool

Access via the operating tool is possible:

- Via HART communication, e.g. Commubox FXA195
- Via Endress+Hauser Commubox FXA291
 - With the Commubox FXA291, a CDI connection can be established with the device interface and a Windows PC/notebook with a USB port

7.6 DeviceCare

7.6.1 Function scope

Tool for connecting and configuring Endress+Hauser field devices.

The fastest way to configure Endress+Hauser field devices is with the dedicated "DeviceCare" tool. Together with the device type managers (DTMs), DeviceCare presents a convenient, comprehensive solution.



For details, see Innovation Brochure IN01047S

7.7 FieldCare

7.7.1 Function scope

FDT-based plant asset management tool from Endress+Hauser. FieldCare can configure all smart field devices in a system and helps you manage them. By using the status information, FieldCare is also a simple but effective way of checking their status and condition.

Access is via:

- CDI service interface
- HART communication

Typical functions:

- Parameterization of transmitters
- Loading and saving of device data (upload/download)
- Documentation of the measuring point
- Visualization of the measured value memory (line recorder) and event logbook



For additional information about FieldCare, see Operating Instructions BA00027S and BA00059S

8 System integration



8.1 Overview of device description files

- Manufacturer ID: 17 (0x0011)
- Device type ID: 0x11C1
- HART specification: 7.6
- DD files, information and files can be found at:
 - www.endress.com
 - www.fieldcommgroup.org

8.2 Measured variables via HART protocol

The following measured values are assigned to the device variables at the factory:

Device variable	Measured value
Primary variable (PV)	Level linearized
Secondary variable (SV)	Distance
Tertiary variable (TV)	Absolute echo amplitude
Quaternary variable (QV)	Relative echo amplitude

-  The assignment of the measured values to the device variables can be changed in the following submenu:
Application → HART output → HART output
-  In a HART Multidrop loop, only one device may use the analog current value for signal transmission. For all other devices in the "**Loop current mode**" parameter, select the **Disable** option.

9 Commissioning

i All configuration tools provide a commissioning assistant that supports the user when setting the most important configuration parameters (**Guidance** menu **Commissioning** wizard).

9.1 Preliminaries

The measuring range and the unit in which the measured value is transmitted correspond to the data on the nameplate.

WARNING



The settings of the current output are relevant for safety!

This can result in product overflow.

- ▶ The setting for the current output depends on the setting in the **Assign PV** parameter.
- ▶ After changing the setting of the current output, check the setting of the span (Lower range value output and Upper range value output) and change it if necessary!

9.2 Function check

Before commissioning the measuring point, check whether the post-mounting and post-connection checks (checklist) have been performed:

-  "Post-mounting check" section
-  "Post-connection check" section

9.3 Establishing a connection via FieldCare and DeviceCare

9.3.1 Via HART protocol

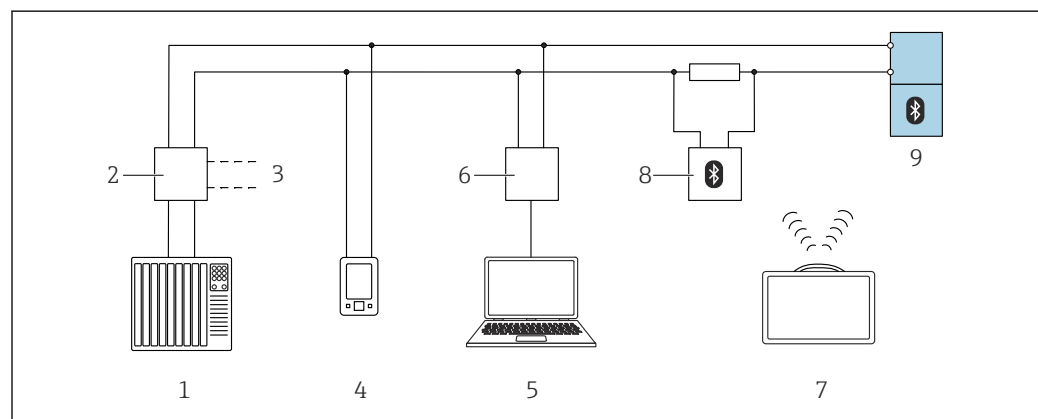

9 Options for remote operation via HART protocol

- 1 PLC (programmable logic controller)
- 2 Transmitter power supply unit, e.g., RN42
- 3 Connection for Commubox FXA195 and AMS Trex™ device communicator
- 4 AMS Trex™ device communicator
- 5 Computer with operating tool (e.g., DeviceCare/FieldCare, AMS Device View, SIMATIC PDM)
- 6 Commubox FXA195 (USB)
- 7 Field Xpert SMT70
- 8 Bluetooth modem with connecting cable (e.g., VIATOR)
- 9 Transmitter

9.3.2 Via service interface (CDI)

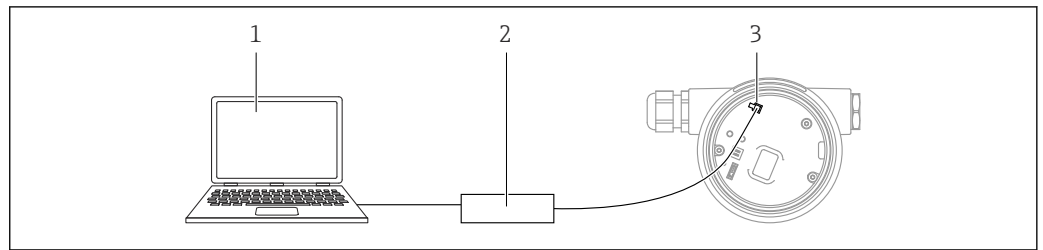

A0039148

- 1 Computer with FieldCare/DeviceCare operating tool
- 2 Commubox FXA291
- 3 Service interface (CDI) of the measuring device (= Endress+Hauser Common Data Interface)

9.4 Configuring the device address via software

See "HART address" parameter

Enter the address to exchange data via the HART protocol.

- Guidance → Commissioning → HART address
- Application → HART output → Configuration → HART address

9.5 Setting the operating language

9.5.1 Local display

Setting the operating language

i To set the operating language, the display first needs to be unlocked:

1. Press the **ESC** key for at least 2 s.
↳ A dialog box appears.
2. Unlock the display operation.
3. Select the **Language** parameter in the main menu.
4. Press the **ESC** key.
5. Select the desired language with the **+** or **-** key.
6. Press the **ESC** key.

i Display operation locks automatically (except in the **Safety mode** wizard):

- after 1 min on the main page if no key has been pressed
- after 10 min within the operating menu if no key has been pressed

9.5.2 Operating tool

Set display language

System → Display → Language

Selection in the **Language** parameter; Visibility depends on order options or device settings

9.6 Device configuration

9.6.1 Level measurement in liquids

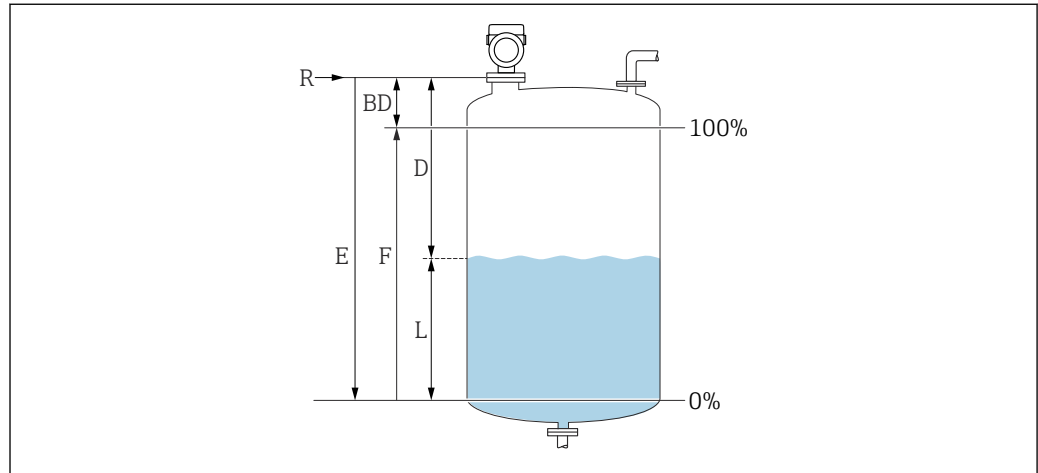

A0016933

 10 Configuration parameters for level measurement in liquids

- R Reference point of measurement
- D Distance
- L Level
- E "Empty calibration" parameter (= 0%)
- F "Full calibration" parameter (= 100%)

9.6.2 Commissioning with the Commissioning wizard

In FieldCare, DeviceCare, SmartBlue and on the display, the **Commissioning** wizard is available to guide the user through the initial commissioning steps.

Complete this wizard to commission the device.

For each parameter, enter the appropriate value or select the appropriate option.

NOTE

If you exit the wizard before completing all required parameters, the changes you made will be saved. For this reason, the device may be in an undefined state!

In this case, a reset to the default settings is recommended.

9.7 Recording the Echo curve

Record the current Echo curve as a reference echo curve for subsequent diagnostic purposes

After the measurement has been configured, it is recommended to record the current Echo curve as a reference echo curve.

The **Save reference curve** parameter in the **Echo curve** submenu is used to record the Echo curve.

Diagnostics → Echo curve → Save reference curve

- ▶ Under the **Save reference curve** parameter, activate the **Customer reference curve** option



9.8 "Simulation" submenu

Simulation of a process variable, a pulse output or a diagnostic event.

10 Operation

10.1 Reading off the device locking status

Displaying active write protection in the **Locking status** parameter

- Local display :
 - The  symbol appears on the main page
- Operating tool (FieldCare/DeviceCare) :
 - Navigation: System → Device management → Locking status

10.2 Reading off measured values

All the measured values can be read off using the **Measured values** submenu.

Navigation: **Application** menu → **Measured values** submenu

10.3 Adapting the device to process conditions

The following menus are available for this purpose:

- Basic settings in the **Guidance** menu
- Advanced settings in:
 - **Diagnostics** menu
 - **Application** menu
 - **System** menu

10.4 Heartbeat Technology (optional)

10.4.1 Heartbeat Verification

"Heartbeat Verification" wizard

This wizard is used to start an automatic verification of the device functionality. The results can be documented as a verification report.

- The wizard can be used via the operating tools and the display
 - The wizard can be started on the display but only shows the **Passed** option or **Failed** option result.
- The wizard guides the user through the entire process for creating the verification report

10.4.2 Heartbeat Verification/Monitoring

 The **Heartbeat** submenu is only available when operating via FieldCare, DeviceCare or the SmartBlue app. It contains the wizards that are provided with the Heartbeat Verification and Heartbeat Monitoring application packages.

 Documentation on the Heartbeat Technology: Endress+Hauser website: www.endress.com → Downloads.

11 Diagnostics and troubleshooting

11.1 General troubleshooting

11.1.1 General errors

Device is not responding

- Possible cause: Supply voltage does not match the specification on the nameplate
Remedial action: Apply the correct voltage
- Possible cause: The polarity of the supply voltage is wrong
Remedial action: Correct the polarity
- Possible cause: The connecting cables are not in contact with the terminals
Remedial action: Check the electrical contact between cables and correct if necessary
- Possible cause: Load resistance too high
Remedial action: Increase the supply voltage to reach the minimum terminal voltage

Values not visible on the display

- Possible cause: Display setting is too bright or too dark
Remedial action:
Use the **Contrast display** parameter to increase or reduce contrast
Navigation path: System → Display → Contrast display
- Possible cause: The plug of the display cable is not connected correctly
Remedial action: Connect the plug correctly
- Possible cause: Display is defective
Remedial action: Replace the display

"Communication error" is indicated on the display when the device is started or the display is connected

- Possible cause: Electromagnetic interference influence
Remedial action: Check grounding of the device
- Possible cause: Defective cable connection or display plug
Remedial action: Replace the display

Communication via CDI interface not working

Possible cause: Wrong setting of the COM port on the computer

Remedial action: Check the setting of the COM port on the computer and correct it if necessary

Device measuring incorrectly

Possible cause: Parameter configuration error

Remedial action: Check and correct the parameter configuration

11.2 Error - SmartBlue operation

Operation via SmartBlue is only possible on devices that have a display with Bluetooth (optionally available).

Device is not visible in the live list

- Possible cause: No Bluetooth connection available
Remedial action: Enable Bluetooth in the field device via display or software tool and/or in the smartphone/tablet
- Possible cause: Bluetooth signal outside range
Remedial action: Reduce distance between field device and smartphone/tablet
The connection has a range of up to 25 m (82 ft).
Operating radius with intervisibility 10 m (33 ft)
- Possible cause: Geopositioning is not enabled on Android devices or is not permitted for the SmartBlue app
Remedial action: Enable/permit the geopositioning service on Android device for the SmartBlue app
- Display does not have Bluetooth

Device appears in the live list but a connection cannot be established

- Possible cause: The device is already connected with another smartphone/tablet via Bluetooth
Only one point-to-point connection is permitted
Remedial action: Disconnect the smartphone/tablet from the device
- Possible cause: Incorrect user name and password
Remedial action: The standard user name is "admin" and the password is the device serial number indicated on the device nameplate (only if the password was not changed by the user beforehand)
If the password has been forgotten, contact Endress+Hauser Service (www.addresses.endress.com)

Connection via SmartBlue not possible

- Possible cause: Incorrect password entered
Remedial action: Enter the correct password, paying attention to lower/upper case
- Possible cause: Forgotten password
Remedial action: Contact Endress+Hauser Service (www.addresses.endress.com)

Login via SmartBlue not possible

- Possible cause: Device is being put into operation for the first time
Remedial action: Enter the user name "admin" and the password (device serial number), paying attention to lower/upper case
- Possible cause: The electric current and voltage are not correct.
Remedial action: Increase the supply voltage.

Device cannot be operated via SmartBlue

- Possible cause: Incorrect password entered
Remedial action: Enter the correct password, paying attention to lower/upper case
- Possible cause: Forgotten password
Remedial action: Contact Endress+Hauser Service (www.addresses.endress.com)
- Possible cause: **Operator** option has no authorization
Remedial action: Change to **Maintenance** option

11.3 Diagnostic information on local display

11.3.1 Diagnostic message

Measured value display and diagnostic message in alarm condition

Faults detected by the self-monitoring system of the device are displayed as a diagnostic message in alternation with the unit.

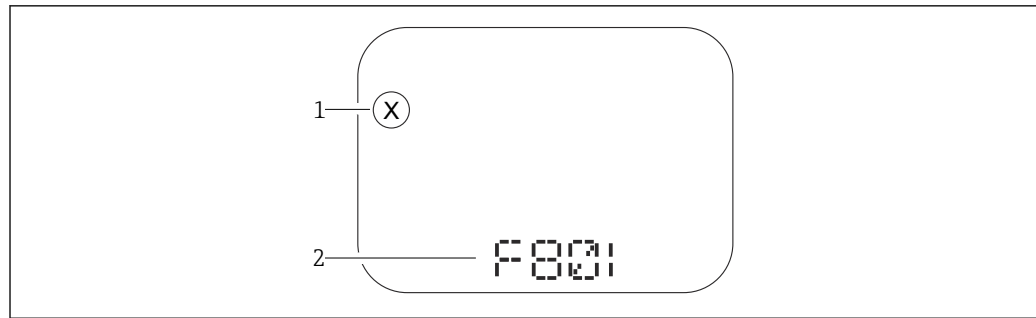

A0043759

- 1 Status signal
2 Status symbol with diagnostic event

Faults detected by the self-monitoring system of the device are displayed as a diagnostic message in alternation with the measured value display.

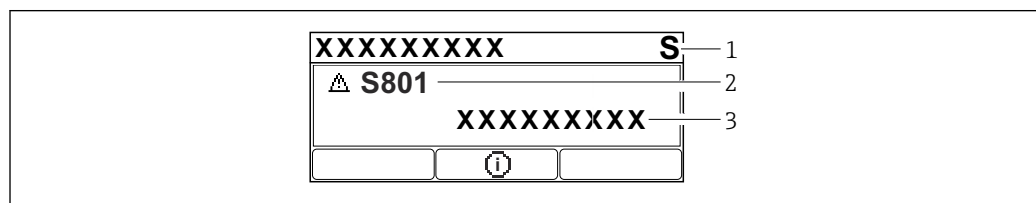

A0043103

- 1 Status signal
2 Status symbol with diagnostic event
3 Event text

Status signals

F

"Failure (F)" option

A device error has occurred. The measured value is no longer valid.

C

"Function check (C)" option

The device is in the service mode (e.g. during a simulation).

S

"Out of specification (S)" option

The device is being operated:

- Outside of its technical specifications (e.g. during startup or a cleaning)
- Outside of the configuration performed by the user (e.g. sensor frequency outside the configured span)

M

"Maintenance required (M)" option

Maintenance required. The measured value remains valid.

Diagnostic event and event text

The fault can be identified by means of the diagnostic event. The event text helps you by providing information about the fault. In addition, the corresponding status symbol is displayed in front of the diagnostic event.

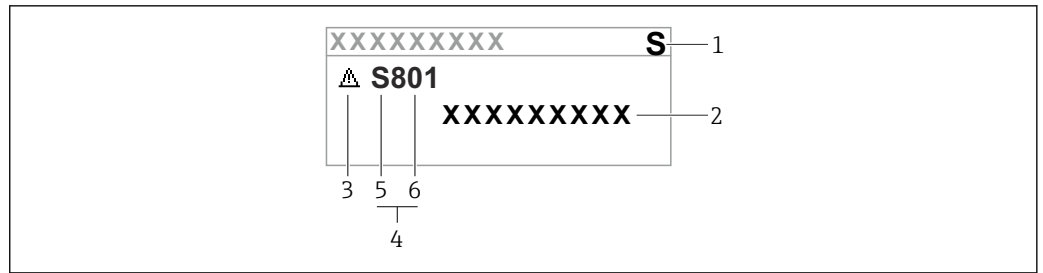

- 1 Status signal
- 2 Event text
- 3 Status symbol
- 4 Diagnostic event
- 5 Status signal
- 6 Event number

If two or more diagnostic events occur simultaneously, only the diagnostic message with the highest priority is shown.

"Active diagnostics" parameter

Key

Opens the message about the remedial measures.

Key

Acknowledge warnings.

Key

Back to operating menu.

11.4 Diagnostic event in the operating tool

If there is a diagnostic event in the device, the status signal appears on the top left in the status section of the operating tool together with the associated icon for event behavior according to NAMUR NE 107:

- Failure (F)
- Function check (C)
- Out of specification (S)
- Maintenance required (M)

Click the status signal to see the detailed status signal.

The diagnostic events and remedial measures can be printed in the **Diagnostic list** submenu.

11.5 Adapting the diagnostic information

The event level can be configured:

Navigation: Diagnostics → Diagnostic settings → Configuration

11.6 Queued diagnostic messages

The display alternates between the queued diagnostic messages and the measured value.

Queued diagnostic messages can also be displayed in the **Active diagnostics** parameter.

Navigation: Diagnostics → Active diagnostics



11.7 Diagnostic list

In the **Diagnostic list** submenu submenu, up to 5 currently pending diagnostic messages can be displayed. If more than 5 messages are pending, the messages with the highest priority are shown on the display.

Navigation path

Diagnostics → Diagnostic list

Calling up and closing the remedial measures

1. Press .
 - ↳ The message for the remedial measures for the selected diagnostic event opens.
2. Press  +  simultaneously.
 - ↳ The message about the remedial measures closes.

11.8 List of diagnostic events

Diagnostic number	Short text	Remedy instructions	Status signal [from the factory]	Diagnostic behavior [from the factory]
Diagnostic of sensor				
062	Sensor connection faulty	Check sensor connection	F	Alarm
151	Sensor electronic failure	Replace sensor electronic module	F	Alarm
168	Build-up detected	Check process conditions	M	Warning ¹⁾
Diagnostic of electronic				
203	HART Device Malfunction	Check device specific diagnosis.	S	Warning
204	HART Electronic Defect	Check device specific diagnosis.	F	Alarm
242	Firmware incompatible	1. Check software 2. Flash or change main electronic module	F	Alarm
252	Module incompatible	1. Check if correct electronic module is plugged 2. Replace electronic module	F	Alarm
270	Main electronics defective	Replace main electronics	F	Alarm
272	Main electronics faulty	1. Restart device 2. Contact service	F	Alarm
273	Main electronics defective	Replace main electronics	F	Alarm
282	Data storage inconsistent	Restart device	F	Alarm
283	Memory content inconsistent	1. Restart device 2. Contact service	F	Alarm
287	Memory content inconsistent	1. Restart device 2. Contact service	M	Warning
388	Electronics and HistoROM defective	1. Restart device 2. Replace electronics and HistoROM 3. Contact service	F	Alarm
Diagnostic of configuration				
410	Data transfer failed	1. Retry data transfer 2. Check connection	F	Alarm

Diagnostic number	Short text	Remedy instructions	Status signal [from the factory]	Diagnostic behavior [from the factory]
412	Processing download	Download active, please wait	C	Warning
420	HART Device Configuration Locked	Check device locking configuration.	S	Warning
421	HART Loop Current fixed	Check Multi-drop mode or current simulation.	S	Warning
431	Trim required	Carry out trim	C	Warning
435	Linearization faulty	Check linearization table	F	Alarm
437	Configuration incompatible	1. Update firmware 2. Execute factory reset	F	Alarm
438	Dataset different	1. Check data set file 2. Check device parameterization 3. Download new device parameterization	M	Warning
441	Current output out of range	1. Check process 2. Check current output settings	S	Warning
484	Failure mode simulation active	Deactivate simulation	C	Warning
485	Process variable simulation active	Deactivate simulation	C	Warning
491	Current output simulation active	Deactivate simulation	C	Warning
495	Diagnostic event simulation active	Deactivate simulation	S	Warning
538	Configuration Sensor Unit invalid	1. Check sensor configuration 2. Check device configuration	F	Alarm
585	Simulation distance	Deactivate simulation	C	Warning
586	Record map	Recording of mapping please wait	C	Warning
Diagnostic of process				
801	Supply voltage too low	Increase supply voltage	F	Alarm
802	Supply voltage too high	Decrease supply voltage	S	Warning
805	Loop current faulty	1. Check wiring 2. Replace electronics	F	Alarm
806	Loop diagnostics	1. Check supply voltage 2. Check wiring and terminals	M	Warning ¹⁾
807	No Baseline due to insuf. volt. at 20 mA	Increase supply voltage	M	Warning
825	Electronics temperature	1. Check ambient temperature 2. Check process temperature	S	Warning
826	Sensor temperature out of range	1. Check ambient temperature 2. Check process temperature	S	Warning
846	HART Non-Primary Variable Out of Limit	Check device specific diagnosis.	S	Warning
847	HART Primary Variable Out of Limit	Check device specific diagnosis.	S	Warning
848	HART Device Variable Alert	Check device specific diagnosis.	S	Warning
941	Echo lost	Check parameter 'DC value'	S	Warning ¹⁾

Diagnostic number	Short text	Remedy instructions	Status signal [from the factory]	Diagnostic behavior [from the factory]
942	In safety distance	1. Check level 2. Check safety distance 3. Reset self holding	S	Warning ¹⁾
952	Foam detected	Check process conditions	C	Warning ¹⁾
968	Level limited	1. Check level 2. Check limit parameters	S	Warning

1) Diagnostic behavior can be changed.

11.9 Event logbook

11.9.1 Event history

A chronological overview of the event messages that have occurred is provided in the **Event logbook** submenu. This submenu only exists if operating via the local display. In the case of operation via FieldCare, the event list can be displayed with the "Event List / HistoROM" functionality of FieldCare.

Navigation:

Diagnostics → Event logbook → Event list

A maximum of 100 event messages can be displayed in chronological order.



The event history includes entries for:

- Diagnostic events
- Information events

In addition to the operating time when the event occurred, each event is also assigned a symbol that indicates whether the event has occurred or is finished:

- Diagnostic event
 - ☉: Occurrence of the event
 - ☺: End of the event
- Information event
 - ☉: Occurrence of the event

Calling up and closing the remedial measures

1. Press .
 - ↳ The message for the remedial measures for the selected diagnostic event opens.
2. Press  +  simultaneously.
 - ↳ The message about the remedial measures closes.

11.9.2 Filtering the event logbook

Filters can be used to determine which category of event messages is displayed in the **Event list** submenu.

Navigation: Diagnostics → Event logbook

Filter categories

- All
- Failure (F)
- Function check (C)

- Out of specification (S)
- Maintenance required (M)
- Information

11.9.3 Overview of information events

Info number	Info name
I1000	----- (Device ok)
I1079	Sensor changed
I1089	Power on
I1090	Configuration reset
I1091	Configuration changed
I11074	Device verification active
I1110	Write protection switch changed
I11104	Loop diagnostics
I1151	History reset
I1154	Reset terminal voltage min/max
I1155	Reset electronics temperature
I1157	Memory error event list
I1256	Display: access status changed
I1264	Safety sequence aborted
I1335	Firmware changed
I1397	Fieldbus: access status changed
I1398	CDI: access status changed
I1440	Main electronic module changed
I1444	Device verification passed
I1445	Device verification failed
I1461	Sensor verification failed
I1512	Download started
I1513	Download finished
I1514	Upload started
I1515	Upload finished
I1551	Assignment error fixed
I1552	Failed: Main electronic verification
I1554	Safety sequence started
I1555	Safety sequence confirmed
I1556	Safety mode off
I1956	Reset

11.10 Resetting the device

11.10.1 Resetting the device via the operating tool

Reset the device configuration - either entirely or in part - to a defined state

Navigation: System → Device management → Reset device

Reset device parameter

 For details see the "Description of device parameters" documentation.

11.10.2 Resetting the device via keys on the electronic insert

Reset the password

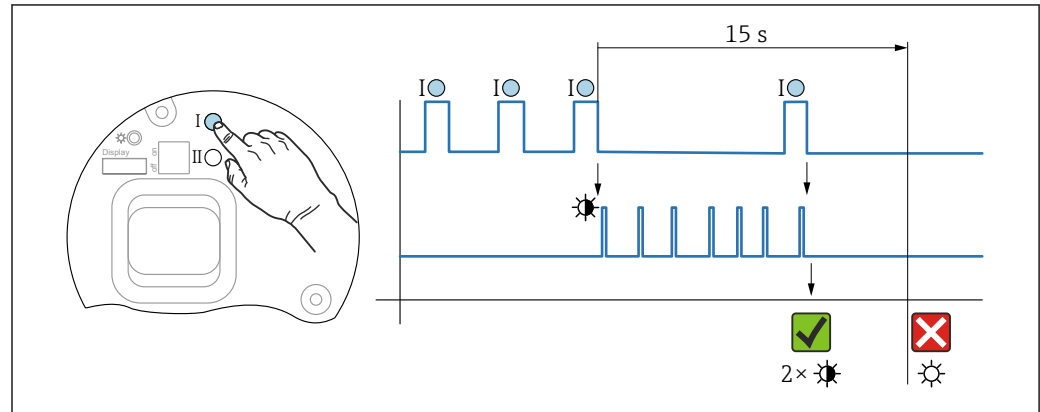

 11 Sequence - resetting the password

Deleting/resetting the password

1. Press operating key I three times.
 - ↳ The Reset Password function is started, the LED flashes.
2. Press operating key I once within 15 s.
 - ↳ The password is reset, the LED flashes briefly.

If operating key I is not pressed within 15 s, the action is canceled and the LED is no longer lit.

Resetting the device to the factory setting

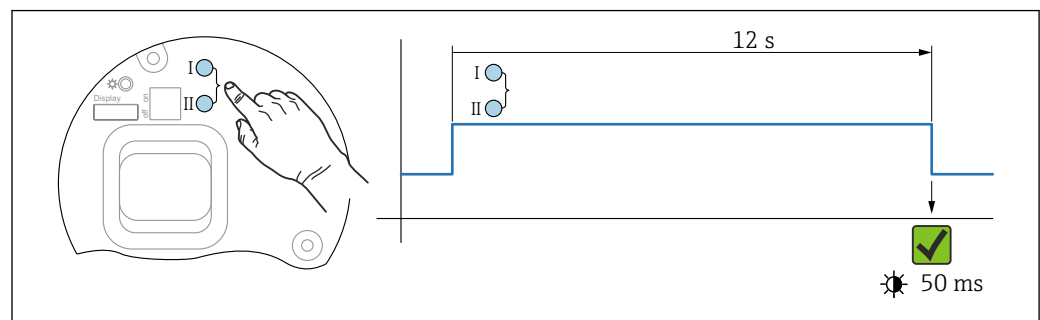

 12 Operating keys on the electronic insert

Resetting the device to the factory setting

- ▶ Press operating key I and operating key II simultaneously for at least 12 s.
 - ↳ Device data are reset to the factory setting, the LED flashes briefly.

11.11 Device information

All the device information is contained in the **Information** submenu.

Navigation: System → Information

 For details see the "Description of device parameters" documentation.

11.12 Firmware history

 The firmware version can explicitly be ordered via the product structure. This makes it possible to ensure the compatibility of the firmware version with an existing or planned system integration.

11.12.1 Version 01.00.zz

Original software

12 Maintenance

No special maintenance work is required.

12.1 Exterior cleaning

Notes on cleaning

- The cleaning agents used should not corrode the surfaces and the seals
- Observe the degree of protection of the device

12.2 Seals

 The process seals, located on the process connection of the device, should be replaced periodically. The interval between changes depends on the frequency of the cleaning cycles, the cleaning temperature and the medium temperature.

13 Repair

13.1 General information

13.1.1 Repair concept

Endress+Hauser repair concept

- The devices have a modular design
- Repairs can be carried out by Endress+Hauser Service or by appropriately trained customers
- Spare parts are grouped into logical kits with the associated replacement instructions

 For more information on service and spare parts, please contact your Endress+Hauser sales representative.

13.1.2 Repair of Ex-certified devices

WARNING

Incorrect repair can affect electrical safety!

Explosion Hazard!

- ▶ Only specialist personnel or the Endress+Hauser service team may carry out repairs on Ex-certified devices.
- ▶ Relevant standards and national regulations on hazardous areas, safety instructions and certificates must be observed.
- ▶ Use only original Endress+Hauser spare parts.
- ▶ Please note the device designation on the nameplate. Only identical parts may be used as replacements.
- ▶ Carry out repairs according to the instructions.
- ▶ Only the Endress+Hauser service team is permitted to modify a certified device and convert it to another certified version.
- ▶ All repairs and modifications must be documented.

13.2 Spare parts

- Some replaceable device components are identified by a spare part nameplate. This contains information about the spare part.
- All the spare parts available for the measuring device are listed in the *Device Viewer* (www.endress.com/deviceviewer) along with the order code and can be ordered. If available, users can also download the associated Installation Instructions.

 Device serial number or QR code:
Located on the device and spare part nameplate.

13.3 Replacement

CAUTION

Data upload/download is not permitted if the device is used for safety-related applications.

- ▶ After an entire device or an electronics module has been replaced, the parameters can be downloaded to the device again via the communication interface. For this, the data must have been uploaded to the PC beforehand using the "FieldCare/DeviceCare" software.

13.3.1 HistoROM

It is not necessary to perform a new device calibration after replacing the display or transmitter electronics.



The spare part is supplied without HistoROM.

After removing the transmitter electronics, remove HistoRom and insert it into the new spare part.

13.4 Return

The requirements for safe device return can vary depending on the device type and national legislation.

1. Refer to the web page for information:
<http://www.endress.com/support/return-material>
↳ Select the region.
2. Return the device if repairs or a factory calibration are required, or if the wrong device was ordered or delivered.

13.5 Disposal



If required by the Directive 2012/19/EU on waste electrical and electronic equipment (WEEE), the product is marked with the depicted symbol in order to minimize the disposal of WEEE as unsorted municipal waste. Do not dispose of products bearing this marking as unsorted municipal waste. Instead, return them to the manufacturer for disposal under the applicable conditions.

14 Accessories

14.1 Weather protection cover 316L

The weather protection cover can be ordered together with the device via the "Accessory enclosed" product structure.

It is used to protect against direct sunlight, precipitation and ice.

Weather protection cover 316L is suitable for the dual compartment housing made of aluminum or 316L. The delivery includes the holder for direct mounting on the housing.

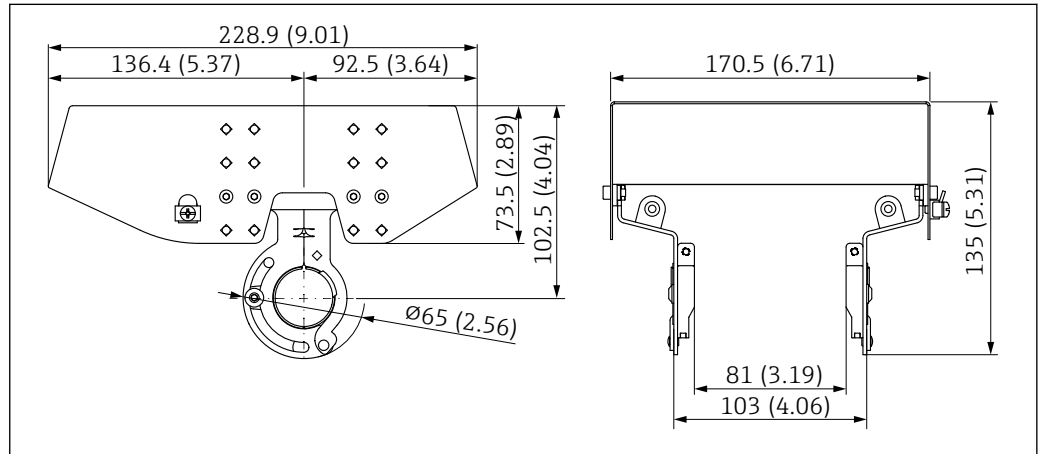

13 Dimensions. Unit of measurement mm (in)

Material

- Weather protection cover: 316L
- Clamping screw: A4
- Holder: 316L

Order number for accessories:

71438303

14.2 Plastic weather protection cover

The weather protection cover can be ordered together with the device via the "Accessory enclosed" product structure.

It is used to protect against direct sunlight, precipitation and ice.

The plastic weather protection cover is suitable for the single compartment housing made of aluminum. The delivery includes the holder for direct mounting on the housing.

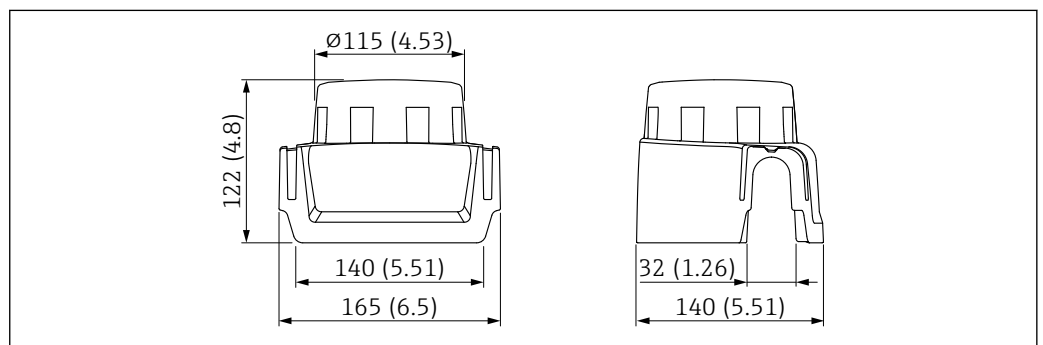

14 Dimensions. Unit of measurement mm (in)

Material

Plastic

Order number for accessories:

71438291

14.3 M12 socket

M12 socket, straight

- Material:
 - Body: PBT; union nut: nickel-plated die-cast zinc; seal: NBR
- Degree of protection (fully locked): IP67
- Pg coupling: Pg7
- Order number: 52006263

M12 socket, angled

- Material:
 - Body: PBT; union nut: nickel-plated die-cast zinc; seal: NBR
- Degree of protection (fully locked): IP67
- Pg coupling: Pg7
- Order number: 71114212

M12 socket, angled, 5 m (16 ft) cable

- M12 socket material:
 - Body: TPU
 - Union nut: nickel-plated die-cast zinc
- Cable material:
 - PVC
- Cable Li Y YM 4×0.34 mm² (20 AWG)
- Cable colors
 - 1 = BN = brown
 - 2 = WH = white
 - 3 = BU = blue
 - 4 = BK = black
- Order number: 52010285

14.4 Remote display FHX50B

The remote display is ordered via the Product Configurator.

If the remote display is to be used, the device version **Prepared for display FHX50B** must be ordered.

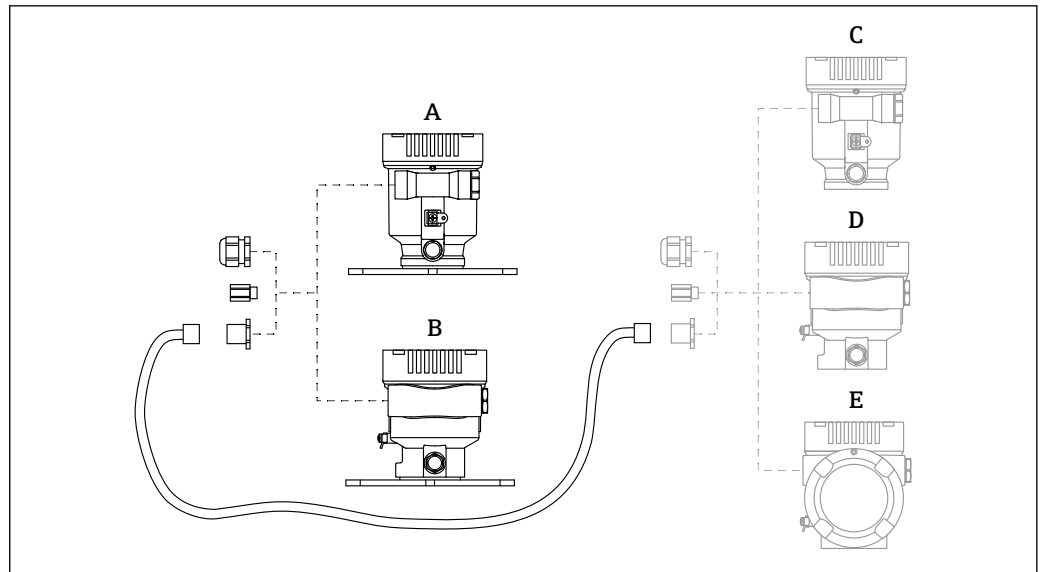

A0046692

- A Plastic single compartment housing, remote display
 B Aluminum single compartment housing, remote display
 C Device side, plastic single compartment housing prepared for remote display
 D Device side, aluminum single compartment housing prepared for remote display
 E Device side, dual compartment housing, L-form, prepared for remote display

Material of single compartment housing, remote display

- Aluminum
- Plastic

Degree of protection:

- IP68 / NEMA 6P
- IP66 / NEMA 4x

Connecting cable:

- Connecting cable (option) up to 30 m (98 ft)
- Standard cable provided by customer onsite up to 60 m (196 ft)

Ambient temperature:

- -40 to +80 °C (-40 to +176 °F)
- Option: -50 to +80 °C (-58 to +176 °F)

14.5 Gas-tight feedthrough

The chemically inert glass feedthrough which prevents gases from entering the electronics housing is optionally available and can be ordered as a "Mounted accessory" via the product structure.

14.6 Process adapter M24

 For details, refer to TI00426F/00/EN "Weld-in adapters, process adapters and flanges".

14.7 Commubox FXA195 HART

For intrinsically safe HART communication with FieldCare via the USB interface

 For details, see "Technical Information" TI00404F

14.8 HART Loop Converter HMX50

Is used to evaluate and convert dynamic HART process variables to analog current signals or limit values.

Order number:

71063562



For details, see "Technical Information" TI00429F and Operating Instructions BA00371F

14.9 FieldPort SWA50

Intelligent Bluetooth® and/or WirelessHART adapter for all HART field devices



For details, see "Technical Information" TI01468S

14.10 Wireless HART adapter SWA70

The WirelessHART adapter is used for the wireless connection of field devices. It can be easily integrated into field devices and existing infrastructures, offers data protection and transmission safety and can be operated in parallel with other wireless networks.



For details, see Operating Instructions BA00061S

14.11 Fieldgate FXA42

Fieldgates enable communication between connected 4 to 20 mA, Modbus RS485 and Modbus TCP devices and SupplyCare Hosting or SupplyCare Enterprise. The signals are transmitted either via Ethernet TCP/IP, WLAN or mobile communications (UMTS). Advanced automation capabilities are available, such as an integrated Web-PLC, OpenVPN and other functions.



For details, see "Technical Information" TI01297S and Operating Instructions BA01778S.

14.12 Field Xpert SMT70

Universal, high-performance tablet PC for device configuration in Ex Zone 2 and non-Ex areas



For details, see "Technical Information" TI01342S

14.13 DeviceCare SFE100

Configuration tool for HART, PROFIBUS and FOUNDATION Fieldbus field devices



Technical Information TI01134S

14.14 FieldCare SFE500

FDT-based plant asset management tool

It can configure all smart field units in your system and helps you manage them. By using the status information, it is also a simple but effective way of checking their status and condition.



Technical Information TI00028S

14.15 Memograph M

The Memograph M graphic data manager provides information on all the relevant process variables. Measured values are recorded correctly, limit values are monitored and measuring points analyzed. The data are stored in the 256 MB internal memory and also on an SD card or USB stick.



Technical Information TI00133R and Operating Instructions BA00247R

14.16 RN42

Single-channel active barrier with wide-range power supply for safe electrical isolation of 4 to 20 mA standard signal circuits, HART transparent.



Technical Information TI01584K and Operating Instructions BA02090K

15 Technical data

15.1 Input

Measured variable The measured variable is the distance between the reference point and the product surface. The level is calculated based on "E", the empty distance entered.

Measuring range The measuring range starts at the point where the beam hits the tank floor. Levels below this point cannot be measured, particularly in the case of spherical bases or conical outlets.

Maximum measuring range

The maximum measuring range depends on the antenna size and design.

Antenna	Maximum measuring range
Integrated, PEEK, 20 mm (0.75 in)	10 m (32.8 ft)
Cladded flush mount, PTFE, 50 mm (2 in)	50 m (164 ft)
Cladded flush mount, PTFE, 80 mm (3 in)	80 m (262 ft)

Usable measuring range

The usable measuring range depends on the antenna size, the medium's reflective properties, the installation position and any possible interference reflections.

In principle, measurement is possible up to the tip of the antenna.

To avoid any material damage from corrosive or aggressive media or deposit buildup on the antenna, the end of the measuring range should be selected 10 mm (0.4 in) before the tip of the antenna **A**.

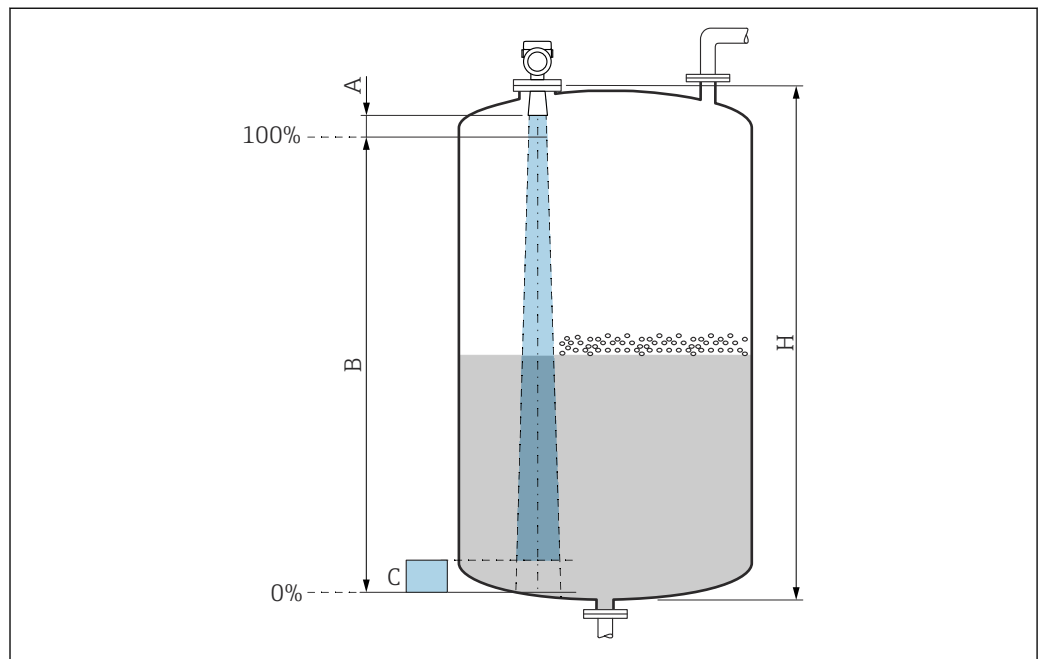

A0031828

- A Antenna tip + 10 mm (0.4 in)
- B Smallest possible measuring range
- C Distance above tank floor = 50 to 80 mm (1.97 to 3.15 in); (water-based medium $\epsilon_r = 2$)
- H Vessel height > 0.7 m (2.3 ft)

The media groups and the possible measuring range are described as a function of the application and media group in the following section. If the dielectric constant of the medium is not known, to ensure a reliable measurement assume the medium belongs to group B.

Media groups

- **A0** (ϵ_r 1.2 to 1.4)
e.g. n-butane, liquid nitrogen, liquid hydrogen
- **A** (ϵ_r 1.4 to 1.9)
Non-conductive liquids, e.g. liquefied gas
- **B** (ϵ_r 1.9 to 4)
Non-conductive liquids, e.g. gasoline, oil, toluene, etc.
- **C** (ϵ_r 4 to 10)
e.g. concentrated acid, organic solvents, ester, aniline, etc.
- **D** ($\epsilon_r >10$)
Conductive liquids, aqueous solutions, diluted acids, bases and alcohol

i Measurement of the following media with absorbing gas phase

For example:

- Ammonia
- Acetone
- Methylene chloride
- Methyl ethyl ketone
- Propylene oxide
- VCM (vinyl chloride monomer)

To measure absorbing gases, either use a guided radar, measuring devices with another measuring frequency or another measuring principle.

If measurements must be performed in one of these media, please contact Endress+Hauser.

i For the dielectric constants (DC values) of many media commonly used in industry, please refer to:

- Dielectric constant (DC value) Compendium CPO1076F
- The Endress+Hauser "DC Values app" (available for Android and iOS)

Measurement in storage vessel

Storage vessel - measuring conditions

Calm medium surface (e.g. bottom filling, filling via immersion tube or rare filling from above)

Integrated antenna, PEEK, 20 mm (0.75 in) in storage vessel

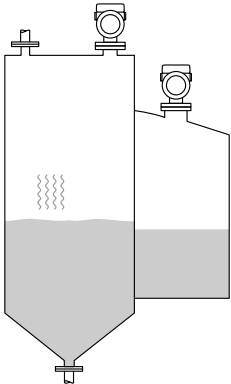
	Media group	Measuring range
	A0 (ϵ_r 1.2 to 1.4)	1.5 m (5 ft)
	A (ϵ_r 1.4 to 1.9)	2.5 m (8 ft)
	B (ϵ_r 1.9 to 4)	5 m (16 ft)
	C (ϵ_r 4 to 10)	8 m (26 ft)
	D ($\epsilon_r >10$)	10 m (33 ft)

Antenna, PTFE cladded flush mount, 50 mm (2 in) in storage vessel

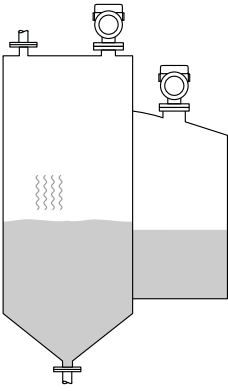
	Media group	Measuring range
	A0 (ϵ_r 1.2 to 1.4)	7 m (23 ft)
	A (ϵ_r 1.4 to 1.9)	12 m (39 ft)
	B (ϵ_r 1.9 to 4)	23 m (75 ft)
	C (ϵ_r 4 to 10)	40 m (131 ft)
	D (ϵ_r >10)	50 m (164 ft)

Antenna, PTFE cladded flush mount, 80 mm (3 in) in storage vessel

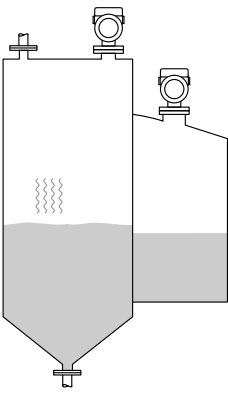
	Media group	Measuring range
	A0 (ϵ_r 1.2 to 1.4)	22 m (72 ft)
	A (ϵ_r 1.4 to 1.9)	40 m (131 ft)
	B (ϵ_r 1.9 to 4)	50 m (164 ft)
	C (ϵ_r 4 to 10)	65 m (231 ft)
	D (ϵ_r >10)	80 m (262 ft)

Cladded antenna, PEEK, 20 mm (0.75 in) in storage vessel

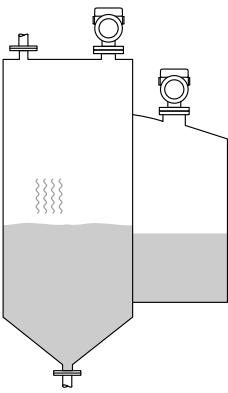
	Media group	Measuring range
	A0 (ϵ_r 1.2 to 1.4)	1.5 m (5 ft)
	A (ϵ_r 1.4 to 1.9)	2.5 m (8 ft)
	B (ϵ_r 1.9 to 4)	5 m (16 ft)
	C (ϵ_r 4 to 10)	8 m (26 ft)
	D (ϵ_r >10)	10 m (33 ft)

Cladded antenna, PEEK, 40 mm (1.5 in) in storage vessel

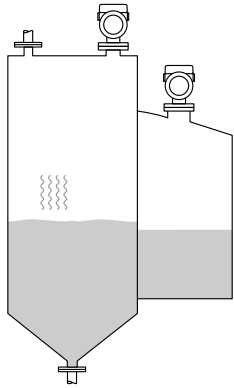
	Media group	Measuring range
	A0 (ϵ_r 1.2 to 1.4)	3 m (10 ft)
	A (ϵ_r 1.4 to 1.9)	6 m (20 ft)
	B (ϵ_r 1.9 to 4)	11 m (36 ft)
	C (ϵ_r 4 to 10)	15 m (49 ft)
	D (ϵ_r >10)	22 m (72 ft)

Measurement in buffer vessel

Buffer vessel - measuring conditions

Moving medium surface (e.g. permanent free filling from above, mixing jets)

Integrated antenna, PEEK, 20 mm (0.75 in) in buffer vessel

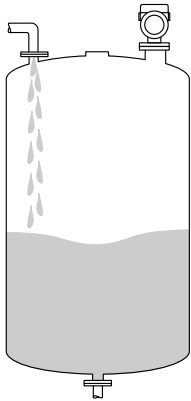
	Media group	Measuring range
	A0 (ϵ_r 1.2 to 1.4)	1 m (3.3 ft)
	A (ϵ_r 1.4 to 1.9)	1.5 m (5 ft)
	B (ϵ_r 1.9 to 4)	3 m (10 ft)
	C (ϵ_r 4 to 10)	6 m (20 ft)
	D (ϵ_r >10)	8 m (26 ft)

Antenna, PTFE cladded flush mount, 50 mm (2 in) in buffer vessel

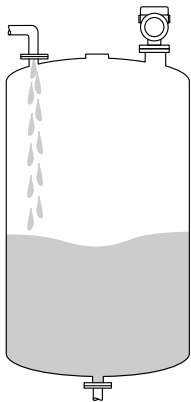
	Media group	Measuring range
	A0 (ϵ_r 1.2 to 1.4)	4 m (13 ft)
	A (ϵ_r 1.4 to 1.9)	7 m (23 ft)
	B (ϵ_r 1.9 to 4)	13 m (43 ft)
	C (ϵ_r 4 to 10)	28 m (92 ft)
	D (ϵ_r >10)	44 m (144 ft)

Antenna, PTFE cladded flush mount, 80 mm (3 in) in buffer vessel

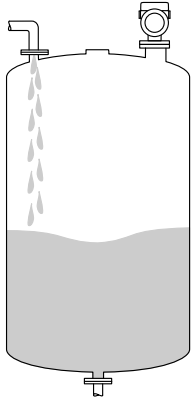
	Media group	Measuring range
	A0 (ϵ_r 1.2 to 1.4)	12 m (39 ft)
	A (ϵ_r 1.4 to 1.9)	23 m (75 ft)
	B (ϵ_r 1.9 to 4)	45 m (148 ft)
	C (ϵ_r 4 to 10)	60 m (197 ft)
	D (ϵ_r >10)	70 m (230 ft)

Cladded antenna, PEEK, 20 mm (0.75 in) in buffer vessel

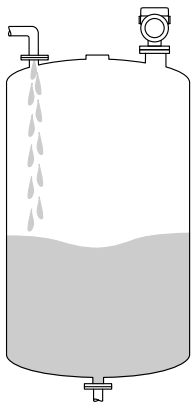
	Media group	Measuring range
	A0 (ϵ_r 1.2 to 1.4)	1 m (3.3 ft)
	A (ϵ_r 1.4 to 1.9)	1.5 m (5 ft)
	B (ϵ_r 1.9 to 4)	3 m (10 ft)
	C (ϵ_r 4 to 10)	6 m (20 ft)
	D (ϵ_r >10)	8 m (26 ft)

Cladded antenna, PEEK, 40 mm (1.5 in) in buffer vessel

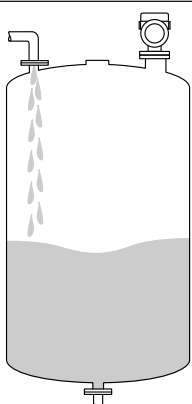
	Media group	Measuring range
	A0 (ϵ_r 1.2 to 1.4)	1.5 m (5 ft)
	A (ϵ_r 1.4 to 1.9)	3 m (10 ft)
	B (ϵ_r 1.9 to 4)	6 m (20 ft)
	C (ϵ_r 4 to 10)	13 m (43 ft)
	D (ϵ_r >10)	20 m (66 ft)

Measurement in vessel with agitator

Vessel with agitator - measuring conditions

Turbulent medium surface (e.g. from filling from above, stirrers and baffles)

Integrated antenna, PEEK, 20 mm (0.75 in) in vessel with agitator

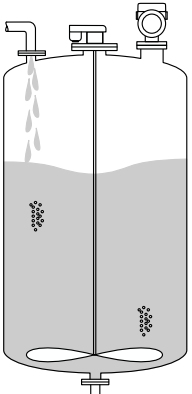
	Media group	Measuring range
	A (ϵ_r 1.4 to 1.9)	1 m (3.3 ft)
	B (ϵ_r 1.9 to 4)	1.5 m (5 ft)
	C (ϵ_r 4 to 10)	3 m (10 ft)
	D (ϵ_r >10)	5 m (16 ft)

Antenna, PTFE clad flush mount, 50 mm (2 in) in vessel with agitator

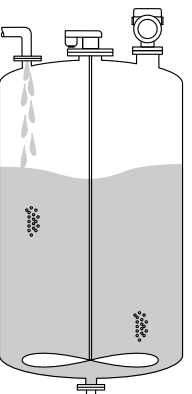
	Media group	Measuring range
	A0 (ϵ_r 1.2 to 1.4)	2 m (7 ft)
	A (ϵ_r 1.4 to 1.9)	4 m (13 ft)
	B (ϵ_r 1.9 to 4)	7 m (23 ft)
	C (ϵ_r 4 to 10)	15 m (49 ft)
	D (ϵ_r >10)	25 m (82 ft)

Antenna, PTFE clad flush mount, 80 mm (3 in) in vessel with agitator

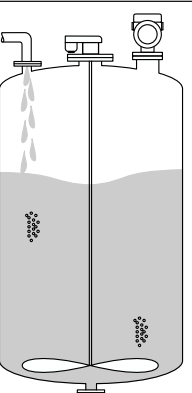
	Media group	Measuring range
	A0 (ϵ_r 1.2 to 1.4)	7 m (23 ft)
	A (ϵ_r 1.4 to 1.9)	13 m (43 ft)
	B (ϵ_r 1.9 to 4)	25 m (82 ft)
	C (ϵ_r 4 to 10)	50 m (164 ft)
	D (ϵ_r >10)	60 m (197 ft)

Cladded antenna, PEEK, 20 mm (0.75 in) in vessel with agitator

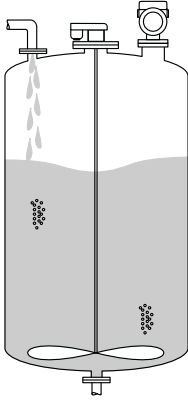
	Media group	Measuring range
	A (ϵ_r 1.4 to 1.9)	1 m (3.3 ft)
	B (ϵ_r 1.9 to 4)	1.5 m (5 ft)
	C (ϵ_r 4 to 10)	3 m (10 ft)
	D ($\epsilon_r >10$)	5 m (16 ft)

Cladded antenna, PEEK, 40 mm (1.5 in) in vessel with agitator

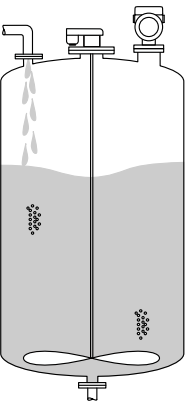
	Media group	Measuring range
	A0 (ϵ_r 1.2 to 1.4)	1 m (3.3 ft)
	A (ϵ_r 1.4 to 1.9)	1.5 m (5 ft)
	B (ϵ_r 1.9 to 4)	3 m (10 ft)
	C (ϵ_r 4 to 10)	7 m (23 ft)
	D ($\epsilon_r >10$)	11 m (36 ft)

Operating frequency Approx. 80 GHz
 Up to 8 devices can be installed in a tank without the devices mutually influencing one another.

Transmission power ■ Peak power: 6.3 mW
 ■ Average output power: 63 μ W

15.2 Output

Output signal **HART**
 Signal coding:
 FSK ± 0.5 mA over current signal
 Data transmission rate:
 1 200 Bit/s
 Galvanic isolation:
 Yes

Current output

4 to 20 mA with superimposed digital communication protocol HART, 2-wire

The current output offers a choice of three different operating modes:

- 4.0 to 20.5 mA
- NAMUR NE 43: 3.8 to 20.5 mA (factory setting)
- US mode: 3.9 to 20.8 mA

Signal on alarm

Current output

Failure mode (according to NAMUR Recommendation NE 43):

- Minimum alarm (= factory setting): 3.6 mA
- Maximum alarm: 22 mA

Local display

Status signal (according to NAMUR Recommendation NE 107):

Plain text display

Operating tool via service interface (CDI)

Status signal (according to NAMUR Recommendation NE 107):

Plain text display

Operating tool via HART communication

Status signal (according to NAMUR Recommendation NE 107):

Plain text display

Linearization

The linearization function of the device allows the conversion of the measured value into any unit of length, weight, flow or volume.

Pre-programmed linearization curves

Linearization tables for calculating the volume in the following vessels are preprogrammed into the device:

- Pyramid bottom
- Conical bottom
- Angled bottom
- Horizontal cylinder
- Sphere

Other linearization tables of up to 32 value pairs can be entered manually.

Load

4 to 20 mA HART

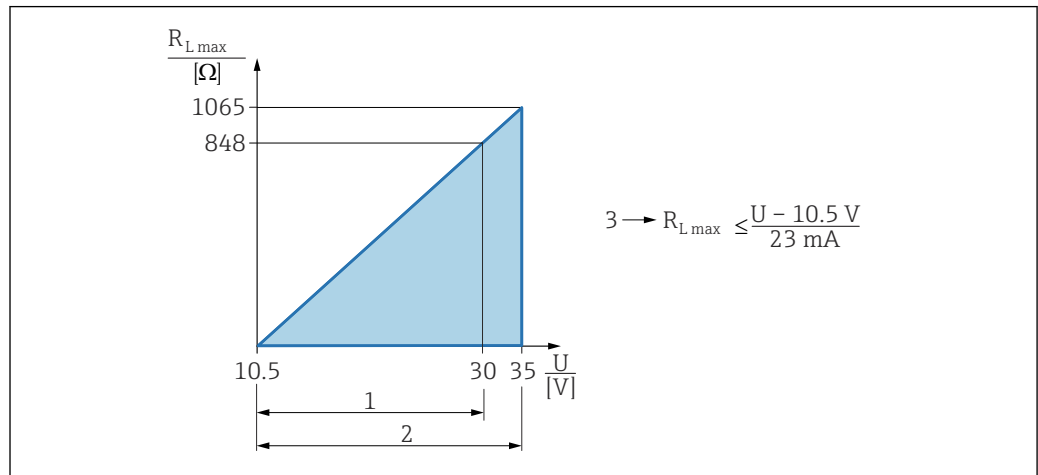

- 1 Power supply 10.5 to 30 VDC Ex i
- 2 Power supply 10.5 to 35 VDC, for other types of protection and non-certified device versions
- 3 $R_{L,max}$ maximum load resistance
- U Supply voltage

Operation via handheld terminal or PC with operating program: take minimum communication resistor of 250 Ω into consideration.

Protocol-specific data

HART

Manufacturer ID:

17 (0x11{hex})

Device type ID:

0x11C1

Device revision:

1

HART specification:

7

DD version:

1

Device description files (DTM, DD)

Information and files under:

- www.endress.com

On the product page for the device: Documents/Software → Device drivers

- www.fieldcommgroup.org

HART load:

Min. 250 Ω

HART device variables

The following measured values are assigned to the device variables at the factory:

Device variable	Measured value
Assign PV ¹⁾	Level linearized
Assign SV	Distance

Device variable	Measured value
Assign TV	Absolute echo amplitude
Assign QV	Relative echo amplitude

1) The PV is always applied to the current output.

Choice of HART device variables

- Level linearized
- Distance
- Terminal voltage
- Electronics temperature
- Sensor temperature
- Absolute echo amplitude
- Relative echo amplitude
- Area of incoupling
- Build-up index
- Build-up detected
- Foam index
- Foam detected
- Percent of range
- Loop current
- Terminal current
- Not used

Supported functions

- Burst mode
- Additional transmitter status
- Device locking

Wireless HART data

Minimum start-up voltage:

10.5 V

Start-up current:

< 3.6 mA

Starting time:

< 15 s

Minimum operating voltage:

10.5 V

Multidrop current:

4 mA

Time to establish connection:

< 30 s

15.3 Environment

Ambient temperature range

The following values apply up to a process temperature of +85 °C (+185 °F). At higher process temperatures, the permitted ambient temperature is reduced.

- Without LCD display:
 - Standard: -40 to +85 °C (-40 to +185 °F)
 - Optionally available: -50 to +85 °C (-58 to +185 °F) with restricted operating life and performance
 - Optionally available: -60 to +85 °C (-76 to +185 °F) with restricted operating life and performance; below -50 °C (-58 °F): devices can be damaged permanently
- With LCD display: -40 to +85 °C (-40 to +185 °F) with limitations in optical properties such as display speed and contrast. Can be used without limitations up to -20 to +60 °C (-4 to +140 °F)

- i** If operating outdoors in strong sunlight:
- Mount the device in the shade.
 - Avoid direct sunlight, particularly in warm climatic regions.
 - Use a weather protection cover (see accessories).

Ambient temperature limits

The permitted ambient temperature (T_a) depends on the selected housing material and process temperature range.

In the event of temperature (T_p) at the process connection, the permitted ambient temperature (T_a) is reduced.

- i** The following information only takes functional aspects into consideration. Additional restrictions may apply for certified device versions.

Plastic housing material

Order option; process temperature range: **-20 to +150 °C (-4 to +302 °F)**

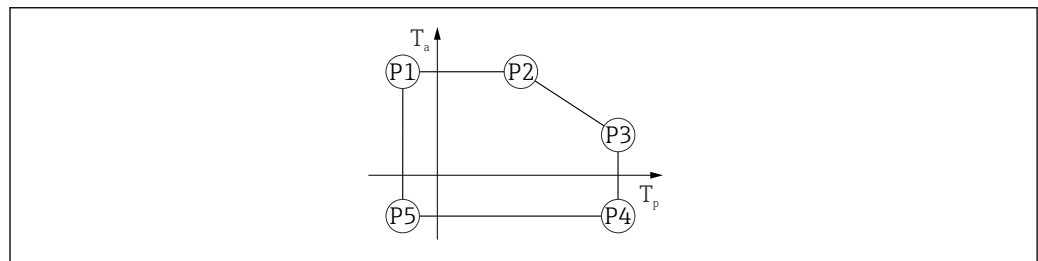

A0032024

15 Plastic housing material; process temperature range: -20 to +150 °C (-4 to +302 °F)

- P1 = T_p : -20 °C (-4 °F) | T_a : +76 °C (+169 °F)
- P2 = T_p : +76 °C (+169 °F) | T_a : +76 °C (+169 °F)
- P3 = T_p : +150 °C (+302 °F) | T_a : +25 °C (+77 °F)
- P4 = T_p : +150 °C (+302 °F) | T_a : -20 °C (-4 °F)
- P5 = T_p : -20 °C (-4 °F) | T_a : -20 °C (-4 °F)

- i** In the case of devices with plastic housings and CSA C/US approval, the selected process temperature range of -20 to +150 °C (-4 to +302 °F) is limited to 0 to +150 °C (+32 to +302 °F).

Process temperature range: **0 to +150 °C (+32 to +302 °F), with CSA C/US approval**

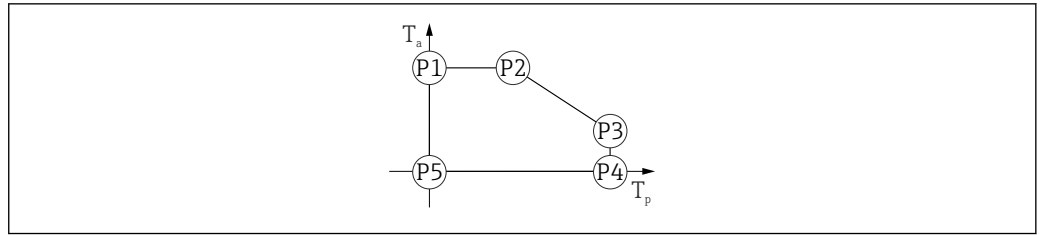

A0048826

16 Plastic housing material; process temperature range: 0 to +150 °C (+32 to +302 °F) with CSA C/US approval

- P1 = T_p : 0 °C (+32 °F) | T_a : +76 °C (+169 °F)
- P2 = T_p : +76 °C (+169 °F) | T_a : +76 °C (+169 °F)
- P3 = T_p : +150 °C (+302 °F) | T_a : +25 °C (+77 °F)
- P4 = T_p : +150 °C (+302 °F) | T_a : 0 °C (+32 °F)
- P5 = T_p : 0 °C (+32 °F) | T_a : 0 °C (+32 °F)

Order option; process temperature range: -20 to +200 °C (-4 to +392 °F)

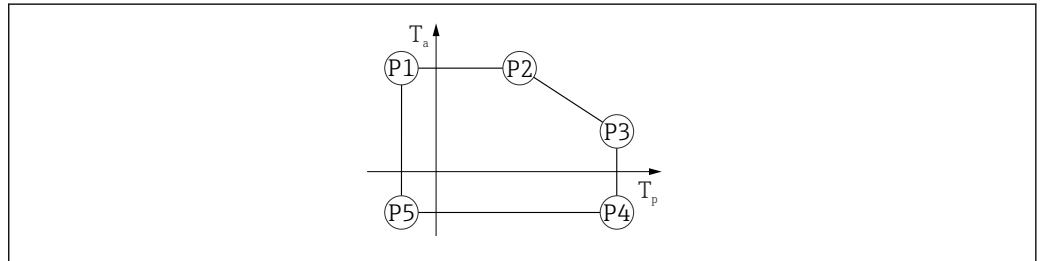

A0032024

17 Plastic housing material; process temperature range: -20 to +200 °C (-4 to +392 °F)

- P1 = T_p : -20 °C (-4 °F) | T_a : +76 °C (+169 °F)
- P2 = T_p : +76 °C (+169 °F) | T_a : +76 °C (+169 °F)
- P3 = T_p : +200 °C (+392 °F) | T_a : +27 °C (+81 °F)
- P4 = T_p : +200 °C (+392 °F) | T_a : -20 °C (-4 °F)
- P5 = T_p : -20 °C (-4 °F) | T_a : -20 °C (-4 °F)

i In the case of devices with plastic housings and CSA C/US approval, the selected process temperature range of -20 to +200 °C (-4 to +392 °F) is limited to 0 to +200 °C (+32 to +392 °F).

Process temperature range: 0 to +200 °C (+32 to +392 °F), restriction with CSA C/US approval

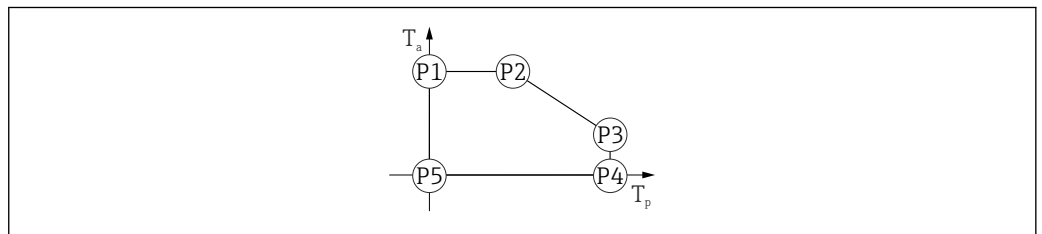

A0048826

18 Plastic housing material; process temperature range: 0 to +200 °C (+32 to +392 °F) with CSA C/US approval

- P1 = T_p : 0 °C (+32 °F) | T_a : +76 °C (+169 °F)
- P2 = T_p : +76 °C (+169 °F) | T_a : +76 °C (+169 °F)
- P3 = T_p : +200 °C (+392 °F) | T_a : +27 °C (+81 °F)
- P4 = T_p : +200 °C (+392 °F) | T_a : 0 °C (+32 °F)
- P5 = T_p : 0 °C (+32 °F) | T_a : 0 °C (+32 °F)

Process temperature range: -40 to +150 °C (-40 to +302 °F)

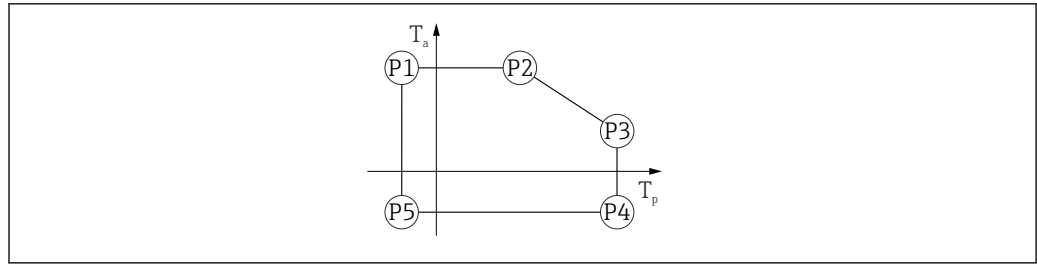

A0032024

19 Plastic housing material; process temperature range: -40 to $+150$ °C (-40 to $+302$ °F)

- P1 = T_p : -40 °C (-40 °F) | T_a : $+76$ °C ($+169$ °F)
- P2 = T_p : $+76$ °C ($+169$ °F) | T_a : $+76$ °C ($+169$ °F)
- P3 = T_p : $+150$ °C ($+302$ °F) | T_a : $+25$ °C ($+77$ °F)
- P4 = T_p : $+150$ °C ($+302$ °F) | T_a : -40 °C (-40 °F)
- P5 = T_p : -40 °C (-40 °F) | T_a : -40 °C (-40 °F)

i In the case of devices with plastic housings and CSA C/US approval, the selected process temperature range of -40 to $+150$ °C (-40 to $+302$ °F) is limited to 0 to $+150$ °C ($+32$ to $+302$ °F).

Process temperature range: **0 to $+150$ °C ($+32$ to $+302$ °F), with CSA C/US approval**

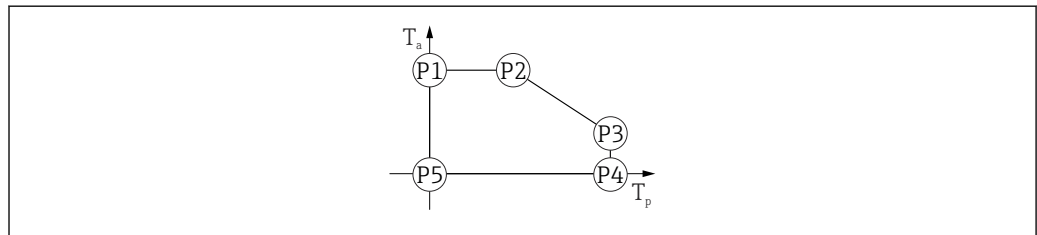

A0048826

20 Plastic housing material; process temperature range: 0 to $+150$ °C ($+32$ to $+302$ °F) with CSA C/US approval

- P1 = T_p : 0 °C ($+32$ °F) | T_a : $+76$ °C ($+169$ °F)
- P2 = T_p : $+76$ °C ($+169$ °F) | T_a : $+76$ °C ($+169$ °F)
- P3 = T_p : $+150$ °C ($+302$ °F) | T_a : $+25$ °C ($+77$ °F)
- P4 = T_p : $+150$ °C ($+302$ °F) | T_a : 0 °C ($+32$ °F)
- P5 = T_p : 0 °C ($+32$ °F) | T_a : 0 °C ($+32$ °F)

Process temperature range: **-40 to $+200$ °C (-40 to $+392$ °F)**

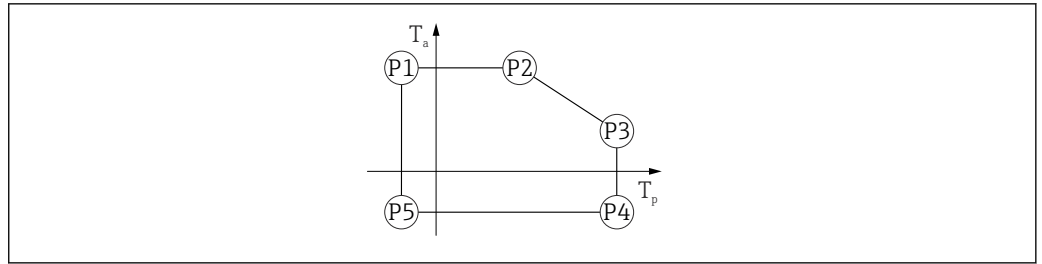

A0032024

21 Plastic housing material; process temperature range: -40 to $+200$ °C (-40 to $+392$ °F)

- P1 = T_p : -40 °C (-40 °F) | T_a : $+76$ °C ($+169$ °F)
- P2 = T_p : $+76$ °C ($+169$ °F) | T_a : $+76$ °C ($+169$ °F)
- P3 = T_p : $+200$ °C ($+392$ °F) | T_a : $+27$ °C ($+81$ °F)
- P4 = T_p : $+200$ °C ($+392$ °F) | T_a : -40 °C (-40 °F)
- P5 = T_p : -40 °C (-40 °F) | T_a : -40 °C (-40 °F)

i In the case of devices with plastic housings and CSA C/US approval, the selected process temperature range of -40 to $+200$ °C (-40 to $+392$ °F) is limited to 0 to $+200$ °C ($+32$ to $+392$ °F).

Process temperature range: **0 to $+200$ °C ($+32$ to $+392$ °F), with CSA C/US approval**

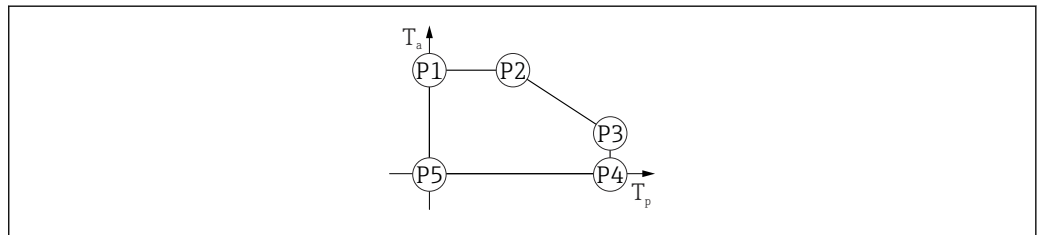

A0048826

22 Plastic housing material; process temperature range: 0 to $+200$ °C ($+32$ to $+392$ °F) with CSA C/US approval

- P1 = T_p : 0 °C ($+32$ °F) | T_a : $+76$ °C ($+169$ °F)
- P2 = T_p : $+76$ °C ($+169$ °F) | T_a : $+76$ °C ($+169$ °F)
- P3 = T_p : $+200$ °C ($+392$ °F) | T_a : $+27$ °C ($+81$ °F)
- P4 = T_p : $+200$ °C ($+392$ °F) | T_a : 0 °C ($+32$ °F)
- P5 = T_p : 0 °C ($+32$ °F) | T_a : 0 °C ($+32$ °F)

Aluminum housing material

Order option; process temperature range: -20 to $+150$ °C (-4 to $+302$ °F)

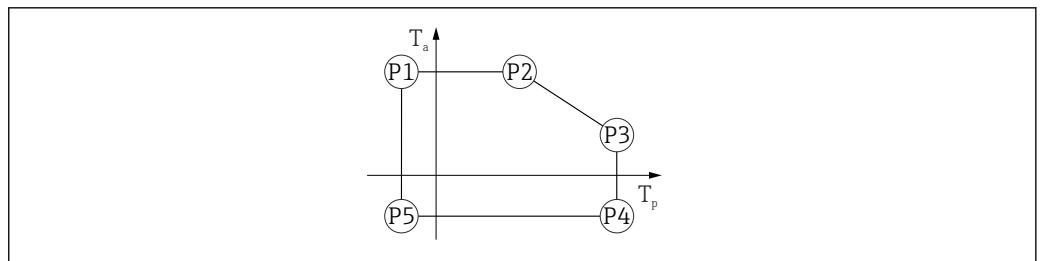

A0032024

23 Aluminum housing material; process temperature range: -20 to $+150$ °C (-4 to $+302$ °F)

- P1 = T_p : -20 °C (-4 °F) | T_a : $+79$ °C ($+174$ °F)
- P2 = T_p : $+79$ °C ($+174$ °F) | T_a : $+79$ °C ($+174$ °F)
- P3 = T_p : $+150$ °C ($+302$ °F) | T_a : $+53$ °C ($+127$ °F)
- P4 = T_p : $+150$ °C ($+302$ °F) | T_a : -20 °C (-4 °F)
- P5 = T_p : -20 °C (-4 °F) | T_a : -20 °C (-4 °F)

Order option; process temperature range: -20 to $+200$ °C (-4 to $+392$ °F)

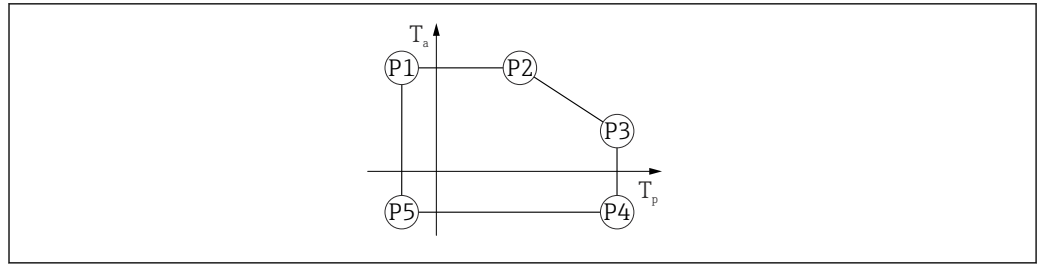

A0032024

24 Aluminum housing material; process temperature range: -20 to +200 °C (-4 to +392 °F)

- P1 = T_p: -20 °C (-4 °F) | T_a: +79 °C (+174 °F)
- P2 = T_p: +79 °C (+174 °F) | T_a: +79 °C (+174 °F)
- P3 = T_p: +200 °C (+392 °F) | T_a: +47 °C (+117 °F)
- P4 = T_p: +200 °C (+392 °F) | T_a: -20 °C (-4 °F)
- P5 = T_p: -20 °C (-4 °F) | T_a: -20 °C (-4 °F)

Order option; process temperature range: -40 to +150 °C (-40 to +302 °F)

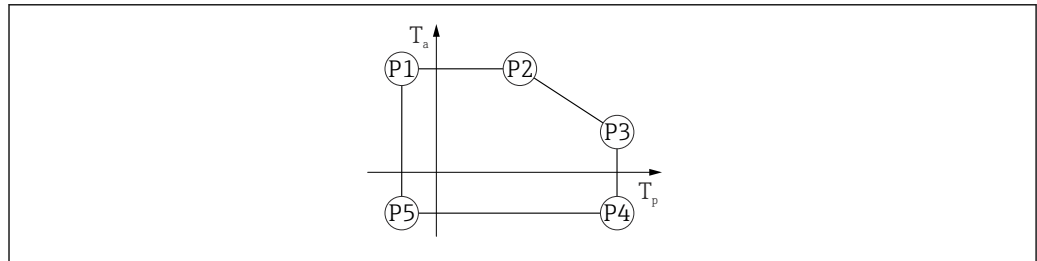

A0032024

25 Aluminum housing material; process temperature range: -40 to +150 °C (-40 to +302 °F)

- P1 = T_p: -40 °C (-40 °F) | T_a: +79 °C (+174 °F)
- P2 = T_p: +79 °C (+174 °F) | T_a: +79 °C (+174 °F)
- P3 = T_p: +150 °C (+302 °F) | T_a: +53 °C (+127 °F)
- P4 = T_p: +150 °C (+302 °F) | T_a: -40 °C (-40 °F)
- P5 = T_p: -40 °C (-40 °F) | T_a: -40 °C (-40 °F)

Order option; process temperature range: -40 to +200 °C (-40 to +392 °F)

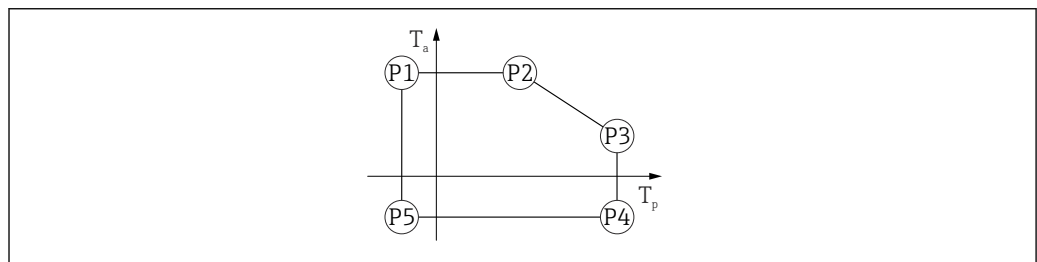

A0032024

26 Aluminum housing material; process temperature range: -40 to +200 °C (-40 to +392 °F)

- P1 = T_p: -40 °C (-40 °F) | T_a: +76 °C (+169 °F)
- P2 = T_p: +76 °C (+169 °F) | T_a: +76 °C (+169 °F)
- P3 = T_p: +200 °C (+392 °F) | T_a: +47 °C (+117 °F)
- P4 = T_p: +200 °C (+392 °F) | T_a: -40 °C (-40 °F)
- P5 = T_p: -40 °C (-40 °F) | T_a: -40 °C (-40 °F)

316L housing material

Order option; process temperature range: -20 to +150 °C (-4 to +302 °F)

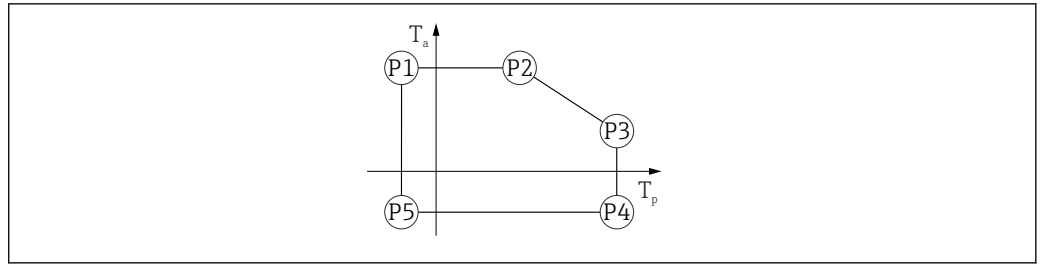

A0032024

27 316L housing material; process temperature range: -20 to $+150$ °C (-4 to $+302$ °F)

- P1 = T_p : -20 °C (-4 °F) | T_a : $+77$ °C ($+171$ °F)
- P2 = T_p : $+77$ °C ($+171$ °F) | T_a : $+77$ °C ($+171$ °F)
- P3 = T_p : $+150$ °C ($+302$ °F) | T_a : $+43$ °C ($+109$ °F)
- P4 = T_p : $+150$ °C ($+302$ °F) | T_a : -20 °C (-4 °F)
- P5 = T_p : -20 °C (-4 °F) | T_a : -20 °C (-4 °F)

Order option; process temperature range: -20 to $+200$ °C (-4 to $+392$ °F)

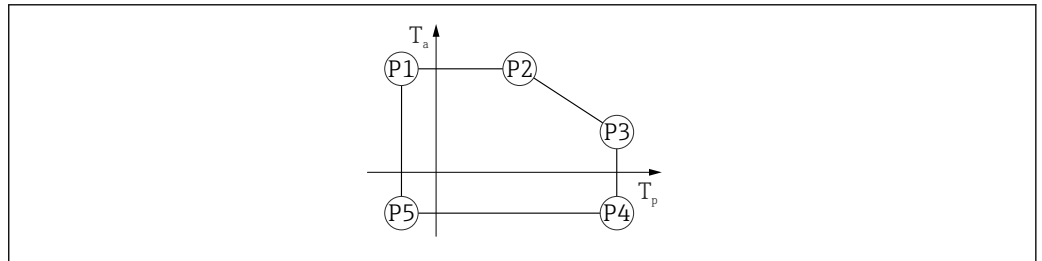

A0032024

28 316L housing material; process temperature range: -20 to $+200$ °C (-4 to $+392$ °F)

- P1 = T_p : -20 °C (-4 °F) | T_a : $+77$ °C ($+171$ °F)
- P2 = T_p : $+77$ °C ($+171$ °F) | T_a : $+77$ °C ($+171$ °F)
- P3 = T_p : $+200$ °C ($+392$ °F) | T_a : $+38$ °C ($+100$ °F)
- P4 = T_p : $+200$ °C ($+392$ °F) | T_a : -20 °C (-4 °F)
- P5 = T_p : -20 °C (-4 °F) | T_a : -20 °C (-4 °F)

Order option; process temperature range: -40 to $+150$ °C (-40 to $+302$ °F)

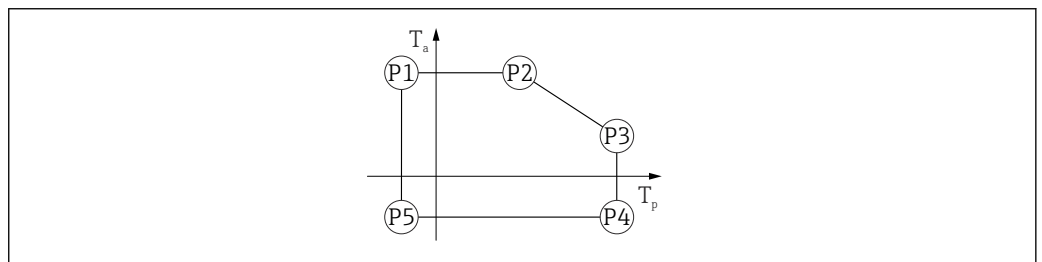

A0032024

29 316L housing material; process temperature range: -40 to $+150$ °C (-40 to $+302$ °F)

- P1 = T_p : -40 °C (-40 °F) | T_a : $+77$ °C ($+171$ °F)
- P2 = T_p : $+77$ °C ($+171$ °F) | T_a : $+77$ °C ($+171$ °F)
- P3 = T_p : $+150$ °C ($+302$ °F) | T_a : $+43$ °C ($+109$ °F)
- P4 = T_p : $+150$ °C ($+302$ °F) | T_a : -40 °C (-40 °F)
- P5 = T_p : -40 °C (-40 °F) | T_a : -40 °C (-40 °F)

Order option; process temperature range: -40 to $+200$ °C (-40 to $+392$ °F)

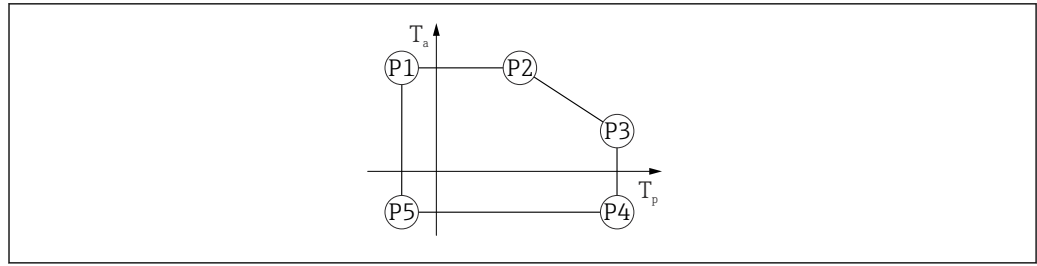

A0032024

■ 30 316L housing material; process temperature range: -40 to +200 °C (-40 to +392 °F)

- P1 = T_p : -40 °C (-40 °F) | T_a : +77 °C (+171 °F)
- P2 = T_p : +77 °C (+171 °F) | T_a : +77 °C (+171 °F)
- P3 = T_p : +200 °C (+392 °F) | T_a : +38 °C (+100 °F)
- P4 = T_p : +200 °C (+392 °F) | T_a : -40 °C (-40 °F)
- P5 = T_p : -40 °C (-40 °F) | T_a : -40 °C (-40 °F)

Storage temperature

- Without LCD display: -40 to +90 °C (-40 to +194 °F)
- With LCD display: -40 to +85 °C (-40 to +185 °F)

Climate class DIN EN 60068-2-38 (test Z/AD)

Installation height as per IEC61010-1 Ed.3

- Generally up to 2 000 m (6 600 ft) above sea level
- Over 2 000 m (6 600 ft) under the following conditions:
 - Supply voltage < 35 V_{DC}
 - Power supply, overvoltage category 1

Degree of protection Test as per IEC 60529 and NEMA 250-2014

Housing and process connection

IP66/68, TYPE 4X/6P
(IP68: (1.83 mH₂O for 24 h))

Cable entries

- Gland M20, plastic, IP66/68 TYPE 4X/6P
- Gland M20, brass nickel plated, IP66/68 TYPE 4X/6P
- Gland M20, 316L, IP66/68 TYPE 4X/6P
- Thread M20, IP66/68 TYPE 4X/6P
- Thread G1/2, IP66/68 TYPE 4X/6P
 - If the G1/2 thread is selected, the device is delivered with an M20 thread as standard and a G1/2 adapter is included with the delivery, along with the corresponding documentation
- Thread NPT1/2, IP66/68 TYPE 4X/6P
- HAN7D plug, 90 degrees, IP65 NEMA Type 4X
- M12 plug
 - When housing is closed and connecting cable is plugged in: IP66/67 NEMA Type 4X
 - When housing is open or connecting cable is not plugged in: IP20, NEMA Type 1

NOTICE

Plug M12 and plug HAN7D: incorrect mounting can invalidate the IP protection class!

- ▶ The degree of protection only applies if the connecting cable used is plugged in and screwed tight.
- ▶ The degree of protection only applies if the connecting cable used is specified according to IP67 NEMA Type 4X.
- ▶ The IP protection classes are only maintained if the dummy cap is used or the cable is connected.

Vibration resistance DIN EN 60068-2-64 / IEC 60068-2-64 for 5 to 2 000 Hz: 1.5 (m/s²)²/Hz

Electromagnetic compatibility (EMC)

- Electromagnetic compatibility as per EN 61326 series and NAMUR recommendation EMC (NE21)
- With regard to the safety function (SIL), the requirements of EN 61326-3-x are satisfied
- Maximum measured error during EMC testing: < 0.5 % of the span.

For more details refer to the EU Declaration of Conformity.

15.4 Process

Process pressure range

⚠ WARNING

The maximum pressure for the device depends on the lowest-rated component with regard to pressure (components are: process connection, optional mounted parts or accessories).

- ▶ Only operate the device within the specified limits for the components!
- ▶ MWP (Maximum Working Pressure): The MWP is specified on the nameplate. This value refers to a reference temperature of +20 °C (+68 °F) and may be applied to the device for an unlimited time. Note temperature dependence of MWP. For flanges, refer to the following standards for the permitted pressure values at higher temperatures: EN 1092-1 (with regard to their stability/temperature property, the materials 1.4435 and 1.4404 are grouped together under EN 1092-1; the chemical composition of the two materials can be identical), ASME B16.5, JIS B2220 (the latest version of the standard applies in each case). MWP data that deviate from this are provided in the relevant sections of the Technical Information.
- ▶ The Pressure Equipment Directive (2014/68/EU) uses the abbreviation **PS**. This corresponds to the maximum working pressure (MWP) of the device.

The following tables show the dependencies between the seal material, process temperature (T_p) and process pressure range for each process connection that can be selected for the antenna used.

Integrated antenna, PEEK, 20 mm (0.75 in)

Process connection M24 with process adapter, accessory enclosed

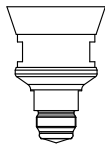
	Seal	T _p	Process pressure range
 <p>A0048027</p>	FKM Viton GLT	-40 to +150 °C (-40 to +302 °F)	-1 to 20 bar (-14.5 to 290 psi)
	FKM Viton GLT	-40 to +200 °C (-40 to +392 °F)	-1 to 20 bar (-14.5 to 290 psi)
	EPDM	-40 to +150 °C (-40 to +302 °F)	-1 to 20 bar (-14.5 to 290 psi)

	Seal	T _p	Process pressure range
	FFKM Kalrez	-20 to +150 °C (-4 to +302 °F)	-1 to 20 bar (-14.5 to 290 psi)
	FFKM Kalrez	-20 to +200 °C (-4 to +392 °F)	-1 to 20 bar (-14.5 to 290 psi)

 The pressure range may be further restricted in the event of a CRN approval.

Antenna, cladded flush mount, PTFE, 50 mm (2 in)

Process connection Tri-Clamp DN51 (2") ISO2852

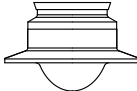
	Seal	T _p	Process pressure range
 <small>A0047838</small>	PTFE cladded	-40 to +150 °C (-40 to +302 °F)	-1 to 16 bar (-14.5 to 232 psi)
	PTFE cladded	-40 to +200 °C (-40 to +392 °F)	-1 to 16 bar (-14.5 to 232 psi)

Process connection Tri-Clamp DN70-76.1 (3") ISO2852

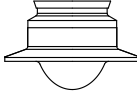
	Seal	T _p	Process pressure range
 <small>A0047838</small>	PTFE cladded	-40 to +150 °C (-40 to +302 °F)	-1 to 14 bar (-14.5 to 203 psi)
	PTFE cladded	-40 to +200 °C (-40 to +392 °F)	-1 to 14 bar (-14.5 to 203 psi)

Process connection slotted nut DIN11851 DN50 PN25

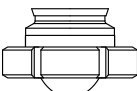
	Seal	T _p	Process pressure range
 <small>A0050063</small>	PTFE cladded	-40 to +150 °C (-40 to +302 °F)	-1 to 25 bar (-14.5 to 362.6 psi)
	PTFE cladded	-40 to +200 °C (-40 to +392 °F)	-1 to 25 bar (-14.5 to 362.6 psi)

 The pressure range may be further restricted in the event of a CRN approval.

Antenna, cladded flush mount, PTFE, 80 mm (3 in)

Process connection Tri-Clamp DN101.6 (4") ISO2852

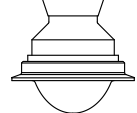
	Seal	T _p	Process pressure range
 <small>A0047826</small>	PTFE cladded	-40 to +150 °C (-40 to +302 °F)	-1 to 14 bar (-14.5 to 203 psi)
	PTFE cladded	-40 to +200 °C (-40 to +392 °F)	-1 to 14 bar (-14.5 to 203 psi)

Process connection slotted nut DIN11851 DN80 PN25

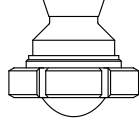
	Seal	T _p	Process pressure range
 A0047825	PTFE cladded	-40 to +150 °C (-40 to +302 °F)	-1 to 25 bar (-14.5 to 362.6 psi)
	PTFE cladded	-40 to +200 °C (-40 to +392 °F)	-1 to 25 bar (-14.5 to 362.6 psi)

 The pressure range may be further restricted in the event of a CRN approval.

Dielectric constant

For liquids

$$\epsilon_r \geq 1.2$$

Contact Endress+Hauser for applications with lower dielectric constants than indicated.

Index

A

Access authorization to parameters	
Read access	29
Write access	29
Access code	29
Incorrect input	29
Application	8

B

Bluetooth® wireless technology	31
--	----

C

CE mark (Declaration of Conformity)	9
Cleaning	48
Climate class	72

D

Declaration of Conformity	9
Device locking, status	37
Device Viewer	49
DeviceCare	32
Diagnostic event	40
In the operating tool	41
Diagnostic events	39
Diagnostic list	42
Diagnostic message	39
Diagnostics	
Symbols	39
Display values	
For locking status	37
Disposal	50
Document	
Purpose	5

E

Event history	44
Event list	44
Event text	40
Exterior cleaning	48

F

Field of application	
Residual risks	8
FieldCare	32
Function	32
Filtering the event logbook	44
Functional Safety Manual (FY)	6
FV (HART variable)	33

H

HART integration	33
HART protocol	34
HART variables	33

I

Intended use	8
------------------------	---

L

Local display	
see Diagnostic message	
see In alarm condition	

M

Media	8
-----------------	---

O

Operating elements	
Diagnostic message	41
Operation	37
Operational safety	9

P

Product safety	9
Purpose of this document	5
PV (HART variable)	33

R

Read access	29
Reading off measured values	37
Registered trademarks	7
Repair concept	49
Requirements concerning the staff	8
Return	50

S

Safety instructions	
Basic	8
Safety Instructions (XA)	6
Securing screw	21
Service interface (CDI)	35
Settings	
Adapting the measuring device to the process	
conditions	37
Spare parts	49
Nameplate	49
Status signals	40
Submenu	
Event list	44
SV (HART variable)	33

T

Troubleshooting	38
Turning the display module	17
TV (HART variable)	33

U

Use of the measuring device	
see Intended use	
Use of the measuring devices	
Borderline cases	8
Incorrect use	8

W

Workplace safety	9
----------------------------	---

Write access 29



www.addresses.endress.com
