

Brief Operating Instructions

Proline Promag L 400

Electromagnetic flowmeter

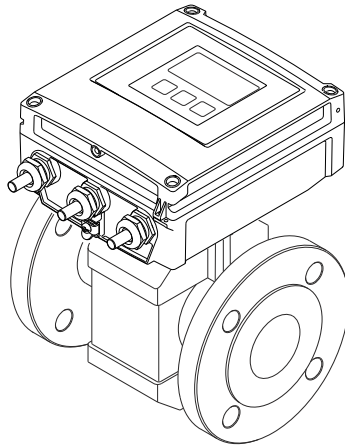

These Instructions are Brief Operating Instructions; they are not a substitute for the Operating Instructions pertaining to the device.

Detailed information about the device can be found in the Operating Instructions and the other documentation:

- On the CD-ROM supplied (not included in the delivery for all device versions).
- Available for all device versions via:
 - Internet: www.endress.com/deviceviewer
 - Smart phone/tablet: *Endress+Hauser Operations App*

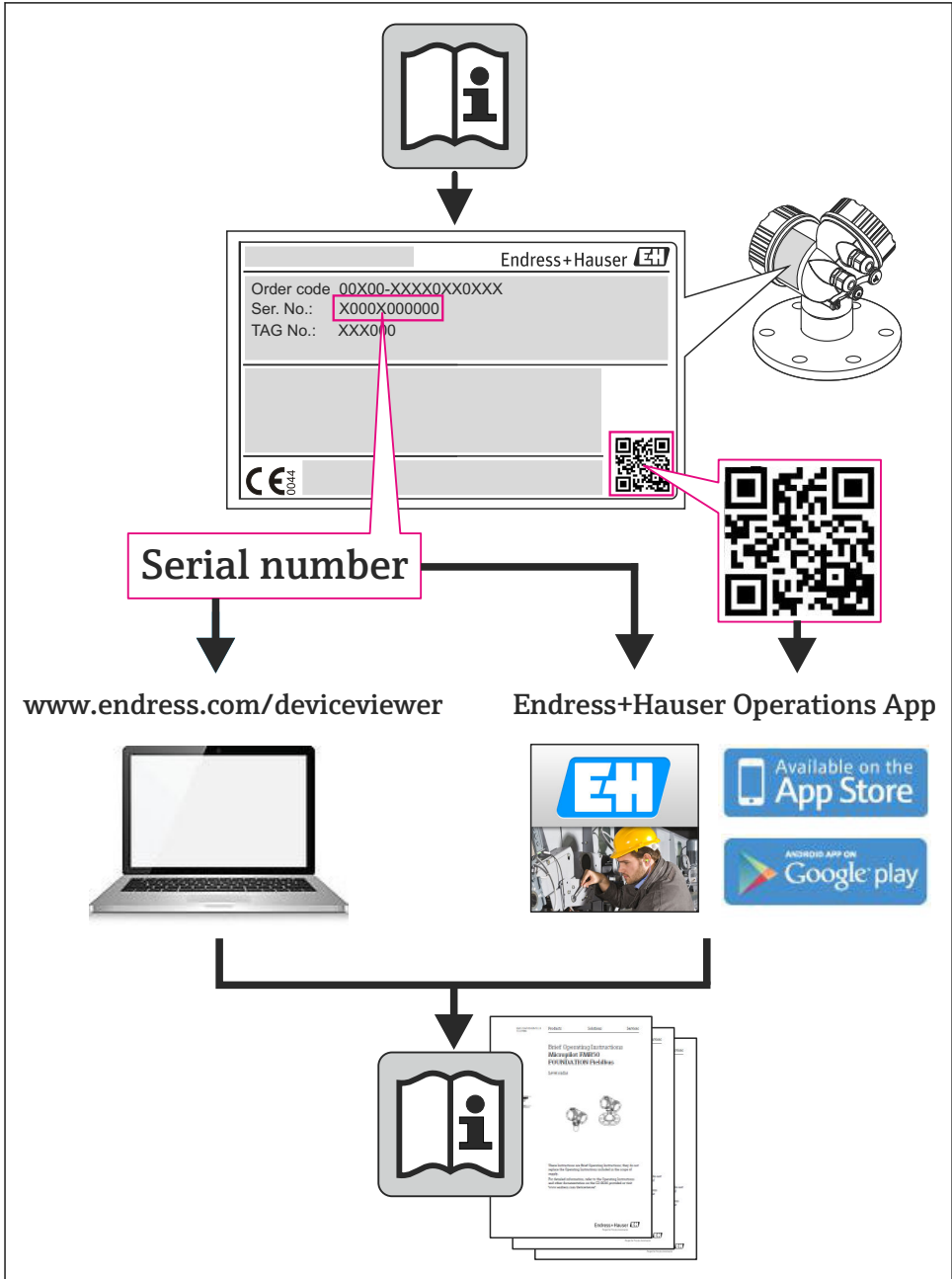

A0023555





Table of contents

1	Document information	4
1.1	Symbols used	4
2	Basic safety instructions	5
2.1	Requirements for the personnel	5
2.2	Designated use	6
2.3	Workplace safety	7
2.4	Operational safety	7
2.5	Product safety	7
2.6	IT security	7
3	Product description	7
4	Incoming acceptance and product identification	8
4.1	Incoming acceptance	8
4.2	Product identification	9
5	Storage and transport	10
5.1	Storage conditions	10
5.2	Transporting the product	10
6	Installation	12
6.1	Installation conditions	12
6.2	Mounting the measuring device	16
6.3	Post-installation check	18
7	Electrical connection	19
7.1	Connection conditions	19
7.2	Connecting the measuring device	27
7.3	Hardware settings	34
7.4	Ensuring the degree of protection	37
7.5	Post-connection check	38
8	Operation options	39
8.1	Structure and function of the operating menu	39
8.2	Access to the operating menu via the local display	40
8.3	Access to the operating menu via the Web browser	44
8.4	Access to the operating menu via the operating tool	48
9	System integration	48
9.1	Cyclic data transfer PROFIBUS DP	48
9.2	Cyclic data processing EtherNet/IP	52
10	Commissioning	57
10.1	Function check	57
10.2	Switching on the measuring device	57
10.3	Configuring the device address via software	57
10.4	Setting the operating language	58
10.5	Configuring the measuring device	58
10.6	Defining the tag name	59
10.7	Protecting settings from unauthorized access	59
11	Diagnostic information	59







1 Document information

1.1 Symbols used





1.1.1 Safety symbols

Symbol	Meaning
	DANGER! This symbol alerts you to a dangerous situation. Failure to avoid this situation will result in serious or fatal injury.
	WARNING! This symbol alerts you to a dangerous situation. Failure to avoid this situation can result in serious or fatal injury.
	CAUTION! This symbol alerts you to a dangerous situation. Failure to avoid this situation can result in minor or medium injury.
	NOTE! This symbol contains information on procedures and other facts which do not result in personal injury.









1.1.2 Electrical symbols

Symbol	Meaning	Symbol	Meaning
	Direct current		Alternating current
	Direct current and alternating current		Ground connection A grounded terminal which, as far as the operator is concerned, is grounded via a grounding system.
	Protective ground connection A terminal which must be connected to ground prior to establishing any other connections.		Equipotential connection A connection that has to be connected to the plant grounding system: This may be a potential equalization line or a star grounding system depending on national or company codes of practice.



1.1.3 Tool symbols

Symbol	Meaning	Symbol	Meaning
	Torx screwdriver		Flat blade screwdriver
	Phillips head screwdriver		Allen key
	Open-ended wrench		

1.1.4 Symbols for certain types of information

Symbol	Meaning	Symbol	Meaning
	Permitted Procedures, processes or actions that are permitted.		Preferred Procedures, processes or actions that are preferred.
	Forbidden Procedures, processes or actions that are forbidden.		Tip Indicates additional information.
	Reference to documentation		Reference to page
	Reference to graphic	1. 2. 3. ...	Series of steps
	Result of a sequence of actions		Visual inspection

1.1.5 Symbols in graphics

Symbol	Meaning	Symbol	Meaning
1, 2, 3, ...	Item numbers	1. 2. 3. ...	Series of steps
A, B, C, ...	Views	A-A, B-B, C-C, ...	Sections
	Hazardous area		Safe area (non-hazardous area)
	Flow direction		

2 Basic safety instructions

2.1 Requirements for the personnel

The personnel must fulfill the following requirements for its tasks:

- ▶ Trained, qualified specialists must have a relevant qualification for this specific function and task
- ▶ Are authorized by the plant owner/operator
- ▶ Are familiar with federal/national regulations
- ▶ Before beginning work, the specialist staff must have read and understood the instructions in the Operating Instructions and supplementary documentation as well as in the certificates (depending on the application)
- ▶ Following instructions and basic conditions

2.2 Designated use

Application and media

The measuring device described in these Instructions is intended only for flow measurement of liquids with a minimum conductivity of 5 $\mu\text{S}/\text{cm}$.

Depending on the version ordered, the measuring device can also measure potentially explosive, flammable, poisonous and oxidizing media.

Measuring devices for use in hazardous areas, in hygienic applications or in applications where there is an increased risk due to process pressure, are labeled accordingly on the nameplate.

To ensure that the measuring device remains in proper condition for the operation time:

- ▶ Only use the measuring device in full compliance with the data on the nameplate and the general conditions listed in the Operating Instructions and supplementary documentation.
- ▶ Based on the nameplate, check whether the ordered device is permitted for the intended use in the hazardous area (e.g. explosion protection, pressure vessel safety).
- ▶ Use the measuring device only for media against which the process-wetted materials are adequately resistant.
- ▶ If the measuring device is not operated at atmospheric temperature, compliance with the relevant basic conditions specified in the associated device documentation is absolutely essential.

Incorrect use

Non-designated use can compromise safety. The manufacturer is not liable for damage caused by improper or non-designated use.

WARNING

Danger of breakage of the sensor due to corrosive or abrasive fluids!

- ▶ Verify the compatibility of the process fluid with the sensor material.
- ▶ Ensure the resistance of all fluid-wetted materials in the process.
- ▶ Observe the specified pressure and temperature range.

Verification for borderline cases:

- ▶ For special fluids and fluids for cleaning, Endress+Hauser is glad to provide assistance in verifying the corrosion resistance of fluid-wetted materials, but does not accept any warranty or liability as minute changes in the temperature, concentration or level of contamination in the process can alter the corrosion resistance properties.

Residual risks

The external surface temperature of the housing can increase by max. 10 K due to the power consumption of the electronic components. Hot process fluids passing through the measuring device will further increase the surface temperature of the housing. The surface of the sensor, in particular, can reach temperatures which are close to the fluid temperature.

Possible burn hazard due to fluid temperatures!

- ▶ For elevated fluid temperature, ensure protection against contact to prevent burns.

2.3 Workplace safety

For work on and with the device:

- ▶ Wear the required personal protective equipment according to federal/national regulations.

For welding work on the piping:

- ▶ Do not ground the welding unit via the measuring device.

If working on and with the device with wet hands:

- ▶ It is recommended to wear gloves on account of the higher risk of electric shock.

2.4 Operational safety

Risk of injury.

- ▶ Operate the device in proper technical condition and fail-safe condition only.
- ▶ The operator is responsible for interference-free operation of the device.

Environmental requirements

If a plastic transmitter housing is permanently exposed to certain steam and air mixtures, this can damage the housing.

- ▶ If you are unsure, please contact your Endress+Hauser Sales Center for clarification.
- ▶ If used in an approval-related area, observe the information on the nameplate.

2.5 Product safety

This measuring device is designed in accordance with good engineering practice to meet state-of-the-art safety requirements, has been tested, and left the factory in a condition in which it is safe to operate.

It meets general safety standards and legal requirements. It also complies with the EC directives listed in the device-specific EC Declaration of Conformity. Endress+Hauser confirms this by affixing the CE mark to the device.

2.6 IT security

We only provide a warranty if the device is installed and used as described in the Operating Instructions. The device is equipped with security mechanisms to protect it against any inadvertent changes to the device settings.

IT security measures in line with operators' security standards and designed to provide additional protection for the device and device data transfer must be implemented by the operators themselves.

3 Product description

The device consists of a transmitter and a sensor.

Two device versions are available:

- Compact version - transmitter and sensor form a mechanical unit.
- Remote version - transmitter and sensor are mounted in separate locations.

 For detailed information on the product description, see the Operating Instructions for the device.

4 Incoming acceptance and product identification

4.1 Incoming acceptance

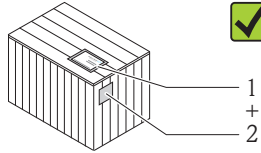
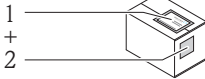

Are the order codes on the delivery note (1) and the product sticker (2) identical?

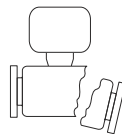
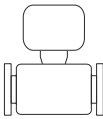
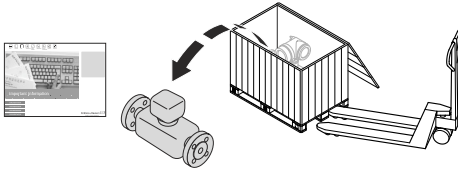

Are the goods undamaged?

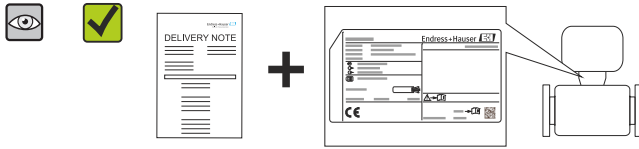

Do the nameplate data match the ordering information on the delivery note?

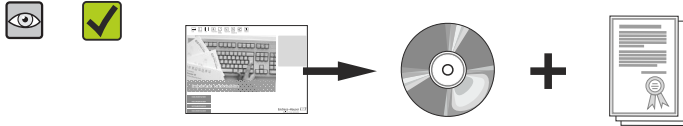

Is the CD-ROM with the Technical Documentation (depends on device version) and documents present?



- If one of the conditions is not satisfied, contact your Endress+Hauser Sales Center.
- Depending on the device version, the CD-ROM might not be part of the delivery! The Technical Documentation is available via the Internet or via the *Endress+Hauser Operations App*.

4.2 Product identification

The following options are available for identification of the measuring device:

- Nameplate specifications
- Order code with breakdown of the device features on the delivery note
- Enter serial numbers from nameplates in *W@M Device Viewer* (www.endress.com/deviceviewer): All information about the measuring device is displayed.
- Enter the serial number from the nameplates into the *Endress+Hauser Operations App* or scan the 2-D matrix code (QR code) on the nameplate with the *Endress+Hauser Operations App*: all the information for the measuring device is displayed.

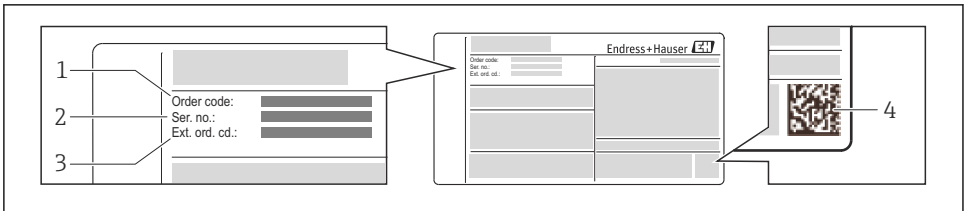

A0021952

1 Example of a nameplate

- 1 Order code
- 2 Serial number (Ser. no.)
- 3 Extended order code (Ext. ord. cd.)
- 4 2-D matrix code (QR code)



For detailed information on the breakdown of the specifications on the nameplate, see the Operating Instructions for the device .

5 Storage and transport

5.1 Storage conditions

Observe the following notes for storage:

- Store in original packaging.
- Do not remove protective covers or protective caps installed on process connections.
- Protect from direct sunlight.
- Select a storage location where moisture cannot collect in the measuring device.
- Store in a dry and dust-free place.
- Do not store outdoors.
- Storage temperature → 📄 12

5.2 Transporting the product

Transport the measuring device to the measuring point in the original packaging.

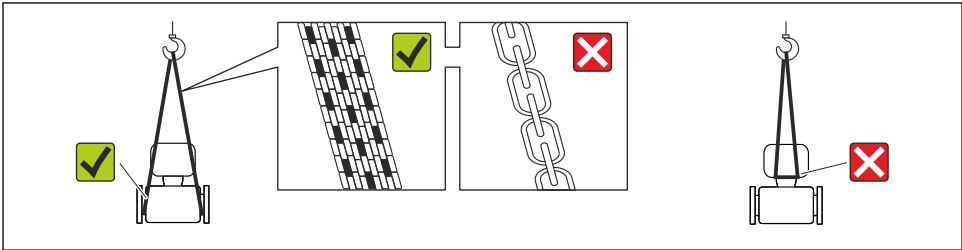

A0015604

i Do not remove protective covers or caps installed on process connections. They prevent mechanical damage to the sealing surfaces and contamination in the measuring tube.

5.2.1 Measuring devices without lifting lugs

⚠ WARNING

Center of gravity of the measuring device is higher than the suspension points of the webbing slings.

Risk of injury if the measuring device slips.

- ▶ Secure the measuring device against slipping or turning.
- ▶ Observe the weight specified on the packaging (stick-on label).

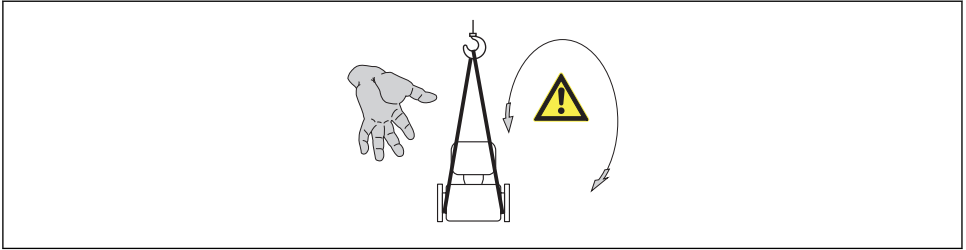

A0015606

5.2.2 Measuring devices with lifting lugs

⚠ CAUTION

Special transportation instructions for devices with lifting lugs

- ▶ Only use the lifting lugs fitted on the device or flanges to transport the device.
- ▶ The device must always be secured at two lifting lugs at least.

5.2.3 Transporting with a fork lift

If transporting in wood crates, the floor structure enables the crates to be lifted lengthwise or at both sides using a forklift.

⚠ CAUTION

Risk of damaging the magnetic coil

- ▶ If transporting by forklift, do not lift the sensor by the metal casing.
- ▶ This would buckle the casing and damage the internal magnetic coils.

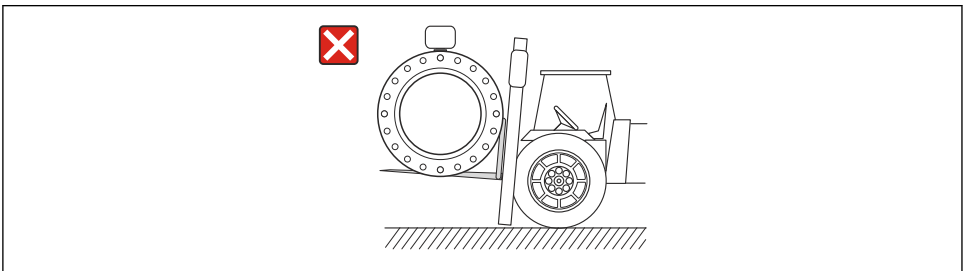

A0023726

6 Installation

6.1 Installation conditions

6.1.1 Mounting position

Mounting location

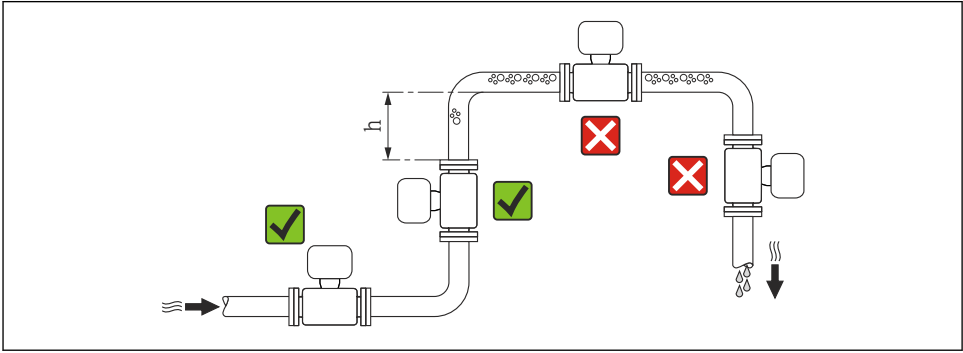

A0023343

$$h \geq 2 \times DN$$

Installation in down pipes

Install a siphon with a vent valve downstream of the sensor in down pipes whose length $h \geq 5$ m (16.4 ft). This precaution is to avoid low pressure and the consequent risk of damage to the measuring tube. This measure also prevents the system losing prime.

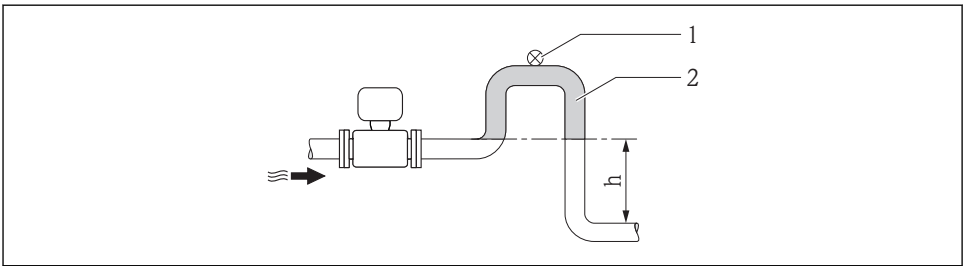

A0017064

2 Installation in a down pipe

- 1 Vent valve
- 2 Pipe siphon
- h Length of down pipe

Installation in partially filled pipes

A partially filled pipe with a gradient necessitates a drain-type configuration.

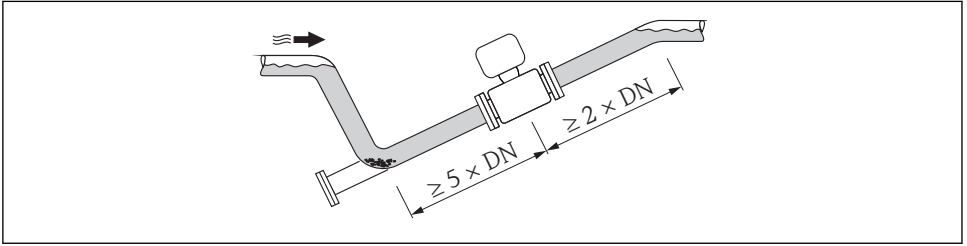

A0017063

Orientation

The direction of the arrow on the sensor nameplate helps you to install the sensor according to the flow direction.

An optimum orientation position helps avoid gas and air accumulations and deposits in the measuring tube.

Vertical

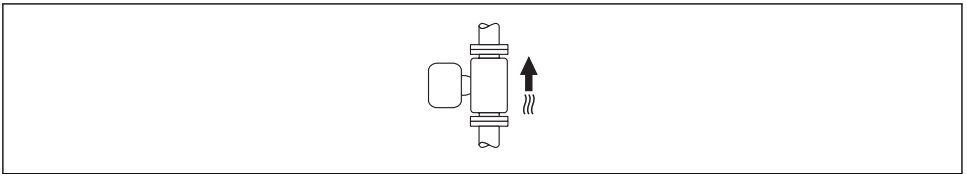

A0015591

Optimum for self-emptying pipe systems and for use in conjunction with empty pipe detection.

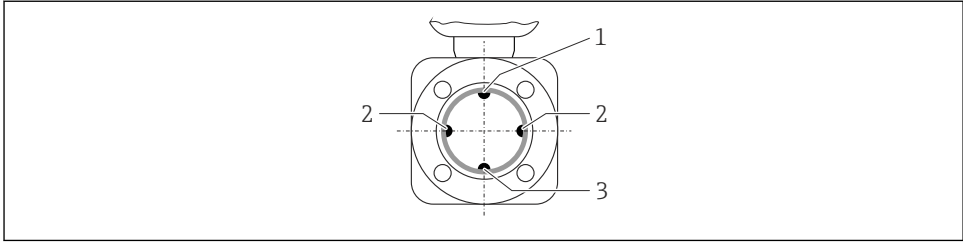
Horizontal

A0016260

- 1 EPD electrode for empty pipe detection
- 2 Measuring electrodes for signal detection
- 3 Reference electrode for potential equalization

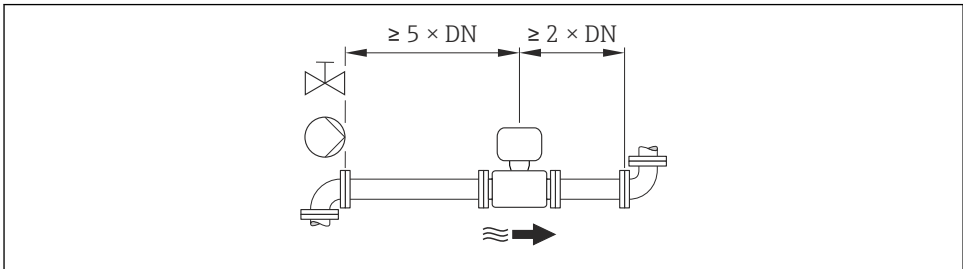

- The measuring electrode plane must be horizontal. This prevents brief insulation of the two measuring electrodes by entrained air bubbles.
- Empty pipe detection only works if the transmitter housing is pointing upwards as otherwise there is no guarantee that the empty pipe detection function will actually respond to a partially filled or empty measuring tube.

Inlet and outlet runs

A0016275



For the dimensions and installation lengths of the device, see the "Technical Information" document, "Mechanical construction" section

6.1.2 Requirements from environment and process**Ambient temperature range**

For detailed information on the ambient temperature range, see the Operating Instructions for the device.

If operating outdoors:

- Install the measuring device in a shady location.
- Avoid direct sunlight, particularly in warm climatic regions.
- Avoid direct exposure to weather conditions.

Temperature tables



Observe the interdependencies between the permitted ambient and fluid temperatures when operating the device in hazardous areas.



For detailed information on the temperature tables, see the separate document entitled "Safety Instructions" (XA) for the device.

System pressure

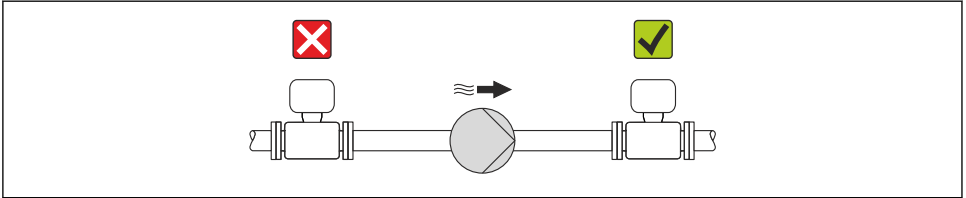

A0015594



Furthermore, install pulse dampers if reciprocating, diaphragm or peristaltic pumps are used.

Vibrations

It is recommended to mount the sensor and transmitter separately.

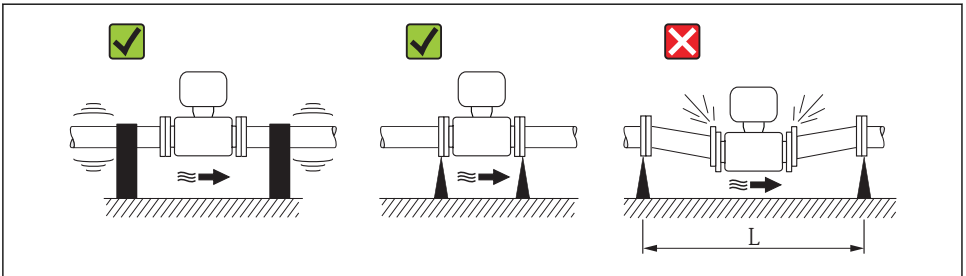

A0016266



3 Measures to avoid device vibrations ($L > 10\text{ m (33 ft)}$)

Adapters

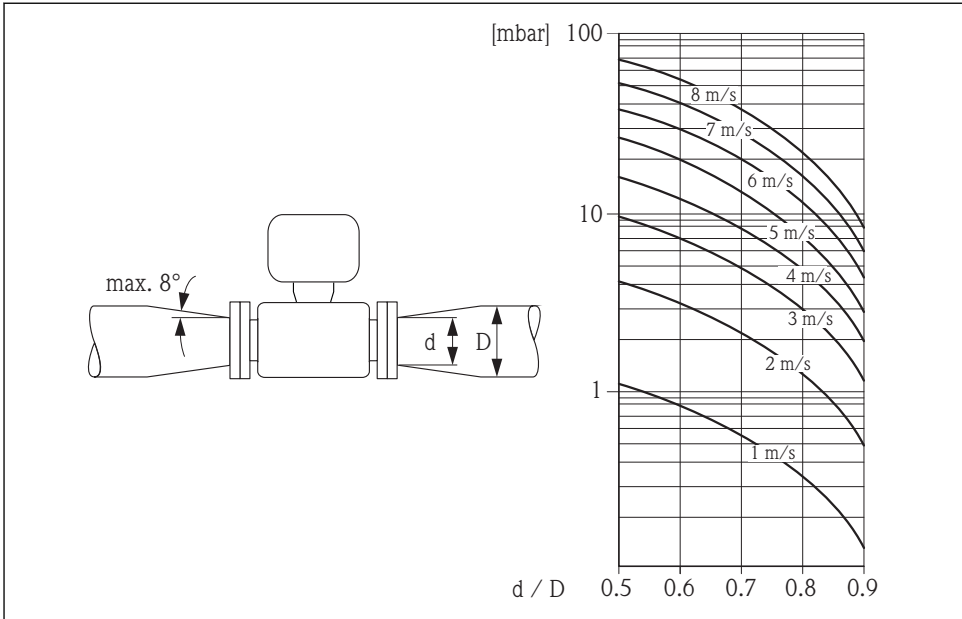

A0016359

6.1.3 Special mounting instructions

Display protection

- ▶ To ensure that the optional display protection can be easily opened, maintain the following minimum head clearance: 350 mm (13.8 in)

6.2 Mounting the measuring device

6.2.1 Required tools

For transmitter

- Torque wrench
- For wall mounting:
 - Open-ended wrench for hexagonal screw max. M5
- For pipe mounting:
 - Open-ended wrench AF 8
 - Phillips head screwdriver PH 2
- For turning the transmitter housing (compact version):
 - Phillips head screwdriver PH 2
 - Torx screwdriver TX 20
 - Open-ended wrench AF 7

For sensor

For flanges and other process connections:

- Screws, nuts, seals etc. are not included in the scope of supply and must be provided by the customer.
- Appropriate mounting tools

6.2.2 Preparing the measuring device

1. Remove all remaining transport packaging.
2. Remove any protective covers or protective caps present from the sensor.
3. Remove stick-on label on the electronics compartment cover.

6.2.3 Mounting the sensor

⚠ WARNING

Danger due to improper process sealing!

- ▶ Ensure that the inside diameters of the gaskets are greater than or equal to that of the process connections and piping.
- ▶ Ensure that the gaskets are clean and undamaged.
- ▶ Install the gaskets correctly.

1. Ensure that the direction of the arrow on the sensor matches the flow direction of the medium.
2. To ensure compliance with device specifications, install the measuring device between the pipe flanges in a way that it is centered in the measurement section.
3. If using ground disks, comply with the Installation Instructions provided.
4. Observe required screw tightening torques → 📄 18.
5. Install the measuring device or turn the transmitter housing so that the cable entries do not point upwards.

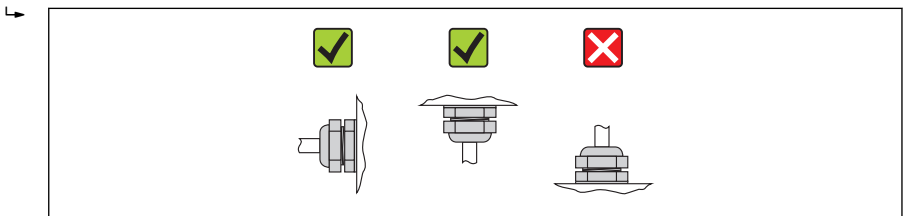

A0013964

Mounting the seals

⚠ CAUTION

An electrically conductive layer could form on the inside of the measuring tube!

Risk of measuring signal short circuit.

- ▶ Do not use electrically conductive sealing compounds such as graphite.

Comply with the following instructions when installing seals:

- Make sure that the seals do not protrude into the piping cross-section.
- For DIN flanges: only use seals according to DIN EN 1514-1.
- For "hard rubber" lining: additional seals are **always** required.
- For "polyurethane" lining: generally additional seals are **not** required.
- For "PTFE" lining: generally additional seals are **not** required.

Mounting the ground cable/ground disks

Comply with the information on potential equalization and detailed mounting instructions for the use of ground cables/ground disks →  33.

Screw tightening torques



For detailed information on the screw tightening torques, see the "Mounting the sensor" section of the Operating Instructions for the device

6.3 Post-installation check

Is the device undamaged (visual inspection)?	<input type="checkbox"/>
Does the measuring device conform to the measuring point specifications? For example: <ul style="list-style-type: none"> ▪ Process temperature ▪ Process pressure (refer to the section on "Pressure-temperature ratings" in the "Technical Information" document on the CD-ROM provided) ▪ Ambient temperature ▪ Measuring range 	<input type="checkbox"/>
Has the correct orientation for the sensor been selected ? <ul style="list-style-type: none"> ▪ According to sensor type ▪ According to medium temperature ▪ According to medium properties (outgassing, with entrained solids) 	<input type="checkbox"/>
Does the arrow on the sensor nameplate match the direction of flow of the fluid through the piping ?	<input type="checkbox"/>
Are the measuring point identification and labeling correct (visual inspection)?	<input type="checkbox"/>
Is the device adequately protected from precipitation and direct sunlight?	<input type="checkbox"/>
Have the fixing screws been tightened with the correct tightening torque?	<input type="checkbox"/>

7 Electrical connection



The measuring device does not have an internal circuit breaker. For this reason, assign the measuring device a switch or power-circuit breaker so that the power supply line can be easily disconnected from the mains.

7.1 Connection conditions

7.1.1 Required tools

- Torque wrench
- For cable entries: Use corresponding tools
- For housing cover: Torx screwdriver or flat-blade screwdriver
- Wire stripper
- When using stranded cables: crimping tool for ferrule

7.1.2 Requirements for connecting cable

The connecting cables provided by the customer must fulfill the following requirements.

Electrical safety

In accordance with applicable federal/national regulations.

Permitted temperature range

- -40 °C (-40 °F) to $+80\text{ °C}$ ($+176\text{ °F}$)
- Minimum requirement: cable temperature range \geq ambient temperature $+20\text{ K}$

Power supply cable

Standard installation cable is sufficient.

Signal cable

Current output

- For 0-20 mA and 4-20 mA: standard installation cable is sufficient.
- For 4-20 mA HART: Shielded cable recommended. Observe grounding concept of the plant.

Pulse/frequency/switch output

Standard installation cable is sufficient.

Status input

Standard installation cable is sufficient.

PROFIBUS DP

The IEC 61158 standard specifies two types of cable (A and B) for the bus line which can be used for every transmission rate. Cable type A is recommended.



For detailed information about the specification of the connecting cable, see the Operating Instructions for the device.

Modbus RS485

The EIA/TIA-485 standard specifies two types of cable (A and B) for the bus line which can be used for every transmission rate. Cable type A is recommended.

 For detailed information about the specification of the connecting cable, see the Operating Instructions for the device.

EtherNet/IP

The standard ANSI/TIA/EIA-568-B.2 Annex specifies CAT 5 as the minimum category for a cable used for EtherNet/IP. CAT 5e and CAT 6 are recommended.

 For more information on planning and installing EtherNet/IP networks, please refer to the "Media Planning and Installation Manual. EtherNet/IP" of ODVA Organization.

Connecting cable for remote version

The remote version is connected via an electrode cable and a coil current cable.

 For detailed information about the specification of the connecting cables, see the Operating Instructions for the device.

Reinforced connecting cables

Reinforced connecting cables with an additional, reinforcing metal braid should be used for:

- When laying the cable directly in the ground
- Where there is a risk of damage from rodents

Operation in zones of severe electrical interference

Grounding is by means of the ground terminal provided for the purpose inside the connection housing. The stripped and twisted lengths of cable shield to the ground terminal must be as short as possible.

Cable diameter

- Cable glands supplied:
 - For standard cable: M20 × 1.5 with cable $\phi 6$ to 12 mm (0.24 to 0.47 in)
 - For reinforced cable: M20 × 1.5 with cable $\phi 9.5$ to 16 mm (0.37 to 0.63 in)
- (Plug-in) spring terminals for wire cross-sections 0.5 to 2.5 mm² (20 to 14 AWG)

7.1.3 Terminal assignment

Transmitter

Supply voltage

Order code for "Power supply"	Terminal numbers	
	1 (L+/L)	2 (L-/N)
Option L (wide range power unit)	AC100 to 240 V	
	AC/DC24 V	

*0-20 mA/4-20 mA HART connection version with additional outputs and inputs**Signal transmission 0-20 mA/4-20 mA HART with additional outputs and inputs*

Order code for "Output" and "Input"	Terminal numbers							
	Output 1		Output 2		Output 3		Input	
	26 (+)	27 (-)	24 (+)	25 (-)	22 (+)	23 (-)	20 (+)	21 (-)
Option H	<ul style="list-style-type: none"> ▪ 4-20 mA HART (active) ▪ 0-20 mA (active) 		Pulse/frequency output (passive)			Switch output (passive)		-
Option I	<ul style="list-style-type: none"> ▪ 4-20 mA HART (active) ▪ 0-20 mA (active) 		Pulse/frequency/switch output (passive)			Pulse/frequency/switch output (passive)		Status input

*PROFIBUS DP connection version**PROFIBUS DP signal transmission*

Order code for "Output" and "Input"	Terminal numbers	
	26 (RxD/TxD-P)	27 (RxD/TxD-N)
Option L	B	A
Order code for "Output": Option L: PROFIBUS DP, for use in non-hazardous areas and Zone 2/div. 2		

*Modbus RS485 connection version**Signal transmission Modbus RS485*

Order code for "Output" and "Input"	Terminal numbers	
	26 (+)	27 (-)
Option M	B	A

*EtherNet/IP connection version**EtherNet/IP signal transmission*

Order code for "Output"	Connection via
Option N	EtherNet/IP connector

Remote version

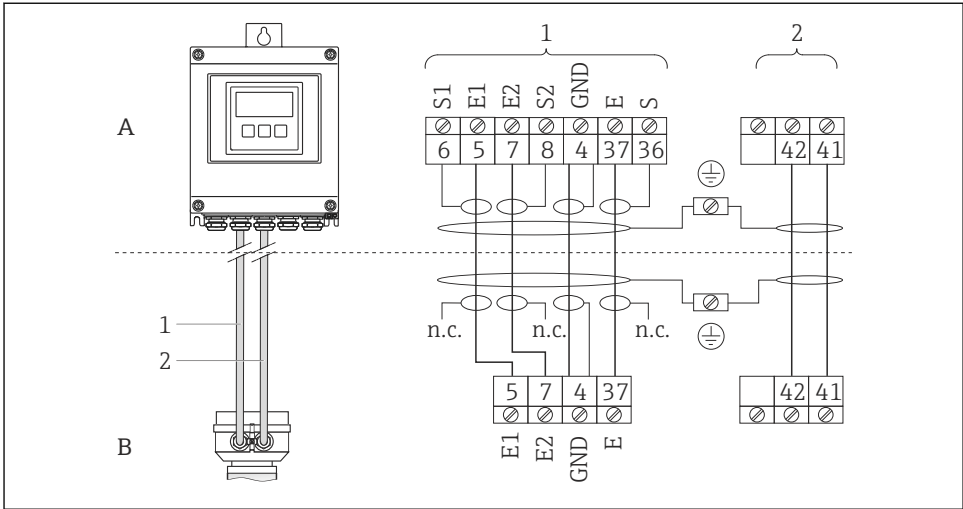

A0020534

4 Remote version terminal assignment

A Transmitter wall-mount housing

B Sensor connection housing

1 Electrode cable

2 Coil current cable

n.c. Not connected, insulated cable shields

Terminal No. and cable colors: 6/5 = brown; 7/8 = white; 4 = green; 36/37 = yellow

7.1.4 Pin assignment, device plug

EtherNet/IP

Device plug for signal transmission (device side)

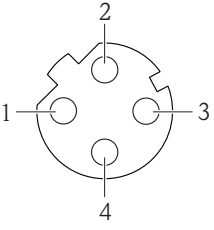
	Pin	Assignment	Coding	Plug/socket
	1	+		
2	+	Rx		
3	-	Tx		
4	-	Rx		

A0016812

7.1.5 Shielding and grounding

Modbus

The shielding and grounding concept requires compliance with the following:

- Electromagnetic compatibility (EMC)
- Explosion protection
- Personal protection equipment
- National installation regulations and guidelines
- Observe cable specification →  19.
- Keep the stripped and twisted lengths of cable shield to the ground terminal as short as possible.
- Seamless cable shielding.

Grounding of the cable shield

To comply with EMC requirements:

- Ensure the cable shield is grounded to the potential matching line at multiple points.
- Connect every local ground terminal to the potential matching line.

NOTICE

In systems without potential matching, the multiple grounding of the cable shield causes mains frequency equalizing currents!

Damage to the bus cable shield.

- ▶ Only ground the bus cable shield to either the local ground or the protective ground at one end.

PROFIBUS DP

Optimum electromagnetic compatibility (EMC) of the fieldbus system can only be guaranteed if the system components and, in particular, the lines are shielded and the shield forms as complete a cover as possible. A shield coverage of 90% is ideal.

- To ensure an optimum EMC protective effect, connect the shield as often as possible to the reference ground.
- For reasons of explosion protection, you should refrain from grounding however.

To comply with both requirements, the fieldbus system allows three different types of shielding:

- Shielding at both ends.
- Shielding at one end on the feed side with capacitance termination at the field device.
- Shielding at one end on the feed side.

Experience shows that the best results with regard to EMC are achieved in most cases in installations with one-sided shielding on the feed side (without capacitance termination at the field device). Appropriate measures with regard to input wiring must be taken to allow unrestricted operation when EMC interference is present. These measures have been taken into account for this device. Operation in the event of disturbance variables as per NAMUR NE21 is thus guaranteed.

Where applicable, national installation regulations and guidelines must be observed during the installation!

Where there are large differences in potential between the individual grounding points, only one point of the shielding is connected directly with the reference ground. In systems without potential equalization, therefore, cable shielding of fieldbus systems should only be grounded on one side, for example at the fieldbus supply unit or at safety barriers.

NOTICE

In systems without potential matching, the multiple grounding of the cable shield causes mains frequency equalizing currents!

Damage to the bus cable shield.

- Only ground the bus cable shield to either the local ground or the protective ground at one end. Insulate the shield that is not connected.

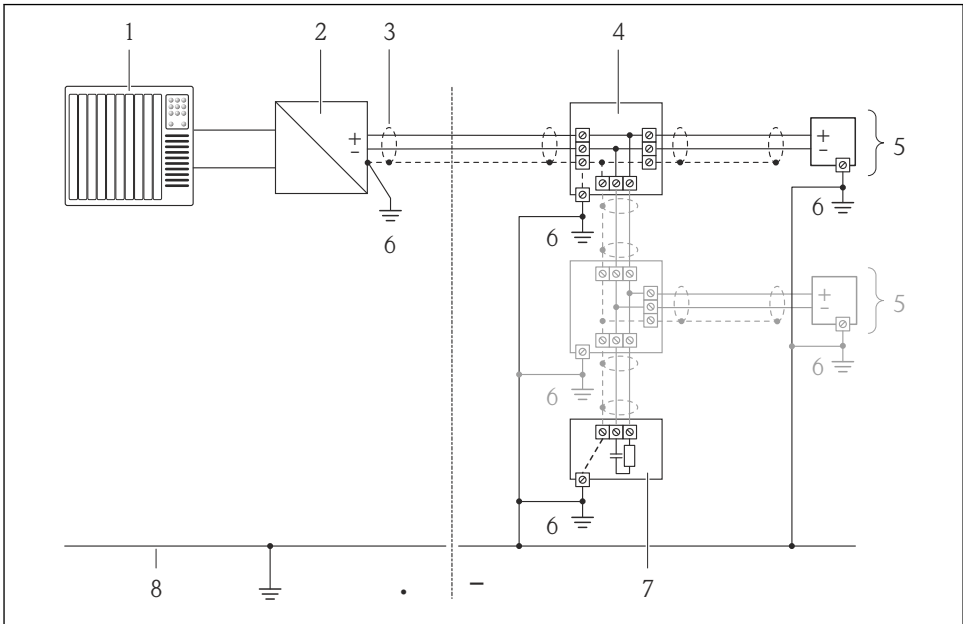

A0019004

- 1 Controller (e.g. PLC)
- 2 Segment coupler PROFIBUS DP/PA
- 3 Cable shield
- 4 T-box
- 5 Measuring device
- 6 Local grounding
- 7 Bus terminator
- 8 Potential matching line

7.1.6 Requirements for the supply unit

Supply voltage

Transmitter

Order code for "Power supply"	Terminal voltage	Frequency range
Option L	AC100 to 240 V	50/ 60 Hz, ± 4 Hz
	AC/DC24 V	50/ 60 Hz, ± 4 Hz

7.1.7 Preparing the measuring device

1. Remove dummy plug if present.
2. If measuring device is delivered with cable glands:
Observe cable specification →  19.

7.1.8 Preparing the connecting cable for the remote version

When terminating the connecting cable, pay attention to the following points:

- In the case of electrode cables, make sure that the ferrules do not touch the core shields on the sensor side. Minimum distance = 1 mm (exception: green "GND" cable)
- In the case of coil current cables, insulate one core of the three-core wire at the level of the core reinforcement. You only require two cores for the connection.
- Fit the fine-wire cores with ferrules.

Transmitter

Electrode cable	Coil current cable
<p style="text-align: center;">A</p> <p style="text-align: center;">B</p> <p style="text-align: center;">GND</p> <p>5 Engineering unit mm (in)</p> <p style="text-align: right;">A0021324</p>	<p style="text-align: center;">A</p> <p style="text-align: center;">B</p> <p>6 Engineering unit mm (in)</p> <p style="text-align: right;">A0021325</p>
<p>A = Termination of the cables B = Termination of the fine-wire cores with ferrules 1 = Red ferrules, ϕ1.0 mm (0.04 in) 2 = White ferrules, ϕ0.5 mm (0.02 in) * = Stripping only for reinforced cables</p>	

Sensor

Electrode cable	Coil current cable
<p>A</p> <p>B</p> <p>1 2 2 2 1</p> <p>GND</p> <p>$\geq 1 (0.04)$</p> <p>A0016488</p>	<p>A</p> <p>B</p> <p>1 1 1</p> <p>A0016489</p>
<p>A = Termination of the cables B = Termination of the fine-wire cores with ferrules 1 = Red ferrules, $\phi 1.0$ mm (0.04 in) 2 = White ferrules, $\phi 0.5$ mm (0.02 in) * = Stripping only for reinforced cables</p>	

7.2 Connecting the measuring device

⚠ WARNING

Risk of electric shock! Components carry dangerous voltages!

- ▶ Have electrical connection work carried out by correspondingly trained specialists only.
- ▶ Observe applicable federal/national installation codes and regulations.
- ▶ Comply with local workplace safety regulations.
- ▶ Observe grounding concept of the plant.
- ▶ Never mount or wire the measuring device while it is connected to the supply voltage.
- ▶ Before the supply voltage is applied, connect the protective ground to the measuring device.

7.2.1 Connecting the remote version

⚠ WARNING

Risk of damaging the electronic components!

- ▶ Ground the remote version: connect the sensor and transmitter to the same potential equalization.
- ▶ Only connect the sensor to a transmitter with the same serial number.
- ▶ Ground the connection housing of the sensor via the external screw terminal.

The following procedure (in the action sequence given) is recommended for the remote version:

1. Mount the sensor and transmitter.
2. Connect the connecting cable.
3. Connect the transmitter.

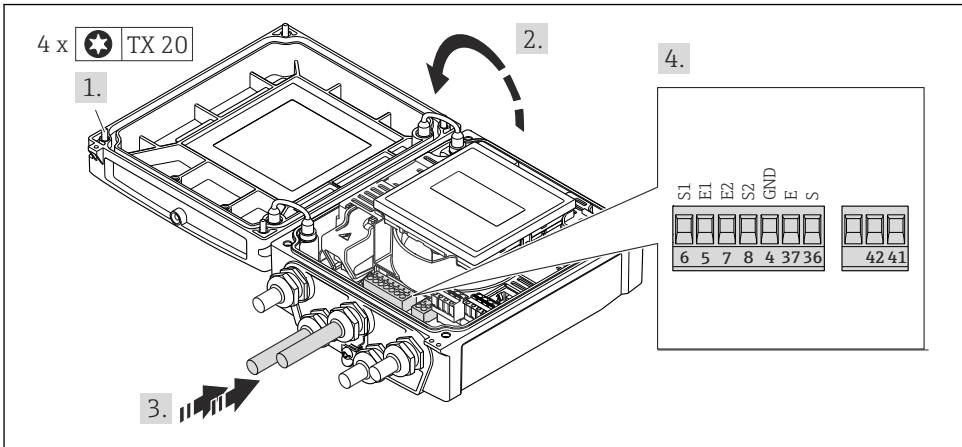

A0017445

- 7 Transmitter: main electronics module with terminals

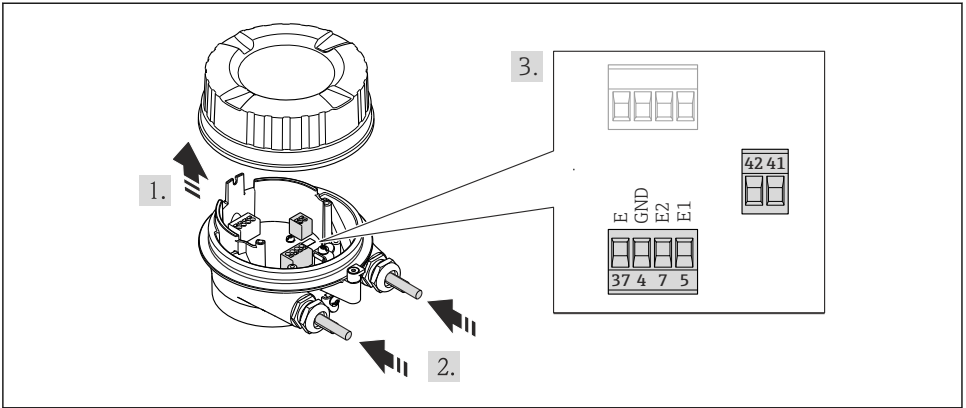

A0021527

8 Sensor: connection module

7.2.2 Connecting the transmitter

⚠ WARNING

Housing degree of protection may be voided due to insufficient sealing of the housing.

- ▶ Screw in the screw without using any lubricant. The threads on the cover are coated with a dry lubricant.

Tightening torques for plastic housing

Housing cover fixing screw	1.3 Nm
Cable entry	4.5 to 5 Nm
Ground terminal	2.5 Nm

Supply voltage connection, 0-20 mA/4-20 mA HART and additional outputs/inputs

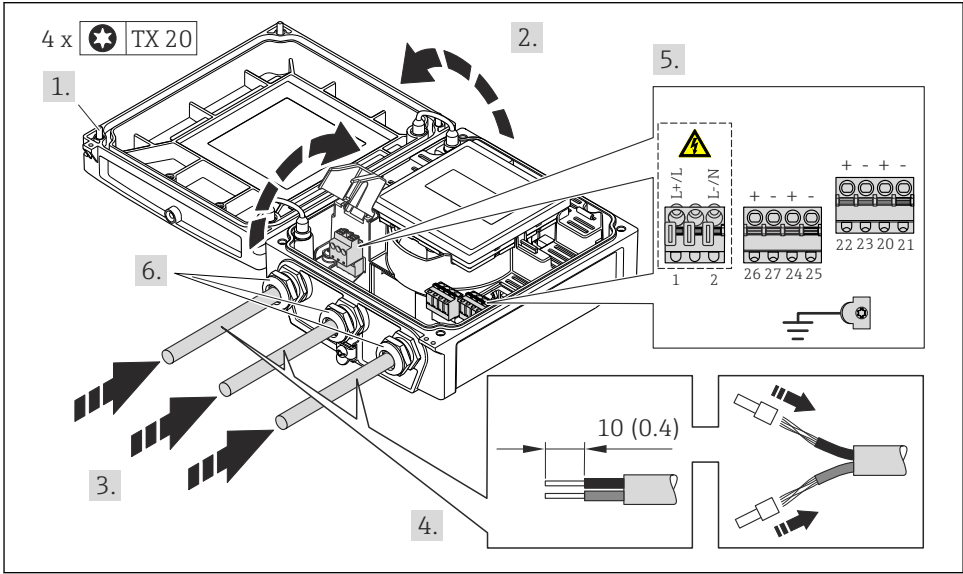

- Connect the cable in accordance with the terminal assignment → 20. For supply voltage: open the shock protection cover.

i For HART communication: when connecting the cable shielding to the ground terminal, observe the grounding concept of the facility.

Connecting the supply voltage and PROFIBUS DP

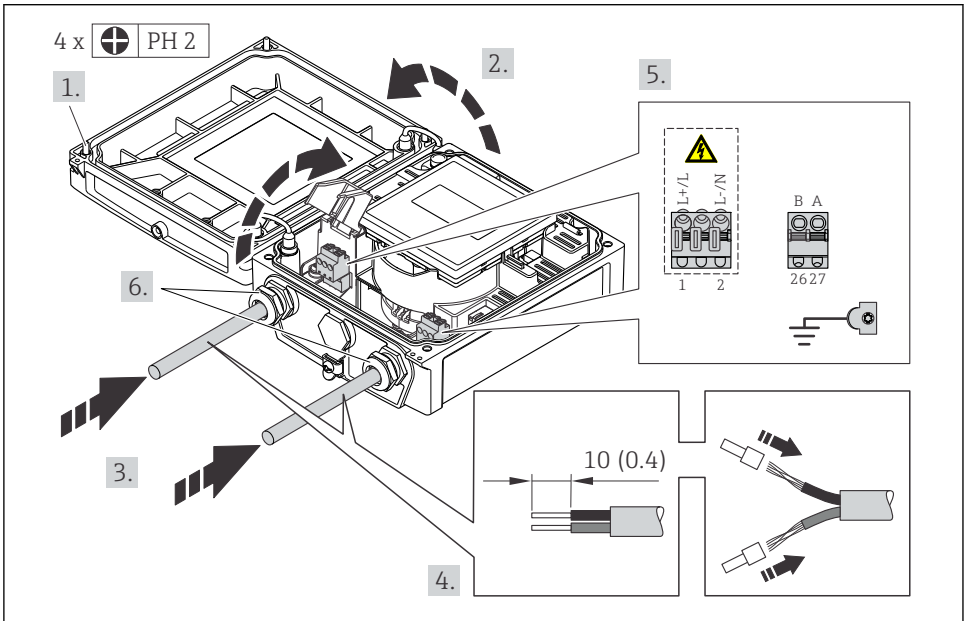

A0023164

- Connect the cable in accordance with the terminal assignment → 20. For supply voltage: open the shock protection cover.

Connecting the supply voltage and Modbus RS485

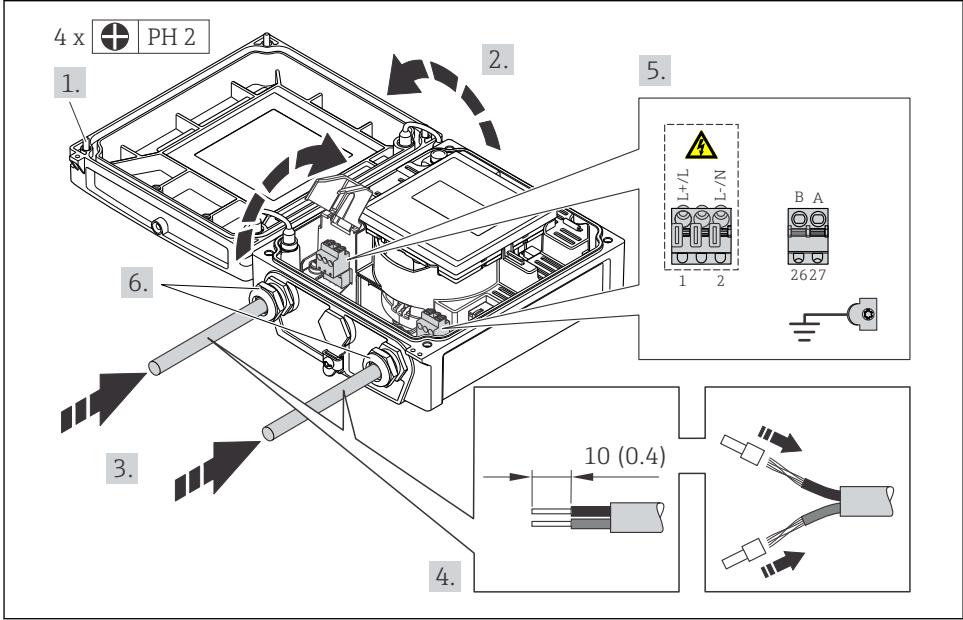

A0024218

- ▶ Connect the cable in accordance with the terminal assignment → 20. For supply voltage: open the shock protection cover.

Connecting the supply voltage and EtherNet/IP

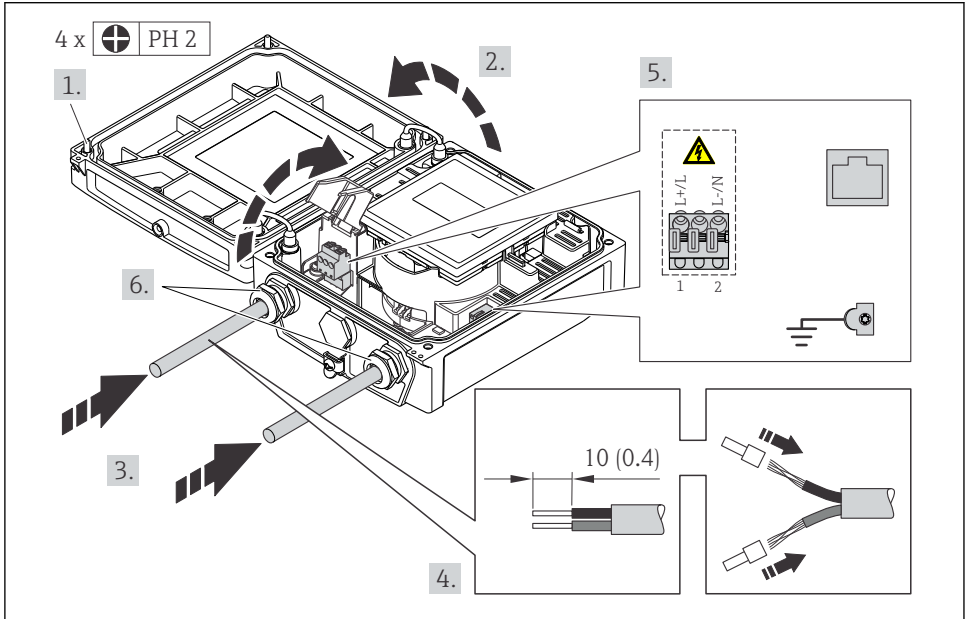

A0021356

- ▶ Connect the cable in accordance with the terminal assignment → 20. For supply voltage: open the shock protection cover.

7.2.3 Ensuring potential equalization

Requirements

CAUTION

Electrode damage can result in the complete failure of the device!

- ▶ Same electrical potential for the fluid and sensor
- ▶ Remote version: same electrical potential for the sensor and transmitter
- ▶ Company-internal grounding concepts
- ▶ Pipe material and grounding

Connection examples for standard situations

Metal, grounded pipe

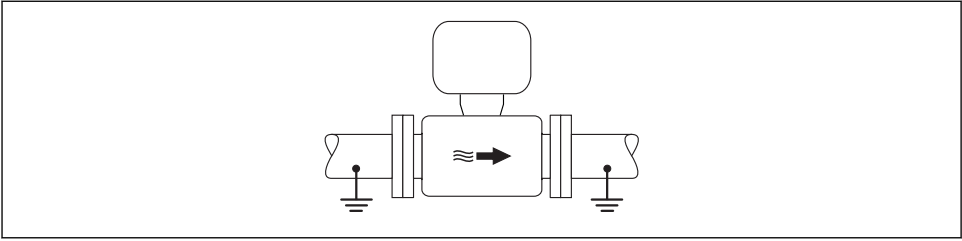

A0016315

9 Potential equalization via measuring tube

Connection example in special situations



For detailed information on special cases, see the Operating Instructions for the device.

- Unlined and ungrounded metal pipe
- Plastic pipe or pipe with insulating liner
- Pipe with a cathodic protection unit

7.3 Hardware settings

7.3.1 Setting the device address

EtherNet/IP

The IP address of the measuring device can be configured for the network via DIP switches.

Addressing data

IP address and configuration options			
1st octet	2nd octet	3rd octet	4th octet
192.	168.	1.	XXX
	↓		↓
	Can only be configured via software addressing		Can be configured via software addressing and hardware addressing

IP address range	1 to 254 (4th octet)
IP address broadcast	255

Addressing mode ex works	Software addressing; all DIP switches for hardware addressing are set to OFF.
IP address ex works	DHCP server active



For device addressing via software

Setting the address

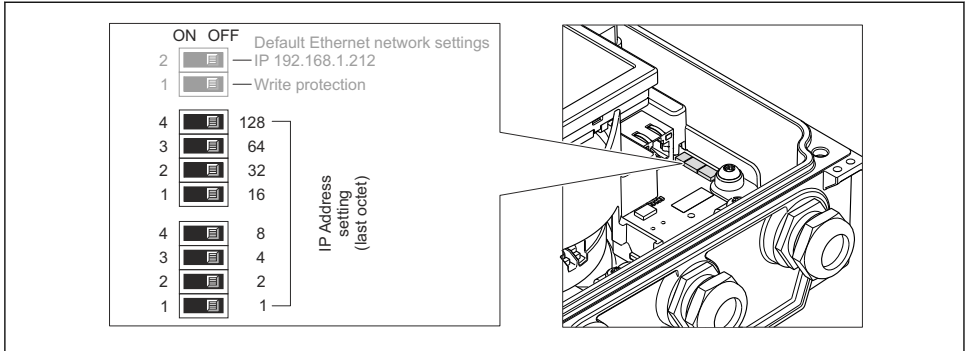

A0021322

- ▶ Set the desired IP address using the corresponding DIP switches on the I/O electronics module.
 - ↳ Hardware addressing with the configured IP address is enabled after 10 s.

PROFIBUS DP

The address must always be configured for a PROFIBUS DP/PA device. The valid address range is between 1 and 126. In a PROFIBUS DP/PA network, each address can only be assigned once. If an address is not configured correctly, the device is not recognized by the master. All measuring devices are delivered from the factory with the device address 126 and with the software addressing method.

Setting the address

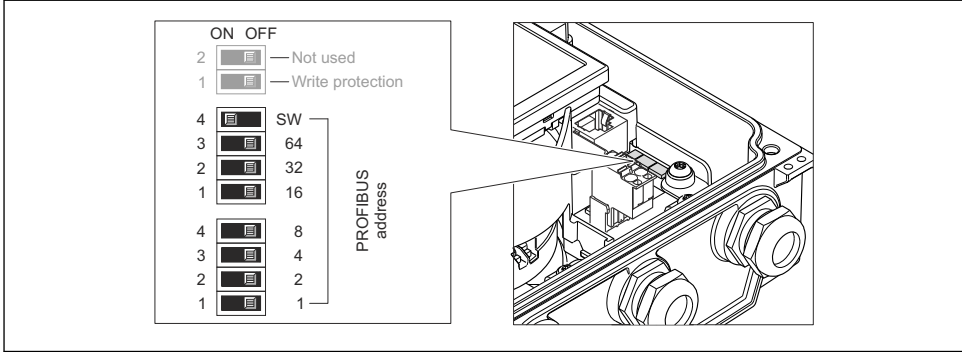

A0023061

10 Addressing using DIP switches on the I/O electronics module

1. Disable software addressing (OFF) via the top DIP switch 4 (SW).
2. Set the desired device address via the corresponding DIP switches.

↳ Example → 10, 36: $1 + 16 + 32 = \text{device address } 49$

The device demands rebooting after 10 s. After rebooting, hardware addressing is enabled with the configured IP address.

7.3.2 Enabling the terminating resistor

PROFIBUS DP

To avoid incorrect communication transmission caused by impedance mismatch, terminate the PROFIBUS DP cable correctly at the start and end of the bus segment.

- If the device is operated with a baud rate of 1.5 MBaud and under:
For the last transmitter on the bus, terminate via DIP switch 2 (bus termination) and DIP switch 1 and 3 (bus polarization). Setting: ON – ON – ON → 11, 37.
- For baud rates > 1.5 MBaud:
Due to the capacitance load of the user and the line reflections generated as a result, ensure that an external bus terminator is used.

i It is generally advisable to use an external bus terminator as the entire segment can fail if a device that is terminated internally is defective.

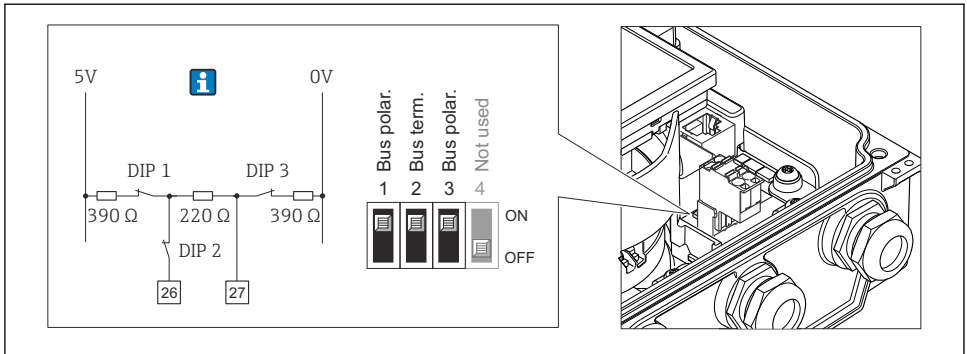

A0023063

11 Termination using DIP switches on the I/O electronics module (for baud rates < 1.5 Mbaud)

Modbus RS485

To avoid incorrect communication transmission caused by impedance mismatch, terminate the Modbus RS485 cable correctly at the start and end of the bus segment.

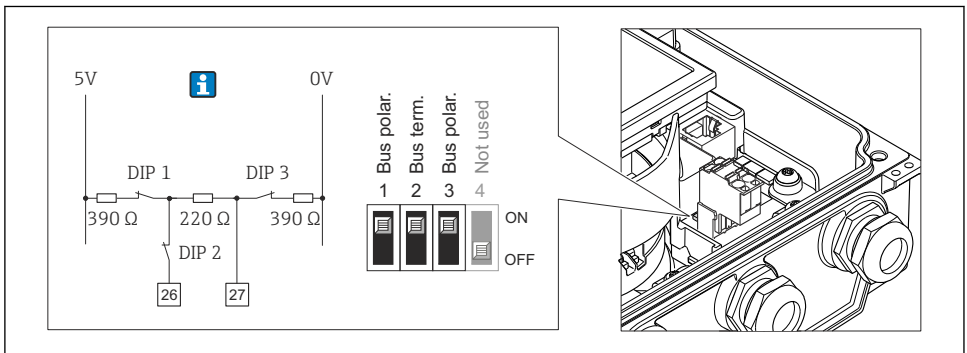

A0023063

12 Terminating resistor can be enabled via DIP switch on the main electronics module

7.4 Ensuring the degree of protection

7.4.1 Degree of protection IP66/67, Type 4X enclosure

The measuring device fulfills all the requirements for the IP66/67 degree of protection, Type 4X enclosure.

To guarantee IP66/67 degree of protection, Type 4X enclosure, carry out the following steps after the electrical connection:

1. Check that the housing seals are clean and fitted correctly. Dry, clean or replace the seals if necessary.

2. Tighten all housing screws and screw covers.
3. Firmly tighten the cable glands.
4. To ensure that moisture does not enter the cable entry, route the cable so that it loops down before the cable entry ("water trap").

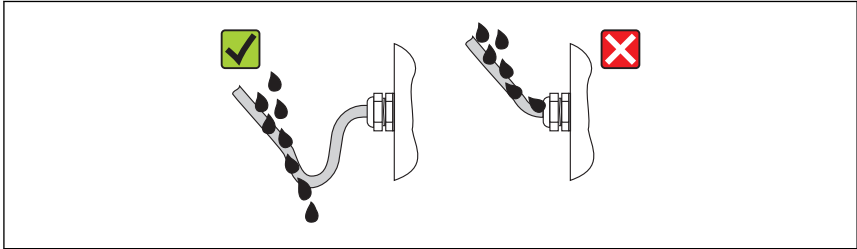

A0013960

5. Insert dummy plugs into unused cable entries.

7.5 Post-connection check

Are cables or the device undamaged (visual inspection)?	<input type="checkbox"/>
Do the cables comply with the requirements → 19?	<input type="checkbox"/>
Do the cables have adequate strain relief?	<input type="checkbox"/>
Are all the cable glands installed, firmly tightened and leak-tight? Cable run with "water trap" → 37 ?	<input type="checkbox"/>
Only for remote version: is the sensor connected to the right transmitter? Check the serial number on the nameplate of the sensor and transmitter.	<input type="checkbox"/>
Does the supply voltage match the specifications on the transmitter nameplate ?	<input type="checkbox"/>
Is the terminal assignment correct ?	<input type="checkbox"/>
If supply voltage is present, do values appear on the display module?	<input type="checkbox"/>
Is the potential equalization established correctly → 33?	<input type="checkbox"/>
Are all housing covers installed and the screws tightened with the correct tightening torque?	<input type="checkbox"/>

8 Operation options

8.1 Structure and function of the operating menu

8.1.1 Structure of the operating menu

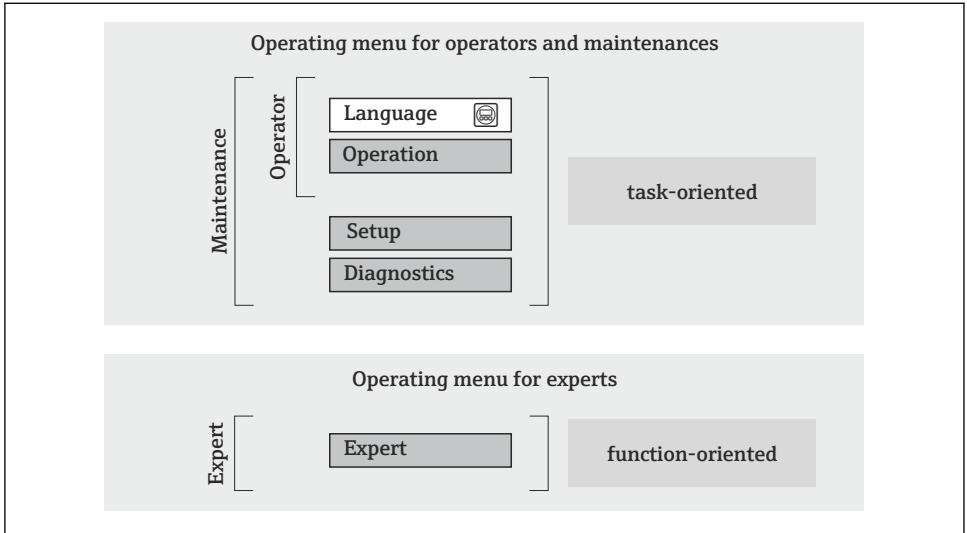

 13 Schematic structure of the operating menu

8.1.2 Operating philosophy

The individual parts of the operating menu are assigned to certain user roles (operator, maintenance etc.). Each user role contains typical tasks within the device lifecycle.



For detailed information on the operating philosophy, see the Operating Instructions for the device.

8.2 Access to the operating menu via the local display

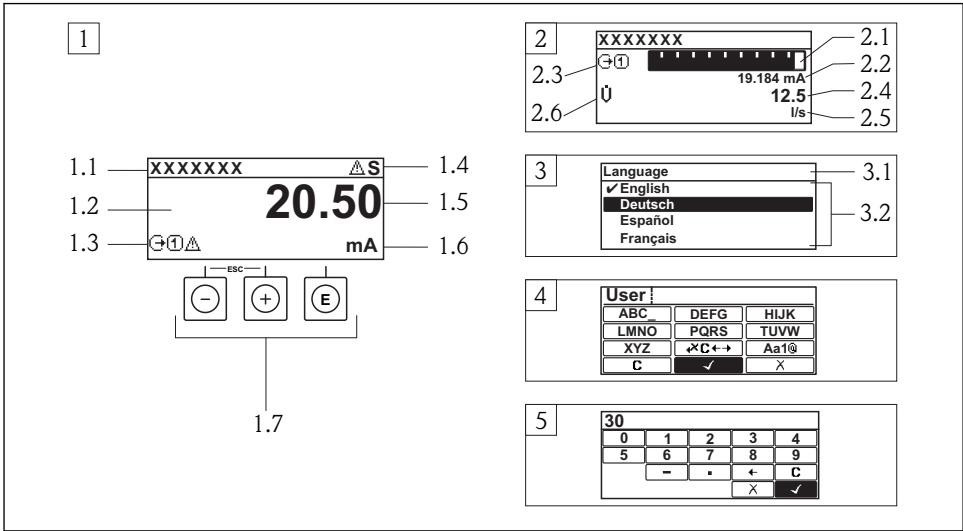





A0014013

- 1 Operational display with measured value shown as "1 value, max." (example)
 - 1.1 Device tag
 - 1.2 Display area for measured values (4-line)
 - 1.3 Explanatory symbols for measured value: Measured value type, measuring channel number, symbol for diagnostic behavior
 - 1.4 Status area
 - 1.5 Measured value
 - 1.6 Unit for the measured value
 - 1.7 Operating elements
- 2 Operational display with measured value shown as "1 bar graph + 1 value" (example)
 - 2.1 Bar graph display for measured value 1
 - 2.2 Measured value 1 with unit
 - 2.3 Explanatory symbols for measured value 1: measured value type, measuring channel number
 - 2.4 Measured value 2
 - 2.5 Unit for measured value 2
 - 2.6 Explanatory symbols for measured value 2: measured value type, measuring channel number
- 3 Navigation view: picklist of a parameter
 - 3.1 Navigation path and status area
 - 3.2 Display area for navigation: ✓ designates the current parameter value
- 4 Editing view: text editor with input mask
- 5 Editing view: numeric editor with input mask











8.2.1 Operational display

Status area

The following symbols appear in the status area of the operational display at the top right:

- Status signals
 - **F**: Failure
 - **C**: Function check
 - **S**: Out of specification
 - **M**: Maintenance required
- Diagnostic behavior
 - : Alarm
 - : Warning
- : Locking (the device is locked via the hardware)
- : Communication (communication via remote operation is active)

Display area

- Measured variables (depending on the device version), e.g.:
 - : Volume flow
 - : Mass flow
 - : Density
 - **G**: Conductivity
 - : Temperature
- : Totalizer (the measurement channel number indicates which totalizer is displayed)
- : Output (the measurement channel number indicates which output is displayed)
- : Input
-  ... : Measurement channel number (if more than one channel is present for the same measured variable type)
- Diagnostic behavior (for a diagnostic event that concerns the displayed measured variable)
 - : Alarm
 - : Warning









8.2.2 Navigation view

Status area

The following appears in the status area of the navigation view in the top right corner:

- Of the submenu
 - The direct access code for the parameter you are navigating to (e.g. 0022-1)
 - If a diagnostic event is present, the diagnostic behavior and status signal
- In the wizard
 - If a diagnostic event is present, the diagnostic behavior and status signal







Display area

- Icons for menus
 - : Operation
 - : Setup
 - : Diagnostics
 - : Expert
- : Submenus
- : Wizards
- : Parameters within a wizard
- : Parameter locked





8.2.3 Editing view

Input mask



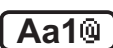

Operating symbols in the numeric editor

Key	Meaning	Key	Meaning
	Confirms selection.		Moves the input position one position to the left.
	Exits the input without applying the changes.		Inserts decimal separator at the input position.
	Inserts minus sign at the input position.		Clears all entered characters.













Operating symbols in the text editor

Key	Meaning	Key	Meaning
	Confirms selection.		Switches to the selection of the correction tools.
	Exits the input without applying the changes.		Clears all entered characters.
	Toggle <ul style="list-style-type: none"> ■ Between upper-case and lower-case letters ■ For entering numbers ■ For entering special characters 		

Correction symbols under

Key	Meaning	Key	Meaning
	Clears all entered characters.		Moves the input position one position to the left.
	Moves the input position one position to the right.		Deletes one character immediately to the left of the input position.

8.2.4 Operating elements

Keys and meaning
<p> Minus key</p> <ul style="list-style-type: none"> ▪ <i>In a menu, submenu:</i> Moves the selection bar upwards in a choose list. ▪ <i>With a wizard:</i> Confirms the parameter value and goes to the previous parameter. ▪ <i>With a text and numeric editor:</i> Moves the selection bar to the left (backwards) in an input screen.
<p> Plus key</p> <ul style="list-style-type: none"> ▪ <i>In a menu, submenu:</i> Moves the selection bar downwards in a choose list. ▪ <i>With a wizard:</i> Confirms the parameter value and goes to the next parameter. ▪ <i>With a text and numeric editor:</i> Moves the selection bar to the right (forwards) in an input screen.
<p> Enter key</p> <p><i>For operational display</i></p> <ul style="list-style-type: none"> ▪ Pressing the key briefly opens the operating menu. ▪ Pressing the key for 2 s opens the context menu. <p><i>In a menu, submenu</i></p> <ul style="list-style-type: none"> ▪ Pressing the key briefly: <ul style="list-style-type: none"> - Opens the selected menu, submenu or parameter. - Starts the wizard. - If help text is open, closes the help text of the parameter. ▪ Pressing the key for 2 s for parameter: If present, opens the help text for the function of the parameter. <p><i>With a wizard:</i> Opens the editing view of the parameter.</p> <p><i>With a text and numeric editor:</i></p> <ul style="list-style-type: none"> ▪ Pressing the key briefly: <ul style="list-style-type: none"> - Opens the selected group. - Carries out the selected action. ▪ Pressing the key for 2 s confirms the edited parameter value.
<p>+ Escape key combination (press keys simultaneously)</p> <p><i>In a menu, submenu</i></p> <ul style="list-style-type: none"> ▪ Pressing the key briefly: <ul style="list-style-type: none"> - Exits the current menu level and takes you to the next higher level. - If help text is open, closes the help text of the parameter. ▪ Pressing the key for 2 s for the parameter: Returns you to the operational display ("home position"). <p><i>With a wizard:</i> Exits the wizard and takes you to the next higher level.</p> <p><i>With a text and numeric editor:</i> Closes the text or numeric editor without applying changes.</p>
<p>+ Minus/Enter key combination (press the keys simultaneously)</p> <p>Reduces the contrast (brighter setting).</p>
<p>+ Plus/Enter key combination (press and hold down the keys simultaneously)</p> <p>Increases the contrast (darker setting).</p>
<p>++ Minus/Plus/Enter key combination (press the keys simultaneously)</p> <p><i>For operational display:</i> Enables or disables the keypad lock (only SD02 display module).</p>

8.2.5 Further information



For further information on the following topics, see the Operating Instructions for the device

- Calling up help text
- User roles and related access authorization
- Disabling write protection via access code
- Enabling and disabling the keypad lock

8.3 Access to the operating menu via the Web browser

8.3.1 Function range

Thanks to the integrated Web server the device can be operated and configured via a Web browser. The operating menu structure is the same as in the local display.

8.3.2 Prerequisites

Computer hardware

Interface	The computer must have an RJ45 interface.
Connecting cable	Standard Ethernet cable with RJ45 connector.
Screen	Recommended size: $\geq 12"$ (depends on the screen resolution) Web server operation is not optimized for touch screens!

Computer software

Recommended operating systems	Microsoft Windows 7 or higher. Microsoft Windows XP is supported.
Web browsers supported	<ul style="list-style-type: none"> ■ Microsoft Internet Explorer 8 or higher ■ Mozilla Firefox ■ Google chrome

Computer settings

User rights	User rights are required for TCP/IP and proxy server settings (for changes to the IP address, subnet mask etc.).
Proxy server settings of the Web browser	The Web browser setting <i>Use proxy server for LAN</i> must be disabled .
JavaScript	JavaScript must be enabled. If JavaScript cannot be enabled: enter <code>http://192.168.1.212/basic.html</code> in the address line of the Web browser. A fully functional but simplified version of the operating menu structure starts in the Web browser.

Measuring device

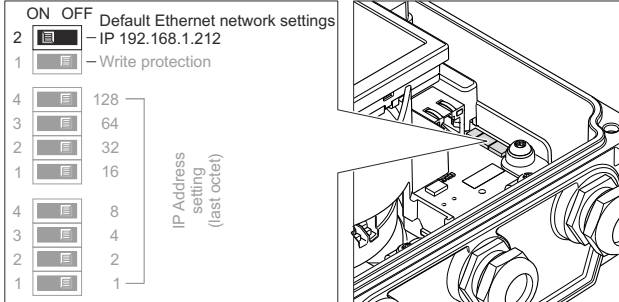
Web server	Web server must be enabled; factory setting: ON
IP address	<p>If the IP address of the device is not known:</p> <ul style="list-style-type: none"> ▪ The IP address can be read out via local operation: Diagnostics → Device information → IP address ▪ Communication with the Web server can be established via the standard IP address 192.168.1.212. <p>The DHCP function is enabled in the device at the factory, i.e. the device expects an IP address to be assigned by the network. This function can be disabled and the device can be set to the standard IP address 192.168.1.212: set top DIP switch No. 2 from OFF → ON.</p> <div style="display: flex; align-items: center;"> <div style="border: 1px solid black; padding: 5px; margin-right: 10px;"> <p>ON OFF Default Ethernet network settings</p> <p>2 <input checked="" type="checkbox"/> - IP 192.168.1.212</p> <p>1 <input type="checkbox"/> - Write protection</p> <p>4 <input type="checkbox"/> 128</p> <p>3 <input type="checkbox"/> 64</p> <p>2 <input type="checkbox"/> 32</p> <p>1 <input type="checkbox"/> 16</p> <p>4 <input type="checkbox"/> 8</p> <p>3 <input type="checkbox"/> 4</p> <p>2 <input type="checkbox"/> 2</p> <p>1 <input type="checkbox"/> 1</p> <p style="text-align: right; margin-right: 5px;">IP Address setting (last octet)</p> </div>  </div> <p style="text-align: right; font-size: small;">A0023353</p> <ul style="list-style-type: none"> ▪ Once the DIP switch has been activated, the device must be restarted before the device uses the standard IP address. ▪ If the standard IP address (top DIP switch No. 2 = ON) is used, there is no connection to the EtherNet/IP network.

8.3.3 Establishing a connection

Configuring the Internet protocol of the computer

IP address	192.168.1.XXX; for XXX all numerical values except: 0, 212 and 255 → e.g. 192.168.1.213
Subnet mask	255.255.255.0
Default gateway	192.168.1.212 or leave cells empty

1. Switch on the measuring device and connect to the computer via the cable .
2. If a 2nd network card is not used: all the applications on the notebook should be closed, or all the applications that require the Internet or network, such as e-mail, SAP applications, Internet or Windows Explorer, i.e. close all open Internet browsers.
3. Configure the properties of the Internet protocol (TCP/IP) as defined in the table above.

Starting the Web browser

1. Enter the IP address of the Web server in the address line of the Web browser:
192.168.1.212
2. If the IP address of the measuring device is known, enter the defined device address in the address line of the Web browser. If it is unknown, read the IP address via local operation (Diagnostics → Device information → IP address) or set the upper DIP switch No. 2 to ON, restart the device and enter the standard IP address 192.168.1.212 →  45.

The login page appears.

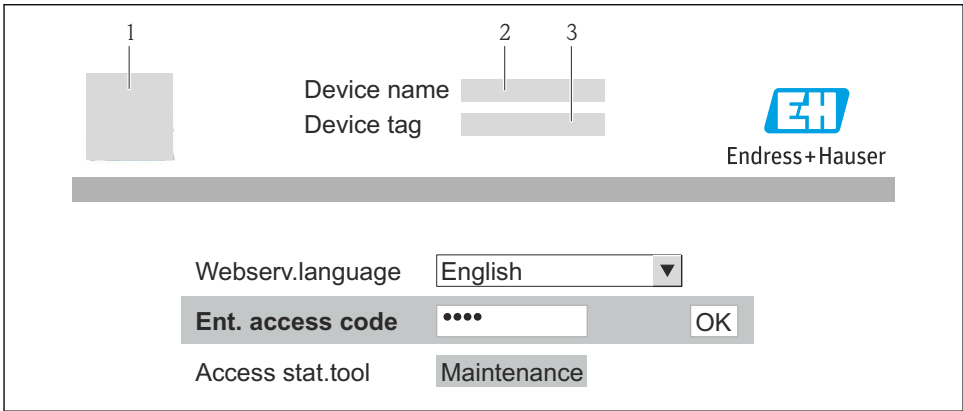

A0017362

- 1 *Device tag*
- 2 *Picture of device*

8.3.4 Logging on

Access code	0000 (factory setting); can be changed by customer
--------------------	--

8.3.5 User interface

1 Picture of device
 2 Function row with 6 functions
 3 Device tag
 4 Header
 5 Working area
 6 Navigation area

A0017757-EN

Header

The following information appears in the header:

- Device tag
- Device status with status signal
- Current measured values

Function row

Functions	Meaning
Measured values	The measured values of the device are displayed
Menu	Access to the operating menu structure of the device, same as for the local display and operating tool
Device status	Displays the diagnostic messages currently pending, listed in order of priority
Data management	<ul style="list-style-type: none"> ■ Data exchange between PC and measuring device: <ul style="list-style-type: none"> - Upload the configuration from the device (XML format, create configuration back-up) - Save the configuration to the device (XML format, restore configuration) - Export the event list (.csv file) - Export parameter settings (.csv file, create documentation of the measuring point configuration) - Export the Heartbeat verification log (PDF file, only available with the "Heartbeat Verification" application package) ■ Upload the device driver for system integration from the device
Network configuration	Configuration and checking of all the parameters required for establishing the connection to the device: <ul style="list-style-type: none"> ■ Network settings (e.g. IP address, MAC address) ■ Device information (e.g. serial number, firmware version)
Logout	End the operation and call up the login page

8.4 Access to the operating menu via the operating tool



For detailed information about access to the operating menu via operating tool, refer to the Operating Instructions for the device .

9 System integration



For detailed information on system integration, see the Operating Instructions for the device.

9.1 Cyclic data transfer PROFIBUS DP

9.1.1 Cyclic data transmission

Cyclic data transmission when using the device master file (GSD).

Block model

The block model shows which input and output data the measuring device makes available for cyclic data exchange. Cyclic data exchange takes place with a PROFIBUS master (Class 1), e.g. a control system etc.

Measuring device				Control system
Transducer Block	Analog Input block 1 to 4 → 📄 49	Output value AI	→	PROFIBUS DP
		Output value TOTAL	→	
	Totalizer block 1 to 3 → 📄 49	Controller SETTOT	←	
		Configuration MODETOT	←	
	Analog Output block 1 → 📄 51	Input values AO	←	
	Discrete Input block 1 to 2 → 📄 51	Output values DI	→	
Discrete Output block 1 to 2 → 📄 51	Input values DO	←		

Defined order of modules

The modules are permanently assigned to the slots, i.e. when configuring the modules, the order and the arrangement of the modules must be respected.

Slot	Module	Function block
1...4	AI	Analog Input block 1 to 4
5	TOTAL or SETTOT_TOTAL or SETOT_MODETOT_TOTAL	Totalizer block 1
6		Totalizer block 2
7		Totalizer block 3
8	AO	Analog Output block 1

Slot	Module	Function block
9...10	DI	Discrete Input block 1 to 2
11...12	DO	Discrete Output block 1 to 2

To optimize the data throughput rate of the PROFIBUS network, it is advisable to only configure modules that are processed in the PROFIBUS master system. Any resulting gaps between the configured modules must be assigned to the `EMPTY_MODULE`.

Description of the modules



The data structure is described from the perspective of the PROFIBUS master:

- Input data: Are sent from the measuring device to the PROFIBUS master.
- Output data: Are sent from the PROFIBUS master to the measuring device.

AI module (Analog Input)

Transmit an input variable from the measuring device to the PROFIBUS master (Class 1).

Selection: input variable

The input variable can be specified using the `CHANNEL` parameter.

CHANNEL	Input variable	CHANNEL	Input variable
33122	Volume flow	1132	Conductivity
32961	Mass flow	1042	Electronic temperature
708	Flow velocity		

Factory setting

Function block	Factory setting	Function block	Factory setting
AI 1	Volume flow	AI 3	Electronic temperature
AI 2	Mass flow	AI 4	Flow velocity

TOTAL module

Transmit a totalizer value from the measuring device to the PROFIBUS master (Class 1).

Selection: totalizer value

The totalizer value can be specified using the `CHANNEL` parameter.

CHANNEL	Input variable
33122	Volume flow
32961	Mass flow

Factory setting

Function block	Factory setting: TOTAL
Totalizer 1, 2 and 3	Volume flow

SETTOT_TOTAL module

The module combination consists of the SETTOT and TOTAL functions:

- SETTOT: Control the totalizers via the PROFIBUS master.
- TOTAL: Transmit the totalizer value including the status to PROFIBUS master.

Selection: control totalizer

CHANNEL	Value SETTOT	Control totalizer
33310	0	Totalize
33046	1	Resetting
33308	2	Adopt totalizer initial setting

Factory setting

Function block	Factory setting: Value SETTOT (meaning)
Totalizer 1, 2 and 3	0 (totalizing)

SETTOT_MODETOT_TOTAL module

The module combination consists of the SETTOT, MODETOT and TOTAL functions:

- SETTOT: Control the totalizers via the PROFIBUS master.
- MODETOT: Configure the totalizers via the PROFIBUS master.
- TOTAL: Transmit the totalizer value including the status to PROFIBUS master.

Selection: totalizer configuration

CHANNEL	MODETOT value	Totalizer configuration
33306	0	Balancing
33028	1	Balance the positive flow
32976	2	Balance the negative flow
32928	3	Stop totalizing

Factory setting

Function block	Factory setting: Value MODETOT (meaning)
Totalizer 1, 2 and 3	0 (balancing)

AO module (Analog Output)

Transmit a compensation value from the PROFIBUS master (Class 1) to the measuring device.

Assigned compensation values

A compensation value is permanently assigned to the individual Analog Output blocks.

CHANNEL	Function block	Compensation value
731	AO 1	External density



The selection is made via: Expert → Sensor → External compensation

DI module (Discrete Input)

Transmit discrete input values from the measuring device to the PROFIBUS master (Class 1).

Selection: device function

The device function can be specified using the CHANNEL parameter.

CHANNEL	Device function	Factory setting: state (meaning)
894	Empty pipe detection	<ul style="list-style-type: none"> ▪ 0 (device function not active) ▪ 1 (device function active)
895	Low flow cut off	
1430	Status verification ¹⁾	

1) Only available with the "Heartbeat Verification" application package

Factory setting

Function block	Factory setting	Function block	Factory setting
DI 1	Empty pipe detection	DI 2	Low flow cut off

DO module (Discrete Output)

Transmit discrete output values from the PROFIBUS master (Class 1) to the measuring device.

Assigned device functions

A device function is permanently assigned to the individual Discrete Output blocks.

CHANNEL	Function block	Device function	Values: control (meaning)
891	DO 1	Flow override	<ul style="list-style-type: none"> ▪ 0 (disable device function) ▪ 1 (enable device function)
1429	DO 2	Start verification ¹⁾	

1) Only available with the "Heartbeat Verification" application package

EMPTY_MODULE module

This module is used to assign empty spaces arising from modules not being used in the slots
→  48.



9.2 Cyclic data processing EtherNet/IP

9.2.1 Cyclic data transmission

Cyclic data transmission when using the device master file (GSD).

Block model

The block model shows which input and output data the measuring device makes available for implicit messaging. Cyclical data exchange is performed using an EtherNet/IP scanner, e.g. a distributed control system etc.

Measuring device				Control system
Transducer Block	Input Assembly Fix (Assem100) 44 Byte	→  54	Permanently assigned input group	→
	Output Assembly Fix (Assem102) 64 Byte	→  55	Permanently assigned output group	←
	Input Assembly Fix (Assem101) 88 Byte	→  54	Configurable input group	→
				EtherNet/IP

Input and output groups

Possible configurations

Configuration 1: Exclusive Owner Multicast

Input Assembly Fix		Instance	Size [byte]	Min. RPI (ms)
Input Assembly Configurable	Configuration	0 x 64	398	-
Output Assembly Fix	O → T Configuration	0 x 66	64	5
Input Assembly Fix	T → O Configuration	0 x 64	44	5

Configuration 2: Input Only Multicast

Input Assembly Fix		Instance	Size [byte]	Min. RPI (ms)
Input Assembly Configurable	Configuration	0 x 68	398	-
Output Assembly Fix	O → T Configuration	0 x C7	-	-
Input Assembly Fix	T → O Configuration	0 x 64	44	5

Configuration 3: Exclusive Owner Multicast

Input Assembly Configurable		Instance	Size [byte]	Min. RPI (ms)
Input Assembly Configurable	Configuration	0 x 68	398	–
Output Assembly Fix	O → T Configuration	0 x 66	64	5
Input Assembly Fix	T → O Configuration	0 x 65	88	5

Configuration 4: Input Only Multicast

Input Assembly Configurable		Instance	Size [byte]	Min. RPI (ms)
Input Assembly Configurable	Configuration	0 x 68	398	–
Output Assembly Fix	O → T Configuration	0 x C7	–	–
Input Assembly Fix	T → O Configuration	0 x 64	88	5

Configuration 5: Exclusive Owner Multicast

Input Assembly Fix		Instance	Size [byte]	Min. RPI (ms)
Input Assembly Configurable	Configuration	0 x 69	–	–
Output Assembly Fix	O → T Configuration	0 x 66	64	5
Input Assembly Fix	T → O Configuration	0 x 64	44	5

Configuration 6: Input Only Multicast

Input Assembly Fix		Instance	Size [byte]	Min. RPI (ms)
Input Assembly Configurable	Configuration	0 x 69	–	–
Output Assembly Fix	O → T Configuration	0 x C7	–	–
Input Assembly Fix	T → O Configuration	0 x 65	44	5

Configuration 7: Exclusive Owner Multicast

Input Assembly Configurable		Instance	Size [byte]	Min. RPI (ms)
Input Assembly Configurable	Configuration	0 x 69	–	–
Output Assembly Fix	O → T Configuration	0 x 66	64	5
Input Assembly Fix	T → O Configuration	0 x 64	88	5

Configuration 8: Input Only Multicast

Input Assembly Configurable		Instance	Size [byte]	Min. RPI (ms)
Input Assembly Configurable	Configuration	0 x 69	-	-
Output Assembly Fix	O → T Configuration	0 x C7	-	-
Input Assembly Fix	T → O Configuration	0 x 65	88	5

Permanently assigned input group

Input Assembly Fix (Assem100) 44 Byte

Designation	Description	Byte
Input Assembly Fix	1. File header (not visible)	1...4
	2. Current diagnosis ¹⁾	5...8
	3. Mass flow	9...12
	4. Volume flow	13...16
	5. Corrected volume flow	17...20
	6. Temperature	21...24
	7. Density	25...28
	8. Reference density	29...32
	9. Totalizer 1	33...36
	10. Totalizer 2	37...40
	11. Totalizer 3	41...44

1) Structure: Code, number, description (e.g.: 16777265 F882 input signal)

Configurable input group

Input Assembly Configurable (Assem101) 88 byte

Designation	Description	Format
Input Assembly Configurable	1. - 10. Input values 1 to 10	Real
	11. - 20. Input values 11 to 20	Double integer

Possible input values

Possible input values 1 to 10:		
<ul style="list-style-type: none"> ▪ Off ▪ Mass flow ▪ Volume flow ▪ Corrected volume flow ▪ Target mass flow ▪ Carrier mass flow ▪ Density ▪ Reference density ▪ Concentration 	<ul style="list-style-type: none"> ▪ Temperature ▪ Carrier pipe temperature ▪ Electronic temperature ▪ Oscillation frequency 0 ▪ Oscillation frequency 1 ▪ Oscillation amplitude 0 ▪ Oscillation amplitude 1 ▪ Oscillation frequency 0 ▪ Oscillation frequency 1 ▪ Oscillation damping 0 ▪ Oscillation damping 1 ▪ Signal shift 	<ul style="list-style-type: none"> ▪ Tube damping fluctuation 0 ▪ Tube damping fluctuation 1 ▪ Exciter current 0 ▪ Exciter current 1 ▪ Monitoring of exciter current 0 ▪ Monitoring of exciter current 1 ▪ Totalizer 1 ▪ Totalizer 2 ▪ Totalizer 3 ▪ Sensor integrity

Possible input values 11 to 20:		
<ul style="list-style-type: none"> ▪ Off ▪ Current diagnosis ▪ Previous diagnosis ▪ Mass flow unit ▪ Volume flow unit ▪ Corrected volume flow unit 	<ul style="list-style-type: none"> ▪ Temperature unit ▪ Density unit ▪ Reference density unit ▪ Concentration unit ▪ Current unit ▪ Status verification 	<ul style="list-style-type: none"> ▪ Totalizer 1 unit ▪ Totalizer 2 unit ▪ Totalizer 3 unit ▪ Verification result

Permanently assigned output group

Output Assembly Fix (Assem102) 64 byte

Designation	Description (format)	Byte	Bit	Value
Output Assembly Fix	1. Totalizer 1	1	1	<ul style="list-style-type: none"> ▪ 0: Enable ▪ 1: Disable
	2. Totalizer 2		2	
	3. Totalizer 3		3	
	4. Pressure compensation		4	
	5. Reference density compensation		5	
	6. Temperature compensation		6	
	7. Verification		7	
	8. Not used		8	
	9. Not used	2...4	0...8	-
	10. Control totalizer 1 (integer)	5...6	0...8	<ul style="list-style-type: none"> ▪ 32226: Add ▪ 32490: Reset and stop ▪ 32228: Default value and stop ▪ 198: Reset and add ▪ 199: Default value and add
	11. Not used	7...8	0...8	-

Designation	Description (format)	Byte	Bit	Value
	12. Control totalizer 2 (integer)	9...10	0..8	See totalizer 1
	13. Not used	11...12	0..8	–
	14. Control totalizer 3 (integer)	13...14	0..8	See totalizer 1
	15. Not used	15...16	0..8	–
	16. External pressure (real)	17...20	0..8	Data format: Byte 1 to 4: External pressure Floating-point number (IEEE754)
	17. External pressure unit (integer)	21...22	0..8	<ul style="list-style-type: none"> ■ 2165: Pa a ■ 2116: kPa a ■ 2137: MPa a ■ 4871: bar a ■ 2166: Pa g ■ 2117: kPa a ■ 2138: MPa a ■ 2053: bar g ■ 2182: Psi a ■ 2183: Psi g ■ 2244: Customer-specific
	18. Not used	23...24	0..8	–
	19. External reference density (real)	25...28	0..8	Data format: Byte 1 to 4: External ref. density Floating-point number (IEEE754)
	20. External reference density unit (integer)	29...30	0..8	<ul style="list-style-type: none"> ■ 2112: kg/Nm³ ■ 2113: kg/Nl ■ 2092: g/Scm³ ■ 2114: kg/Scm³ ■ 2181: lb/Sft³
	21. Not used	31...32	0..8	–
	22. External temperature (real)	33...36	0..8	Data format: Byte 1 to 4: External temperature Floating-point number (IEEE754)
	23. External temperature unit (integer)	37...38	0..8	<ul style="list-style-type: none"> ■ 4608: °C ■ 4609: °F ■ 4610: K ■ 4611: °R
	24. Not used	39...40	0..8	–
	25. Start verification (integer)	41...42	0..8	<ul style="list-style-type: none"> ■ 32378: Start ■ 32713: Cancel
	26. Not used	43...64	0..8	–

10 Commissioning

10.1 Function check

Before commissioning the measuring device:

- ▶ Make sure that the post-installation and post-connection checks have been performed.
- "Post-installation check" checklist →  18
- "Post-connection check" checklist →  38

10.2 Switching on the measuring device

- ▶ After a successful function check, switch on the measuring device.
 - ↳ After a successful startup, the local display switches automatically from the startup display to the operational display.



If nothing appears on the local display or a diagnostic message is displayed, refer to the Operating Instructions for the device →  2

10.3 Configuring the device address via software

In the "**Communication**" submenu the device address can be set.

Navigation

"Setup" menu → Communication → Device address

10.3.1 Ethernet network and Web server

When delivered, the measuring device has the following factory settings:

IP address	192.168.1.212
Subnet mask	255.255.255.0
Default gateway	192.168.1.212



- If hardware addressing is active, software addressing is disabled.
- If a switch is made to hardware addressing, the address configured via software addressing is retained for the first 9 places (the first three octets).



If the IP address of the device is not known, the device address currently configured can be read out: Operating Instructions for the device →  2

10.3.2 PROFIBUS network

At time of delivery, the measuring device has the following factory setting:

Device address	126
----------------	-----



If hardware addressing is active, software addressing is blocked →  34

10.4 Setting the operating language

Factory setting: English or ordered local language

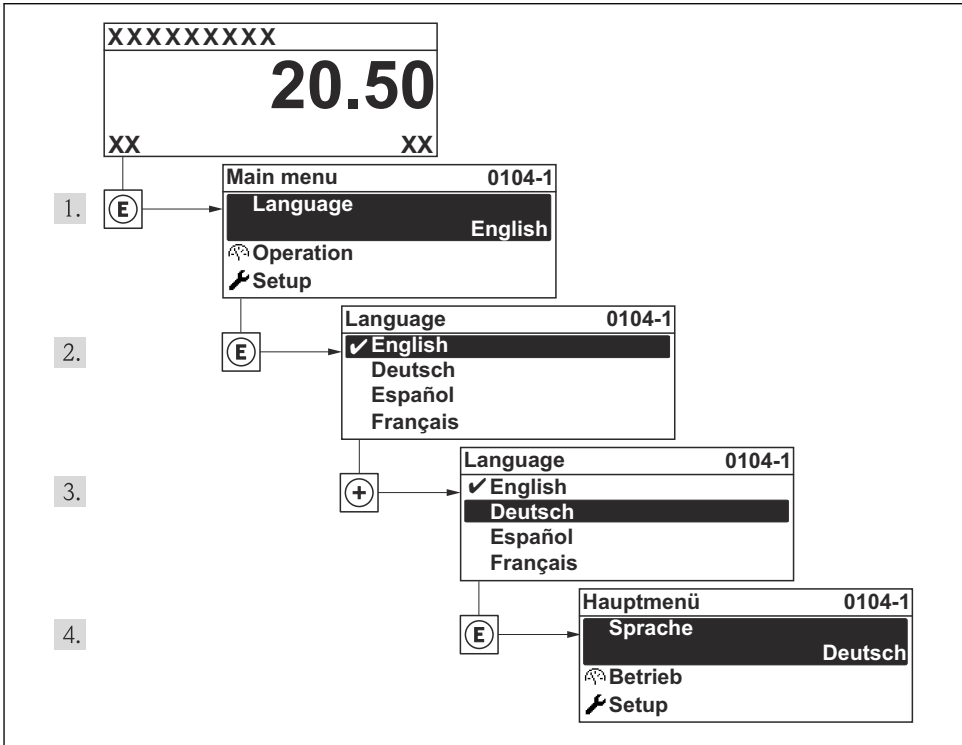

A0013996

14 Taking the example of the local display

10.5 Configuring the measuring device

The **Setup** menu and its guided wizards enable fast commissioning of the measuring device. The wizards systematically guide the user through all the parameters required for configuration, such as parameters for measurement or outputs.

The wizards available in the particular device can vary on account of the device version (e.g. communication method).

Wizard/submenu	Meaning
Status input	Configure the status input
Current output 1	Configure the current output
Pulse/frequency/switch output 1 to n	Configure the pulse/frequency/switch output
Display	Configure the measured value display

Wizard/submenu	Meaning
Output conditioning	Define the output conditioning
Low flow cut off	Set the low flow cut off
Empty pipe detection	Configure empty pipe detection (EPD)
HART input	Configure the HART input

10.6 Defining the tag name

To enable fast identification of the measuring point within the system, you can enter a unique designation using the **Device tag** parameter and thus change the factory setting.

Navigation

"Setup" menu → Device tag

Parameter overview with brief description

Parameter	Description	User entry	Factory setting
Device tag	Enter the name for the measuring point.	Max. 32 characters, such as letters, numbers or special characters (e.g. @, %, /).	Prowirl

10.7 Protecting settings from unauthorized access

The following options exist for protecting the configuration of the measuring device from unintentional modification after commissioning:

- Write protection via access code for the local display and Web browser
- Write protection via write protection switch
- Write protection via keypad lock



For detailed information on protecting the settings against unauthorized access, see the Operating Instructions for the device.

11 Diagnostic information

Faults detected by the self-monitoring system of the measuring device are displayed as a diagnostic message in alternation with the operational display. The message on remedial measures can be called up from the diagnostic messages, and contains important information on the fault.

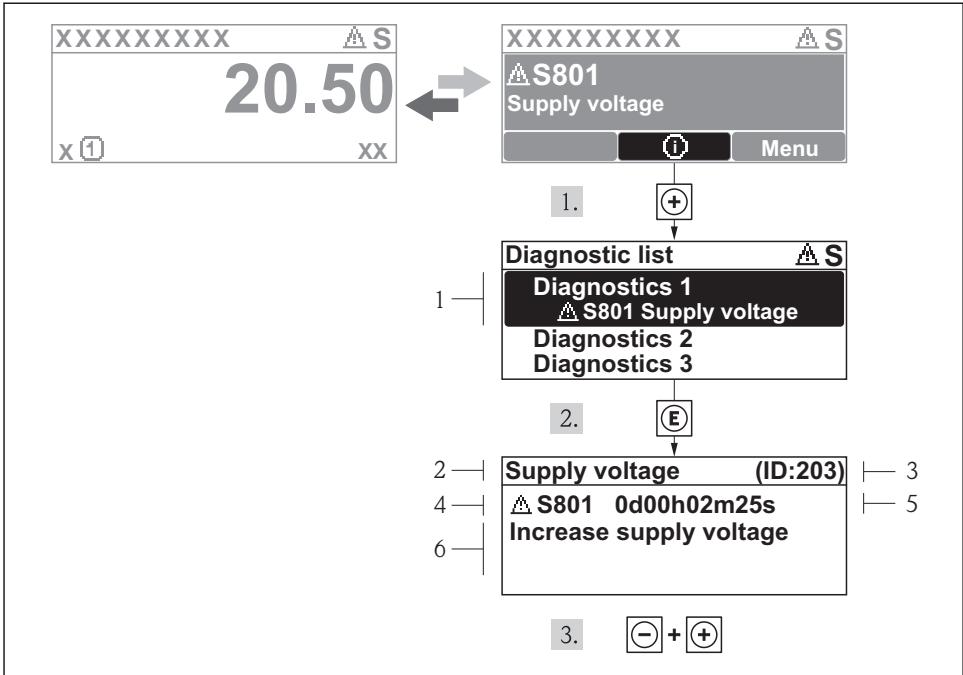

A0013940-EN

15 Message for remedial measures

- 1 Diagnostic information
- 2 Short text
- 3 Service ID
- 4 Diagnostic behavior with diagnostic code
- 5 Operation time of occurrence
- 6 Remedial measures

The user is in the diagnostic message.

1. Press **+** (**i** symbol).
 - ↳ The **Diagnostic list** submenu opens.
2. Select the desired diagnostic event with **+** or **-** and press **E** .
 - ↳ The message for the remedial measures for the selected diagnostic event opens.
3. Press **-** + **+** simultaneously.
 - ↳ The message for the remedial measures closes.

www.addresses.endress.com
