



User Manual

**EE310**

**Humidity/Temperature Sensor**

YOUR PARTNER IN SENSOR TECHNOLOGY



**ELEKTRONIK®**  
Ges.m.b.H.

E+E Elektronik® Ges.m.b.H. provides no warranty of any kind for this publication and accepts no liability for improper use of the products described.

This publication might contain technical inaccuracies or typographical errors. The content is revised regularly and is not subject to change management. The manufacturer reserves the right to modify or change its described products at any time.

© Copyright E+E Elektronik® Ges.m.b.H.  
All rights reserved.

## **USA**

### **FCC notice**

This equipment has been tested and found to comply with the limits for a Class A digital device, pursuant to part 15 of the FCC Rules. These limits are designed to provide reasonable protection against harmful interference when the equipment is operated in a commercial environment. This equipment generates, uses, and can radiate radio frequency energy and, if not installed and used in accordance with the instruction manual, may cause harmful interference to radio communications. Operation of this equipment in a residential area is likely to cause harmful interference in which case the user will be required to correct the interference at his own expense.

## **CANADA**

### **ICES-003 Issue 5:**

CAN ICES-3 A / NMB-3 A

# CONTENT

<b>1</b>	<b>General</b> .....	<b>4</b>
1.1	Explanation of Symbols .....	4
1.2	Safety Instructions .....	4
1.2.1	General Safety Instructions .....	4
1.2.2	Alarm Module with Voltages >50 V (Option AM2) .....	4
1.2.3	Integrated Power Supply 100 - 240 V AC (Option AM3) .....	4
1.2.4	Mounting, Start-up and Operation .....	4
1.2.5	Intended Use .....	5
1.2.6	Disclaimer .....	5
1.3	Environmental Aspects .....	5
1.4	ESD Protection .....	5
<b>2</b>	<b>Scope of Supply</b> .....	<b>6</b>
<b>3</b>	<b>Product Design</b> .....	<b>6</b>
3.1	Dimensions .....	7
3.1.1	Enclosure .....	7
3.1.2	Probes .....	7
<b>4</b>	<b>Installation</b> .....	<b>8</b>
4.1	Mechanical Installation .....	8
4.1.1	Mounting of the Polycarbonate Enclosure .....	8
4.1.2	DIN Rail Mounting of the Polycarbonate Enclosure .....	8
4.2	Electrical Connection .....	9
4.2.1	Electrical Connection and Wiring .....	10
4.3	Probe Mounting (Wall / Duct Version) .....	13
4.4	Mounting Remote Sensing Probe of EE310-T5 .....	13
4.5	Mounting Pressure Tight Probe of EE310-T10 .....	14
4.5.1	Installation of the Probe Directly in the Process .....	14
4.5.2	Installation of the Probe with Ball Valve Set .....	14
4.6	Mounting T24 T only, Remote Probe .....	16
<b>5</b>	<b>Optional Modules</b> .....	<b>17</b>
5.1	Alarm Module (Option AM2) .....	17
5.2	Integrated Power Supply 100 - 240 V AC (Option AM3) .....	19
5.3	RS485 Module - Modbus RTU (Option J3) .....	20
5.4	Ethernet Module - Modbus TCP (Option J4) .....	20
5.4.1	Available TCP and UDP Ports .....	20
5.4.2	IPv4 Settings .....	21
5.4.3	Retrofit with Ethernet Module .....	22
5.5	Modbus Map .....	22
5.6	Pluggable Probe (Option PC4) .....	23
<b>6</b>	<b>Operation</b> .....	<b>23</b>
6.1	Configuration Interface .....	24
6.2	3.5" TFT Colour Display .....	25
6.3	Chart + Data Logger .....	25
6.4	Configuration Menu .....	26
6.5	Status Information .....	27
6.6	Buzzer ON / OFF .....	27
6.7	Error Indication .....	27
<b>7</b>	<b>Maintenance</b> .....	<b>28</b>
7.1	Self Diagnosis and Error Messages .....	28
7.1.1	Error Messages via Display .....	28
7.1.2	Error Messages via LEDs .....	28
7.1.3	Solving Typical Problems .....	28
7.2	Cleaning the Sensing Head / Filter Replacement .....	29
7.3	RH / T Adjustment and Calibration .....	29
<b>8</b>	<b>Replacement Parts / Accessories</b> .....	<b>30</b>
<b>9</b>	<b>Technical Data</b> .....	<b>31</b>
<b>10</b>	<b>Appendix</b> .....	<b>32</b>
10.1	Overview .....	32
10.2	Detailed Information .....	32
10.3	Optional Menu .....	35

# 1 General

This operation manual serves for ensuring proper handling and optimal functioning of the device. The operation manual shall be read before commissioning the equipment and it shall be provided to all staff involved in transport, installation, operation, maintenance and repair.

The operation manual may not be used for the purposes of competition without the written consent of E+E Elektronik® and may not be forwarded to third parties. Copies may be made for internal purposes. All information, technical data and diagrams included in these instructions are based on the information available at the time of writing.

## 1.1 Explanation of Symbols



**This symbol indicates safety information.**

It is essential that all safety information is strictly observed. Failure to comply with this information can lead to personal injuries or damage to property. E+E Elektronik® assumes no liability if this happens.



**This symbol indicates instructions.**

The instructions shall be observed in order to reach optimal performance of the device.

## 1.2 Safety Instructions

### 1.2.1 General Safety Instructions



- Avoid any unnecessary mechanical stress and inappropriate use.
- When replacing the filter cap make sure not to touch the sensing elements.
- For sensor cleaning and filter cap replacement please see “Cleaning instructions” at [www.epluse.com](http://www.epluse.com).
- Installation, electrical connection, maintenance and commissioning shall be performed by qualified personnel only.
- The devices are designed for the operation with class III supply (EU) and class 2 supply (NA).
- The power supply must be switched off before opening the housing.
- An existing Ethernet connection must be disconnected before opening the housing.

### 1.2.2 Alarm Module with Voltages >50 V (Option AM2)

The optional alarm module is isolated from the low-voltage side of EE310 by a special partition; this must remain fitted at all times in the back section of the enclosure.

The EE310 enclosure must be tightly closed during operation. An open enclosure corresponds to IP00 and exposes components carrying dangerous voltage. Any work (maintenance for instance) on the device may be performed by qualified staff only.

### 1.2.3 Integrated Power Supply 100 - 240 V AC (Option AM3)

The EE310 enclosure must be tightly closed during operation. An open enclosure corresponds to IP00 and exposes components carrying dangerous voltage. Any work (maintenance for instance) on the device may be performed by qualified staff only.

### 1.2.4 Mounting, Start-up and Operation

The device has been produced under state of the art manufacturing conditions, has been thoroughly tested and has left the factory fulfilling all safety criteria.

The manufacturer has taken all precautions to ensure safe operation of the device. The user must ensure that the device is set up and installed in a manner that does not have a negative effect on its safe use.

The user is responsible for observing all applicable safety guidelines, local and international, with respect to safe installation and operation on the device. This operating manual contains information and warnings that must be observed by the user in order to ensure safe operation.

- Mounting, start-up, operation and maintenance of the device may be performed by qualified staff only.
- Such staff must be authorized by the plant operator to carry out the mentioned activities.
- The qualified staff must have read and understood this operating manual and must follow the instructions contained within.
- All process and electrical connections shall be thoroughly checked by authorized staff before putting the system into operation.
- Do not install or start-up a device supposed to be faulty. Make sure that such devices are not accidentally used by marking them clearly as faulty.
- A faulty device may only be investigated and possibly repaired by qualified, trained and authorized staff. If the fault cannot be fixed, the device shall be removed from the system.
- Service operations other than described in this operating manual may only be performed by the manufacturer.

### 1.2.5 Intended Use

EE310 is optimized for reliable measurement in demanding industrial applications. In addition to highly accurate measurement of relative humidity (RH) and temperature (T), the sensor also calculates parameters such as dew point, absolute humidity and mixing ratio.

Various models are available including wall, duct and remote probe. Remote probe models can be used from  $-80^{\circ}\text{C}$  ( $-112^{\circ}\text{F}$ ) up to  $180^{\circ}\text{C}$  ( $356^{\circ}\text{F}$ ) and the pressure tight probe up to 20 bar (290 psi). Please refer to chapter 9 Technical Data for the working ranges of the probes. The use of the EE310 other than described in this manual is not allowed.

The manufacturer cannot be held responsible for damages as a result of incorrect handling, installation and maintenance of the device.

Unauthorized modifications of the product lead to loss of all warranty claims. The device may only be powered as decied in this manual.

### 1.2.6 Disclaimer

The manufacturer or his authorized agent can only be held liable in case of willful or gross negligence. In any case, the scope of liability is limited to the corresponding amount of the order issued to the manufacturer. The manufacturer assumes no liability for damages incurred due to failure to comply with the applicable regulations, operating instructions or the operating conditions. Consequential damages are excluded from the liability.

## 1.3 Environmental Aspects



Products from E+E Elektronik® are developed and manufactured observing of all relevant requirements with respect to environment protection. Please observe local regulations for the device disposal.



For disposal, the individual components of the device must be separated according to local recycling regulations. The electronics shall be disposed of correctly as electronics waste.

## 1.4 ESD Protection

The sensing elements and the electronics board are ESD (electrostatic discharge) sensitive components of the device and must be handled as such. The failure to do so may damage the device by electrostatic discharges when touching exposed sensitive components.

## 2 Scope of Supply

	Included in the scope of supply of:
EE310 according to ordering guide	all versions
Operation manual	all versions
Inspection certificate according to DIN EN 10204 – 3.1	all versions
Mating plug for integrated power supply	AM3
Mating plug RKC 5/7	AM3 / E4 / E6 / E12
Mating plug RSC 5/7 (2 pcs. for option E12)	E5 / E6 / E12
Mating plug HPP V4 RJ45 Cat5	J4

## 3 Product Design

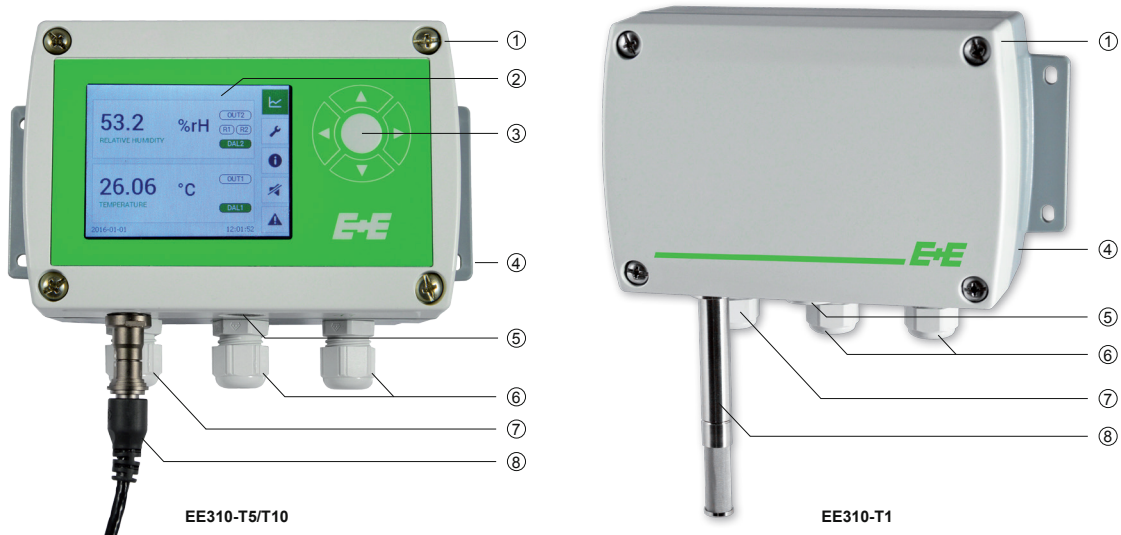

Fig. 1 Product design

- ① Front section with electronic / display\* and probe cable
- ② 3.5" TFT colour display\*
- ③ 5 push-buttons for configuration menu
- ④ Back section with electrical connection, alarm\* + supply module\* and mounting holes
- ⑤ Micro USB service interface
- ⑥ Standard cable glands / connectors\*
- ⑦ Additional cable gland / connector\*
- ⑧ Probe / cable gland / connector\*

\* optional

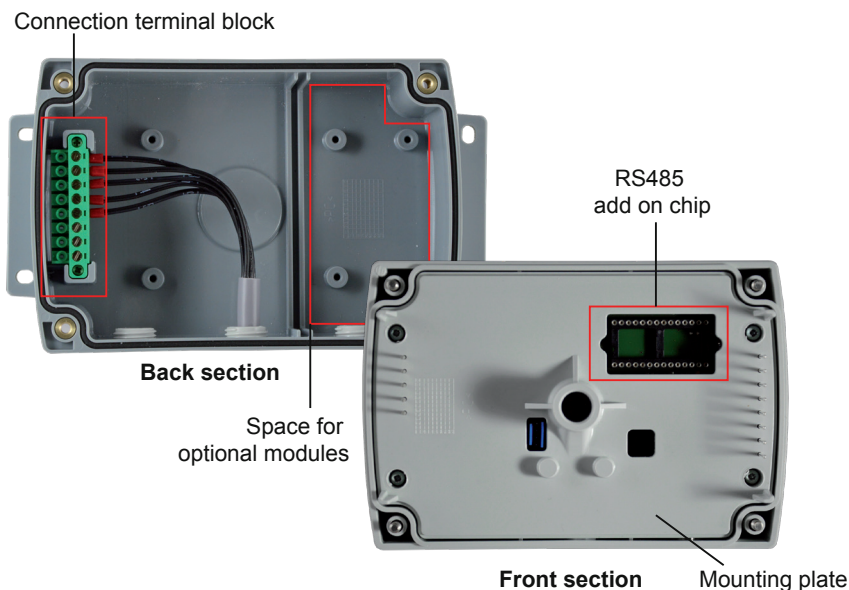
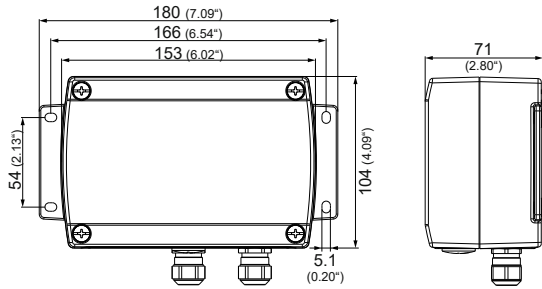

Fig. 2 Modular enclosure

# 3.1 Dimensions

## 3.1.1 Enclosure

### Polycarbonate



### Stainless steel

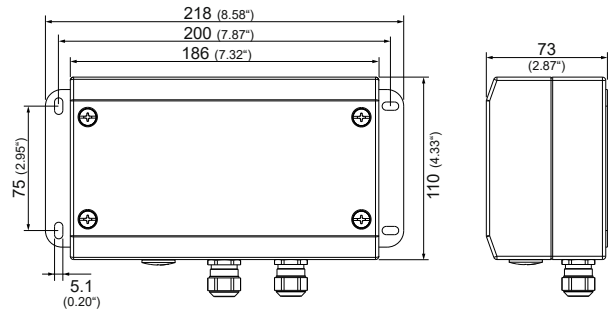

## 3.1.2 Probes

### T1: Wall mount

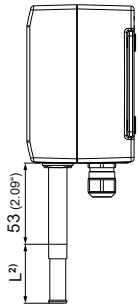

### T5: Remote probe up to 180 °C (356 °F)

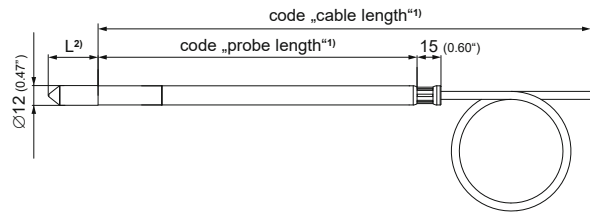

### T2: Duct mount

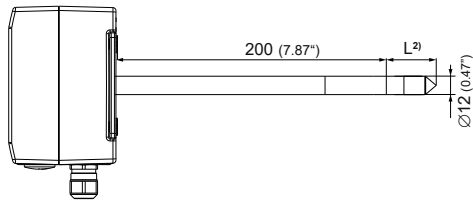

### T10: Pressure tight probe up to 20 bar (300 psi)

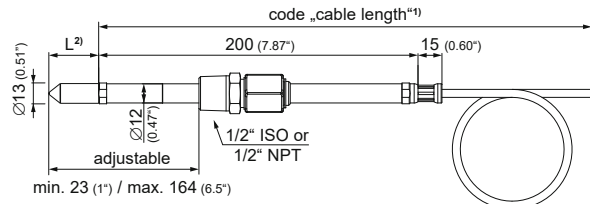

### T24: T only remote probe (M3)

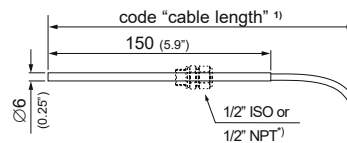

1) Refer to ordering guide

2) L = filter length; refer to data sheet "Accessories"

\*) Not included in the scope of supply:  
 1/2" ISO  $\varnothing$  6 mm HA011104  
 1/2" NPT  $\varnothing$  6 mm HA011105

# 4 Installation

## 4.1 Mechanical Installation

### 4.1.1 Mounting of the Polycarbonate Enclosure

- Drill the mounting holes according to the corresponding mounting pattern below.
- Mount the back section of the enclosure with 4 screws (screw diameter < 4.2 mm (0.2"), not included in the scope of supply).

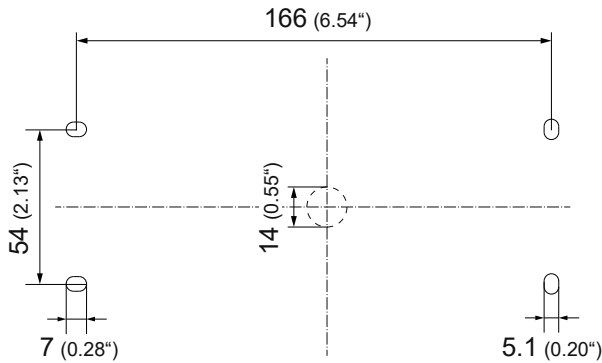

Fig. 3 Drilling pattern of polycarbonate enclosure in mm / inch

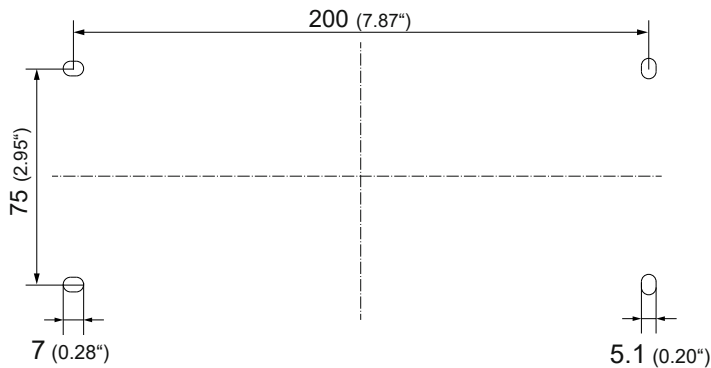

Fig. 4 Drilling pattern of stainless steel enclosure in mm / inch

### 4.1.2 DIN Rail Mounting of the Polycarbonate Enclosure

- Mount the two DIN rail brackets (to be ordered separately, see chapter 8) onto the back section.
- Snap in the enclosure onto the DIN rail

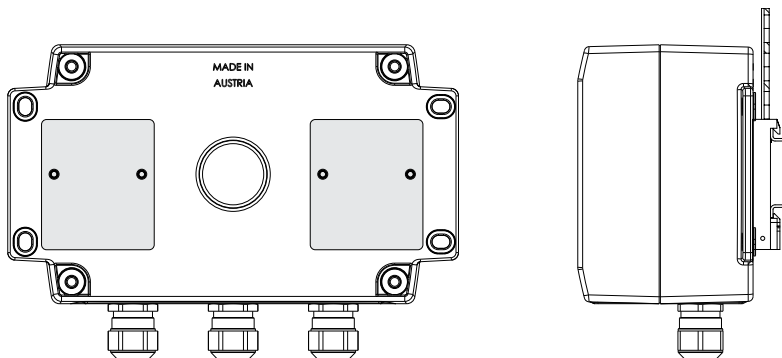

Fig. 5 DIN rail installation



## 4.2 Electrical Connection



The electrical installation of the EE310 shall be performed by qualified personnel only. Observe all applicable national and international requirements for the installation of electrical devices as well as for power supply according to EN 61140, class III (EU) and class 2 supply (North America).



For EE310 with alarm module (option AM2) or integrated power supply 100 - 240 V AC (option AM3), the metal enclosure must be grounded during operation.

### Connection diagram

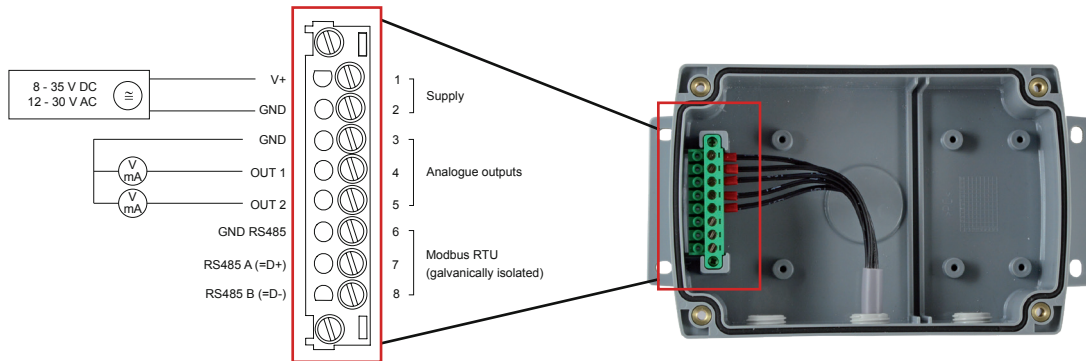

Fig. 6 Electrical connection

### Analogue outputs

Both analogue outputs shall be configured to either voltage or current. Measurands, analogue output range and scaling are freely selectable. All settings can be performed via display and push buttons or using the EE-PCS Product Configuration Software, see EE-PCS Product Configuration Software, see chapter 6.1.

### Error indication

The analogue outputs feature an error indication function according to NAMUR NE43. In the case of an error the output signal will freeze at 21 mA or 11 V respectively.



### Note

By default the error indication is disabled.



When changing one of the analogue outputs from current to voltage and vice versa, the second output will change automatically as well. The output scaling changes automatically if it is out of physical range (i.e. 20 mA will be changed to 10 V instead of 20 V).

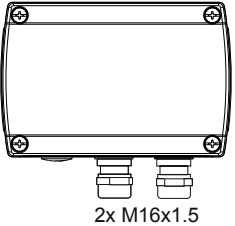
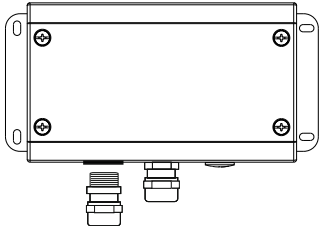
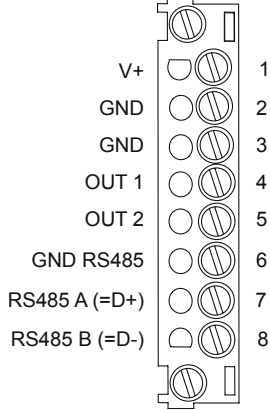
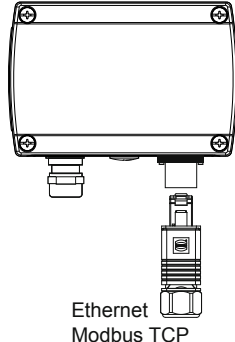
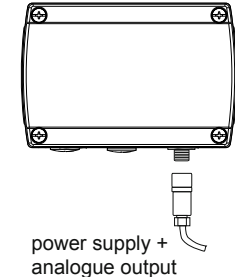
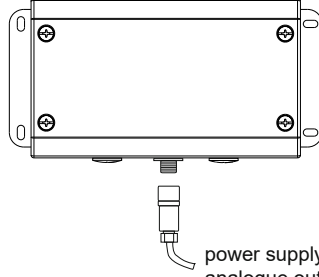
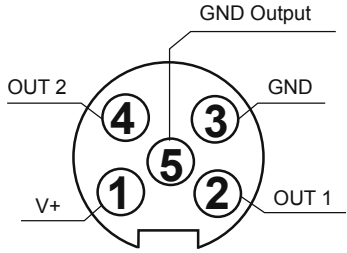
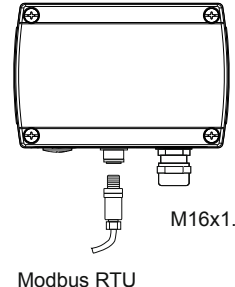
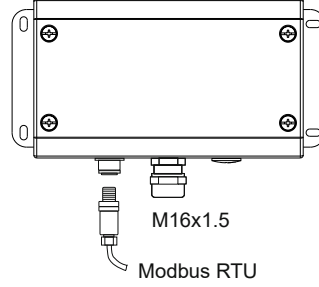
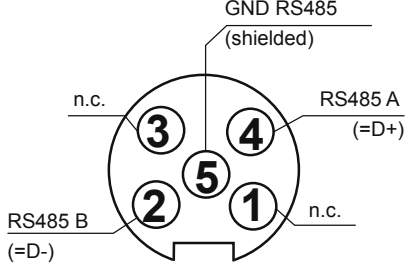

Check output scale after changing between voltage and current output.

### 4.2.1 Electrical Connection and Wiring

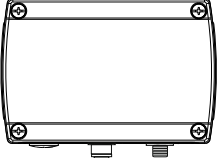
Option	Polycarbonate enclosure	Stainless steel enclosure	Pin assignment
Cable glands	 <p>2x M16x1.5</p>	 <p>1 x M16x1.5 mounted 1 x M16x1.5 enclosed</p>	
J4	 <p>Ethernet Modbus TCP</p>		
E4	 <p>power supply + analogue output</p>	 <p>power supply + analogue output</p>	
E5	 <p>Modbus RTU M16x1.5</p>	 <p>Modbus RTU M16x1.5</p>	

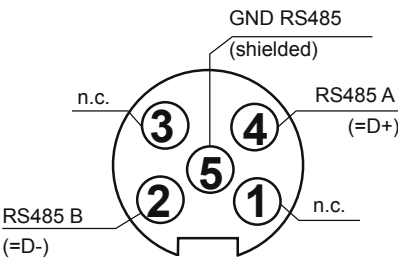
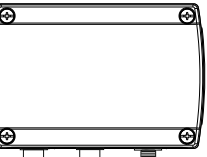
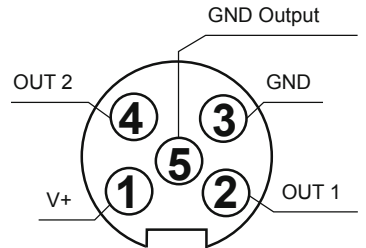
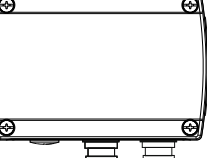
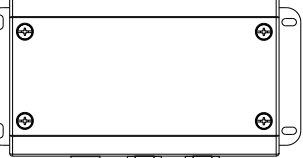
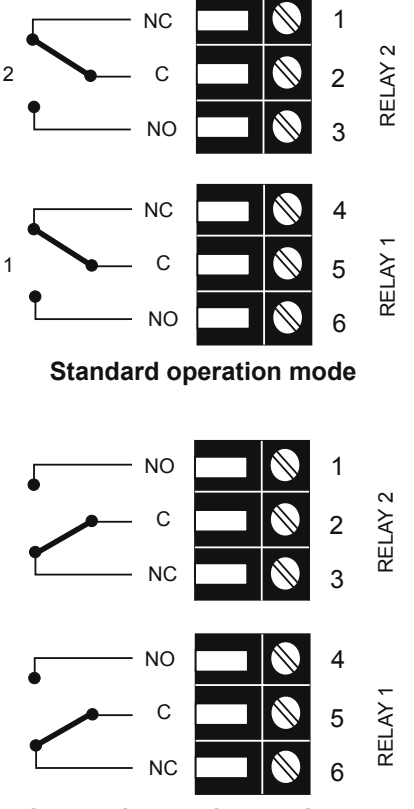
Option	Polycarbonate enclosure	Stainless steel enclosure	Pin assignment
E6	 <p>Modbus RTU power supply + analogue output</p>	 <p>Modbus RTU power supply + analogue output</p>	 <p><b>Modbus RTU</b></p>
E12	 <p>Modbus RTU power supply + analogue output</p>		 <p><b>Power supply + analogue output</b></p>
AM2	 <p>2x M16x1.5</p>	 <p>2x M16x1.5</p>	 <p><b>Standard operation mode</b></p> <p><b>Inverted operation mode</b></p>

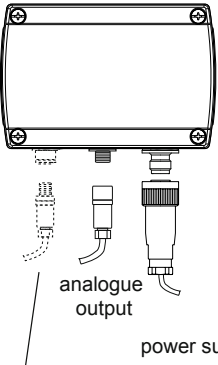
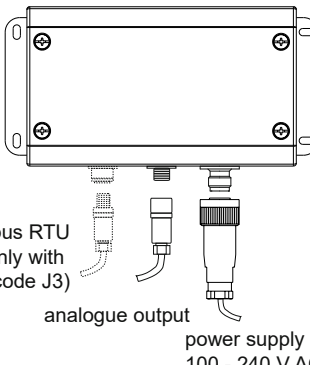
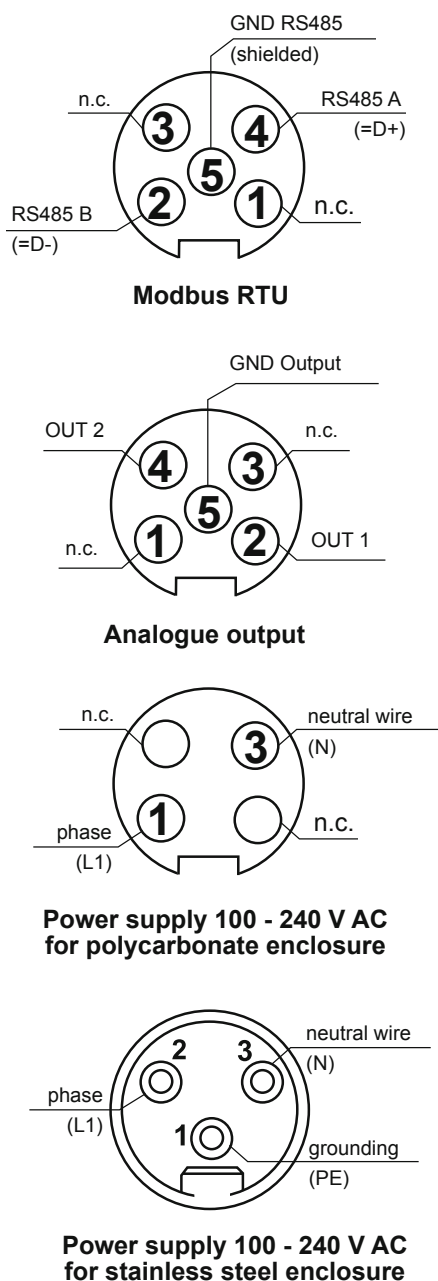
Option	Polycarbonate enclosure	Stainless steel enclosure	Pin assignment
AM3	 <p>analogue output</p> <p>power supply</p> <p>Modbus RTU (only with order code J3)</p>	 <p>Modbus RTU (only with order code J3)</p> <p>analogue output</p> <p>power supply 100 - 240 V AC</p>	 <p>GND RS485 (shielded)</p> <p>n.c.</p> <p>RS485 A (=D+)</p> <p>RS485 B (=D-)</p> <p>n.c.</p> <p><b>Modbus RTU</b></p> <p>GND Output</p> <p>OUT 2</p> <p>n.c.</p> <p>OUT 1</p> <p>n.c.</p> <p><b>Analogue output</b></p> <p>n.c.</p> <p>neutral wire (N)</p> <p>phase (L1)</p> <p>n.c.</p> <p><b>Power supply 100 - 240 V AC for polycarbonate enclosure</b></p> <p>neutral wire (N)</p> <p>phase (L1)</p> <p>grounding (PE)</p> <p><b>Power supply 100 - 240 V AC for stainless steel enclosure</b></p>



External diameter of the supply cable for option AM3: 10-12 mm (0.39-0.47").  
 Maximum wire cross section for AM3 connecting cable: 1.5 mm<sup>2</sup> (AWG 16) .

External diameter of the cable for Modbus RTU and analogue output female plug: 4 - 6 mm (0.16 - 0.24").  
 Maximal wire cross section for connecting cable: 0.5 mm<sup>2</sup> (AWG 21).

### 4.3 Probe Mounting (Wall / Duct Version)

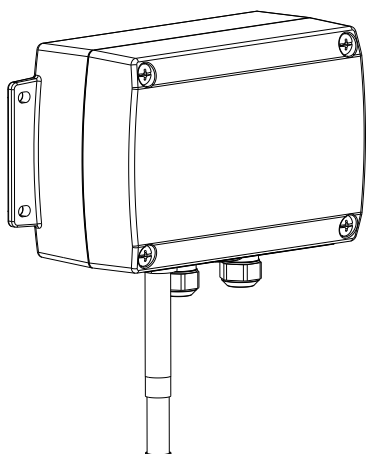

Fig. 7 Mounting of model EE310-T1. The probe shall point downwards.

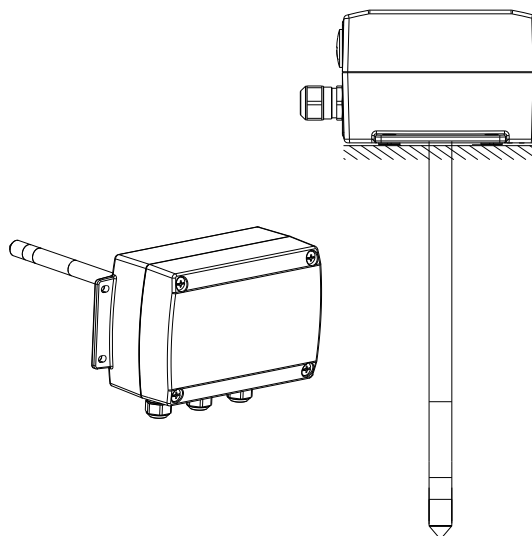

Fig. 8 Mounting of model EE310-T2. The probe shall be mounted horizontally or vertically pointing downwards.

### 4.4 Mounting Remote Sensing Probe of EE310-T5

For mounting the probe into a separation wall use the stainless steel mounting flange. The immersion depth is adjustable. The probe shall be mounted horizontally.

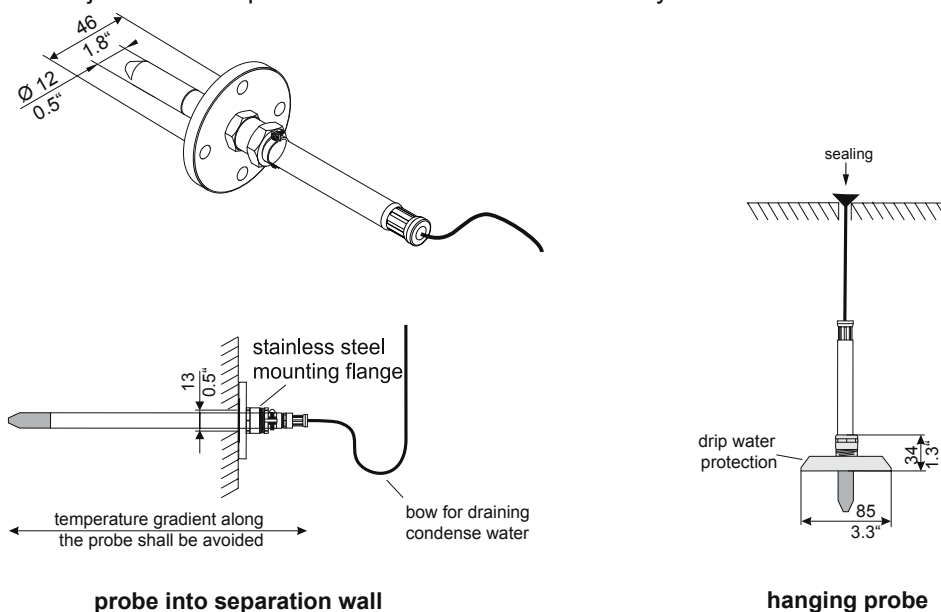

Fig. 9 Mounting the remote probe of EE310-T5

For accurate measurement it is of paramount importance to avoid T gradients along the probe. In case of large T difference between the front and the back of the probe, it is highly recommended to insert the probe completely into the process. Should this not be possible, place a thermal isolation layer on the part of the probe outside the process (on the cable side).

The stainless steel mounting flange is not appropriate for pressure tight mounting. For pressure tight requirements use EE310-T10.

For probe hanging onto its cable from the ceiling in applications where condensation is likely to happen it is important to avoid condense water getting from the cable to the probe and into the sensing head. For this use the drip water protection (see chapter 8).

## 4.5 Mounting Pressure Tight Probe of EE310-T10



### General safety instructions for installation

The installation, commissioning and operation of the EE310-T10 may be performed by qualified staff only. Special attention shall be paid to the correct installation of the probe into the process. In case of inappropriate installation there is the risk for the probe to be suddenly expelled due to the pressure in the process.

Bending over the sensing probe should be avoided under any circumstances!

Make sure that the surface of the probe is not damaged during installation. A damaged probe surface may lead to damaged seals and consequently to leakage and pressure loss.

The probe is rated with leakage rate B according to EN12266-1.

### 4.5.1 Installation of the Probe Directly in the Process

For direct probe installation shut-off valves shall be placed on both sides of the probe insert (see Fig. 10). This allows the sensor probe to be easily removed for maintenance and calibration.

For direct installation into a pressure chamber make sure that the pressure in the chamber and the ambient pressure are equal before removing the probe. The temperature during probe installation may deviate by max.  $\pm 40$  °C ( $\pm 72$  °F) from the regular temperature during normal operation.



Replace the metal sealing ring (see Fig. 10) by a new one every time before re-installing the probe.

#### Probe installation steps

- Close both shut-off valves.
- Place the sensor probe into the probe insert and adjust the immersion depth.
- Tighten the lock nut with a torque of 30 Nm.
- Open the shut-off valves.



Observe strictly the tightening torque. A torque lower than 30 Nm results in a smaller retention force of the clamping sleeve. This leads the risk of sudden expulsion of the sensing probe due to the pressure. A torque higher than 30 Nm may lead to permanent deformation of the clamping sleeve and the sensing probe. This would make the removal and re-installation of the probe difficult or even impossible.

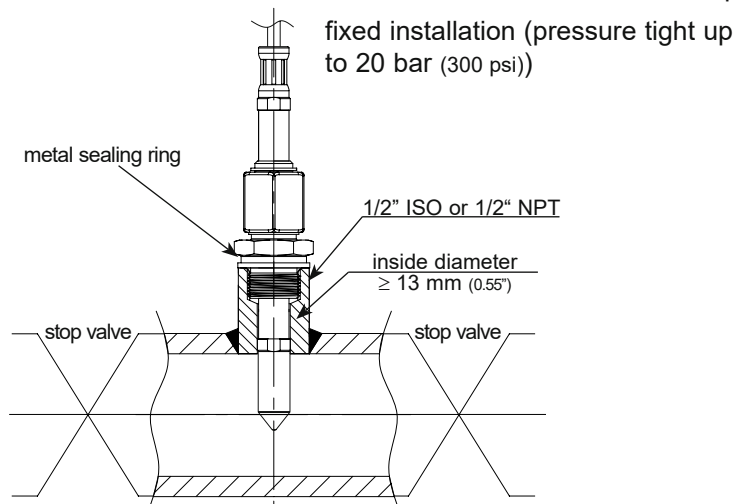

Fig. 10 Installation of the EE310-T10 probe directly into the process

### 4.5.2 Installation of the Probe with Ball Valve Set

The ball valve set allows for installation and removal of the probe without process interruption.

For mounting into a duct, the ball valve shall be installed perpendicular to the flow direction.



The two metal sealing rings (see Fig. 11) shall be replaced every time prior to re-installing the probe.

The temperature during probe installation may deviate by max.  $\pm 40$  °C ( $\pm 72$  °F) from the regular temperature during normal operation.

### Installation of the probe (see Fig. 11)

- Install the probe into the ball valve while the ball valve is closed.
- Open the ball valve.
- Slide the probe through the ball valve to the desired immersion depth. Depending on the process pressure additional tools may be necessary for pushing the probe into the process. Make sure not to damage the probe and the cable.
- Tighten the lock nut with a torque of 30 Nm.



Observe strictly the tightening torque. A torque lower than 30 Nm results a smaller retention force of the clamping sleeve. This leads the risk of sudden expulsion of the sensing probe due to the pressure. A torque higher than 30 Nm may lead to permanent deformation of the clamping sleeve and the sensing probe. This would make the removal and re-installation of the probe difficult or even impossible.

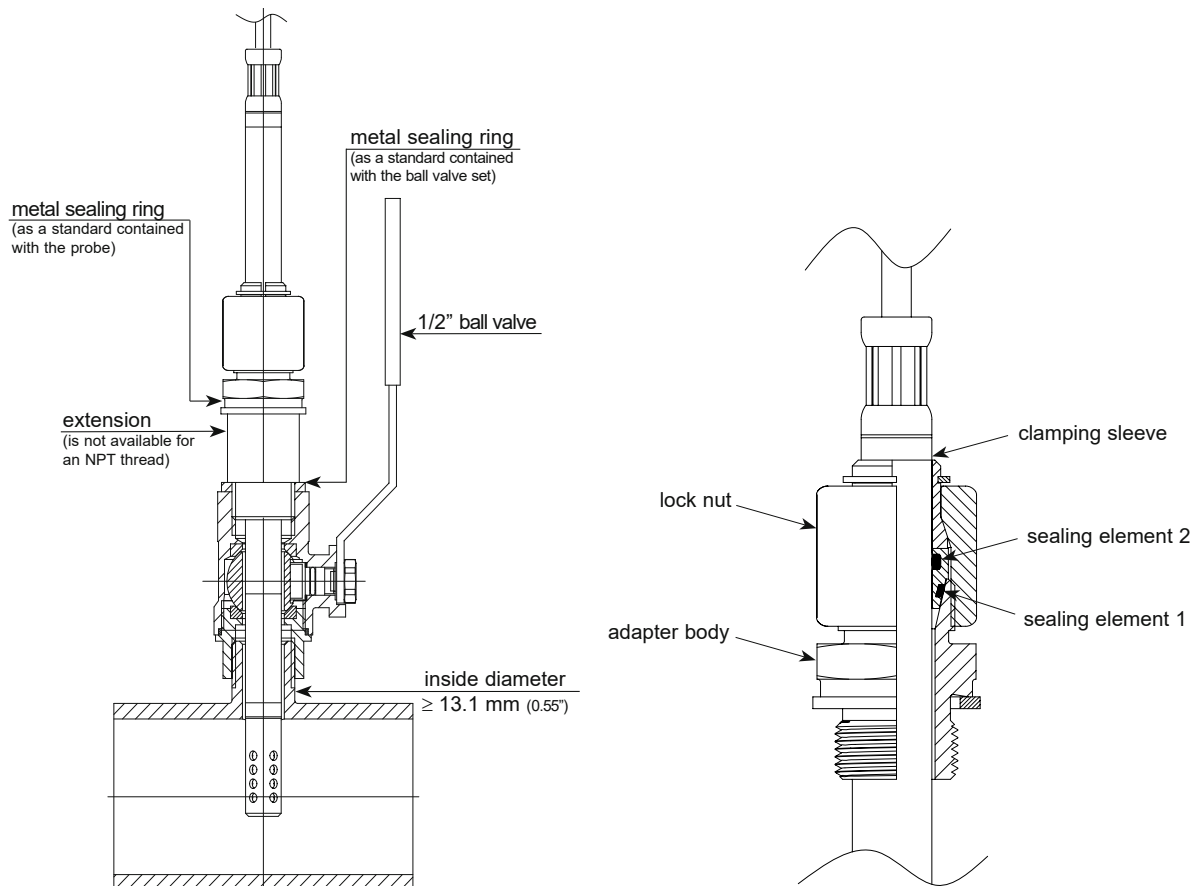

Fig. 11 Installation of the probe by utilizing the ball valve set

### Removing the probe

- Hold firmly the probe to avoid it being suddenly expelled when releasing the lock. Do not bend damage the probe cable.
- Loosen slowly the lock nut with a spanner (spanner width 24) only till the probe is pushed out by the overpressure in the process. Do not completely loosen the lock nut, but only as much as necessary for the probe to slide.
- After the probe has been pushed out of the process up to the stop, close the ball valve.
- Remove the probe from the ball valve.



Observe the correct positioning of the sealing element 1 before reinstalling the probe.

## 4.6 Mounting T24 T only, Remote Probe

The sensing probe shall be mounted horizontally or vertically, pointing downwards whenever possible. For best measuring results make sure that the whole probe body is inserted to your process media. The T24 T only, remote probe is capable for the use within the following working ranges:

T Working range sensing probe:	-40...180 °C (-40...356 °F) or -80...30 °C (-112...86 °F)
Pressure range:	0.01...20 bar (0.15...300 psi)

### Mounting with flange

A mounting flange for the Ø 6 mm (1/4") T probe is available as an accessory.

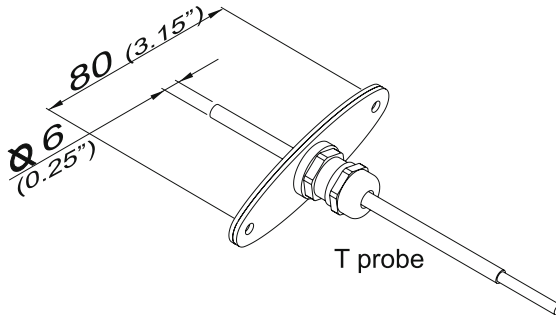

Fig. 12 Flange for T probe Ø 6 mm (1/4"), HA010207

### Pressure tight mounting

The screw connectors for pressure tight installation up to 20 bar (300 psi) are available as accessories:

1/2" ISO	HA011104
1/2" NPT	HA011105



General safety instructions for pressure tight installation

The installation, commissioning and operation of the EE310-T24 in pressure tight applications may be performed by qualified staff only. Special attention shall be paid to the correct installation of the probe into the process. In case of inappropriate installation there is the risk for the probe to be suddenly expelled due to the pressure in the process.

Bending over the sensing probe should be avoided under any circumstances!

Make sure that the surface of the probe is not damaged during installation. A damaged probe surface may lead to damaged seals and consequently to leakage and pressure loss.

### Mounting with immersion well

The innovative stainless steel immersion well is mainly dedicated for measurement in liquids and allows for fast and safe replacement of the T24 T only, remote probe.

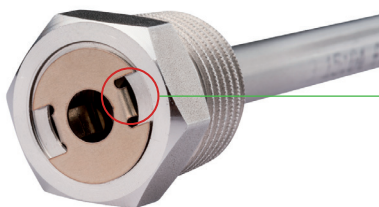

#### Innovative mounting spring

- » For securing the probe inside the well
- » No fastening screw, no tools required

Fig. 13 Immersion well for EE310-T24 T only, remote probe

Pressure rating:	25 bar (363 psi), stainless steel
Max. flow speed:	9 m/s (1771 ft/min)



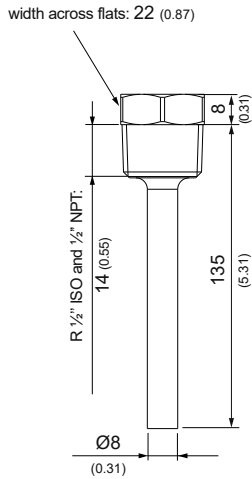
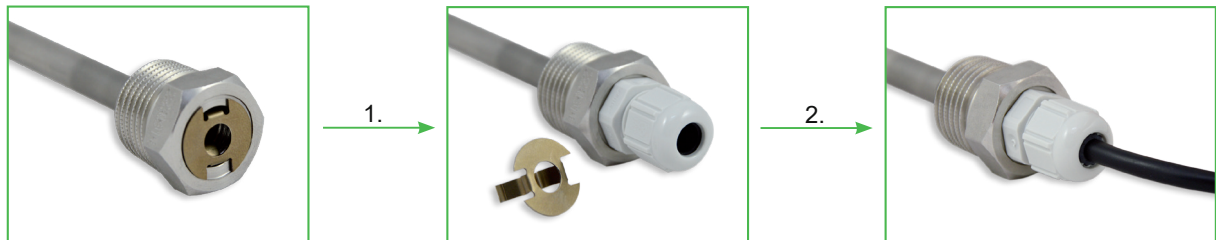

Fig. 14 Immersion well dimensions in mm (inch)

The immersion well can also be used with a cable gland instead of the mounting spring:



1. The spring inside the well must be removed and replaced by a standard M12x1.5 cable gland (not included in the scope of supply).
2. Insert the remote cable sensor and fix it by fastening the cable gland.



Please observe the operating temperature range of the cable gland to match the process parameters!

## 5 Optional Modules

### 5.1 Alarm Module (Option AM2)

The module offers two freely configurable relay outputs for alarm or control purposes. Various operation modes are available including hysteresis, window and error indication.

Max. switch load:	250 V AC / 6 A	28 V DC / 6 A
Min. switch load:	12 V / 100 mA	

No overcurrent and short circuit protection.  
Both relays shall be connected to either high or low voltage.

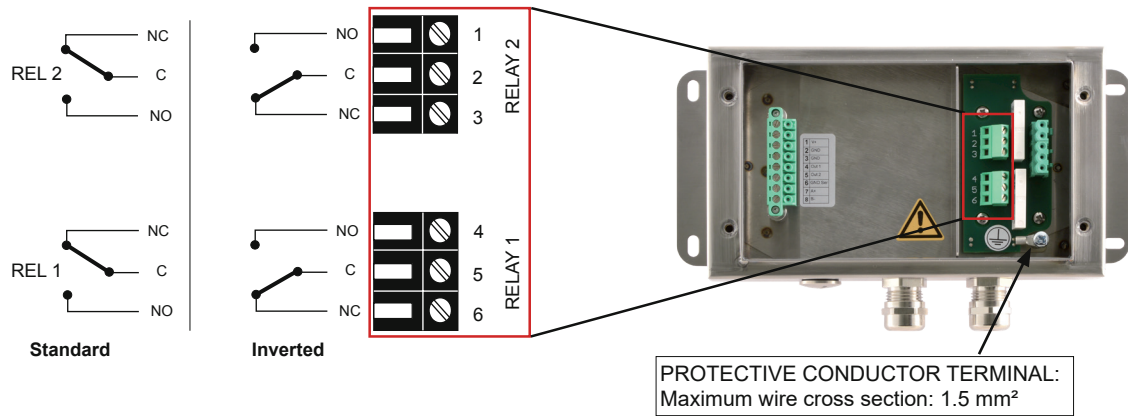

Fig. 15 Alarm module (option AM2)



The metal housing must be grounded during operation. National regulations for installation must be observed!



When error indication mode is selected, various errors will trigger the alarm output. An alarm output in this operation mode is used for error indication only.

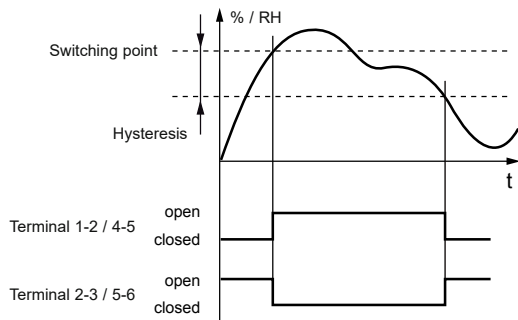

Fig. 16 Example hysteresis mode

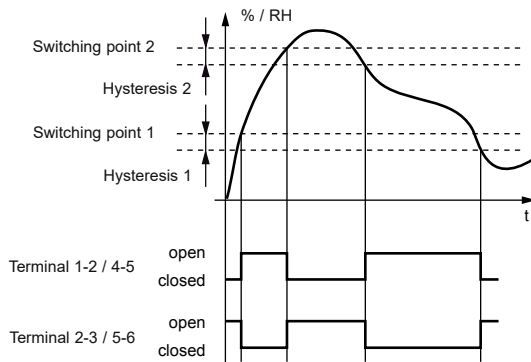

Fig. 17 Example window mode

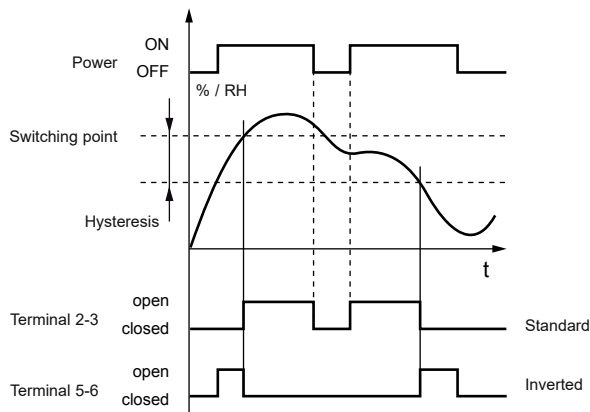

Fig. 18 Example of alarm in case of power supply failure using inverted alarm outputs.

The measurands at the outputs as well as switching points, hysteresis and the default state (standard / inverted) can be set via EE-PCS Product Configuration Software or using the display and the push buttons (see chapter 10.3 / Fig. 38).

## 5.2 Integrated Power Supply 100 - 240 V AC (Option AM3)

This module allows the EE310 to be powered with 100 - 240 V AC (50/60 Hz), 2 VA.



polycarbonate enclosure



stainless steel enclosure

Fig. 19 Power supply module (option AM3)



The AM3 option includes a 1.25 A fuse on the 100-240 V side. This fuse may not be replaced by the user, only by the E+E after sales service.

The protection of the supply cable against excess current and short-circuit must be designated to a wire cross section of 0.8 mm<sup>2</sup> (AWG 18) (6A fuse).

The metal housing must be grounded during operation.

All national regulations for installation shall be observed!

## 5.3 RS485 Module - Modbus RTU (Option J3)

Up to 32 EE310 sensors with Modbus RTU interface can be connected in a RS485 bus system.

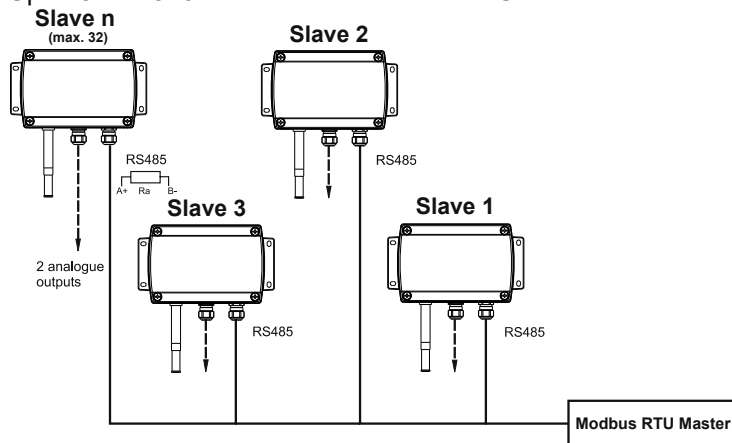

Fig. 20 Two wire RS485 bus



Both ends of the bus shall be terminated with a resistor  $R_a=120\ \Omega$ .

The setup of the Modbus RTU communication can be performed via EE-PCS Product Configuration Software or via display and push buttons, see chapter 10.3 / Fig. 39.

### Data transmission

	Factory settings	Selectable values
Baud rate	9600	300, 600, 1200, 2400, 4800, 9600, 19200, 38400, 57600, 76800
Data bits	8	8
Parity	EVEN	None, odd, even
Stop bits	1	1 or 2
Modbus address	231	1...247



The recommended setting for multiple devices in a Modbus RTU network is 9600 8 Even 1.

## 5.4 Ethernet Module - Modbus TCP (Option J4)

The Ethernet module features power over Ethernet (PoE) and RJ45 connector with IP65 protection class.



The Ethernet connection shall be disconnected before opening the enclosure!

### 5.4.1 Available TCP and UDP Ports

#### Modbus TCP (Port 502)

See “Modbus TCP/IP implementation guide” which can be found on [www.modbus.org/docs/Modbus\\_Messaging\\_Implementation\\_Guide\\_V1\\_0b.pdf](http://www.modbus.org/docs/Modbus_Messaging_Implementation_Guide_V1_0b.pdf).

The unit identifier of the MBAP header is not used and can be any value from 0 to 255.

#### HTTP-Webserver (Port 80)

For a quick communication check enter the desired IP in a web browser and connect with the EE310 Ethernet Module’s Webserver.

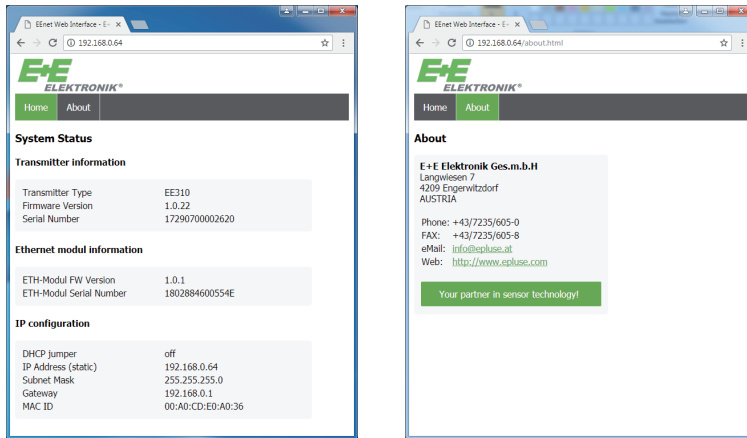

Alternatively send an ICMP echo request (“ping”) to check correct communication settings.

### UDP (Port 5234)

Backwards compatible communication protocol with EE31 device series.

Communication via Ethernet takes place by means of UDP packets, which transport a command or a command response in EE31 protocol format as payload data.

See “Ethernet - communication protocol” which can be found on [www.epluse.com/en/service-support/download-center](http://www.epluse.com/en/service-support/download-center)

### 5.4.2 IPv4 Settings

#### Factory setting:

IP Address: 192.168.0.64  
 Subnet Mask: 255.255.255.0  
 Gateway: 192.168.0.1  
 DNS: 192.168.0.1

DHCP options can be set with jumper on the PCB

Factory setting: DHCP disabled (static IP)

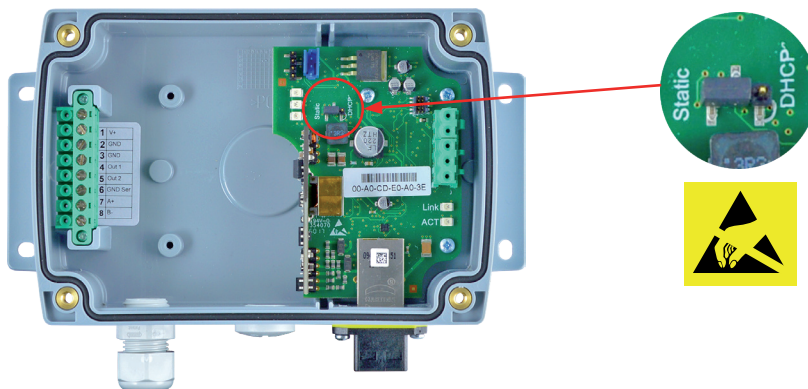

Fig. 21 Ethernet Module - DHCP setting

The setup of the Modbus TCP communication can be performed via EE-PCS Product Configuration Software or via display and push buttons, see chapter 10.3 / Fig. 40.

Modifying the IP address via EE-PCS or display is possible only when the DHCP jumper is set to “Static”. Otherwise the IP settings are read-only.



Supported Ethernet standard: 802.3i/u/x and af; IPv6 is not supported.

### 5.4.3 Retrofit with Ethernet Module

The EE310 can be retrofitted with an Ethernet Module. Before retrofitting please make sure, that the EE310 firmware is updated to the latest version by using the Configuration Software EE-PCS.

- Firmware for sensor: V 1.0.22 or higher
- Firmware for display: V 1.0.9 or higher

Order code:

**HA010606** for remote probe type T5 and T10

**HA010607** for duct mount type T2

Due to strong self-heating effects, the Ethernet interface is only recommended with the types T2, T5 and T10 (duct mount and remote probe). Wall mount applications with Ethernet interface shall be realized with type T5 and 0.5 m probe cable by fixing the probe onto the wall with the mounting bracket type HA010211.

## 5.5 Modbus Map

Register number <sup>1)</sup> [DEC]	Protocol address <sup>2)</sup> [HEX]	Measured value	Unit	Type
Read registers: function code 0x03 / 0x04				
1021	3FC	Relative humidity	%	32-bit float
1003	3EA	Temperature	°C	32-bit float
1005	3EC	Temperature	°F	32-bit float
1105	450	Dew point temperature	°C	32-bit float
1107	452	Dew point temperature	°F	32-bit float
1131	46A	Frost point / Dew point temperature	°C	32-bit float
1133	46C	Frost point / Dew point temperature	°F	32-bit float
1113	458	Absolute humidity	g/m <sup>3</sup>	32-bit float
1115	45A	Absolute humidity	gr/ft <sup>3</sup>	32-bit float
1121	460	Mixing ratio	g/kg	32-bit float
1123	462	Mixing ratio	gr/lb	32-bit float
1109	454	Wet bulb temperature	°C	32-bit float
1111	456	Wet bulb temperature	°F	32-bit float
1125	464	Specific enthalpy	kJ/kg	32-bit float
1129	468	Specific enthalpy	BTU/lb	32-bit float
1127	466	Specific enthalpy	ft lbf/lb	32-bit float
1101	44C	Water vapour partial pressure	mbar	32-bit float
1103	44E	Water vapour partial pressure	psi	32-bit float
1151	47E	Volume concentration	ppm	32-bit float
5001	1388	Air pressure	mbar	32-bit float

Write registers: function code 0x06 for 16-bit and 0x10 (decimal: 16) for 32-bit				
0001	0	Slave-ID	/	16-bit integer
5001	1388	Air pressure	mbar	32-bit float

1) Register number starts from 1

2) Protocol address starts from 0

### Modbus RTU Example

Example of MODBUS RTU command for reading the Temperature (float value) T = 26.953624 °C from the register 0x3EA

Device slave ID 231 [E7 in HEX]

Reference document, chapter 6.3: [www.modbus.org/docs/Modbus\\_Application\\_Protocol\\_V1\\_1b.pdf](http://www.modbus.org/docs/Modbus_Application_Protocol_V1_1b.pdf)

**Request [Hex]: E7 03 03 EA 00 02 F3 BD**

	Modbus ID address	Function code	Starting address Hi	Starting address Lo	No. of register Hi	No. of register Lo	CRC	
Request [Hex]:	E7	03	03	EA	00	02	F3	BD

Response [Hex]: E7 03 04 A1 06 41 D7 CE 0E

	Modbus ID address	Function code	Byte count	Register 1 value Hi	Register 1 value Lo	Register 2 value Hi	Register 2 value Lo	CRC	
Response [Hex]:	E7	03	04	A1	06	41	D7	CE	0E

Conversion:

Response [Hex]	Value in decimal
41 D7 A1 06	26.953624

See also Application Note AN0103 at [www.epluse.com/EE310](http://www.epluse.com/EE310).

## 5.6 Pluggable Probe (Option PC4)

EE310-T5 and EE310-T10 sensors are optionally available with pluggable sensing probe, which is attached to the EE310 enclosure by a push-pull plug. If the probe or the probe cable gets damaged it is possible to easily replace the probe without humidity and temperature adjustment. The replacement probe (see order information below) is supplied with a set of 7 individual parameters.



If you use two or more devices at the same time, make sure not to mix up the sensors! You can read out the serial number of the connected sensor by scanning the barcode on the basic unit.

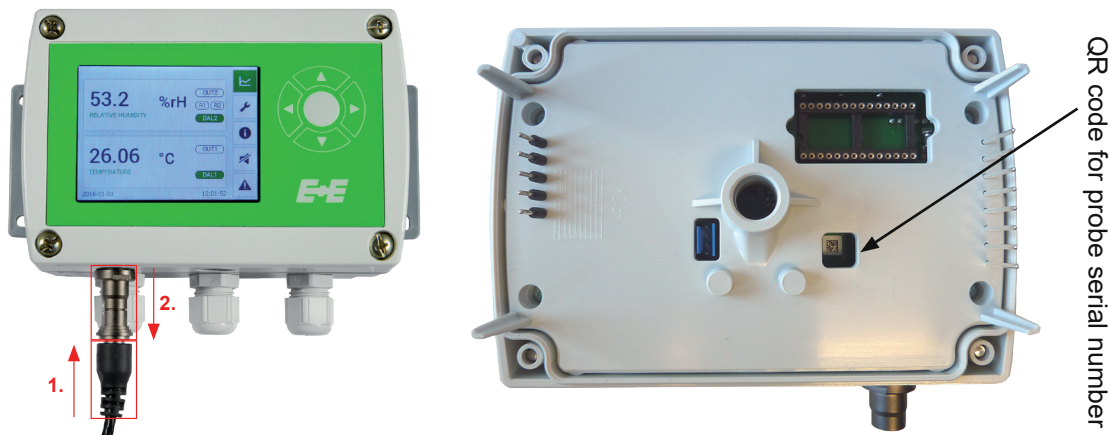

Fig. 22 Pluggable probe

### Probe replacement procedure

- Plug off the damaged probe
- Plug on the new probe
- Update the 7 parameters with EE-PCS Product Configuration Software or via display and push buttons (see chapter 10.2 / Fig. 36).



**Note:** When replacing the probe, the factory calibration loses its validity. A calibration to verify accuracy is recommended but not mandatory.

### Ordering code for replacement probe

Type		PE310	
		T5	T10
Filter	Stainless steel sintered	F4	F4
	PTFE	F5	
	H <sub>2</sub> O <sub>2</sub>	F12	
	stainless steel - metal grid (up to 180 °C / 356 °F)	F9	F9
Cable length (incl. probe length)	2 m (6.6 ft)	K2	K2
	5 m (16.4 ft)	K5	K5
	10 m (32.8 ft)	K10	K10
Probe length	65 mm (2.55")	L65	
	200 mm (7.87")	L200	L200
	400 mm (15.75")	L400	L400
Process connection	1/2" ISO thread		PA23
	1/2" NPT thread		PA25
Optional features	E+E sensor coating		C1

Tab. 1 Ordering code for replacement probe

# 6 Operation

## 6.1 Configuration Interface

The EE310 is ready to use and does not require any configuration by the user. The factory setup of EE310 corresponds to the type number ordered. For ordering guide please see data sheet at [www.epluse.com/EE310](http://www.epluse.com/EE310). If needed, the user can change the factory setup by using a micro USB cable and the EE-PCS, Product configuration Software. The EE310 will be powered by the PC via the USB interface, an addition powered supply is not necessary.

One can change the scaling of the analogue outputs, the settings of the alarm module the digital settings and perform a T and RH adjustment.

In addition, is it possible to enable or disable the NAMUR error indication (factory setting: disabled).

1. Download the EE-PCS Product Configuration Software from [www.epluse.com/configurator](http://www.epluse.com/configurator) and install it on the PC.
2. Connect the E+E device to the PC using the appropriate configuration cable.
3. Start the EE-PCS software.
4. Follow the instructions on the EE-PCS opening page for scanning the ports and identifying the connected device.
5. Click on the desired setup or adjustment mode from the main EE-PCS menu on the left and follow the online instructions of the EE-PCS.

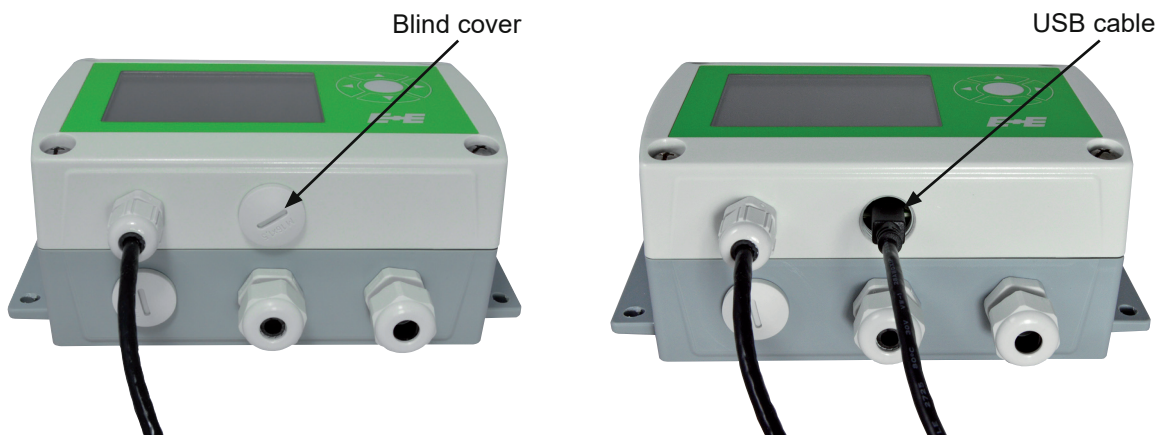

Fig. 23 USB serial interface

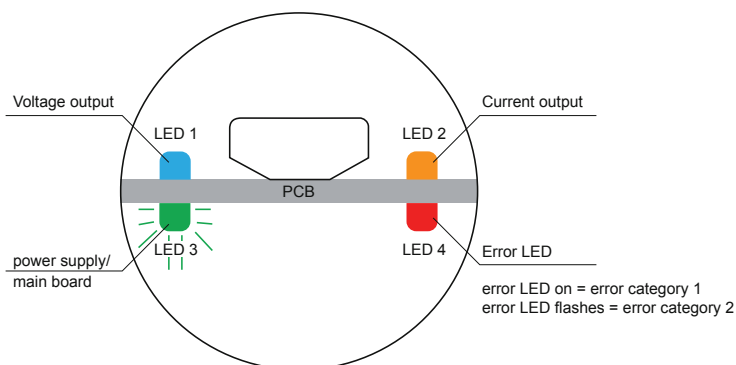

Fig. 24 Status LEDs are located at the USB port



Ensure that the device is only powered by the USB interface during firmware update, otherwise the update may fail.



## 6.2 3.5" TFT Colour Display

The EE310 display includes a data logger and push buttons for full configuration of the device. Upon start-up of an EE310 with display, the data logger and the configuration menu will be initialised during the first 5 seconds.

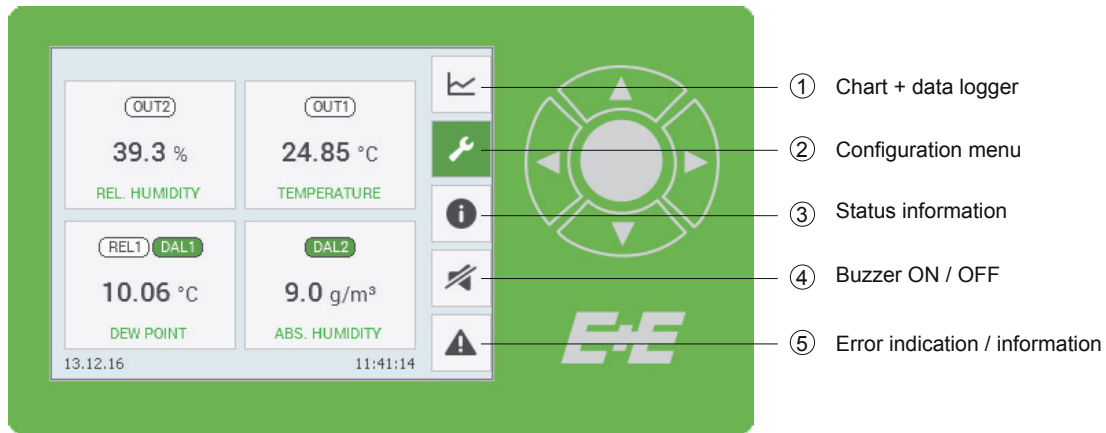

Fig. 25 Display with push buttons

## 6.3 Chart + Data Logger

The TFT display with the integrated data logging function saves all measured and calculated values to the internal memory. The data logger has a real time clock (UTC time) with a battery back-up.



Changing the UTC time erases all stored data.

The data logger can save 20 000 values for each measurand. The logging interval is to be set by the user from 1 second to 12 hours.

The data logger setup can be performed via display and push buttons, see chapter 10.2 / Fig. 32.

The data logger menu is also used to select the logged data to be shown as a graph as well as for scaling the graph, see chapter 10.2 / Fig. 32.

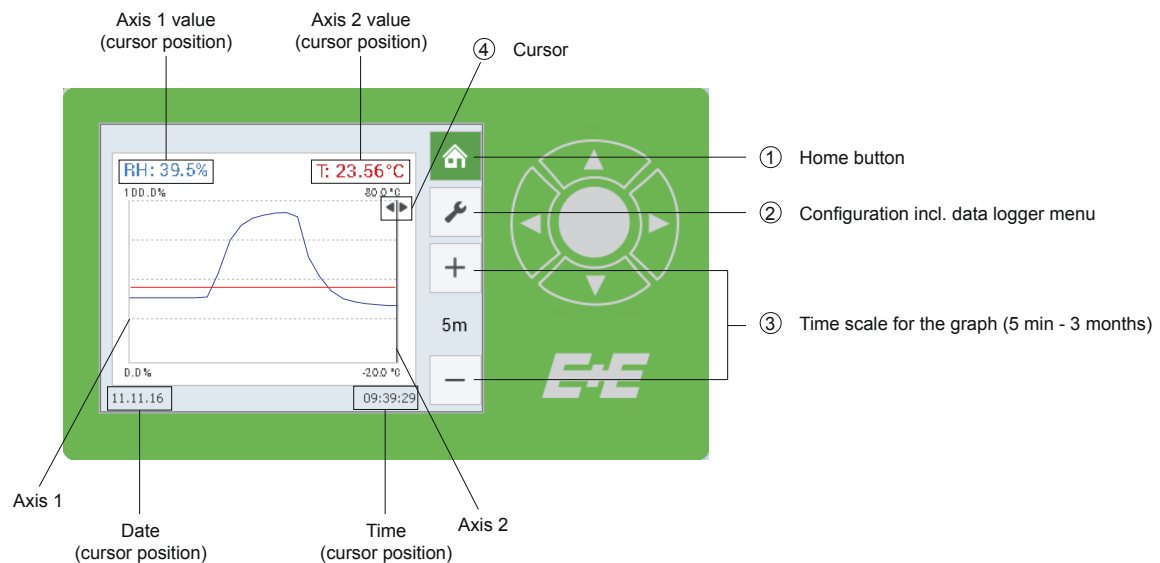

Fig. 26 Data logging

Each point in the graph represents a logged value. The points are connected by a linear interpolation.



The data logging continues even when the data memory is full; new data is stored while the oldest data is deleted (first in first out memory). The last 20 000 logged values are available in the internal memory.

The logged data can be downloaded with EE-PCS Product Configuration Software as .csv file by choosing the measurands and the time period.

## 6.4 Configuration Menu

Detailed information to the configuration menu see chapter 10.

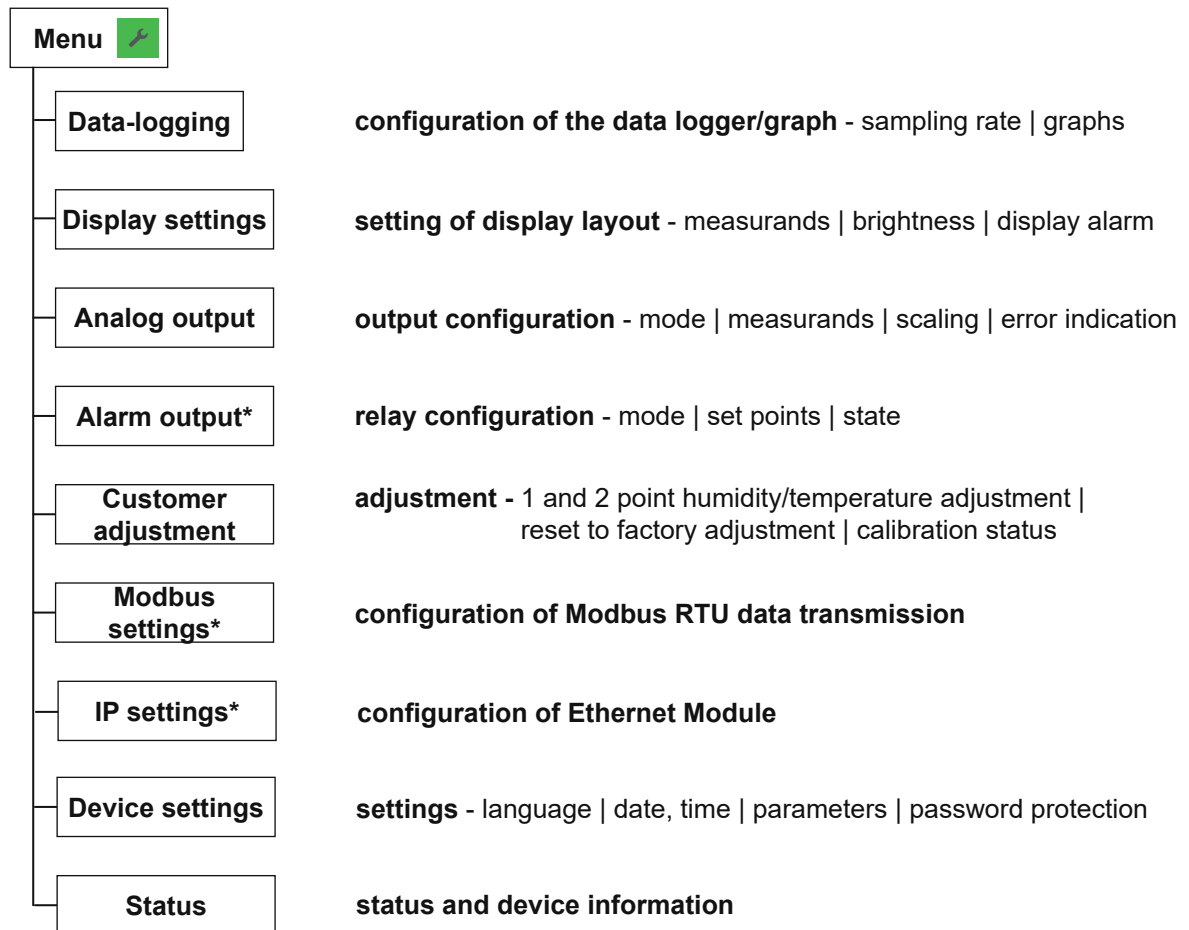

\* Menu only available with the corresponding optional modules.

## 6.5 Status Information

The status information shows all actual EE310 settings.

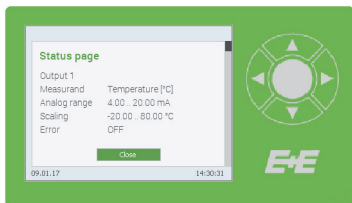

Fig. 27 Status information

## 6.6 Buzzer ON / OFF



## 6.7 Error Indication

When an error occurs, the error indication shows the error code.

# 7 Maintenance

## 7.1 Self Diagnosis and Error Messages

### 7.1.1 Error Messages via Display

Error description	Error code (display)	Error category	Recommended action
Voltage out short circuit - output 1 only*	1.1	1	Check wiring of outputs
Voltage out short circuit - output 2 only*	1.2		
Voltage out short circuit - both outputs*	1.3		
Current loop open - output 1 only	2.1	1	Check wiring of outputs
Current loop open - output 2 only	2.2		
Current loop open - both outputs	2.3		
RH sensor polluted	3.x	1	Cleaning sensor
Hardware error	5.x		
	6.x		
	8.x		
Temperature measurement failure	7.x	2	Return the faulty unit to E+E for service
Humidity measurement failure	9.x		
	10.x		

\* not available with 0 - 1 V output

Tab. 2 Overview of error codes

**Error category 1** = non-critical error, can be solved by the user

- The display blinks and the buzzer beeps every 10 seconds.
- The red status LED lights continuously.

**Error category 2** = critical error, return the device to E+E for service

- The display blinks and the buzzer beeps continuously.
- The red status LED flashes.

### 7.1.2 Error Messages via LEDs

Four status LEDs placed on both sides of a PCB are located close to the USB service interface, under a blind cover.

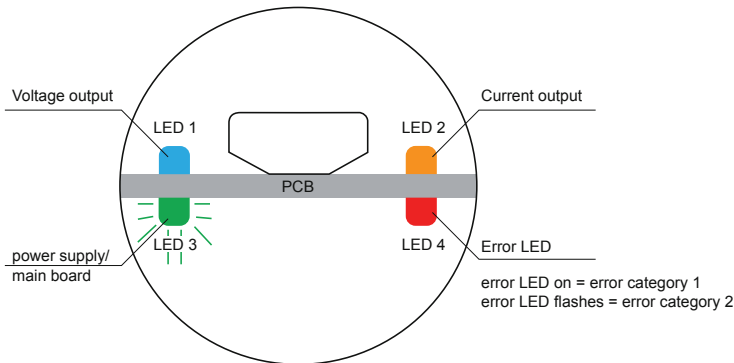

Fig. 28 Status LEDs

**LED 1 (blue):** analogue outputs one set to voltage.

**LED 2 (orange):** analogue outputs one set to current.

**LED 3 (flashing green):** supply voltage applied (microprocessor is active).

**LED 4 (red):** constant lit: error category 1  
flashes: error category 2

### 7.1.3 Solving Typical Problems

Error description	Likely causes and solutions
<b>Display shows incorrect values</b>	Error during re-adjustment of the sensor. → Reset to factory calibration and repeat the adjustment routine.
	Filter polluted → Replace filter
<b>Long response time</b>	Output configured incorrectly → check configuration
	Filter polluted → Replace filter
<b>High humidity values - red LED blinks</b>	Inappropriate filter type → Contact E+E representative for advice.
	Water in sensing head → Investigate the cause for water / condensation. Contact E+E representative for advice.
	Inappropriate filter type → Contact E+E representative for advice.

Tab. 3 Self diagnosis

## 7.2 Cleaning the Sensing Head / Filter Replacement

In case of dusty, oily and polluted environment:

- The filter cap shall be replaced once in a while with an E+E original one. A polluted filter cap causes longer response time of the device.
- If needed, the sensing head can be cleaned. For cleaning instructions please see [www.epluse.com/EE310](http://www.epluse.com/EE310).

## 7.3 RH / T Adjustment and Calibration

### Humidity calibration and adjustment

Depending on the application and the requirements of certain industries, there might arise the need for periodical humidity calibration (comparison with a reference) or adjustment (bringing the device in line with a reference).

### Calibration and adjustment at E+E Elektronik

Calibration and/or adjustment can be performed in the E+E Elektronik calibration laboratory. For information on the E+E capabilities in ISO or accredited calibration please see [www.eplusecal.com](http://www.eplusecal.com).

### Calibration and adjustment by the user

Depending on the level of accuracy required, the humidity reference can be:

- Humidity Calibrator (e.g. Humor 20), please see [www.epluse.com/humor20](http://www.epluse.com/humor20).
- Handheld device (e.g. Omniport30), please see [www.epluse.com/omniport30](http://www.epluse.com/omniport30).
- Humidity calibration Kit (e.g. E+E Humidity Standards), please see [www.epluse.com/EE310](http://www.epluse.com/EE310).

Perform 1 or 2 point adjustment via EE-PCS Product Configuration Software or via display (see below).

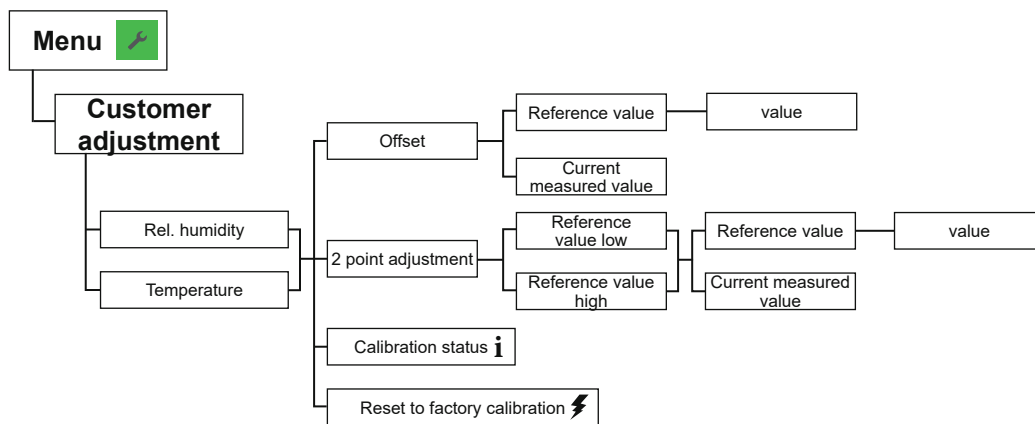

Fig. 29 Adjustment menu

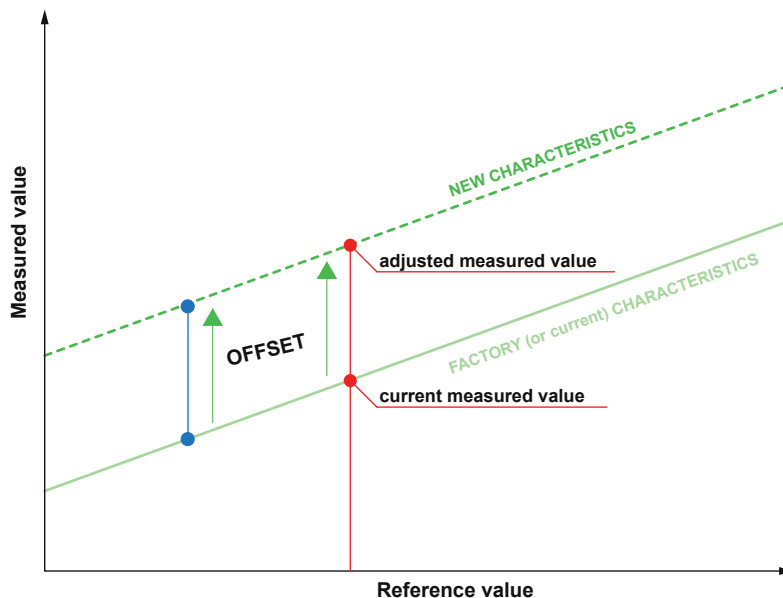

Fig. 30 Offset adjustment

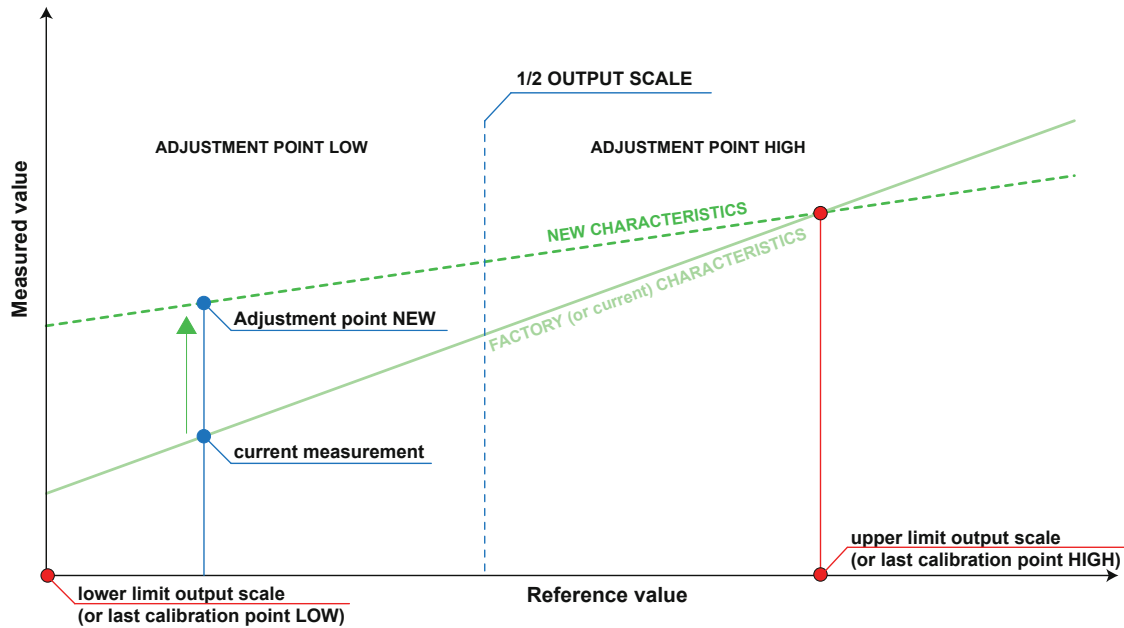

Fig. 31 2 point adjustment procedure

## 8 Replacement Parts / Accessories

### Description

- Filter caps
- Mounting flange stainless steel
- Drip water protection
- RS485 kit for retrofitting
- Ethernet module for retrofitting polycarbonate enclosure
- Bracket for installation onto mounting rails<sup>1)</sup>
- Replacement probes<sup>2)</sup>
- Humidity calibration kit

1) For polycarbonate enclosure only. Two pieces are necessary for each EE310

2) Only for devices with pluggable probe option PC4.

### Order code

- HA0101xx
- HA010201
- HA010503
- HA010605
- HA010606 for remote probe type T5, T10
- HA010607 for duct mounting type T2
- HA010203
- see chapter 5.6
- see data sheet „Humidity calibration kit“

For more details or illustrations refer also to data sheet “Accessories”.

## 9 Technical Data

### Measurands

Relative humidity (RH)	
Working range	0...100 % RH
Accuracy <sup>1)</sup> (incl. hysteresis, non-linearity and repeatability)	
-15...40 °C (5...104 °F) RH ≤90 %	± (1.3 + 0.3 % * mv) % RH
-15...40 °C (5...104 °F) RH >90 %	± 2.3 % RH
<i>value</i>	
-25...70 °C (-13...158 °F)	± (1.4 + 1 % * mv) % RH
-40...180 °C (-40...356 °F)	± (1.5 + 1.5 % * mv) % RH
Temperature dependence of electronics	typ. ± 0.01 % RH/°C (0.0055 %RH / °F)
Response time	< 15 s with metal grid filter at 20 °C (68 °F) / t <sub>90</sub>
Temperature (T)	
Working range sensing probe	
T1, wall:	-40...60 °C (-40...140 °F)
T2, duct:	-40...80 °C (-40...176 °F)
T5, remote:	-40...180 °C (-40...356 °F)
T10, pressure tight:	-40...180 °C (-40...356 °F)
T24, T only remote probe:	-40...180 °C (-40...356 °F) or -80...30 °C (-112...86 °F)

Accuracy<sup>1)</sup>

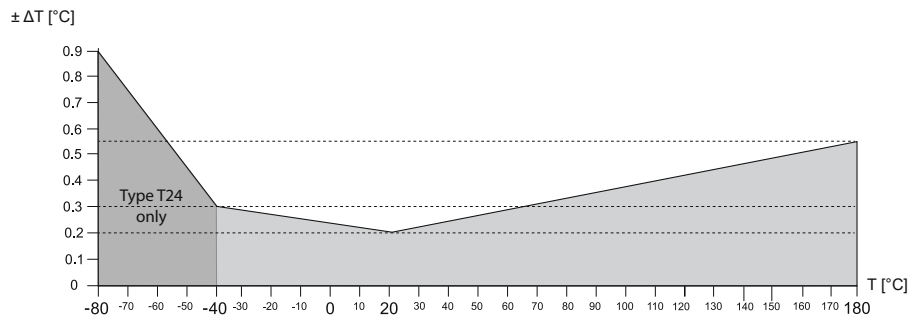

Temperature dependence of electronics, typ.  $\pm 0.001^\circ\text{C}/^\circ\text{C}$

### Calculated parameters

	from		EE310-T1	up to	EE310-T2	EE310-T5, T10	unit
Dew point temperature	Td	-40 (-40)	60 (140)	80 (176)	100 (212)	°C (°F)	
Frost point temperature	Tf	-40 (-40)	0 (32)	0 (32)	0 (32)	°C (°F)	
Wet bulb temperature	Tw	0 (32)	60 (140)	80 (176)	100 (212)	°C (°F)	
Water vapour partial pressure	e	0 (0)	200 (3)	500 (7.5)	1100 (15)	mbar (psi)	
Mixing ratio	r	0 (0)	425 (2900)	999 (9999)	999 (9999)	g/kg (gr/lb)	
Absolute humidity	dv	0 (0)	150 (60)	300 (120)	700 (300)	g/m <sup>3</sup> (gr/f <sup>3</sup> )	
Specific enthalpy	h	0 (0)	400 (50000)	1000 (375000)	2800 (999999)	kJ/kg (Btu/lb)	

### Outputs

Two analogue outputs  
freely selectable and scalable

0 - 1 / 5 / 10 V      -1 mA < I<sub>L</sub> < 1 mA  
4 - 20 mA      3-wire      R<sub>L</sub> < 500 Ohm  
0 - 20 mA      3 wire      R<sub>L</sub> < 500 Ohm

Digital interface / protocol      option J3      RS485 / Modbus RTU (EE310 = 1 unit load)  
Factory settings: 9600 bps, parity even, stop bit 1 / Modbus

address 231

option J4      Ethernet-PoE with Modbus TCP

### General

Power supply class III  $\diamond$  (EU) / class 2 (NA)      8 - 35 V DC      12 - 30 V AC  
100 - 240 V AC, 50/60 Hz with option AM3<sup>2)</sup>

Current consumption at 24 V DC/AC (typ.)      15 mA / 40 mA<sub>rms</sub> for 2 voltage outputs  
35 mA / 100 mA<sub>rms</sub> for 2 current outputs  
50 mA / 150 mA<sub>rms</sub> additional for display  
30mA / 90 mA<sub>rms</sub> additional for Ethernet

Pressure range for pressure tight probe      0.01...20 bar (0.15...300 psi)

Probe material      Stainless steel 1.4404 / AISI 316L

Enclosure material      Polycarbonate, UL94-V0 approved or  
Stainless steel 1.4404 / AISI 316 L

Protection rating      IP65 / NEMA 4

Cable glands      for polycarbonate enclosure      M16 x 1.5, for cable Ø 3 - 7 mm (0.12 - 0.28")  
for metal enclosure      M16 x 1.5, for cable Ø 4.5 - 10 mm (0.18 - 0.39")

Electrical connection      Screw terminals max. 1.5 mm<sup>2</sup> (AWG 16)

Working and storage temperature range of electronics      -40...60 °C (-40...140 °F) without display  
-20...50 °C (-4...122 °F) with display

Electromagnetic compatibility      EN 61326-1      EN 61326-2-3      ICES-003 ClassA  
Industrial Environment      FCC Part15 ClassA



Two alarm outputs<sup>2)</sup>      Changeover contact  
250 V AC / 6 A      28 V DC / 6 A

System requirements for EE-PCS software      Windows XP or higher; USB port

1) Traceable to international standards, administrated by NIST, PTB, BEV, ...  
The accuracy statement includes the uncertainty of the factory calibration with an enhancement factor k=2 (2-times standard deviation).  
The accuracy was calculated in accordance with EA-4/02 and with regard to GUM (Guide to the Expression of Uncertainty in Measurement).  
For model T1 the accuracy data is valid only for air speed higher than 0.2m/s.  
2) Appropriate for outdoor use, wet location, degree of pollution 2, overvoltage category II, altitude up to 3000 m (9843 ft).

# 10 Appendix

## 10.1 Overview

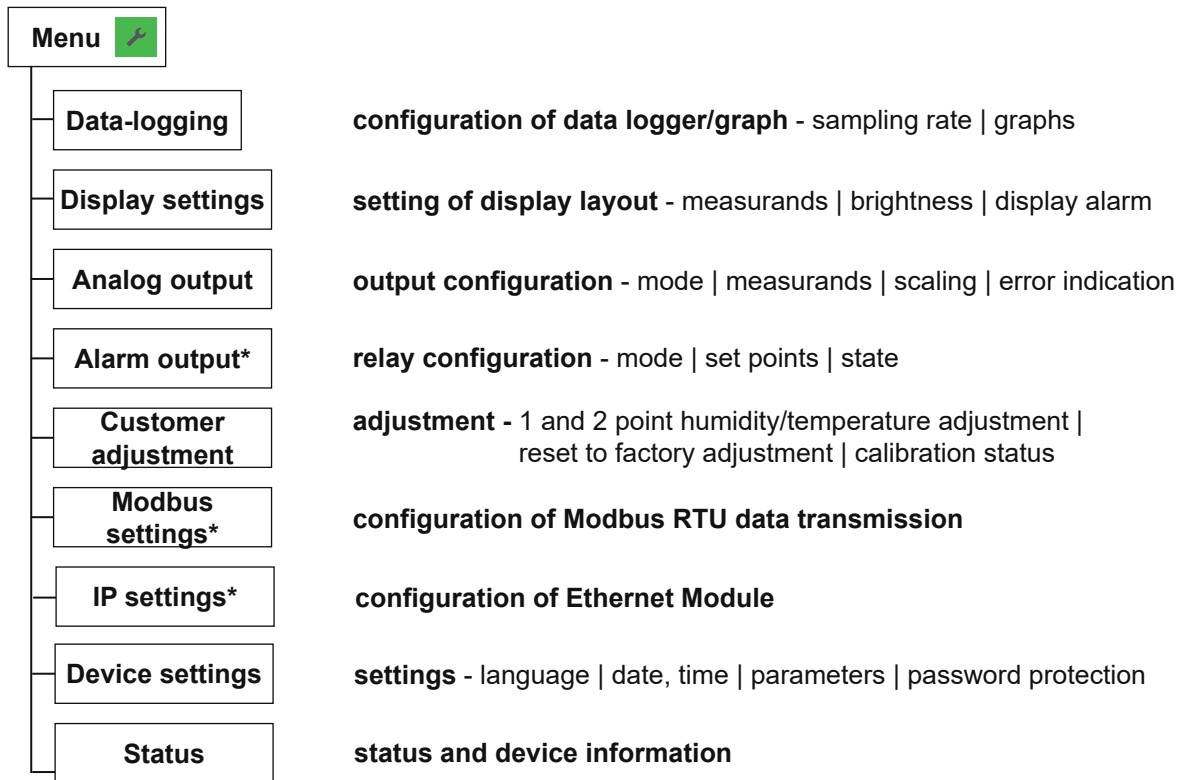

\* Menu only available with connected modules.

## 10.2 Detailed Information

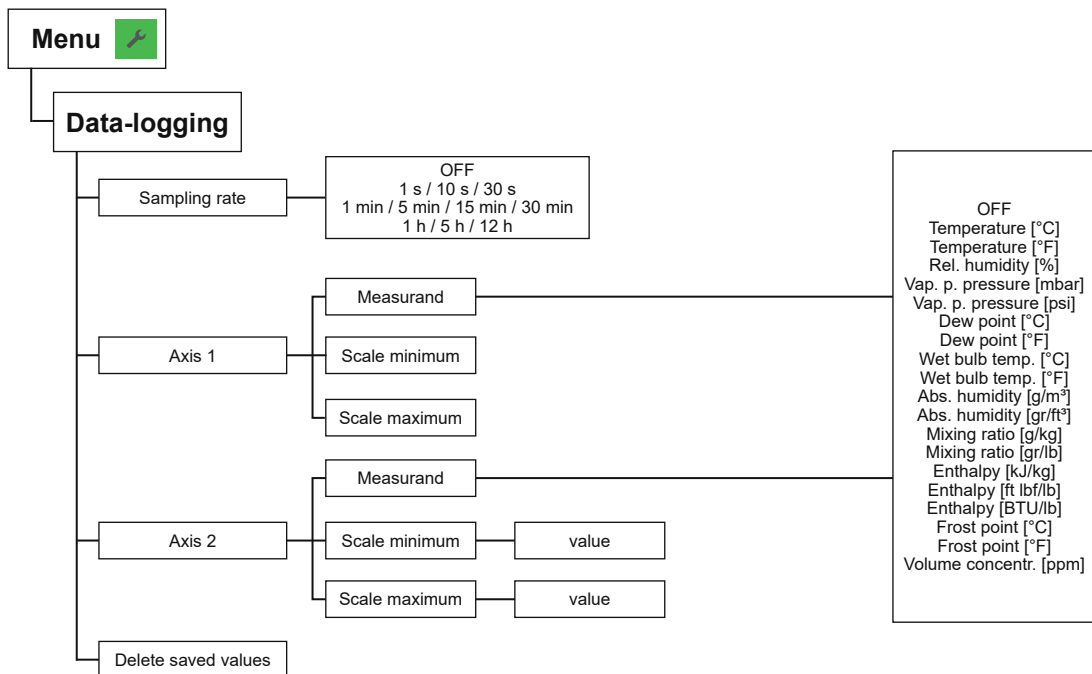

Fig. 32 Data logging



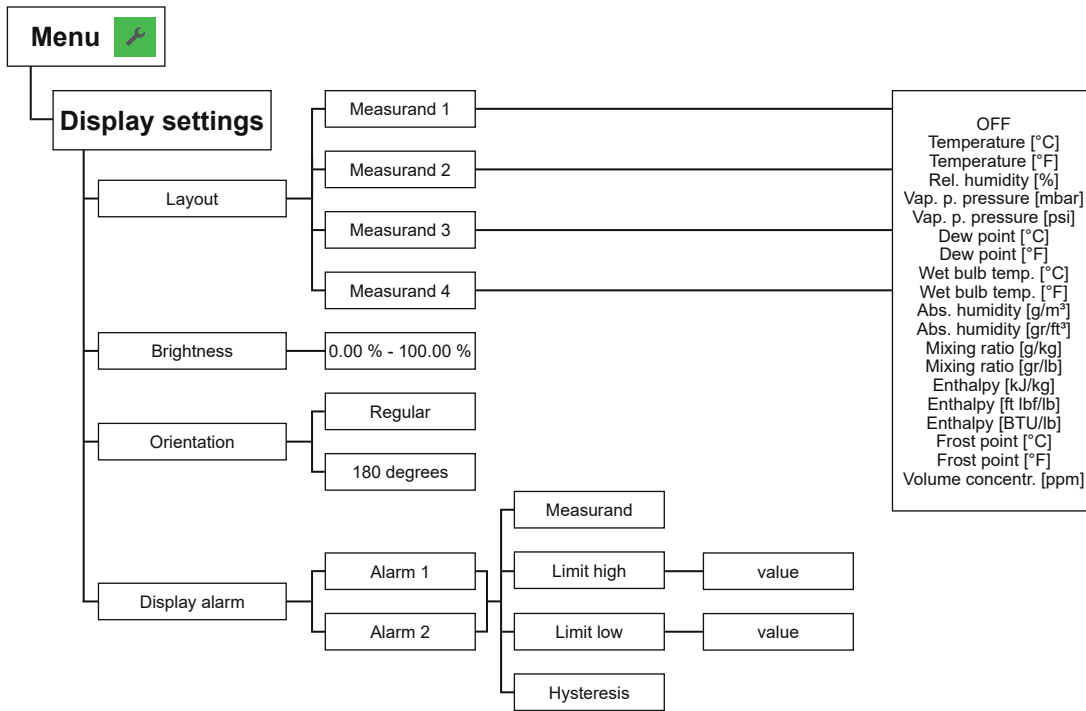

Fig. 33 Display settings

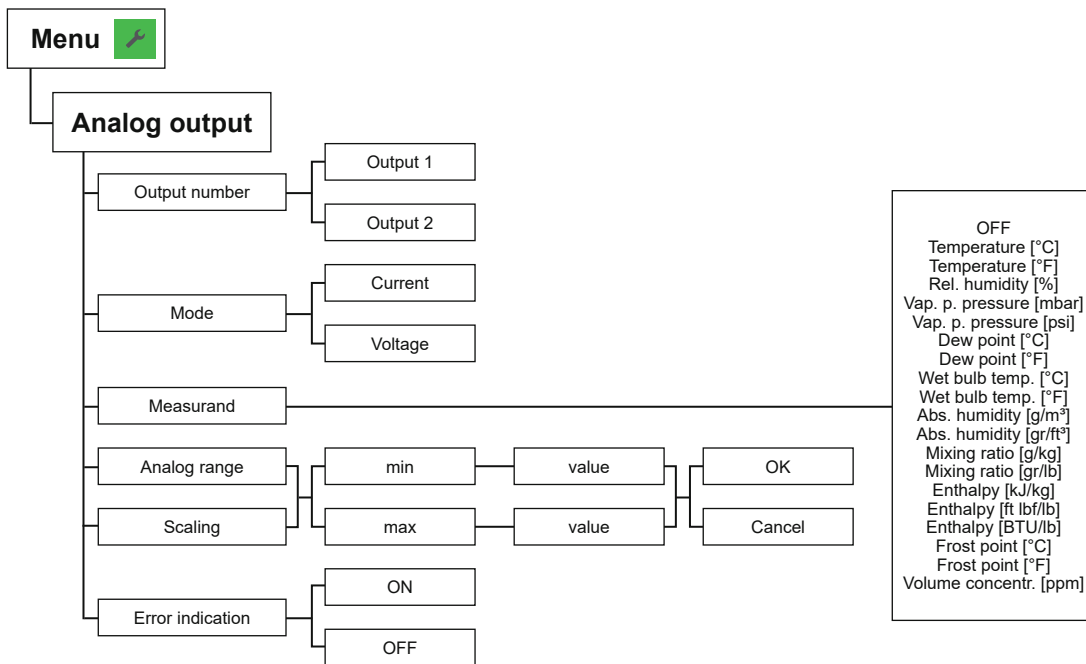

Fig. 34 Analogue output

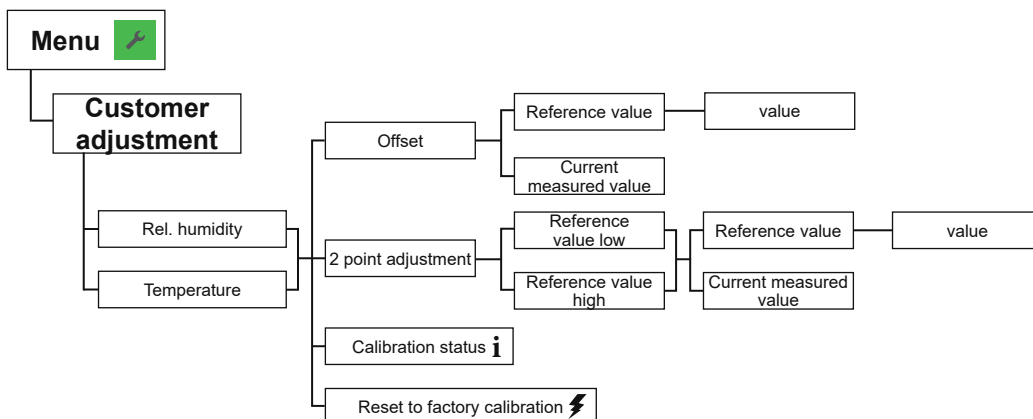
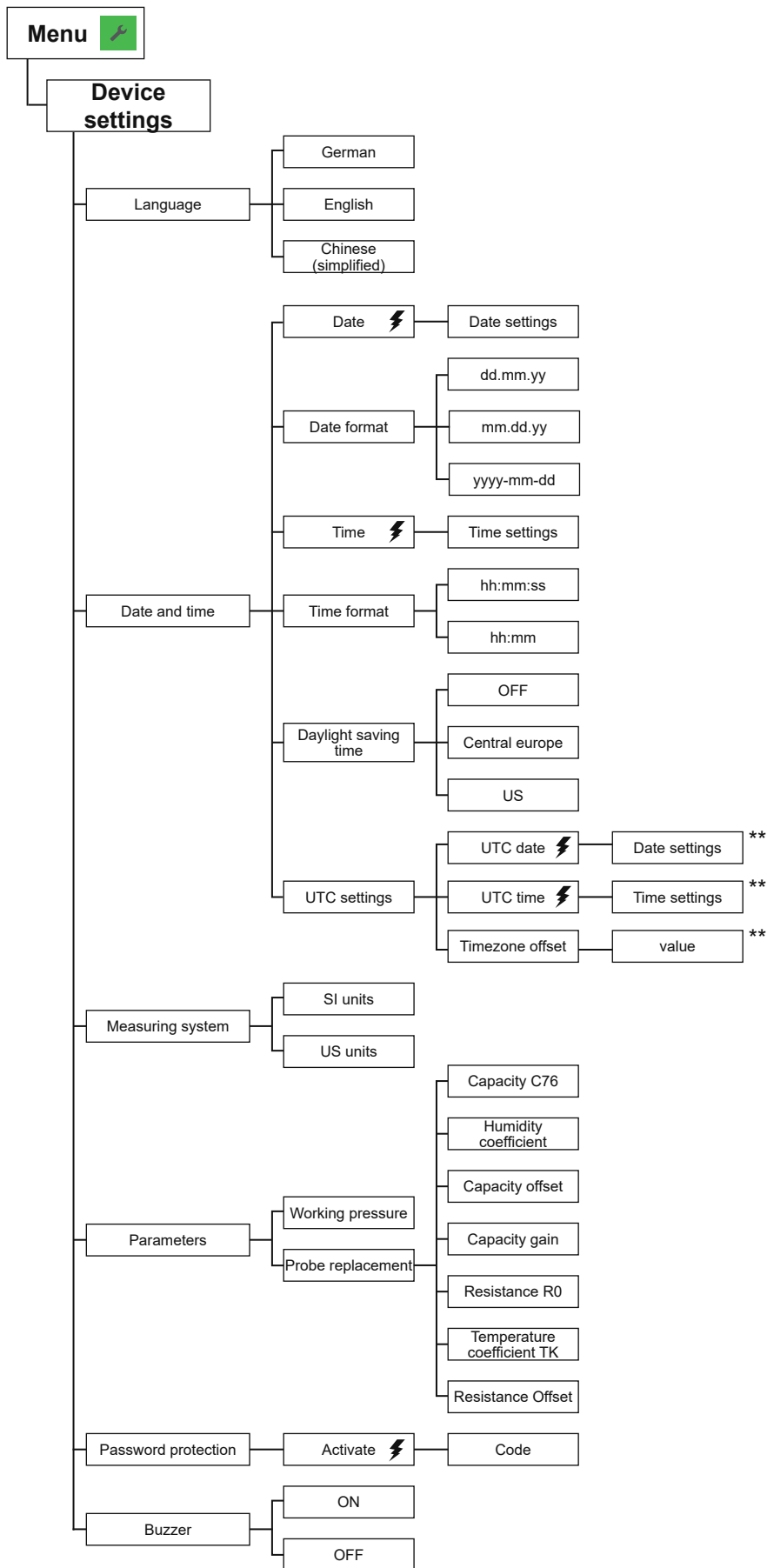

Fig. 35 Customer adjustment



\*\* changing the UTC time will delete measurement data!

Fig. 36 Device settings

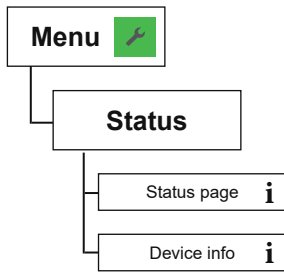
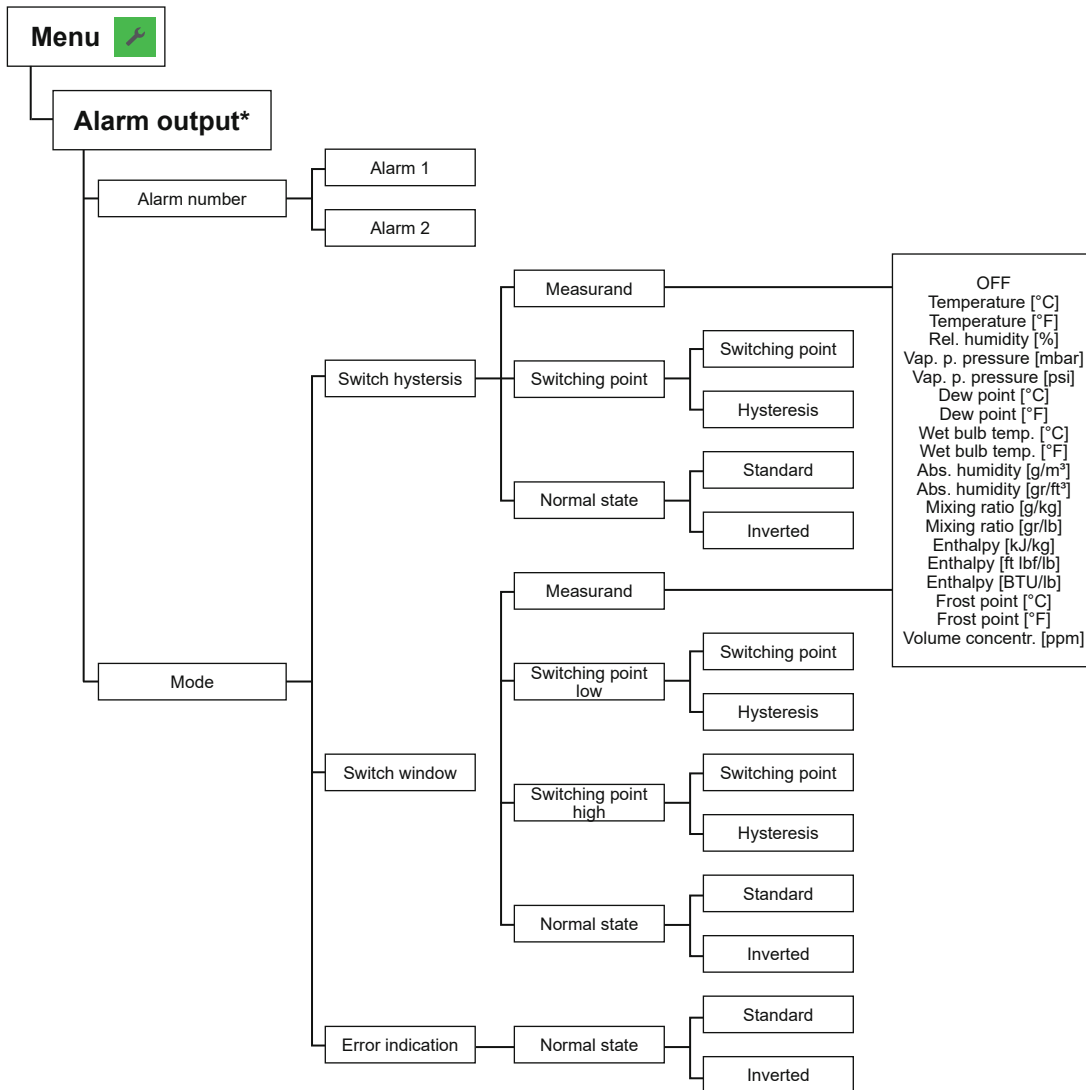

Fig. 37 Status

## 10.3 Optional Menu

(only available with plugged in modules during the start up procedure)



\* Menu only available with connected alarm module during EE310 start-up

Fig. 38 Alarm output

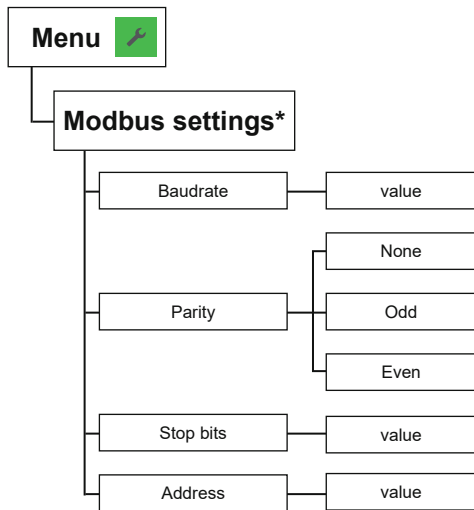

\* Menu only available with connected Modbus RTU module during EE310 start-up.

Fig. 39 Modbus settings

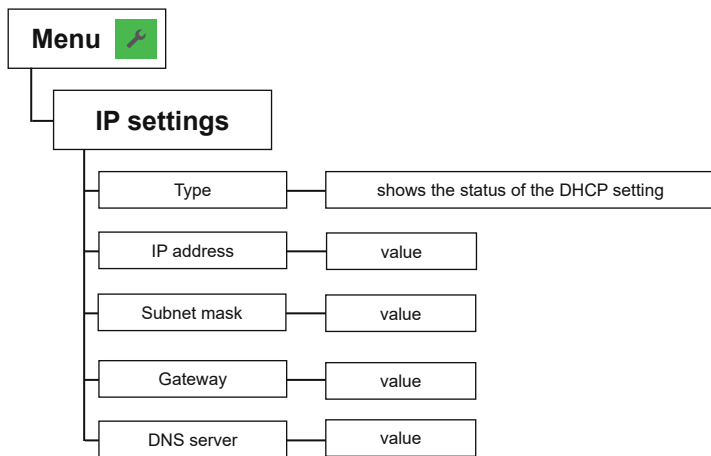

Fig. 40 IP settings





#### HEADQUARTERS

##### **E+E Elektronik Ges.m.b.H.**

Langwiesen 7  
4209 Engerwitzdorf  
Austria  
Tel.: +43 7235 605-0  
E-mail: [info@epluse.com](mailto:info@epluse.com)  
Web: [www.epluse.com](http://www.epluse.com)

#### SUBSIDIARIES

##### **E+E Elektronik China**

18F, Kaidi Financial Building,  
No.1088 XiangYin Road  
200433 Shanghai  
Tel.: +86 21 6117 6129  
E-mail: [info@epluse.cn](mailto:info@epluse.cn)

##### **E+E Elektronik France**

Le Norly III, 136 chemin du  
Moulin  
69130 Ecully  
Tel.: +33 4 74 72 35 82  
E-mail: [info@epluse.fr](mailto:info@epluse.fr)

##### **E+E Elektronik Germany**

Schöne Aussicht 8 C  
61348 Bad Homburg  
Tel.: +49 6172 13881-0  
E-mail: [info@epluse.de](mailto:info@epluse.de)

##### **E+E Elektronik Italy**

Via Alghero 17/19  
20128 Milano (MI)  
Tel.: +39 02 2707 86 36  
E-mail: [info@epluse.it](mailto:info@epluse.it)

##### **E+E Elektronik Korea**

Suite 2001, Heungdeok IT  
Valley Towerdong, 13,  
Heungdeok 1-ro, Giheung-gu  
16954 Yongin-si, Gyeonggi-do  
Tel.: +82 31 732 6050  
E-mail: [info@epluse.co.kr](mailto:info@epluse.co.kr)

##### **E+E Elektronik USA**

333 East State Parkway  
Schaumburg, IL 60173  
Tel.: +1 847 490 0520  
E-mail: [office@epluse.com](mailto:office@epluse.com)

YOUR PARTNER IN SENSOR TECHNOLOGY



**ELEKTRONIK®**  
Ges.m.b.H.