

Data Sheet

E2G Pressure Transducer

FEATURES

- Ranges vac through 20,000 psi
- IP66/67 Ingress rating
- Wide selection of electrical & process connections available
- Customizable configurations
- External magnetic offset & span adjustment

TYPICAL USES

- Off-Road equipment
- Construction machinery
- HVAC/Refrigeration
- Compressor control
- Pump monitoring
- Agricultural equipment
- Diagnostic kits
- Engine monitoring
- Process automation & controls
- Hydraulic & pneumatic sensing



E2G
Pressure Transducer



PERFORMANCE SPECIFICATIONS

Reference Temperature:	21°C ±2°C
Static Accuracy:	±0.25% of span, ±0.50% of span, ±1.0% of span, (0-1.5# Range only available in ±0.5% and 1.0% accuracy) Terminal Point Method includes: hysteresis, linearity, repeatability, offset and span
Stability:	±0.25% year at reference conditions

ENVIRONMENTAL SPECIFICATIONS

Thermal Coefficients:	Offset: ±0.009% /°C from -40°C to 125°C Span: ±0.009% /°C from -40°C to 125°C
Temperature Limits:	Storage: -58°F to 257°F (-50°C to 125°C) Operating: -40°F to 257°F (-40°C to 125°C) Media: -40°F to 257°F (-40°C to 125°C)
Humidity:	0-100% (non-condensing)

FUNCTIONAL SPECIFICATIONS

Response Time (Output)	4 ms
Gauge/Compound Pressure Ranges:	VAC to 20,000 psig
Shock:	80g, 6 ms, Haversine
Vibration:	Random: 10g RMS 20-2000 Hz
Absolute Pressure Ranges:	0 to 500 psia
Proof Pressure:	1.2× - 2× (See Table 1 on page 2)
Burst Pressure:	3× - 8× (See Table 1 on page 2)

KEY BENEFITS

- Highly configurable
- Easy calibration of offset and span

ELECTRICAL SPECIFICATIONS

Circuit Protection:	Reverse polarity protected
Output Signal:	Supply Voltage: (unregulated)
	Min. Max:
0-5 Vdc (3 Wire)	9 Vdc 36 Vdc
1-5 Vdc (3 Wire)	9 Vdc 36 Vdc
1-6 Vdc (3 Wire)	9 Vdc 36 Vdc
0-10 Vdc (3 Wire)	14 Vdc 36 Vdc
1-11 Vdc (3 Wire)	14 Vdc 36 Vdc
0.1-5 Vdc (3 Wire)	9 Vdc 36 Vdc
0.1-10 Vdc (3 Wire)	14 Vdc 36 Vdc
0.5-4.5 Vdc (3 Wire)	9 Vdc 36 Vdc
4-20 mA (2 Wire)	9 Vdc 36 Vdc
20-4 mA (2 Wire)	9 Vdc 36 Vdc
Adjustability:	±5% of span non-interactive offset & span
Supply Current:	<8 mA (Vout)
Current Source/Sink for Voltage Output	1 mA (source)/ 0.1 mA (sink) MAX.
Withstand/Breakdown	100 Vdc/Vac, optional 500 Vdc/Vac

Data Sheet

E2G Pressure Transducer

PHYSICAL SPECIFICATIONS

Ingress Rating: IP66 (NEMA 4X) (STD.)
IP67 (IP69K Consult Factory)

WETTED MATERIAL

Diaphragm:	Sensor:	Material:
	A	17-4PH Stainless steel
	B	316L Stainless steel
	C	316L Stainless steel, liquid isolated
	D	A286

Process Connection: 316L Stainless steel

NON-WETTED MATERIAL

Housing: 316L Stainless steel

EMC TESTING

EMC: Directive 2014/30/EU, and EN61326-1, EN61326-2-3 (Industrial Env.)

Immunity:	Standard	Level
	61000-4-2 (ESD)	±4kV/±8kV (Contact/Air)
	61000-4-3 (Radiated RF)	10 V/m to 1GHZ, 3 V/m to 2GHZ, 1 V/m to 2.7GHZ
	61000-4-4 (EFT/Burst)	±1kV (5/50ns, 5kHz)
	61000-4-5 (Surge)	±1kV, Earth to Shield over all I/O lines
	61000-4-6 (Conducted RF)	3V/ (0.15 to 80MHz)
	61000-4-8 (Line Freq. Magnetic)	30A/m

Emissions: EN 55011 (CISPR 11) Class A, Group 1 & FCC (47 CFR 15)

TABLE 1: PROOF & BURST PRESSURE MULTIPLIERS

Sensor Range	A Sensor - 17-4PH SS		B Sensor - 316 LSS		Sensor C - 316L SS ISO		Sensor D - A286	
	Proof	Burst	Proof	Burst	Proof	Burst	Proof	Burst
(psi)								
1.5					2X	5X		
5					3x	5x		
10					2x	5x		
15					2x	5x		
30					2x	5x		
45	2x	8x	1.5x	8x	2x	5x		
50	2x	8x	1.5x	8x	2x	5x		
60	2x	8x	1.5x	8x	2x	5x		
75	2x	8x	1.5x	8x	2x	5x		
100	2x	8x	1.5x	8x	2x	5x		
150	2x	8x	1.5x	8x	2x	4x		
200	2x	8x	1.5x	8x	2x	3x		
300	2x	8x	1.5x	8x	2x	3x		
500	2x	8x	1.2x	5x	3x	4x		
750	2x	8x	1.2x	5x				
1000	2x	8x	1.2x	5x				
1500	2x	8x	1.2x	5x				
2000	2x	8x	1.2x	5x				
3000	2x	5x	1.2x	5x				
5000	1.5x	5x	1.2x	5x			1.5x	5x
7500	1.5x	3x					1.5x	5x
10000	1.2x	3x					1.2x	5x
15000	1.2x	3x					1.2x	5x
20000	1.2x	3x					1.2x	5x
(Compound)								
VAC#					2x	5x		
V&15#					2x	5x		
V&30#					2x	5x		
V&45#	2x	8x	1.5x	8x				
V&60#	2x	8x	1.5x	8x	2x	5x		
V&100#	2x	8x	1.5x	8x				
V&150#	2x	8x	1.5x	8x	2x	4x		
V&200#	2x	8x	1.5x	8x				
V&300#	2x	8x	1.5x	8x	2x	3x		
(psia)								
15					2x	5x		
30					2x	5x		
70					2x	5x		
150					2x	4x		
300					2x	3x		
500					2x	3x		

Data Sheet

E2G Pressure Transducer

ORDERING CODE	Example:	E2G	B	3	C	F02	42	CC	X	10	F	100#	-XNH
Model													
E2G - General Purpose		E2G											
Sensor Materials - See Table 2 on page 4 for more options													
A - 17-4PH Stainless steel													
B - 316L Stainless steel			B										
C - 316L Stainless steel (liquid isolated)													
D - A286													
Accuracy													
3 - 0.25% span (not available with 1.5 psi range)				3									
5 - 0.50% span													
7 - 1.00% span													
Calibration Chart													
N - Without calibration chart													
C - With calibration chart					C								
Pressure Connections - See Table 3 on page 5 for more options													
F02 - (¼ NPT Female)						F02							
Output Type													
05 - 0-5 Vdc													
10 - 0-10 Vdc													
11 - 1-11 Vdc													
12 - 1-10 Vdc													
13 - 0.1-5 Vdc													
15 - 1-5 Vdc													
16 - 1-6 Vdc													
42 - 4-20 mA							42						
45 - 0.5-4.5 Vdc non-ratiometric													
00 - Custom													
Electrical Connections - See Table 4 on page 6 for more options													
CC - (½ NPT conduit w/cable)								CC					
Mating Connector													
M - With mating connector													
X - Without mating connector									X				
Cable Length													
Max cable length of 30ft for outputs 05, 10, 11, 12, 13, 15, 16 and 45. Max cable length of 99ft for outputs 24 and 42													
00 - No cable													
XX - 01 to 99										10			
Unit of Length													
F - Feet											F		
M - Meter													
N - Inches													
0 - No cable													
Pressure Ranges - Coding example only, see Table 5 on page 7 for more options													
100# - 100 psig												100#	
Options (if choosing an option(s) must include an "X")													-X__
NN - Paper tag													
NH - Stainless steel tag													NH

Accessory	Part Number
Offset and Span Adjustment Magnet	266A143-01
Accessories must be ordered separately	

Data Sheet

E2G Pressure Transducer

TABLE 2 - SENSOR PRESSURE RANGE

psi	Sensor Material				bar	Sensor Material				inHg	Sensor Material			
	A 17-PH SS	B 316L SS	C 316 ISO	D A286		A 17-PH SS	B 316L SS	C 316 ISO	D A286		A 17-PH SS	B 316L SS	C 316 ISO	D A286
1.5#			•											
5#			•		400MB			•		10IM		•		
10#			•		600MB			•		20IM		•		
15#			•		1BR			•		30IM		•		
30#	•	•	•		1.6BR			•		50IM		•		
45#	•	•	•		2BR			•		100IM	•	•	•	
50#	•	•	•		2.5BR	•	•	•		200IM	•	•	•	
60#	•	•	•		4BR	•	•	•		300IM	•	•	•	
75#	•	•	•		6BR	•	•	•		500IM	•	•	•	
100#	•	•	•		10BR	•	•	•		1000IM	•	•		
150#	•	•	•		16BR	•	•	•		VACIM			•	
200#	•	•	•		20BR	•	•	•		V&30IM			•	
250#	•	•	•		25BR	•	•	•		V&60IM			•	
300#	•	•	•		40BR	•	•	•		V&100IM	•	•	•	
500#	•	•	•		60BR	•	•	•		V&200IM	•	•	•	
750#	•	•			100BR	•	•			30IMA			•	
1000#	•	•			160BR	•	•			50IMA			•	
1500#	•	•			200BR	•	•			100IMA			•	
2000#	•	•			250BR	•			•	200IMA			•	
2500#	•	•			400BR	•			•	300IMA			•	
3000#	•	•			600BR	•			•	500IMA			•	
5000#	•	•		•	1000BR	•				1000IMA			•	
7500#	•			•	VACBR			•						
10000#	•			•	V&1BR			•						
15000#	•			•	V&1.6BR			•						
20000#	•			•	V&2BR			•						
VAC#			•		V&4BR	•	•	•						
V&15#	•		•		V&6BR	•	•	•						
V&30#	•		•		1BRA			•						
V&45#	•	•	•		1.6BRA			•						
V&60#	•	•	•		2BRA			•						
V&100#	•	•	•		2.5BRA			•						
V&150#	•	•	•		4BRA			•						
V&200#	•	•	•		6BRA			•						
V&300#	•	•	•		10BRA			•						
15#A			•		16BRA			•						
30#A			•		20BRA			•						
50#A			•											
100#A			•											
120#A			•											
300#A			•											

E2G Pressure Transducer

TABLE 3 - PRESSURE CONNECTION DIMENSIONS

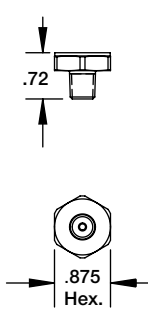
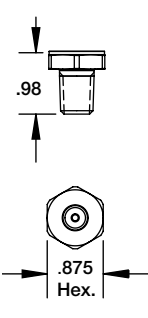
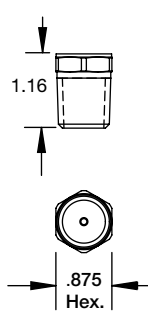
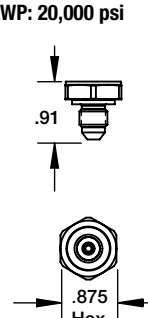
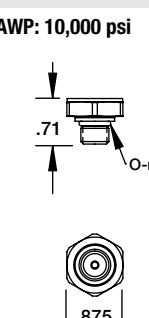
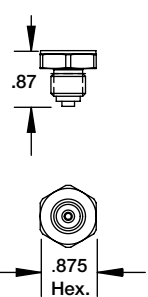
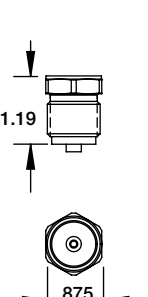
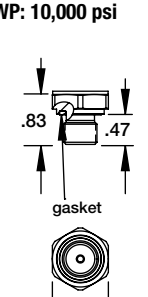
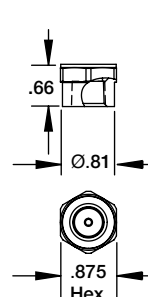
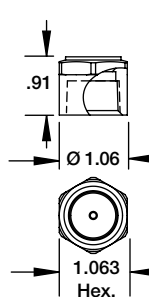
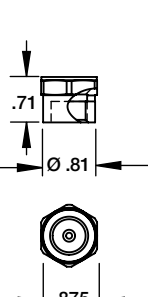
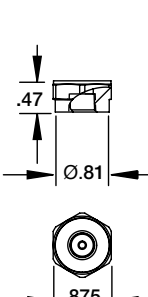
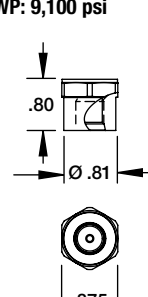
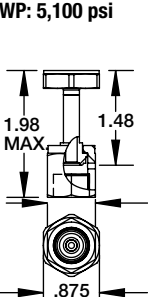
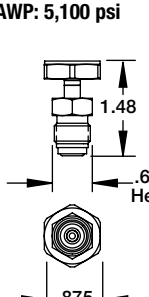
<p>1/8 NPT Male Code: M01 MAWP: 20,000 psi</p>	<p>1/4 NPT Male Code: M02 MAWP: 20,000 psi</p>	<p>1/2 NPT Male Code: M04 MAWP: 10,000 psi</p>	<p>7/16-20 UNJF-3A 37° Flare (SAE AS4395) Code: M76 MAWP: 20,000 psi</p>	<p>7/16-20 UNJF-2A SAE-Male (SAE J1926 O-Ring Boss seal) Code: MEK MAWP: 10,000 psi</p>
				
<p>G1/4 B-Male (EN837-1) Code: MG2 MAWP: 20,000 psi</p>	<p>G1/2 B Male (EN837-1) Code: MG4 MAWP: 20,000 psi</p>	<p>G1/4 A-MALE (stud end DIN 3852-E G1/4) Code: MGA MAWP: 10,000 psi</p>	<p>1/4-18 NPT Female Code: F02 MAWP: 10,000 psi</p>	<p>1/2-14 NPT Female Code: F04 MAWP: 5,000 psi</p>
				
<p>9/16-18 UNF-2B Female Code: F09 MAWP: 25,000 psi</p>	<p>1/8 -27 NPT Female Code: F01 MAWP: 10,000 psi</p>	<p>7/16-20 UNF-2B SAEJ1926 Code: FRW MAWP: 9,100 psi</p>	<p>1/4" VCR gland with 9/16-18 Female Swivel Nut Code: FV2 MAWP: 5,100 psi</p>	<p>1/4" VCR gland with 9/16-18 Male Swivel Nut Code: MV2 MAWP: 5,100 psi</p>
				

Data Sheet

E2G Pressure Transducer

TABLE 4 - ELECTRICAL CONNECTION DIMENSIONS

Maximum temperature range listed

Metri Pack 3-Pin

Code: GN – IP67 (NEMA 4X)

-40°F to 185°F (-40°C to 85°C)

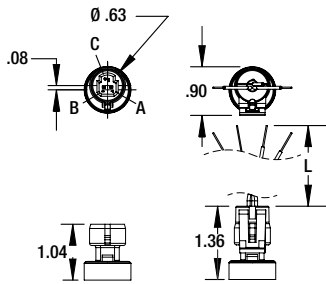

AMP Superseal 3-Pin

Code: AP – IP66 (NEMA 4X)

-40°F to 185°F (-40°C to 85°C)

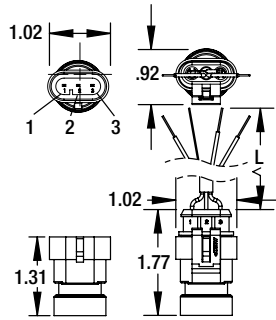

Over-Mold Cable

Code: FC, FV* – IP67 (NEMA 4X)

-40°F to 185°F (-40°C to 85°C)

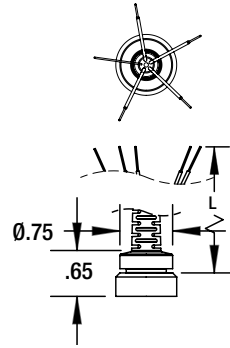

M12 4-Pin

Code: EW – IP66 (NEMA 4X)

-40°F to 185°F (-40°C to 85°C)

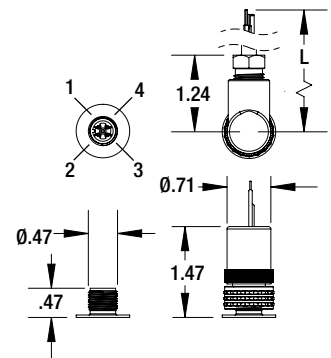

DEUTSCH DT04 3-Pin

Code: DT – IP66 (NEMA 4X)

-40°F to 185°F (-40°C to 85°C)

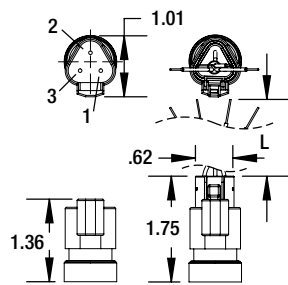

Hirschmann EN 175301-803 Form A

Code: DA – IP66 (NEMA 4X)

-40°F to 185°F (-40°C to 85°C)

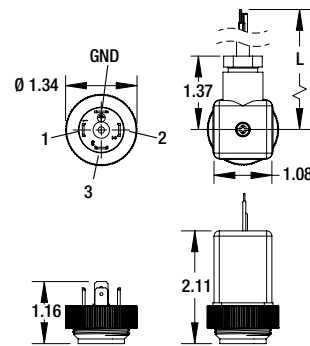

Mini-Hirschmann

Code: HM – IP66 (NEMA 4X)

-40°F to 185°F (-40°C to 85°C)

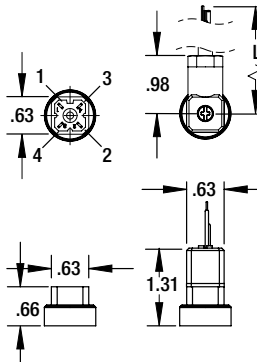

MIL DTL 26482 8 4-Pin

Code: B4 – No IP or NEMA rating

-40°F to 221°F (-25°C to 105°C)

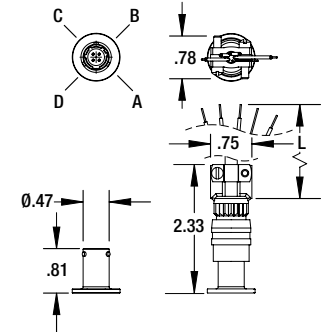

Hirschmann EN 175301-803 Form C

Code: DC
IP66 (NEMA 4X)

-40°F to 185°F (-40°C to 85°C)

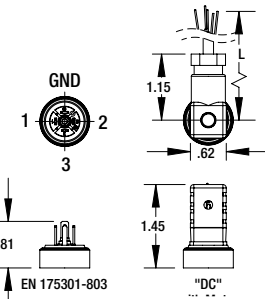

M20 Conduit With Cable

Code: MC, MV*
IP67 (NEMA 4X)

-40°F to 257°F (-40°C to 125°C)

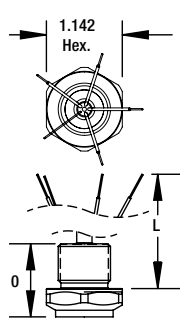

1/2" NPT Conduit With Cable

Code: CC, CV*
IP67 (NEMA 4X)

-40°F to 257°F (-40°C to 125°C)

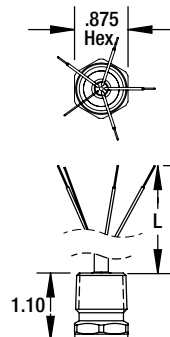

1/2" NPT Conduit With Flying Leads

Code: CF
IP67 (NEMA 4X)

-40°F to 257°F (-40°C to 125°C)

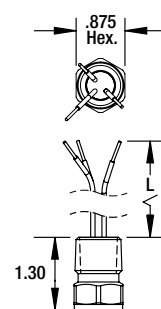

M20 Conduit With Flying Leads

Code: MF
IP67 (NEMA 4X)

-40°F to 257°F (-40°C to 125°C)

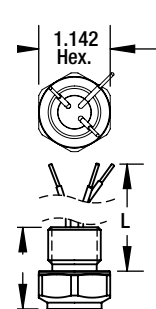

Note: * Indicates Vented Cable

Data Sheet

E2G Pressure Transducer

TABLE 5 - PRESSURE RANGES

Vac.	PSI	bar	inHg
Compound	VAC#	VACBR	VACIM
	V&15#	V&1BR	V&30IM
	—	V&1.6BR	—
	V&30#	V&2BR	V&60IM
	V&45#	—	V&100IM
	V&60#	V&4BR	—
	—	V&6BR	—
	V&100#	—	V&200IM
	V&150#	—	—
	V&200#	—	—
Positive Pressure (psig)	V&300#	—	—
	1.5#	105MB	3IM
	5#	400MB	10IM
	—	600MB	—
	10#	—	20IM
	15#	1BR	30IM
	—	1.6BR	50IM
	30#	2BR	—
	—	2.5BR	—
	45#	—	—
	50#	—	100IM
	60#	4BR	—
	75#	—	—
	—	6BR	—
	100#	—	200IM
	150#	10BR	300IM
	200#	—	—
	—	16BR	—
	250#	—	500IM
	300#	20BR	—
—	25BR	—	
500#	—	1000IM	
—	40BR	—	
750#	—	—	
—	60BR	—	
1000#	—	—	
1500#	100BR	—	
2000#	160BR	—	
—	200BR	—	
2500#	—	—	
3000#	—	—	
—	250BR	—	
5000#	—	—	
—	400BR	—	
7500#	—	—	
—	600BR	—	
10000#	—	—	
15000#	1000BR	—	
20000#	—	—	
Absolute Pressure (psia)	15#A	1BRA	30IMA
	—	1.6BRA	50IMA
	30#A	2BRA	—
	—	2.5BRA	—
	50#A	—	100IMA
	—	4BRA	—
	—	6BRA	—
	100#A	—	200IMA
	—	10BRA	300IMA
	200#A	—	—
—	16BRA	500IMA	
—	20BRA	—	
500#A	—	—	

DIMENSIONS

For reference only, consult Ashcroft for specific dimensional drawings

