

Technical Information

Proline Promass E 100

Coriolis flowmeter



The flowmeter with minimum total cost of ownership and an ultra-compact transmitter

Application

- Measuring principle operates independently of physical fluid properties such as viscosity or density
- Accurate measurement of liquids and gases for a wide range of standard applications

Device properties

- Compact dual-tube sensor
- Medium temperature up to +150 °C (+302 °F)
- Process pressure: up to 100 bar (1 450 psi)
- Robust, ultra-compact transmitter housing
- Highest degree of protection: IP69
- Local display available

Your benefits

- Cost-effective – multi-purpose device; an alternative to conventional volumetric flowmeters
- Fewer process measuring points – multivariable measurement (flow, density, temperature)
- Space-saving installation – no in/outlet run needs
- Space-saving transmitter – full functionality on smallest footprint
- Time-saving local operation without additional software and hardware – integrated web server
- Integrated verification – Heartbeat Technology

Table of contents





About this document	4	Shock resistance	48
Symbols used	4	Impact resistance	48
Function and system design	5	Interior cleaning	49
Measuring principle	5	Electromagnetic compatibility (EMC)	49
Measuring system	5	Process	49
Equipment architecture	7	Medium temperature range	49
Safety	7	Density	49
Input	8	Pressure-temperature curves	50
Measured variable	8	Secondary containment	53
Measuring range	8	Rupture disk	53
Operable flow range	9	Flow limit	53
Output	9	Pressure loss	53
Output signal	9	System pressure	53
Signal on alarm	10	Thermal insulation	54
Ex connection data	12	Heating	54
Low flow cut off	13	Vibrations	54
Protocol-specific data	13	Mechanical construction	55
Power supply	23	Dimensions in SI units	55
Terminal assignment	23	Dimensions in US units	68
Pin assignment, device plug	30	Weight	76
Supply voltage	32	Materials	76
Power consumption	33	Process connections	78
Current consumption	33	Surface roughness	78
Power supply failure	33	Operability	78
Electrical connection	34	Operating concept	78
Potential equalization	39	Local display	79
Terminals	39	Remote operation	79
Cable entries	39	Service interface	81
Cable specification	39	Certificates and approvals	83
Performance characteristics	41	CE mark	83
reference operating conditions	41	C-Tick symbol	83
Maximum measured error	41	Ex approval	84
Repeatability	43	Sanitary compatibility	84
Response time	43	HART certification	84
Influence of ambient temperature	43	Certification PROFIBUS	84
Influence of medium temperature	43	Certification PROFINET	85
Influence of medium pressure	44	EtherNet/IP certification	85
Design fundamentals	44	Modbus RS485 certification	85
Installation	45	Pressure Equipment Directive	85
Mounting location	45	Other standards and guidelines	85
Orientation	46	Ordering information	86
Inlet and outlet runs	47	Application packages	86
Special mounting instructions	47	Heartbeat Technology	86
Mounting Safety Barrier Promass 100	48	Concentration	87
Environment	48	Accessories	87
Ambient temperature range	48	Device-specific accessories	87
Storage temperature	48	Communication-specific accessories	87
Climate class	48	Service-specific accessories	88
Degree of protection	48	System components	88
Vibration resistance	48		

Supplementary documentation	89
Standard documentation	89
Supplementary device-dependent documentation	89
Registered trademarks	90









About this document

Symbols used



Electrical symbols

Symbol	Meaning
	Direct current
	Alternating current
	Direct current and alternating current
	Ground connection A grounded terminal which, as far as the operator is concerned, is grounded via a grounding system.
	Protective Earth (PE) A terminal which must be connected to ground prior to establishing any other connections. The ground terminals are situated inside and outside the device: <ul style="list-style-type: none"> ▪ Inner ground terminal: Connects the protective earth to the mains supply. ▪ Outer ground terminal: Connects the device to the plant grounding system.

Symbols for certain types of information

Symbol	Meaning
	Permitted Procedures, processes or actions that are permitted.
	Preferred Procedures, processes or actions that are preferred.
	Forbidden Procedures, processes or actions that are forbidden.
	Tip Indicates additional information.
	Reference to documentation.
	Reference to page.
	Reference to graphic.
	Visual inspection.

Symbols in graphics

Symbol	Meaning
1, 2, 3, ...	Item numbers
1. , 2. , 3. , ...	Series of steps
A, B, C, ...	Views
A-A, B-B, C-C, ...	Sections
	Hazardous area
	Safe area (non-hazardous area)
	Flow direction

Function and system design

Measuring principle

The measuring principle is based on the controlled generation of Coriolis forces. These forces are always present in a system when both translational and rotational movements are superimposed.

$$F_c = 2 \cdot \Delta m (v \cdot \omega)$$

F_c = Coriolis force

Δm = moving mass

ω = rotational velocity

v = radial velocity in rotating or oscillating system

The amplitude of the Coriolis force depends on the moving mass Δm , its velocity v in the system and thus on the mass flow. Instead of a constant rotational velocity ω , the sensor uses oscillation.

In the sensor, two parallel measuring tubes containing flowing fluid oscillate in antiphase, acting like a tuning fork. The Coriolis forces produced at the measuring tubes cause a phase shift in the tube oscillations (see illustration):

- At zero flow (when the fluid is at a standstill) the two tubes oscillate in phase (1).
- Mass flow causes deceleration of the oscillation at the inlet of the tubes (2) and acceleration at the outlet (3).

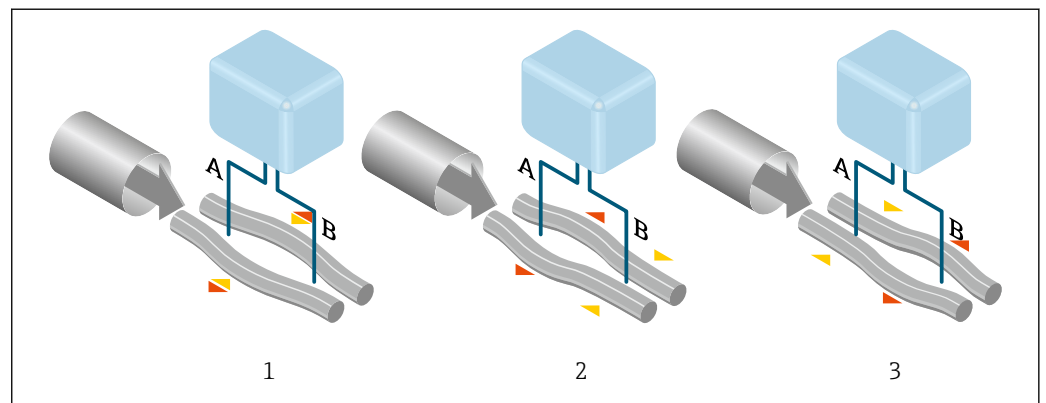

A0028850

The phase difference (A-B) increases with increasing mass flow. Electrodynamical sensors register the tube oscillations at the inlet and outlet. System balance is ensured by the antiphase oscillation of the two measuring tubes. The measuring principle operates independently of temperature, pressure, viscosity, conductivity and flow profile.

Density measurement

The measuring tube is continuously excited at its resonance frequency. A change in the mass and thus the density of the oscillating system (comprising measuring tube and fluid) results in a corresponding, automatic adjustment in the oscillation frequency. Resonance frequency is thus a function of medium density. The microprocessor utilizes this relationship to obtain a density signal.

Volume measurement

Together with the measured mass flow, this is used to calculate the volume flow.

Temperature measurement

The temperature of the measuring tube is determined in order to calculate the compensation factor due to temperature effects. This signal corresponds to the process temperature and is also available as an output signal.

Measuring system

The device consists of a transmitter and a sensor. If a device with Modbus RS485 intrinsically safe is ordered, the Safety Barrier Promass 100 is part of the scope of supply and must be implemented to operate the device.

The device is available as a compact version:
The transmitter and sensor form a mechanical unit.

Transmitter

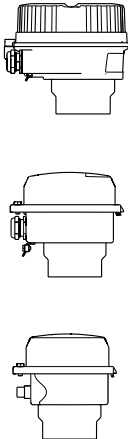
<p>Promass 100</p>  <p>A0016693</p> <p>A0016694</p> <p>A0016695</p>	<p>Device versions and materials:</p> <ul style="list-style-type: none"> ■ Compact, aluminum, coated: Aluminum, AlSi10Mg, coated ■ Compact, hygienic, stainless: Hygienic version, stainless steel 1.4301 (304) ■ Ultra-compact, hygienic, stainless: Hygienic version, stainless steel 1.4301 (304) <p>Configuration:</p> <ul style="list-style-type: none"> ■ Via operating tools (e.g. FieldCare, DeviceCare) ■ Additionally for device version with local display: Via Web browser (e.g. Microsoft Internet Explorer) ■ Also for device version with 4-20 mA HART, pulse/frequency/switch output: Via Web browser (e.g. Microsoft Internet Explorer) ■ Also for device version with EtherNet/IP output: <ul style="list-style-type: none"> - Via Web browser (e.g. Microsoft Internet Explorer) - Via Add-on Profile Level 3 for automation system from Rockwell Automation - Via Electronic Data Sheet (EDS) ■ Also for device version with PROFINET output: <ul style="list-style-type: none"> - Via Web browser (e.g. Microsoft Internet Explorer) - Via device master file (GSD)
---	---

Sensor

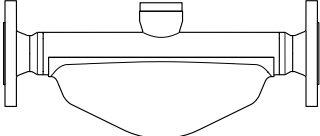
<p>Promass E</p>  <p>A0030940</p>	<ul style="list-style-type: none"> ■ For standard applications where stable and reliable measurements are required ■ Simultaneous measurement of flow, volume flow, density and temperature (multivariable) ■ Immune to process influences ■ Nominal diameter range: DN 8 to 80 ($\frac{3}{8}$ to 3") ■ Materials: <ul style="list-style-type: none"> - Sensor: stainless steel, 1.4301 (304) - Measuring tubes: stainless steel, 1.4539 (904L) - Process connections: stainless steel, 1.4404 (316/316L)
---	---

Safety Barrier Promass 100

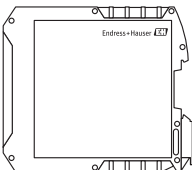
 <p>A0016763</p>	<ul style="list-style-type: none"> ■ Dual-channel safety barrier for installation in non-hazardous locations or zone 2/div. 2: <ul style="list-style-type: none"> - Channel 1: DC 24 V power supply - Channel 2: Modbus RS485 ■ In addition to current, voltage and power limitation, it offers galvanic isolation of circuits for explosion protection. ■ Easy top-hat rail mounting (DIN 35 mm) for installation in control cabinets
---	--

Equipment architecture

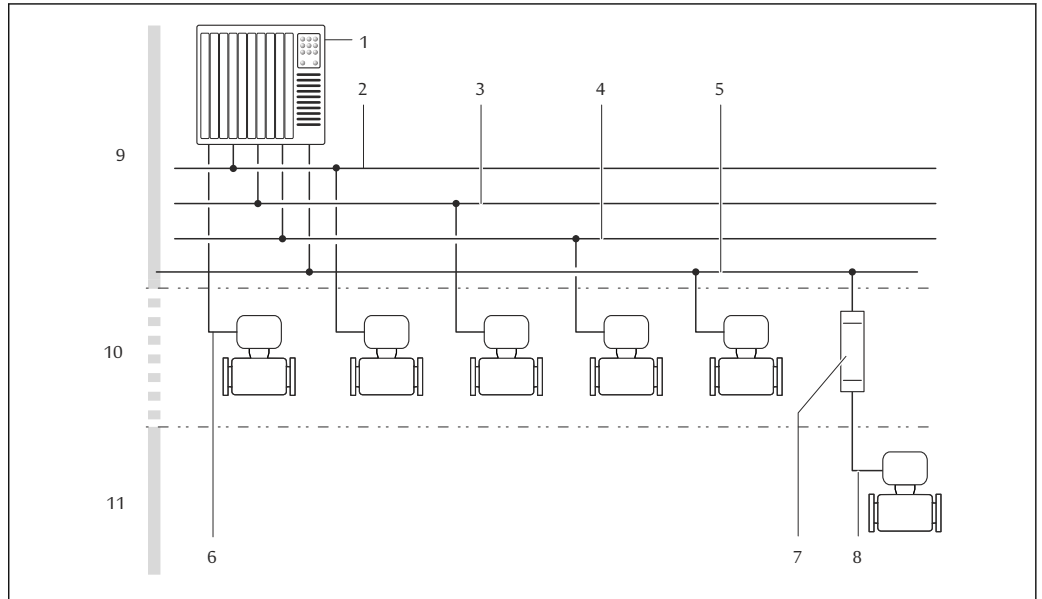

A0016779

1 Possibilities for integrating measuring devices into a system

- 1 Control system (e.g. PLC)
- 2 EtherNet/IP
- 3 PROFIBUS DP
- 4 PROFINET
- 5 Modbus RS485
- 6 4-20 mA HART, pulse/frequency/switch output
- 7 Safety Barrier Promass 100
- 8 Modbus RS485 intrinsically safe
- 9 Non-hazardous area
- 10 Non-hazardous area and Zone 2/Div. 2
- 11 Hazardous area and Zone 1/Div. 1

Safety

IT security

We only provide a warranty if the device is installed and used as described in the Operating Instructions. The device is equipped with security mechanisms to protect it against any inadvertent changes to the device settings.

IT security measures in line with operators' security standards and designed to provide additional protection for the device and device data transfer must be implemented by the operators themselves.

Input

Measured variable

Direct measured variables

- Mass flow
- Density
- Temperature

Calculated measured variables

- Volume flow
- Corrected volume flow
- Reference density

Measuring range

Measuring ranges for liquids

DN		Measuring range full scale values $\dot{m}_{\min(F)}$ to $\dot{m}_{\max(F)}$	
[mm]	[in]	[kg/h]	[lb/min]
8	$\frac{3}{8}$	0 to 2 000	0 to 73.50
15	$\frac{1}{2}$	0 to 6 500	0 to 238.9
25	1	0 to 18 000	0 to 661.5
40	$1\frac{1}{2}$	0 to 45 000	0 to 1 654
50	2	0 to 70 000	0 to 2 573
80	3	0 to 180 000	0 to 6 615

Measuring ranges for gases

The full scale values depend on the density of the gas and can be calculated with the formula below:

$$\dot{m}_{\max(G)} = \dot{m}_{\max(F)} \cdot \rho_G \cdot x$$

$\dot{m}_{\max(G)}$	Maximum full scale value for gas [kg/h]
$\dot{m}_{\max(F)}$	Maximum full scale value for liquid [kg/h]
$\dot{m}_{\max(G)} < \dot{m}_{\max(F)}$	$\dot{m}_{\max(G)}$ can never be greater than $\dot{m}_{\max(F)}$
ρ_G	Gas density in [kg/m ³] at operating conditions
x	Constant dependent on nominal diameter

DN		x
[mm]	[in]	[kg/m ³]
8	$\frac{3}{8}$	85
15	$\frac{1}{2}$	110
25	1	125
40	$1\frac{1}{2}$	125
50	2	125
80	3	155



To calculate the measuring range, use the *Applicator* sizing tool → 88

Calculation example for gas

- Sensor: Promass E, DN 50
- Gas: Air with a density of 60.3 kg/m³ (at 20 °C and 50 bar)
- Measuring range (liquid): 70 000 kg/h
- $x = 125$ kg/m³ (for Promass E, DN 50)

Maximum possible full scale value:

$$\dot{m}_{\max(G)} = \dot{m}_{\max(F)} \cdot \rho_G : x = 70\,000 \text{ kg/h} \cdot 60.3 \text{ kg/m}^3 : 125 \text{ kg/m}^3 = 33\,800 \text{ kg/h}$$

Recommended measuring range

"Flow limit" section → 53

Operable flow range

Over 1000 : 1.

Flow rates above the preset full scale value do not override the electronics unit, with the result that the totalizer values are registered correctly.

Output



Output signal

HART current output

Current output	4-20 mA HART (active)
Maximum output values	<ul style="list-style-type: none"> ▪ DC 24 V (no flow) ▪ 22.5 mA
Load	0 to 700 Ω
Resolution	0.38 μA
Damping	Adjustable: 0.07 to 999 s
Assignable measured variables	<ul style="list-style-type: none"> ▪ Mass flow ▪ Volume flow ▪ Corrected volume flow ▪ Density ▪ Reference density ▪ Temperature <p> The range of options increases if the measuring device has one or more application packages.</p>

Pulse/frequency/switch output

Function	Can be set to pulse, frequency or switch output
Version	Passive, open collector
Maximum input values	<ul style="list-style-type: none"> ▪ DC 30 V ▪ 25 mA
Voltage drop	For 25 mA: ≤ DC 2 V
Pulse output	
Pulse width	Adjustable: 0.05 to 2 000 ms
Maximum pulse rate	10 000 Impulse/s
Pulse value	Adjustable
Assignable measured variables	<ul style="list-style-type: none"> ▪ Mass flow ▪ Volume flow ▪ Corrected volume flow
Frequency output	
Output frequency	Adjustable: 0 to 10 000 Hz
Damping	Adjustable: 0 to 999 s
Pulse/pause ratio	1:1

Assignable measured variables	<ul style="list-style-type: none"> ▪ Mass flow ▪ Volume flow ▪ Corrected volume flow ▪ Density ▪ Reference density ▪ Temperature <p> The range of options increases if the measuring device has one or more application packages.</p>
Switch output	
Switching behavior	Binary, conductive or non-conductive
Switching delay	Adjustable: 0 to 100 s
Number of switching cycles	Unlimited
Assignable functions	<ul style="list-style-type: none"> ▪ Off ▪ On ▪ Diagnostic behavior ▪ Limit value <ul style="list-style-type: none"> - Mass flow - Volume flow - Corrected volume flow - Density - Reference density - Temperature - Totalizer 1-3 ▪ Flow direction monitoring ▪ Status <ul style="list-style-type: none"> - Partially filled pipe detection - Low flow cut off <p> The range of options increases if the measuring device has one or more application packages.</p>

PROFIBUS DP

Signal encoding	NRZ code
Data transfer	9.6 kBaud...12 MBaud

Modbus RS485

Physical interface	In accordance with EIA/TIA-485-A standard
Terminating resistor	<ul style="list-style-type: none"> ▪ For device version used in non-hazardous areas or Zone 2/Div. 2: integrated and can be activated via DIP switches on the transmitter electronics module ▪ For device version used in intrinsically safe areas: integrated and can be activated via DIP switches on the Safety Barrier Promass 100

EtherNet/IP

Standards	In accordance with IEEE 802.3
------------------	-------------------------------

PROFINET

Standards	In accordance with IEEE 802.3
------------------	-------------------------------

Signal on alarm

Depending on the interface, failure information is displayed as follows:

Current output 4 to 20 mA

4 to 20 mA

Failure mode	Choose from: <ul style="list-style-type: none"> ▪ 4 to 20 mA in accordance with NAMUR recommendation NE 43 ▪ 4 to 20 mA in accordance with US ▪ Min. value: 3.59 mA ▪ Max. value: 22.5 mA ▪ Freely definable value between: 3.59 to 22.5 mA ▪ Actual value ▪ Last valid value
---------------------	--

Pulse/frequency/switch output

Pulse output	
Failure mode	Choose from: <ul style="list-style-type: none"> ▪ Actual value ▪ No pulses
Frequency output	
Failure mode	Choose from: <ul style="list-style-type: none"> ▪ Actual value ▪ 0 Hz ▪ Defined value: 0 to 12 500 Hz
Switch output	
Failure mode	Choose from: <ul style="list-style-type: none"> ▪ Current status ▪ Open ▪ Closed

PROFIBUS DP

Status and alarm messages	Diagnostics in accordance with PROFIBUS PA Profile 3.02
----------------------------------	---

Modbus RS485

Failure mode	Choose from: <ul style="list-style-type: none"> ▪ NaN value instead of current value ▪ Last valid value
---------------------	---

EtherNet/IP

Device diagnostics	Device condition can be read out in Input Assembly
---------------------------	--

PROFINET

Device diagnostics	According to "Application Layer protocol for decentralized periphery", Version 2.3
---------------------------	--

Local display

Plain text display	With information on cause and remedial measures
Backlight	Red backlighting indicates a device error.

 Status signal as per NAMUR recommendation NE 107

Interface/protocol

- Via digital communication:
 - HART protocol
 - PROFIBUS DP
 - Modbus RS485
 - EtherNet/IP
 - PROFINET
- Via service interface
 CDI-RJ45 service interface

Plain text display	With information on cause and remedial measures
---------------------------	---

 Additional information on remote operation →  79

Web server

Plain text display	With information on cause and remedial measures
---------------------------	---

Light emitting diodes (LED)

Status information	Status indicated by various light emitting diodes The following information is displayed depending on the device version: <ul style="list-style-type: none"> ▪ Supply voltage active ▪ Data transmission active ▪ Device alarm/error has occurred ▪ EtherNet/IP network available ▪ EtherNet/IP connection established ▪ PROFINET network available ▪ PROFINET connection established ▪ PROFINET blinking feature
---------------------------	--

Ex connection data

These values only apply for the following device version:
 Order code for "Output", option M "Modbus RS485", for use in intrinsically safe areas

Safety Barrier Promass 100

Safety-related values

Terminal numbers			
Supply voltage		Signal transmission	
2 (L-)	1 (L+)	26 (A)	27 (B)
$U_{nom} = DC\ 24\ V$ $U_{max} = AC\ 260\ V$		$U_{nom} = DC\ 5\ V$ $U_{max} = AC\ 260\ V$	

Intrinsically safe values

Terminal numbers			
Supply voltage		Signal transmission	
20 (L-)	10 (L+)	62 (A)	72 (B)
$U_o = 16.24 \text{ V}$ $I_o = 623 \text{ mA}$ $P_o = 2.45 \text{ W}$ With IIC ¹⁾ : $L_o = 92.8 \text{ } \mu\text{H}$, $C_o = 0.433 \text{ } \mu\text{F}$, $L_o/R_o = 14.6 \text{ } \mu\text{H}/\Omega$ With IIB: $L_o = 372 \text{ } \mu\text{H}$, $C_o = 2.57 \text{ } \mu\text{F}$, $L_o/R_o = 58.3 \text{ } \mu\text{H}/\Omega$			
 For an overview and for information on the interdependencies between the gas group - sensor - nominal diameter, see the "Safety Instructions" (XA) document for the measuring device			

1) The gas group depends on the sensor and nominal diameter ff.

Transmitter

Intrinsically safe values

Order code for "Approval"	Terminal numbers			
	Supply voltage		Signal transmission	
	20 (L-)	10 (L+)	62 (A)	72 (B)
<ul style="list-style-type: none"> ▪ Option BM: ATEX II2G + IECEx Z1 Ex ia, II2D Ex tb ▪ Option BO: ATEX II1/2G + IECEx Z0/Z1 Ex ia, II2D ▪ Option BQ: ATEX II1/2G + IECEx Z0/Z1 Ex ia ▪ Option BU: ATEX II2G + IECEx Z1 Ex ia ▪ Option C2: CSA C/US IS Cl. I, II, III Div. 1 ▪ Option 85: ATEX II2G + IECEx Z1 Ex ia + CSA C/US IS Cl. I, II, III Div. 1 	$U_i = 16.24 \text{ V}$ $I_i = 623 \text{ mA}$ $P_i = 2.45 \text{ W}$ $L_i = 0 \text{ } \mu\text{H}$ $C_i = 6 \text{ nF}$			
 For an overview and for information on the interdependencies between the gas group - sensor - nominal diameter, see the "Safety Instructions" (XA) document for the measuring device				

Low flow cut off

The switch points for low flow cut off are user-selectable.

Protocol-specific data

HART

Manufacturer ID	0x11
Device type ID	0x4A
HART protocol revision	7
Device description files (DTM, DD)	Information and files under: www.endress.com
HART load	Min. 250 Ω

Dynamic variables	<p>Read out the dynamic variables: HART command 3 The measured variables can be freely assigned to the dynamic variables.</p> <p>Measured variables for PV (primary dynamic variable)</p> <ul style="list-style-type: none"> ▪ Mass flow ▪ Volume flow ▪ Corrected volume flow ▪ Density ▪ Reference density ▪ Temperature <p>Measured variables for SV, TV, QV (secondary, tertiary and quaternary dynamic variable)</p> <ul style="list-style-type: none"> ▪ Mass flow ▪ Volume flow ▪ Corrected volume flow ▪ Density ▪ Reference density ▪ Temperature ▪ Totalizer 1 ▪ Totalizer 2 ▪ Totalizer 3 <p> The range of options increases if the measuring device has one or more application packages.</p> <p>Heartbeat Technology application package Additional measured variables are available with the Heartbeat Technology application package: Oscillation amplitude 0</p>
Device variables	<p>Read out the device variables: HART command 9 The device variables are permanently assigned.</p> <p>A maximum of 8 device variables can be transmitted:</p> <ul style="list-style-type: none"> ▪ 0 = mass flow ▪ 1 = volume flow ▪ 2 = corrected volume flow ▪ 3 = density ▪ 4 = reference density ▪ 5 = temperature ▪ 6 = totalizer 1 ▪ 7 = totalizer 2 ▪ 8 = totalizer 3 ▪ 13 = target mass flow ▪ 14 = carrier mass flow ▪ 15 = concentration

PROFIBUS DP

Manufacturer ID	0x11
Ident number	0x1561
Profile version	3.02
Device description files (GSD, DTM, DD)	<p>Information and files under:</p> <ul style="list-style-type: none"> ▪ www.endress.com On the product page for the device: Documents/Software → Device drivers ▪ www.profibus.org

<p>Output values (from measuring device to automation system)</p>	<p>Analog input 1 to 8</p> <ul style="list-style-type: none"> ▪ Mass flow ▪ Volume flow ▪ Corrected volume flow ▪ Target mass flow ▪ Carrier mass flow ▪ Density ▪ Reference density ▪ Concentration ▪ Temperature ▪ Carrier pipe temperature ▪ Electronic temperature ▪ Oscillation frequency ▪ Oscillation amplitude ▪ Frequency fluctuation ▪ Oscillation damping ▪ Tube damping fluctuation ▪ Signal asymmetry ▪ Exciter current <p>Digital input 1 to 2</p> <ul style="list-style-type: none"> ▪ Partially filled pipe detection ▪ Low flow cut off <p>Totalizer 1 to 3</p> <ul style="list-style-type: none"> ▪ Mass flow ▪ Volume flow ▪ Corrected volume flow
<p>Input values (from automation system to measuring device)</p>	<p>Analog output 1 to 3 (fixed assignment)</p> <ul style="list-style-type: none"> ▪ Pressure ▪ Temperature ▪ Reference density <p>Digital output 1 to 3 (fixed assignment)</p> <ul style="list-style-type: none"> ▪ Digital output 1: switch positive zero return on/off ▪ Digital output 2: perform zero point adjustment ▪ Digital output 3: switch switch output on/off <p>Totalizer 1 to 3</p> <ul style="list-style-type: none"> ▪ Totalize ▪ Reset and hold ▪ Preset and hold ▪ Stop ▪ Operating mode configuration: <ul style="list-style-type: none"> – Net flow total – Forward flow total – Reverse flow total
<p>Supported functions</p>	<ul style="list-style-type: none"> ▪ Identification & Maintenance Simplest device identification on the part of the control system and nameplate ▪ PROFIBUS upload/download Reading and writing parameters is up to ten times faster with PROFIBUS upload/download ▪ Condensed status Simplest and self-explanatory diagnostic information by categorizing diagnostic messages that occur
<p>Configuration of the device address</p>	<ul style="list-style-type: none"> ▪ DIP switches on the I/O electronics module ▪ Via operating tools (e.g. FieldCare)

Modbus RS485

<p>Protocol</p>	<p>Modbus Applications Protocol Specification V1.1</p>
<p>Device type</p>	<p>Slave</p>
<p>Slave address range</p>	<p>1 to 247</p>
<p>Broadcast address range</p>	<p>0</p>

Function codes	<ul style="list-style-type: none"> ▪ 03: Read holding register ▪ 04: Read input register ▪ 06: Write single registers ▪ 08: Diagnostics ▪ 16: Write multiple registers ▪ 23: Read/write multiple registers
Broadcast messages	Supported by the following function codes: <ul style="list-style-type: none"> ▪ 06: Write single registers ▪ 16: Write multiple registers ▪ 23: Read/write multiple registers
Supported baud rate	<ul style="list-style-type: none"> ▪ 1 200 BAUD ▪ 2 400 BAUD ▪ 4 800 BAUD ▪ 9 600 BAUD ▪ 19 200 BAUD ▪ 38 400 BAUD ▪ 57 600 BAUD ▪ 115 200 BAUD
Data transfer mode	<ul style="list-style-type: none"> ▪ ASCII ▪ RTU
Data access	Each device parameter can be accessed via Modbus RS485.  For Modbus register information, see "Description of device parameters" documentation

EtherNet/IP

Protocol	<ul style="list-style-type: none"> ▪ The CIP Networks Library Volume 1: Common Industrial Protocol ▪ The CIP Networks Library Volume 2: EtherNet/IP Adaptation of CIP
Communication type	<ul style="list-style-type: none"> ▪ 10Base-T ▪ 100Base-TX
Device profile	Generic device (product type: 0x2B)
Manufacturer ID	0x49E
Device type ID	0x104A
Baud rates	Automatic ¹⁰ / ₁₀₀ Mbit with half-duplex and full-duplex detection
Polarity	Auto-polarity for automatic correction of crossed TxD and RxD pairs
Supported CIP connections	Max. 3 connections
Explicit connections	Max. 6 connections
I/O connections	Max. 6 connections (scanner)
Configuration options for measuring device	<ul style="list-style-type: none"> ▪ DIP switches on the electronics module for IP addressing ▪ Manufacturer-specific software (FieldCare) ▪ Add-on Profile Level 3 for Rockwell Automation control systems ▪ Web browser ▪ Electronic Data Sheet (EDS) integrated in the measuring device
Configuration of the EtherNet interface	<ul style="list-style-type: none"> ▪ Speed: 10 MBit, 100 MBit, auto (factory setting) ▪ Duplex: half-duplex, full-duplex, auto (factory setting)
Configuration of the device address	<ul style="list-style-type: none"> ▪ DIP switches on the electronics module for IP addressing (last octet) ▪ DHCP ▪ Manufacturer-specific software (FieldCare) ▪ Add-on Profile Level 3 for Rockwell Automation control systems ▪ Web browser ▪ EtherNet/IP tools, e.g. RSLinx (Rockwell Automation)
Device Level Ring (DLR)	No

Fix Input			
RPI	5 ms to 10 s (factory setting: 20 ms)		
Exclusive Owner Multicast		Instance	Size [byte]
	Instance configuration:	0x68	398
	O → T configuration:	0x66	64
	T → O configuration:	0x64	44
Exclusive Owner Multicast		Instance	Size [byte]
	Instance configuration:	0x69	-
	O → T configuration:	0x66	64
	T → O configuration:	0x64	44
Input only Multicast		Instance	Size [byte]
	Instance configuration:	0x68	398
	O → T configuration:	0xC7	-
	T → O configuration:	0x64	44
Input only Multicast		Instance	Size [byte]
	Instance configuration:	0x69	-
	O → T configuration:	0xC7	-
	T → O configuration:	0x64	44
Input Assembly	<ul style="list-style-type: none"> ▪ Current device diagnostics ▪ Mass flow ▪ Volume flow ▪ Corrected volume flow ▪ Density ▪ Reference density ▪ Temperature ▪ Totalizer 1 ▪ Totalizer 2 ▪ Totalizer 3 		
Configurable Input			
RPI	5 ms to 10 s (factory setting: 20 ms)		
Exclusive Owner Multicast		Instance	Size [byte]
	Instance configuration:	0x68	398
	O → T configuration:	0x66	64
	T → O configuration:	0x65	88
Exclusive Owner Multicast		Instance	Size [byte]
	Instance configuration:	0x69	-
	O → T configuration:	0x66	64
	T → O configuration:	0x65	88
Input only Multicast		Instance	Size [byte]
	Instance configuration:	0x68	398
	O → T configuration:	0xC7	-
	T → O configuration:	0x65	88
Input only Multicast		Instance	Size [byte]
	Instance configuration:	0x69	-
	O → T configuration:	0xC7	-
	T → O configuration:	0x65	88

Configurable Input Assembly	<ul style="list-style-type: none"> ▪ Current device diagnostics ▪ Mass flow ▪ Volume flow ▪ Corrected volume flow ▪ Density ▪ Reference density ▪ Temperature ▪ Totalizer 1 ▪ Totalizer 2 ▪ Totalizer 3 <p> The range of options increases if the measuring device has one or more application packages.</p>
Fix Output	
Output Assembly	<ul style="list-style-type: none"> ▪ Activation of reset totalizers 1-3 ▪ Activation of pressure compensation ▪ Activation of reference density compensation ▪ Activation of temperature compensation ▪ Reset totalizers 1-3 ▪ External pressure value ▪ Pressure unit ▪ External reference density ▪ Reference density unit ▪ External temperature ▪ Temperature unit
Configuration	
Configuration Assembly	<p>Only the most common configurations are listed below.</p> <ul style="list-style-type: none"> ▪ Software write protection ▪ Mass flow unit ▪ Mass unit ▪ Volume flow unit ▪ Volume unit ▪ Corrected volume flow unit ▪ Corrected volume unit ▪ Density unit ▪ Reference density unit ▪ Temperature unit ▪ Pressure unit ▪ Length ▪ Totalizer 1-3: <ul style="list-style-type: none"> - Assignment - Unit - Operating mode - Failsafe mode ▪ Alarm delay

PROFINET

Protocol	"Application layer protocol for decentral device periphery and distributed automation", version 2.3
Conformity class	B
Communication type	100 MBit/s
Device profile	Application interface identifier 0xF600 Generic device
Manufacturer ID	0x11
Device type ID	0x844A
Device description files (GSD, DTM)	Information and files under: <ul style="list-style-type: none"> ▪ www.endress.com On the product page for the device: Documents/Software → Device drivers ▪ www.profibus.org
Baud rates	Automatic 100 Mbit/s with full-duplex detection

Cycle times	From 8 ms
Polarity	Auto-polarity for automatic correction of crossed TxD and RxD pairs
Supported connections	<ul style="list-style-type: none"> ▪ 1 x AR (Application Relation) ▪ 1 x Input CR (Communication Relation) ▪ 1 x Output CR (Communication Relation) ▪ 1 x Alarm CR (Communication Relation)
Configuration options for measuring device	<ul style="list-style-type: none"> ▪ DIP switches on the electronics module, for device name assignment (last part) ▪ Manufacturer-specific software (FieldCare, DeviceCare) ▪ Web browser ▪ Device master file (GSD), can be read out via the integrated Web server of the measuring device
Configuration of the device name	<ul style="list-style-type: none"> ▪ DIP switches on the electronics module, for device name assignment (last part) ▪ DCP protocol
Output values (from measuring device to automation system)	<p>Analog Input module (slot 1 to 14)</p> <ul style="list-style-type: none"> ▪ Mass flow ▪ Volume flow ▪ Corrected volume flow ▪ Target mass flow ▪ Carrier mass flow ▪ Density ▪ Reference density ▪ Concentration ▪ Temperature ▪ Carrier pipe temperature ▪ Electronic temperature ▪ Oscillation frequency ▪ Oscillation amplitude ▪ Frequency fluctuation ▪ Oscillation damping ▪ Tube damping fluctuation ▪ Signal asymmetry ▪ Exciter current <p>Discrete Input module (slot 1 to 14)</p> <ul style="list-style-type: none"> ▪ Empty pipe detection ▪ Low flow cut off <p>Diagnostics Input module (slot 1 to 14)</p> <ul style="list-style-type: none"> ▪ Last diagnostics ▪ Current diagnosis <p>Totalizer 1 to 3 (slot 15 to 17)</p> <ul style="list-style-type: none"> ▪ Mass flow ▪ Volume flow ▪ Corrected volume flow <p>Heartbeat Verification module (fixed assignment) Verification status (slot 23)</p> <p> The range of options increases if the measuring device has one or more application packages.</p>

<p>Input values (from automation system to measuring device)</p>	<p>Analog Output module (fixed assignment)</p> <ul style="list-style-type: none"> ▪ External pressure (slot 18) ▪ External temperature (slot 19) ▪ External reference density (slot 20) <p>Discrete Output module (fixed assignment)</p> <ul style="list-style-type: none"> ▪ Activate/deactivate positive zero return (slot 21) ▪ Perform zero point adjustment (slot 22) <p>Totalizer 1 to 3 (slot 15 to 17)</p> <ul style="list-style-type: none"> ▪ Totalize ▪ Reset and hold ▪ Preset and hold ▪ Stop ▪ Operating mode configuration: <ul style="list-style-type: none"> - Net flow total - Forward flow total - Reverse flow total <p>Heartbeat Verification module (fixed assignment) Start verification (slot 23)</p> <p> The range of options increases if the measuring device has one or more application packages.</p>
<p>Supported functions</p>	<ul style="list-style-type: none"> ▪ Identification & Maintenance Simple device identification via: <ul style="list-style-type: none"> - Control system - Nameplate ▪ Measured value status The process variables are communicated with a measured value status ▪ Blinking feature via the local display for simple device identification and assignment

Administration of software options

Input/output value	Process variable	Category	Slot
Output value	Mass flow	Process variable	1 to 14
	Volume flow		
	Corrected volume flow		
	Density		
	Reference density		
	Temperature		
	Electronic temperature		
	Oscillation frequency		
	Frequency fluctuation		
	Oscillation damping		
	Oscillation frequency		
	Signal asymmetry		
	Exciter current		
	Empty pipe detection		
	Low flow cut off		
Current device diagnostics			
Previous device diagnostics			
Output value	Target mass flow	Concentration ¹⁾	1 to 14
	Carrier mass flow		
	Concentration		
Output value	Oscillation damping 1	Heartbeat ²⁾	1 to 14

Input/output value	Process variable	Category	Slot
	Oscillation frequency 1		
	Oscillation amplitude 0		
	Oscillation amplitude 1		
	Frequency fluctuation 1		
	Tube damping fluctuation 1		
	Exciter current 1		
Input value	External density	Process monitoring	18
	External temperature		19
	External reference density		20
	Flow override		21
	Zero point adjustment		22
	Status verification	Heartbeat Verification	23

- 1) Only available with the "Concentration" application package.
- 2) Only available with the "Heartbeat" application package.

Startup configuration

Startup configuration (NSU)	<p>If startup configuration is enabled, the configuration of the most important device parameters is taken from the automation system and used.</p> <p>The following configuration is taken from the automation system:</p> <ul style="list-style-type: none"> ■ Management <ul style="list-style-type: none"> - Software revision - Write protection ■ System units <ul style="list-style-type: none"> - Mass flow - Mass - Volume flow - Volume - Corrected volume flow - Corrected volume - Density - Reference density - Temperature - Pressure ■ Concentration application package <ul style="list-style-type: none"> - Coefficients A0 to A4 - Coefficients B1 to B3 ■ Sensor adjustment ■ Process parameter <ul style="list-style-type: none"> - Damping (flow, density, temperature) - Flow override ■ Low flow cut off <ul style="list-style-type: none"> - Assign process variable - Switch-on/switch-off point - Pressure shock suppression ■ Empty pipe detection <ul style="list-style-type: none"> - Assign process variable - Limit values - Response time - Max. damping ■ Corrected volume flow calculation <ul style="list-style-type: none"> - External reference density - Fixed reference density - Reference temperature - Linear expansion coefficient - Square expansion coefficient ■ Measuring mode <ul style="list-style-type: none"> - Medium - Gas type - Reference sound velocity - Temperature coefficient sound velocity ■ External compensation <ul style="list-style-type: none"> - Pressure compensation - Pressure value - External pressure ■ Diagnostic settings ■ Diagnostic behavior for diverse diagnostic information
-----------------------------	---

Power supply

Terminal assignment

Overview: housing version and connection versions

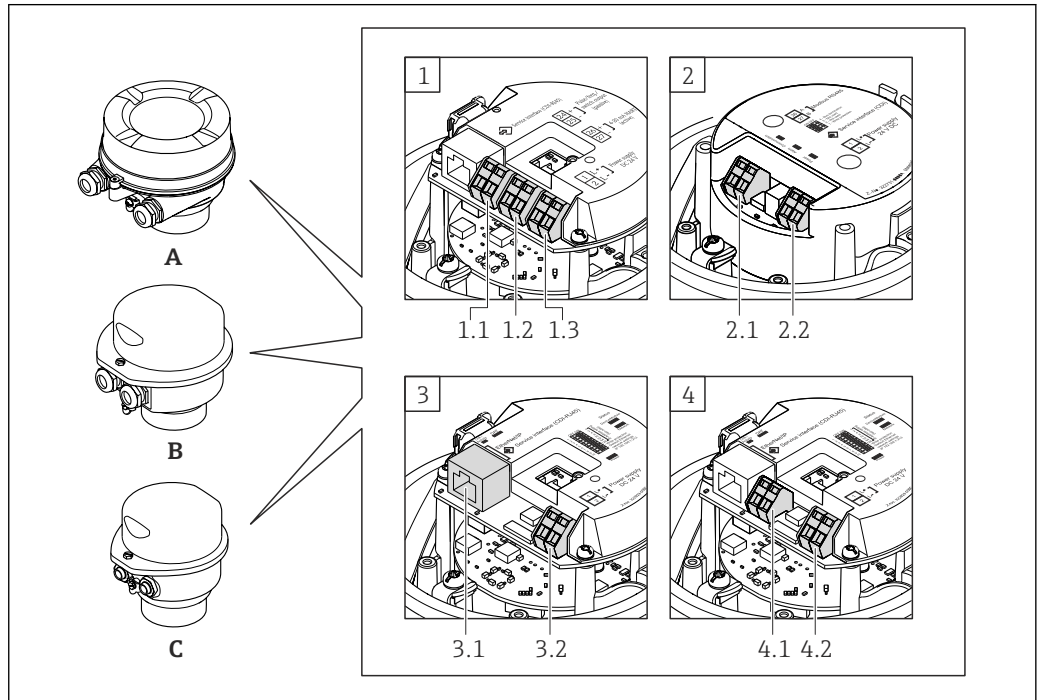

A0016770

- A Housing version: compact, aluminum coated
- B Housing version: compact, hygienic, stainless
- C Housing version: ultra-compact, hygienic, stainless
- 1 Connection version: 4-20 mA HART, pulse/frequency/switch output
 - 1.1 Signal transmission: pulse/frequency/switch output
 - 1.2 Signal transmission: 4-20 mA HART
 - 1.3 Supply voltage
- 2 Connection version: Modbus RS485
 - 2.1 Signal transmission
 - 2.2 Supply voltage
- 3 Connection versions: EtherNet/IP and PROFINET
 - 3.1 Signal transmission
 - 3.2 Supply voltage
- 4 Connection version: PROFIBUS DP
 - 4.1 Signal transmission
 - 4.2 Supply voltage

Transmitter

Connection version 4-20 mA HART with pulse/frequency/switch output

Order code for "Output", option **B**

Depending on the housing version, the transmitters can be ordered with terminals or device plugs.

Order code "Housing"	Connection methods available		Possible options for order code "Electrical connection"
	Outputs	Power supply	
Options A, B	Terminals	Terminals	<ul style="list-style-type: none"> ▪ Option A: coupling M20x1 ▪ Option B: thread M20x1 ▪ Option C: thread G ½" ▪ Option D: thread NPT ½"
Options A, B	Device plugs → 31	Terminals	<ul style="list-style-type: none"> ▪ Option L: plug M12x1 + thread NPT ½" ▪ Option N: plug M12x1 + coupling M20 ▪ Option P: plug M12x1 + thread G ½" ▪ Option U: plug M12x1 + thread M20
Options A, B, C	Device plugs → 31	Device plugs → 31	Option Q: 2 x plug M12x1
Order code for "Housing": <ul style="list-style-type: none"> ▪ Option A: compact, coated aluminum ▪ Option B: compact, hygienic, stainless ▪ Option C: ultra-compact, hygienic, stainless 			

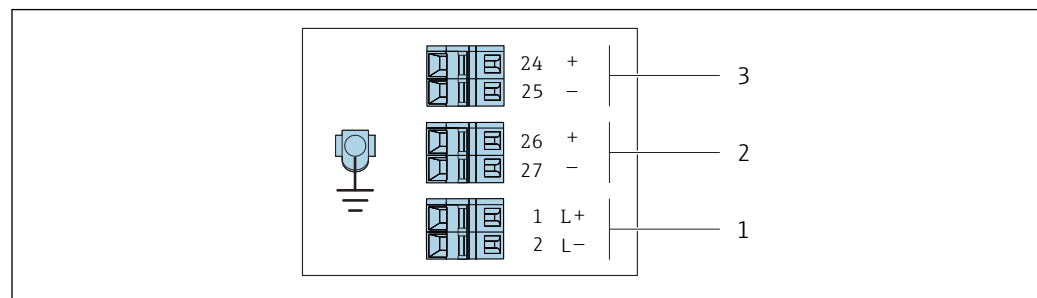

A0016886

2 Terminal assignment 4-20 mA HART with pulse/frequency/switch output

- 1 Power supply: DC 24 V
- 2 Output 1: 4-20 mA HART (active)
- 3 Output 2: pulse/frequency/switch output (passive)



Order code "Output"	Terminal number					
	Power supply		Output 1		Output 2	
	2 (L-)	1 (L+)	27 (-)	26 (+)	25 (-)	24 (+)
Option B	DC 24 V		4-20 mA HART (active)		Pulse/frequency/switch output (passive)	
Order code for "Output": Option B: 4-20 mA HART with pulse/frequency/switch output						

PROFIBUS DP connection version

 For use in the non-hazardous area and Zone 2/Div. 2

Order code for "Output", option L

Depending on the housing version, the transmitters can be ordered with terminals or device plugs.

Order code "Housing"	Connection methods available		Possible options for order code "Electrical connection"
	Output	Power supply	
Options A, B	Terminals	Terminals	<ul style="list-style-type: none"> ▪ Option A: coupling M20x1 ▪ Option B: thread M20x1 ▪ Option C: thread G 1/2" ▪ Option D: thread NPT 1/2"
Options A, B	Device plugs →  31	Terminals	<ul style="list-style-type: none"> ▪ Option L: plug M12x1 + thread NPT 1/2" ▪ Option N: plug M12x1 + coupling M20 ▪ Option P: plug M12x1 + thread G 1/2" ▪ Option U: plug M12x1 + thread M20
Options A, B, C	Device plugs →  31	Device plugs →  31	Option Q: 2 x plug M12x1
Order code for "Housing": <ul style="list-style-type: none"> ▪ Option A: compact, coated aluminum ▪ Option B: compact, hygienic, stainless ▪ Option C: ultra-compact, hygienic, stainless 			

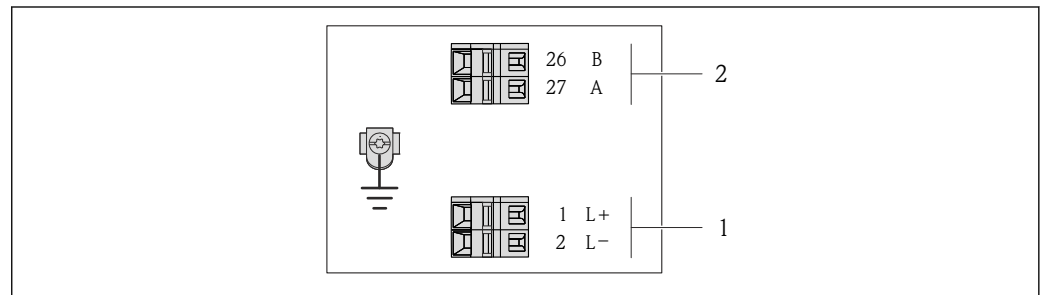

A0022716

 3 PROFIBUS DP terminal assignment

- 1 Power supply: DC 24 V
- 2 PROFIBUS DP



Order code "Output"	Terminal number			
	Power supply		Output	
	2 (L-)	1 (L+)	26 (RxD/TxD-P)	27 (RxD/TxD-N)
Option L	DC 24 V		B	A
Order code for "Output": Option L: PROFIBUS DP, for use in non-hazardous areas and Zone 2/Div. 2				

Modbus RS485 connection version

 For use in the non-hazardous area and Zone 2/Div. 2

Order code for "Output", option **M**

Depending on the housing version, the transmitters can be ordered with terminals or device plugs.

Order code "Housing"	Connection methods available		Possible options for order code "Electrical connection"
	Output	Power supply	
Options A, B	Terminals	Terminals	<ul style="list-style-type: none"> ▪ Option A: coupling M20x1 ▪ Option B: thread M20x1 ▪ Option C: thread G ½" ▪ Option D: thread NPT ½"
Options A, B	Device plugs →  31	Terminals	<ul style="list-style-type: none"> ▪ Option L: plug M12x1 + thread NPT ½" ▪ Option N: plug M12x1 + coupling M20 ▪ Option P: plug M12x1 + thread G ½" ▪ Option U: plug M12x1 + thread M20
Options A, B, C	Device plugs →  31	Device plugs →  31	Option Q: 2 x plug M12x1
Order code for "Housing": <ul style="list-style-type: none"> ▪ Option A: compact, coated aluminum ▪ Option B: compact, hygienic, stainless ▪ Option C ultra-compact, hygienic, stainless 			

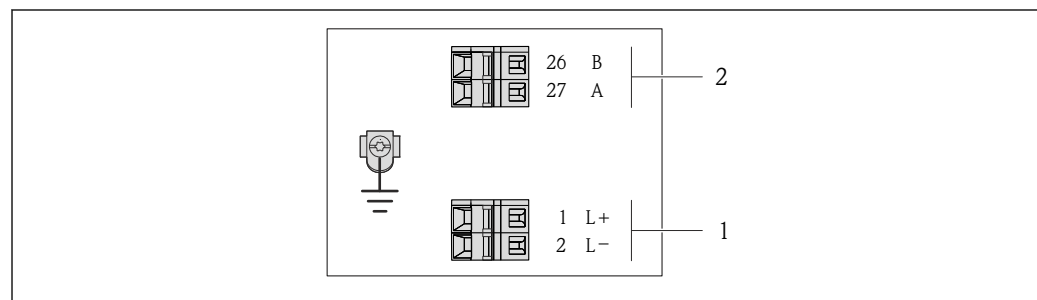

A0019528

 4 Modbus RS485 terminal assignment, connection version for use in non-hazardous areas and Zone 2/Div. 2

- 1 Power supply: DC 24 V
- 2 Modbus RS485

Order code "Output"	Terminal number			
	Power supply		Output	
	1 (L+)	2 (L-)	26 (B)	27 (A)
Option M	DC 24 V		Modbus RS485	
Order code for "Output": Option M : Modbus RS485, for use in non-hazardous areas and Zone 2/Div. 2				

Modbus RS485 connection version

 For use in the intrinsically safe area. Connection via Safety Barrier Promass 100.

Order code for "Output", option **M**

Depending on the housing version, the transmitters can be ordered with terminals or device plugs.

Order code "Housing"	Connection methods available		Possible options for order code "Electrical connection"
	Output	Power supply	
Options A, B	Terminals	Terminals	<ul style="list-style-type: none"> ▪ Option A: coupling M20x1 ▪ Option B: thread M20x1 ▪ Option C: thread G ½" ▪ Option D: thread NPT ½"
A, B, C	Device plugs →  31		Option I: plug M12x1
Order code for "Housing": <ul style="list-style-type: none"> ▪ Option A: compact, coated aluminum ▪ Option B: compact, hygienic, stainless ▪ Option C: ultra-compact, hygienic, stainless 			

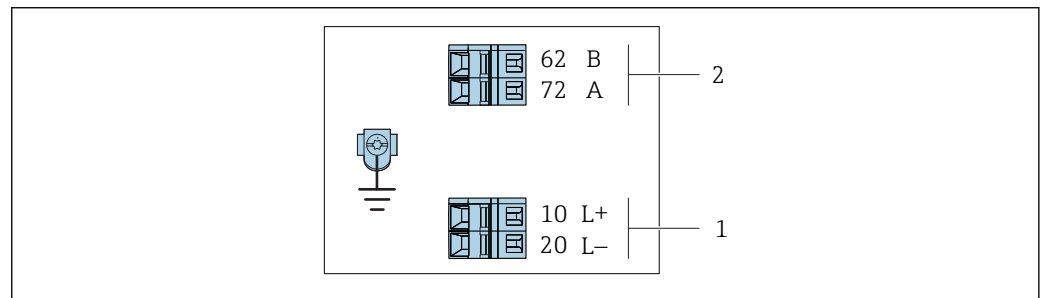

A0030219

 5 *Modbus RS485 terminal assignment, connection version for use in intrinsically safe areas (connection via Safety Barrier Promass 100)*

- 1 *Intrinsically safe power supply*
- 2 *Modbus RS485*

Order code "Output"	10 (L+)	20 (L-)	62 (B)	72 (A)
Option M	Intrinsically safe supply voltage		Modbus RS485 intrinsically safe	
Order code for "Output": Option M : Modbus RS485, for use in the intrinsically safe area (connection via Safety Barrier Promass 100)				

EtherNet/IP connection version

Order code for "Output", option **N**

Depending on the housing version, the transmitters can be ordered with terminals or device plugs.

Order code "Housing"	Connection methods available		Possible options for order code "Electrical connection"
	Output	Power supply	
Options A, B	Device plugs → 32	Terminals	<ul style="list-style-type: none"> ▪ Option L: plug M12x1 + thread NPT ½" ▪ Option N: plug M12x1 + coupling M20 ▪ Option P: plug M12x1 + thread G ½" ▪ Option U: plug M12x1 + thread M20
Options A, B, C	Device plugs → 32	Device plugs → 32	Option Q : 2 x plug M12x1
Order code for "Housing": <ul style="list-style-type: none"> ▪ Option A: compact, coated aluminum ▪ Option B: compact, hygienic, stainless ▪ Option C: ultra-compact, hygienic, stainless 			

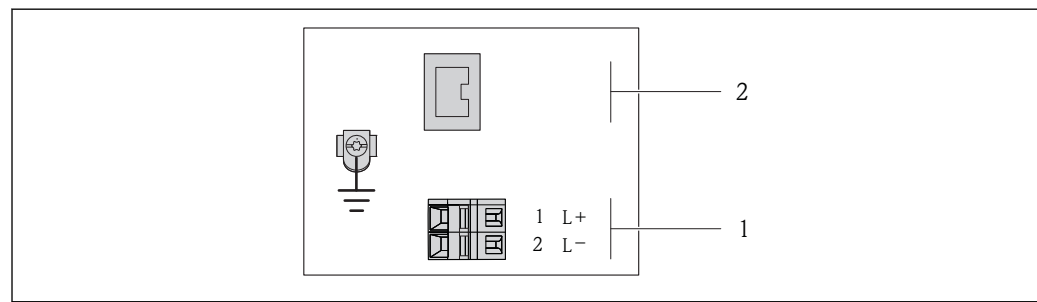

A0017054

6 EtherNet/IP terminal assignment



- 1 Power supply: DC 24 V
- 2 EtherNet/IP

Order code "Output"	Terminal number		Output Device plug M12x1
	Power supply 2 (L-)	1 (L+)	
Option N	DC 24 V		EtherNet/IP
Order code for "Output": Option N : EtherNet/IP			

PROFINET connection version

Order code for "Output", option **R**

Depending on the housing version, the transmitters can be ordered with terminals or device plugs.

Order code for "Housing"	Connection methods available		Possible options for order code "Electrical connection"
	Output	Power supply	
Options A, B	Device plugs →  30	Terminals	<ul style="list-style-type: none"> ▪ Option L: plug M12x1 + thread NPT 1/2" ▪ Option N: plug M12x1 + coupling M20 ▪ Option P: plug M12x1 + thread G 1/2" ▪ Option U: plug M12x1 + thread M20
Options A, B, C	Device plugs →  30	Device plugs →  30	Option Q : 2 x plug M12x1
Order code for "Housing": <ul style="list-style-type: none"> ▪ Option A: compact, coated aluminum ▪ Option B: compact, hygienic, stainless ▪ Option C: ultra-compact, hygienic, stainless 			

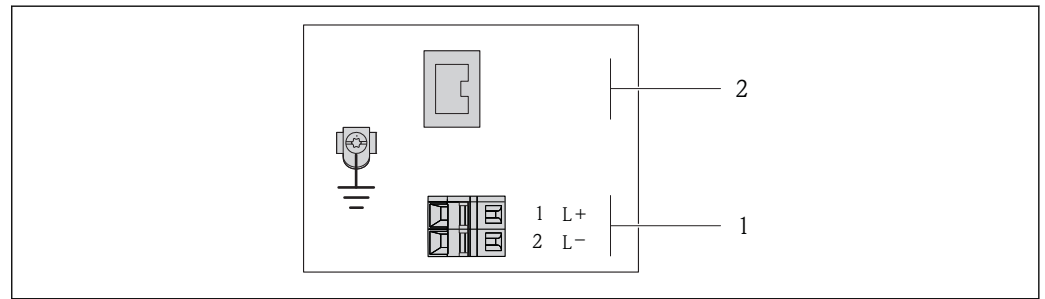

A0017054

 7 *PROFINET terminal assignment*

- 1 Power supply: DC 24 V
- 2 PROFINET

Order code for "Output"	Terminal number		Output Device plug M12x1
	2 (L-)	1 (L+)	
Option R	DC 24 V		PROFINET
Order code for "Output": Option R : PROFINET			

Safety Barrier Promass 100

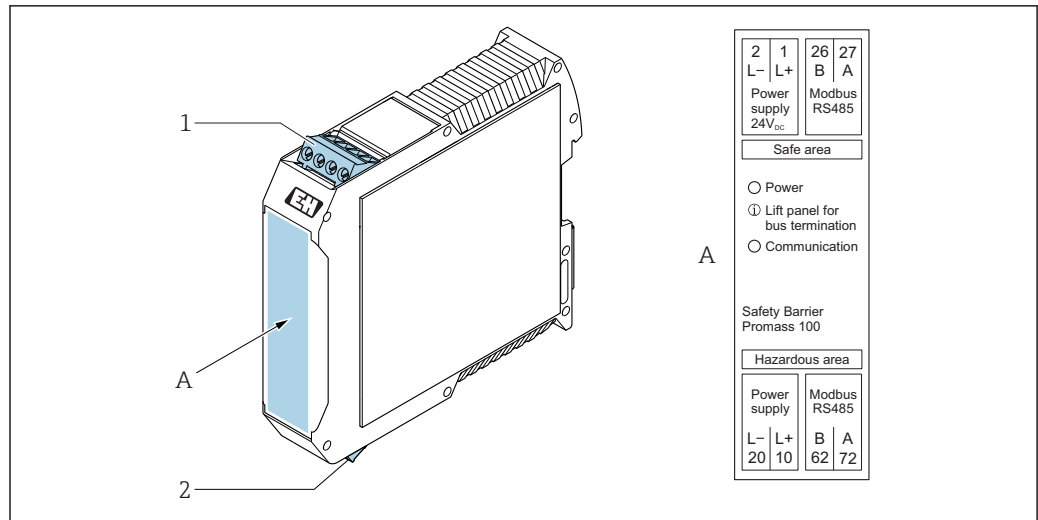

A0030220

8 Safety Barrier Promass 100 with terminals

- 1 Non-hazardous area, Zone 2, Class I Division 2
- 2 Intrinsically safe area

Pin assignment, device plug

- i** Order codes for the M12x1 connectors, see the "Order code for **electrical connection**" column:
 - 4-20 mA HART, pulse/frequency/switch output → 23
 - PROFIBUS DP → 25
 - Modbus RS485 → 26
 - EtherNet/IP → 28
 - PROFINET → 29

Supply voltage

For all connection versions except MODBUS RS485 intrinsically safe (device side)

- i** Device plug MODBUS RS485 intrinsically safe with supply voltage → 31

<p style="text-align: center;">A0016809</p>	Pin	Assignment	
	1	L+	DC 24 V
	2		Not assigned
	3		Not assigned
	4	L-	DC 24 V
	5		Grounding/shielding
Coding		Plug/socket	
A		Plug	

- i** The following is recommended as a socket:
 - Binder, series 763, part no. 79 3440 35 05
 - Alternatively: Phoenix part no. 1669767 SAC-5P-M12MS
 - With the order code for "Output", option **B**: 4-20 mA HART, pulse/frequency/switch output
 - With the order code for "Output", option **N**: EtherNet/IP
 - When using the device in a hazardous location: Use a suitably certified socket.

4-20 mA HART with pulse/frequency/switch output

Device plug for signal transmission (device side)

	Pin		Assignment
	1	+	4-20 mA HART (active)
	2	-	4-20 mA HART (active)
	3	+	Pulse/frequency/switch output (passive)
	4	-	Pulse/frequency/switch output (passive)
	5		Grounding/shielding
Coding		Plug/socket	
A		Socket	

- Recommended plug: Binder, series 763, part no. 79 3439 12 05
- When using the device in a hazardous location, use a suitably certified plug.

PROFIBUS DP

For use in the non-hazardous area and Zone 2/Div. 2.

Device plug for signal transmission (device side)

	Pin		Assignment
	1		Not assigned
	2	A	PROFIBUS DP
	3		Not assigned
	4	B	PROFIBUS DP
	5		Grounding/shielding
Coding		Plug/socket	
B		Socket	

- Recommended plug: Binder, series 763, part no. 79 4449 20 05
- When using the device in a hazardous location, use a suitably certified plug.

MODBUS RS485

Device plug for signal transmission with supply voltage (device side), MODBUS RS485 (intrinsically safe)

	Pin		Assignment
	1	L+	Supply voltage, intrinsically safe
	2	A	Modbus RS485 intrinsically safe
	3	B	
	4	L-	Supply voltage, intrinsically safe
	5		Grounding/shielding
Coding		Plug/socket	
A		Plug	

- Recommended socket: Binder, series 763, part no. 79 3439 12 05
- When using the device in a hazardous location: Use a suitably certified socket.

Device plug for signal transmission (device side), MODBUS RS485 (not intrinsically safe)

 For use in the non-hazardous area and Zone 2/Div. 2.

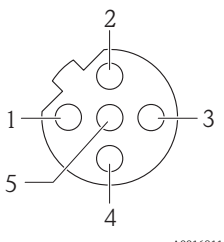
	Pin	Assignment	
	1		Not assigned
	2	A	Modbus RS485
	3		Not assigned
	4	B	Modbus RS485
	5		Grounding/shielding
Coding		Plug/socket	
B		Socket	

-  Recommended plug: Binder, series 763, part no. 79 4449 20 05
- When using the device in a hazardous location, use a suitably certified plug.

EtherNet/IP

Device plug for signal transmission (device side)

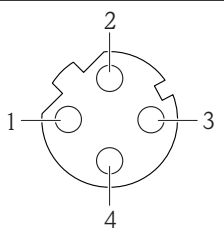
	Pin	Assignment	
	1	+	Tx
	2	+	Rx
	3	-	Tx
	4	-	Rx
	Coding		Plug/socket
D		Socket	

-  Recommended plug:
- Binder, series 763, part no. 99 3729 810 04
 - Phoenix, part no. 1543223 SACC-M12MSD-4Q
 - When using the device in a hazardous location, use a suitably certified plug.

PROFINET

Device plug for signal transmission (device side)

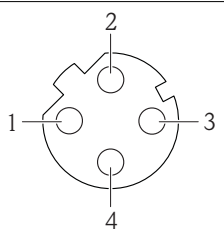
	Pin	Assignment	
	1	+	TD +
	2	+	RD +
	3	-	TD -
	4	-	RD -
	Coding		Plug/socket
D		Socket	

-  Recommended plug:
- Binder, series 763, part no. 99 3729 810 04
 - Phoenix, part no. 1543223 SACC-M12MSD-4Q
 - When using the device in a hazardous location, use a suitably certified plug.

Supply voltage

The power unit must be tested to ensure it meets safety requirements (e.g. PELV, SELV).

Transmitter

For device version with communication type:

- HART, PROFIBUS DP, EtherNet/IP: DC 20 to 30 V
- Modbus RS485, device version:
 - For use in the non-hazardous area and Zone 2/Div. 2: DC 20 to 30 V
 - For use in the intrinsically safe area: power supply via Safety Barrier Promass 100

Promass 100 safety barrier

DC 20 to 30 V

Power consumption

Transmitter

Order code for "Output"	Maximum Power consumption
Option B : 4-20 mA HART with pulse/frequency/switch output	3.5 W
Option L : PROFIBUS DP	3.5 W
Option M Modbus RS485, for use in non-hazardous areas and Zone 2/Div. 2	3.5 W
Option M : Modbus RS485, for use in intrinsically safe areas	2.45 W
Option N : EtherNet/IP	3.5 W
Option R : PROFINET	3.5 W

Promass 100 safety barrier

Order code for "Output"	Maximum Power consumption
Option M : Modbus RS485, for use in intrinsically safe areas	4.8 W

Current consumption

Transmitter

Order code for "Output"	Maximum Current consumption	Maximum switch-on current
Option B : 4-20mA HART, pul./freq./switch output	145 mA	18 A (< 0.125 ms)
Option L : PROFIBUS DP	145 mA	18 A (< 0.125 ms)
Option M Modbus RS485, for use in non-hazardous areas and Zone 2/Div. 2	90 mA	10 A (< 0.8 ms)
Option M : Modbus RS485, for use in intrinsically safe areas	145 mA	16 A (< 0.4 ms)
Option N : EtherNet/IP	145 mA	18 A (< 0.125 ms)
Option R : PROFINET	145 mA	18 A (< 0.125 ms)

Promass 100 safety barrier

Order code for "Output"	Maximum Current consumption	Maximum switch-on current
Option M : Modbus RS485, for use in intrinsically safe areas	230 mA	10 A (< 0.8 ms)

Power supply failure

- Totalizers stop at the last value measured.
- Depending on the device version, the configuration is retained in the device memory or in the plug-in memory (HistoROM DAT).
- Configuration is retained in the plug-in memory (HistoROM DAT).
- Error messages (incl. total operated hours) are stored.

Electrical connection

Connecting the transmitter

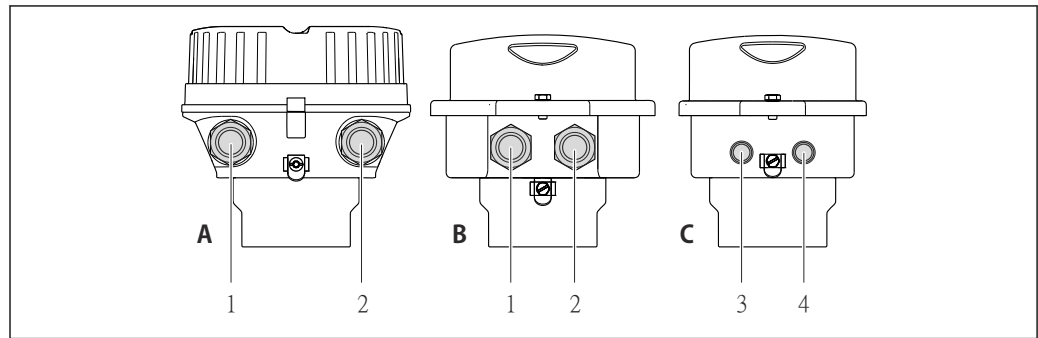

A0016924

- A Housing version: compact, aluminum coated
 B Housing version: compact hygienic, stainless
 1 Cable entry or device plug for signal transmission
 2 Cable entry or device plug for supply voltage
 C Housing version: ultra-compact, hygienic, stainless, M12 device plug
 3 Device plug for signal transmission
 4 Device plug for supply voltage

- i** ■ Terminal assignment → 23
- Pin assignment, device plug → 30

i In the case of device versions with a connector, the transmitter housing does not need to be opened to connect the signal cable or power supply cable.

Connection examples

Current output 4 to 20 mA HART

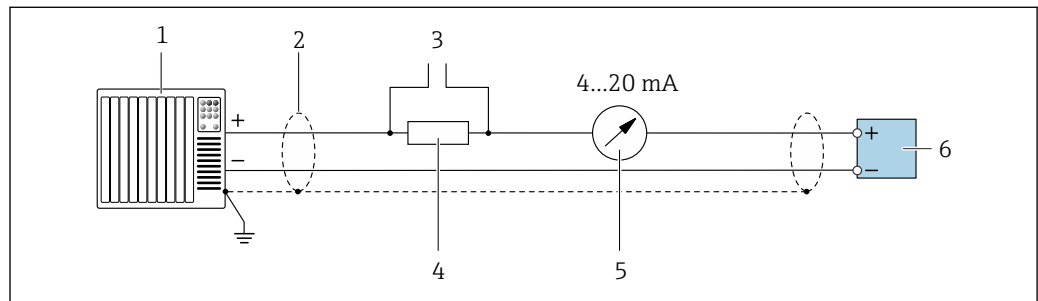

A0029055

9 Connection example for 4 to 20 mA HART current output (active)

- 1 Automation system with current input (e.g. PLC)
- 2 Cable shield: the cable shield must be grounded at both ends to comply with EMC requirements; observe cable specifications → 39
- 3 Connection for HART operating devices → 79
- 4 Resistor for HART communication ($\geq 250 \Omega$): observe maximum load
- 5 Analog display unit: observe maximum load
- 6 Transmitter

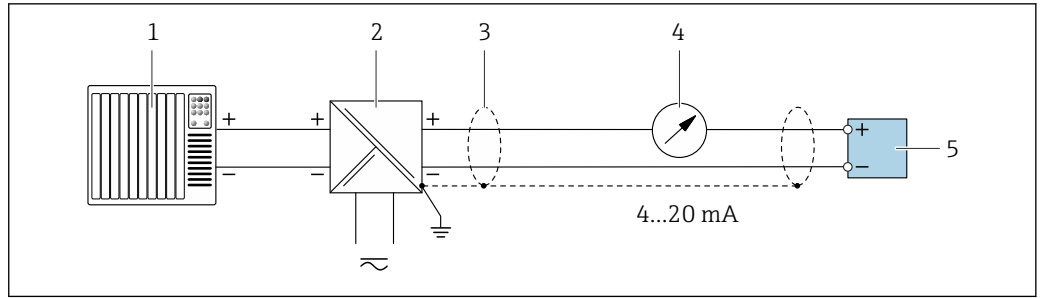

A0028762

10 Connection example for 4 to 20 mA HART current output (passive)

- 1 Automation system with current input (e.g. PLC)
- 2 Power supply
- 3 Cable shield: the cable shield must be grounded at both ends to comply with EMC requirements; observe cable specifications → 39
- 4 Analog display unit: observe maximum load
- 5 Transmitter

Pulse/frequency output

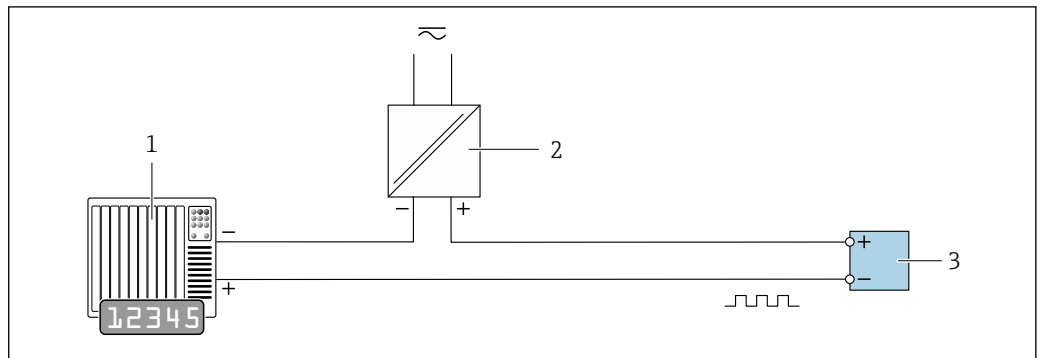

A0028761

11 Connection example for pulse/frequency output (passive)

- 1 Automation system with pulse/frequency input (e.g. PLC)
- 2 Power supply
- 3 Transmitter: Observe input values

Switch output

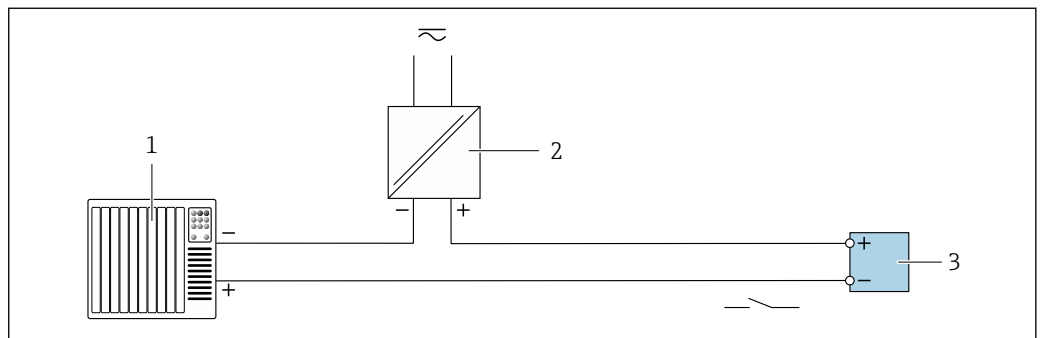

A0028760

12 Connection example for switch output (passive)

- 1 Automation system with switch input (e.g. PLC)
- 2 Power supply
- 3 Transmitter: Observe input values

PROFIBUS DP

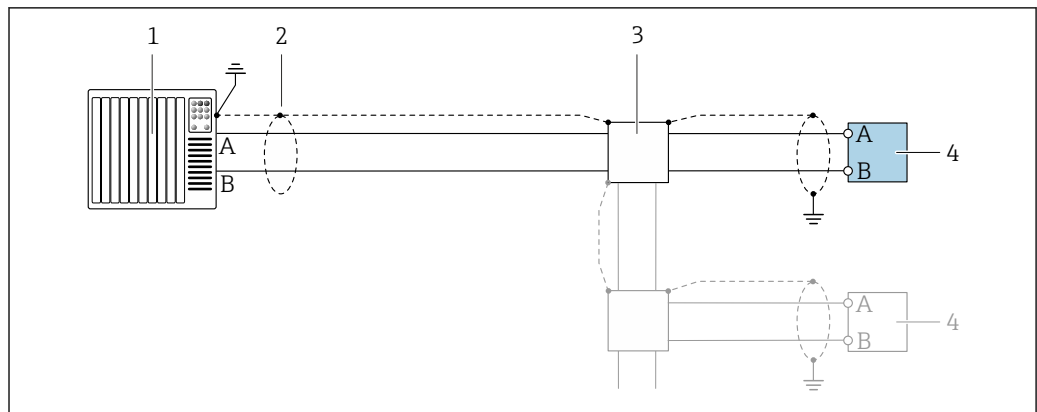

A0028765

13 Connection example for PROFIBUS DP, non-hazardous area and Zone 2/Div. 2

- 1 Control system (e.g. PLC)
- 2 Cable shield: the cable shield must be grounded at both ends to comply with EMC requirements; observe cable specifications
- 3 Transmitter

i If baud rates > 1.5 Mbaud an EMC cable entry must be used and the cable shield must continue as far as the terminal wherever possible.

Modbus RS485

Modbus RS485, non-hazardous area and Zone 2/Div. 2

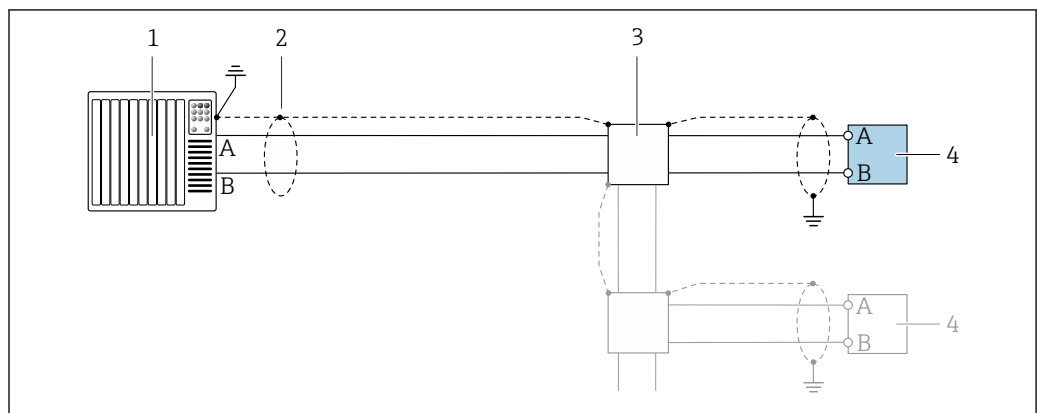

A0028765

14 Connection example for Modbus RS485, non-hazardous area and Zone 2/Div. 2

- 1 Control system (e.g. PLC)
- 2 Cable shield: the cable shield must be grounded at both ends to comply with EMC requirements; observe cable specifications → 39
- 3 Distribution box
- 4 Transmitter

Modbus RS485 intrinsically safe

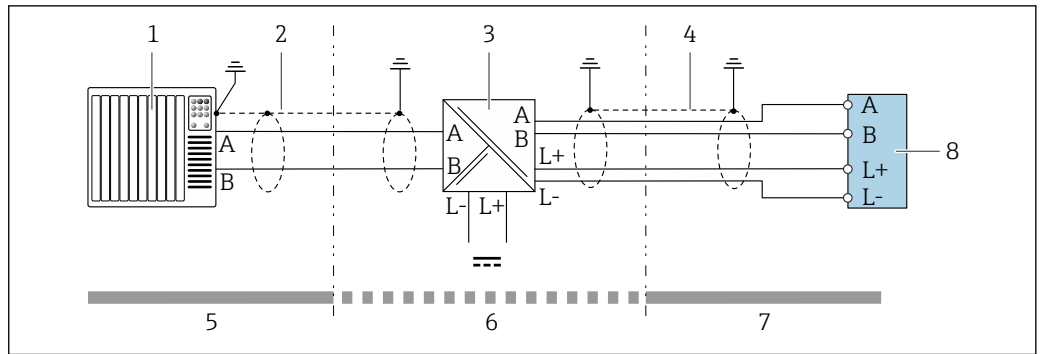

A0028766

15 Connection example for Modbus RS485 intrinsically safe

- 1 Control system (e.g. PLC)
- 2 Cable shield, observe cable specifications
- 3 Safety Barrier Promass 100
- 4 Observe cable specifications
- 5 Non-hazardous area
- 6 Non-hazardous area and Zone 2/Div. 2
- 7 Intrinsically safe area
- 8 Transmitter

EtherNet/IP

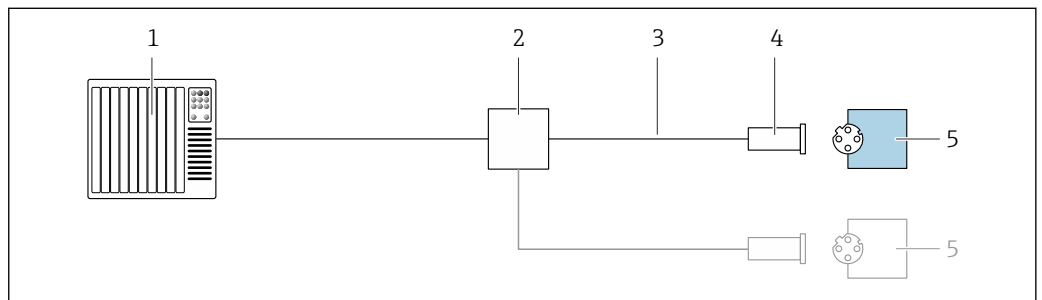

A0028767

16 Connection example for EtherNet/IP

- 1 Control system (e.g. PLC)
- 2 Ethernet switch
- 3 Observe cable specifications
- 4 Device plug
- 5 Transmitter

PROFINET

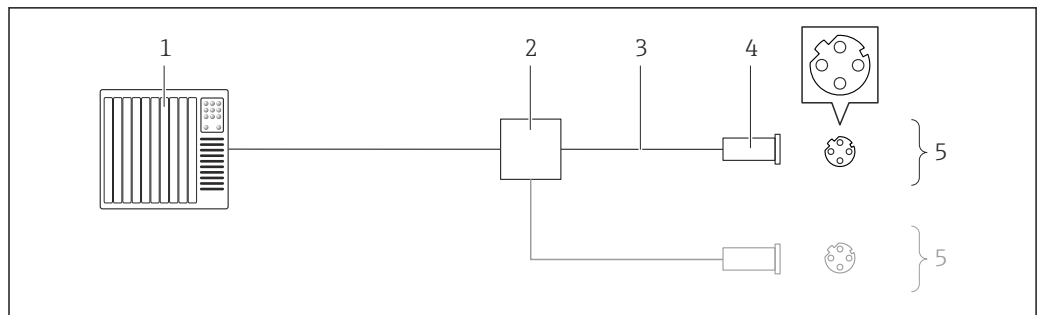

A0016805

17 Connection example for PROFINET

- 1 Control system (e.g. PLC)
- 2 Ethernet switch
- 3 Observe cable specifications
- 4 Device plug
- 5 Transmitter

HART input

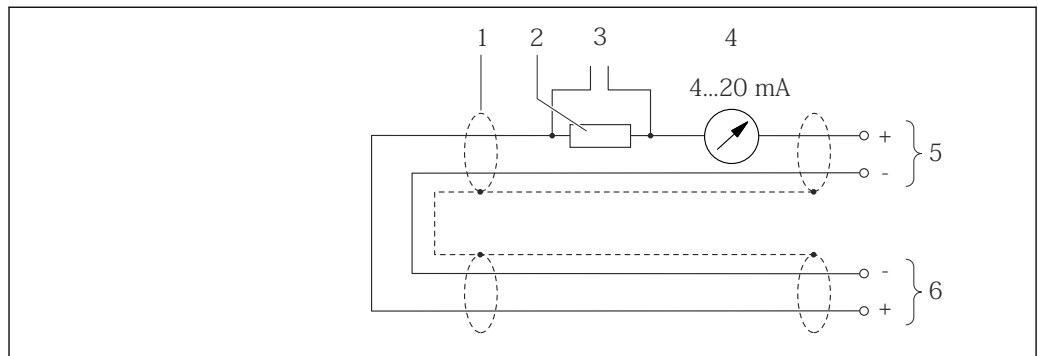

A0019828

18 Connection example for HART input (burst mode) via current output (active)

- 1 Cable shield, observe cable specifications
- 2 Resistor for HART communication ($\geq 250 \Omega$): observe maximum load
- 3 Connection for HART operating devices
- 4 Analog display unit
- 5 Transmitter
- 6 Sensor for external measured variable

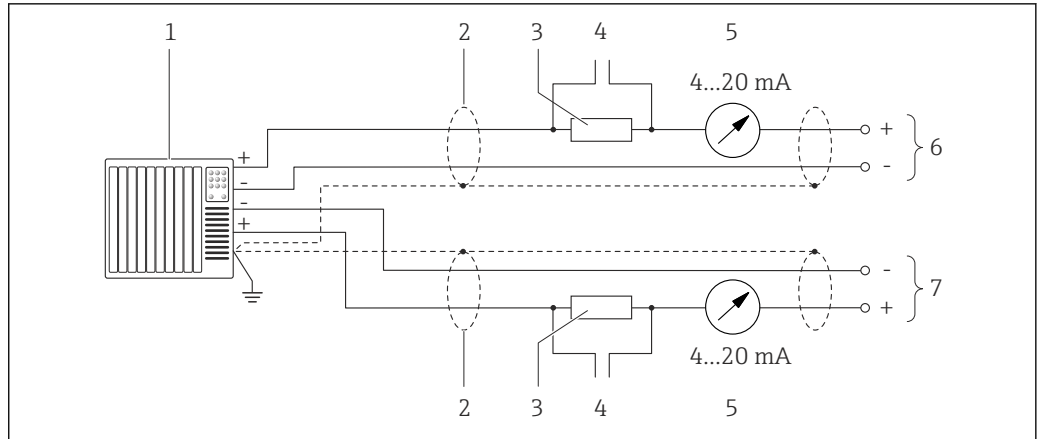

19 Connection example for HART input (master mode) via current output (active)

- 1 Automation system with current input (e.g. PLC).
Prerequisite: automation system with HART version 6, HART commands 113 and 114 can be processed.
- 2 Cable shield, observe cable specifications
- 3 Resistor for HART communication ($\geq 250 \Omega$): observe maximum load
- 4 Connection for HART operating devices
- 5 Analog display unit
- 6 Transmitter
- 7 Sensor for external measured variable

Potential equalization

Requirements

No special measures for potential equalization are required.

Please consider the following to ensure correct measurement:

- Same electrical potential for the medium and sensor
- Company-internal grounding concepts

 For devices intended for use in hazardous locations, please observe the guidelines in the Ex documentation (XA).

Terminals

Transmitter

Spring terminals for wire cross-sections 0.5 to 2.5 mm² (20 to 14 AWG)

Promass 100 safety barrier

Plug-in screw terminals for wire cross-sections 0.5 to 2.5 mm² (20 to 14 AWG)

Cable entries

- Cable gland: M20 × 1.5 with cable ϕ 6 to 12 mm (0.24 to 0.47 in)
- Thread for cable entry:
 - M20
 - G 1/2"
 - NPT 1/2"

Cable specification

Permitted temperature range

- The installation guidelines that apply in the country of installation must be observed.
- The cables must be suitable for the minimum and maximum temperatures to be expected.

Power supply cable

Standard installation cable is sufficient.

Signal cable

Current output 4 to 20 mA HART

A shielded cable is recommended. Observe grounding concept of the plant.

Pulse/frequency/switch output

Standard installation cable is sufficient.

PROFIBUS DP

The IEC 61158 standard specifies two types of cable (A and B) for the bus line which can be used for every transmission rate. Cable type A is recommended.

Cable type	A
Characteristic impedance	135 to 165 Ω at a measuring frequency of 3 to 20 MHz
Cable capacitance	< 30 pF/m
Wire cross-section	> 0.34 mm ² (22 AWG)
Cable type	Twisted pairs
Loop resistance	\leq 110 Ω /km
Signal damping	Max. 9 dB over the entire length of the cable cross-section
Shield	Copper braided shielding or braided shielding with foil shield. When grounding the cable shield, observe the grounding concept of the plant.

Modbus RS485

The EIA/TIA-485 standard specifies two types of cable (A and B) for the bus line which can be used for every transmission rate. Cable type A is recommended.

Cable type	A
Characteristic impedance	135 to 165 Ω at a measuring frequency of 3 to 20 MHz
Cable capacitance	< 30 pF/m
Wire cross-section	> 0.34 mm ² (22 AWG)
Cable type	Twisted pairs
Loop resistance	\leq 110 Ω /km
Signal damping	Max. 9 dB over the entire length of the cable cross-section
Shield	Copper braided shielding or braided shielding with foil shield. When grounding the cable shield, observe the grounding concept of the plant.

EtherNet/IP

The standard ANSI/TIA/EIA-568-B.2 Annex specifies CAT 5 as the minimum category for a cable used for EtherNet/IP. CAT 5e and CAT 6 are recommended.



For more information on planning and installing EtherNet/IP networks, please refer to the "Media Planning and Installation Manual. EtherNet/IP" of ODVA Organization

PROFINET

Standard IEC 61156-6 specifies CAT 5 as the minimum category for a cable used for PROFINET. CAT 5e and CAT 6 are recommended.



For more information on planning and installing PROFINET networks, see: "PROFINET Cabling and Interconnection Technology", Guideline for PROFINET

Connecting cable between Safety Barrier Promass 100 and measuring device

Cable type	Shielded twisted-pair cable with 2x2 wires. When grounding the cable shield, observe the grounding concept of the plant.
Maximum cable resistance	2.5 Ω , one side



Comply with the maximum cable resistance specifications to ensure the operational reliability of the measuring device.



The maximum cable length for individual wire cross-sections is specified in the table below. Observe the maximum capacitance and inductance per unit length of the cable and connection values for hazardous areas .

Wire cross-section		Maximum cable length	
[mm ²]	[AWG]	[m]	[ft]
0.5	20	70	230
0.75	18	100	328
1.0	17	100	328
1.5	16	200	656
2.5	14	300	984

Performance characteristics

reference operating conditions

- Error limits based on ISO 11631
- Water with +15 to +45 °C (+59 to +113 °F) at 2 to 6 bar (29 to 87 psi)
- Specifications as per calibration protocol
- Accuracy based on accredited calibration rigs that are traced to ISO 17025.

 To obtain measured errors, use the *Applicator* sizing tool →  88

Maximum measured error

o.r. = of reading; 1 g/cm³ = 1 kg/l; T = medium temperature

Base accuracy

 Design fundamentals →  44

Mass flow and volume flow (liquids)

- ±0.15 % o.r.
- ±0.10 % o.r. (order code for "Calibration flow", option **A, B, C**, for mass flow)
- ±0.25 % o.r.

Mass flow (gases)

±0.35 % o.r.

Density (liquids)

Under reference operating conditions [g/cm ³]	Standard density calibration ¹⁾ [g/cm ³]
±0.0005	±0.02

1) Valid over the entire temperature and density range

Temperature

±0.5 °C ± 0.005 · T °C (±0.9 °F ± 0.003 · (T - 32) °F)

Zero point stability

DN		Zero point stability	
[mm]	[in]	[kg/h]	[lb/min]
8	$\frac{3}{8}$	0.20	0.007
15	$\frac{1}{2}$	0.65	0.024
25	1	1.80	0.066
40	$1\frac{1}{2}$	4.50	0.165
50	2	7.0	0.257
80	3	18.0	0.6615

Flow values

Flow values as turndown parameter depending on nominal diameter.

SI units

DN [mm]	1:1	1:10	1:20	1:50	1:100	1:500
	[kg/h]	[kg/h]	[kg/h]	[kg/h]	[kg/h]	[kg/h]
8	2 000	200	100	40	20	4
15	6 500	650	325	130	65	13
25	18 000	1 800	900	360	180	36
40	45 000	4 500	2 250	900	450	90
50	70 000	7 000	3 500	1 400	700	140
80	180 000	18 000	9 000	3 600	1 800	360

US units

DN [inch]	1:1	1:10	1:20	1:50	1:100	1:500
	[lb/min]	[lb/min]	[lb/min]	[lb/min]	[lb/min]	[lb/min]
$\frac{3}{8}$	73.50	7.350	3.675	1.470	0.735	0.147
$\frac{1}{2}$	238.9	23.89	11.95	4.778	2.389	0.478
1	661.5	66.15	33.08	13.23	6.615	1.323
$1\frac{1}{2}$	1 654	165.4	82.70	33.08	16.54	3.308
2	2 573	257.3	128.7	51.46	25.73	5.146
3	6 615	661.5	330.8	132.3	66.15	13.23

Accuracy of outputs

The output accuracy must be factored into the measured error if analog outputs are used, but can be ignored for fieldbus outputs (e.g. Modbus RS485, EtherNet/IP).

The outputs have the following base accuracy specifications.

Current output

Accuracy	Max. $\pm 5 \mu\text{A}$
-----------------	--------------------------

Pulse/frequency output



o.r. = of reading

Accuracy	Max. ± 50 ppm o.r. (over the entire ambient temperature range)
-----------------	--

Repeatability

o.r. = of reading; $1 \text{ g/cm}^3 = 1 \text{ kg/l}$; T = medium temperature

Base repeatability

 Design fundamentals →  44

Mass flow and volume flow (liquids)

± 0.075 % o.r.
 ± 0.05 % o.r. (calibration option, for mass flow)

Mass flow (gases)

± 0.35 % o.r.

Density (liquids)

$\pm 0.00025 \text{ g/cm}^3$

Temperature

$\pm 0.25 \text{ }^\circ\text{C} \pm 0.0025 \cdot T \text{ }^\circ\text{C}$ ($\pm 0.45 \text{ }^\circ\text{F} \pm 0.0015 \cdot (T-32) \text{ }^\circ\text{F}$)

Response time

The response time depends on the configuration (damping).

Influence of ambient temperature

Current output

o.r. = of reading

Temperature coefficient	Max. ± 0.005 % o.r./ $^\circ\text{C}$
--------------------------------	---

Pulse/frequency output

Temperature coefficient	No additional effect. Included in accuracy.
--------------------------------	---

Influence of medium temperature

Mass flow and volume flow

o.f.s. = of full scale value

When there is a difference between the temperature for zero point adjustment and the process temperature, the additional measured error of the sensor is typically ± 0.0002 % o.f.s./ $^\circ\text{C}$ (± 0.0001 % o. f.s./ $^\circ\text{F}$).

The effect is reduced if zero point adjustment is performed at process temperature.

Density

When there is a difference between the density calibration temperature and the process temperature, the typical measured error of the sensor is $\pm 0.0001 \text{ g/cm}^3 / ^\circ\text{C}$ ($\pm 0.00005 \text{ g/cm}^3 / ^\circ\text{F}$). Field density calibration is possible.

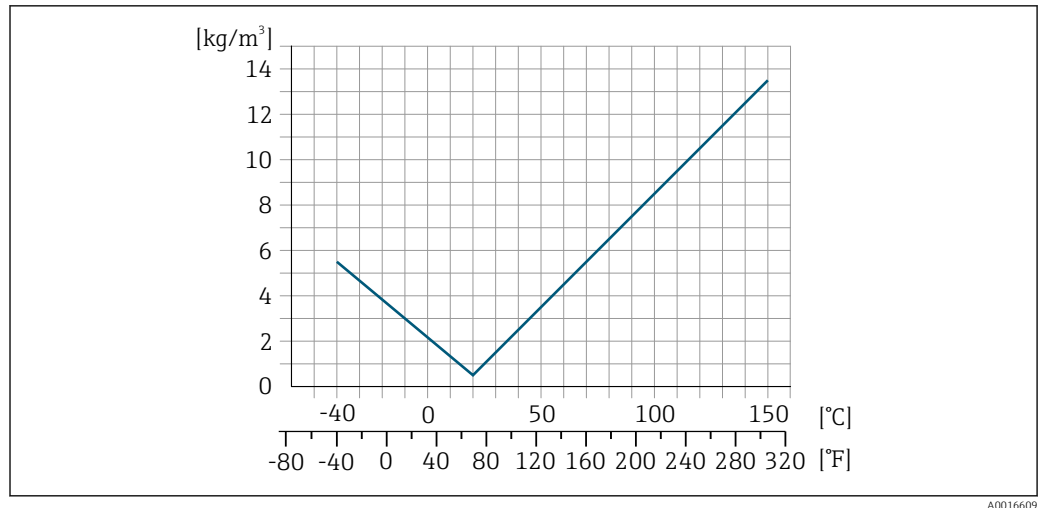

20 Field density calibration, for example at +20 °C (+68 °F)

Temperature

$\pm 0.005 \cdot T \text{ } ^\circ\text{C}$ ($\pm 0.005 \cdot (T - 32) \text{ } ^\circ\text{F}$)

Influence of medium pressure

The table below shows the effect on accuracy of mass flow due to a difference between calibration pressure and process pressure.

o.r. = of reading



It is possible to compensate for the effect by:

- Reading in the current pressure measured value via the current input.
- Specifying a fixed value for the pressure in the device parameters.



Operating Instructions .

DN		[% o.r./bar]	[% o.r./psi]
[mm]	[in]		
8	3/8	no influence	
15	1/2	no influence	
25	1	no influence	
40	1 1/2	no influence	
50	2	-0.009	-0.0006
80	3	-0.020	-0.0014

Design fundamentals

o.r. = of reading, o.f.s. = of full scale value

BaseAccu = base accuracy in % o.r., BaseRepeat = base repeatability in % o.r.

MeasValue = measured value; ZeroPoint = zero point stability

Calculation of the maximum measured error as a function of the flow rate

Flow rate	Maximum measured error in % o.r.
$\geq \frac{\text{ZeroPoint}}{\text{BaseAccu}} \cdot 100$ <small>A0021332</small>	$\pm \text{BaseAccu}$ <small>A0021339</small>
$< \frac{\text{ZeroPoint}}{\text{BaseAccu}} \cdot 100$ <small>A0021333</small>	$\pm \frac{\text{ZeroPoint}}{\text{MeasValue}} \cdot 100$ <small>A0021334</small>

Calculation of the maximum repeatability as a function of the flow rate

Flow rate	Maximum repeatability in % o.r.
$\geq \frac{1/2 \cdot \text{ZeroPoint}}{\text{BaseRepeat}} \cdot 100$ <small>A0021335</small>	$\pm \text{BaseRepeat}$ <small>A0021340</small>
$< \frac{1/2 \cdot \text{ZeroPoint}}{\text{BaseRepeat}} \cdot 100$ <small>A0021336</small>	$\pm 1/2 \cdot \frac{\text{ZeroPoint}}{\text{MeasValue}} \cdot 100$ <small>A0021337</small>

Example for maximum measured error

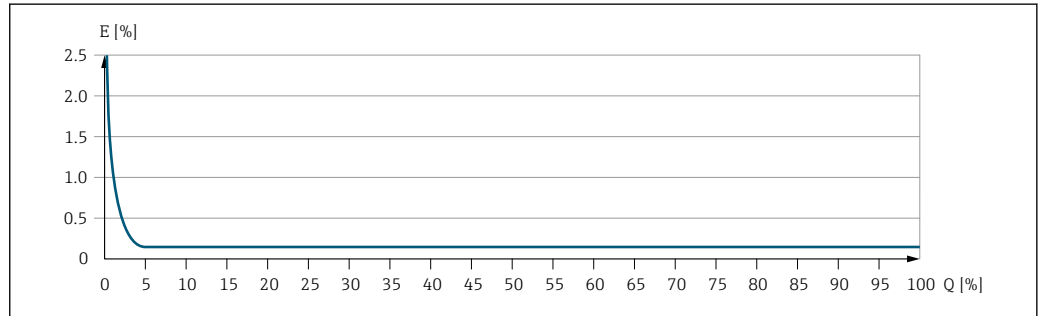

E Maximum measured error in % o.r. (example)
 Q Flow rate in % of maximum full scale value

Installation

No special measures such as supports etc. are necessary. External forces are absorbed by the construction of the device.

Mounting location

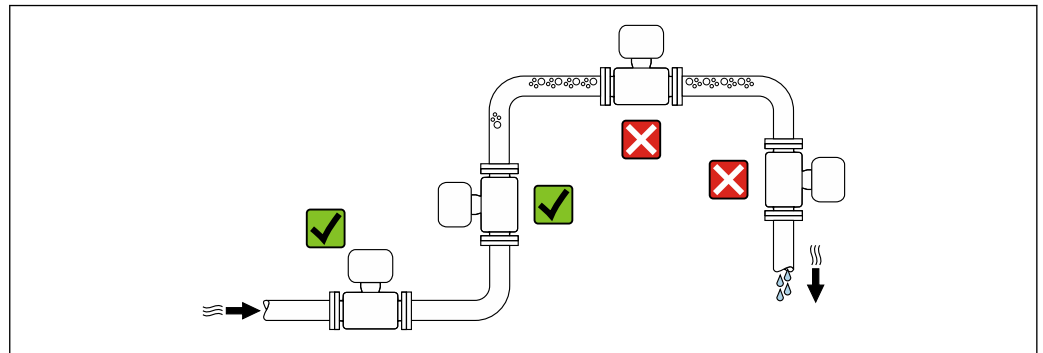

To prevent measuring errors arising from accumulation of gas bubbles in the measuring tube, avoid the following mounting locations in the pipe:

- Highest point of a pipeline.
- Directly upstream of a free pipe outlet in a down pipe.

Installation in down pipes

However, the following installation suggestion allows for installation in an open vertical pipeline. Pipe restrictions or the use of an orifice with a smaller cross-section than the nominal diameter prevent the sensor running empty while measurement is in progress.

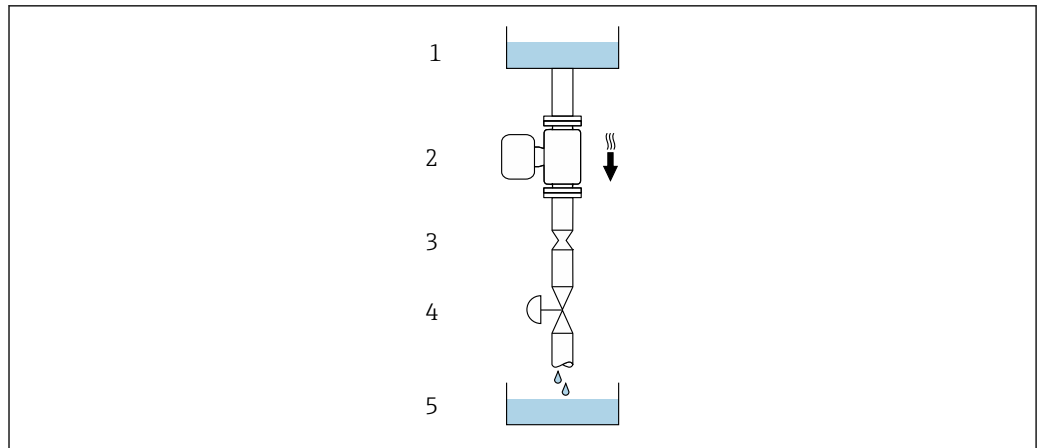

A0028773

21 Installation in a down pipe (e.g. for batching applications)

- 1 Supply tank
- 2 Sensor
- 3 Orifice plate, pipe restriction
- 4 Valve
- 5 Batching tank

DN		Ø orifice plate, pipe restriction	
[mm]	[in]	[mm]	[in]
8	3/8	6	0.24
15	1/2	10	0.40
25	1	14	0.55
40	1 1/2	22	0.87
50	2	28	1.10
80	3	50	1.97

Orientation

The direction of the arrow on the sensor nameplate helps you to install the sensor according to the flow direction (direction of medium flow through the piping).

Orientation			Recommendation
A	Vertical orientation	 A0015591	☑☑
B	Horizontal orientation, transmitter at top	 A0015589	☑☑ ¹⁾ Exceptions: → ☒ 22, ☒ 47
C	Horizontal orientation, transmitter at bottom	 A0015590	☑☑ ²⁾ Exceptions: → ☒ 22, ☒ 47
D	Horizontal orientation, transmitter at side	 A0015592	☒

- 1) Applications with low process temperatures may decrease the ambient temperature. To maintain the minimum ambient temperature for the transmitter, this orientation is recommended.
- 2) Applications with high process temperatures may increase the ambient temperature. To maintain the maximum ambient temperature for the transmitter, this orientation is recommended.

If a sensor is installed horizontally with a curved measuring tube, match the position of the sensor to the fluid properties.

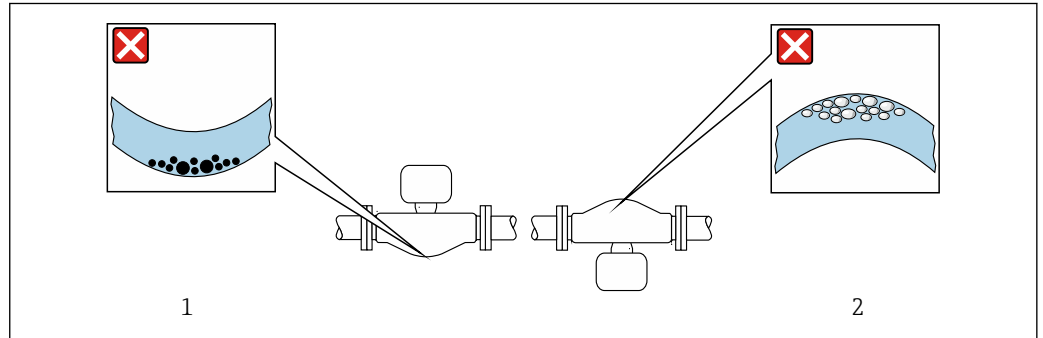

22 Orientation of sensor with curved measuring tube

- 1 Avoid this orientation for fluids with entrained solids: Risk of solids accumulating.
- 2 Avoid this orientation for outgassing fluids: Risk of gas accumulating.

A0028774

Inlet and outlet runs

No special precautions need to be taken for fittings which create turbulence, such as valves, elbows or T-pieces, as long as no cavitation occurs → 53.

Special mounting instructions

Rupture disk

Information that is relevant to the process: → 53.

The position of the rupture disk is indicated on a sticker applied over it. If the rupture disk is triggered, the sticker is destroyed. The disk can therefore be visually monitored.

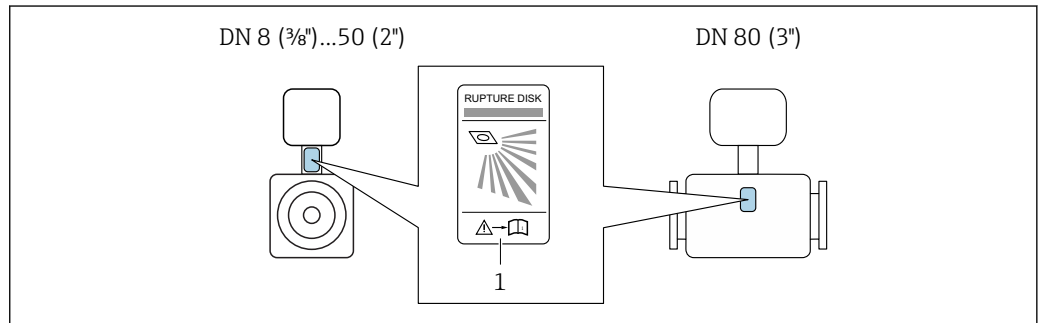

1 Rupture disk label

A0029956

Zero point adjustment

All measuring devices are calibrated in accordance with state-of-the-art technology. Calibration takes place under reference conditions → 41. Therefore, a zero point adjustment in the field is generally not required.

Experience shows that zero point adjustment is advisable only in special cases:

- To achieve maximum measuring accuracy even with low flow rates.
- Under extreme process or operating conditions (e.g. very high process temperatures or very high-viscosity fluids).

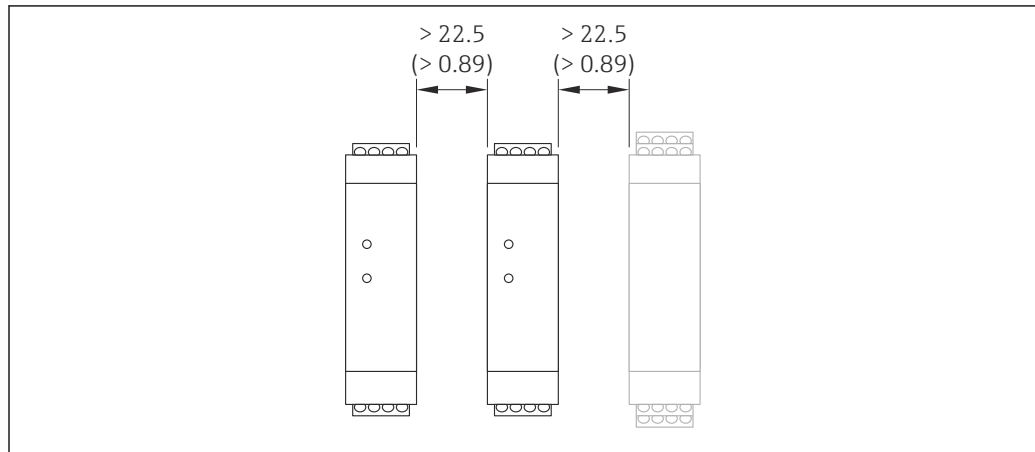
**Mounting Safety Barrier
Promass 100**

A0016894

23 Minimum distance between additional Safety Barrier Promass 100 or other modules. Engineering unit mm (in)

Environment

Ambient temperature range	Measuring device	<ul style="list-style-type: none"> ■ -40 to +60 °C (-40 to +140 °F) ■ Order code for "Test, certificate", option JM: -50 to +60 °C (-58 to +140 °F)
	Safety Barrier Promass 100	-40 to +60 °C (-40 to +140 °F)

- ▶ If operating outdoors:
Avoid direct sunlight, particularly in warm climatic regions.

Storage temperature -40 to +80 °C (-40 to +176 °F), preferably at +20 °C (+68 °F)

Climate class DIN EN 60068-2-38 (test Z/AD)

Degree of protection

Transmitter and sensor

- As standard: IP66/67, type 4X enclosure
- With the order code for "Sensor options", option **CM**: IP69 can also be ordered
- When housing is open: IP20, type 1 enclosure
- Display module: IP20, type 1 enclosure

Safety Barrier Promass 100
IP20

Vibration resistance

- Vibration, sinusoidal according to IEC 60068-2-6
 - 2 to 8.4 Hz, 3.5 mm peak
 - 8.4 to 2 000 Hz, 1 g peak
- Vibration broad-band random, according to IEC 60068-2-64
 - 10 to 200 Hz, 0.003 g²/Hz
 - 200 to 2 000 Hz, 0.001 g²/Hz
 - Total: 1.54 g rms

Shock resistance Shock, half-sine according to IEC 60068-2-27
6 ms 30 g

Impact resistance Rough handling shocks according to IEC 60068-2-31

Interior cleaning

- Cleaning in place (CIP)
- Sterilization in place (SIP)

Options

Oil- and grease-free version for wetted parts, without declaration
 Order code for "Service", option **HA**

Electromagnetic compatibility (EMC)

- Depends on the communication protocol:
 - HART, PROFIBUS DP, EtherNet/IP:
As per IEC/EN 61326 and NAMUR Recommendation 21 (NE 21)
 - Modbus RS485:
As per IEC/EN 61326 and NAMUR Recommendation 21 (NE 21)
 - PROFINET: as per IEC/EN 61326
- Complies with emission limits for industry as per EN 55011 (Class A)
- Device version with PROFIBUS DP: Complies with emission limits for industry as per EN 50170 Volume 2, IEC 61784

 The following applies for PROFIBUS DP: If baud rates > 1.5 MBaud, an EMC cable entry must be used and the cable shield must continue as far as the terminal wherever possible.

 Details are provided in the Declaration of Conformity.

Process

Medium temperature range

-40 to +150 °C (-40 to +302 °F)

Dependency of ambient temperature on medium temperature

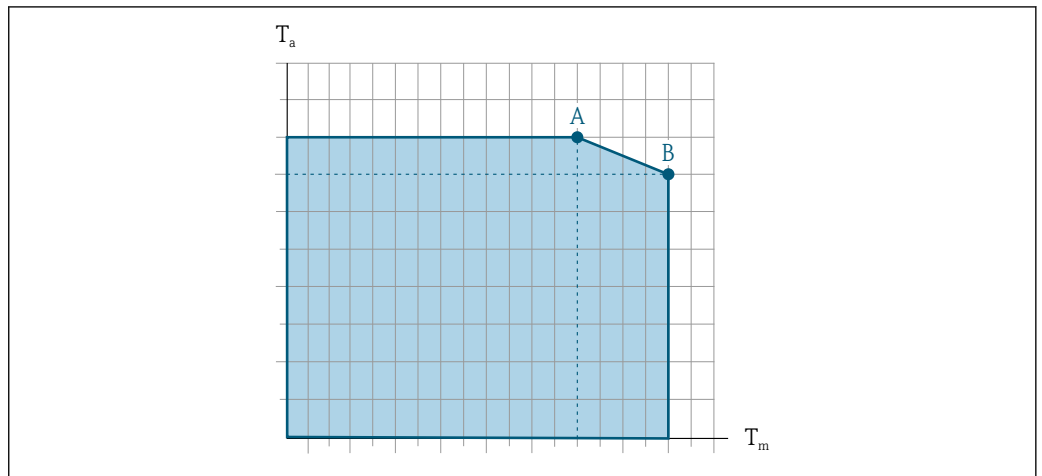

 24 Exemplary representation, values in the table below.

T_a Ambient temperature

T_m Medium temperature

A Maximum permitted medium temperature T_m at $T_{a\max} = 60\text{ °C}$ (140 °F); higher medium temperatures T_m require a reduced ambient temperature T_a

B Maximum permitted ambient temperature T_a for the maximum specified medium temperature T_m of the sensor

 Values for devices used in the hazardous area:
 Separate Ex documentation (XA) for the device .

Density

0 to 5 000 kg/m³ (0 to 312 lb/cf)

Pressure-temperature curves The following pressure/temperature diagrams apply to all pressure-bearing parts of the device and not just the process connection. The diagrams show the maximum permissible medium pressure depending on the specific medium temperature.

Flange according to EN 1092-1 (DIN 2501)

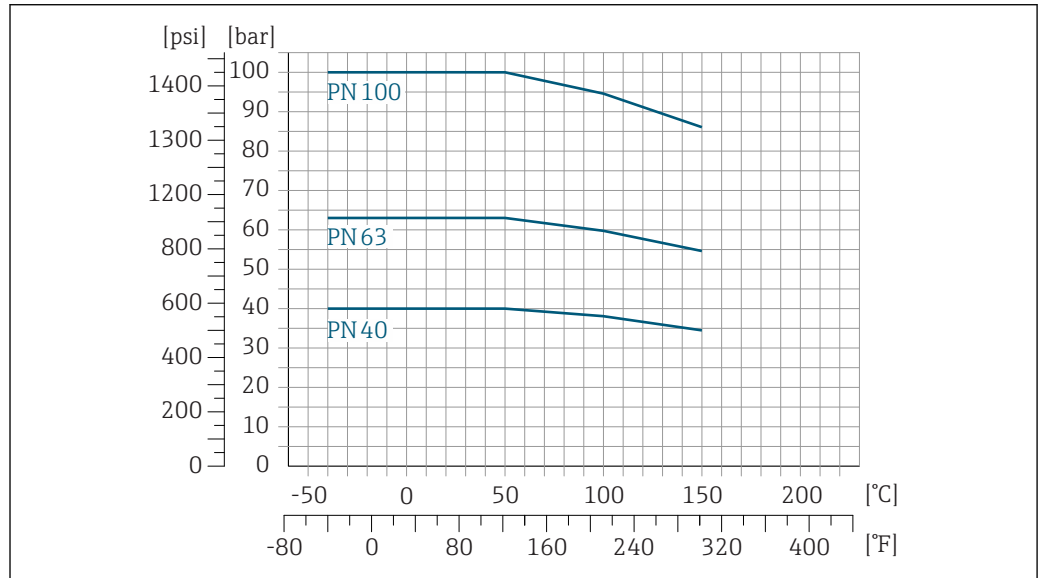

25 With flange material 1.4404 (F316/F316L)

Flange according to ASME B16.5

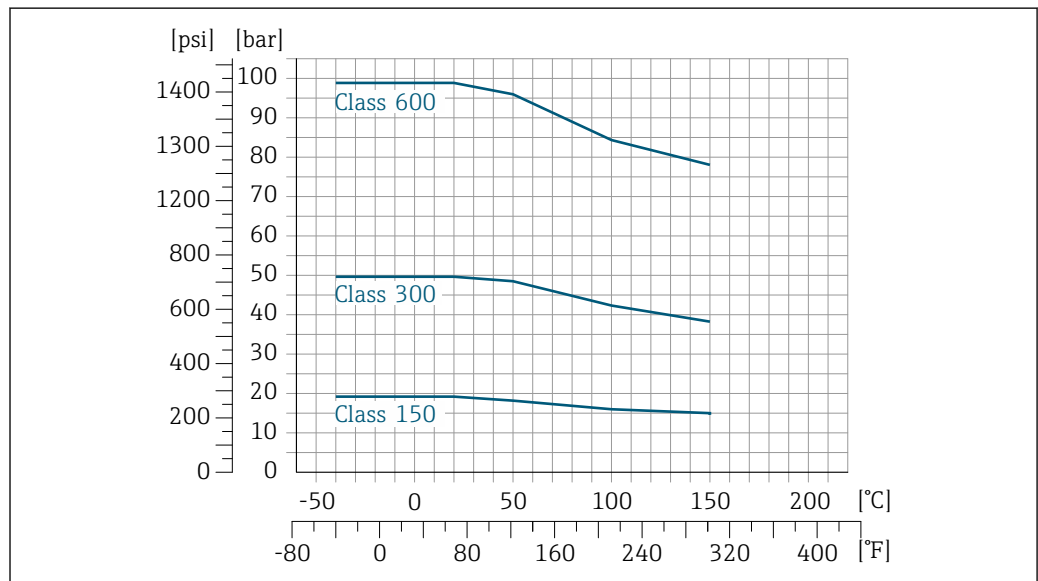

26 With flange material 1.4404 (F316/F316L)

Flange JIS B2220

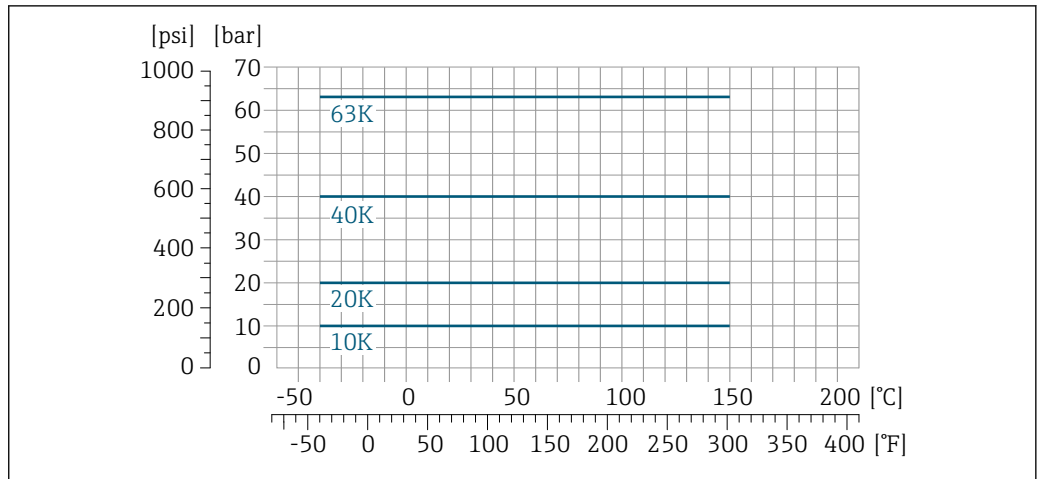

27 With flange material 1.4404 (F316/F316L)

Flange DIN 11864-2 Form A

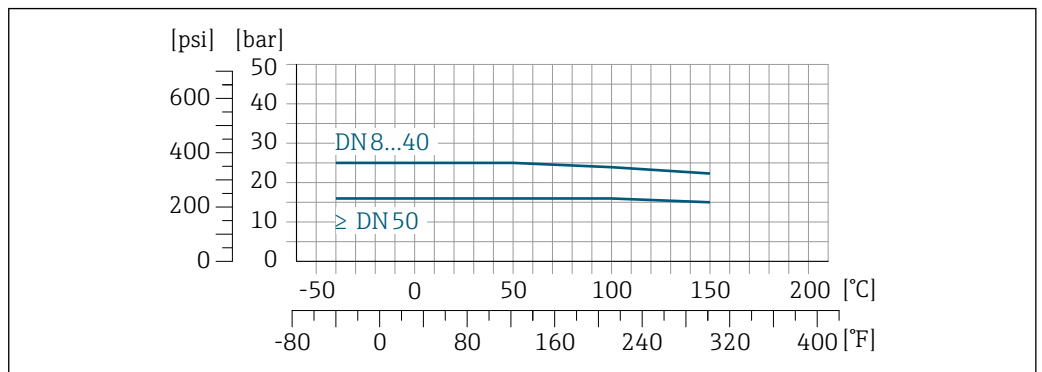

28 With flange material 1.4404 (316/316L)

Thread DIN 11851

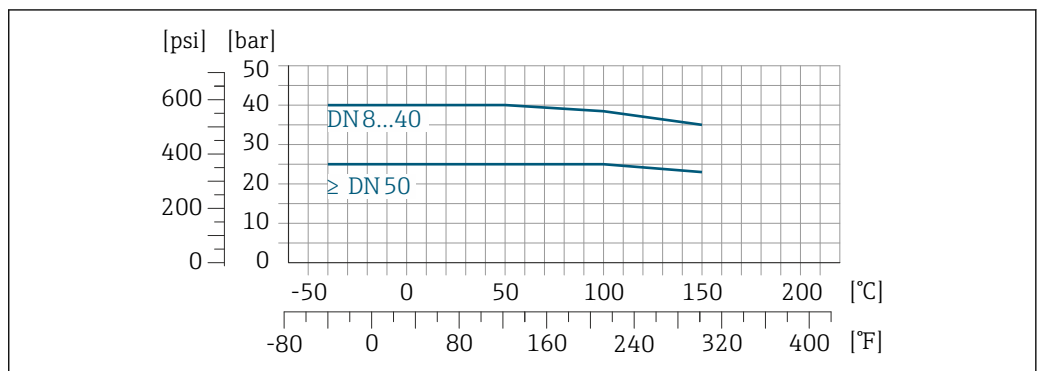

29 With connection material 1.4404 (316/316L)

DIN 11851 allows for applications up to +140 °C (+284 °F) if suitable sealing materials are used. Please take this into account when selecting seals and counterparts, as these components can limit the pressure and temperature range.

Thread DIN 11864-1 Form A

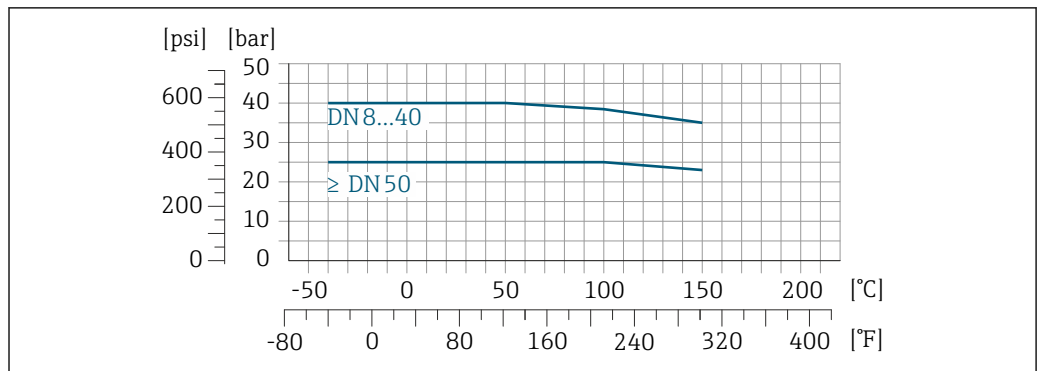

A0029948-EN

30 With connection material 1.4404 (316/316L)

Thread ISO 2853

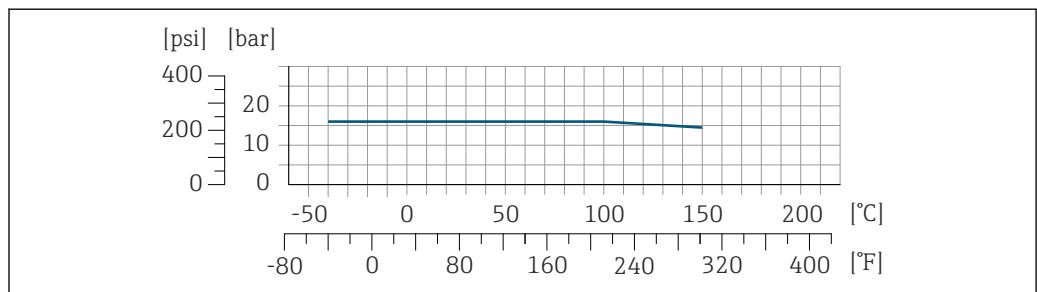

A0029853-EN

31 With connection material 1.4404 (316/316L)

Thread SMS 1145

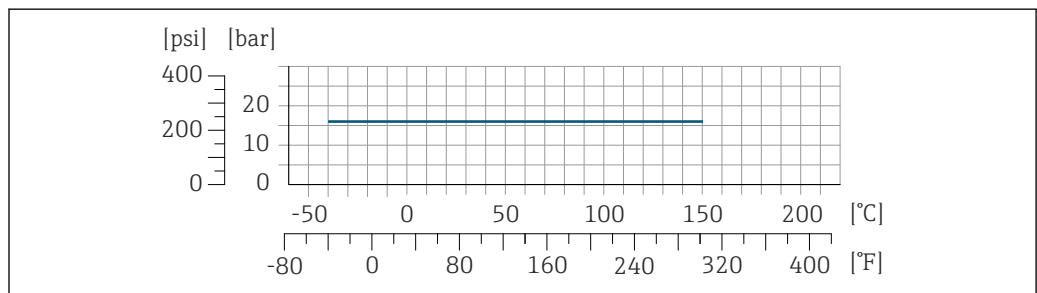

A0032218-EN

32 With connection material 1.4404 (316/316L)

VCO

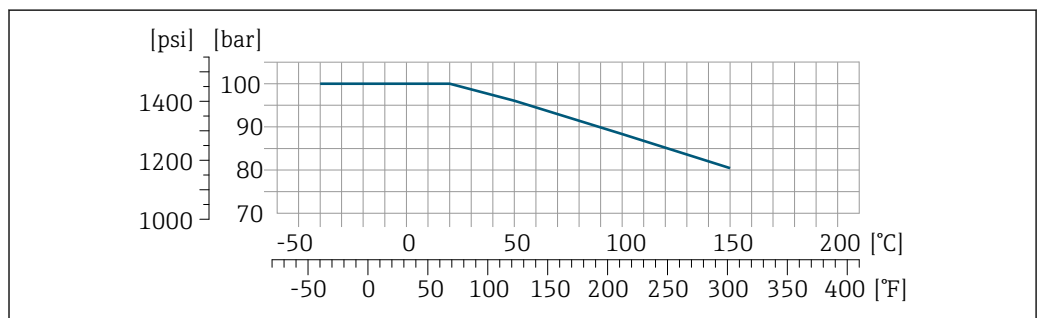

A0029863-EN

33 With connection material 1.4404 (316/316L)

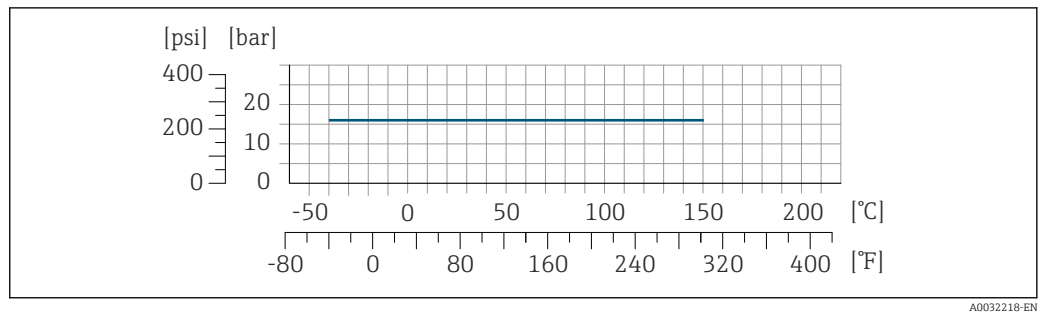
Tri-Clamp

The clamp connections are suitable up to a maximum pressure of 16 bar (232 psi). Please observe the operating limits of the clamp and seal used as they can be over 16 bar (232 psi). The clamp and seal are not included in the scope of supply.

Secondary containment

The sensor housing is filled with dry nitrogen gas and protects the electronics and mechanics inside. The secondary containment does not have a pressure rating classification.

Reference value for the pressure loading capacity of the sensor housing: 16 bar (232 psi)

If the device is fitted with a rupture disk (order code for "Sensor option", option **CA** "Rupture disk"), the rupture disk trigger pressure is decisive for the maximum nominal pressure → [8](#) 53.

i If a measuring tube fails (e.g. due to process characteristics like corrosive or abrasive fluids), the fluid will be contained by the secondary containment.

Rupture disk

To increase the level of safety, a device version with a rupture disk with a trigger pressure of 10 to 15 bar (145 to 217.5 psi) can be used (order code for "Sensor option", option **CA** "rupture disk").

Rupture disks cannot be combined with the separately available heating jacket.

Special mounting instructions: → [8](#) 47

Flow limit

Select the nominal diameter by optimizing between the required flow range and permissible pressure loss.

i For an overview of the full scale values for the measuring range, see the "Measuring range" section → [8](#) 8

- The minimum recommended full scale value is approx. 1/20 of the maximum full scale value
- In most applications, 20 to 50 % of the maximum full scale value can be considered ideal
- A low full scale value must be selected for abrasive media (such as liquids with entrained solids): flow velocity < 1 m/s (< 3 ft/s).
- For gas measurement the following rules apply:
 - The flow velocity in the measuring tubes should not exceed half the sound velocity (0.5 Mach).
 - The maximum mass flow depends on the density of the gas: formula → [8](#) 8

i To calculate the flow limit, use the *Applicator* sizing tool → [8](#) 88

Pressure loss

i To calculate the pressure loss, use the *Applicator* sizing tool → [8](#) 88

System pressure

It is important that cavitation does not occur, or that gases entrained in the liquids do not outgas. This is prevented by means of a sufficiently high system pressure.

For this reason, the following mounting locations are recommended:

- At the lowest point in a vertical pipe
- Downstream from pumps (no danger of vacuum)

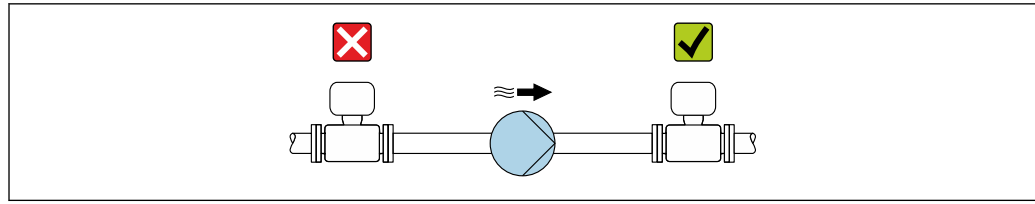

A0028777

Thermal insulation

In the case of some fluids, it is important to keep the heat radiated from the sensor to the transmitter to a low level. A wide range of materials can be used for the required insulation.

NOTICE

Electronics overheating on account of thermal insulation!

- ▶ Recommended orientation: horizontal orientation, transmitter housing pointing downwards.
- ▶ Do not insulate the transmitter housing .
- ▶ Maximum permissible temperature at the lower end of the transmitter housing: 80 °C (176 °F)
- ▶ Thermal insulation with extended neck free: the insulation is omitted around the extended neck. We recommend that you do not insulate the extended neck in order to ensure optimum dissipation of heat.

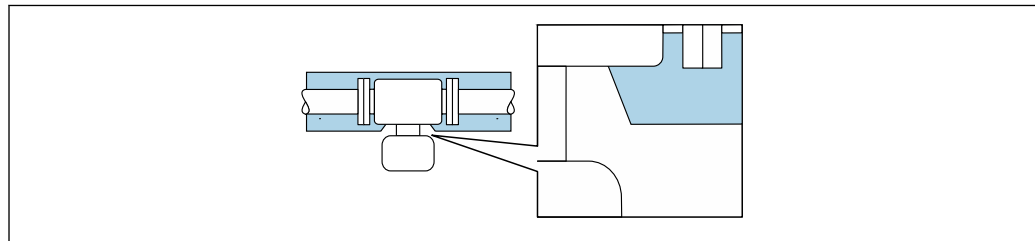

A0034391

34 Thermal insulation with extended neck free

Heating

Some fluids require suitable measures to avoid loss of heat at the sensor.

Heating options

- Electrical heating, e.g. with electric band heaters
- Via pipes carrying hot water or steam
- Via heating jackets



Heating jackets for the sensors can be ordered as accessories from Endress+Hauser .-> 87

NOTICE

Danger of overheating when heating

- ▶ Ensure that the temperature at the lower end of the transmitter housing does not exceed 80 °C (176 °F).
- ▶ Ensure that convection takes place on a sufficiently large scale at the transmitter neck.
- ▶ Ensure that a sufficiently large area of the housing support remains exposed. The uncovered part serves as a radiator and protects the electronics from overheating and excessive cooling.

Vibrations

The high oscillation frequency of the measuring tubes ensures that the correct operation of the measuring system is not influenced by plant vibrations.

Mechanical construction

Dimensions in SI units

Compact version

Order code for "Housing", option A "Compact coated aluminum"

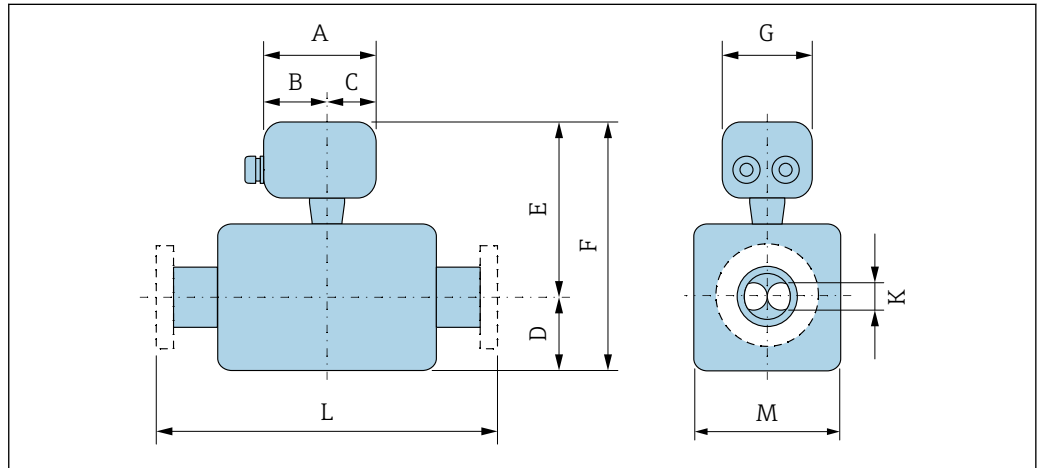

A0033787

DN [mm]	A [mm]	B [mm]	C [mm]	D [mm]	E ¹⁾ [mm]	F ¹⁾ [mm]	G [mm]	K [mm]	L [mm]	M [mm]
8	147.5	93.5	54	89.1	177.1	266.2	136	5.35	²⁾	44.9
15	147.5	93.5	54	100.1	177.1	277.2	136	8.3	²⁾	44.9
25	147.5	93.5	54	102.1	174.2	276.2	136	12	²⁾	51
40	147.5	93.5	54	120.7	180.2	300.8	136	17.6	²⁾	64.3
50	147.5	93.5	54	175.5	194.5	369.9	136	26	²⁾	91.1
80	147.5	93.5	54	205.3	210	415.3	136	40.5	²⁾	127

1) If using a display, order code for "Display; operation", option B: values +28 mm

2) Dependent on the respective process connection

Order code for "Housing", option B "Compact hygienic, stainless"

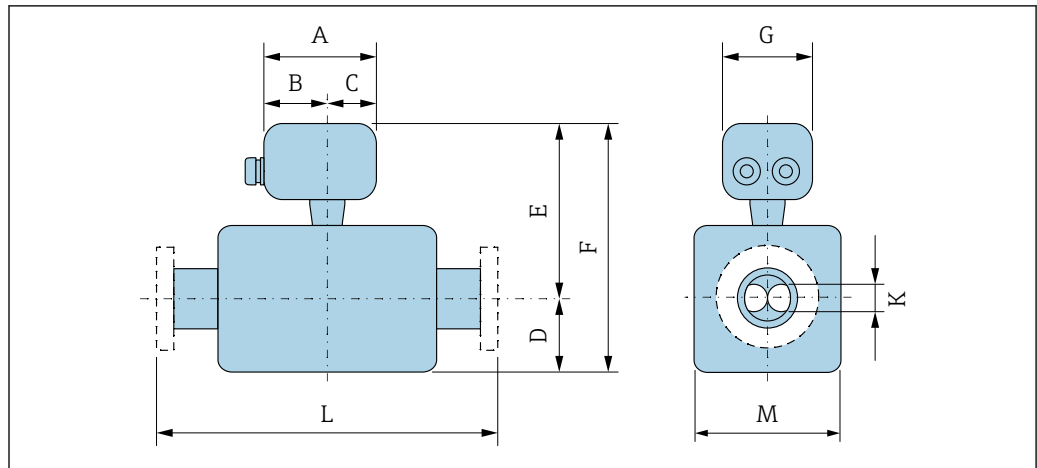

A0033787

DN [mm]	A [mm]	B [mm]	C [mm]	D [mm]	E ¹⁾ [mm]	F ¹⁾ [mm]	G [mm]	K [mm]	L [mm]	M [mm]
8	136.8	78	58.8	89.1	172.5	261.6	133.5	5.35	²⁾	44.9
15	136.8	78	58.8	100.1	172.5	272.6	133.5	8.30	²⁾	44.9
25	136.8	78	58.8	102.1	169.6	271.6	133.5	12.0	²⁾	51
40	136.8	78	58.8	120.7	175.6	296.2	133.5	17.6	²⁾	64.3
50	136.8	78	58.8	175.5	189.9	365.3	133.5	26.0	²⁾	91.1
80	136.8	78	58.8	205.3	205.4	410.8	133.5	40.5	²⁾	127

- 1) If using a display, order code for "Display; operation", option B: values +14 mm
 2) Dependent on the respective process connection

Order code for "Housing", option C "Ultra-compact hygienic, stainless"

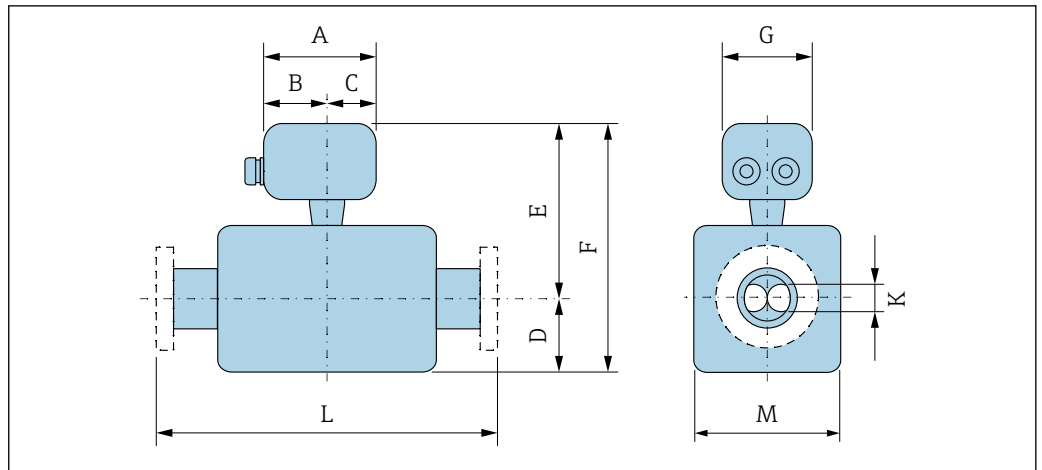

DN [mm]	A [mm]	B [mm]	C [mm]	D [mm]	E ¹⁾ [mm]	F ¹⁾ [mm]	G [mm]	K [mm]	L [mm]	M [mm]
8	123.6	67.7	55.9	89.1	172.3	261.4	111.4	5.35	²⁾	44.9
15	123.6	67.7	55.9	100.1	172.3	272.4	111.4	8.30	²⁾	44.9
25	123.6	67.7	55.9	102.1	169.4	271.4	111.4	12.0	²⁾	51
40	123.6	67.7	55.9	120.7	175.4	296	111.4	17.6	²⁾	64.3
50	123.6	67.7	55.9	175.5	189.6	365	111.4	26.0	²⁾	91.1
80	123.6	67.7	55.9	205.3	205.2	410.5	111.4	40.5	²⁾	127

- 1) If using a display, order code for "Display; operation", option B: values +14 mm
- 2) Dependent on the respective process connection

Flange connections

Fixed flange EN 1092-1, ASME B16.5, JIS B2220

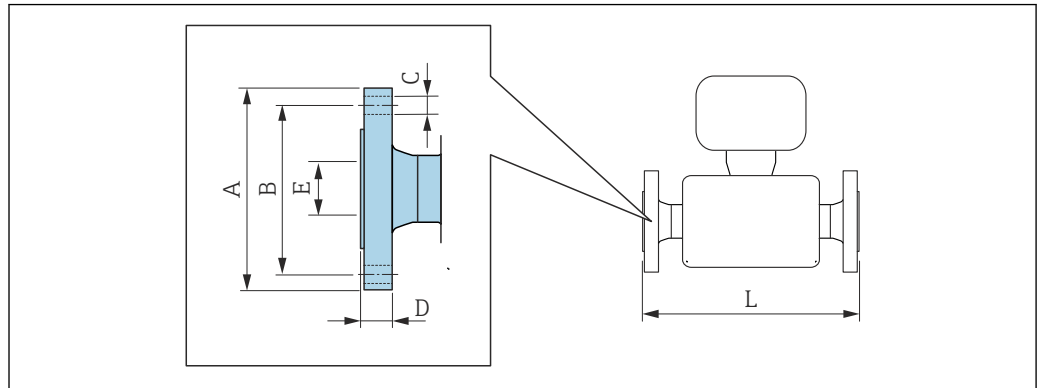

A0015621

i Length tolerance for dimension L in mm:
+1.5 / -2.0

Flange according to EN 1092-1 (DIN 2501 / DIN 2512N), PN 40 1.4404 (F316/F316L): order code for "Process connection", option D2S						
Flange with groove according to EN 1092-1 Form D (DIN 2512N), PN 40 1.4404 (F316/F316L): order code for "Process connection", option D6S						
DN [mm]	A [mm]	B [mm]	C [mm]	D [mm]	E [mm]	L [mm]
8 ¹⁾	95	65	4 × Ø14	16	17.3	232/510 ²⁾
15	95	65	4 × Ø14	16	17.3	279/510 ²⁾
25	115	85	4 × Ø14	18	28.5	329/600 ²⁾
40	150	110	4 × Ø18	18	43.1	445
50	165	125	4 × Ø18	20	54.5	556/715 ²⁾
80	200	160	8 × Ø18	24	82.5	611/915 ²⁾
Surface roughness (flange): EN 1092-1 Form B1 (DIN 2526 Form C), Ra 3.2 to 12.5 µm						

- 1) DN 8 with DN 15 flanges as standard
- 2) Installation length in accordance with NAMUR recommendation NE 132 optionally available (order code for "Process connection", option D2N or D6N (with groove))

Flange according to EN 1092-1 (DIN 2501), PN 40 (with DN 25 flanges) 1.4404 (F316/F316L) Order code for "Process connection", option R2S						
DN [mm]	A [mm]	B [mm]	C [mm]	D [mm]	E [mm]	L [mm]
8	115	85	4 × Ø14	18	28.5	302
15	115	85	4 × Ø14	18	28.5	315
Surface roughness (flange): EN 1092-1 Form B1 (DIN 2526 Form C), Ra 3.2 to 12.5 µm						

Flange according to EN 1092-1 (DIN 2501 / DIN 2512N), PN 63
1.4404 (F316/F316L): order code for "Process connection", option D3S

Flange with groove according to EN 1092-1 Form D (DIN 2512N), PN 63
1.4404 (F316/F316L): order code for "Process connection", option D7S

DN [mm]	A [mm]	B [mm]	C [mm]	D [mm]	E [mm]	L [mm]
50	180	135	4 × Ø22	26	54.5	565
80	215	170	8 × Ø22	28	81.7	646

Surface roughness (flange): EN 1092-1 Form B2 (DIN 2526 Form E), Ra 0.8 to 3.2 µm

Flange according to EN 1092-1 (DIN 2501 / DIN 2512N), PN 100
1.4404 (F316/F316L)
Order code for "Process connection", option D4S

Flange with groove according to EN 1092-1 Form D (DIN 2512N) available, PN 100
1.4404 (F316/F316L)
Order code for "Process connection", option D8S

DN [mm]	A [mm]	B [mm]	C [mm]	D [mm]	E [mm]	L [mm]
8 ¹⁾	105	75	4 × Ø14	20	17.3	261
15	105	75	4 × Ø14	20	17.3	295
25	140	100	4 × Ø18	24	28.5	360
40	170	125	4 × Ø22	26	42.5	486
50	195	145	4 × Ø26	28	53.9	581
80	230	180	8 × Ø26	32	80.9	656

Surface roughness (flange): EN 1092-1 Form B2 (DIN 2526 Form E), Ra 0.8 to 3.2 µm

1) DN 8 with DN 15 flanges as standard

Flange according to ASME B16.5, Class 150
1.4404 (F316/F316L)
Order code for "Process connection", option AAS

DN [mm]	A [mm]	B [mm]	C [mm]	D [mm]	E [mm]	L [mm]
8 ¹⁾	90	60.3	4 × Ø15.7	11.2	15.7	232
15	90	60.3	4 × Ø15.7	11.2	15.7	279
25	110	79.4	4 × Ø15.7	14.2	26.7	329
40	125	98.4	4 × Ø15.7	17.5	40.9	445
50	150	120.7	4 × Ø19.1	19.1	52.6	556
80	190	152.4	4 × Ø19.1	23.9	78.0	611

Surface roughness (flange): Ra 3.2 to 6.3 µm

1) DN 8 with DN 15 flanges as standard

Flange according to ASME B16.5, Class 300
1.4404 (F316/F316L)
Order code for "Process connection", option ABS

DN [mm]	A [mm]	B [mm]	C [mm]	D [mm]	E [mm]	L [mm]
8 ¹⁾	95	66.7	4 × Ø15.7	14.2	15.7	232
15	95	66.7	4 × Ø15.7	14.2	15.7	279

Flange according to ASME B16.5, Class 300 1.4404 (F316/F316L) <i>Order code for "Process connection", option ABS</i>						
DN [mm]	A [mm]	B [mm]	C [mm]	D [mm]	E [mm]	L [mm]
25	125	88.9	4 × Ø19.0	17.5	26.7	329
40	155	114.3	4 × Ø22.3	20.6	40.9	445
50	165	127	8 × Ø19.0	22.3	52.6	556
80	210	168.3	8 × Ø22.3	28.4	78.0	611
Surface roughness (flange): Ra 3.2 to 6.3 µm						

1) DN 8 with DN 15 flanges as standard

Flange according to ASME B16.5, Class 600 1.4404 (F316/F316L) <i>Order code for "Process connection", option ACS</i>						
DN [mm]	A [mm]	B [mm]	C [mm]	D [mm]	E [mm]	L [mm]
8 ¹⁾	95	66.7	4 × Ø15.7	20.6	13.9	261
15	95	66.7	4 × Ø15.7	20.6	13.9	295
25	125	88.9	4 × Ø19.1	23.9	24.3	380
40	155	114.3	4 × Ø22.4	28.7	38.1	496
50	165	127	8 × Ø19.1	31.8	49.2	583
80	210	168.3	8 × Ø22.4	38.2	73.7	671
Surface roughness (flange): Ra 3.2 to 6.3 µm						

1) DN 8 with DN 15 flanges as standard

Flange JIS B2220, 10K 1.4404 (F316/F316L) <i>Order code for "Process connection", option NDS</i>						
DN [mm]	A [mm]	B [mm]	C [mm]	D [mm]	E [mm]	L [mm]
50	155	120	4 × Ø19	16	50	556
80	185	150	8 × Ø19	18	80	603
Surface roughness (flange): Ra 3.2 to 6.3 µm						

Flange JIS B2220, 20K 1.4404 (F316/F316L) <i>Order code for "Process connection", option NES</i>						
DN [mm]	A [mm]	B [mm]	C [mm]	D [mm]	E [mm]	L [mm]
8 ¹⁾	95	70	4 × Ø15	14	15	232
15	95	70	4 × Ø15	14	15	279
25	125	90	4 × Ø19	16	25	329
40	140	105	4 × Ø19	18	40	445
50	155	120	8 × Ø19	18	50	556

Flange JIS B2220, 20K 1.4404 (F316/F316L) <i>Order code for "Process connection", option NES</i>						
DN [mm]	A [mm]	B [mm]	C [mm]	D [mm]	E [mm]	L [mm]
80	200	160	8 × Ø23	22	80	603
Surface roughness (flange): Ra 3.2 to 6.3 µm						

- 1) DN 8 with DN 15 flanges as standard

Flange JIS B2220, 40K 1.4404 (F316/F316L) <i>Order code for "Process connection", option NGS</i>						
DN [mm]	A [mm]	B [mm]	C [mm]	D [mm]	E [mm]	L [mm]
8 ¹⁾	115	80	4 × Ø19	20	15	261
15	115	80	4 × Ø19	20	15	300
25	130	95	4 × Ø19	22	25	375
40	160	120	4 × Ø23	24	38	496
50	165	130	8 × Ø19	26	50	601
80	210	170	8 × Ø23	32	75	661
Surface roughness (flange): Ra 3.2 to 6.3 µm						

- 1) DN 8 with DN 15 flanges as standard

Flange JIS B2220, 63K 1.4404 (F316/F316L) <i>Order code for "Process connection", option NHS</i>						
DN [mm]	A [mm]	B [mm]	C [mm]	D [mm]	E [mm]	L [mm]
8 ¹⁾	120	85	4 × Ø19	23	12	282
15	120	85	4 × Ø19	23	12	315
25	140	100	4 × Ø23	27	22	383
40	175	130	4 × Ø25	32	35	515
50	185	145	4 × Ø23	34	48	616
80	230	185	4 × Ø25	40	73	686
Surface roughness (flange): Ra 3.2 to 6.3 µm						

- 1) DN 8 with DN 15 flanges as standard

Fixed flange DIN 11864-2

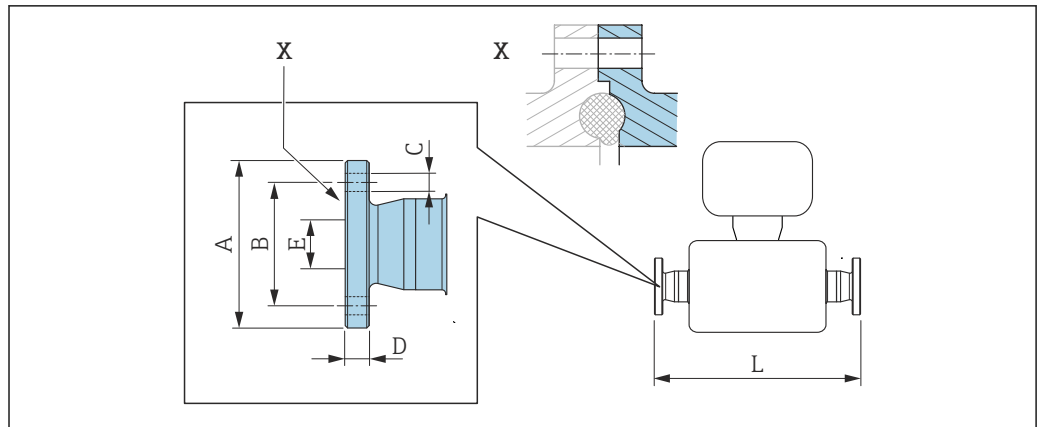

A0015627

35 Detail X: Asymmetrical process connection; the part shown in blue is provided by the supplier.

i Length tolerance for dimension L in mm:
+1.5 / -2.0

Flange DIN11864-2 Form A, for pipe according to DIN11866 series A, flange with notch 1.4404 (316/316L)

Order code for "Process connection", option KCS

DN [mm]	A [mm]	B [mm]	C [mm]	D [mm]	E [mm]	L [mm]
8	54	37	4 × Ø9	10	10	249
15	59	42	4 × Ø9	10	16	293
25	70	53	4 × Ø9	10	26	344
40	82	65	4 × Ø9	10	38	456
50	94	77	4 × Ø9	10	50	562
80	133	112	8 × Ø11	12	81	671

3-A version available: order code for "Additional approval", option LP in conjunction with

Ra ≤ 0.8 µm: Order code for "Measuring tube material", option **SB**

Ra ≤ 0.4 µm: Order code for "Measuring tube material", option **SC**

Clamp connections

Tri-Clamp

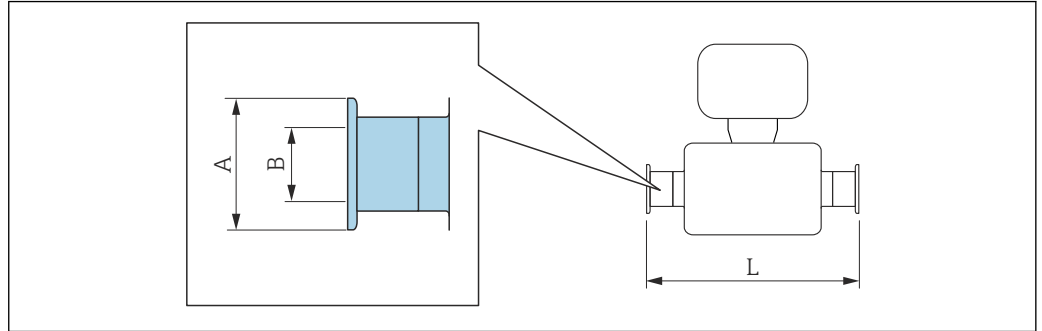

A0015625

 Length tolerance for dimension L in mm:
+1.5 / -2.0

Tri-Clamp (½") 1.4404 (316/316L) Order code for "Process connection", option FDW				
DN [mm]	Clamp [in]	A [mm]	B [mm]	L [mm]
8	½	25.0	9.5	229
15	½	25.0	9.5	273

3-A version available: order code for "Additional approval", option LP in conjunction with
 Ra ≤ 0.8 µm: Order code for "Measuring tube material", option **SB**
 Ra ≤ 0.4 µm: Order code for "Measuring tube material", option **SC**

Tri-Clamp (≥ 1") 1.4404 (316/316L) Order code for "Process connection", option FTS				
DN [mm]	Clamp [in]	A [mm]	B [mm]	L [mm]
8	1	50.4	22.1	229
15	1	50.4	22.1	273
25	1	50.4	22.1	324
40	1½	50.4	34.8	456
50	2	63.9	47.5	562
80	3	90.9	72.9	671

3-A version available: order code for "Additional approval", option LP in conjunction with
 Ra ≤ 0.8 µm: Order code for "Measuring tube material", option **SB**
 Ra ≤ 0.4 µm: Order code for "Measuring tube material", option **SC**

Threaded couplings

Thread DIN 11851, DIN11864-1, SMS 1145

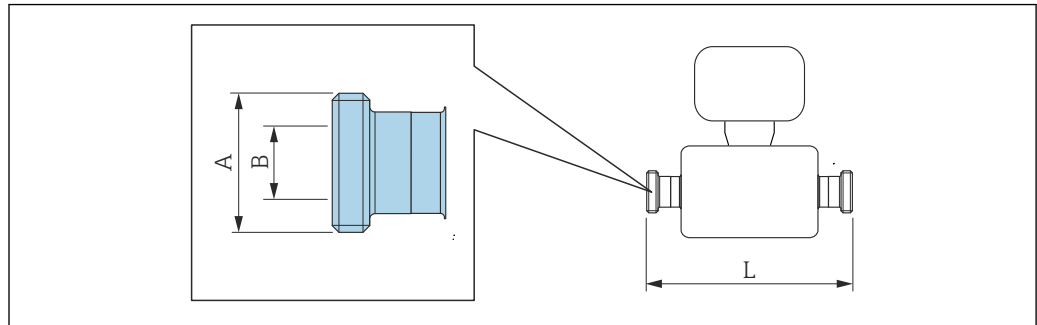

A0015628

i Length tolerance for dimension L in mm:
+1.5 / -2.0

Thread DIN 11851, for pipe according to DIN11866, series A 1.4404 (316/316L) Order code for "Process connection", option FMW			
DN [mm]	A [in]	B [mm]	L [mm]
8	Rd 34 × 1/8	16	229
15	Rd 34 × 1/8	16	273
25	Rd 52 × 1/6	26	324
40	Rd 65 × 1/6	38	456
50	Rd 78 × 1/6	50	562
80	Rd 110 × 1/4	81	671

3-A version available: order code for "Additional approval", option LP in conjunction with
 Ra ≤ 0.8 µm: Order code for "Measuring tube material", option SB
 Ra ≤ 0.4 µm: Order code for "Measuring tube material", option SC

Thread DIN11864-1 Form A, for pipe according to DIN11866, series A 1.4404 (316/316L) Order code for "Process connection", option FLW			
DN [mm]	A [in]	B [mm]	L [mm]
8	Rd 28 × 1/8	10	229
15	Rd 34 × 1/8	16	273
25	Rd 52 × 1/6	26	324
40	Rd 65 × 1/6	38	456
50	Rd 78 × 1/6	50	562
80	Rd 110 × 1/4	81	671

3-A version available: order code for "Additional approval", option LP in conjunction with
 Ra ≤ 0.8 µm: Order code for "Measuring tube material", option SB
 Ra ≤ 0.4 µm: Order code for "Measuring tube material", option SC

Thread SMS 1145 1.4404 (316/316L) <i>Order code for "Process connection", option SCS</i>			
DN [mm]	A [in]	B [mm]	L [mm]
8	Rd 40 × 1/6	22.5	229
15	Rd 40 × 1/6	22.5	273
25	Rd 40 × 1/6	22.5	324
40	Rd 60 × 1/6	35.5	456
50	Rd 70 × 1/6	48.5	562
80	Rd 98 × 1/6	72.9	671

3-A version available: order code for "Additional approval", option LP in conjunction with
 Ra ≤ 0.8 µm: Order code for "Measuring tube material", option **SB**
 Ra ≤ 0.4 µm: Order code for "Measuring tube material", option **SC**

Thread ISO 2853

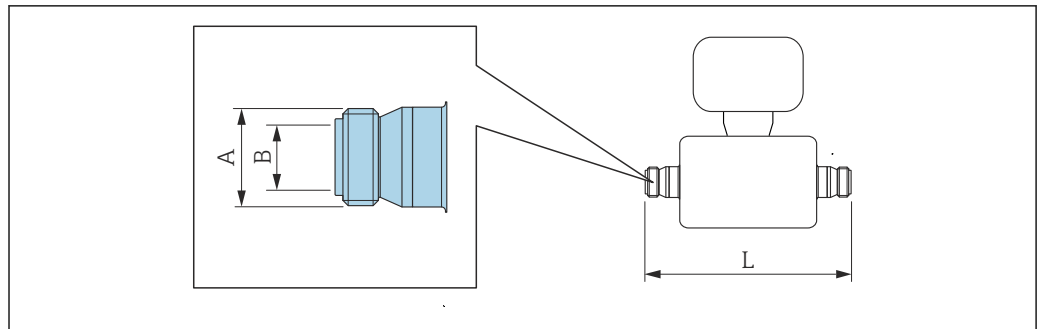

A0015623

i Length tolerance for dimension L in mm:
+1.5 / -2.0

Thread ISO 2853, for pipe according to ISO 2037 1.4404 (316/316L) Order code for "Process connection", option JSF			
DN [mm]	A ¹⁾ [mm]	B [mm]	L [mm]
8	37.13	22.6	229
15	37.13	22.6	273
25	37.13	22.6	324
40	50.68	35.6	456
50	64.16	48.6	562
80	91.19	72.9	671

3-A version available: order code for "Additional approval", option LP in conjunction with
 Ra ≤ 0.8 µm: Order code for "Measuring tube material", option SB
 Ra ≤ 0.4 µm: Order code for "Measuring tube material", option SC

1) Max. thread diameter as per ISO 2853 annex A

VCO

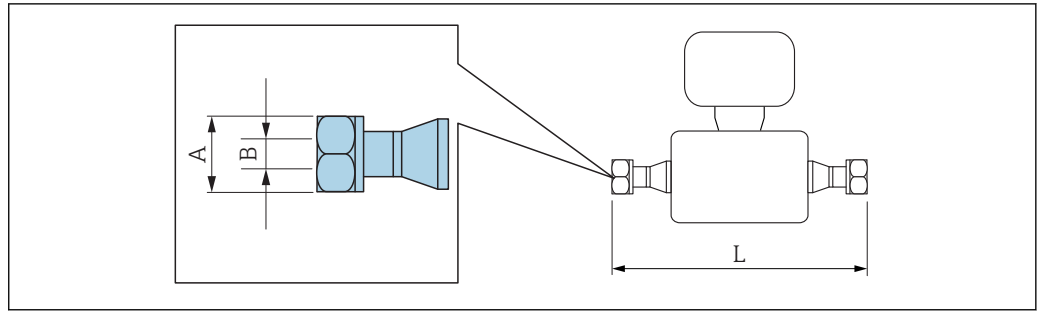

A0015624

i Length tolerance for dimension L in mm:
+1.5 / -2.0

8-VCO-4 (1/2")
1.4404 (316/316L)
 Order code for "Process connection", option CVS

DN [mm]	A [in]	B [mm]	L [mm]
8	AF 1	10.2	252

12-VCO-4 (3/4")
1.4404 (316/316L)
 Order code for "Process connection", option CWS

DN [mm]	A [in]	B [mm]	L [mm]
15	AF 1 1/2	15.7	305

Safety Barrier Promass 100

Top-hat rail EN 60715:

- TH 35 x 7.5
- TH 35 x 15

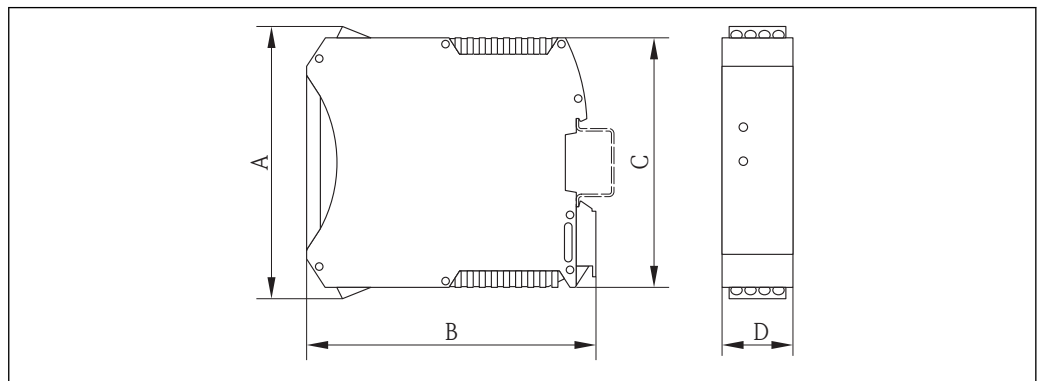

A0016777

A [mm]	B [mm]	C [mm]	D [mm]
108	114.5	99	22.5

Dimensions in US units

Compact version

Order code for "Housing", option A "Compact coated aluminum"

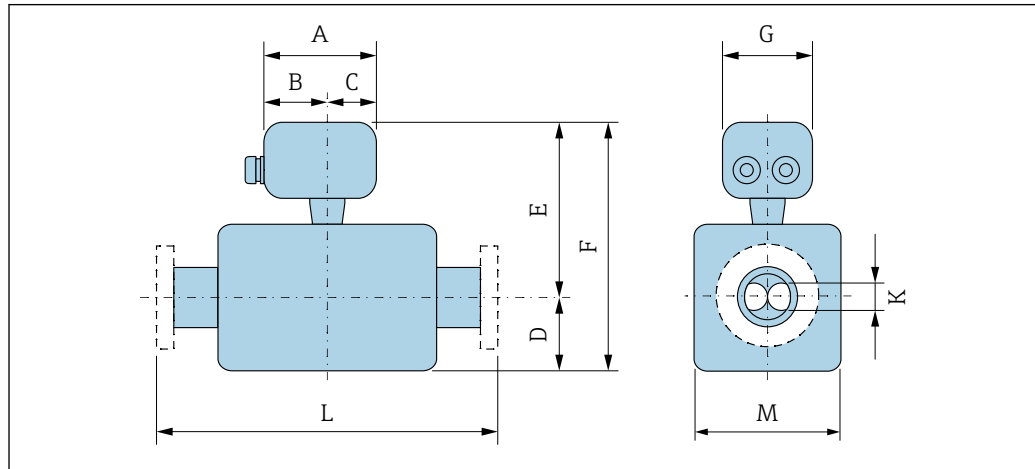

A0033787

DN [in]	A [in]	B [in]	C [in]	D [in]	E ¹⁾ [in]	F ¹⁾ [in]	G [in]	K [in]	L [in]	M [in]
3/8	5.81	3.68	2.13	3.66	7.05	10.71	5.35	0.21	2)	
1/2	5.81	3.68	2.13	4.13	7.13	11.26	5.35	0.33	2)	
1	5.81	3.68	2.13	4.17	7.32	11.5	5.35	0.47	2)	
1 1/2	5.81	3.68	2.13	4.76	7.56	12.32	5.35	0.69	2)	
2	5.81	3.68	2.13	6.67	8.19	14.86	5.35	1.02	2)	
3	5.81	3.68	2.13	8.07	8.41	16.48	5.35	1.59	2)	

- 1) If using a display, order code for "Display; operation", option B: values +1.1 in
 2) Dependent on the respective process connection

Order code for "Housing", option B "Compact hygienic, stainless"

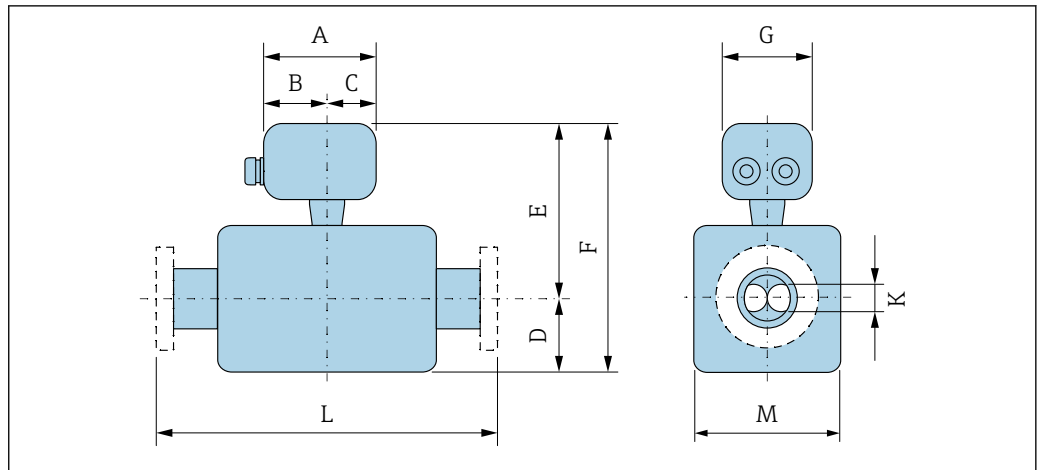

A0033787

DN [in]	A [in]	B [in]	C [in]	D [in]	E ¹⁾ [in]	F ¹⁾ [in]	G [in]	K [in]	L [in]	M [in]
3/8	5.39	3.07	2.31	3.66	6.85	10.51	5.26	0.21	2)	
1/2	5.39	3.07	2.31	4.13	6.93	11.06	5.26	0.33	2)	
1	5.39	3.07	2.31	4.17	7.13	11.3	5.26	0.47	2)	
1 1/2	5.39	3.07	2.31	4.76	7.36	12.13	5.26	0.69	2)	
2	5.39	3.07	2.31	6.67	7.99	14.67	5.26	1.02	2)	
3	5.39	3.07	2.31	8.07	8.21	16.28	5.26	1.59	2)	

- 1) If using a display, order code for "Display; operation", option B: values +0.55 in
- 2) Dependent on the respective process connection

Order code for "Housing", option C "Ultra-compact hygienic, stainless"

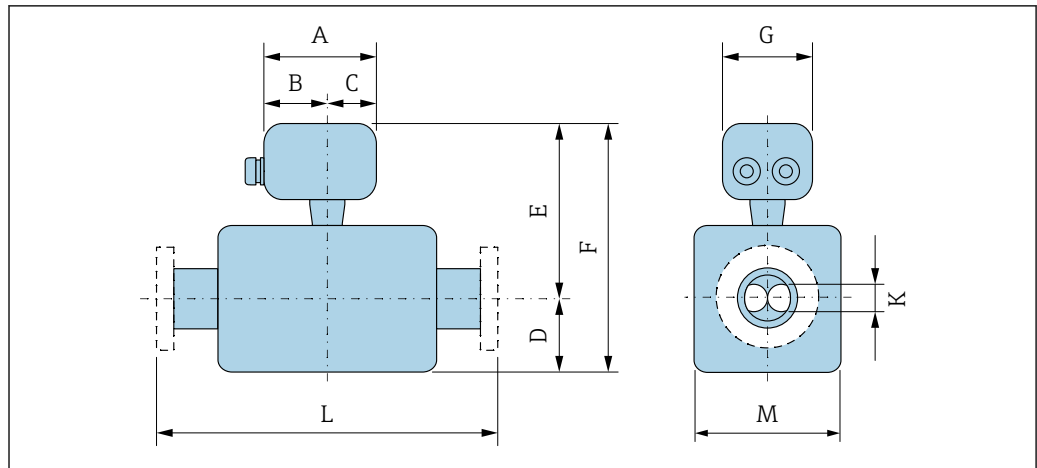

A0033787

DN [in]	A [in]	B [in]	C [in]	D [in]	E ¹⁾ [in]	F ¹⁾ [in]	G [in]	K [in]	L [in]	M [in]
3/8	4.87	2.67	2.2	3.66	6.85	10.51	4.39	0.21	²⁾	
1/2	4.87	2.67	2.2	4.13	6.93	11.06	4.39	0.33	²⁾	
1	4.87	2.67	2.2	4.17	7.13	11.3	4.39	0.47	²⁾	
1 1/2	4.87	2.67	2.2	4.76	7.36	12.13	4.39	0.69	²⁾	
2	4.87	2.67	2.2	6.67	7.99	14.67	4.39	1.02	²⁾	
3	4.87	2.67	2.2	8.07	8.21	16.28	4.39	1.59	²⁾	

- 1) If using a display, order code for "Display; operation", option B: values +0.55 in
 2) Dependent on the respective process connection

Flange connections

Fixed flange ASME B16.5

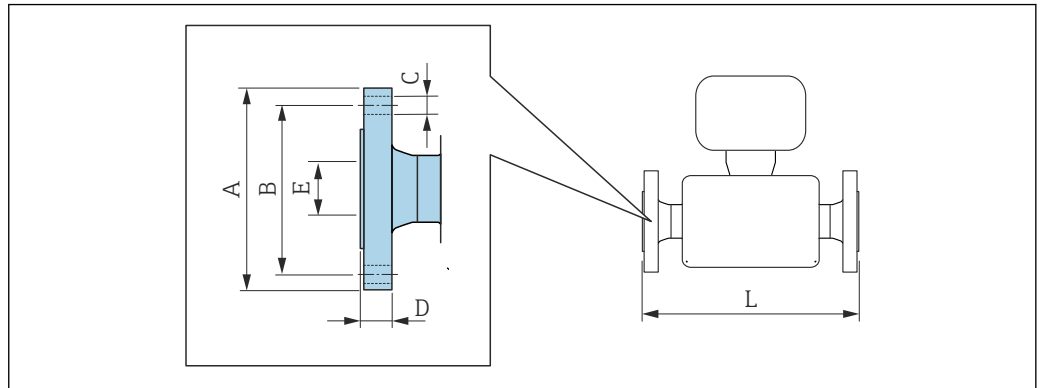

i Length tolerance for dimension L in inch:
+0.06 / -0.08

Flange according to ASME B16.5, CI 150						
1.4404 (F316/F316L)						
<i>Order code for "Process connection", option AAS</i>						
DN [in]	A [in]	B [in]	C [in]	D [in]	E [in]	L [in]
3/8 ¹⁾	3.54	2.37	4 × Ø0.62	0.44	0.62	9.13
1/2	3.54	2.37	4 × Ø0.62	0.44	0.62	10.98
1	4.33	3.13	4 × Ø0.62	0.56	1.05	12.95
1 1/2	4.92	3.87	4 × Ø0.62	0.69	1.61	17.52
2	5.91	4.75	4 × Ø0.75	0.75	2.07	21.89
3	7.48	6.00	4 × Ø0.75	0.94	3.07	24.06

Surface roughness (flange): Ra 32 to 248 µin

1) DN 3/8" with DN 1/2" flanges as standard

Flange according to ASME B16.5, Class 300						
1.4404 (F316/F316L)						
<i>Order code for "Process connection", option ABS</i>						
DN [in]	A [in]	B [in]	C [in]	D [in]	E [in]	L [in]
3/8 ¹⁾	3.74	2.63	4 × Ø0.62	0.56	0.62	9.13
1/2	3.74	2.63	4 × Ø0.62	0.56	0.62	10.98
1	4.92	3.50	4 × Ø0.75	0.69	1.05	12.95
1 1/2	6.10	4.50	4 × Ø0.88	0.81	1.61	17.52
2	6.50	5.00	8 × Ø0.75	0.88	2.07	21.89
3	8.27	6.63	8 × Ø0.88	1.12	3.07	24.06

Surface roughness (flange): Ra 32 to 248 µin

1) DN 3/8" with DN 1/2" flanges as standard

Flange according to ASME B16.5, Class 600 1.4404 (F316/F316L) Order code for "Process connection", option ACS						
DN [in]	A [in]	B [in]	C [in]	D [in]	E [in]	L [in]
$\frac{3}{8}$ ¹⁾	3.74	2.63	4 × Ø0.62	0.81	0.55	10.28
$\frac{1}{2}$	3.74	2.63	4 × Ø0.62	0.81	0.55	11.61
1	4.92	3.50	4 × Ø0.75	0.94	0.96	14.96
1½	6.10	4.50	4 × Ø0.88	1.13	1.50	19.53
2	6.50	5.00	8 × Ø0.75	1.25	1.94	22.95
3	8.27	6.63	8 × Ø0.88	1.50	2.9	26.42
Surface roughness (flange): Ra 32 to 248 µin						

1) DN $\frac{3}{8}$ " with DN $\frac{1}{2}$ " flanges as standard

Clamp connections

Tri-Clamp

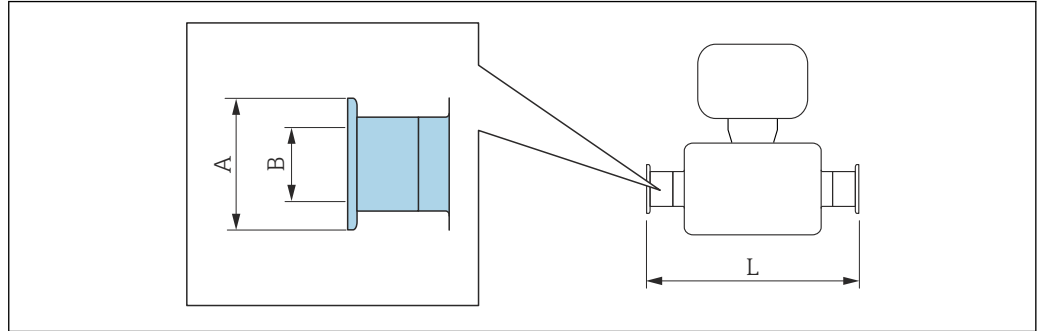

A0015625

 Length tolerance for dimension L in inch:
+0.06 / -0.08

Tri-Clamp (½") 1.4404 (316/316L) Order code for "Process connection", option FDW				
DN [in]	Clamp [in]	A [in]	B [in]	L [in]
⅜	½	0.98	0.37	9.02
½	½	0.98	0.37	10.75

3-A version available: order code for "Additional approval", option LP in conjunction with
 Ra ≤ 32 μin: Order code for "Measuring tube material", option **SB**
 Ra ≤ 16 μin: Order code for "Measuring tube material", option **SC**

Tri-Clamp (≥ 1") 1.4404 (316/316L) Order code for "Process connection", option FTS				
DN [in]	Clamp [in]	A [in]	B [in]	L [in]
⅜	1	1.98	0.87	9.02
½	1	1.98	0.87	10.75
1	1	1.98	0.87	12.76
1½	1½	1.98	1.37	17.95
2	2	2.52	1.87	22.13
3	3	3.58	2.87	26.42

3-A version available: order code for "Additional approval", option LP in conjunction with
 Ra ≤ 32 μin: Order code for "Measuring tube material", option **SB**
 Ra ≤ 16 μin: Order code for "Measuring tube material", option **SC**

Threaded couplings

Thread SMS 1145

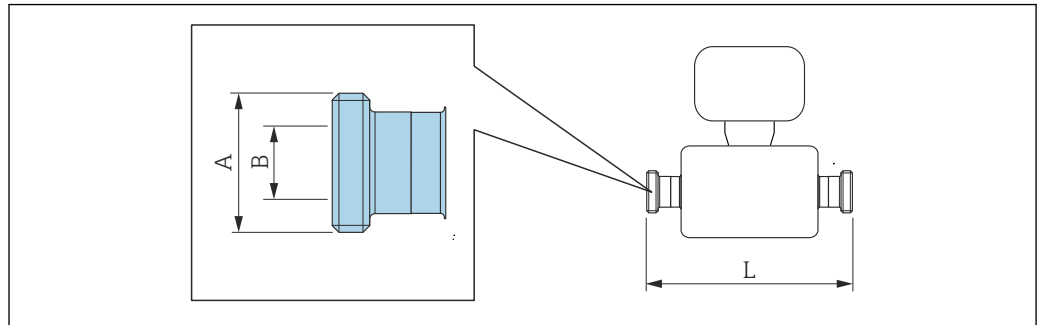

A0015628

i Length tolerance for dimension L in inch:
+0.06 / -0.08

Thread SMS 1145 1.4404 (316/316L) Order code for "Process connection", option SCS			
DN [in]	A [in]	B [in]	L [in]
3/8	Rd 40 × 1/6	0.89	9.02
1/2	Rd 40 × 1/6	0.89	10.75
1	Rd 40 × 1/6	0.89	12.76
1 1/2	Rd 60 × 1/6	1.40	17.95
2	Rd 70 × 1/6	1.91	22.13
3	Rd 98 × 1/6	2.87	26.42

3-A version available: order code for "Additional approval", option LP in conjunction with
 Ra ≤ 32 μin: Order code for "Measuring tube material", option **SB**
 Ra ≤ 16 μin: Order code for "Measuring tube material", option **SC**

VCO

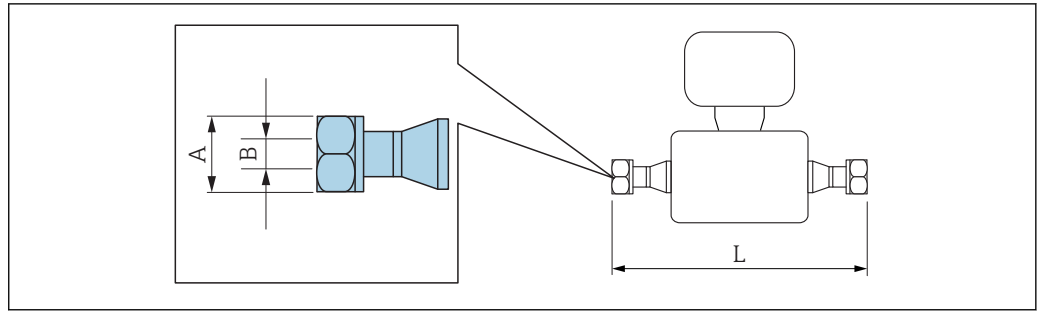

A0015624

i Length tolerance for dimension L in inch:
+0.06 / -0.08

8-VCO-4 (1/2")
1.4404 (316/316L)
Order code for "Process connection", option CVS

DN [in]	A [in]	B [in]	L [in]
3/8	AF 1	0.40	9.92

12-VCO-4 (3/4")
1.4404 (316/316L)
Order code for "Process connection", option CWS

DN [in]	A [in]	B [in]	L [in]
1/2	AF 1 1/2	0.62	12.01

Safety Barrier Promass 100

Top-hat rail EN 60715:

- TH 35 x 7.5
- TH 35 x 15

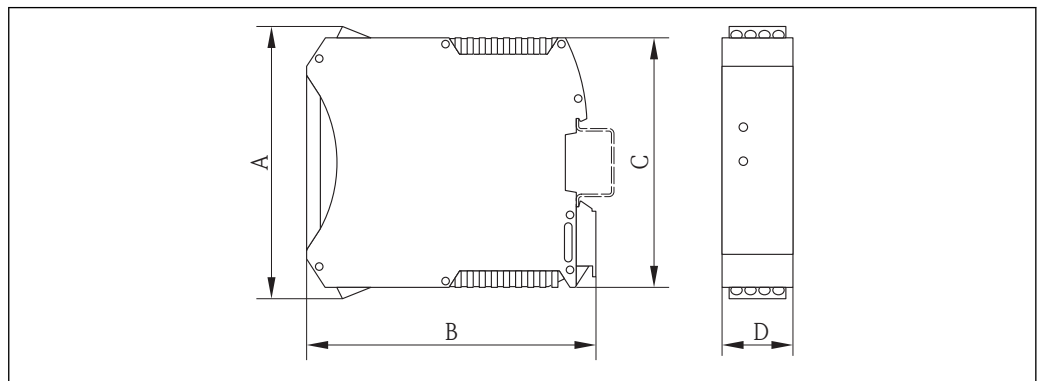

A0016777

A [in]	B [in]	C [in]	D [in]
4.25	4.51	3.9	0.89

Weight All values (weight exclusive of packaging material) refer to devices with EN/DIN PN 40 flanges. Weight specifications including transmitter: order code for "Housing", option A "Compact, aluminum coated".

Different values due to different transmitter versions:

Weight in SI units

DN [mm]	Weight [kg]
8	4.5
15	4.8
25	6.4
40	10.4
50	15.5
80	29

Weight in US units

DN [in]	Weight [lbs]
3/8	10
1/2	11
1	14
1 1/2	23
2	34
3	64

Safety Barrier Promass 100

49 g (1.73 ounce)

Materials

Transmitter housing

- Order code for "Housing", option **A** "Compact, aluminum coated": Aluminum, AlSi10Mg, coated
- Order code for "Housing", option **B** "Compact, hygienic, stainless": Hygienic version, stainless steel 1.4301 (304)
- Order code for "Housing", option **C** "Ultra-compact, hygienic, stainless": Hygienic version, stainless steel 1.4301 (304)
- Window material for optional local display (→  79):
 - For order code for "Housing", option **A**: glass
 - For order code for "Housing", option **B** and **C**: plastic

Cable entries/cable glands

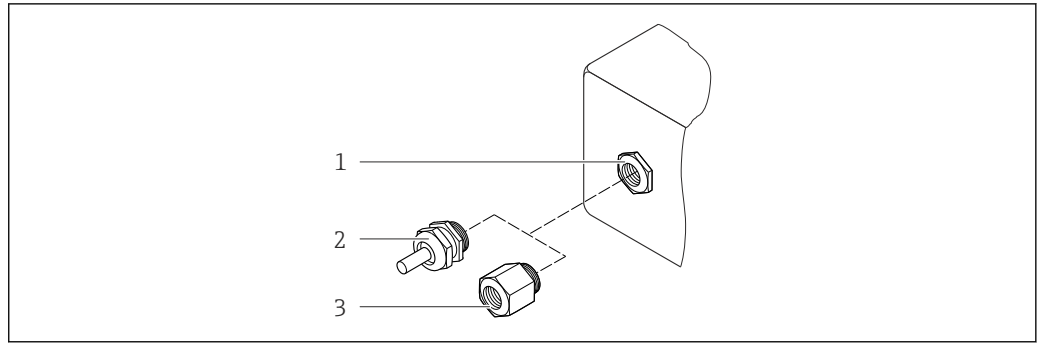

A0020640

36 Possible cable entries/cable glands

- 1 Female thread M20 × 1.5
- 2 Cable gland M20 × 1.5
- 3 Adapter for cable entry with internal thread G ½" or NPT ½"

Order code for "Housing", option A "Compact, coated aluminum"

The various cable entries are suitable for hazardous and non-hazardous areas.

Cable entry/cable gland	Material
Cable gland M20 × 1.5	Nickel-plated brass
Adapter for cable entry with internal thread G ½"	
Adapter for cable entry with internal thread NPT ½"	

Order code for "Housing", option B "Compact, hygienic, stainless"

The various cable entries are suitable for hazardous and non-hazardous areas.

Cable entry/cable gland	Material
Cable gland M20 × 1.5	Stainless steel, 1.4404 (316L)
Adapter for cable entry with internal thread G ½"	
Adapter for cable entry with internal thread NPT ½"	

Device plug

Electrical connection	Material
Plug M12x1	<ul style="list-style-type: none"> ▪ Socket: Stainless steel, 1.4404 (316L) ▪ Contact housing: Polyamide ▪ Contacts: Gold-plated brass

Sensor housing

- Acid and alkali-resistant outer surface
- Stainless steel 1.4301 (304)

Measuring tubes

Stainless steel, 1.4539 (904L); manifold: stainless steel, 1.4404 (316L)

Process connections

- Flanges according to EN 1092-1 (DIN2501) / according to ASME B 16.5 / as per JIS B2220: Stainless steel, 1.4404 (F316/F316L)
- All other process connections: Stainless steel, 1.4404 (316/316L)



List of all available process connections → 78

Seals

Welded process connections without internal seals

Accessories*Protective cover*

Stainless steel, 1.4404 (316L)

Safety Barrier Promass 100

Housing: Polyamide

Process connections

- Fixed flange connections:
 - EN 1092-1 (DIN 2501) flange
 - EN 1092-1 (DIN 2512N) flange
 - Namur lengths in accordance with NE 132
 - ASME B16.5 flange
 - JIS B2220 flange
 - DIN 11864-2 Form A flange, DIN 11866 series A, flange with notch
- Clamp connections
 - Tri-Clamp (OD tubes), DIN 11866 series C
- Thread:
 - DIN 11851 thread, DIN 11866 series A
 - SMS 1145 thread
 - ISO 2853 thread, ISO 2037
 - DIN 11864-1 Form A thread, DIN 11866 series A
- VCO connections
 - 8-VCO-4
 - 12-VCO-4



For information on the different materials used in the process connections → 76

Surface roughness

All data relate to parts in contact with fluid. The following surface roughness quality can be ordered.

- Not polished
- $Ra_{max} = 0.8 \mu\text{m}$ (32 μin)
- $Ra_{max} = 0.4 \mu\text{m}$ (16 μin)

Operability

Operating concept**Operator-oriented menu structure for user-specific tasks**

- Commissioning
- Operation
- Diagnostics
- Expert level

Quick and safe commissioning

- Individual menus for applications
- Menu guidance with brief explanations of the individual parameter functions

Reliable operation

- Operation in the following languages:
 - Via "FieldCare", "DeviceCare" operating tool: English, German, French, Spanish, Italian, Chinese, Japanese
 - Via integrated Web browser (only available for device versions with HART, PROFIBUS DP, PROFINET and EtherNet/IP): English, German, French, Spanish, Italian, Dutch, Portuguese, Polish, Russian, Turkish, Chinese, Japanese, Bahasa (Indonesian), Vietnamese, Czech, Swedish, Korean
- Uniform operating philosophy applied to operating tools and Web browser
- If replacing the electronic module, transfer the device configuration via the plug-in memory (HistoROM DAT) which contains the process and measuring device data and the event logbook. No need to reconfigure.
For devices with Modbus RS485, the data recovery function is implemented without the plug-in memory (HistoROM DAT).

Efficient diagnostics increase measurement availability

- Troubleshooting measures can be called up via the operating tools and web browser
- Diverse simulation options
- Status indicated by several light emitting diodes (LEDs) on the electronic module in the housing compartment

Local display

 A local display is only available for device versions with the following communication protocols: HART, PROFIBUS-DP, PROFINET, EtherNet/IP

The local display is only available with the following device order code:
Order code for "Display; operation", option **B**: 4-line; illuminated, via communication

Display element

- 4-line liquid crystal display with 16 characters per line.
- White background lighting; switches to red in event of device errors.
- Format for displaying measured variables and status variables can be individually configured.
- Permitted ambient temperature for the display: -20 to +60 °C (-4 to +140 °F). The readability of the display may be impaired at temperatures outside the temperature range.

Remote operation

Via HART protocol

This communication interface is available in device versions with a HART output.

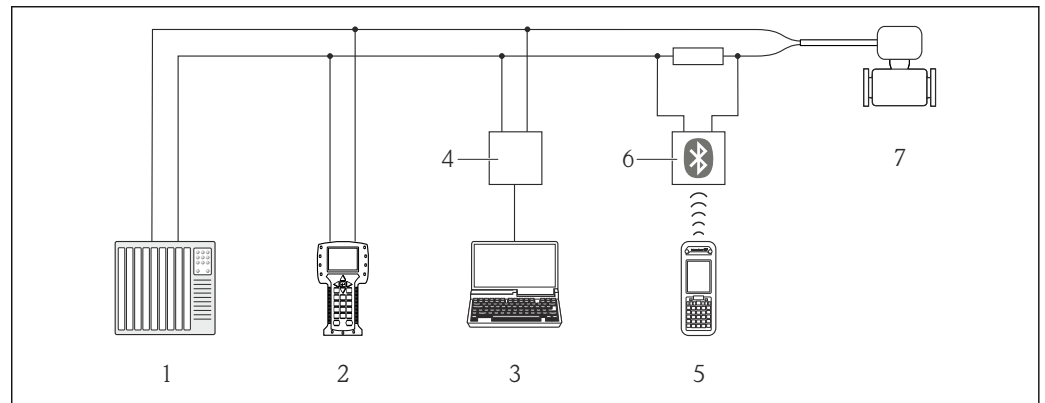

 37 Options for remote operation via HART protocol

- 1 Control system (e.g. PLC)
- 2 Field Communicator 475
- 3 Computer with operating tool (e.g. FieldCare, AMS Device Manager, SIMATIC PDM)
- 4 Commubox FXA195 (USB)
- 5 Field Xpert SFX350 or SFX370
- 6 VIATOR Bluetooth modem with connecting cable
- 7 Transmitter

Via PROFIBUS DP network

This communication interface is available in device versions with PROFIBUS DP.

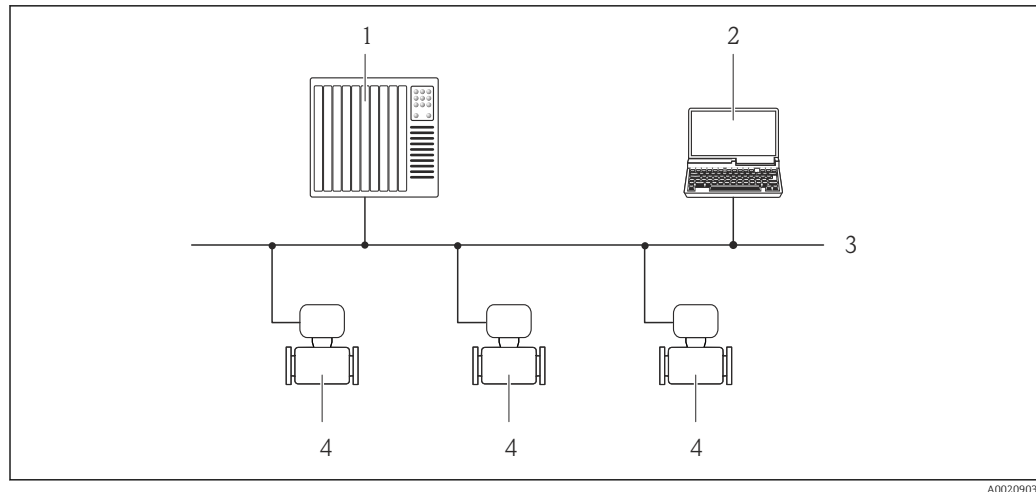

A0020903

38 Options for remote operation via PROFIBUS DP network

- 1 Automation system
- 2 Computer with PROFIBUS network card
- 3 PROFIBUS DP network
- 4 Measuring device

Via EtherNet/IP network

This communication interface is available in device versions with EtherNet/IP.

Star topology

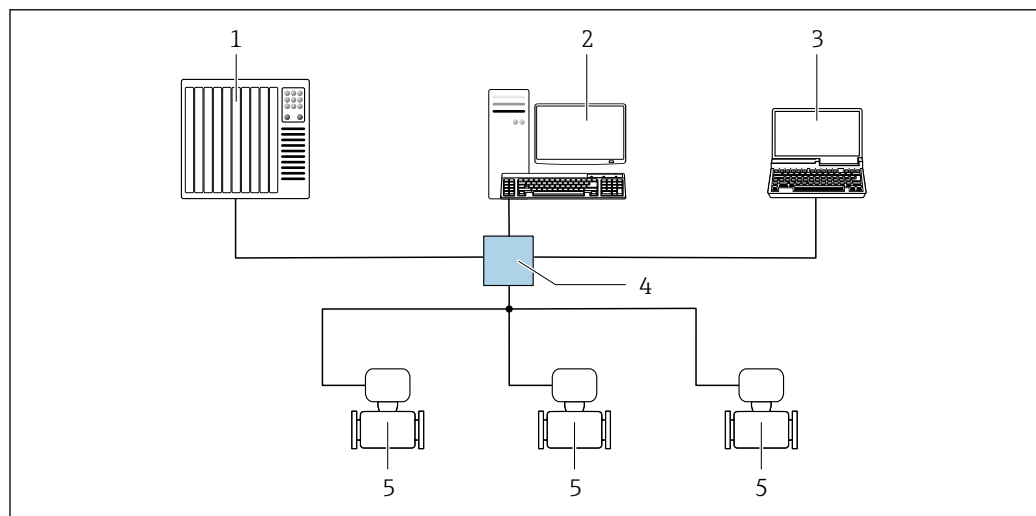

A0032078

39 Options for remote operation via EtherNet/IP network: star topology

- 1 Automation system, e.g. "RSLogix" (Rockwell Automation)
- 2 Workstation for measuring device operation: with Custom Add-On Profile for "RSLogix 5000" (Rockwell Automation) or with Electronic Data Sheet (EDS)
- 3 Computer with Web browser (e.g. Internet Explorer) for accessing the integrated device Web server or computer with operating tool (e.g. FieldCare, DeviceCare) with COM DTM "CDI Communication TCP/IP"
- 4 Ethernet switch
- 5 Measuring device

Via PROFINET network

This communication interface is available in device versions with PROFINET.

Star topology

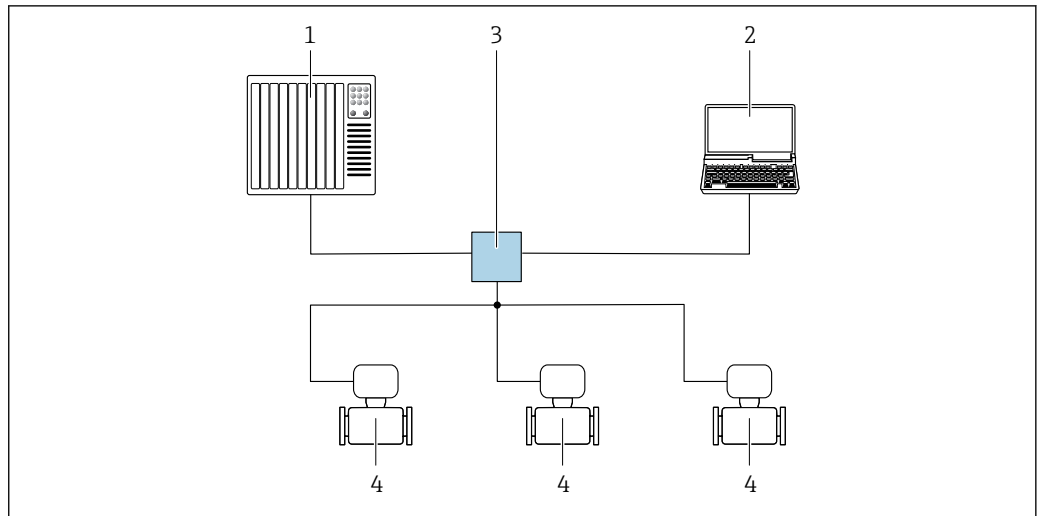

A0026545

40 Options for remote operation via PROFINET network: star topology

- 1 Automation system, e.g. Simatic S7 (Siemens)
- 2 Computer with Web browser (e.g. Internet Explorer) for accessing the integrated device Web server or computer with operating tool (e.g. FieldCare, DeviceCare, SIMATIC PDM) with COM DTM "CDI Communication TCP/IP"
- 3 Switch, e.g. Scalance X204 (Siemens)
- 4 Measuring device

Service interface

Via service interface (CDI-RJ45)

This communication interface is present in the following device version:

- Order code for "Output", option B: 4-20 mA HART, pulse/frequency/switch output
- Order code for "Output", option L: PROFIBUS DP
- Order code for "Output", option N: EtherNet/IP
- Order code for "Output", option R: PROFINET

HART

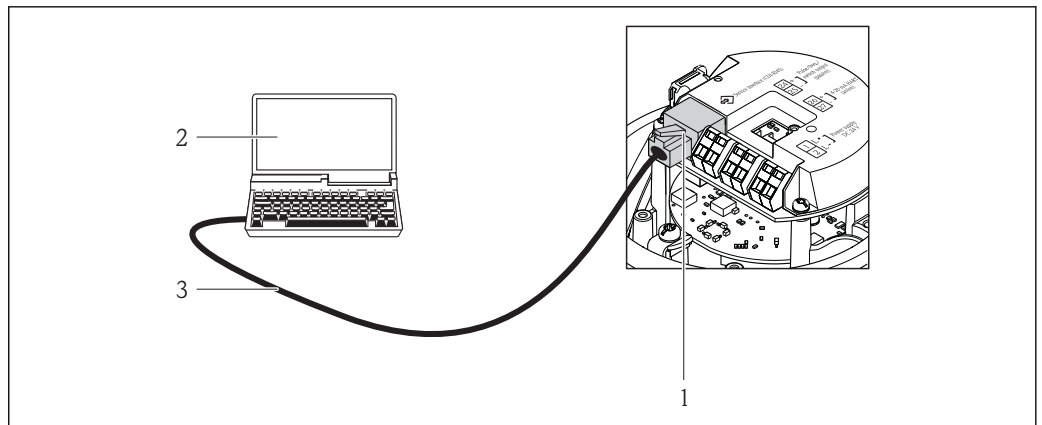

A0016926

41 Connection for the order code for "Output", option B: 4-20 mA HART, pulse/frequency/switch output

- 1 Service interface (CDI -RJ45) of the measuring device with access to the integrated Web server
- 2 Computer with Web browser (e.g. Internet Explorer) for accessing the integrated device Web server or with "FieldCare" operating tool with COM DTM "CDI Communication TCP/IP"
- 3 Standard Ethernet connecting cable with RJ45 plug

PROFIBUS DP

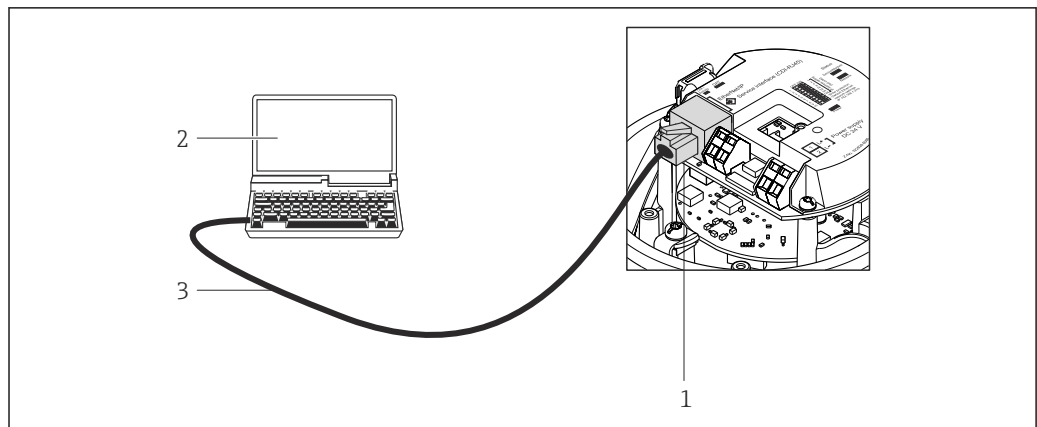

A0021270

42 Connection for order code for "Output", option L: PROFIBUS DP

- 1 Service interface (CDI -RJ45) of the measuring device with access to the integrated Web server
- 2 Computer with Web browser (e.g. Internet Explorer) for accessing the integrated device Web server or with "FieldCare" operating tool with COM DTM "CDI Communication TCP/IP"
- 3 Standard Ethernet connecting cable with RJ45 plug

EtherNet/IP

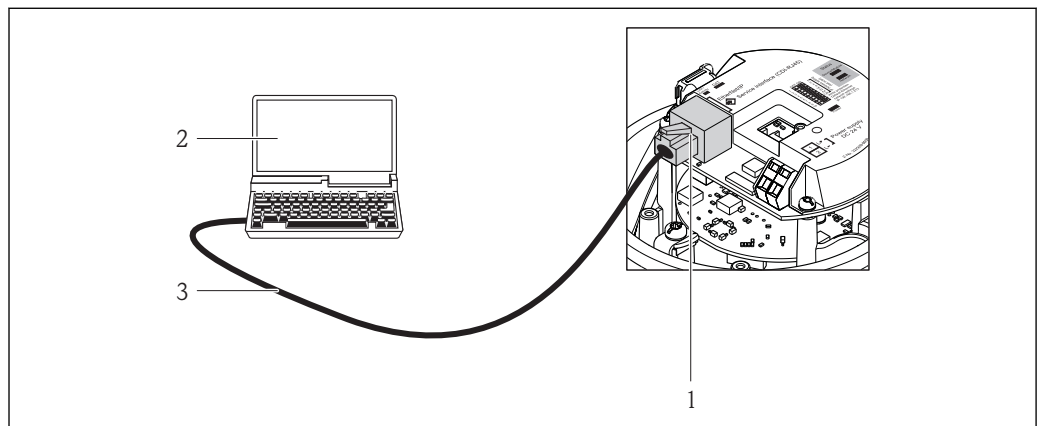

A0016940

43 Connection for order code for "Output", option N: EtherNet/IP

- 1 Service interface (CDI -RJ45) and EtherNet/IP interface of the measuring device with access to the integrated Web server
- 2 Computer with Web browser (e.g. Internet Explorer) for accessing the integrated device Web server or with "FieldCare" operating tool with COM DTM "CDI Communication TCP/IP"
- 3 Standard Ethernet connecting cable with RJ45 plug

PROFINET

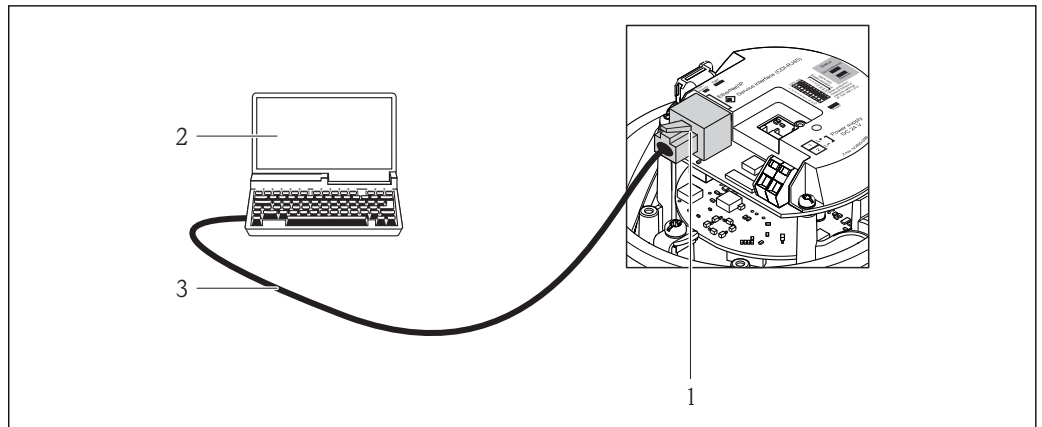

A0016940

44 Connection for order code for "Output", option R: PROFINET

- 1 Service interface (CDI -RJ45) and PROFINET interface of the measuring device with access to the integrated Web server
- 2 Computer with Web browser (e.g. Internet Explorer) for accessing the integrated device Web server or with "FieldCare" operating tool with COM DTM "CDI Communication TCP/IP"
- 3 Standard Ethernet connecting cable with RJ45 plug

Via service interface (CDI)

This communication interface is present in the following device version:
Order code for "Output", option **M**: Modbus RS485

Modbus RS485

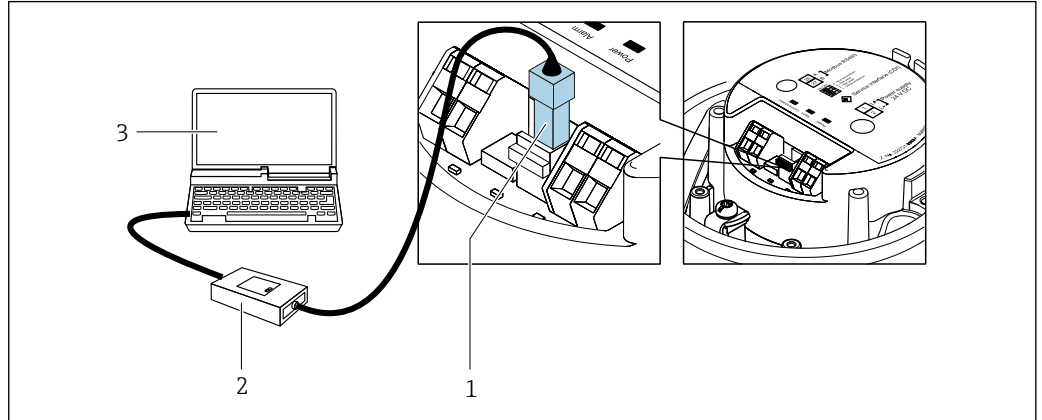

A0030216

- 1 Service interface (CDI) of measuring device
- 2 Commubox FXA291
- 3 Computer with "FieldCare" operating tool with COM DTM "CDI Communication FXA291"

Certificates and approvals

CE mark

The measuring system is in conformity with the statutory requirements of the applicable EU Directives. These are listed in the corresponding EU Declaration of Conformity along with the standards applied.

Endress+Hauser confirms successful testing of the device by affixing to it the CE mark.

C-Tick symbol

The measuring system meets the EMC requirements of the "Australian Communications and Media Authority (ACMA)".

Ex approval

The measuring device is certified for use in hazardous areas and the relevant safety instructions are provided in the separate "Safety Instructions" (XA) document. Reference is made to this document on the nameplate.

 The separate Ex documentation (XA) containing all the relevant explosion protection data is available from your Endress+Hauser sales center.

ATEX/IECEx

Currently, the following versions for use in hazardous areas are available:

Ex ia

Category (ATEX)	Type of protection
II2G	Ex ia IIC T6...T1 Gb or Ex ia IIB T6...T1 Gb
II1/2G, II2D	Ex ia IIC T6...T1 Ga/Gb or Ex ia IIB T6...T1 Ga/Gb Ex tb IIIC Txx °C Db
II2G, II2D	Ex ia IIC T6...T1 Gb or Ex ia IIB T6...T1 Gb Ex tb IIIC Txx °C Db

Ex nA

Category (ATEX)	Type of protection
II3G	Ex nA IIC T6...T1 Gc or Ex nA IIC T5-T1 Gc

cCSA_{US}

Currently, the following versions for use in hazardous areas are available:

IS (Ex i)

- Class I Division 1 Groups ABCD
- Class II Division 1 Groups EFG and Class III

NI (Ex nA)

Class I Division 2 Groups ABCD

Sanitary compatibility

- 3-A approval
Only devices with the order code for "Additional approval", option **LP** "3A" have 3-A approval.
- EHEDG-tested
Only devices with the order code for "Additional approval", option **LT** "EHEDG" have been tested and meet the requirements of the EHEDG.
To meet the requirements for EHEDG certification, the device must be used with process connections in accordance with the EHEDG position paper entitled "Easy Cleanable Pipe Couplings and Process Connections" (www.ehedg.org).

HART certification**HART interface**

The measuring device is certified and registered by the FieldComm Group. The measuring system meets all the requirements of the following specifications:

- Certified according to HART 7
- The device can also be operated with certified devices of other manufacturers (interoperability)

Certification PROFIBUS**PROFIBUS interface**

The measuring device is certified and registered by the PNO (PROFIBUS User Organization Organization). The measuring system meets all the requirements of the following specifications:

- Certified in accordance with PROFIBUS PA Profile 3.02
- The device can also be operated with certified devices of other manufacturers (interoperability)

Certification PROFINET	<p>PROFINET interface</p> <p>The measuring device is certified and registered by the PNO (PROFIBUS User Organization Organization). The measuring system meets all the requirements of the following specifications:</p> <ul style="list-style-type: none"> ■ Certified according to: <ul style="list-style-type: none"> – Test specification for PROFINET devices – PROFINET Security Level 1 – Netload Class ■ The device can also be operated with certified devices of other manufacturers (interoperability)
EtherNet/IP certification	<p>The measuring device is certified and registered by the ODVA (Open Device Vendor Association). The measuring system meets all the requirements of the following specifications:</p> <ul style="list-style-type: none"> ■ Certified in accordance with the ODVA Conformance Test ■ EtherNet/IP Performance Test ■ EtherNet/IP PlugFest compliance ■ The device can also be operated with certified devices of other manufacturers (interoperability)
Modbus RS485 certification	<p>The measuring device meets all the requirements of the MODBUS/TCP conformity test and has the "MODBUS/TCP Conformance Test Policy, Version 2.0". The measuring device has successfully passed all the test procedures carried out.</p>
Pressure Equipment Directive	<p>The devices can be ordered with or without a PED approval. If a device with a PED approval is required, this must be explicitly stated in the order. For devices with nominal diameters less than or equal to DN 25 (1"), this is neither possible nor necessary.</p> <ul style="list-style-type: none"> ■ With the identification PED/G1/x (x = category) on the sensor nameplate, Endress+Hauser confirms conformity with the "Essential Safety Requirements" specified in Appendix I of the Pressure Equipment Directive 2014/68/EC. ■ Devices bearing this marking (PED) are suitable for the following types of medium: <ul style="list-style-type: none"> – Media in Group 1 and 2 with a vapor pressure greater than, or smaller and equal to 0.5 bar (7.3 psi) – Unstable gases ■ Devices not bearing this marking (PED) are designed and manufactured according to good engineering practice. They meet the requirements of Art. 4, Par. 3 of the Pressure Equipment Directive 2014/68/EU. The range of application is indicated in tables 6 to 9 in Annex II of the Pressure Equipment Directive 2014/68/EC.
Other standards and guidelines	<ul style="list-style-type: none"> ■ EN 60529 Degrees of protection provided by enclosures (IP code) ■ IEC/EN 60068-2-6 Environmental influences: Test procedure - Test Fc: vibrate (sinusoidal). ■ IEC/EN 60068-2-31 Environmental influences: Test procedure - Test Ec: shocks due to rough handling, primarily for devices. ■ EN 61010-1 Safety requirements for electrical equipment for measurement, control and laboratory use - general requirements ■ IEC/EN 61326 Emission in accordance with Class A requirements. Electromagnetic compatibility (EMC requirements). ■ NAMUR NE 21 Electromagnetic compatibility (EMC) of industrial process and laboratory control equipment ■ NAMUR NE 32 Data retention in the event of a power failure in field and control instruments with microprocessors ■ NAMUR NE 43 Standardization of the signal level for the breakdown information of digital transmitters with analog output signal. ■ NAMUR NE 53 Software of field devices and signal-processing devices with digital electronics ■ NAMUR NE 80 The application of the pressure equipment directive to process control devices ■ NAMUR NE 105 Specifications for integrating fieldbus devices in engineering tools for field devices

- NAMUR NE 107
Self-monitoring and diagnosis of field devices
- NAMUR NE 131
Requirements for field devices for standard applications
- NAMUR NE 132
Coriolis mass meter

Ordering information

Detailed ordering information is available from the following sources:

- In the Product Configurator on the Endress+Hauser website: www.endress.com -> Click "Corporate" -> Select your country -> Click "Products" -> Select the product using the filters and search field -> Open product page -> The "Configure" button to the right of the product image opens the Product Configurator.
- From your Endress+Hauser Sales Center: www.addresses.endress.com



Product Configurator - the tool for individual product configuration

- Up-to-the-minute configuration data
- Depending on the device: Direct input of measuring point-specific information such as measuring range or operating language
- Automatic verification of exclusion criteria
- Automatic creation of the order code and its breakdown in PDF or Excel output format
- Ability to order directly in the Endress+Hauser Online Shop

Application packages

Many different application packages are available to enhance the functionality of the device. Such packages might be needed to address safety aspects or specific application requirements.

The application packages can be ordered with the device or subsequently from Endress+Hauser. Detailed information on the order code in question is available from your local Endress+Hauser sales center or on the product page of the Endress+Hauser website: www.endress.com.

 Detailed information on the application packages:
Special Documentation for the device →  89

Heartbeat Technology

Package	Description
Heartbeat Verification +Monitoring	<p>Heartbeat Verification Meets the requirement for traceable verification to DIN ISO 9001:2008 Chapter 7.6 a) "Control of monitoring and measuring equipment".</p> <ul style="list-style-type: none"> ■ Functional testing in the installed state without interrupting the process. ■ Traceable verification results on request, including a report. ■ Simple testing process via local operation or other operating interfaces. ■ Clear measuring point assessment (pass/fail) with high test coverage within the framework of manufacturer specifications. ■ Extension of calibration intervals according to operator's risk assessment. <p>Heartbeat Monitoring Continuously supplies data, which are characteristic of the measuring principle, to an external condition monitoring system for the purpose of preventive maintenance or process analysis. These data enable the operator to:</p> <ul style="list-style-type: none"> ■ Draw conclusions - using these data and other information - about the impact process influences (such as corrosion, abrasion, buildup etc.) have on the measuring performance over time. ■ Schedule servicing in time. ■ Monitor the process or product quality, e.g. gas pockets.

Concentration

Package	Description
Concentration measurement	<p>Calculation and outputting of fluid concentrations</p> <p>Many applications use density as a key measured value for monitoring quality or controlling processes. The device measures the density of the fluid as standard and makes this value available to the control system.</p> <p>The observed density is converted to the concentration of a substance of a binary mixture using the "Concentration Measurement" application package:</p> <ul style="list-style-type: none"> ▪ Choice of predefined fluids (e.g. various sugar solutions, acids, alkalis, salts, ethanol etc.) ▪ Common or user-defined units ("Brix", "Plato", % mass, % volume, mol/l etc.) for standard applications. ▪ Concentration calculation from user-defined tables. <p>The measured values are output via the digital and analog outputs of the device.</p>

Accessories







Various accessories, which can be ordered with the device or subsequently from Endress+Hauser, are available for the device. Detailed information on the order code in question is available from your local Endress+Hauser sales center or on the product page of the Endress+Hauser website: www.endress.com.



Device-specific accessories

For the sensor



Accessories	Description
Heating jacket	<p>Is used to stabilize the temperature of the fluids in the sensor.</p> <p>Water, water vapor and other non-corrosive liquids are permitted for use as fluids. If using oil as a heating medium, please consult with Endress+Hauser.</p> <p>Heating jackets cannot be used with sensors fitted with a rupture disk.</p>

Communication-specific accessories



Accessories	Description
Commubox FXA195 HART	<p>For intrinsically safe HART communication with FieldCare via the USB interface.</p> <p> For details, see "Technical Information" TI00404F</p>
Commubox FXA291	<p>Connects Endress+Hauser field devices with a CDI interface (= Endress+Hauser Common Data Interface) and the USB port of a computer or laptop.</p> <p> For details, see the "Technical Information" document TI405C/07</p>
HART Loop Converter HMX50	<p>Is used to evaluate and convert dynamic HART process variables to analog current signals or limit values.</p> <p> For details, see "Technical Information" TI00429F and Operating Instructions BA00371F</p>
Wireless HART adapter SWA70	<p>Is used for the wireless connection of field devices.</p> <p>The WirelessHART adapter can be easily integrated into field devices and existing infrastructures, offers data protection and transmission safety and can be operated in parallel with other wireless networks with minimum cabling complexity.</p> <p> For details, see Operating Instructions BA00061S</p>
Fieldgate FXA320	<p>Gateway for the remote monitoring of connected 4 to 20 mA measuring devices via a Web browser.</p> <p> For details, see "Technical Information" TI00025S and Operating Instructions BA00053S</p>
Fieldgate FXA520	<p>Gateway for the remote diagnostics and remote configuration of connected HART measuring devices via a Web browser.</p> <p> For details, see "Technical Information" TI00025S and Operating Instructions BA00051S</p>

Field Xpert SFX350	Field Xpert SFX350 is a mobile computer for commissioning and maintenance. It enables efficient device configuration and diagnostics for HART and FOUNDATION Fieldbus devices and can be used in non-hazardous areas.  For details, see Operating Instructions BA01202S
Field Xpert SFX370	Field Xpert SFX370 is a mobile computer for commissioning and maintenance. It enables efficient device configuration and diagnostics for HART and FOUNDATION Fieldbus devices and can be used in the non-hazardous area and in the hazardous area.  For details, see Operating Instructions BA01202S

Service-specific accessories

Accessories	Description
Applicator	Software for selecting and sizing Endress+Hauser measuring devices: <ul style="list-style-type: none"> Choice of measuring devices for industrial requirements Calculation of all the necessary data for identifying the optimum flowmeter: e.g. nominal diameter, pressure loss, flow velocity and accuracy. Graphic illustration of the calculation results Determination of the partial order code, administration, documentation and access to all project-related data and parameters over the entire life cycle of a project. Applicator is available: <ul style="list-style-type: none"> Via the Internet: https://wapps.endress.com/applicator As a downloadable DVD for local PC installation.
W@M	W@M Life Cycle Management Improved productivity with information at your fingertips. Data relevant to a plant and its components is generated from the first stages of planning and during the asset's complete life cycle. W@M Life Cycle Management is an open and flexible information platform with online and on-site tools. Instant access for your staff to current, in-depth data shortens your plant's engineering time, speeds up procurement processes and increases plant uptime. Combined with the right services, W@M Life Cycle Management boosts productivity in every phase. For more information, visit www.endress.com/lifecyclemanagement
FieldCare	FDT-based plant asset management tool from Endress+Hauser. It can configure all smart field units in your system and helps you manage them. By using the status information, it is also a simple but effective way of checking their status and condition.  For details, see Operating Instructions BA00027S and BA00059S
DeviceCare	Tool for connecting and configuring Endress+Hauser field devices.  For details, see Innovation brochure IN01047S
Commubox FXA291	Connects Endress+Hauser field devices with a CDI interface (= Endress+Hauser Common Data Interface) and the USB port of a computer or laptop.  For details, see "Technical Information" TI00405C

System components

Accessories	Description
Memograph M graphic data manager	The Memograph M graphic data manager provides information on all the relevant measured variables. Measured values are recorded correctly, limit values are monitored and measuring points analyzed. The data are stored in the 256 MB internal memory and also on a SD card or USB stick.  For details, see "Technical Information" TI00133R and Operating Instructions BA00247R
iTEMP	The temperature transmitters can be used in all applications and are suitable for the measurement of gases, steam and liquids. They can be used to read in the medium temperature.  For details, see "Fields of Activity", FA00006T

Supplementary documentation



For an overview of the scope of the associated Technical Documentation, refer to the following:

- The *W@M Device Viewer* : Enter the serial number from the nameplate (www.endress.com/deviceviewer)
- The *Endress+Hauser Operations App*: Enter the serial number from the nameplate or scan the 2-D matrix code (QR code) on the nameplate.

Standard documentation

Brief Operating Instructions

Brief Operating Instructions for the sensor

Measuring device	Documentation code
Proline Promass E	KA01260D

Transmitter Brief Operating Instructions

Measuring device	Documentation code
Proline Promass 100	KA01334D KA01333D KA01335D KA01332D KA01336D

Technical Information

Measuring device	Documentation code
Proline Promass E 100	TI01351D

Description of Device Parameters

Measuring device	Documentation code
Proline Promass 100	GP01033D
Proline Promass 100	GP01034D
Proline Promass 100	GP01035D
Proline Promass 100	GP01036D
Proline Promass 100	GP01037D

Supplementary device-dependent documentation

Safety Instructions

Content	Documentation code
ATEX/IECEX Ex i	XA00159D
ATEX/IECEX Ex nA	XA01029D
cCSAus IS	XA00160D
INMETRO Ex i	XA01219D
INMETRO Ex nA	XA01220D

Special Documentation

Content	Documentation code
Information on the Pressure Equipment Directive	SD00142D
Modbus RS485 Register Information	SD00154D

Content	Documentation code
Concentration measurement	SD01152D
Concentration measurement	SD01503D
Heartbeat Technology	SD01153D
Heartbeat Technology	SD01493D
Web server	SD01820D
Web server	SD01821D
Web server	SD01822D
Web server	SD01823D

Installation Instructions

Contents	Comment
Installation instructions for spare part sets and accessories	Documentation code: specified for each individual accessory .

Registered trademarks

HART®

Registered trademark of the FieldComm Group, Austin, Texas, USA

PROFIBUS®

Registered trademark of the PROFIBUS User Organization, Karlsruhe, Germany

Modbus®

Registered trademark of SCHNEIDER AUTOMATION, INC.

EtherNet/IP™

Trademark of ODVA, Inc.

PROFINET®

Registered trademark of the PROFIBUS User Organization, Karlsruhe, Germany

Microsoft®

Registered trademark of the Microsoft Corporation, Redmond, Washington, USA

TRI-CLAMP®

Registered trademark of Ladish & Co., Inc., Kenosha, USA

www.addresses.endress.com
