

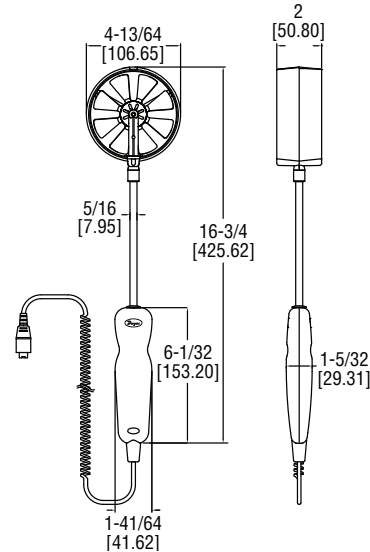

Model VP1 100 mm Vane Thermo-Anemometer Probe for UHH

Specifications - Installation and Operating Instructions



The Model VP1 100 mm Vane Thermo-Anemometer Probe measures air velocity, air flow, humidity, and temperature when combined with the Model UHH Universal Handheld. By having a larger diameter, the rotating vane is able to measure velocities down to 50 fpm or 0.25 m/s. An arrow is molded into the vane housing to depict the flow direction.

PAIRING PROBES

1. Plug VP1 into UHH 6-pin probe connection on the top of the UHH.
2. Turn on Model UHH Universal Handheld by pressing the button.

SETTINGS

When using the Model VP1 Wireless 100 mm Thermo-Anemometer Probe, the base unit can display velocity or air flow along with temperature and humidity. The settings allow users to select velocity or air flow, engineering units, measurement range, and which parameters to show on the display. To access the setting menus:

1. Press the or arrows to scroll through the menu headings at the top of the display.
2. When **PROBE** is highlighted, hit the button to access the probe menu.
3. Press the arrow to scroll through the sub-menu headings. The currently selected parameter will be highlighted in yellow.

Flow / Velocity Selection

1. When sub-menu **TYPE** (next to Anemometer) is highlighted, hit the button to access the settings for the sub-menu.
2. Press the arrow to scroll through the parameters. The currently selected parameter will be highlighted in yellow.
3. When **DISPLAY** is highlighted, press the button and velocity or vol. flow will be highlighted.
4. Pressing the or buttons will alternate between velocity and vol. flow.
5. Once the desired selection is made, press button.

Units Selection

1. When sub-menu **TYPE** (next to Anemometer, Humidity or Temperature) is highlighted, hit the button to access the settings sub-menu.
2. Press the arrow to scroll through the parameter headings. The currently selected parameter will be highlighted in yellow.
3. When **UNITS** is highlighted, press the button and the current units will be highlighted.
4. Pressing the or buttons will cycle through the available units.
5. Once the desired selection is made, press button.

SPECIFICATIONS

Service: Clean Air.

Temperature Limits:

Process: -4 to 140°F (-20 to 60°C);
Ambient: 5 to 125°F (-15 to 51°C).

Range:

Air Velocity: 50 to 5000 fpm (0.25 to 25 m/s).
Temperature: -4 to 140°F (-20 to 60°C).
Relative Humidity: 0 to 100% RH.
Air Volume: 999,999 in selected units.

Accuracy:

Air Velocity: 0.25 to 10 m/s: ±1.5% of reading ±20 fpm (±0.1 m/s); 10 to 20 m/s: 1.5% of reading ±40 fpm (±0.2 m/s); 20 to 25 m/s: ±1.5% of reading ±60 fpm (±0.3 m/s).
Temperature: ±0.54 @ 77°F (±0.3 @ 25°C).
Relative Humidity: ±2% @ 77°F (25°C) (10 to 90% RH); ±4% (0 to 10% and 90 to 100%).

Response Time:

Air Velocity: 1 s.
Temperature: 1.5 s.
Relative Humidity: 1.5 s.
Air Volume: 1 s.

Probe Length: 8" (203 mm) insertion.

Vane Material: Anodized aluminum.









Handle Enclosure: Thermoplastic elastomer over polycarbonate.

Supplied With: Wrist strap.







Weight: 15.2 oz (449.52 g).

Agency Approvals: CE, RoHS.

Area Adjustment (Only when Display is set to Volumetric Flow)

1. When sub-menu **TYPE** (next to Anemometer) is highlighted, hit the  button to access the settings sub-menu.
2. Press the  arrow to scroll through the parameter headings. The currently selected parameter will be highlighted in yellow.
3. When **AREA** is highlighted, press the  button to enter a new submenu that allows selection of the shape of the duct, engineering units in which the duct is measured, and the dimensions of the duct.
4. Press the  arrow to scroll through the parameter headings. The currently selected parameter will be highlighted in yellow.
5. When the desired menu is highlighted, press the  button and the current value of the parameter will be highlighted.
6. Pressing the  or  buttons will cycle through the available options for each parameter.
7. Once the desired selection is made, press  button.
8. After all of the area parameters are made, press  button.













Range Adjustment

1. When sub-menu **TYPE** (next to Anemometer) is highlighted, hit the  button to access the settings sub-menu.
2. Press the  arrow to scroll through the parameter headings. The currently selected parameter will be highlighted in yellow.
3. When **RANGE** is highlighted, press the  button and the current minimum and maximum of the range will be highlighted.
4. Pressing the  or  buttons will cycle through the available ranges.
5. Once the desired selection is made, press  button.

Display Measurements

NOTICE

The measurements on the **MAJOR** display will always be displayed, but the measurements on the secondary displays can be turned off.

1. When **MAJOR** is highlighted, press the  button and the measurement type selected will be highlighted.
2. Pressing the  or  buttons will cycle through the available parameters.
3. Once the desired selection is made, press  button.
4. In order to turn off the secondary displays, use the  and  to select the measurement type that is not selected for the **MAJOR** display.
5. When the desired **TYPE** is highlighted, hit the  button to access the settings sub-menu.
6. Press the  arrow to scroll through the parameter headings. The currently selected parameter will be highlighted in yellow.
7. When **VISIBLE** is highlighted, press the  button and either ON or OFF will be highlighted. The measurement will be displayed when set to ON and not displayed when set to OFF.
8. Pressing the  or  buttons will alternate between ON and OFF.
9. Once the desired selection is made, press  button.

MAINTENANCE/REPAIR

Upon final installation of the Model VP1, no routine maintenance is required. The Model VP1 is not field serviceable and should be returned if repair is needed. Field repair should not be attempted and may void warranty.

WARRANTY/RETURN

Refer to "Terms and Conditions of Sales" in our catalog and on our website. Contact customer service to receive a Return Goods Authorization number before shipping the product back for repair. Be sure to include a brief description of the problem, plus any additional application notes.