



Model UHH - Universal Handheld Test Instrument

Specifications - Installation and Operating Instructions



Front View



Side View

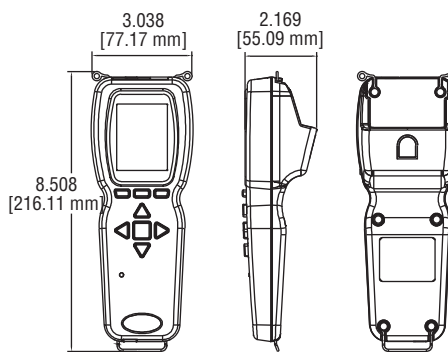

The Model UHH Universal Handheld Test Instrument is a highly versatile instrument that offers the utmost flexibility and ease of user operation by having the capacity to work with a variety of Dwyer Instruments, Inc. compatible sensing modules and probes. Additional wired and wireless probes or modules are instantly recognized by the UHH without any user reprogramming or alteration, allowing seamless sensor addition, upgrade or replacement. See the AQT Series in the Dwyer Instruments, Inc. catalog or website www.dwyer-inst.com for available packages and sensors.

The Universal Handheld offers numerous features that enable a technician to quickly set up and intuitively navigate through their daily activities. Data is stored via the internal memory or a separate SD card in various auto or manual logging operations. Logged files can be quickly transferred to a PC or laptop through a USB cable or by a portable SD card. The display can operate in standard numerical meter mode, gage mode with an analog needle, gage mode with additional pass/fail operation zones, and strip chart mode which enables a simplified visual tracking of the process. The four directional buttons, combined with the three soft key buttons that are aligned to corresponding screen functions, allow for quick navigation through the four main operation menus.

The rugged plastic case, with protective thermo-plastic over-mold and the dust-shielding rubber caps, permit the unit to handle abuse and properly withstand dusty environments. The base UHH includes an integral molded compartment that securely holds wireless modules. The storage compartment offers convenient transportation of a module with the base instrument during testing. A flexible hand strap, included with every UHH, allows the base handheld to be safely connected to a belt, pipe, ladder or similar structure freeing the user's hands to focus on the sampling test. A 6-pin connector enables one wired probe at a time to be plugged in to the base instrument without worry of becoming disconnected during sampling. Additional wireless units can be paired to the base handheld allowing users to quickly switch between multiple parameters that need to be measured.

The rechargeable battery via the included USB cable provides long term operation to last through several days of work. At just under 10 oz, the compact UHH base is lightweight. Included with the UHH is a soft carrying case, universal office / car charger, and USB cable.

NOTICE

This device complies with Industry Canada license-exempt RSS standard(s). Operation is subject to the following two conditions:

(1) This device may not cause harmful interference. and (2) this device must accept any interference received, including interference that may cause undesired operation.

Cet appareil est conforme à des règlements d'Industrie Canada exempts de licence standard RSS (s). Son fonctionnement est soumis aux deux conditions suivantes: (1) Ce dispositif ne doit pas causer d'interférences nuisibles, et (2) cet appareil doit accepter toute interférence reçue, y compris les interférences pouvant entraîner un fonctionnement indésirable.

This Class B digital apparatus complies with Canadian ICES-003.

Cet appareil numéroté de la classe B est conforme à la norme NMB-003 du Canada.

UHH SPECIFICATIONS

Languages: English, German, Italian, Portuguese, Spanish.

Display: OLED, color 240 x 320.

Temperature Limits: 5 to 125°F (-15 to 51°C).

Note: When using wireless function: 20 to 125°F (-6 to 51°C).

Battery Charging Limits: 32 to 113°F (0 to 45°C).

Resolution: 1 FPM, 0.1 MPS, 0.1 CFM & M³/HR; 0.1°F & °C; RH 0.1%.

Units Air Velocity: FPM, MPH, KN, M/H, M/S K/H, FPS.

Units Flow: CFM, M³/HR, M³/S, GPM, GPH, GPD, LPS, LPM, LPH.

Units Temperature: °F, °C.

Handle Enclosure: Thermoplastic elastomer over polycarbonate.

Maximum Wireless Distance: 50' (15 m) typical.

Power Requirements: 3 V BR1225 lithium metal battery, installed functional, non-replaceable and 3.7 V lithium ion battery, installed functional, non-replaceable. (**Note:** Intended to be operated with power cables less than 3 m in length).

Memory: 4 MB internal (~50,000 readings).

Weight: 10 oz (283 g).

Supplied With:

AQT1: Soft case; USB cable/charger; Hand strap;

AQTIP: Soft case; Hard case; USB cable/charger; Hand strap, 2GB SD card.

Agency Approvals: CE (not while charging), FCC compliant.

NOTICE

In some instances, it might be necessary to update the firmware of the UHH base unit. Dwyer Instruments, Inc. will provide information and files necessary to complete this upgrade in the field or the units can be returned to the factory to complete any future firmware updates.

NOTICE

While UHH is connected to a pc, the unit will act as a storage device for retrieving log files. During this time, the unit cannot be used to take measurements.

UHH FEATURE OUTLINE



SIDE VIEW

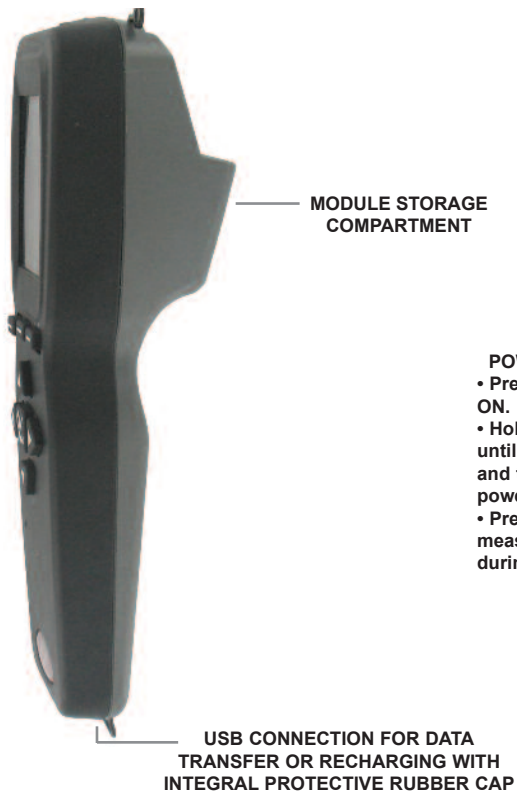

WIRELESS PROBE



MENU SETUP



Probe Main Menu

Probe Menu

- Press the **◀▶** to scroll through the top main menus.
- When **PROBE** is highlighted, hit the enter key.

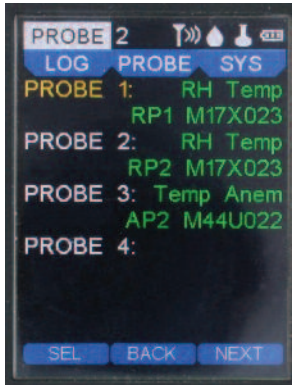

Pairing Mode Sub-Menu

- After placing the UHH into **Pairing Mode**, turn on one wireless probe. After a period of up to 15 to 20 seconds, the UHH screen will update with the information about the wireless probe that was just turned on.

Note: If probe does not appear, power probe down, then power back on.



Pairing Mode Sub-Menu (cont'd)

- To confirm a proper pairing, select that probe on the list. That probe's details will disappear, meaning that probe has been paired. The details of paired probes will now be visible in the **Paired** sub-menu. Once paired, no other UHH can pair with that probe as long as your UHH is communicating with that probe.
- In **Paired** sub-menu you can see probes that are paired with the UHH. You may delete probes from being paired by selecting the probe. Once deleted, any UHH can pair with that probe.
- The currently active probe connected will appear as well as the parameter types being provided to the UHH. **ACTIVE** will detail the active probe's description, model code and corresponding serial number.
- Select the primary measurement of the home screen under the **SOURCE** setting.
- To alter the potential modes of the measurements, scroll down to any of the **TYPE** sub-menus to select and adjust.



TYPE Sub-Menu Anemometer (Velocity Selected)

- In this example, the **Anemometer** can be changed from either **Velocity** mode or **Vol. Flow** mode.
- Change the engineering units to be displayed under the **UNITS** section.
- Note:** Some probes or modules may provide a selectable range which can be adjusted here.



TYPE Anemometer Sub-Menu (Vol. Flow Selected)

- Similarly to when **Velocity** is selected, applicable engineering units can be chosen in the **UNITS** category for **Vol. Flow**.
- Note an area must be entered.



Area Sub Menu (Vol. Flow Selected)

- If **Vol. Flow** is chosen, select the **AREA** category to adjust the **DUCT** style, the **AREA UNITS**, **HEIGHT** and **WIDTH** dimensions.

• In this example, the **Temperature** range is set and cannot be changed as it is green and unselectable, however the units may be adjusted and the user can decide if the temperature will be displayed in the home screen.



TYPE Sub-Menu Temperature

SYS Menu



SYS Main Menu

- Press the ◀ ▶ to scroll through the top main menus.
- When **SYS** is highlighted, push the enter key.
- The **STATUS** will show how many probes are currently paired.
- The **WIRELESS** feature may be turned on or off and the display **CONTRAST** adjusted here as well.
- If desired, a **RESTORE DEFAULT** feature is available from this screen.
- Note: **FILE** displays remaining available memory. If **INT** is selected in the **LOG** main menu the maximum memory is 4 MB. A 2 GB memory card is the maximum memory the UHH can utilize if **SD** is selected.



Status Sub Menu

- If you select the **STATUS** sub menu you can view the firmware edition as well as the UHH device handle.

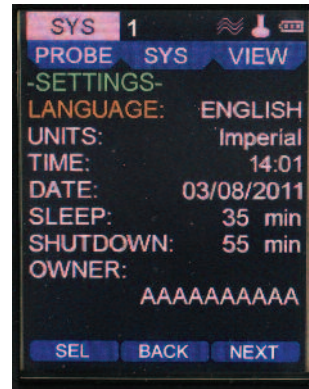

SETTINGS Sub Menu

- Click on the **SETTINGS** sub menu for language selection as well as the default engineering units. The **DATE** and **TIME** can be entered, as well as power management inactivity time delays for **SLEEP** and **SHUTDOWN**.
- The user can program in their name, an identification code or their company name into the **SETTINGS** sub menu under **OWNER**.



VIEW METER Mode

VIEW Menu

- Press the ◀ ▶ to scroll through the top main menus.
- When **VIEW** is highlighted, select with the enter key.
- Several viewing modes are available on the home screen from the selections in this menu.
- The default is **METER** which displays numerical values.
- The **AVERAGE** setting calculation is programmed in this menu.
- **AVERAGE** values may be altered from 1 to 60 seconds.

Home Display Under Standard Meter Mode

On the home display, multiple parameters may be viewed at the same time depending on the probe or module being used. If two or more parameters are displayed, the largest reading at the top will always be present and may be switched between parameters (see the **PROBE** main menu for details). In order to change the probe selected to be viewed, press the up or down arrow keys.



Parameter Hot Key

- The three soft keys under the display can be used to quickly access the most common menu functions.
- The label, above the soft key on the left, describes the active parameter for the other two soft keys (i.e. If **ANEMO** is displayed above the left soft key, the other two soft keys will refer to the velocity or flow parameter that is displayed).
- Pressing the soft key under the word **UNITS** cycles through the available engineering units of the selected parameter.
- The center soft key will quickly select the mode of operation (i.e. Velocity or Volumetric Flow are the available modes of operation for **ANEMO**).

NOTICE When Volumetric Flow is selected, Settings will show instead of **UNITS** as the area and range will also need to be changed for Volumetric Flow in addition to the engineering units.

• Pressing the left soft key will switch to the next displayed parameter (if one exists) or will change to the **DISPLAY** hot keys if there is only one parameter displayed. If there is multiple parameters displayed, the left soft key will cycle to **DISPLAY** after cycling through all of the displayed parameters.



Display Hot Key Home Screen

- When **DISPLAY** is selected, the center soft key will cycle through the display modes of operation which include the current reading, average readings, and peak and valley readings.
- Pressing the soft key under **CLEAR**, will reset the peak and valley readings to the current reading.
- Pressing the left soft key under **DISPLAY** will switch to the **LOG** hot keys.



LOG Hot Key Home Screen

- When **LOG** is selected, the center soft key will access the Log Menu Settings. In this menu, the parameter that is going to be logged can be selected, along with the type of trigger and duration of the Log. See the Log Menu for information about the Log settings.
- If Manual or Event trigger types are selected, then the soft key on the right under **STORE** will trigger to start a new log. Before starting the log, the user must create the log file and name the log. Once the log is started, the label will change to **STOP** and pressing the button will stop the current log. For Event triggers, even though the meter will be in logging mode, there will not be any readings stored until the current measurement meets the conditions of the event or the minimum set time for recording a measurement.

NOTICE When the log is started, the display will return to the home view and the user will have to push the left soft key several times until **LOG** appears to have access to the **STOP** soft key.

- If Single trigger type is selected, then the soft key on the right under **STORE** will store the current value into the open log file.
- The log counter will track how many measurements were stored in the current log file.
- Pressing the left soft key under **LOG** will switch to the **SOURCE** hot keys.



SOURCE Hot Key Home Screen

- When **SOURCE** is selected, the center soft key will select the parameter to show on the larger display at the top.
- The soft key on the right side under **HOLD**, will freeze the current reading and change the label above the soft key on the right side to **RUN**. Pressing the button again will unfreeze the readings and toggle the label back to **HOLD**.
- Pressing the left soft key under **SOURCE** will return to the first parameter's hot keys.

Alternative Home Displays Views

In addition to displaying the measurements as a digital meter, the UHH allows the user to view the measurements either as a gauge, a gauge with range bands, or as a graphical strip chart.



View GAUGE Mode

- In the view menu, choose **GAUGE** mode to display a digital analog gauge like one similar to a speedometer. The available range will be adjustable with min and max scale feature.
- Adjust both the **min** and **max** for the associated values that will correspond to the 0° value for min and the 180° value for the max or full scale reading.

NOTICE Some probes or modules may have selectable ranges that are programmed in the **PROBE** menu under **RANGE**. You cannot go above this chosen full scale **RANGE** in the **GAUGE** setting in the **VIEW** menu..



Home View GAUGE Mode

- In this example, the **min** is zero and the **max** is 500. The live process value is shown under the gauge dial.
- The mid point will always show at the 90° point on the gauge dial. • Select **RANGE**



View RANGE Mode

- in the **VIEW** category in the view menu.
- Two sets of **min** and **max** will appear listed as **GAUGE** and **RANGE**.
- The **GAUGE** settings are just as in the previous **GAUGE** view mode and show the zero and full scale points of the dial.
- The **RANGE low** and **high** settings provide a different color green zone to appear on the dial of the digital gauge. This two color band dial provides a quick determination during a test if the reading is in the pass or fail zone.



Home View RANGE Mode

- In this example, the **GAUGE** has a **min** of 0 and a **max** of 500. The **RANGE low** is 100 while the **high** is 400.
- A green zone on the dial corresponding to the **RANGE low/high** settings will appear on the home screen.



View STRIP Mode

- Select **STRIP** in the view category in the view menu. This option offers the user a strip chart style graph with Y axis scaled with the selected major sensor setting and an X axis showing the selected time.
- The x axis time may be adjusted from 10 to 3,600 seconds.



Home View STRIP Mode

- Besides the time setting shown on the graph, you can program the graph to show full scale of the range of the sensor, half scale where the top of the Y axis is half of the full scale, or mid-scale where half the full scale value is displayed in the middle of the Y axis.

LOG Main Menu



LOG Main Menu

- Press the ◀▶ to scroll through the top main menus.
- When **LOG** is highlighted, push the enter key.
- Here you can program the sampling rate of the logging. The sampling **RATE** may be adjusted from 1 to 3600 seconds between recordings.
- The **FILE FORMAT** can be altered from **CSV** to a **TSV** downloadable file type.
- You can program the **TRIGGER** to be a manual trigger, a trigger begun by a programmed event or a single trigger which manually logs a single point by the push of a button.
- Select the **LOG** to **START** and **STOP** the logging function. The LED will flash when the data sample is stored in any logging mode. A log status icon will also appear at the top to acknowledge a logging session is active. The log counter will list how many measurements have been recorded in the current log file.
- After the log session has begun, the file name will appear on the **FILE** row.
- You may select under **MEDIA** to either store data logged files to an **SD** card if one is inserted or to **INT** which is the internal memory.
- Select **LOG FILES** to view all saved files. See view of saved files section for more details.

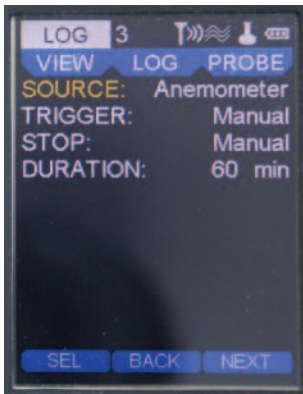

LOG TRIGGER Menu

- If the trigger has been selected to be **Manual** from the **LOG** main menu, the screen above will appear.

- You can change the ending of the log to be either a manual end under **STOP**, or you can set the **STOP** to end after a duration.
- If **DURATION** is chosen the programmed duration determines how long the log session will last. It may be set from 1 to 1,440 minutes.

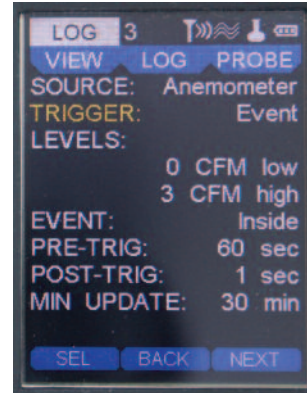

LOG TRIGGER Event Menu

- If the **TRIGGER** has been selected to be **Event** from the **LOG** main menu, the screen will appear as shown.
- The trigger's source parameter must be selected to determine the levels for the event.
- **LEVELS** provides initiation points where the trigger will begin a log operation.
- The auto trigger **EVENT** settings can begin **INSIDE** or **OUTSIDE** the **LEVELS** trigger band.
- Setting a **PRE-TRIG** setting to anything other than 0 will provide data recorded to the file for that time period prior to the event trigger initiation.
- **POST-TRIG** sets the duration after the auto trigger event of the log session.
- If the **MIN UPDATE** is set to anything other than 0, a data point will be captured at the time of the **MIN UPDATE** even if the **TRIGGER** threshold has not been reached.
- The **PRE-TRIG** and **POST-TRIG** can be adjusted over a time period, dependent on the sample rate, while the **MIN UPDATE** can be set from 0 to 60 minutes.

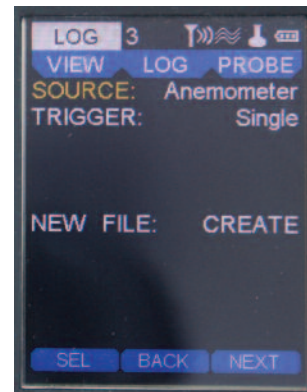

Home View If Single Trigger Chosen

If **Single** is chosen, no other parameters are necessary to be programmed. This mode will allow the right soft key located under **STORE** in the log hot key home display to save a single data point into a file. Each subsequent data point will continue to be stored in that same file until a new file is created in the Log Settings Trigger Menu shown above when operating a new file, the user can name the file.

Viewing Currently Saved Files

The files that are stored in the internal memory or on the SD card can be viewed on the display in the Log Main Menu. The **MEDIA** setting selects the memory location and the **LOG FILES** Setting opens the list of currently available log files.

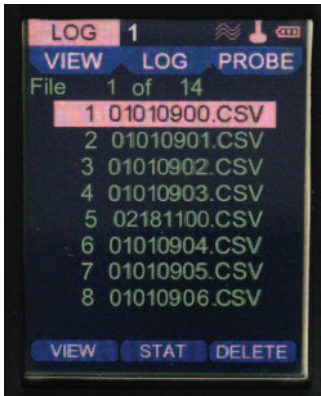

List of Log Files

File names can be scrolled through and their data viewed by selecting **VIEW**. Calculated statistics of the data from a file are viewable such as average or peak and valley by selecting **STAT**. A file may be deleted by hitting **DELETE**. To exit this screen and return to the previous, press the left arrow key.



VIEW of Saved Files

The following will appear after hitting **VIEW** from the saved files list. Numerical order value in the saved group along with its file name and format, the **DATE**, **TIME** of that data point and the parameter data values recorded. To scroll through each data point's information within a file, press the **▲▼** navigation keys. Any data point may be deleted in their respective file by pressing **DEL**.

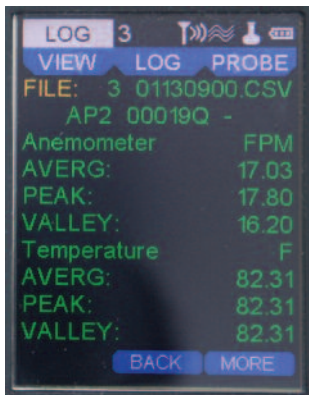

STAT (Statistics) of a Saved File

After selecting **STAT** from the saved file list screen you will see statistics for all data within the respective file. Average, Peak and Valley will be visible for all parameters. The soft key under **MORE** will display additional parameters if available.

NOTICE If there are many stored data points on a file, some time may elapse before the statistics shown above appear.



Low Battery Warning

Low Battery Warning

The low battery level screen will appear when the UHH detects its charge to be nearing an end. The lithium ion polymer battery is expected to provide approximately 1000 full charge cycles over its lifespan. Once the battery has exceeded its useful lifespan, due to varying regulations regarding shipping lithium batteries, please contact Dwyer Instruments Inc. for details.

NOTICE It is required before the initial use of the module to fully charge the battery for 12 hours.

WARNING Lithium ion polymer batteries are very volatile and can cause a fire if punctured or severely damaged. Only use a Dwyer Instruments, Inc. approved charging device in a well ventilated area away from any flammable materials or gases. Do not incinerate. Only charge between 32 to 113°F (0 to 45°C).

MAINTENANCE/REPAIR

Upon final installation of the Series UHH, no routine maintenance is required. The Series UHH is not field serviceable. Contact Dwyer Instruments Inc. for return details (field repair should not be attempted and may void warranty).

WARRANTY/RETURN

Refer to "Terms and Conditions of Sales" in our catalog and on our website. Contact customer service to receive a Return Goods Authorization number before shipping the product back for repair. Be sure to include a brief description of the problem plus any additional application notes.

ACCESSORIES

Model	Description
AP1	Thermo-anemometer air velocity & temperature probe with coiled cable
RP1	Thermo-hygrometer & temperature probe with coiled cable
VP1	100 mm vane thermo-anemometer air velocity, temperature, humidity probe
AP2	Wireless thermo-anemometer air velocity & temperature probe
RP2	Wireless thermo-hygrometer humidity & temperature probe
VP2	Wireless 100 mm vane thermo-anemometer air velocity, temperature, humidity probe
UHH-STRAP	UHH hand strap
UHH-ICHRG	UHH charger with international adapters
UHH-CBL	USB cable
UHH-SD	2GB SD card
UHH-C1	Soft carrying case
UHH-C2	Heavy duty hard case with pre-cut foam inserts for additional sensor storage