

# OPERATION MANUAL

Dakota NDT

## BT1-DL

Ultrasonic Bolt Tension Monitor

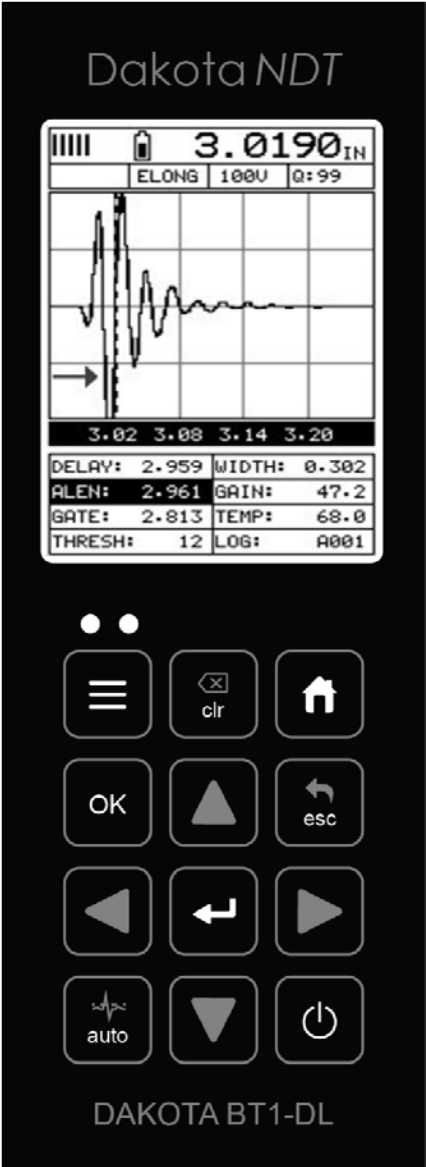



# Table of Contents

<b>CHAPTER ONE INTRODUCTION .....</b>	<b>1</b>
1.1 GENERAL DISCLAIMER.....	1
1.2 SAFETY.....	1
1.3 WARRANTY .....	2
<b>CHAPTER TWO ABOUT THIS MANUAL .....</b>	<b>3</b>
2.1 NEW TO ULTRASONICS?.....	3
2.2 NEW TO FASTENER MEASUREMENT? .....	3
2.3 <i>BT1-DL</i> OVERVIEW .....	3
2.4 TABBED & HOT MENU REFERENCE .....	6
<b>CHAPTER THREE QUICK START GUIDE .....</b>	<b>8</b>
3.1 OVERVIEW .....	8
3.2 GETTING THE <i>BT1-DL</i> READY .....	8
3.3 SETTING UP THE <i>BT1-DL</i> .....	8
3.4 CREATING A NEW GROUP TO STORE MEASUREMENTS .....	11
3.5 SETTING THE APPROXIMATE LENGTH .....	19
3.6 MEASURING REFERENCE LENGTHS.....	22
3.7 MEASURING ELONGATIONS.....	23
<b>CHAPTER FOUR KEYBOARD, MENU, &amp; CONNECTOR REFERENCE .....</b>	<b>25</b>
4.1 MENU KEY (OPERATION & SUB MENUS).....	25
4.2 CAL – MENU.....	27
4.3 MATL (MATERIAL) – MENU .....	28
4.4 GEOM (GEOMETRY) – MENU.....	28
4.5 DISP (DISPLAY) – MENU.....	29
4.6 TUNE – MENU .....	30
4.7 GATES – MENU .....	31
4.8 AUTO – MENU.....	31
4.9 SETUP – MENU.....	32
4.10 DATA – MENU .....	32
4.11 UTIL (UTILITIES) – MENU .....	33
4.12 XFER (TRANSFER) – MENU .....	34
4.13 CLR (CLEAR) KEY .....	34
4.14 MEAS (MEASUREMENT MODE) KEY .....	34
4.15 OK KEY .....	34
4.16 ESC KEY.....	35
4.17 ARROW KEYS.....	35

4.18 ENTER KEY .....	35
4.19 AUTO SET KEY .....	35
4.20 ON/OFF KEY .....	35
4.21 NAVIGATING THE HOT MENU .....	35
4.22 TOP & BOTTOM END CAPS .....	37
<b>CHAPTER FIVE THEORY OF OPERATION.....</b>	<b>38</b>
5.1 ULTRASONIC MEASUREMENT OF BOLTS.....	38
5.2 FEATURES OF THE <i>BT1-DL</i> .....	38
5.3 ULTRASONIC WAVES .....	39
5.4 MEASUREMENT MODE.....	39
<b>CHAPTER SIX BOLT PREPARATION .....</b>	<b>40</b>
6.1 USE OF ULTRASONIC COUPLANT .....	40
6.2 TRANSDUCER CONTACT REQUIREMENTS.....	40
6.3 BOLT END REFLECTORS.....	42
<b>CHAPTER SEVEN TRANSDUCER SELECTION .....</b>	<b>44</b>
7.1 SELECTING THE TRANSDUCER.....	44
<b>CHAPTER EIGHT MEASURING SYSTEM ZERO (CALIBRATION) .....</b>	<b>45</b>
8.1 INTRODUCTION .....	45
8.2 CALIBRATION / ZERO MISNOMER.....	45
8.3 CREATING A GROUP TO DOCUMENT ZERO (CALIBRATION) DATA .....	46
8.4 AUTO - ZERO/CALIBRATION .....	47
8.5 ONE & TWO POINT ZERO CALIBRATION .....	50
8.6 VERIFICATION OF SYSTEM ZERO CALIBRATION.....	58
8.7 USING A 'SET ASIDE' BOLT .....	65
<b>CHAPTER NINE TEMPERATURE COMPENSATION.....</b>	<b>67</b>
9.1 PURPOSE .....	67
9.2 MANUAL MODE .....	67
9.3 SEMI AUTOMATIC MODE.....	68
9.4 AUTOMATIC MODE .....	70
<b>CHAPTER TEN BOLT MATERIAL CALIBRATION.....</b>	<b>71</b>
10.1 WHY CALIBRATE? .....	71
10.2 VELOCITY CALIBRATION .....	71
10.3 STRESS FACTOR CALIBRATION.....	75
10.4 TEMPERATURE FACTOR CALIBRATION .....	79
<b>CHAPTER ELEVEN LOAD MEASUREMENT .....</b>	<b>82</b>
11.1 CALCULATING LOAD FACTOR.....	82

11.2 CALIBRATING LOAD FACTOR (FIELD CALIBRATION) .....	84
11.3 PERFORMING A FIELD CALIBRATION .....	85

**CHAPTER TWELVE MEASUREMENT & WAVEFORM DISPLAY..... 99**

12.1 QUANTITIES OF MEASUREMENT .....	99
12.2 DISPLAY VIEW OPTIONS .....	100
12.3 ADJUSTING THE DISPLAY .....	104
12.4 GAIN .....	108
12.5 GATE .....	111
12.6 THRESHOLD .....	114
12.7 INTERPRETING THE WAVEFORM .....	117
12.8 MANUALLY LOCATING THE ECHO .....	118
12.9 AUTOMATIC ECHO OPTIMIZATION (AUTO SET) .....	120
12.10 UNLOADED LENGTH AND ELONGATION MEASUREMENTS .....	123

**CHAPTER THIRTEEN ADDITIONAL FEATURES..... 124**

13.1 QUALITY/CORRELATION (TRANSDUCER PLACEMENT) .....	124
13.2 LOCK SYSTEM ZERO .....	124
13.3 CONTRAST .....	125
13.4 BACKLIGHT .....	126
13.5 GRAPHICS OPTIONS (LOOK & FEEL) .....	127
13.6 PULSE .....	129
13.7 PULSER VOLTAGE .....	130
13.8 DAMPING .....	131
13.9 DIGITIZER .....	132
13.10 POLARITY .....	133
13.11 ALARM MODE.....	134
13.12 KEY CLICK .....	137
13.13 DATE & TIME.....	137
13.14 UPGRADE GAUGE .....	139
13.15 FREEZE & CAPTURE .....	140
13.16 CAPTURE VIEWER .....	141

**CHAPTER FOURTEEN DATA STORAGE – SETUP, EDIT, & VIEW FILES 143**

14.1 INTRODUCTION TO A PROJECT .....	143
14.2 CREATING A PROJECT FOLDER/DIRECTORY .....	143
14.3 VIEWING & OPENING A PROJECT FOLDER .....	145
14.4 INTRODUCTION TO GROUP (SPREADSHEET) FORMAT .....	146
14.5 CREATING A NEW GROUP .....	147
14.6 STORING A READING.....	150
14.7 VIEWING STORED READINGS .....	151
14.8 DELETING GROUPS (FILES) .....	152

14.9 EDITING A GROUP (FILE) .....	155
14.10 CHANGING THE ACTIVE FILE - OPEN.....	157
14.11 CLOSING AN ACTIVE FILE - CLOSE .....	159

**CHAPTER FIFTEEN SETUPS – CREATE, STORE, EDIT, & RECALL .....160**

15.1 INTRODUCTION TO SETUPS.....	160
15.2 OPENING A SETUP .....	160
15.3 SAVING A SETUP .....	161
15.4 DELETING A SAVED SETUP .....	164
15.5 USING THE DEFAULT SETUP .....	166
15.6 SELECTING A LANGUAGE .....	167

**CHAPTER SIXTEEN SOFTWARE, FILE TRANSFER, & UPGRADES.....169**

16.1 COMPUTER SYSTEM REQUIREMENTS.....	169
16.2 INSTALLING DAKVIEW.....	169
16.3 COMMUNICATING WITH <i>BT1-DL</i> .....	169
16.4 LINE POWER.....	169
16.5 UPGRADING THE <i>BT1-DL</i> .....	169

## CHAPTER ONE INTRODUCTION

The Dakota NDT model **BT1-DL** is used to measure the stretch (elongation, load, stress and %strain) of a fastener under tension. This is accomplished ultrasonically by sending an ultrasonic wave down the length of the fastener and accurately measuring the change in transit time between an unloaded versus loaded fastener/bolt, and calculating a physical stretch. The objective for using ultrasonics, over conventional/mechanical methods is accuracy. Most conventional methods refer to a torque value which has limited accuracy due to the coefficient of friction. The coefficient of friction is difficult to determine, as it depends on the control and application of lubrication.

The **BT1-DL** avoids the coefficient of friction entirely, using the transit time of a wave, Hooke's law, and Young's modulus to accurately calculate the stretch on a bolt. Since the **BT1-DL** cannot physically stretch a bolt, both conventional/mechanical methods and the **BT1-DL** are complimentary and used in conjunction.

Dakota NDT maintains a customer support resource in order to assist users with questions or difficulties not covered in this manual. Customer support may be reached at any of the following:

Dakota NDT
1500 Green Hills Road, #107
Scotts Valley, CA 95066 USA
Telephone: (831) 431-9722
Facsimile: (831) 431-9723
<a href="http://www.dakotandt.com">www.dakotandt.com</a>

### 1.1 General Disclaimer

The manual should be read and understood prior to using the **BT1-DL**. This operating manual provides the user with all the general information necessary to use and adjust the designed features. However, this manual is not a certified NDT/Bolting training course, nor is it intended to be one. Training, according to company requirements, is recommended. The responsibility for proper use of the instrument rests solely on the user.

### 1.2 Safety

Using the **BT1-DL** while standing in water or in a wet environment can result in serious electric shock, injury, and even death.

Operating the **BT1-DL** with damaged or inadequate cables and power source can result in serious electric shock, injury, and even death.

Failure to read this manual and understand the proper operation of the **BT1-DL** can result in inaccurate measurements, and lead to decisions which cause property damage, personal injury, or even death.

Use of the **BT1-DL** for any other purpose, or in any other manner than described in this manual invalidates the warranty and can result in serious electric shock, injury, and even death.

### **1.3 Warranty**

The Dakota NDT **BT1-DL** carries a two year limited warranty. The warranty only applies to **BT1-DL** units being operated as described in this manual. Software and hardware failures of the unit will be repaired or replaced at Dakota NDT discretion. Dakota NDT will not be held liable for any damage caused, interruption of business, loss of profits, etc., resulting from such failures. Dakota NDT will not be liable to repair or replace a unit, which has been damaged, used inappropriately, or subject to unauthorized repair by the purchaser.



## CHAPTER TWO ABOUT THIS MANUAL

This chapter is intended to help you make the best use of this manual. Readers may have different knowledge of ultrasonic bolt measurement and may find parts of this manual repetitive or unnecessary.

### 2.1 New To Ultrasonics?

There are a variety of ultrasonic applications currently being utilized in today's industry. For example weld inspection, thickness measuring, immersion testing of flaws, etc. The use of ultrasound to measure forces in fasteners is relatively new compared to the previously mentioned traditional applications.

Ultrasonic measurement of bolts provides an extremely accurate means of determining fastener load, provided the correct techniques are utilized. As a new user, careful consideration of this entire manual is highly recommended.

### 2.2 New to fastener measurement?

Assuming you are familiar with ultrasonics, but unfamiliar with fastener measurement, the chapters on transducer selection and the theory of operation can be skipped entirely.

The **BT1-DL** measures load on the fastener by measuring the amount the fastener stretches. As load is applied to the fastener, it stretch's just as a spring would stretch. The stretch is proportional to the load while the load is less than the elastic limit of bolt. By measuring the stretch of the fastener and knowing the physical properties of the fastener, the load of the fastener can be calculated. The **BT1-DL** measures the fastener stretch by ultrasonically measuring the change in length.

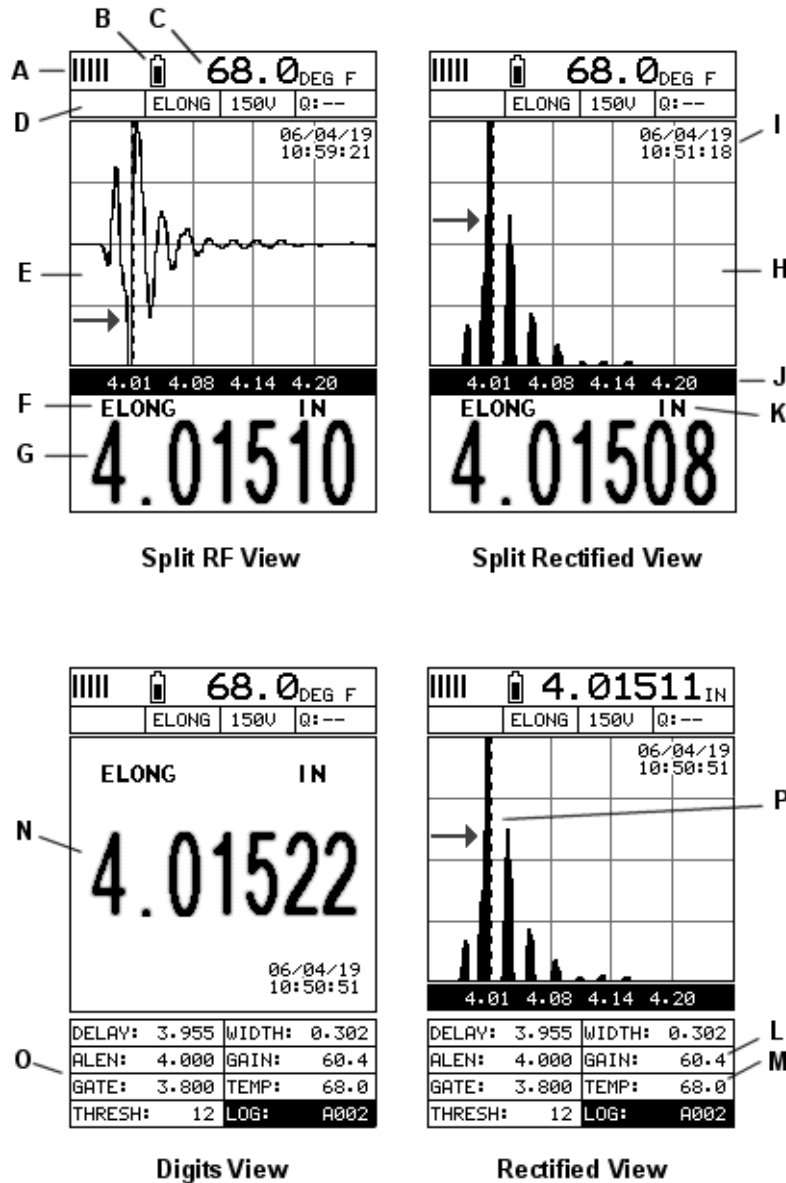

Be sure to setup and experiment with a test fixture of some kind as a means of becoming familiar with your **BT1-DL**.

### 2.3 **BT1-DL** Overview







In order to understand how to operate the **BT1-DL**, it's best to start off with an understanding of what it is we're looking at exactly. The **BT1-DL** has a lot of great features, tools, and flexibility to assist you with all of your bolting applications. Let's have a brief look at the screens you'll be looking at most often:

- A. **Repeatability/Stability Indicator** – Indicates the reliability of the measured bolt length. When all the vertical bars are fully illuminated and the last digit on the digital thickness value is stable, the **BT1-DL** is reliably measuring the same value on a consistent basis.
- B. **Battery Icon** – Indicates the amount of battery life the **BT1-DL** has remaining.

- C. **Temperature** – Indicates the current temperature of either the temperature sensor, or manual value entered.
- D. **Feature Status Bar** – Indicates the features currently enabled and in use:
- Alarm
  - Quantity
  - Pulser Voltage
  - Q-Factor (wave correlation)
- E. **RF A-Scan Display (split screen)** – Displays the radio frequency sound wave reflection returned the opposite end of the bolt being measured. The RF view displays both the positive and negative cycles.
- F. **Quantity** – Displays the current quantity setting used (elongation, load, stress, strain or time).
- G. **Digital Measurement** – Display in inches, millimeters, KSI, KIPS, %strain, time (nanoseconds).
- H. **Rectified A-Scan Display** – Displays either the positive or negative half cycle wave reflection returned from the opposite end of the bolt being measured, depending on the polarity selected.
- I. **Time & Date** – Feature to display either the time, date, or both time and date on the main measurement screen.
- J. **Length Division Markers** – Measurement scale of length.
- K. **Units** – Displays the current measurement units being used (English, Metric).
- L. **Gain** – The current gain setting can be adjusted at any time while in measurement mode.
- M. **Temperature** – Refer to (C) above. The location of the temperature is displayed in this location when the hot menus are shown. Notice in (C) the view is split screen and temperature is displayed in the top right corner of the display. When the temperature mode is set ‘manual’, the value can be changed at any time.
- N. **Digital Measurement** – Display in inches, millimeters, KSI, KIPS, %strain, time (nanoseconds).
- O. **Hot Menu items** – We call this menu section our “hot menu”, as these items are the most commonly adjusted features, requiring quick access from the user. They can be displayed and scrolled by pressing the  key at any time. The  key advances forward and the  key backwards to the next hot menu item.
- P. **Detect/Gate/Threshold** – The broken dotted line demonstrates where the **BT1-DL** is currently detecting on the waveform. Notice the horizontal line with an arrow pointing at the detection point. This is the ‘gate’, and the height of the line from the baseline is the ‘threshold’ level.

## 2.4 Tabbed & Hot Menu Reference

The following table is a quick menu reference guide of the tabbed menu items, which can be accessed by pressing the  key multiple times to tab right, or the  key multiple times to tab left through the tabbed menus. The **BT1-DL** has 11 tabbed menu titles and multiple submenu items as illustrated below. The **BT1-DL** also has 1 'hot menu' subset of commonly adjusted menu items. They can be quickly accessed from the main measurement screen by pressing the  key multiple times to access and tab right, or pressing the  key multiple times to tab left through the hot menu cells. Refer to Chapter Four for additional definitions and information on the keypad and menu items.

Hot Menu Items	
----------------	--

**Note:** "Log" and "Temp" are also listed in the Hot Menu, and are used to access data storage if no log file is currently open, or display log or grid file if open, as well as display the temperature.

Start >>

CAL	MATL	GEOM	DISP	TUNE	GATES	AUTO	SETUP
ZERO MODE	UNITS	QUANTITY	VIEW	PULSE	POLARITY	AUTO SET	OPEN
ZERO	TYPE	LOAD FACTOR	CONTRAST	PULSER VOLTAGE	GATE	APPROX LEN (ALEN)	SAVE
MEASURE ZERO	VELOCITY	LOAD OFFSET	BACKLIGHT	DAMPING	THRESHOLD 1		DELETE
LOCK SYS ZERO	STRESS FACTOR	AREA	DELAY	GAIN			DEFAULT SETUP
LOAD CAL MODE	TEMP COEF	EFFECTIVE LEN	WIDTH	GAIN STEP			
LOAD CAL CALC			RECT WAVE	DIGITIZER			LANGUAGE
			DETECT MARK				

>> End

<b>DATA</b>	<b>UTILS</b>	<b>XFER</b>
PROJECT	TEMP MODE	UPGRADE GAUGE
NEW	ALARM	CAPTURE TO FILE
EDIT	ALARM LOW	CAPTURE VIEWER
OPEN	ALARM HIGH	ABOUT
CLOSE	KEY CLICK	
DELETE ONE FILE	SET DATE	
DELETE ALL DATA	SHOW DATE	
SUMMARY		

## CHAPTER THREE QUICK START GUIDE

### 3.1 Overview

This section demonstrates the basic procedures for setting up and measuring bolts using the **BT1-DL**. More in depth explanations pertaining to the individual functions and features can be found in the chapters that follow.

Here we go!

### 3.2 Getting the **BT1-DL** ready

#### Making all the connections

In order to get the **BT1-DL** ready for operation; the following connections must be made:







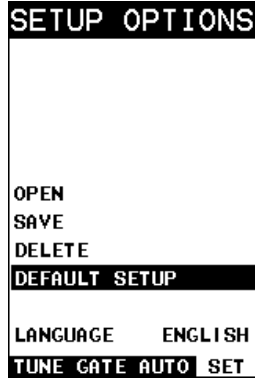

- 1) Remove the **BT1-DL** from the carrying case.
- 2) Connect the transducer cable to the transducer and plug it into the **BT1-DL**.
- 3) If a temperature sensor is being used, connect the sensor to the **BT1-DL**.

### 3.3 Setting up the **BT1-DL**

**Please Read:** In this section the **BT1-DL** will be setup in its simplest form. Remember this is only a quick start guide to get the user up and measuring bolts. Before we setup the gauge to measure basic elongation, the following assumptions must be made: A preset material type will be used. The user will not be re-measuring the fasteners at a later date to monitor relaxation of the joint over time. This eliminates the need for an instrument zero/calibration. All these assumptions will be answered and explained in detail in the chapters that follow.

#### Selecting Default Setup







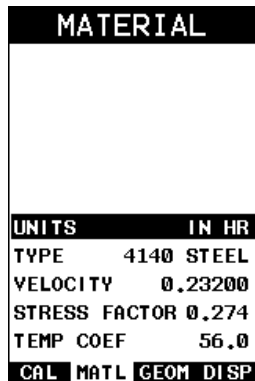

- 1) Press the  key to power up the **BT1-DL**.
- 2) Press the  key once to activate the menu items tab. Press the  key multiple times to tab right and the  key multiple times to tab left until the **SETUP** menu is highlighted and displaying the submenu items.
- 3) Use the  and  arrow keys multiple times to scroll through the submenu items until **DEFAULT SETUP** is highlighted.
- 4) Press the  key to display the confirmation screen, followed by pressing the  key to load the default setup.

### Selecting the Units



**Note:** *The default setup, selected in the previous section, automatically defaults to English units – inches. Follow the procedure below to change the units to Metric, if needed.*

- 1) Press the  key multiple times to tab right and the  key multiple times to tab left until the **MATL** menu is highlighted and displaying the submenu items.
- 2) Use the  and  arrow keys to scroll through the sub menu items until **UNITS** is highlighted.
- 3) Press the  and  arrow keys to scroll through the unit options **IN** (inches), **IN HR** (inches hi resolution), **MM** (millimeters), and **MM HR** (millimeters hi resolution).

**Note:** *The high-resolution options display an additional digit of resolution to the measurement. This mode is typically used when measuring very short bolts with very little elongation.*









### Selecting the Material Type

MATERIAL	
UNITS	IN HR
TYPE	4140 STEEL
VELOCITY	0.23200
STRESS FACTOR	0.274
TEMP COEF	56.0
CAL	MATL GEOM DISP

This section allows the user the ability to select a material from a list of preset material types. Keep in mind that we are measuring elongation only. If your material is not in the list, select a similar material type. When measuring in



elongation mode, the measurement consists of a difference equation only (Loaded Length – Unloaded Length =  $\Delta$  Length). Therefore, it doesn't matter if the ultrasonic length is different from the actual physical length, because the  $\Delta$  Length will be the same. Example: 2.0080" physical loaded length – 2.0000" physical unloaded length = 0.0080"  $\Delta$  Length which is equivalent to 2.1080" ultrasonic loaded length – 2.1000" ultrasonic unloaded length = 0.0080"  $\Delta$  Length.







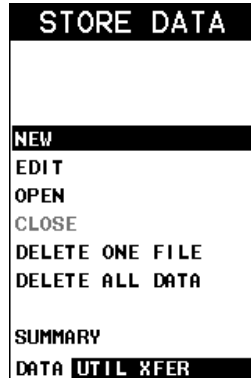

- 1) Press the  and  arrow keys multiple times to scroll through the sub menu items until **TYPE** is highlighted.
- 2) Press the  key to display the list material types.
- 3) Press the  and  arrow keys multiple times to scroll through the material list until the appropriate type is highlighted.
- 4) Press the  key to display the confirmation screen.
- 5) Press the  key to select the type and return to the menu screen, or  to cancel selecting the material type.

### 3.4 Creating a New Group to Store Measurements





Now that the **BT1-DL** is all setup, this section will explain how to get started measuring unloaded initial lengths. In order to do this, we need to create a group that contains bolts. A group can have up to 250 bolts, each bolt containing 1 reference length (L-REF), and up to 51 elongations. Keep in mind that the **BT1-DL** uses a group to store measurements and all gauge settings at the time of measurement.



#### Creating a Group Name



- 1) Press the  key once to activate the menu items tab. Press the  key multiple times to tab right, and the  key multiple times to tab left, until the **DATA** menu is highlighted and displaying the submenu items.
- 2) Press the  and  arrow keys multiple times to scroll through the submenu items until **NEW** is highlighted.
- 3) Press the  key to display the **New Group Edit Box**.
- 4) Press the  and  arrow keys multiple times to scroll through the new **Group List Items** until **NAME** is highlighted.
- 5) Press the  key to activate the **Alpha Edit Box**.





- 6) Press the     arrow keys to highlight the appropriate alpha characters.
- 7) Press the  key to select a character and advance to the next field of the **Group Name**.





- 8) Use the  key to backspace if necessary.
- 9) Repeat steps 6 - 8 until the **Group Name** is completed.
- 10) Press the  key to save the **Group Name** and return to the **Group List Items** menu, or  to cancel entering the **Group Name**.





### Creating a Group Note

LOG NOTE	
DATE:	06/04/19
NOTE: 1/2 5MHZ SER#	
JOB:	GOLDEN GATE
OPER:	JOHNNY BOLT
COM1:	JOB WENT OK
COM2:	VIEW WAS
COM3:	BETTER
COM4:	

- 1) Press the  and  arrow keys multiple times to scroll through the new **Group List Items** until **NOTE** is highlighted.
- 2) Press the  key to activate the **Alpha Edit Box**.

LOG NOTE									
0	1	2	3	4	5	6	7	8	9
!	"	#	\$	%	&	'	(	)	*
A	B	C	D	E	F	G	H	I	J
K	L	M	N	O	P	Q	R	S	T
U	V	W	X	Y	Z				
1/2 5MHZ SER									
OK					ESC				







- 3) Press the     arrow keys to highlight the appropriate alpha characters.



- 4) Press the  key to select a character and advance to the next field of the **Group Note**.
- 5) Use the  key to backspace if necessary.
- 6) Repeat steps **3 - 5** until the **Group Note** is completed.
- 7) Press the  key to save the **Group Note** and return to the **Group List Items** menu, or  to cancel entering the **Group Note**.

### Selecting the Number of Bolts in the Group



**Note:** A group can contain up to 250 bolts. There must be at least 1 bolt in a group.

NEW BOLT GROUP	
NAME:	BOLTS-R-US
NOTE:	1/2 5MHZ
<b>NUM BOLTS</b>	<b>1</b>
NUM READS	1
START BOLT	1
INCR DIR:	NONE
CREATE GRID	

- 1) Press the  and  arrow keys multiple times to scroll through the new **Group List Items** until **NUM BOLTS** is highlighted.
- 2) Press the  key to display the **Digits Edit Box**.
- 3) Press the  and  arrow keys multiple times to scroll the highlighted value.
- 4) Press the  and  arrow keys multiple times to scroll the digit locations.

- 5) Repeat steps **3 & 4** until the **NUM BOLTS** value is correctly displayed.
- 6) Press the  key to save the **NUM BOLTS** and return to the **Group List Items** menu, or  to cancel entering the **NUM BOLTS**.



**Note:** *If a number greater than 250 is entered, an error message box "VALUE IS OUT OF RANGE" will be displayed.*







- 7) Press the  key to display the **Digits Edit Box** and re-enter the **NUM BOLTS**.
- 8) Press the  key to save the **NUM BOLTS** and return to the **Group List Items** menu, or  to cancel entering the **NUM BOLTS**.

### Selecting the Number of Readings Per Bolt



**Note:** *A bolt can have up to 51 possible measurements and 1 initial length (L-REF). There must be at least one reading per bolt.*



NEW BOLT GROUP	
NAME:	BOLTS-R-US
NOTE:	1/2 5MHZ
NUM BOLTS	1
<b>NUM READS</b>	<b>1</b>
START BOLT	1
INCR DIR:	NONE
CREATE GRID	

- 1) Press the  and  arrow keys multiple times to scroll through the new **Group List Items** until **NUM READS** is highlighted.
- 2) Press the  key to display the **Digits Edit Box**.

- 3) Press the  and  arrow keys multiple times to scroll the highlighted value.
- 4) Press the  and  arrow keys multiple times to scroll the digit locations.
- 5) Repeat steps **3 & 4** until the **NUM READS** value is correctly displayed.
- 6) Press the  key to save the **NUM READS** and return to the **Group List Items** menu, or  to cancel entering the **NUM READS**.

**Note:** *If a number less than 1 or greater than 51 is entered, an error message box “VALUE IS OUT OF RANGE” will be displayed.*









- 7) Press the  key to display the **Digits Edit Box** and re-enter the **NUM READS**.
- 8) Press the  key to save the **NUM READS** and return to the **Group List Items** menu, or  to cancel entering the **NUM READS**.

If there's not enough memory available to create the group, an error message box “**NOT ENOUGH MEMORY**” will be displayed. Press the  or  key to return to the **Group List Items** menu. It may be necessary to free some memory in the **BT1-DL** at this time.



### **Selecting the Starting Bolt Number**

**Note:** *Depending on the application and layout of the project, the user won't always want the starting bolt to be 1. This feature allows the user to define what the starting number will be.*

NEW BOLT GROUP	
NAME:	BOLTS-R-US
NOTE:	1/2 5MHZ
NUM BOLTS	1
NUM READS	1
<b>START BOLT</b>	<b>1</b>
INCR DIR:	NONE
CREATE GRID	

- 1) Press the  and  arrow keys multiple times to scroll through the new **Group List Items** until **START BOLT NUM** is highlighted.
- 2) Press the  key to display the **Digits Edit Box**.
- 3) Press the  and  arrow keys multiple times to scroll the highlighted value.
- 4) Press the  and  arrow keys multiple times to scroll the digit locations.
- 5) Repeat steps **3 & 4** until the **START BOLT NUM** value is correctly displayed.
- 6) Press the  key to save the **START BOLT NUM** and return to the **Group List Items** menu, or  to cancel entering the **START BOLT NUM**.





**Note:** If a value is enter that is greater than the maximum number of bolts allowed per group (250), an error message box "VALUE IS OUT OF RANGE" will be displayed.

- 7) Press the  key to display the **Digits Edit Box** and re-enter the **START BOLT NUM**.
- 8) Press the  key to save the **START BOLT NUM** and return to the **Group List Items** menu, or  to cancel entering the **START BOLT NUM**.

### Selecting the Auto Increment Direction

The **Auto Increment** feature gives the user the ability to specify which direction to advance the cursor after storing a reading.

NEW BOLT GROUP	
NAME:	BOLTS-R-US
NOTE:	1/2 5MHZ
NUM BOLTS	1
NUM READS	1
START BOLT	1
<b>INCR DIR:</b>	<b>NONE</b>
CREATE GRID	







- 1) Press the  and  arrow keys multiple times to scroll through the new **Group List Items** until **INCR. DIR** is highlighted.
- 2) Press the  and  arrow keys multiple times to toggle the **Increment** direction **NONE, NORTH, EAST, SOUTH, or WEST**.
- 3) When the correct **Increment** direction is displayed, continue on to the next section "**Saving the Group**".

### Saving the Group

Once all the parameters are set, the user has the option of saving or canceling the new group.



NEW BOLT GROUP	
NAME:	BOLTS-R-US
NOTE:	1/2 5MHZ
NUM BOLTS	1
NUM READS	1
START BOLT	1
INCR DIR:	NONE
CREATE GRID	



- 1) Press the  and  arrow keys multiple times to scroll through the new **Group List Items** until **CREATE GROUP?** is highlighted.
- 2) Press the  key to accept the group parameters, and activate the confirmation screen.
- 3) Press the  key to save the **New Group**, or the  key to cancel the **New Group** setup and return to the **DATA** menu.
- 4) Press the  key to return to the measurement screen to begin measuring reference lengths.

### 3.5 Setting the Approximate Length

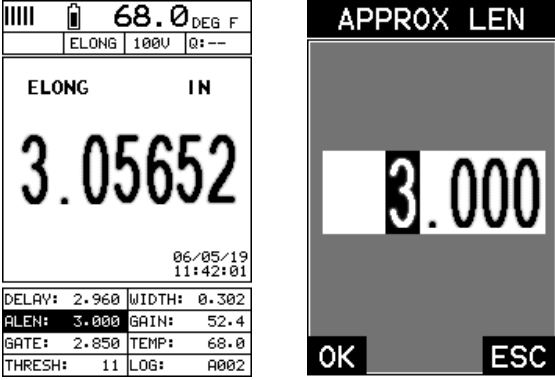

In order to utilize the **AUTO SET** feature of the **BT1-DL**, when measuring reference lengths, the **BT1-DL** has to know where to start looking for the detection. We can accomplish this by entering an approximate length into the gauge. The **BT1-DL** will automatically take the value entered and scan +/- 5% in both directions of the approximate length for the detection signal. The approximate length is a very valuable feature that can be used to pin point a specific detection area. This feature will be further discussed later in the manual.



#### Setting the Approximate Length using the Hot Menu





1) Press the  key once to activate measure menu items. Press the  key multiple times to advance to the next cell right and the  key multiple times to advance to the next cell left, until the **ALEN** cell is highlighted.

2) Press the  key to display the **Digits Edit Box**.

3) Press the  and  arrow keys multiple times to scroll the highlighted value.

4) Press the  and  arrow keys multiple times to scroll the digit locations.









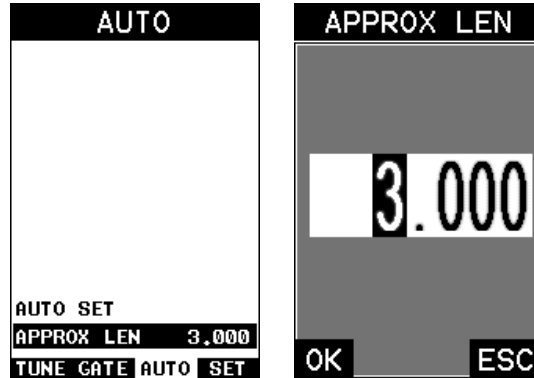



5) Repeat steps 3 & 4 until the **ALEN** value is correctly displayed.

6) Press the  key to return to the measurement screen, or  to cancel entering the **ALEN**.

The user can also access and set the approximate length from the tabbed menus. However, this method is more tedious than making the adjustments using the Hot Menus. The procedure using the tabbed menus is outlined below:

### Setting the Approximate Length using the Tabbed Menus





- 1) Press the  key once to activate the menu items tab. Press the  key multiple times to tab right, and the  key multiple times to tab left, until the **AUTO** menu is highlighted and displaying the submenu items.
- 2) Press the  and  arrow keys multiple times to scroll through the sub menu items until **APPROX. LEN.** is highlighted.
- 3) Press the  key to display the **Digits Edit Box**.
- 4) Press the  and  arrow keys multiple times to scroll the highlighted value.
- 5) Press the  and  arrow keys multiple times to scroll the digit locations.
- 6) Repeat steps 4 & 5 until the **Approx. Len.** value is correctly displayed.
- 7) Press the  key to set the **Approx. Len.** and return to the menu screen, or  to cancel entering the **Approx. Len.**.
- 8) Finally, press the  key to return to the measurement screen and begin measuring reference lengths.

### 3.6 Measuring Reference Lengths





At this point, the **BT1-DL** is setup and ready to start measuring reference lengths. We've already setup a bolt group to store the reference length data, and now need to display the group storage locations prior to making measurements.

#### Storing a Reading

DELAY: 2.958	WIDTH: 0.302
ALEN: 3.000	GAIN: 51.0
GATE: 2.850	TEMP: 68.0
THRESH: 10	LOG: A003

- 1) Press the  key once to activate measure menu items. Press the  key multiple times to move right and the  key multiple times to move left until the **LOG** cell is highlighted.

NAME	BOLTS	R	US
A	B	C	
1	4.01493		
2	3.05655	0.00000	
3			

- 2) Press the  key to display the **Group View Box**.
- 3) Press the     arrow keys to scroll the target cell cursor to the desired storage location.

**Note:** *The approximate lengths must always be located in the first column A for all bolts in the group.*

- 4) Place a small amount of couplant on the transducer and attached it to the bolt. Make sure that the transducer is seated so that there is no couplant layer creating a gap between the transducer and bolt. This can be accomplished by rotating the transducer clockwise and counter clockwise while applying a very small amount of pressure to seat the transducer firmly against the bolt.

**Important Note:** *Always be sure to place the transducer in the same exact location if it will be removed in between reference lengths and elongation measurements. This will eliminate any potential sound path error caused by*

*moving the transducer to a completely different location on the bolt, thus causing potentially erroneous measurements. Be consistent and as methodical in your methods as possible. This will help to avoid transducer placement errors.*

5) Press the  key, located in the bottom left corner of the keypad, to locate the detection point, or end of the bolt.

6) Press the  key to save the current approximate length in the highlighted cell location.

**Note:** *If the measurement was saved in error, press the  key at anytime to clear the stored reading and re-measure using the steps 4 – 6 above.*

**Note:** The **Group View Box** can be aborted at any time by pressing the  key.





### 3.7 Measuring Elongations

Now that the reference lengths have been measured and saved, we're ready to start measuring elongation values. We'll start off by assuming the bolt has been stretched or tightened, the transducer has been once again coupled to the bolt in the same location as before, and we're ready to measure the elongation as follows:



#### Measuring an Elongation

**Important Note (recap):** Always be sure to place the transducer in the same exact location if it will be removed in between reference lengths and elongation measurements. This will eliminate any potential sound path error caused by moving the transducer to a completely different location on the bolt, thus causing potentially erroneous measurements. Be consistent and as methodical in your methods as possible. This will help to avoid transducer placement errors.

NAME: BOLTS-R-US			
	A	B	C
1	4.02888	0.00008	
2	4.02916		
3			
4			

1) Press the     arrow keys to scroll the target cell cursor to the desired storage location.

**Note:** Elongation values must be stored in column B - ZZ.

**Note:** Do not press the  key, while measuring elongation's, as this activates a high speed mode used specifically with our shut-off box. The  feature is only used when measuring reference lengths. If the  key is accidentally pressed, press it again to turn the high speed mode off.

2) Press the  key to save the current elongation in the highlighted cell location.

**Note:** If the measurement was saved in error, press the  key at anytime to clear the stored reading and re-measure using steps 1 & 2 above.

3) Continue to repeat this process until all the elongation measurements have been completed.

**Note:** The **Group View Box** can be aborted at any time by pressing the  key.

## CHAPTER FOUR KEYBOARD, MENU, & CONNECTOR REFERENCE







### 4.1 Menu Key (Operation & Sub Menus)

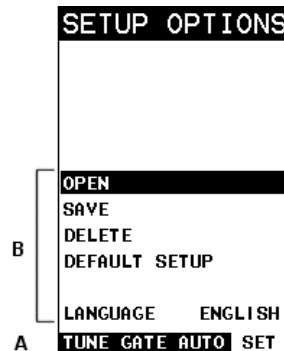

The **MENU** key activates the primary menu structure containing 11 menu tab groups. These tab groups then contain sub menu items, or functions. The sub menu items have been organized in tab groups according to how closely they are related to the individual tab group names. Let's first get familiar with how to move around in these tabs before continuing on to the sub menu functions. This procedure is outlined below:





### Activating and Getting Around in the Menu Items



- 1) Press the  key once to activate the menu items tab. Press the  key multiple times to tab right, and the  key multiple times to tab left until the desired tab group is highlighted and displaying the submenu items **(A)**.

Now that you're familiar with activating and moving amongst the tab groups, let's have a look at how to move around in the sub menu items as follows:

### Getting Around in the Sub Menu Items

- 1) Use the  and  arrow keys to scroll through the sub menu items until the desired function is highlighted. The sub menu items are illustrated in the diagram above **(B)**.
- 2) Depending on which function is highlighted, use the  and  arrow keys to scroll the options/values, or the  key to activate the **Digit Edit** and **List Box** options.

The sections to follow will provide the user with an explanation of the sub menu functions:



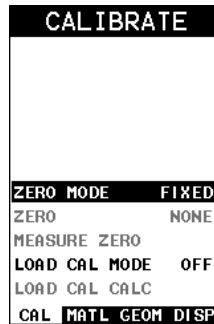

## 4.2 CAL – Menu

**ZERO MODE:** The **BT1-DL** is zeroed in much the same way that a mechanical micrometer is zeroed. There are three zero mode options available in *the BT1-DL* – FIXED, ONE POINT, TWO POINT and AUTO. Selecting the proper mode is dependent on the application requirements, but the most convenient mode of preference is - AUTO. Refer to page 45, for an explanation of this important procedure.

**ZERO VALUE:** Depending on the Zero Mode selected above, the actual zero value will be calculated and displayed in this sub menu item. The user can edit this value at anytime from this sub menu item. Refer to page 45 for a further explanation.

**MEASURE ZERO:** Once the Zero Mode has been selected above, this function displays and calculates the actual measurement screen containing the known physical length, velocity, and temperature coefficient of the calibration standard versus the ultrasonic length. . Refer to page 45 for a further explanation.

**LOCK SYS ZERO:** Locks the zero value in the calibration menu from being overwritten by opening previously saved setup files. Each setup file records the system zero at the time it was saved. Refer to page 124 for further explanation.

**LOAD CAL MODE:** Enables and disables the field calibration feature of the **BT1-DL**. This is used to compare known and ultrasonic loads. Refer to page 84 for a further explanation.

**LOAD CAL CALC:** This feature is used to calculate a linear regression or vector curve, once the Load Cal Mode is enabled and known and ultrasonic loads have been entered and ultrasonically measured. If the regression option was selected in Load Cal Mode, a correction load offset and load factor will be calculated. If the vector option was selected, a load factor will be calculated and the offset will be set to zero. Refer to page 84 for a further explanation.

MATERIAL	
UNITS	IN HR
TYPE	4140 STEEL
VELOCITY	0.23200
STRESS FACTOR	0.274
TEMP COEF	56.0
CAL	MATL GEOM DISP

### 4.3 MATL (material) – Menu

**UNITS:** Toggle between English and Metric units and multiple resolutions for each unit ( IN - .0001, INHR - .00001, or MM - .001, MMHR - .0001 ), Using the abbreviation HR to represent High Resolution.

**TYPE:** Select the bolt material type from a preset list of material types. Each type contains a velocity, stress factor, and temperature factor. When a type is selected, these values are displayed in the sub menu items below and can be edited by the user at anytime.

**VELOCITY:** This feature allows the user to edit the material velocity at anytime. Once a material type is selected, the velocity of the selected material type is stored in this sub menu item and can be edited a by the user if necessary.

**STRESS FACTOR:** This feature allows the user to edit the stress factor at anytime. Once a material type is selected, the stress factor of the selected material type is stored in this sub menu item and can be edited by the user if necessary. Refer to page 75 for further info.

**TEMP COEF:** This feature allows the user to edit the material temperature coefficient at anytime. Once a material type is selected, the temperature coefficient of the selected material is stored in this sub menu item and can be edited by the user if necessary. Refer to page 79 for further info.

GEOMETRY	
QUANTITY	ELONG
LOAD FACTOR	0.000
LOAD OFFSET	0.0
AREA	0.000
EFFECTIVE LEN	0.00
CAL	MATL GEOM DISP

### 4.4 GEOM (geometry) – Menu

**QUANTITY:** Selectable units of measure in terms of TIME, ELONGATION, LOAD, STRESS, and % STRAIN. Refer to page 99 for further info.

**LOAD FACTOR:** The conversion factor from elongation to Load. This value is typically determined by performing a field calibration and running a regression or

vector using the **BT1-DL** or utility software. Alternatively, the load factor can be determined using the bolt calculator in the utility software. However, if extreme accuracy is required, performing a field calibration is a must. This sub menu item enables the user to edit the factor at anytime. Refer to page 82 for further info.

**LOAD OFFSET:** Normally the Load Offset is set to zero. However, when a field calibration is performed and regression calculated a small offset (y intercept) will result. This value is a constant added or subtracted from the measurement, and will result in correction to the load quantity. This sub menu item enables the user to edit the offset value at anytime. Refer to page 82 for further info.

**AREA:** The cross sectional area of the fastener being measured. Used to calculate stress. Set to zero if the user is not measuring the quantity in terms of stress. This sub menu item enables the user to edit the area at anytime. Refer to page 82 for further info.

**EFFECTIVE LENGTH:** The length of the region of the fastener under stress (the distance between the nut plus some amount of additional stress that occurs in the head and nut(s) of the fastener). This sub menu item enables the user to edit the effective length at anytime. Refer to page 82 for further info.

SET DISPLAY	
VIEW	DIGITS
CONTRAST	10
BACKLIGHT	OFF
DELAY	2.958
WIDTH	0.302
RECT WAVE	FILLED
DETECT MARK	DOTS
CAL	MATL GEOM DISP

#### 4.5 DISP (display) – Menu

**VIEW:** Selectable RF wave, RECT (rectified), and DIGITS (large digits) views. Refer to page 100 for further info.

**CONTRAST:** Adjustable display contrast for variable light conditions. An arbitrary scale of 1-20 has been implemented, with the darkest setting at 20. Refer to page 125 for further info.

**BACKLIGHT:** Selectable OFF, ON, AUTO, or INVERT back light option. Refer to page 126 for further info.

**DELAY:** Provides the user the ability to change where the left side of the display window starts according to time which is converted to a length, in English or Metric units. Refer to section 12.3 for further info.

**WIDTH:** Provides the user the ability to change the overall size of the viewable measurement area. It functions a lot like a zoom on a camera. Refer to section 12.3 for further info.

**RECT WAVE:** This option provides the user an outlined or filled view option when the display setting is in RECT (rectified) wave mode only. Refer to page 100 for further info.

**DETECT MARK:** Selectable graphics option for the point of detection on the waveform: Line, Box, Dots, None. Offers the user a graphics preference on how they prefer to view the detection on the waveform. Refer to page 127 for further info.

TUNE SIGNAL	
PULSE	THIN
PULSER VOLTAGE	100
DAMPING	50
GAIN	51.0
GAIN STEP	1.0
DIGITIZER	4X
TUNE GATE AUTO SET	

#### 4.6 TUNE – Menu

**PULSE:** The **BT1-DL** has an adjustable pulse width for both high penetration and resolution applications. The pulse width refers to the duration of time the pulser is on. There are three different types of pulsers built into the **BT1-DL** – Spike, Square Wave, and Tone Burst with adjustable voltage options of 100-400 volts and select settings of Spike, Thin, Wide, HV Spike, HV Thin, HV Wide, TB 10MHz, TB 5MHz, TB 2MHz, and TB 1MHz. Refer to page 137 for a further explanation.

**PULSER VOLTAGE:** Adjustable voltage of 100-400 volts, depending on the pulser option selected. The standard setting is 150 volts. This enables the **BT1-DL** to offer greater penetration for difficult material types, or increased resolution on noisy materials. Refer to page 130 for further explanation.

**DAMPING:** Provides the user with multiple input impedances to match the impedance of the transducer, and optimized overall transducer performance. Refer to page 131 for further info.

**GAIN:** The **BT1-DL** has 100dB gain range from (-30 to 70 dB), used in conjunction with the attenuator feature above. This feature is used to increase/decrease the power or amplitude of the signal. This might easily be considered as similar to turning the volume up or down on a stereo receiver. Refer to page 107 for further info.

**GAIN STEP:** The gain increment step size for each key press. If the step size is set to 3, then each key press will increase/decrease the gain +/-3dB. Refer to page 107 for further info.

**DIGITIZER:** Increases the measurement resolution by 2x or 4x by increasing the number of shots/samples. The higher the sample digitizer rate, the better the resolution, but the slower the update rate/speed and vice versa. Refer to page 130 for a further explanation.

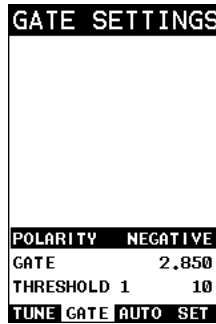

#### 4.7 GATES – Menu

**POLARITY:** The **BT1-DL** operates on a zero crossing detection principal. This feature toggles which stroke of the cycle the crossing detection uses, either positive or negative. Refer to page 133 for further info.

**GATE:** Gates allow the user to view a specific measurement range, or sections of the waveform, and ignore others. The Gate1 feature adjusts the start of the gate, according to time/distance. Gate 1 can be used in all pulse-echo and echo-echo measurement modes. Refer to page 111 for further info.

**THRESHOLD1:** Enables the user to set the sensitivity level of Gate1. The amplitude of the signal must reach or exceed the threshold level before a measurement is detected. Refer to page 111 for further info.



#### 4.8 AUTO – Menu

**AUTO SET:** Automatically locates the detection point if the measurement is out of the viewable display area. Used when measuring reference lengths only. Refer to section 12.9 for further info.

**APPROX LEN:** In order for the user to use the Auto Set feature, an approximate length of the fastener must be entered. The approximate length gives the **BT1-DL** some idea of where to turn on the receiver and look for the detection, or end of the bolt. This sub menu item enables the user to edit the length at anytime. Refer to section 12.9 for further info.

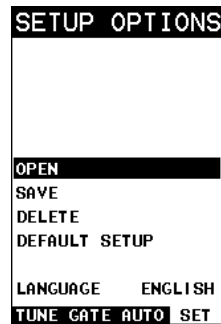

## 4.9 SETUP – Menu

**OPEN:** Displays a list of factory and user defined setups currently stored in memory. These setups can be recalled and used at any time. Refer to page 160 for further info.

**SAVE:** Provides the user with the ability to save a custom setup that has been modified or created by the user. Refer to page 161 for further info.

**DELETE:** Provides the user with the ability to delete specific setups previously save in memory. Refer to page 164 for further info.

**DEFAULT SETUP:** Loads a basic default setup. Use only as a last resort when the setups in the **BT1-DL** have been corrupted and a computer is not accessible. Refer to page 166 for further info.

**LANGUAGE:** Provides the user the ability to select different languages for the **BT1-DL**. Refer to page 167 for further info.

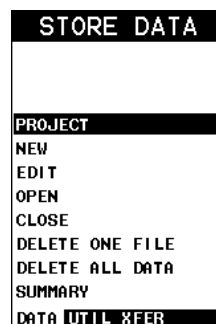

## 4.10 DATA – Menu

**PROJECT:** This function provides the user with the ability to create folders (projects) for a specific customer/Job/Location. Data groups will then be created and stored into a given project folder. Refer to page 143 for further info.

**NEW:** Allows the user the ability to create a new alpha numeric grid, or sequential log file with auto identifiers. It is equipped with custom parameters, rows, and columns depending on the user's application reporting requirements. Refer to page 147 for further info.

**EDIT:** Gives the user the ability to change parameters of grid or sequential file previously saved. *Pre-defined coordinates cannot be changed once they have been created.* Refer to page 155 for further info.

**OPEN:** This function provides the user with the ability to recall grids or sequential log files that currently exist in memory, from a list of grids. Refer to page 157 for further info.

**CLOSE:** Provides the user the ability to close a currently opened grid or sequential log file. Refer to page 159 for further info.

**DELETE ONE FILE:** This function provides the user with the ability to delete one individual grid or sequential log file from a list of multiple grids/files previously saved in memory. Refer to page 152 for further info.

**DELETE ALL DATA:** This function provides the user with the ability to delete all files currently stored in memory. Refer to page 153 for further info.

**SUMMARY:** Provides the user with an overall summary of the current data group open/active. Refer to page 153 for further info.

UTILITIES	
TEMP MODE	MANUAL
ALARM	OFF
ALARM LOW	0.00200
ALARM HIGH	0.00300
KEY CLICK	QUIET
SET DATE	MMDDYY
SHOW DATE	BOTH
DATA UTIL REFER	

#### 4.11 UTIL (utilities) – Menu

**TEMP MODE:** This sub menu item enables the user to select the automatic temperature compensation mode (manual, semi-auto, and auto). This feature is only available to those units purchased with the automatic temperature compensation option and probe. **Note:** *Contact Dakota for information on upgrading the BT1-DL.* Refer to page 67 for further info.

**ALARM:** Toggles alarm mode on, off, or audible. Refer to page 134 for further info.

**ALARM LOW:** Gives the user the ability to set the LO limit parameter. If the measurement falls below this value, a red light will illuminate and sound the internal beeper. Refer to page 134 for further info.

**ALARM HIGH:** Gives the user the ability to set the HI limit parameter. If the measurement exceeds this value, a red light will illuminate and sound the internal beeper. Refer to page 134 for further info.

**KEY CLICK:** Gives the user the ability to set the level of the key press beeper OFF, QUIET, or LOUD. Refer to page 137 for further info.

**SET DATE:** Gives the user the ability to set the internal date and time stamp in the BT1-DL. Refer to page 137 for further info.

**SHOW DATE:** Gives the user the ability display the time, date or both in the main measurement screen. Refer to page 137 for further info.

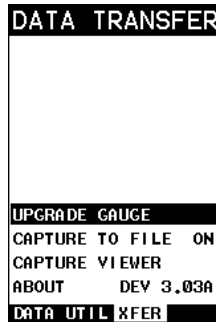

## 4.12 XFER (transfer) – Menu

**UPGRADE GAUGE:** Enables the user the ability to upgrade the **BT1-DL** to the most current firmware revision. Refer to page 139 for further info.

**CAPTURE TO FILE:** Enables the user the ability to enable screen capture to .tiff files. Refer to page 140 for further info.

**CAPTURE VIEWER:** Enables the user to view all the captured (.tiff) files stored in the **BT1-DL** on the gauge display. Refer to page 141 for further info.

**ABOUT:** Provides the user with Dakota NDT contact information and the **BT1-DL** software version. Refer the Dakota NDT web site for information on the latest firmware versions available for download.

## 4.13 CLR (clear) Key



The primary functions of the **CLR** key, are to clear a measurement from a grid or sequential log files cell location or set an obstruct, backspace in an **Alpha Edit Box**. If a user has already saved a measurement and B-Scan to a cell location, use this key to clear the measurement at any time.

## 4.14 HOME (measurement mode) Key



The **HOME** key puts the **BT1-DL** into its primary mode of operation. In this mode, the user has a complete view of the waveform, hot menu items, and measurement.

## 4.15 OK Key





The primary function of the **OK** key is confirmation of a change or selection. The **OK** key also toggles between full or split screen view while in the main measurement screen. If the **BT1-DL** is displaying a data group, the **OK** key toggles an advance to row number option.



#### 4.16 ESC Key



The **ESC** key is used in the , , and **EDIT** functions as a back or escape

key. If the **BT1-DL** is displaying a group file, the  key toggles the display view options: Digits, RF, RECT views.

#### 4.17 Arrow Keys



The **Arrow Keys** are used to navigate through the menus, increase/decrease values, and toggle specific function keys.

#### 4.18 ENTER key



The **ENTER** key is used in the overall menu selection process, to activate list and edit boxes, display and save measurements to a group file location.

#### 4.19 AUTO SET Key



The **AUTO SET** is an automatic measurement routine that attempts to locate the detection and set all the scope parameters of the **BT1-DL**. Additionally, “**capture to file**” allows the user to take a snapshot of the current screen, give it a name, and save it to the SD card. “Capture to file” must be enabled in the XFER menu.

#### 4.20 ON/OFF Key



The **ON/OFF** key simply powers the unit either **ON** or **OFF**. **Note:** *Unit will automatically power off when idle for 5 minutes. All current settings are automatically saved prior to powering off.*





#### 4.21 Navigating the Hot Menu

DELAY: 2.958	WIDTH: 0.302
ALEN: 3.000	GAIN: 51.0
GATE: 2.850	TEMP: 68.0
THRESH: 10	LOG: A003



The diagram above is a screenshot of the “Hot Menu” in the **BT1-DL**. The Hot Menu contain all the most regularly adjusted features. The primary purpose of the design was to provide the user with an efficient way to make adjustments on the fly, while continuing to have visibility of the A-Scan display. The following procedure outlines the steps to navigate and make adjustments as follows:

### Navigating Hot Menus

- 1) Press the  key once to display the measure screen, and multiple times to advance the cursor to the next cell right, or  to advance to the next cell left, until the desired function is highlighted.
- 2) Press the  and  arrow keys to scroll the options/values, or the  key to activate the **Digit Edit** and **List Box** options.

**Note:** *This is a coarse adjustment. It's the fastest and easiest way to increment, decrement, or toggle the status however it does so in coarse steps.*

*Pressing the  key will allow the user to enter a specific target value.*

***This procedure above is universal for navigating through and selecting all the features in the Hot Menus.***

## 4.22 Top & Bottom End Caps

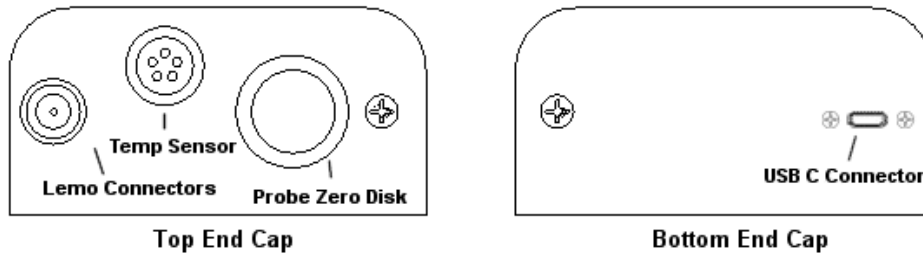

The top & bottom end panels are where all connections are made to the **BT1-DL**. The diagram above shows the layout and description of the connectors:

### Transducer Connector

**Refer to Diagram:** The transducer connector is a board mounted and shielded LEMO “00”.

### Temperature Sensor Connector

**Refer to Diagram:** The temperature sensor connector is a Shielded custom 5 pin Lemo “1”.

### Battery Cover (backup)

**Refer to Diagram:** The battery cover is the large round disk shown in the diagram. Simply remove the cover when replacing the batteries (3AA cells).

**Important:** Be sure to follow the polarity labels located on the back label of the **BT1-DL**. **Note:** *Rechargeable batteries can be used however they must be recharged outside of the unit in a stand-alone battery charger.*

### USB Type B Connector

**Refer to Diagram:** The **USB-C** connector, located on the bottom end cap, is a mini type C female connector. It is designed to connect directly from the **BT1-DL** to a standard USB type A port on a PC. It can be used as line power when connected to a the USB PC port. The battery icon will display the line power is activated. It can also be powered by a standard cell phone adapter into a power outlet. The line power will not provide power to rechargeable batteries. The cable supplied with the **BT1-DL** is a USB type C to a USB type A (pt# N-003-0330).

**Note:** *This connector is also used to upgrade the **BT1-DL** with the latest version of firmware.*

## CHAPTER FIVE

### THEORY OF OPERATION

#### 5.1 Ultrasonic Measurement of Bolts

**Note:** *The terms bolt, fastener, and threaded fastener are used interchangeably.*

Ultrasonic measurement has proven to be the most reliable and cost effective solution when:

- Variations in friction or joint geometry prevent applied torque from controlling the actual clamping force produced by the fastener with the required accuracy.
- The clamping force must be monitored over the service life of the bolt.

Ultrasonic measurement of clamping load is obtained through a predictable decrease in the sound velocity within the body of the bolt as the tensile load is increased. By introducing a sonic pulse at one end of the bolt and accurately measuring the time required for the echo to return from the opposite end, the ultrasonic length is determined. As the fastener is tightened, the change in this ultrasonic length is used to calculate and display the actual clamping force produced.

The physics governing this process are clearly understood, and have been employed for many years in the fields of active sonar, or radar. Send a pulse of energy toward an object (in this case the opposite or reflecting end of the fastener), and then measure the time between the initial pulse and the returning echo.

While the concept is comparatively simple and ultrasonic measurement can produce very accurate results, the selection of the optimum bolt and transducer and their coupling can be difficult. The **BT1-DL** minimizes these difficulties to the greatest extent possible:

- The variable width pulser system can send the maximum amount of energy to the ultrasonic transducer, allowing the broadest possible range of transducers for a given application.
- The low noise and gain features of the receiver system allow signal detection and measurement in the most difficult applications.
- The digital signal processor optimizes the measurement process.

#### 5.2 Features of the **BT1-DL**

The Dakota NDT **BT1-DL**, Ultrasonic Bolt Tension Monitor, defines the State of the Art in the measurement of the actual clamp load produced by tightening a fastener. The **BT1-DL** can measure time, elongation, load, stress, or %strain in bolts of virtually any material from 1 inch to 50 feet in length. By storing the reference waveform and displaying it for comparison while the elongation is being measured, the **BT1-DL** minimizes operator training.

### 5.3 Ultrasonic waves

Ultrasonic measurement requires the transmission of a suitable quantity of ultrasonic energy through the length of the bolt. The relationship of the energy pulse frequency to its penetration is important in energy transmission. Lower frequencies produce longer wavelengths that will travel further through a given substance: while higher frequencies produce shorter wavelengths. To use a familiar example: AM radio signals are broadcast at relatively low frequencies and can be received hundreds of miles away, over the horizon. Higher quality FM radio and television signals are broadcast at much higher frequencies, and can only be received within a comparatively short line-of-sight or distance.

The same phenomenon exists with ultrasound. A low frequency 1 MHz pulse travels much farther through metal than a 5 MHz pulse. Therefore, a lower frequency transducer is able to achieve an echo in a longer bolt, or in a bolt made of metal with higher resistance to sound transmission (attenuation). While the lower frequency has more penetration power, it also produces more unwanted noise. Low frequency energy tends to spread, much like an unfocussed beam of light. When low frequency energy is introduced at the end of a bolt, a significant portion is bounced from side to side within the cylindrical shape, producing a noisy and distorted echo. Higher frequency pulses tend to travel more directly down and back the centerline of a bolt, with less noise and distortion.

### 5.4 Measurement Mode

The **BT1-DL** uses a standard pulse-echo (P-E) mode for measurement. This is accomplished by measuring from the initial pulse (sometimes referred to as an artificial zero) to the first echo (reflection). In this mode errors can result from surface coatings applied to the bolt, as well as temperature variations. However, typical protective surface coatings commonly applied to fasteners will work fine.

## CHAPTER SIX

### BOLT PREPARATION

The best balance between maximum frequency and noise suppression requires selecting the best transducer for bolt measurement. The diameter of the transducer (which is generally specified by the diameter of the actual piezoelectric crystal) directly effects energy transmission: Larger diameter crystals have greater ability to send and receive energy, and less of the energy tends to spread laterally. The **BT1-DL** Bolt Tension Monitor strives to achieve this ideal balance: direct transmission of the strongest possible pulse, with the least amount of noise and distortion, down and back the center of the bolt to obtain the most accurate measurement.

#### 6.1 Use of Ultrasonic Couplant

Sonic energy at the frequency range used by the **BT1-DL** travels well through solid materials and most liquids. It does not travel well through air. This variable resistance to the passage of sonic energy is called *sonic impedance*. It is the sudden change in impedance which occurs when the sound pulse attempts to cross the metal / air boundary at the end of the bolt, which causes most of the energy to be returned as an echo. To make a familiar comparison: light crossing the transparent glass boundary of a mirror and reflecting back an image from the nontransparent silvered back is much like an echo.

Any air gap between the face of the transducer and the end of the bolt will prevent the sonic energy from crossing. The gap must be filled with a suitable coupling fluid. Normally, a liquid ultrasonic couplant is applied between the transducer and the bolt. Since liquid has sonic impedance closer to the transducer and bolt material than air, it forms a continuous path for the outgoing pulse and the returning echo.

Many liquids can serve as an adequate couplant, however liquids with lower sonic attenuation will produce better results. Liquids containing glycerin offer such low impedance, and couplant manufactured for ultrasonic testing, such as the one shipped with the **BT1-DL**, produce the best results.

The single purpose of the couplant is to fill the air gap between the transducer and the bolt end. This is accomplished more easily with a liquid that is viscous enough to stay in place. Very viscous substances can create such a thick layer between the transducer and bolt that measurement errors can occur. Also, viscous substances can trap air bubbles, which prevent adequate energy transmission. Again, the ultrasonic couplant provided with the **BT1-DL** works best. Apply only the smallest quantity of couplant, required to fill the air gap, and carefully seat the transducer so that any trapped air or excess couplant is squeezed out of the interface.

#### 6.2 Transducer Contact Requirements

The goal is to transmit as much sonic energy as possible from the transducer into the bolt, and to send that energy, to the greatest extent possible, down and back the center of the bolt, as shown in Figure 1.

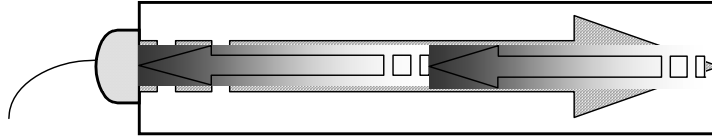
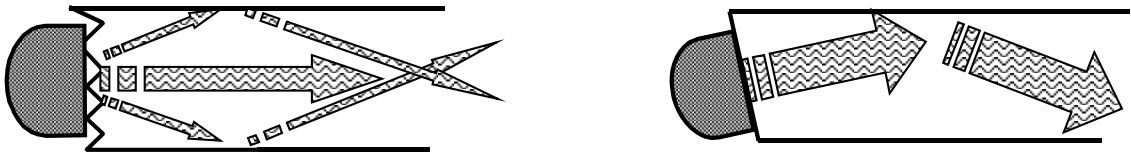

*Figure 1 Sound path in a good bolt*

Smooth, even surfaced bolt ends that seat the entire active surface of the transducer with minimum gap are required for accurate signal transmission. Bolt ends may need to be cleaned, ground, etc. to achieve the required surface.

Avoid:

- Rough or irregular surface's which prevent adequate contact with the transducer. Irregular or rough surfaces can be filled with couplant, but energy transmission will still be reduced and dispersed causing mode conversions to occur from reflections off the side walls of the bolt, as shown at left of Figure 2.
- Bolt ends not perpendicular to the axis of the bolt, as shown at right of Figure 2. Energy will be transmitted toward the side wall and reflect along the bolt, yielding poor signal quality and possible measurement errors. Avoid alignment errors exceeding 2 degrees.



*Figure 2 Rough and angled transducer contact*

- Rusted, dirty, or thick paint-covered bolt ends. These coatings prevent sonic energy from traveling between the transducer and the bolt. Very thin coating or plating is acceptable.
- Bolt ends with recessed grademarks, as shown at left of Figure 3. Couplant can be used to fill recessed grademarks. Small indentations cause some loss of signal strength, but normal measurement is still possible. Large or numerous indentations cause the signal to be too weak for a reliable measurement.
- Bolt ends with raised grade marks, or indentations with a raised edge, which cause the transducer to be seated at an angle to the axis of the bolt, thus preventing adequate contact, as shown at right of Figure 3.



Figure 3 Effect of lowered and raised grade marks

### 6.3 Bolt End Reflectors

Smooth, flat reflecting bolt ends that are perpendicular to the axis of the bolt are required for accurate echo reception. Bolt ends may need to be cleaned, ground, etc. to achieve the required surface.

**Note:** Misalignment exceeding 2 degrees can cause significant errors.

Avoid:

- Rough reflecting bolt ends. As shown in Figure 4, if the reflecting end of the bolt is rough or curved, most of the reflected energy will be dispersed and a weak or distorted echo will be received.
- Reflecting bolt ends not perpendicular to the axis of the bolt. Sonic energy will be reflected toward the sidewall of the bolt, as shown in Figure 5.
- Nonperpendicular reflecting bolt ends due to bending of the bolt as shown in Figure 6.

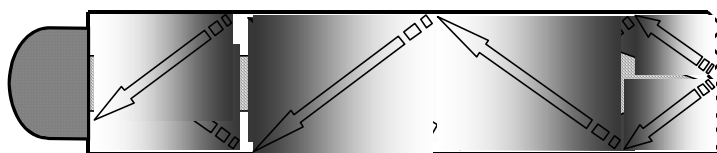

Figure 4 Rough reflective surface

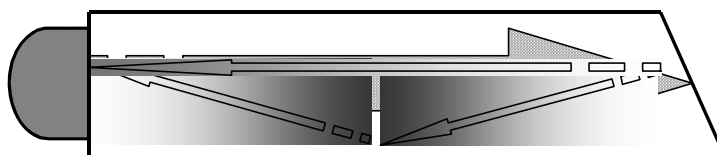
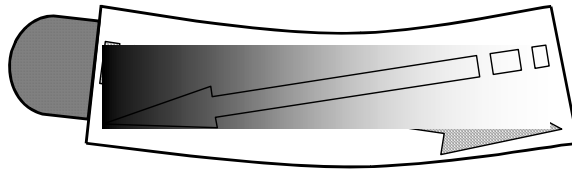

Figure 5 Non Parallel reflecting Surface





*Figure 6 Reflection in a bending bolt*

## CHAPTER SEVEN

### TRANSDUCER SELECTION

#### 7.1 Selecting the Transducer

Transducer selection is a very important part of getting the best results from the **BT1-DL**. The frequency and diameter of transducer should be carefully selected using the following information:

- Select the largest diameter transducer that will seat completely on the end of the bolt. If there are multiple applications and diameters to consider, select a diameter that will work for as many applications as possible, thus reducing the overall number of transducers needed.
- When selecting the proper frequency, the following items should be taken into consideration:

Higher frequencies are typically a better choice when measuring smaller diameter bolts as the sound is better focused resulting in less beam spread and more directivity.

Lower frequencies are more forgiving of potential bending and attenuative materials. This is primarily due to the longer wavelength avoiding smearing or distortion of the waveform. Longer wavelengths require more of a phase shift before distortion will occur. Lower frequencies offer an increased amount of dispersion and a reduced amount of directivity. As this may seem to go against what may typically be considered a good choice, in the case of bending it's actually the best choice overall.

## CHAPTER EIGHT MEASURING SYSTEM ZERO (CALIBRATION)

### 8.1 Introduction

In this chapter will be focused on establishing a system zero to enable the group data to be portable between different hardware devices with limited measuring error. Data created using one **BT1-DL**, can send the data file to another operator for use in another **BT1-DL**, transducer (diameter or frequency), or cable (length or type). The **BT1-DL** offers a few selectable calibration options for flexibility based on preference, or the type of calibration standard used. Every **BT1-DL**, transducer, and cable will have a slightly different system delay because of differences in electronic components and materials. However small, even identical transducers by diameter and frequency may result in different delay times. When porting existing data to another hardware set, it's always optimal to use the same transducer diameter, frequency, and cable length to minimize potential measurement error. These items should be documented for reference in the data group.

The sections that follow will outline the procedures for all the System Zero options: Fixed, Auto, One Point, and Two Point. A system zero is only required if the bolts will be monitored/measured over the service life of the bolt...measured more than one time (later date/time). An example might be measuring bolts in a refinery that requires a shutdown and re-measurement once a year and every year thereafter for the service life of the bolts. An example when a zero is not necessary is when measuring auto engine bolts on an assembly line. In the first example one of the calibration options (auto, one point, two point) would be used, while in the second example the calibration option should be set to 'fixed'.

*A system zero should be done or checked any time the hardware configuration changes in any way. If the **BT1-DL** monitor, transducer, or cable has changed, the zero should be checked against the current zero calibration group in the project folder CAL\_ZERO\_DATA. If the elongation is not reasonably close to "0", then the zero process should be repeated. Regardless, the operator should always take the time to verify the system zero prior to starting a job, even when using the same hardware configuration for existing data.*

### 8.2 Calibration / Zero Misnomer

In the past there have been instances where users were under the impression that zeroing the unit was the same as calibrating the unit. If the ultrasonic unit could successfully measure the calibration bars or glass block, the unit could be considered calibrated. However, this is not the case. The linearity of the unit and material type of the bolts are not calibrated following a system zero procedure.

The **BT1-DL** should be sent in for calibration by Dakota NDT, or other authorized service representative, on a periodic basis to verify proper operation of the

instrument. Check in with your quality department to verify their duration requirement for “Test & Measurement Equipment”.

### 8.3 Creating a Group to Document Zero (Calibration) data

A project folder named “CAL\_ZERO\_DATA” will automatically be created following the completion of a “One Point”, “Two Point”, or “Auto” calibration option...if one doesn’t already exist. A group/log will automatically be created inside of the ‘project folder’ with a ‘date/time’ stamp, each and every time the zero process has been successfully completed. By default, the group/log will consist of 5 bolts and 10 measurements per bolt, allowing for additional calibration points, verification, and recordation. The group log will contain the zero measurements, as well as the diameter and calculated frequency of the transducer used.

The group/log files created will remain on the SD memory card until manually deleted, and provide the user with additional documentation regarding when the zero process was performed, as well as the outcome of the zero calibration process.

**File Name (format):** CALZERO211202\_132519  
 Date(yr/month/day)\_Time(hr/min/sec)

**Note:** This section applies to all the Zero/Calibration options (one point, two point, auto).

**Note:** Refer to Chapter Fourteen for instructions on how to Create, Open, Edit (group name, note), Delete (a group/log), or Close (group) in a project folder.

**Overview**

STORE DATA		OPEN LOG		MEM 3.0031 IN																									
PROJECT CAL_ZERO_DATA		1. CALZERO220322_125126		ELONG 100V 0:---																									
NEW		2. CALZERO220322_125042		<table border="1" style="width: 100%; border-collapse: collapse;"> <tr> <td>3.00</td> <td>3.06</td> <td>3.12</td> <td>3.18</td> </tr> <tr> <td colspan="4">NAME: CALZERO220322_125429</td> </tr> <tr> <td>A</td> <td>B</td> <td colspan="2">C</td> </tr> <tr> <td>1 ZERO CR</td> <td>1/2IN P</td> <td colspan="2">3.76MHZ</td> </tr> <tr> <td>2</td> <td>3.0031</td> <td></td> <td></td> </tr> <tr> <td>3</td> <td>6.0062</td> <td></td> <td></td> </tr> </table>		3.00	3.06	3.12	3.18	NAME: CALZERO220322_125429				A	B	C		1 ZERO CR	1/2IN P	3.76MHZ		2	3.0031			3	6.0062		
3.00	3.06	3.12	3.18																										
NAME: CALZERO220322_125429																													
A	B	C																											
1 ZERO CR	1/2IN P	3.76MHZ																											
2	3.0031																												
3	6.0062																												
EDIT LIVE		3. CALZERO220322_125208																											
OPEN		4. CALZERO220322_125249																											
CLOSE		5. CALZERO220322_125315																											
DELETE ONE FILE		6. CALZERO220322_125429																											
DELETE ALL DATA																													
SUMMARY																													
DATA UTIL XFER																													

### 8.4 Auto - Zero/Calibration

The auto calibration feature uses a single steel calibration bar and two measurements, the second at twice the length (i.e. 3” bar at 3” & 6”). ***This zero option will typically be most preferred, as it’s fully automated and simple to use.*** However, depending on signal quality and the material type of calibration standard, it may not always work (not recommended for use with our triple path glass block). If valid signals cannot be acquired during the ‘auto set’ routine, the **BT1-DL** will report “can’t find stable echo”. Before eliminating this option altogether and using one of the manual options listed below, try relocating the transducer to various positions on the end of the calibration standard first. Since the calibration standards are cylindrical, they can sometimes create substantial sidewall noise based on length, transducer size, and frequency. Moving the transducer to the edge of the cylinder will often times eliminate the noise by shooting down the edge of the standard and allowing the **BT1-DL** to acquire a stable echo.





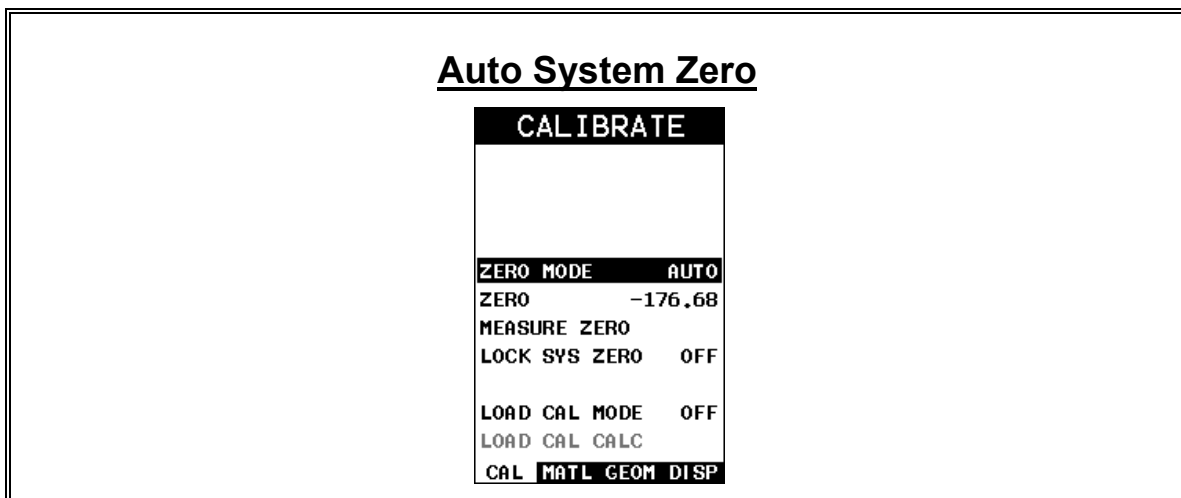

We’re ready to get started with the automatic zero/calibration process. The first thing to note is the procedures in this section demonstrate an automatic ‘two-point’ calibration using a 3” Cal Bar that’s fast and efficient, requiring minimal adjustments from the operator.

**Note:** *The temperature sensor should be connected to the gauge with the Temp Mode set to ‘auto’, located in the utility menu, then placed on the serial # flat of the Cal Bar. This will compensate for temperature shifts and avoid measurement errors.*

**Caution:**



*A very small amount of “WATER”, or other non-intrusive fluid with a similar viscosity, should be used as the couplant between the transducer and calibration standard selected. This will avoid creating a couplant film layer between them and cause an “out of tolerance” condition > +/- 0.001” for the 3” cal bar.*





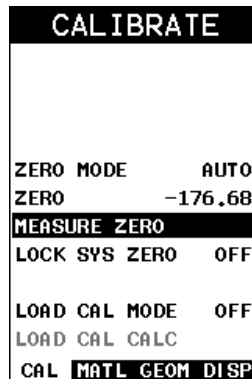

- 1) Press the  key multiple times to tab right and the  key multiple times to tab left until the **CAL** menu is highlighted and displaying the submenu items.
- 2) Press the  and  arrow keys multiple times to scroll through the submenu items until **ZERO MODE** is highlighted.
- 3) Press the  and  arrow keys multiple times to scroll the zero mode options until the **AUTO** option is displayed.

**Note:** *The auto option will perform a two-point calibration using a single 3" cal bar (pt# X-000-0011) and measurements of 1x & 2x lengths.*



- 4) Press the  and  arrow keys multiple times to scroll through the submenu items until **MEASURE ZERO** is highlighted.
- 5) Press the  key to display the **Digits Edit Box** and adjust the physical length of the cal bar.





- 6) Press the     arrow keys multiple times to scroll the highlighted value until the desired **PHY LENGTH** is correctly displayed.

**Note:** *PHY LENGTH* is the actual physical length of the calibration standard noted on the calibration certificate.

- 7) Press the  key to save the **PHY LENGTH** and display the **PROBE DIAMETER** list box.

PROBE DIAMETER	
1.	1/8IN
2.	1/4IN
3.	3/8IN
4.	1/2IN
5.	3/4IN
6.	1 IN

- 8) Press the  and  arrow keys multiple times to scroll the probe diameter options.
- 9) Press the  key to select the probe diameter and start the automated zero process.

**Note:** *The BT1-DL will automatically begin the wave analysis for each measurement, display a summary page of the fit, calculated velocity, zero values, and return to the main measurement screen when completed.*

**Caution:** *Do not disrupt the zero process until completed*

**Note:** *Refer to chapter 14.1 for instructions on how to Create (group), Open, Edit (file name, note), Delete (a group/log), Close (group) in a project folder.*

## 8.5 One & Two Point Zero Calibration

This section will outline the procedure to perform a one or two point system zero calibration. The process using either method are virtually identical, with the exception of entering the additional physical length of the second bar, averaging the two velocities noted on the calibration certificates, and entering the average velocity into the **BT1-DL**. To reiterate, a data group will automatically be created following the completion of either of these two zero calibration methods. For additional information on the group data file refer to section 8.3.

### Calibration Standards:

1. 3" Steel (type 4140 pt# X-000-0011) – Used for one or two point zero calibration options, using the first, and or the second (i.e. 3" & 6") multiple echo.
2. 3" & 6" Steel (type 4140 pt# X-000-0010) – Used for one or two point zero calibration options in a number of configurations (individual or paired).
3. Triple Path Glass Block (1", 2", 3" pt# X-000-0020) – Most commonly used for all three points. Two point using 1" & 3", followed by a linear verification point measured and recorded at 2" after completion of the Two Point procedure.

**Note:** *The temperature sensor should be connected to the gauge with the Temp Mode set to 'auto', located in the utility menu, then placed on the serial # flat of the Cal Bar. This will compensate for temperature shifts and avoid measurement errors. If the triple path glass block will be used as the cal standard, the temp sensor is not necessary with the temperature coefficient of glass close to 0.*

### **Caution:**

*A very small amount of "WATER", or other non-intrusive fluid with a similar viscosity, should be used as the couplant between the transducer and calibration standard selected. This will avoid creating a couplant film layer between them and cause an "out of tolerance" condition > +/- 0.001" for the 3" & 6" cal bars, or +/- 0.0005" for the triple path glass block.*

### **Triple Path Glass Block -**

If the operator will be using the glass block for the zero calibration process, there are only a few changes necessary:

- Physical lengths (PHY LEN) will be performed at 1" & 3".
- Temperature coefficient (TEMP COEF) will be set to "0".
- Recordation of the 2" side in the data group file.







*The physical measurements documented on the glass block calibration certificates were dimensionally measured in the center on all three sides (1", 2", & 3"). The transducer should be placed in the same location during the calibration process.*





The zero calibration procedure is as follows:

### One & Two Point System Zero



CALIBRATE		CALIBRATE	
ZERO MODE ONE POINT		ZERO MODE TWO POINT	
ZERO	-183.37	ZERO	-183.37
MEASURE ZERO		MEASURE ZERO	
LOCK SYS ZERO	OFF	LOCK SYS ZERO	OFF
LOAD CAL MODE	OFF	LOAD CAL MODE	OFF
LOAD CAL CALC		LOAD CAL CALC	
CAL MATL GEOM DISP		CAL MATL GEOM DISP	

- 1) Press the  key multiple times to tab right and the  key multiple times to tab left until the **CAL** menu is highlighted and displaying the submenu items.
- 2) Press the  and  arrow keys multiple times to scroll through the submenu items until **ZERO MODE** is highlighted.
- 3) Press the  and  arrow keys multiple times to scroll the zero mode options until either the **ONE POINT** or **TWO POINT** option is displayed. Each time the arrow keys are pressed, the confirmation screen will appear letting the user know that the **ZERO MODE** is being changed. Pressing the  key each time will allow the mode to be changed.





CALIBRATE		CALIBRATE	
ZERO MODE ONE POINT		ZERO MODE TWO POINT	
ZERO	-183.37	ZERO	-183.37
MEASURE ZERO		MEASURE ZERO	
LOCK SYS ZERO	OFF	LOCK SYS ZERO	OFF
LOAD CAL MODE	OFF	LOAD CAL MODE	OFF
LOAD CAL CALC		LOAD CAL CALC	
CAL MATL GEOM DISP		CAL MATL GEOM DISP	

- 4) Press the  and  arrow keys multiple times to scroll through the sub menu items until **MEASURE ZERO** is highlighted.

ONE POINT		TWO POINT	
PHY LEN 1	3.0031	PHY LEN 1	3.0031
ULTRASONIC 1	3.0031	ULTRASONIC 1	3.0031
VELOCITY	0.23272	PHY LEN 2	6.0062
TEMP COEF	55.0	ULTRASONIC 2	6.0062
POLARITY	AUTO	VELOCITY	0.23272
CALC ZERO	-183.37	TEMP COEF	55.0
		POLARITY	AUTO
		CALC ZERO	-183.37

- 5) Press the  key to display the **Zero Calibration** menu items.
- 6) Press the  and  arrow keys multiple times to scroll through the sub menu items until **PHY LEN 1** is highlighted.

PHY LEN 1	PHY LEN 2
<b>3.0031</b>	<b>6.0062</b>
OK      ESC	OK      ESC



- 7) Press the  key to display the **Digits Edit Box** and adjust the physical length of the cal bar.
- 8) Press the     arrow keys multiple times to scroll the highlighted value until the desired **PHY LEN1** is correctly displayed.

**Note:** *PHY LEN 1 is the actual physical length of the calibration standard noted on the calibration certificate.*

- 9) Press the  key to save **PHY LEN 1** and display the **Zero Calibration** menu items.

10) Repeat steps 6 – 9, if using the **TWO POINT** zero calibration method, to enter and save **PHY LEN 2**.

ONE POINT		TWO POINT	
PHY LEN 1	3.0031	PHY LEN 1	3.0031
ULTRASONIC 1	3.0031	ULTRASONIC 1	3.0031
<b>VELOCITY</b>	<b>0.23272</b>	<b>VELOCITY</b>	<b>0.23272</b>
TEMP COEF	55.0	TEMP COEF	55.0
POLARITY	AUTO	POLARITY	AUTO
CALC ZERO	-183.37	CALC ZERO	-183.37

11) Press the  and  arrow keys multiple times to scroll through the sub menu items until **VELOCITY** is highlighted.





12) Press the  key to display the **Digits Edit Box** and adjust the **VELOCITY** of the cal bar.

**Note:** *If using the TWO POINT method, the average velocity of the cal bars should be entered  $(\text{Cal Bar Vel1} + \text{Cal Bar Vel2}) / 2$ .*

13) Press the  key to save **VELOCITY** and display the **Zero Calibration** menu items.

ONE POINT		TWO POINT	
PHY LEN 1	3.0031	PHY LEN 1	3.0031
ULTRASONIC 1	3.0031	ULTRASONIC 1	3.0031
VELOCITY	0.23272	PHY LEN 2	6.0062
<b>TEMP COEF</b>	<b>55.0</b>	ULTRASONIC 2	6.0062
POLARITY	AUTO	VELOCITY	0.23272
CALC ZERO	-183.37	<b>TEMP COEF</b>	<b>55.0</b>
		POLARITY	AUTO
		CALC ZERO	-183.37

- 14) Press the  and  arrow keys multiple times to scroll through the sub menu items until **TEMP COEF** is highlighted.





- 15) Press the  key to display the **Digits Edit Box** and adjust the **TEMP COEF**.



**Note:** *The Temperature Coefficient (Temp Coef) should be set to '55' when using the 3" (pt# X-000-0011) or 3" & 6" (pt# X-000-0010) steel cal bars, and '0' when using the triple path glass block (pt# X-000-0008).*

- 16) Press the     arrow keys multiple times to scroll the highlighted value until the desired **TEMP COEF** is correctly displayed.

- 17) Press the  key to save the **TEMP COEF** and display the **Zero Calibration** menu items.

ONE POINT		TWO POINT	
PHY LEN 1	3.0031	PHY LEN 1	3.0031
ULTRASONIC 1	3.0031	ULTRASONIC 1	3.0031
VELOCITY	0.23272	PHY LEN 2	6.0062
TEMP COEF	55.0	ULTRASONIC 2	6.0062
<b>POLARITY</b>	<b>AUTO</b>	VELOCITY	0.23272
CALC ZERO	-183.37	TEMP COEF	55.0
		<b>POLARITY</b>	<b>AUTO</b>
		CALC ZERO	-183.37



18) Press the  and  arrow keys multiple times to scroll through the sub menu items until **POLARITY** is highlighted.

19) Press the  and  arrow keys multiple times to scroll the **POLARITY** options (auto, positive, negative) until the desired option is displayed.

**Note:** *AUTO* is the default option and will analyze both sides of the waveform (positive/negative) and attempt to determine the optimal polarity. Experienced operators can opt to override this option by directly setting the polarity to either **POSITIVE** or **NEGATIVE** as is needed.

ONE POINT	TWO POINT	TWO POINT
PHY LEN 1 3.0031	PHY LEN 1 3.0031	PHY LEN 1 3.0031
<b>ULTRASONIC 1 3.0031</b>	<b>ULTRASONIC 1 3.0031</b>	ULTRASONIC 1 3.0031
VELOCITY 0.23272	PHY LEN 2 6.0062	PHY LEN 2 6.0062
TEMP COEF 55.0	ULTRASONIC 2 6.0062	<b>ULTRASONIC 2 6.0062</b>
POLARITY AUTO	VELOCITY 0.23272	VELOCITY 0.23272
CALC ZERO -183.37	TEMP COEF 55.0	TEMP COEF 55.0
	POLARITY AUTO	POLARITY AUTO
	CALC ZERO -183.37	CALC ZERO -183.37

20) Clean both the cal bar and transducer surface and apply a small drop of couplant to the surface of the cal bar. Attached the transducer and rotate it clockwise and counter clockwise to force out the excess couplant. Center the transducer. Be methodical with this process to eliminate any potential errors.

21) Press the  and  arrow keys multiple times using the left button wheel to scroll through the sub menu items until **ULTRASONIC 1** is highlighted.

22) Press the  key to start the automated zero calibration routine.



**Note:** A waveform will be displayed with “CALC ZERO”, noted in the top right corner of the display. Once the routine is completed and a stable echo is displayed, review the waveform quality and polarity selected.

23) Press the  key to store the result - **ACCEPT CAL.**

24) Repeat steps 20 – 23 if using the **TWO POINT** zero calibration option, to complete the routine for the additional zero cal bar **ULTRASONIC 2.**



**Note:** The operator can run the ultrasonic routine as many times as is needed, or until comfortable with the results. When satisfied with the results, it's time to calculate the zero.

ONE POINT	TWO POINT
PHY LEN 1 3.0031	PHY LEN 1 3.0031
ULTRASONIC 1 3.0031	ULTRASONIC 1 3.0031
VELOCITY 0.23272	ULTRASONIC 2 6.0062
TEMP COEF 55.0	VELOCITY 0.23272
POLARITY AUTO	TEMP COEF 55.0
CALC ZERO -183.37	POLARITY AUTO
	CALC ZERO -183.37

25) Press the  and  arrow keys multiple times to scroll through the sub menu items until **CALC ZERO** is highlighted.

PROBE DIAMETER	
1.	1/8IN
2.	1/4IN
3.	3/8IN
4.	1/2IN
5.	3/4IN
6.	1 IN

26) Press the  key to calculate the zero and display the **PROBE DIAMETER** list box. The diameter should be noted on the transducer housing.

27) Press the  and  arrow keys multiple times to scroll the probe diameter options.

28) Press the  key to select the probe diameter.

**Note:** This will be automatically documented in the **CAL\_ZERO\_DATA** project data file.

**Important:** Only if the glass block and two point calibration options were used as the as the calibration standard and method, with the intension of recording all three sides of the glass block, make a note of the velocity value calculated prior to exiting the calibration menu. The material velocity in the **MATL** menu will be edited to match the calculated calibration velocity later in section 8.6, and in order to obtain/record an accurate measurement for the 2" side of the glass block.

29) Press the  key to exit the **CAL** menu and return to the main measurement screen.

**Note:** *The system zero calibration routine just performed is entirely independent of the bolt measurement section. Therefore, be sure the **MAX II** is setup for the actual bolts intended prior to measurement.*

## 8.6 Verification of System Zero Calibration



The system zero can be verified either immediately following completion of one of the zero calibration methods described in the previous sections, prior to starting a new/existing job, or because the hardware has been changed in some way (gauge, transducer, or cable).

**Note:** *If the glass block was used in conjunction with the two point calibration method, with the intension of using all three points (1", 2", 3"), recordation of the 2" side of the block can also be stored/documentated using this procedure to access the CALZERO group data file. However, in order to achieve an accurate result, the velocity calculated at the end of the zero calibration procedure must be entered as the velocity in the **MATL** menu. The zero calibration section is independent of the 'live' measurement section. Additionally, the approximate length must be changed to capture the 2" side of the glass block.*



The procedure below will guide the operator through changing the velocity & approximate length prior to opening the CALZERO group data file:

### Changing Material Velocity & Approximate Length







MATERIAL	
UNITS	IN
TYPE	CUSTOM
VELOCITY	0.23557
STRESS FACTOR	0.274
TEMP COEF	55.0
CAL	MATL GEOM DISP

- 1) Press the  key multiple times to tab right and the  key multiple times to tab left until the **MATL** menu is highlighted and displaying the submenu items.







- 2) Press the  and  arrow keys multiple times to scroll through the sub menu items until **VELOCITY** is highlighted.

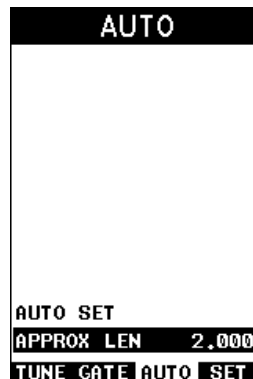





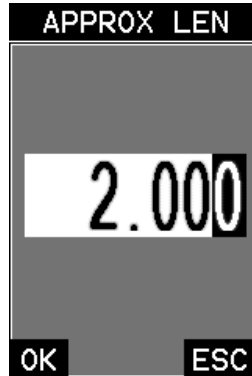

- 3) Press the  key to display the **Digits Edit Box** and adjust the **VELOCITY** to the Zero Calibration velocity calculated.
- 4) Press the     arrow keys multiple times to scroll the highlighted value until the desired **VELOCITY** is correctly displayed.
- 5) Press the  key to save the **VELOCITY** and display the material menu items.



- 6) Press the  key multiple times to tab right and the  key multiple times to tab left until the **AUTO** menu is highlighted and displaying the sub menu items.
- 7) Press the  and  arrow keys multiple times to scroll through the sub menu items until **APPROX LEN** is highlighted.



- 8) Press the  key to display the **Digits Edit Box** and adjust the **APPROX LEN** for 2" to find the correct length.
- 9) Press the     arrow keys multiple times to scroll the highlighted value until the desired **APPROX LEN** is correctly displayed.
- 10) Press the  key to save the **APPROX LEN** and display the **AUTO** menu items.

**Note:** Proceed to the verification section as a guide to access and open the **CAL\_ZERO\_DATA** project, **CALZERO** data group, and record the 2" side of the glass block. Follow steps 1 – 9, The procedure for recording the 2" point will be at the 'end' of the verification section. However, start from the beginning to open the group data file.





**Caution:**

A very small amount of "**WATER**", or other non-intrusive fluid with a similar viscosity, should be used as the couplant between the transducer and calibration standard selected. This will avoid creating a couplant film layer between them and cause an "out of tolerance" condition  $> \pm 0.001"$  for the 3" & 6" cal bars, or  $\pm 0.0005"$  for the triple path glass block.

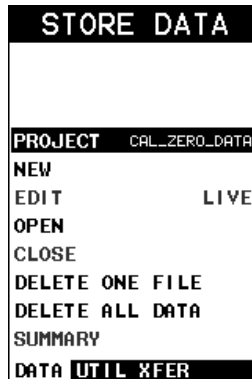

The procedure is as follows:

**Verify System Zero Calibration**



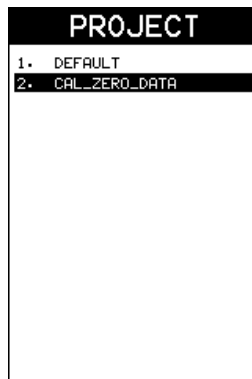

- 1) Press the  key multiple times to tab right and the  key multiple times to tab left until the **DATA** menu is highlighted and displaying the sub menu items.
- 2) Press the  and  arrow keys multiple times to scroll through the sub menu items until **PROJECT** is highlighted.



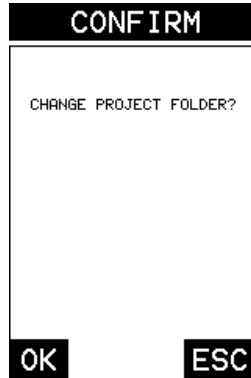

- 3) Press the  key to display the **PROJECT** list items.
- 4) Press the  and  arrow keys multiple times to scroll through the sub menu items until **CAL\_ZERO\_DATA** is highlighted.

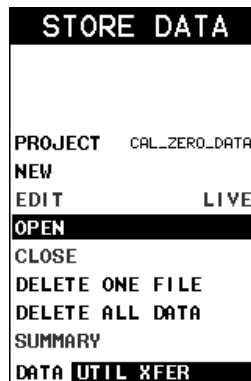

- 5) Press the  key to display the Confirmation screen, followed by pressing the  key to change the project folder.



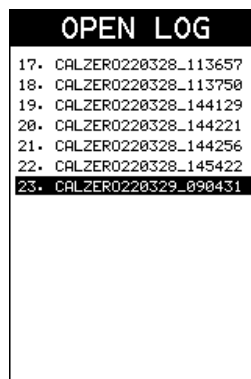

- 6) Press the  and  arrow keys multiple times to scroll through the menu items until **OPEN** is highlighted.







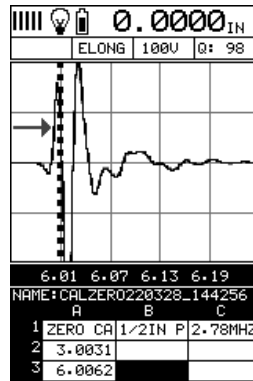

- 7) Press the  key to display the Cal Zero group data files in the project.

**Note:** *The last group log in the list will contain the most recent zero calibration data.*

**CALZERO220329\_090431 Date(yr/month/day)\_Time(hr/min/sec)**

- 8) Press the  and  arrow keys multiple times to scroll through the log files until the appropriate log file is highlighted.



- 9) Press the  key to display the highlighted **CALZERO** group log file.
- 10) Press the     arrow keys multiple times using the left button wheel to scroll the cursor to an empty elongation column B–K on row #2 to verify the 3" Cal Bar.

**Note:** Clean the surface of the Cal Bar & Transducer thoroughly, apply a small drop of WATER, or other non-intrusive fluid with a similar viscosity on the Cal Bar, and attach the transducer to the Cal Bar. Rotate and maneuver the transducer searching for the absolute minimum elongation possible. If the minimum elongation achieved is greater than 0.001", repeat the zero calibration procedure to establish a new system zero.

- 11) Press the  key to store the minimum elongation value, as reference/record that the calibration was verified.
- 12) Repeat steps 10 & 11 for the 6" Cal Bar, to verify and document the elongation value.

**Glass Block – Storing 2" Side**

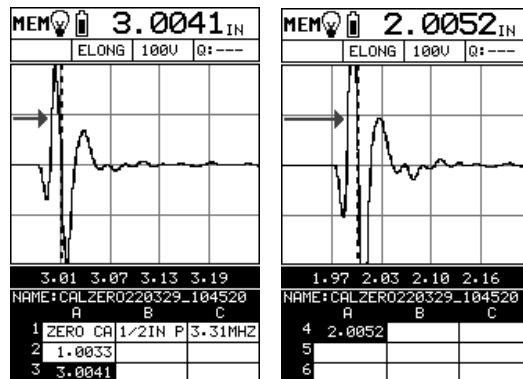

- 1) Press the arrow keys multiple times using the left button wheel to scroll the cursor to an empty L-REF cell in column A, row #4 – 6.

**Note:** Clean the surface of the 2” side of the Glass Block thoroughly. Apply a small drop of WATER, or other non-intrusive fluid with a similar viscosity, in the center of the 2” side and attach the transducer to the Glass Block.

- 2) Press the key to find the 2” echo and optimize the **BT1-DL** setup.

**Note:** Review the waveform and length displayed for a tolerance 0.0005”. Rotate, maneuver, and vary pressure on the transducer, while searching for a length that’s inside of allowable tolerance.

- 3) Press the key to store/record the 2” side of the glass block.
- 4) Press the key to display the **DATA** sub menu items.
- 5) Press the and arrow keys to scroll through the sub menu items until **CLOSE** is highlighted.
- 6) Press the key to close the **CALZERO** group, followed by pressing the **MEAS** key to return the main measurement screen.

## 8.7 Using a 'Set Aside' Bolt





An operator might also consider using a bolt, from the actual lot of bolts on a project, as a zero calibration standard. Using any fastener that provides a good ultrasonic echo with both ends ground and polished can make a simple and effective zero calibration standard. The primary objective is to establish a zero, verify a zero value prior to measuring, and avoid measurement errors if the **BT1-DL**, transducer, or cable has been replaced. While this sounds like an economic way to go, the operator must keep in mind the lack of a calibration certificate, and the need to maintain possession of the bolt, either at the jobsite or in a storage facility for future measurements.

The following procedure will briefly summarize the process of using a 'set aside' bolt from the lot of bolts as a zero calibration standard:





**Note:** Refer to chapter 14.1 for instructions on how to Create, Open, Edit (group name, note), Delete (a group/log), or Close (group) in a project folder.

### Selecting the Bolt Material Type

MATERIAL	
UNITS	IN
TYPE	4140 STEEL
VELOCITY	0.23200
STRESS FACTOR	0.274
TEMP COEF	56.0
CAL	MATL GEOM DISP

- 1) Press the  key multiple times to tab right and the  key multiple times to tab left until the **MATL** menu is highlighted and displaying the sub menu items.
- 2) Press the  and  arrow keys multiple times to scroll through the sub menu items until **TYPE** is highlighted.
- 3) Press the  key to display the list of material types.

MATL TYPE		
1.	4140 STEEL	0.2320
2.	4340 STEEL	0.2320
3.	STS STEEL	0.2300
4.	INCONEL	0.2250
5.	TITANIUM	0.2450
6.	A193 B7	0.2320
7.	A193 B16	0.2320
8.	A325	0.2320
9.	A490	0.2320
10.	A540	0.2320
11.	GR.2	0.2320
12.	GR.5	0.2320
13.	GR.6	0.2320
14.	GR.8	0.2320
15.	GR.9	0.2320
16.	GR.9.8	0.2320

- 4) Press the  and  arrow keys multiple times using the left button wheel to scroll through the material list until the appropriate material is highlighted.
- 5) Press the  key to display the confirmation screen.
- 6) Press the  key to select the material and return to the menu screen, or **ESC** to cancel the material selection.

**Note:** *Make note of the VELOCITY & TEMP COEF values of the material selected. These values will be entered in the ONE POINT calibration section.*

- 7) Proceed to section 8.5 and perform a ONE POINT zero calibration, or section 8.6 to verify the system zero.



## CHAPTER NINE TEMPERATURE COMPENSATION

### 9.1 Purpose

The temperature of a fastener affects the overall physical length, as well as the velocity of a fastener. As the temperature of a fastener increases, the ultrasonic length increases at a rate greater than the physical change in length. If the user intends to measure the same fastener at different time intervals over the service life of the bolt, temperature compensation is very important to produce accurate results. However, if a fastener will only be measured once, never to be measured again, temperature compensation is not needed, as long as the reference length and elongation are measured at the same temperature and time.



The thermal expansion of the fastener and the ultrasonic change in velocity as a result of temperature are two separate effects. However, for the purpose of the **BT1-DL**, they are combined in a single factor known as the Temperature Coefficient (Tc). The sections that follow outline the procedures for selecting and using the temperature compensation mode with the accessory temperature sensor.









### 9.2 Manual Mode

The manual mode option relies on the user to enter in the current temperature before measuring. This is useful to those users that do not require temperature compensation, or have an external temperature device measuring the temperature.









#### Selecting Manual Temperature Mode

UTILITIES	
TEMP MODE	MANUAL
ALARM	OFF
ALARM LOW	0.00200
ALARM HIGH	0.00300
KEY CLICK	QUIET
SET DATE	MMDDYY
SHOW DATE	BOTH
DATA	UTIL & FER

- 1) Press the  key once to activate the menu items tab. Press the  key multiple times to tab right, and the  key multiple times to tab left, until the **UTIL** menu is highlighted and displaying the submenu items.

- 2) Press the  and  arrow keys multiple times to scroll through the sub menu items until **TEMP MODE** is highlighted.
- 3) Press the  and  arrow keys multiple times to scroll the temperature mode options. Once the **MANUAL** temperature mode is displayed, press the  key to return to the measurement screen.
- 4) Press the  key once to activate measure menu items. Press the  key multiple times to move right, and the  key multiple times to move left until the **TEMP** cell is highlighted.

DELAY: 2.934	WIDTH: 0.302
ALEN: 2.961	GAIN: 48.2
GATE: 2.787	TEMP: 68.0
THRESH: 11	ACCEPT: CAL

- 5) Press the  and  arrow keys multiple times to scroll the highlighted value.
- 6) **Alternatively**, press the  key to display the **Digits Edit Box**.
- 7) Press the  and  arrow keys multiple times to scroll the highlighted value.
- 8) Press the  and  arrow keys multiple times to scroll the digit locations.
- 9) Repeat steps **7 & 8** until the **TEMP** value is correctly displayed.
- 10) Press the  key to return to the measurement screen, or  to cancel entering the **TEMP**.













### 9.3 Semi Automatic Mode

The semi automatic mode gives the user an opportunity to initiate when the temperature is read and automatically adjusted. This mode may be desirable to those users want to use the automatic mode but want to retain some control as to when the temperature is changed, rather than take for granted the temperature is

automatically changing. Some companies and application procedures may call for manually initiating and physically viewing the change in temperature by adding a manual step to the procedures. The semi automatic mode answers requirements such as these.

### Selecting Semi Automatic Temperature Mode

UTILITIES	
TEMP MODE SEMI AUTO	
ALARM	OFF
ALARM LOW	0.00200
ALARM HIGH	0.00300
KEY CLICK	QUIET
SET DATE	YYMMDD
SHOW DATE	OFF
DATA UTIL XFER	









- 1) Press the  key once to activate the menu items tab. Press the  key multiple times to tab right, and the  key multiple times to tab left, until the **UTIL** menu is highlighted and displaying the submenu items.
- 2) Press the  and  arrow keys multiple times to scroll through the submenu items until **TEMP MODE** is highlighted.
- 3) Press the  and  arrow keys multiple times to scroll the temperature mode options. Once the **SEMI AUTO** temperature mode is displayed.
- 4) Press the  key once to activate measure menu items. Press the  key multiple times to move right, and the  key multiple times to move left until the **TEMP** cell is highlighted.
- 5) Press the  key to activate the **Digits Edit Box** and the temperature will be displayed and active.
- 6) Press the  key to accept the temperature and return to the measurement screen, or  to cancel entering the **TEMP**.

## 9.4 Automatic Mode

The automatic mode constantly monitors and compensates for temperature when the accessory temperature sensor is attached to the **BT1-DL** and placed on the joint or fastener being measured. While this mode eliminates the need to manually insert or initiate a temperature measurement, it also requires that the user be very cautious that the sensor is properly attached to the joint or fastener, and not accidentally removed or misplaced during the measurement process.

### Selecting Automatic Temperature Mode

UTILITIES	
<b>TEMP MODE AUTOMATIC</b>	
ALARM	OFF
ALARM LOW	0.00200
ALARM HIGH	0.00300
KEY CLICK	QUIET
SET DATE	YYMMDD
SHOW DATE	OFF
<b>DATA UTIL XFER</b>	

- 1) Press the  key once to activate the menu items tab. Press the  key multiple times to tab right, and the  key multiple times to tab left, until the **UTIL** menu is highlighted and displaying the submenu items.
- 2) Press the  and  arrow keys multiple times to scroll through the submenu items until **TEMP MODE** is highlighted.
- 3) Press the  and  arrow keys multiple times to scroll the temperature mode options. Once the **AUTO** temperature mode is displayed.
- 4) Press the  key once to return to the measurement screen.

## CHAPTER TEN BOLT MATERIAL CALIBRATION

### 10.1 Why Calibrate?





The preset bolt types in the **BT1-DL** contain average factors for the material type. These are approximate values only. In a tightly controlled application where extreme accuracy is required, it is necessary to obtain all the information possible about the fasteners being measured. By calibrating the fasteners, the ultrasonic and physical lengths of the bolts will match. However, if a field calibration is done, a complete calibration is not necessary. An important thing to note is the fact that everything done in the calibration process result in average values. Since a sample of fasteners will be used in the calibration process, and given the slight differences in material, the result will always be an average value of that sample.



### 10.2 Velocity Calibration



A velocity calibration is generally performed by adjusting the velocity in the **BT1-DL** to the point where the ultrasonic and physical lengths match. Again, since a sample of fasteners will be used in this process, the velocities will vary by a very small amount, thus resulting in an average velocity value. To accurately calibrate the velocity, a calibrated set of mechanical calipers is required to determine the exact physical lengths of the fasteners. The following procedure outlines this process.

#### Calibrating the Velocity



GEOMETRY	
QUANTITY	ELONG
LOAD FACTOR	0.000
LOAD OFFSET	0.0
AREA	0.000
EFFECTIVE LEN	0.00
CAL	MATL
GEOM	DISP

- 1) Press the  key once to activate the menu items tab. Press the  key multiple times to tab right, and the  key multiple times to tab left, until the **GEOM** menu is highlighted and displaying the submenu items.
- 2) Press the  and  arrow keys multiple times to scroll through the submenu items until **QUANTITY** is highlighted.



3) Press the  and  arrow keys multiple times to scroll the quantity until **ELONG** is displayed.

4) Press the  key multiple times to tab right, and the  key multiple times to tab left, until the **MATL** menu is highlighted and displaying the submenu items.

MATL TYPE		
1.	4140 STEEL	0.2320
2.	4340 STEEL	0.2320
3.	STS STEEL	0.2300
4.	INCONEL	0.2250
5.	TITANIUM	0.2450
6.	A193 B7	0.2320
7.	A193 B16	0.2320
8.	A325	0.2320
9.	A490	0.2320
10.	A540	0.2320
11.	GR.2	0.2320
12.	GR.5	0.2320
13.	GR.6	0.2320
14.	GR.8	0.2320
15.	GR.9	0.2320
16.	GR.9.8	0.2320



5) Press the  and  arrow keys multiple times to scroll through the submenu items until **TYPE** is highlighted.



6) Press the  key to display the list of bolt material types.

7) Press the  and  arrow keys multiple times to scroll through the material list until the appropriate material type is highlighted.









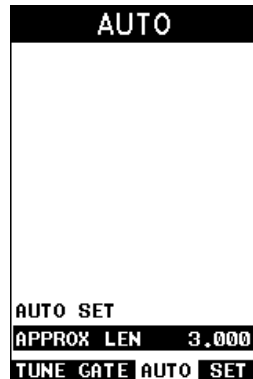

**Note:** *If the material type is not in the list of types, select a similar type. This step is only to get the velocity value in a close proximity – not critical. **Write down the velocity of the material type selected. This will be considered the Current Velocity.***

8) Press the  key to display the confirmation screen.

9) Press the  key to select the type and return to the menu screen, or  to cancel selecting the material type.

- 10) Press the  key multiple times to tab right, and the  key multiple times to tab left, until the **AUTO** menu is highlighted and displaying the submenu items.



- 11) Press the  and  arrow keys multiple times to scroll through the submenu items until **APPROX LEN** is highlighted.
- 12) Press the  key to display the **Digits Edit Box**.
- 13) Press the  and  arrow keys multiple times to scroll the highlighted value.
- 14) Press the  and  arrow keys multiple times to scroll the digit locations.
- 15) Repeat steps **13 & 14** until the **APPROX LEN** value is correctly displayed.
- 16) Press the  key to set the **Approximate Length** and return to the menu screen, or  to cancel entering the **Approximate Length**.
- 17) Press the  and  arrow keys multiple times to scroll through the submenu items until **AUTO SET** is highlighted.





18) Apply a drop of couplant to the bolt or transducer, and attach it to one end of the bolt. Rotate the transducer clockwise and counter clockwise applying a small amount of pressure to eliminate any excess couplant between the transducer and bolt surface. *Be sure to always place the transducer in the same location. This will help to eliminate any potential measurement errors caused by changing the sound path.*

19) Press the  key and the **Ultrasonic Length** of the bolt will be displayed.

**Note:** Alternatively, the  key can be pressed to activate **the Auto Set** routine.



20) Calculate the correct velocity using the following equation:

$$\frac{\text{PhysicalLength}}{\text{UltrasonicLength}} * \text{CurrentVelocity} = \text{CorrectVelocity}$$

21) Press the  key multiple times to tab right, and the  key multiple times to tab left, until the **MATL** menu is highlighted and displaying the submenu items.







MATERIAL	
UNITS	IN HR
TYPE	4140 STEEL
<b>VELOCITY</b>	<b>0.23200</b>
STRESS FACTOR	0.274
TEMP COEF	56.0
CAL	MATL GEOM DISP

22) Press the  and  arrow keys multiple times to scroll through the sub menu items until **VELOCITY** is highlighted.



23) Press the  key to display the **Digits Edit Box**.

**Note:** Enter the Correct Velocity calculated above.

24) Press the  and  arrow keys multiple times to scroll the highlighted value.

25) Press the  and  arrow keys multiple times to scroll to scroll the digit locations.

26) Repeat steps **24 & 25** until the **VELOCITY** value is correctly displayed.

27) Press the  key to set the **Velocity** and return to the menu screen, or  to cancel entering the **Velocity**.

28) Finally, press the  key to return to the measurement screen. *The ultrasonic length displayed should now match the known physical length.*

### 10.3 Stress factor calibration

The sonic stress factor is an empirically determined value for the bolt material or type of bolt being measured. It expresses the ratio of the actual elongation, or stretch, of the bolt, to the apparent ultrasonic change in length. Since the change in ultrasonic length is approximately 3 times the change in physical length, due to the change in velocity, a stress factor must be applied to correct the ultrasonic length in the **BT1-DL**.

Following steps determine the Sonic Stress Factor for bolts of a specific bolt material and specific geometry by measurement of the actual change in bolt length.

Required Equipment:

- A laboratory or room in which the temperature can be maintained at between 66° to 70° F.
- A means of applying load to the bolt. Ideally this would be a tensile load machine, capable of measuring the applied load to within 100 lbs. However, since the actual value of the applied load is not used in calculating the stress factor, any means of applying an approximate load to the bolt will suffice. This includes tightening the bolt against a fixture that simulates the actual joint. A mechanical means of traceable measurement of the physical length of the sample fasteners at various tensile loads to an accuracy of plus or minus 0.0001 inch. Examples of such devices include the following
  - Length measurement function of sophisticated tensile test machine
  - Mechanical or electronic height gages
  - Averaged values of length measurement with mechanical and electric micrometers.
- A Dakota NDT **BT1-DL** Ultrasonic Bolt Tension Monitor.
- A minimum of three sample bolts which are representative of the bolt type and geometry for which the Sonic Stress Factor is to be determined.

**NOTES:**

- The Dakota NDT **BT1-DL** must be calibrated, or zeroed, as described in the Zero Calibration procedure section 8.5.
- The Velocity Calibration should be performed prior to determining the Stress Factor. Refer to section 10.2.
- The sample bolts must be left to soak in the controlled temperature environment for a period of not less than 24 hours. Care must be taken through out the measurement process to avoid significant change in the bolt temperature due to handling of the sample bolts, or the process of applying load.
- The mechanical apparatus for measurement of length must be calibrated in accord with governing QA procedures. The device should be configured so that minimum handling of the sample bolts will be required during the measurement process.

Determination of the Sonic Stress Factor is accomplished by solving the equation:

$$\text{SonicStressFactor} = \frac{\Delta L_{\text{MECHANICAL}}}{\Delta L_{\text{ULTRASONIC}}} = \frac{L_{M1} - L_{M0}}{L_{U1} - L_{U0}}$$

$L_{U0}$  = UltrasonicLength@ZeroLoad

$L_{M0}$  = MechanicalLength@ZeroLoad

$L_{U1}$  = UltrasonicLength@Load

$L_{M1}$  = MechanicalLength@Load

### Calibrating the Stress Factor

- 1) Using the mechanical measuring device, measure and record the Mechanical Length at Zero Load " $L_{M0}$ " for each sample bolt.

**Note:** The following steps assume that the user has performed the steps in the previous section and calibrated the velocity. Therefore, the velocity has been adjusted, approximate length already entered, and the **BT1-DL** is currently setup and ready to measure in elongation mode.

- 2) Apply a drop of couplant to the bolt or transducer, and attach it to one end of the bolt. Rotate the transducer clockwise and counter clockwise applying a small amount of pressure to eliminate any excess couplant between the transducer and bolt. Be sure to always place the transducer in the same location. This will help to eliminate any potential measurement errors cause by changing the sound path.
- 3) Record the Ultrasonic Length at Zero Load " $L_{U0}$ ".
- 4) **Repeat step 2 & 3** for each sample bolt.
- 5) Place the first sample bolt in the loading apparatus. Apply approximately 1/3 of the maximum load, which is to be placed on the bolt under actual

- working conditions. Using the mechanical measuring device, measure and record the Mechanical Length at Load 1 “ $L_{M1}$ ” for the current sample bolt.*
- 6) Apply a drop of couplant to the bolt or transducer, and attach it to one end of the bolt. Rotate the transducer clockwise and counter clockwise applying a small amount of pressure to eliminate any excess couplant between the transducer and bolt. Measure and record the Ultrasonic Length at Load 1 “ $L_{U1}$ ” for the current sample bolt.
  - 7) *Increase the applied load to approximately 2/3 of the maximum load, which is to be placed on the bolt under actual working conditions. Using the mechanical measuring device, measure and record the Mechanical Length at Load 2 “ $L_{M2}$ ” for the current sample bolt.*
  - 8) Apply a drop of couplant to the bolt or transducer, and attach it to one end of the bolt. Rotate the transducer clockwise and counter clockwise applying a small amount of pressure to eliminate any excess couplant between the transducer and bolt. Measure and record the Ultrasonic Length at Load 2 “ $L_{U2}$ ” for the current sample bolt.
  - 9) *Increase the applied load to approximately the maximum load, which is to be placed on the bolt under actual working conditions. Using the mechanical measuring device, measure and record the Mechanical Length at Load 3 “ $L_{M3}$ ” for the current sample bolt.*
  - 10) Apply a drop of couplant to the bolt or transducer, and attach it to one end of the bolt. Rotate the transducer clockwise and counter clockwise applying a small amount of pressure to eliminate any excess couplant between the transducer and bolt. Measure and record the Ultrasonic Length at Load 3 “ $L_{U3}$ ” (Maximum) for the current sample bolt.
  - 11) **Repeat Steps 5 – 10** for the remaining bolts.

12) Calculate the value of the Sonic Stress Factor at each load on each sample bolt.

$$SSF_{B1L1} = \frac{L_{M1} - L_{M0}}{L_{U1} - L_{U0}} \quad SSF_{B1L2} = \frac{L_{M2} - L_{M0}}{L_{U2} - L_{U0}} \quad SSF_{B1L3} = \frac{L_{M3} - L_{M0}}{L_{U3} - L_{U0}}$$

13) Determine the average value of the Sonic Stress Factor by dividing the sum of all SSF values divided by the total number of SSF values.

## 10.4 Temperature Factor Calibration

The thermal expansion of the fastener and the ultrasonic velocity change with temperature are two separate effects. However, for the purpose of the **BT1-DL** they are combined into a single factor known as the Temperature Factor. The important thing to note is that both the thermal expansion and the velocity are changing with respect to changes in temperature. The **BT1-DL** always measures a fastener at 68° F. If the temperature of the fastener is currently being measured at 108° F, the **BT1-DL** will compensate, or correct, the measurement back to 68° F. **Note:** *This is an arbitrary temperature range only. The primary thing to consider is to use a respectable temperature range with at least 5 different temperature points. The following procedure outlines the process for experimental determination of the Temperature Factor for a bolt made of a specific material type and geometry.*

Required Equipment.

- A means of varying and measuring the temperature of the sample bolts between 48° to 108° F to an accuracy of +/- 2° F. The device must allow for a transducer to be connected to one end of the bolt for the purpose of measuring.

Many sophisticated temperature chambers are commercially available, and ideally suited for this function. However, a simple and inexpensive method can be achieved by immersion of the sample bolts in a water bath, which can be heated to boiling or cooled by adding ice. At sea level this will reliably vary the bolt temperature between approximately 48° to 108° F depending on water purity and atmospheric pressure. By measuring the temperature of the stirred water bath with a precise mercury thermometer, while reading the ultrasonic length of the bolt, accurate calibration points can be obtained.

- A Dakota NDT **BT1-DL** Ultrasonic Bolt Tension Monitor.

- A minimum of three sample bolts, which are representative of the bolt type and geometry for which the Temperature Factor is to be determined.

**NOTES:**

- The Dakota NDT **BT1-DL** must be calibrated, or zeroed, as described in the procedure entitled Measuring System Zero in 8.1.
- The sample bolts should be left to soak at the measured temperature points for a period of not less than 20 minutes, to insure that temperature is uniform throughout the sample.
- If a water bath is used, care must be taken to avoid immersion of the ultrasonic transducer.

Determination of the Temperature Factor is accomplished by solving the equation:

Where:

$T_p = \frac{(L_0 - L_T)}{L_T(T_0 - T)} \times 10^6$	<p><math>L_0 =</math> Ultrasonic Length at Beginning Temperature (<math>T_0</math>)</p> <p><math>L_T =</math> Ultrasonic Length at Ending Temperature (<math>T</math>)</p> <p><math>T_0 =</math> Beginning Temperature</p> <p><math>T =</math> Ending Temperature</p>
Temperature Factor	

**Calibrating the Temperature Factor**

1) *Stabilize the sample bolt at approximately 48<sup>o</sup> F. If the water bath method is used this is accomplished in a stirred bath of ice and water. Measure and record this minimum temperature as  $T_0$ .*

**Note:** *The following steps assume that the user has performed the steps in the previous section and calibrated the velocity. Therefore, the velocity has been adjusted, approximate length already entered, and the **BT1-DL** is currently setup and ready to measure in elongation mode.*

2) Apply a drop of couplant to the bolt or transducer, and attach it to one end of the bolt. Rotate the transducer clockwise and counter clockwise applying a small amount of pressure to eliminate any excess couplant between the

transducer and bolt. *Be sure to always place the transducer in the same location. This will help to eliminate any potential measurement errors caused by changing the sound path.*

- 3) Record the ultrasonic length “L<sub>0</sub>” of the sample bolt at the above minimum temperature - 48<sup>0</sup> F.
- 4) **Repeat step 1 - 3** at the target temperatures (T<sub>1</sub> through T<sub>5</sub>) – 48, 68, 88, and 108<sup>0</sup> F (other similar range with 5 temperatures), measuring the ultrasonic lengths (L<sub>1</sub> through L<sub>5</sub>) respectively. This process must be done for each of the sample bolts in the experiment.
- 5) Use the equation below to calculate a linear regression, using the temperatures and lengths recorded for all the sample bolts to determine the temperature factor.

$$TemperatureFactor = \frac{\sum xy - \frac{(\sum x)(\sum y)}{n}}{\sum x^2 - \frac{\sum (x)^2}{n}} * 10^6$$

x = temperature, y = change in reference length, n = number of sample points per bolt

## CHAPTER ELEVEN LOAD MEASUREMENT

### 11.1 Calculating Load Factor

The load factor is an empirically determined value for the geometry of the bolt. It is the amount of load required to elongate the bolt 0.001" in English Units or 0.01mm in Metric Units. The accurate load factor for the bolts being measured is determined by the Calibrate Bolt function.

An approximate value of this geometry dependent factor can be calculated as follows:

$$L_F = \frac{A_\sigma E}{(C_L + D)} \times 10^{-3}$$

Load Factor

$A_\sigma =$  Cross Sectional Area of the Bolt  
 $E =$  Modulus of Elasticity  
 $C_L =$  Clamp Length of the Bolt  
 $D =$  Diameter of the Bolt

**Note:** If no load factor has been entered the BT1-DL defaults to zero.

The relationship between load and elongation is a function of the elasticity of the bolt material, and the geometry of the bolt in the application being measured.

Hooke's Law expresses this relationship:

$P = \frac{\Delta l \times AE}{L_E}$ <p>Hooke's Law</p>	$P =$ Load $L_E =$ Average length under stress $\Delta L =$ Change in Length (elongation) $A =$ Cross sectional area of the bolt $E =$ Modulus of elasticity
---	--

The cross sectional area of the bolt is defined as the average area of a fastener under stress. This factor is only used in the **BT1-DL's** calculation of load. It has no effect on stress or elongation, time, or strain, and is directly proportional to the load measured ultrasonically. If the cross sectional area is off by 5%, the load measurement will also be off by 5% proportionally. For a cylindrical bolt with the same geometry, the area may be approximated as follows:

$A = \pi \left( \frac{D}{2} \right)^2$ <p>Area</p>	$D =$ minor diameter of the bolt, allowing for threads.
--	---



For bolts with complex geometry, the areas should be estimated by averaging each individual area and length. In the case of a hollow fastener, the area of the hole must be subtracted from the overall area. The area of a fastener with complex geometry can be estimated as follows:

$A_{AVG} = \frac{\sum AL}{\sum L}$ <p>Average Area</p>	<p><i>A = Area of a region</i>  <i>L = Length of a region</i></p>
--	---

The value for the Modulus of Elasticity, or Young’s Modulus, should be provided directly from the manufacturer of the bolts.

<i>E = Modulus of Elasticity of the Bolt Material</i>	<i>From Manufacturer</i>
---	--------------------------

The effective length is the average length of the fastener under stress when a load is applied. For an applied constant load, the elongation of a fastener is directly proportional to the effective length. Therefore, errors in the effective length will result in load errors by a proportional amount. The effective length of a fastener is a combination of the actual clamp length of the joint being fastened, plus that area of stress found in the head, nut(s), and or blind hole of the fastener.

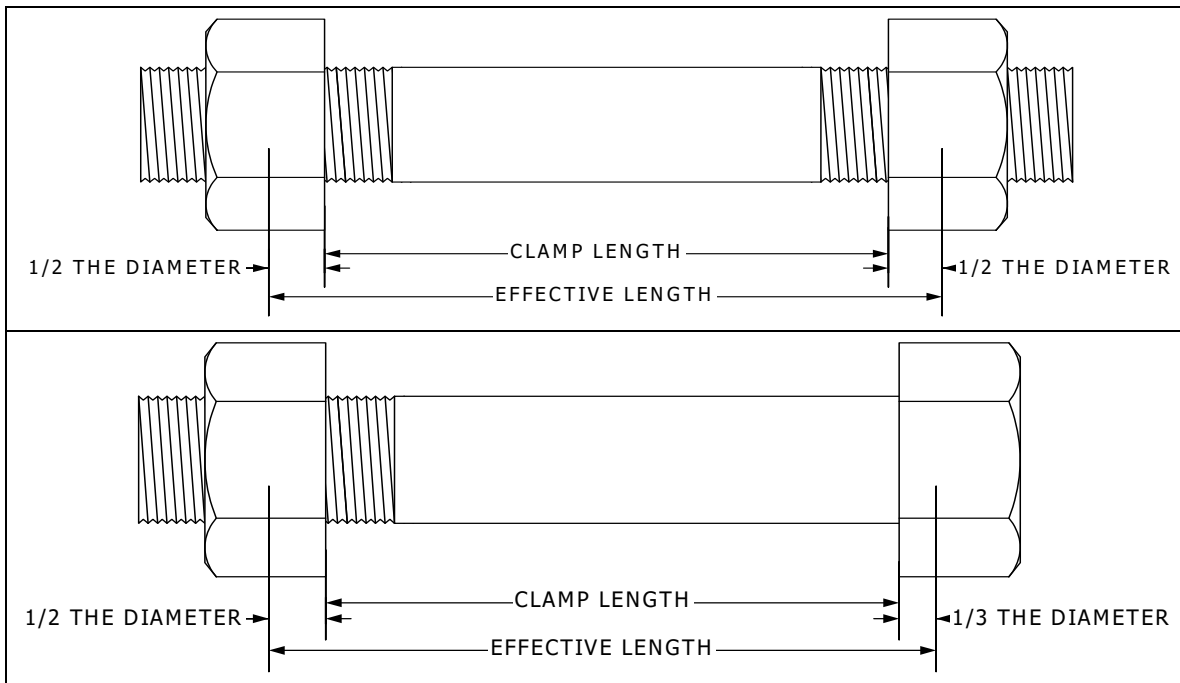

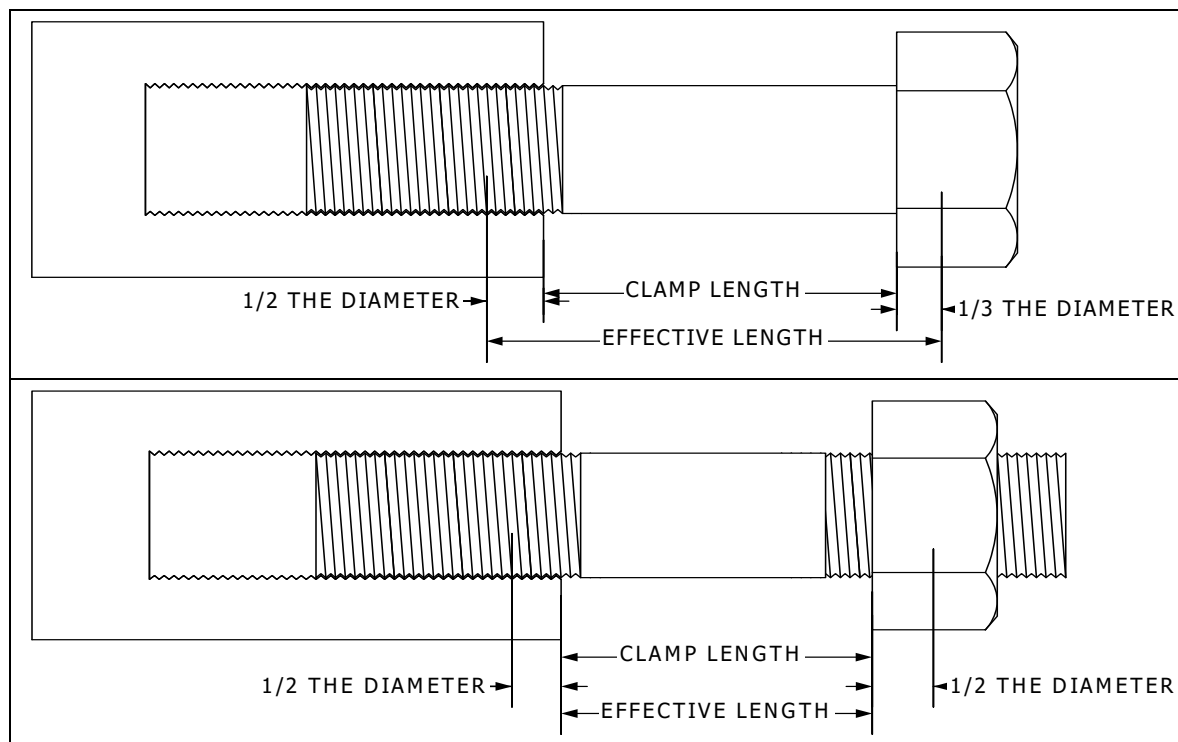

$L_E = C_L + D_X$ <p>Effective Length</p>	<p><math>L_E =</math> Average length under stress  <math>C_L =</math> Clamp length  <math>D_X =</math> Additional diameter added for head, nut(s), and or blind hole.</p>
---	---

**Note:** A convenient way to perform the above Load Factor calculations is to use the bolt calculator included in the DakView PC software.

It's important to note that performing the calculations above is only a good approximation at best. In all cases, if possible, a field calibration should be performed if the user intends to perform measurements in terms of load.

## 11.2 Calibrating Load Factor (Field Calibration)

Clearly, the most effective way of calibrating the load factor is by performing a field calibration. Often times, material constants are unknown or cannot be calibrated in a laboratory environment. In cases such as these, a field calibration is the most accurate means of calibration. A field calibration is accomplished using a tensile tester, load cell, or other calibrated load device to compare known loads against ultrasonic elongations. The **BT1-DL** is equipped with a self-calibrating feature that uses a linear regression or vector equation to produce a best-fit line through the known loads, minimizing error.

The result is an added load offset (intercept), in the case of regression, and a load factor (slope) to correct the ultrasonic measurements to the known loads. The regression produces a load offset and load factor, while the vector sets the offset to

zero and produces only a load factor. Why are both options needed? In applications where a small amount of load is applied to the fastener, thus producing very little elongation, the regression option can potentially produce non-linear results. In cases such as these, a vector may sometimes produce better results as the offset is set at zero. It is recommended to use and compare both results, following a field calibration, to determine which method is most suitable for the application and producing the best results.

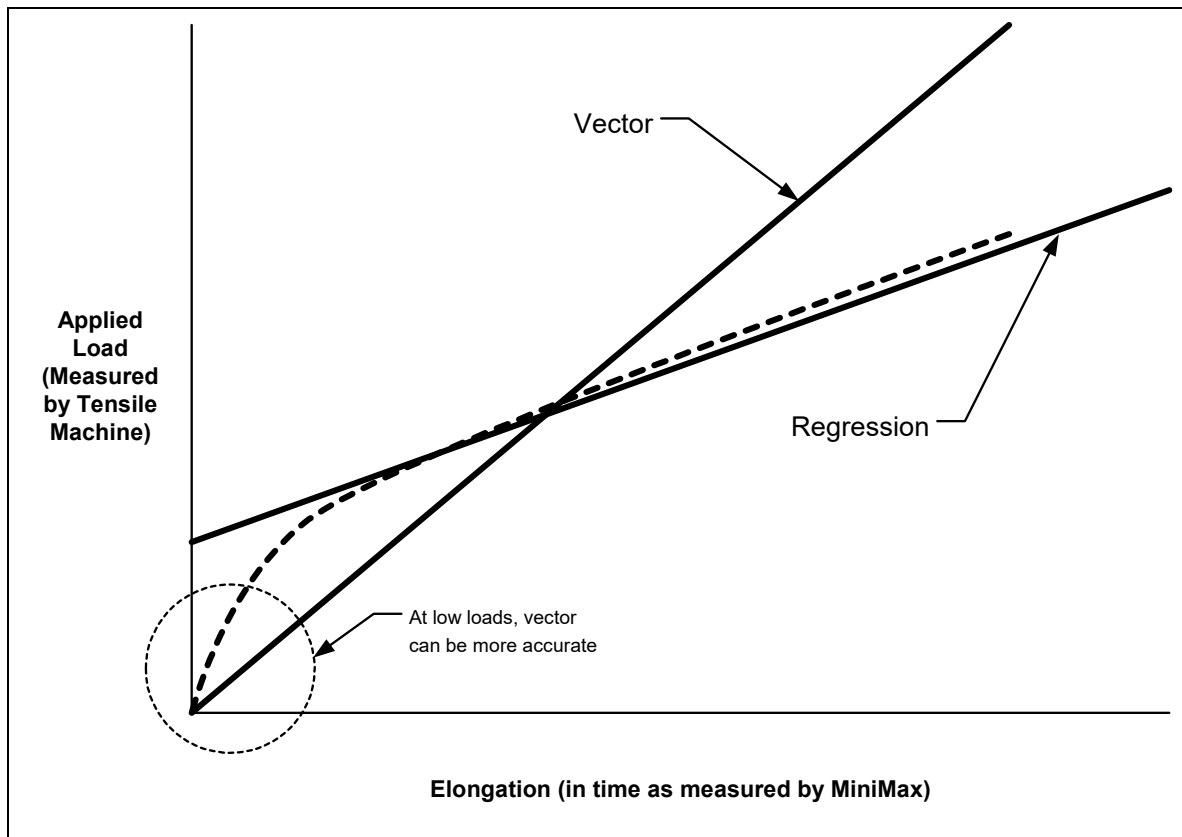







### 11.3 Performing a Field Calibration

This section outlines the necessary procedures to perform a field calibration to determine a Load Factor and Offset (in the case of using regression). In the calibration procedures below, three sample bolts will be used with three loads applied to each bolt (1/3, 2/3, & max). This should be considered the minimum requirement when performing a field calibration.



**Creating a Group Name to Document Field Calibration Data**

STORE DATA
<b>NEW</b>
EDIT
OPEN
CLOSE
DELETE ONE FILE
DELETE ALL DATA
SUMMARY
<b>DATA UTIL XFER</b>









**Note:** Select a name that references this group to **Field Calibration Data**.

- 1) Press the  key once to activate the menu items tab. Press the  key multiple times to tab right, and the  key multiple times to tab left, until the **DATA** menu is highlighted and displaying the submenu items.
- 2) Press the  and  arrow keys multiple times to scroll through the submenu items until **NEW** is highlighted.
- 3) Press the  key to display the **New Group Edit Box**.

NEW BOLT GROUP	
<b>NAME:</b>	<b>BOLTS-R-US</b>
<b>NOTE:</b>	
<b>NUM BOLTS</b>	1
<b>NUM READS</b>	1
<b>START BOLT</b>	1
<b>INCR DIR:</b>	NONE
CREATE GRID	

- 4) Press the  and  arrow keys multiple times to scroll through the new **Group List Items** until **NAME** is highlighted.
- 5) Press the  key to activate the **Alpha Edit Box**.



LOG NAME											
0	1	2	3	4	5	6	7	8	9		
!	'	#	/	.	-	(	)				
A	B	C	D	E	F	G	H	I	J		
K	L	M	N	O	P	Q	R	S	T		
U	V	W	X	Y	Z						
BOLTS-R-US											
OK						ESC					

- 6) Press the     arrow keys to scroll to highlight the appropriate alpha characters.
- 7) Press the  key to select a character and advance to the next field of the **Group Name**.
- 8) Use the  key to backspace if necessary.
- 9) Repeat steps 6 - 8 until the **Group Name** is completed.
- 10) Press the  key to save the **Group Name** and return to the **Group List Items** menu, or  to cancel entering the **Group Name**.

### Creating a Group Note





LOG NOTE	
DATE:	06/04/19
<b>NOTE: 1/2 5MHZ SER#</b>	
JOB:	GOLDEN GATE
OPER:	JOHNNY BOLT
COM1:	JOB WENT OK
COM2:	VIEW WAS
COM3:	BETTER
COM4:	

**Note:** Be sure to include a note that describes and references the Field Calibration data and bolt.

1) Press the  and  arrow keys multiple times to scroll through the new **Group List Items** until **NOTE** is highlighted.

2) Press the  key to activate the **Alpha Edit Box**.





3) Press the , , , and  arrow keys to scroll to highlight the appropriate alpha characters.

4) Press the  key to select a character and advance to the next field of the **Group Note**.

5) Use the  key to backspace if necessary.









6) Repeat steps 3 - 5 until the **Group Note** is completed.

7) Press the  key to save the **Group Note** and return to the **Group List Items** menu, or  to cancel entering the **Group Note**.

### Selecting the Number of Bolts in the Group

**Note:** *In this example the minimum requirement of 3 sample bolts will be used.*













NEW BOLT GROUP	
NAME:	BOLTS-R-US
NOTE:	1/2 5MHZ
<b>NUM BOLTS</b>	<b>1</b>
NUM READS	1
START BOLT	1
INCR DIR:	NONE
CREATE GRID	



- 1) Press the  and  arrow keys multiple times to scroll through the new **Group List Items** until **NUM BOLTS** is highlighted.
- 2) Press the  key to display the **Digits Edit Box**.
- 3) Press the  and  arrow keys multiple times to scroll the highlighted value.
- 4) Press the  and  arrow keys multiple times to scroll the digit locations.
- 5) Repeat steps **3 & 4** until the **NUM BOLTS** value is correctly displayed.
- 6) Press the  key to save the **NUM BOLTS** and return to the **Group List Items** menu, or  to cancel entering the **NUM BOLTS**.

### Selecting the Number of Readings Per Bolt

**Note:** *In this example 3 loads will be applied to each sample bolt.*

NEW BOLT GROUP	
NAME:	BOLTS-R-US
NOTE:	1/2 5MHZ
NUM BOLTS	1
<b>NUM READS</b>	<b>1</b>
START BOLT	1
INCR DIR:	NONE
CREATE GRID	

- 1) Press the  and  arrow keys multiple times to scroll through the new **Group List Items** until **NUM READS** is highlighted.
- 2) Press the  key to display the **Digits Edit Box**.
- 3) Press the  and  arrow keys multiple times to scroll the highlighted value.
- 4) Press the  and  arrow keys multiple times to scroll the digit locations.
- 5) Repeat steps 3 & 4 until the **NUM READS** value is correctly displayed.
- 6) Press the  key to save the **NUM READS** and return to the **Group List Items** menu, or  to cancel entering the **NUM READS**.
- 7) Press the  key to display the **Digits Edit Box** and re-enter the **NUM READS**.
- 8) Press the  key to save the **NUM READS** and return to the **Group List Items** menu, or  to cancel entering the **NUM READS**.









If there's not enough memory available to create the group, an error message box "**NOT ENOUGH MEMORY**" will be displayed. Press the  or  key to return to the **Group List Items** menu. It may be necessary to free some memory in the **BT1-DL** at this time.



### Selecting the Starting Bolt Number

**Note:** Depending on the application and layout of the project, the user won't always want the starting bolt to be 1. This feature allows the user to define what the starting number will be.

NEW BOLT GROUP	
NAME:	BOLTS-R-US
NOTE:	1/2 5MHZ
NUM BOLTS	1
NUM READS	1
<b>START BOLT</b>	<b>1</b>
INCR DIR:	NONE
CREATE GRID	

- 1) Press the  and  arrow keys multiple times to scroll through the new **Group List Items** until **START BOLT NUM** is highlighted.
- 2) Press the  key to display the **Digits Edit Box**.
- 3) Press the  and  arrow keys multiple times to scroll the highlighted value.
- 4) Press the  and  arrow keys multiple times to scroll the digit locations.
- 5) Repeat steps **3 & 4** until the **START BOLT NUM** value is correctly displayed.
- 6) Press the  key to save the **START BOLT NUM** and return to the **Group List Items** menu, or  to cancel entering the **START BOLT NUM**.

**Note:** If a value is enter that is greater than the maximum number of bolts allowed per group (250), an error message box “VALUE IS OUT OF RANGE” will be displayed.



7) Press the  key to display the **Digits Edit Box** and re-enter the **START BOLT NUM.**



8) Press the  key to save the **START BOLT NUM** and return to the **Group List Items** menu, or  to cancel entering the **START BOLT NUM.**

### Selecting the Auto Increment Direction

The **Auto Increment** feature gives the user the ability to specify which direction to advance the cursor after storing a reading.

NEW BOLT GROUP	
NAME:	BOLTS-R-US
NOTE:	1/2 5MHZ
NUM BOLTS	1
NUM READS	1
START BOLT	1
<b>INCR DIR:</b>	<b>NONE</b>
CREATE GRID	

1) Press the  and  arrow keys multiple times to scroll through the new **Group List Items** until **INCR. DIR** is highlighted.







2) Press the  and  arrow keys multiple times to toggle the **Increment** direction **NONE, NORTH, EAST, SOUTH, or WEST.**

3) When the correct **Increment** direction is displayed, continue on to the next section “**Saving the Group**”.

## Saving the Group

Once all the parameters are set, the user has the option of saving or canceling the new group.



NEW BOLT GROUP	
NAME:	BOLTS-R-US
NOTE:	1/2 5MHZ
NUM BOLTS	1
NUM READS	1
START BOLT	1
INCR DIR:	NONE
CREATE GRID	

- 1) Press the  and  arrow keys multiple times to scroll through the new **Group List Items** until **CREATE NEW GROUP?** is highlighted.
- 2) Press the  key to accept the group parameters, and activate the confirmation screen.
- 3) Press the  key to save the **New Group**, or the  key to cancel **the New Group** setup and return to the **DATA** menu.
- 4) Press the  key to return to the measurement screen to begin measuring reference lengths.





Now that a group has been created to store the field calibration data, the group must be activated and ready to store reference lengths and elongations.

### Storing the Reference Length

DELAY: 2.958	WIDTH: 0.302
ALEN: 3.000	GAIN: 51.0
GATE: 2.850	TEMP: 68.0
THRESH: 10	LOG: A003

- 1) Press the  key once to activate measure menu items. Press the  key multiple times to move right and the  key multiple times to move left until the **LOG** cell is highlighted.



NAME: BOLTS R US			
	A	B	C
1	4.01493		
2	3.05655	0.00000	
3			





- 2) Press the  key to display the **Group View Box**.
- 3) Press the     arrow keys to scroll the target cell cursor to the desired storage location.

**Note:** *The first column must be used to store reference lengths.*

### Selecting the Calibration Mode (Vector or Regression)

<b>CALIBRATE</b>	
ZERO MODE TWO POINT	
ZERO	-162.50
MEASURE ZERO	
LOAD CAL MO	<b>REGRESSION</b>
LOAD CAL CALC	
CAL	<b>MATL GEOM DISP</b>

- 1) Press the  key multiple times to tab right and the  key multiple times to tab left until the **CAL** menu is highlighted and displaying the submenu items.

- 2) Press the  and  arrow keys multiple times to scroll through the sub menu items until **LOAD CAL MODE** is highlighted.
- 3) Press the  and  arrow keys multiple times to scroll through the unit options **OFF**, **VECTOR** (zero offset), **REGRESSION**, until the correct mode is displayed.
- 4) Press the  key to return to the measurement mode.

Now that a group has been created and activated, and the load calibration mode selected, we're ready to perform the field calibration.

### Performing a Field Calibration

- 1) *Place the first sample bolt in the load apparatus.*

**Note:** *The following steps assume that the user has previously selected a similar material type for the list of materials and the approximate length of the bolt has been entered. Therefore, the **BT1-DL** is currently setup and ready to measure in elongation mode.*

- 2) Apply a drop of couplant to the bolt or transducer, and attach it to one end of the bolt. Rotate the transducer clockwise and counter clockwise applying a small amount of pressure to eliminate any excess couplant between the transducer and bolt. *Be sure to always place the transducer in the same location. This will help to eliminate any potential measurement errors cause by changing the sound path.*



- 3) Record the ultrasonic reference length at zero Load by pressing the  key.



**Note:** *The reference lengths must be saved in column A in the group.*

4) *Apply approximately 1/3 of the maximum load, which is to be placed on the bolt under actual working conditions.*



5) Measure and record the Ultrasonic Length at Load 1 by pressing the  key. The **Digits Edit Box** will be displayed.

**Note:** *Load 1 should be stored in column B.*

6) Enter the **Known Load** value by pressing the  and  arrow keys multiple times to scroll the highlighted value.

7) Press the  and  arrow keys multiple times to scroll the digit locations.



8) Repeat steps **6 & 7** until the **Known Load** value is correctly displayed.



9) Press the  key to store the **Known Load** and return to the measurement screen, or  to cancel entering the **Known Load**.

10) *Increase the applied load to approximately 2/3 of the maximum load, which is to be placed on the bolt under actual working conditions.*



11) Measure and record the Ultrasonic Length at Load 2 by pressing the  key. The **Digits Edit Box** will be displayed.

**Note:** *Load 2 should be stored in column C.*

12) Enter the **Known Load** value by pressing the  and  arrow keys multiple times to scroll the highlighted value.

13) Press the  and  arrow keys multiple times to scroll the digit locations.



14) Repeat steps **8 & 9** until the **Known Load** value is correctly displayed.



15) Press the  key to store the **Known Load** and return to the measurement screen, or  to cancel entering the **Known Load**.

16) *Increase the applied load to approximately the maximum load, which is to be placed on the bolt under actual working conditions.*

17) Measure and record the Ultrasonic Length at Load 3 by pressing the  key. The **Digits Edit Box** will be displayed.

**Note:** *Load 3 should be stored in column D.*

18) Enter the **Known Load** value by pressing the  and  arrow keys multiple times to scroll the highlighted value.

19) Press the  and  arrow keys multiple times to scroll the digit locations.



20) Repeat steps **18 & 19** until the **Known Load** value is correctly displayed.



21) Press the  key to store the **Known Load** and return to the measurement screen, or  to cancel entering the **Known Load**.

22) **Repeat Steps 1 – 21** for sample bolts 2 & 3.

Now that we have measured and documented three sample bolts, we're now ready to run the vector or regression calculation to determine a load factor and offset (regression only).

### Running a Regression or Vector

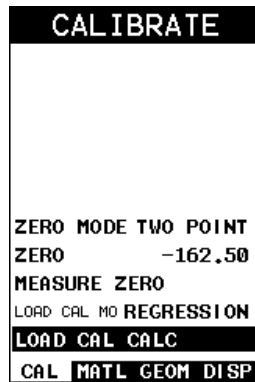

1) Press the  key multiple times to tab right and the  key multiple times to tab left until the **CAL** menu is highlighted and displaying the submenu items.

- 2) Press the  and  arrow keys multiple times to scroll through the sub menu items until **LOAD CAL CALC** is highlighted.



- 3) Press the  key to run the calculation and display the confirmation screen.

**Note:** *The regression or vector coefficient will be displayed. The closer this number is to 1, the better the fit, or least amount of error.*

- 4) Press the  key to accept the calculation, or the  key to cancel and return to the **CAL** menu.

- 5) Press the  key to return to the measurement screen.

**Note:** *The new **Load Factor** and **Offset** values can be reviewed and edited in the **GEOM** tabbed menu item.*

- 6) Calibration is completed.



## CHAPTER TWELVE MEASUREMENT & WAVEFORM DISPLAY

### 12.1 Quantities of Measurement

The **BT1-DL** has the ability to measure in a number of measurement quantities: Time (nanoseconds), Elongation, Load, Stress, and Strain (in terms of %). While there are a number of quantity options available, the easiest and most fail safe quantities to consider are Time and Elongation. *If Load, Stress, or Strain will be used on a regular basis, a calibration of the bolts for the specific application is required.*

The equations below outline the required factors and constants necessary for each quantity. When measuring in terms of time and elongation, very little information is required, as the measurement is simply a difference equation. The stress factor and velocity will typically not vary more than 5%, in total, over the entire range of possible steel fasteners. Therefore the worst case error is 5%. However, when measuring in terms of load, stress, or strain, the error can be enormous if errors in effective length, load factor, or cross sectional area are made. These factors will result in proportional errors overall. Therefore, if the load factor is off by 10%, the load measurement will be in error by the same 10% proportionally.

$X_E = [(S_F)(V_0)]\Delta T$ <p><b>Elongation</b></p>	<p><math>X_E =</math> Elongation  <math>S_F =</math> Sonic Stress Factor  <math>V_0 =</math> Material Velocity  <math>\Delta T =</math> Change in time.</p>
---	---

$P = (X_E)(L_F) + L_o$ <p><b>Load</b></p>	<p><math>P =</math> Load  <math>X_E =</math> Elongation  <math>L_F =</math> Load Factor  <math>L_o =</math> Load Offset</p>
---	---

$S = \left(\frac{P}{A}\right)$ <p><b>Stress</b></p>	<p><math>S =</math> Stress  <math>P =</math> Load  <math>A =</math> Cross sectional error</p>
---	---

$S_N = \left(\frac{X_E}{L_E}\right) * 100$ <p><b>%Strain</b></p>	<p><math>S_N =</math> %Strain  <math>X_E =</math> Elongation  <math>L_E =</math> Effective Length</p>
--	---

## 12.2 Display View Options

A key feature of the **BT1-DL** is the versatility of the display views available to the user. The waveform views are a graphical representation of the actual sound reflections traveling through a fastener and returning back to the transducer. The waveform display shows the amplitude of the signal received on the vertical (Y) axis and time (displayed in terms of length) on the horizontal (X) axis. The two waveform display options are **RF**(Full) wave, and **RECT**(rectified) half wave either positive or negative. These waveform options give the user the ability to view the actual waveform and point of detection. In this view option the user has better control over where the **BT1-DL** is detecting, selecting the proper phase of the signal, and adjusting the gate and threshold (sensitivity) to eliminate noise or to force a specific detection point.



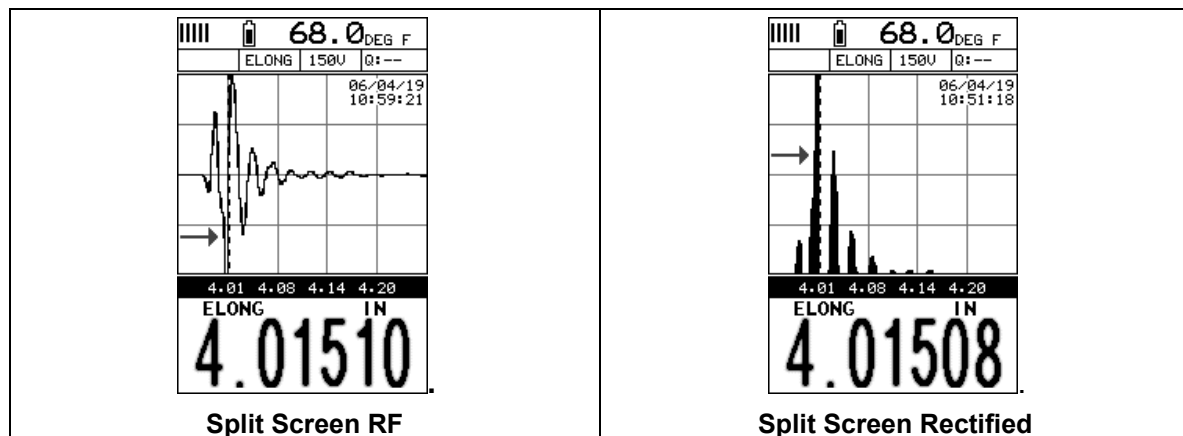

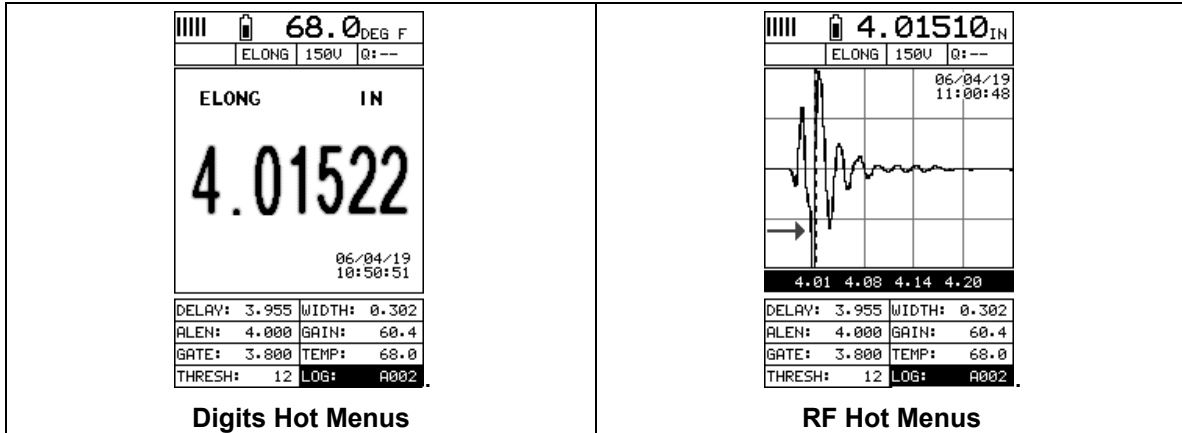



The **RF** waveform view is recommended when initially setting up the **BT1-DL** for an application. The user can consider either a full RF wave or split screen RF option. This display view gives the user the ability to view the entire waveform, both positive and negative cycles, to determine the appropriate phase of the signal for measurement. The **Large Digits** display view is a general digital display of the quantity selected. It's a nice easy viewing option that is typically used following setup of the initial application. The digits view is also equipped with a limits bar that is only displayed when the alarm feature has been activated. The alarm limits are displayed on the screen to give the user a visual idea of where they're at throughout the fastening process. The alarm lights and beeper also work in conjunction with the alarm limits and will display red until the lower limit is reached. Once the bolt stretch is within the limits, the beeper will sound and the green light displayed.





### Changing Display Options

SET DISPLAY	
VIEW	RF
CONTRAST	10
BACKLIGHT	OFF
DELAY	2.934
WIDTH	0.302
RECT WAVE	FILLED
DETECT MARK	DOTS
CAL	MATL GEOM DISP

- 1) Press the  key once to activate the menu items tab. Press the  key multiple times to tab right, and the  key multiple times to tab left, until the **DISP** menu is highlighted and displaying the submenu items.
- 2) Press the  and  arrow keys multiple times to scroll through the submenu items until **VIEW** is highlighted.
- 3) Press the  and  arrow keys multiple times to scroll the view options. Once the appropriate view is displayed, press the  key to return to the measurement screen.

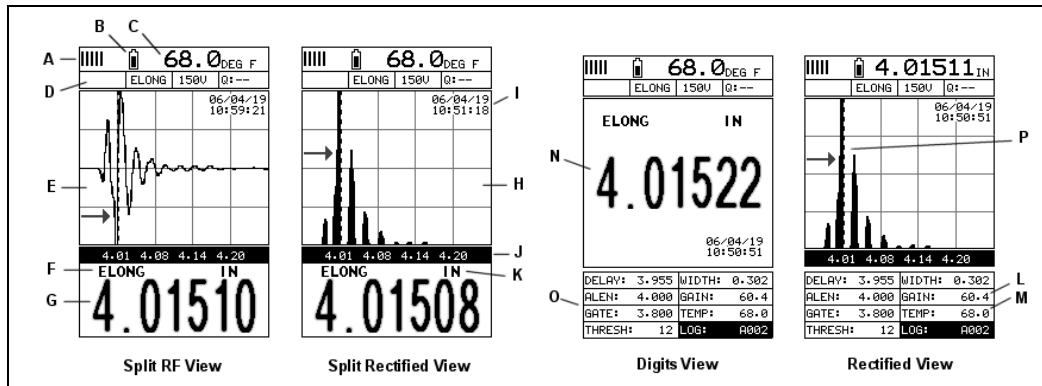

## RF

The RF mode shows the waveform in a similar fashion to an oscilloscope. It shows both the positive and the negative peaks. The peak (either positive or negative) selected for measurement is shown in upper portion of the display.

## Rectified

The rectified A-Scan mode shows half of the waveform. Either the positive or negative peaks are displayed, depending on the polarity selected.



## Digits

The Digits view is a basic digital look and feel. The larger digits make it much easier for the operator to monitor the measurements. The Limits Bar has also been added to the Digits view to provide the user with yet another visual tool for easily monitoring if the fastener is inside specific tolerances.

**Note:** For both RF and Rectified views, it's important to note that a measurement must fall inside the displays viewable range in order to see the waveform. However, even if the waveform is outside of the viewable range of the display, a measurement can be taken and viewed on the digital readout. If the wave is outside of the display range, you can manually change the range by adjusting the **Delay** and **Width** values, or you can use the **Auto Find** feature located in the **UTIL** menu of the tabbed menu items.

The following is a reference list of the viewable features as shown above:

- A. **Repeatability/Stability Indicator** – Indicates the reliability of the measured bolt length. When all the vertical bars are fully illuminated and the last digit on the digital thickness value is stable, the **BT1-DL** is reliably measuring the same value on a consistent basis.
- B. **Battery Icon** – Indicates the amount of battery life the **BT1-DL** has remaining.













- C. **Temperature** – Indicates the current temperature of either the temperature sensor, or manual value entered.
- D. **Feature Status Bar** – Indicates the features currently enabled and in use:
- Alarm
  - Quantity
  - Pulser Voltage
  - Q-Factor (wave correlation)
- E. **RF A-Scan Display (split screen)** – Displays the radio frequency sound wave reflection returned the opposite end of the bolt being measured. The RF view displays both the positive and negative cycles.
- F. **Quantity** – Displays the current quantity setting used (elongation, load, stress, strain or time).
- G. **Digital Measurement** – Display in inches, millimeters, KSI, KIPS, %strain, time (nanoseconds).
- H. **Rectified A-Scan Display** – Displays either the positive or negative half cycle wave reflection returned from the opposite end of the bolt being measured, depending on the polarity selected.
- I. **Time & Date** – Feature to display either the time, date, or both time and date on the main measurement screen.
- J. **Length Division Markers** – Measurement scale of length.
- K. **Units** – Displays the current measurement units being used (English, Metric).
- L. **Gain** – The current gain setting can be adjusted at any time while in measurement mode.
- M. **Temperature** – Refer to (C) above. The location of the temperature is displayed in this location when the hot menus are shown. Notice in (C) the view is split screen and temperature is displayed in the top right corner of the display. When the temperature mode is set ‘manual’, the value can be changed at any time.
- N. **Digital Measurement** – Display in inches, millimeters, KSI, KIPS, %strain, time (nanoseconds).
- O. **Hot Menu items** – We call this menu section our “hot menu”, as these items are the most commonly adjusted features, requiring quick access from the user. They can be displayed and scrolled by pressing the  key at any time. The  key advances forward and the  key backwards to the next hot menu item.
- P. **Detect/Gate/Threshold** – The broken dotted line demonstrates where the **BT1-DL** is currently detecting on the waveform. Notice the horizontal line with an arrow pointing at the detection point. This is the ‘gate’, and the height of the line from the baseline is the ‘threshold’ level.

## 12.3 Adjusting the Display

The width refers to the overall viewable range, with respect to length, being displayed on the screen. The starting length is displayed at the lower left side of the screen, and the ending length is shown at the lower right hand side of the screen. The difference between these values is called the **Width**. The procedures to adjust the **Width** are outlined below:

### Adjusting the Width using the Hot Menu















DELAY:	2.934	WIDTH:	0.302
ALEN:	2.961	GAIN:	48.2
GATE:	2.787	TEMP:	----
THRESH:	11	LOG:	A001

- 1) Press the  key once to activate measure menu items. Press the  key multiple times to move right and the  key multiple times to move left, until the **WIDTH** cell is highlighted.
- 2) Press the  and  arrow keys multiple times to scroll the highlighted value.
- 3) **Alternatively**, press the  key to display the **Digits Edit Box**.
- 4) Press the  and  arrow keys multiple times to scroll the highlighted value.
- 5) Press the  and  arrow keys multiple times to scroll the digit locations.
- 6) Repeat steps **4 & 5** until the **WIDTH** value is correctly displayed.
- 7) Press the  key to return to the measurement screen, or  to cancel entering the **WIDTH**.

The user can also access and adjust the width from the tabbed menus, however this method is a more tedious than making the adjustments using the Hot Menu. The procedure using the tabbed menu is outlined below:

## Adjusting the Width using the Tabbed Menus

SET DISPLAY	
VIEW	RF
CONTRAST	10
BACKLIGHT	OFF
DELAY	2.934
WIDTH	0.302
RECT WAVE	FILLED
DETECT MARK	DOTS
CAL	MATL GEOM DISP

- 1) Press the  key once to activate the menu items tab. Press the  key multiple times to tab right, and the  key multiple times to tab left, until the **DISP** menu is highlighted and displaying the submenu items.
- 2) Press the  and  arrow keys multiple times to scroll through the submenu items until **WIDTH** is highlighted.
- 3) Press the  and  arrow keys multiple times to scroll the value. When the correct width is being displayed, **proceed to step 8**.
- 4) **Alternatively**, press the  key to display the **Digits Edit Box**.
- 5) Press the  and  arrow keys multiple times to scroll the highlighted value.
- 6) Press the  and  arrow keys multiple times to scroll the digit locations.
- 7) Repeat steps **5 & 6** until the **Width** value is correctly displayed.
- 8) Press the  key to set the **Width** and return to the menu screen, or  to cancel entering the **Width**.
- 9) Finally, press the  key to return to the measurement screen.

## Starting delay













The starting **DELAY**, or starting length, is the value displayed on the bottom lower left side of the display in both **RF** and **RECT** (Rectified) views.

**Note:** *Once the range is set, it will remain the same for all the views respectively.*

The procedures to adjust the **Delay** are outlined below:

### Adjusting the Delay using the Hot Menu

DELAY: 2.934	WIDTH: 0.302
ALEN: 2.961	GAIN: 48.2
GATE: 2.787	TEMP: ----
THRESH: 11	LOG: A001















- 1) Press the  key once to activate measure menu items. Press the  key multiple times to move right and the  key multiple times to move left, until the **DELAY** cell is highlighted.
- 2) Press the  and  arrow keys multiple times to scroll the highlighted value.
- 3) **Alternatively**, press the  key to display the **Digits Edit Box**.
- 4) Press the  and  arrow keys multiple times to scroll the highlighted value.
- 5) Press the  and  arrow keys multiple times to scroll the digit locations.
- 6) Repeat steps **4 & 5** until the **DELAY** value is correctly displayed.
- 7) Press the  key to return to the measurement screen, or  to cancel entering the **DELAY**.

The user can also access and adjust the delay from the tabbed menus. However, this method is more tedious than making the adjustments using the Hot Menu. The procedure using the tabbed menus is outlined below:

### Adjusting the Delay using the Tabbed Menus



SET DISPLAY	
VIEW	RF
CONTRAST	10
BACKLIGHT	OFF
<b>DELAY</b>	<b>2.934</b>
WIDTH	0.302
RECT WAVE	FILLED
DETECT MARK	DOTS
CAL MATL GEOM DISP	

- 1) Press the  key once to activate the menu items tab. Press the  key multiple times to tab right, and the  key multiple times to tab left, until the **DISP** menu is highlighted and displaying the submenu items.
- 2) Press the  and  arrow keys multiple times to scroll through the submenu items until **DELAY** is highlighted.
- 3) Press the  and  arrow keys multiple times to scroll the value. When the correct **Delay** is being displayed, **proceed to step 8**.
- 4) **Alternatively**, press the  key to display the **Digits Edit Box**.
- 5) Press the  and  arrow keys multiple times to scroll the highlighted value.
- 6) Press the  and  arrow keys multiple times to scroll the digit locations.
- 7) Repeat steps **5 & 6** until the **Delay** number is correctly displayed.
- 8) Press the  key to set the **Delay** and return to the menu screen, or  to cancel entering the **Delay**.
- 9) Finally, press the  key to return to the measurement screen.













## 12.4 Gain

The gain, or amplification of the return echoes, can be adjusted over a wide range. The setting of the gain is crucial in order to obtain valid readings during the measurement process. Too much gain may result in erroneous measurements, by detecting on noise rather than the length of the fastener itself. Too little gain may result in detection on an undesirable section of the waveform. It may also result in a “peak jump” to another part of the waveform later in time, resulting in measurement errors. The gain can easily be compared to the volume control of a home stereo system. If you turn it up too much, you can’t hear the music clearly. If it’s turned down too much, you can’t hear it at all.

The procedures to adjust the **Gain** are outlined below:

### Adjusting the Gain using the Hot Menu







DELAY:	2.934	WIDTH:	0.302
ALEN:	2.961	GAIN:	48.2
GATE:	2.787	TEMP:	----
THRESH:	11	LOG:	A001

- 1) Press the  key once to activate measure menu items. Press the  key multiple times to move right and the  key multiple times to move left, until the **GAIN** cell is highlighted.
- 2) Press the  and  arrow keys multiple times to scroll the highlighted value.
- 3) **Alternatively**, press the  key to display the **Digits Edit Box**.
- 4) Press the  and  arrow keys multiple times to scroll the highlighted value.
- 5) Press the  and  arrow keys multiple times to scroll the digit locations.
- 6) Repeat steps **4 & 5** until the **GAIN** value is correctly displayed.
- 1) Press the  key to return to the measurement screen, or  to cancel entering the **GAIN**.

The user can also access and adjust the gain from the tabbed menus. However, this method is more tedious than making the adjustments using the hot menu. The procedure using the tabbed menus is outlined below:







### Adjusting the Gain using the Tabbed Menus

TUNE SIGNAL	
PULSE	THIN
PULSER VOLTAGE	100
DAMPING	1500
<b>GAIN</b>	<b>48.2</b>
GAIN STEP	1.0
DIGITIZER	4X
TUNE	GATE AUTO SET

- 1) Press the  key once to activate the menu items tab. Press the  key multiple times to tab right, and the  key multiple times to tab left, until the **TUNE** menu is highlighted and displaying the submenu items.
- 2) Press the  and  arrow keys multiple times to scroll through the submenu items until **GAIN** is highlighted.
- 3) Press the  and  arrow keys multiple times to scroll the value. When the correct **GAIN** is being displayed, **proceed to step 8.**

SET GAIN	
48.2	
OK	ESC





- 4) **Alternatively**, press the  key to display the **Digits Edit Box.**



- 5) Press the  and  arrow keys multiple times to scroll the highlighted value.
- 6) Press the  and  arrow keys multiple times to scroll the digit locations.
- 7) Repeat steps **5 & 6** until the **GAIN** value is correctly displayed.
- 8) Press the  key to set the **GAIN** and return to the menu screen, or  to cancel entering the **GAIN**.
- 9) Finally, press the  key to return to the measurement screen and begin taking readings.

The step size of the gain increment can also be adjusted by the user. The procedure to set a specific gain increment amount is outlined below:









### Adjusting the Step Size using the Tabbed Menus

TUNE SIGNAL	
PULSE	THIN
PULSER VOLTAGE	100
DAMPING	1500
GAIN	48.2
<b>GAIN STEP</b>	<b>1.0</b>
DIGITIZER	4X
TUNE	GATE AUTO SET

- 1) Press the  key once to activate the menu items tab. Press the  key multiple times to tab right, and the  key multiple times to tab left, until the **TUNE** menu is highlighted and displaying the submenu items.
- 2) Press the  and  arrow keys multiple times to scroll through the submenu items until **Step Size** is highlighted.

- 3) Press the  and  arrow keys multiple times to scroll the value. When the correct **Step Size** is being displayed, **proceed to step 8**.



- 4) **Alternatively**, press the  key to display the **Digits Edit Box**.
- 5) Press the  and  arrow keys multiple times to scroll the highlighted value.
- 6) Press the  and  arrow keys multiple times to scroll the digit locations.
- 7) Repeat steps **5 & 6** until the **Step Size** value is correctly displayed.
- 8) Press the  key to set the **Step Size** and return to the menu screen, or  to cancel entering the **Step Size**.
- 9) Finally, press the  key to return to the measurement screen and begin taking readings.

## 12.5 Gate

The **BT1-DL** is equipped with a single gate typically used to block or eliminate noise that is present prior to the reflection from the end of the bolt, and also to force a detection at or on a specific location or waveform. In some cases the first reflection from the end of the bolt will not produce a suitable symmetrical waveform. However, if the user looked further out in time (length), a reflection from a mode conversion very well may be a better alternative signal to detect on. A mode conversion is simply a reflection of energy that took a longer path reflecting off the sidewalls of the

bolt, and resulting in a return echo slightly longer than the overall length of the bolt. A detection can only occur inside of the boundaries of the gate. Therefore, setting the start of the gate beyond the first reflection from the end of the bolt will force the BT1-DL to look for the next detection. In this case a mode conversion.



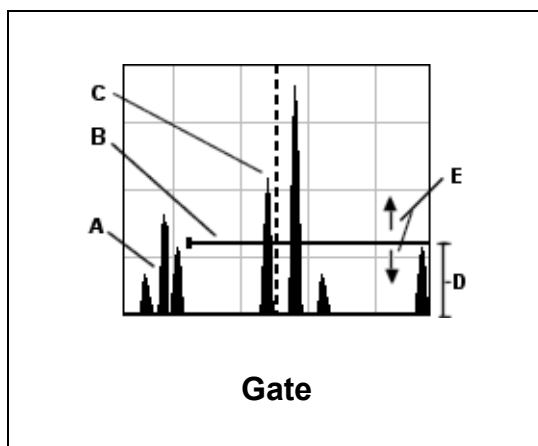









Another potential issue is general transducer or low frequency noise. In this type of situation, the noise interferes with the **BT1-DL** and has enough amplitude to cause the **BT1-DL** to detect on the noise rather than the true return reflection. The diagram below illustrates both cases:



The horizontal line at the top of **(D)** represents the **GATE**. The starting point of **GATE** has been adjusted just beyond the noise **(A)**, so that the **BT1-DL** ignores the noise and detects on the true back wall reflection **(C)**. Alternatively, the diagram can also be considered as **(A)** representing the actual reflection from the end of the bolt, and the gate **(B)** blocking the detection of **(A)** to use the mode conversion **(C)**. Finally, it's important to note that the threshold level (sensitivity) is the height of **(D)**. The bottom of **(D)** is at the baseline, and the further away **(D)** gets from baseline the less sensitive it becomes. The height/amplitude of a waveform must meet or exceed the threshold level in order to detect. Therefore, the horizontal distance of **(B)** from the baseline represents the threshold level, which is indicated by the horizontal position of the gate.

### Adjusting the Gate using the Hot Menu















DELAY:	2.934	WIDTH:	0.302
ALEN:	2.961	GAIN:	48.2
GATE:	2.787	TEMP:	----
THRESH:	11	LOG:	A001

- 1) Press the  key once to activate measure menu items. Press the  key multiple times to move right and the  key multiple times to move left until the **GATE** cell is highlighted.
- 2) Press the  and  arrow keys multiple times to scroll the highlighted value.
- 3) **Alternatively**, press the  key to display the **Digits Edit Box**.
- 4) Press the  and  arrow keys multiple times to scroll the highlighted value.
- 5) Press the  and  arrow keys multiple times to scroll the digit locations.
- 6) Repeat steps 4 & 5 until the **GATE** value is correctly displayed.
- 7) Press the  key to return to the measurement screen, or  to cancel adjusting the **GATE** start value.

The user can also access and adjust the gate from the tabbed menus. However, this method is more tedious than making the adjustments using the **Hot Menu**. The procedure using the tabbed menus is outlined below:

### Adjusting the Gate using the Tabbed menus

GATE SETTINGS	
POLARITY	NEGATIVE
GATE	2.787
THRESHOLD 1	11
TUNE	GATE AUTO SET

- 1) Press the  key once to activate the menu items tab. Press the  key multiple times to tab right and the  key multiple times to tab left until the **AUTO** menu is highlighted and displaying the submenu items.
- 2) Press the  and  arrow keys multiple times to scroll through the submenu items until **GATE** is highlighted.
- 3) Press the  and  arrow keys multiple times to scroll the value. When the correct gate is being displayed, **proceed to step 8**.
- 4) **Alternatively**, press the  key to display the **Digits Edit Box**.
- 5) Press the  and  arrow keys multiple times to scroll the highlighted value.
- 6) Press the  and  arrow keys multiple times to scroll the digit locations.
- 7) Repeat steps **5 & 6** until the gain number is correctly displayed.
- 8) Press the  key to set the **Gate** value and return to the menu screen, or  to cancel entering the **Gate** value.
- 9) Finally, press the  key to return to the measurement screen and begin taking readings.

## 12.6 Threshold













The **Threshold** is the level (sensitivity) of the signal amplitude required to trigger a detection/measurement. The higher the threshold level the lower the sensitivity. Threshold can be used in conjunction with the gain setting. Example: suppose the user is not detecting on the first cycle of the waveform because the amplitude of the first cycle does not have enough output to reach the current threshold level. Either the **Threshold** can be decreased (more sensitivity), or the **Gain** increased to detect on the first cycle. Should the auto set function not determine the optimal level, given and issue with the reflector, the threshold can be manually adjusted to override the auto setting.



The procedures to adjust the **Thresholds** are outlined below:

### Adjusting the Thresholds using the Hot Menu















DELAY:	2.958	WIDTH:	0.302
ALEN:	2.961	GAIN:	47.2
GATE:	2.813	TEMP:	----
THRESH:	12	LOG:	A001

- 1) Press the  key once to activate measure menu items. Press the  key multiple times to move right and the  key multiple times to move left, until the desired **Threshold** cell is highlighted.
- 2) Press the  and  arrow keys multiple times to scroll the highlighted value.
- 3) **Alternatively**, press the  key to display the **Digits Edit Box**.
- 4) Press the  and  arrow keys multiple times to scroll the highlighted value.
- 5) Press the  and  arrow keys multiple times to scroll the digit locations.
- 6) Repeat steps **4 & 5** until the **Threshold** value is correctly displayed.
- 7) Press the  key to return to the measurement screen, or  to cancel entering the **Threshold**.

The user can also access and adjust the **Threshold** from the tabbed menus. However, this method is more tedious than making the adjustments using **the Hot Menus**. The procedure using the tabbed menus is outlined below:

### Adjusting the Threshold using the Tabbed Menus

GATE SETTINGS	
POLARITY	NEGATIVE
GATE	2.813
THRESHOLD 1	12
TUNE	GATE AUTO SET

- 1) Press the  key once to activate the menu items tab. Press the  key multiple times to tab right, and the  key multiple times to tab left, until the **GATES** menu is highlighted and displaying the submenu items.
- 2) Press the  and  arrow keys multiple times to scroll through the submenu items until **Threshold** is highlighted.
- 3) Press the  and  arrow keys multiple times to scroll the value. When the correct threshold is being displayed, **proceed to step 8**.
- 4) **Alternatively**, press the  key to display the **Digits Edit Box**.
- 5) Press the  and  arrow keys multiple times to scroll the highlighted value.
- 6) Press the  and  arrow keys multiple times to scroll the digit locations.
- 7) Repeat steps **5 & 6** until the **Threshold** number is correctly displayed.
- 8) Press the  key to set the **Threshold** and return to the menu screen, or  to cancel entering the **Threshold**.
- 9) Finally, press the  key to return to the measurement screen and begin taking readings.

## 12.7 Interpreting the Waveform

One of the most important things to consider, when using the **BT1-DL**, is how to interpret the waveform in order to choose the proper phase (polarity) and gain setting. It's also important to understand what's taking place during a basic measurement. The user has the option of selecting the phase only once during the **L-REF** (reference length measurement). Once the phase is selected and the **L-REF** measurement taken and stored for a particular bolt, all the elongation and loads taken for that bolt will assume the sample phase/polarity. Initially, this might not seem that critical. In most cases, with well prepared bolts, this might very well be the case. While both phases may look fine at first sight, during the **L-REF** measurement, deformations in the joint can occur when a load is applied to the bolt.

When a load is applied on a bolt, the velocity of the fastener decreases. Any deformations in the joint (bending) will disrupt the sound path and potentially cause an overall decrease in signal amplitude. When this occurs, the decrease in amplitude can cause the **BT1-DL** to lose the first cycle altogether. If the first cycle is lost, the **BT1-DL** will "peak Jump" to another cycle later in time with greater amplitude. Often times transducers have a very slow ramp up time until reaching maximum energy. In other words, the amplitude of the first cycle is lower in amplitude than the second or third cycle. For this reason, selecting the proper phase is very important.

The **Auto Set** feature built into the **BT1-DL** will do a lot of this work for you. However, it's always a good idea to understand how to interpret the waveform. The following diagrams offer a brief explanation:

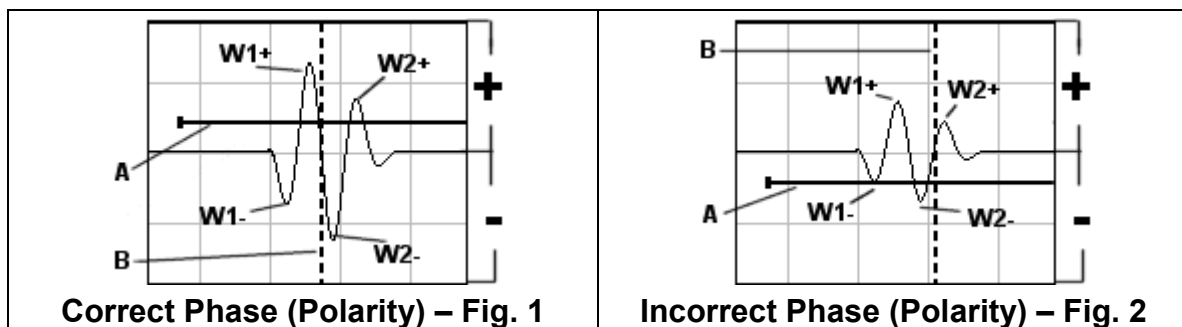

Refer to the illustrations above. The first thing to note is that the screen shots above are split into positive and negative regions. The centerline is assumed zero, and the two regions in the upper portion of the display are positive, while the two lower halves are negative. Refer to **Fig.1**. Notice that the height or amplitude of **W1+** is greater than the height of **W2+** from the zero crossing (centerline). These are the positive cycles, as they are in the upper regions. Now consider that the height of **W1-** is lower in amplitude than **W2-**. These are the negative cycles as they are in the lower regions. Keeping that in mind, the **BT1-DL** uses a zero crossing style of detection. Therefore, the detection will always occur to the right side of the positive or negative cycle being detected. With this said, the detection in **Fig.1 (B)** is occurring on the

zero crossing of the positive first cycle **W1+**. In this example, the correct (positive) polarity has been selected.

Why? I'm getting to that! Refer to **Fig.2**. Notice that when the bolt is tightened, the signal amplitude has decreased due to the applied stress, and a peak jump has occurred from **W1-** to **W2-** at **(B)**. If we look at the height of **W1-** it has a much lower amplitude than **W2-**. Therefore, when stress was applied to the bolt, the amplitude of **W1-** was decreased beyond the threshold **(A)** and the **BT1-DL** jumped to the next available signal with sufficient amplitude. However, this could never happen in **Fig.1**. This is because **W1+** has more amplitude than **W2+**, and a peak jump could never occur without losing the signal entirely.

**Good Rule of Thumb:** Always look at the height of the positive and negative cycles separately. Ask yourself if the first cycle (from left to right) is greater in height (amplitude) than the second. If so, chances are you've selected the correct phase (polarity).

If a situation does occur, as in **Fig.2** above, and you're able to notice the peak jump during the process of loading, increasing the gain or lowering the threshold will generally correct the error. However, if it goes unnoticed, all your measurements will be in error. Therefore, it's critical that the user takes the necessary time to select the proper phase in the initial setup process.

Once again, the Auto Set feature built into the **BT1-DL** will attempt to optimize and select the polarity for you. Use of this feature is further explained in the sections that follow.













## 12.8 Manually Locating the Echo

The echo can be manually located by simply adjusting the delay and width values of the **BT1-DL**. While this process is very tedious and will most often not be used because of the **Auto Set** feature, it should be explained for general control of the instrument. The following procedures outline how to locate the echo using delay and width.

### Adjusting the Delay to Locate the Echo

DELAY:	2.934	WIDTH:	0.302
ALEN:	2.961	GAIN:	48.2
GATE:	2.787	TEMP:	----
THRESH:	11	LOG:	A001





**Note:** The delay should be adjusted to a length slightly shorter than the physical length of the fastener. If the length of the fastener is unknown, the user will be forced to scroll the delay until the echo is located. However, if the Length is known, use the digits edit box to enter the value and save time.







- 1) Press the  key once to activate measure menu items. Press the  key multiple times to move right and the  key multiple times to move left, until the **DELAY** cell is highlighted.
- 2) Press the  and  arrow keys multiple times to scroll the highlighted value.
- 3) **Alternatively**, press the  key to display the **Digits Edit Box**.
- 4) Press the  and  arrow keys multiple times to scroll the highlighted value.
- 5) Press the  and  arrow keys multiple times to scroll the digit locations.
- 6) Repeat steps 4 & 5 until the **DELAY** value is correctly displayed.
- 7) Press the  key to return to the measurement screen, or  to cancel entering the **DELAY**.

### Adjusting the Width using the Hot Menu

DELAY:	2.934	WIDTH:	0.302
ALEN:	2.961	GAIN:	48.2
GATE:	2.787	TEMP:	----
THRESH:	11	LOG:	A001

**Note:** *The width acts like a zoom on a camera. Therefore, adjust the width to the desired view.*

- 1) Press the  key once to activate measure menu items. Press the  key multiple times to move right and the  key multiple times to move left, until the **WIDTH** cell is highlighted.
- 2) Press the  and  arrow keys multiple times to scroll the highlighted value.











- 3) **Alternatively**, press the  key to display the **Digits Edit Box**.
- 4) Press the  and  arrow keys multiple times to scroll the highlighted value.
- 5) Press the  and  arrow keys multiple times to scroll the digit locations.
- 6) Repeat steps **4 & 5** until the **WIDTH** value is correctly displayed.
- 7) Press the  key to return to the measurement screen, or  to cancel entering the **WIDTH**.

## 12.9 Automatic Echo Optimization (Auto Set)

The **BT1-DL** is equipped with a built in Auto Set feature for echo optimization. The **Auto Set** uses a variety of algorithms, evaluating the positive and negative and negative cycles, and selects the best phase (polarity) to use for measurement. It also optimizes the gain, sets the delay and width, and activates and sets the gate accordingly. Use of this feature will save the user a great deal of time in the measurement process. In order to use the **Auto Set** properly, an approximate length of the bolt must be entered into the **BT1-DL**. The approximate length tells the **BT1-DL** where to start looking for the echo. The **BT1-DL** will search **+/- 5%** from the value entered. The following procedures outline the **Auto Set** feature.

### Setting the Approximate Length using the Hot Menu



				68.0 DEG F			
ELONG		100V		Q:--			
ELONG		IN					
3.05652							
				06/05/19 11:42:01			
DELAY: 2.960		WIDTH: 0.302					
ALEN: 3.000		GAIN: 52.4					
GATE: 2.850		TEMP: 68.0					
THRESH: 11		LOG: A002					





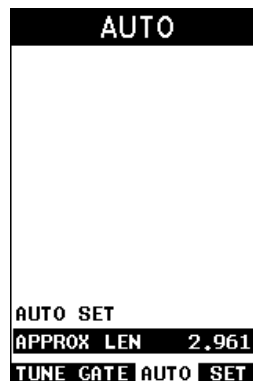



- 1) Press the  key once to activate measurement menu items. Press the  key multiple times to move right and the  key multiple times to move left, until the **ALEN** cell is highlighted.
- 2) Press the  key to display the **Digits Edit Box**.
- 3) Press the  and  arrow keys multiple times to scroll the highlighted value.
- 4) Press the  and  arrow keys multiple times to scroll the digit locations.
- 5) Repeat steps **3 & 4** until the **ALEN** value is correctly displayed.
- 6) Press the  key to return to the measurement screen, or  to cancel entering the **ALEN**.

The user can also access and set the approximate length from the tabbed menus. However, this method is more tedious than making the adjustments using the Hot Menu. The procedure using the tabbed menu is outlined below:

### Setting the Approximate Length using the Tabbed Menu



- 1) Press the  key once to activate the menu items tab. Press the  key multiple times to tab right, and the  key multiple times to tab left, until the **AUTO** menu is highlighted and displaying the submenu items.

- 2) Press the  and  arrow keys multiple times to scroll through the sub menu items until **APPROX. LEN.** is highlighted.
- 3) Press the  key to display the **Digits Edit Box**.
- 4) Press the  and  arrow keys multiple times to scroll the highlighted value.
- 5) Press the  and  arrow keys multiple times to scroll the digit locations.
- 6) Repeat steps **4 & 5** until the **Approx. Len.** value is correctly displayed.
- 7) Press the  key to set the **Approx. Len.** and return to the menu screen, or  to cancel entering the **Approx. Len.**







### Using Auto Set



**Note:** *If the Approximate length has been entered into the **BT1-DL**, the **Auto Set** feature can be run simply by pressing the **AUTO SET** key at the bottom left of the keypad.*





- 1) Press the  key once to activate the menu items tab. Press the  key multiple times to tab right, and the  key multiple times to tab left, until the **UTIL** menu is highlighted and displaying the submenu items.
- 2) Press the  and  arrow keys multiple times to scroll through the submenu items until **AUTO SET** is highlighted.
- 3) Apply a drop of couplant to the bolt or transducer, and attach it to one end of the bolt. Rotate the transducer clockwise and counter clockwise applying a small amount of pressure to eliminate any excess couplant between the transducer and bolt surface. *Be sure to always place the transducer in the same location. This will help to eliminate any potential measurement errors caused by changing the sound path.*
- 4) Press the  key to automatically adjust the display settings and bring the waveform into view.
- 5) Once the signal is displayed, press the  key to return to measurement mode.

## 12.10 Unloaded Length and Elongation Measurements

The entire procedure to effectively prepare, setup, and measure is located in the quick start guide in Chapter Two. Please refer to this section for further instructions.

## CHAPTER THIRTEEN ADDITIONAL FEATURES

### 13.1 Quality/Correlation (Transducer Placement)

The auto correlation feature in the **BT1-DL** is a handy feature to assist the user with returning the transducer back to the original position/location where it was during the initial reference length measurement. Since the sound path is changing, in terms of material consistency, returning the transducer to the same location increases the accuracy of the **BT1-DL**, reducing what is referred to as the “placement error”.

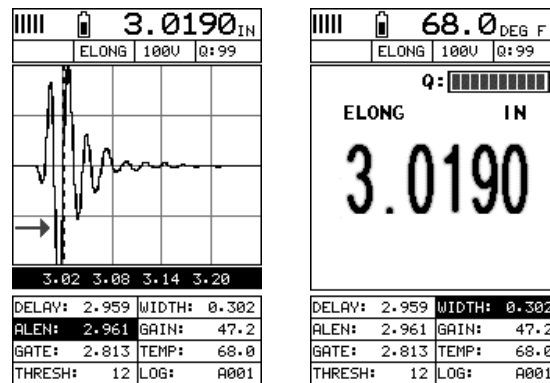

This feature is automatically activated after a reference length is measured and stored, columns B-ZZ. The initial reference length waveform will be grayed out in the background behind the active waveform after moving to one of the columns noted above. The transducer should be placed back in the original estimated position as it was during the initial length measurement. Rotate the transducer clockwise and counter clockwise, making small movements of the transducer position until the active wave matches the symmetry of original wave, and all the while watching the quality indicator (Q) as it approaches 100% match. Once the wave symmetries, and quality indicator, are as close to 100% as possible the user should slightly increase/decrease the gain until the peaks of both waves are at the same level, or amplitude. You'll notice the quality indicator will continue to approach 100% as the gain is adjusted, though may never perfectly achieve the 100% level. However, the primary objective is to return transducer to a position as close to the original location as possible, and achieve a correlated match.

### 13.2 Lock System Zero







The system delay (zero) is stored with every custom setup file created and saved. The value saved is whatever the current zero value setting is at that time, and can be reviewed in the CAL menu. The lock feature has been added as an option to lock the current zero setting in the CAL menu, not allowing the zero value stored in a setup file to overwrite current value in the calibration menu.

**Lock Sys Zero**

```

CALIBRATE
-----
ZERO MODE TWO POINT
ZERO          -234.56
MEASURE ZERO
LOCK SYS ZERO  OFF
LOAD CAL MODE  OFF
LOAD CAL CALC
CAL  MATL GEOM DISP

```

- 1) Press the  key once to activate the menu items tab. Press the  key multiple times to tab right, and the  key multiple times to tab left, until the **CAL** menu is highlighted and displaying the submenu items.
- 2) Press the  and  arrow keys multiple times on the right button wheel to scroll the **LOCK SYS ZERO** value on/off.
- 3) Finally, press the  key to return to the measurement screen and begin taking readings.

**Note:** When a custom setup file is recalled and opened, the following warning screen will be displayed.

```

WARNING!
-----
SYSTEM ZERO LOCKED
VALUES NOT LOADED
-----
OK      ESC

```









**13.3 Contrast**

The **BT1-DL** is equipped with a contrast feature to adjust the display visibility in different light conditions. It has an arbitrary scale with a values from 1-20, with 20

representing the darkest setting. The procedure for adjusting the **Contrast** is outlined below:

**Adjusting Contrast**

SET DISPLAY	
VIEW	DIGITS
<b>CONTRAST</b>	<b>10</b>
BACKLIGHT	OFF
DELAY	2.959
WIDTH	0.302
RECT WAVE	FILLED
DETECT MARK	DOTS
CAL	MATL GEOM DISP









- 1) Press the  key once to activate the menu items tab. Press the  key multiple times to tab right and the  key multiple times to tab left until the **DISP** menu is highlighted and displaying the submenu items.
- 2) Press the  and  arrow keys multiple times to scroll through the submenu items until **CONTRAST** is highlighted.
- 3) Press the  and  arrow keys multiple times to scroll the **CONTRAST** value.
- 4) Finally, press the  key to return to the measurement screen and begin taking readings.

### 13.4 Backlight

The **BT1-DL** has an EL backlit display with the setting options: off, on, auto, invert (inverted) to for various light conditions. The procedure for enabling the **Backlight** is as follows:

#### **Enabling the Backlight**

SET DISPLAY	
VIEW	DIGITS
CONTRAST	10
<b>BACKLIGHT</b>	<b>ON</b>
DELAY	2.959
WIDTH	0.302
RECT WAVE	FILLED
DETECT MARK	DOTS
<b>CAL</b>	<b>MATL</b>
<b>GEOM</b>	<b>DISP</b>

- 1) Press the  key once to activate the menu items tab. Press the  key multiple times to tab right and the  key multiple times to tab left until the **DISP** menu is highlighted and displaying the submenu items.
- 2) Press the  and  arrow keys multiple times to scroll through the submenu items until **BACKLIGHT** is highlighted.
- 3) Press the  and  arrow keys multiple times to scroll the **BACKLIGHT** options.
- 4) Finally, press the  key to return to the measurement screen and begin taking readings.

### 13.5 Graphics Options (look & feel)

The **BT1-DL** has a few graphical 'look and feel' options to accommodate user preference. These features only serve as cosmetic items and do not change the functionality of the **BT1-DL** in any way.

#### RECT Wave:

The rectified wave feature is only functional when using **RECT** wave view, and provides the user the following display options:

**Outline** – Draws the unfilled outline of the waveform.

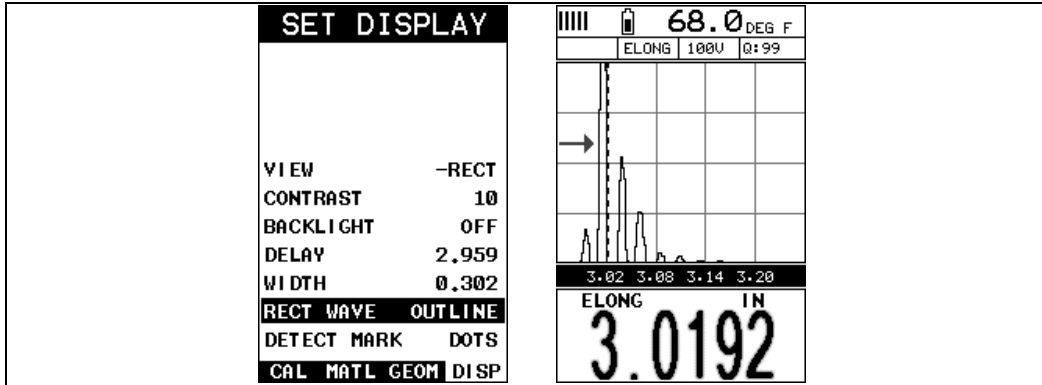

**Filled** – Draws a filled version of the waveform.

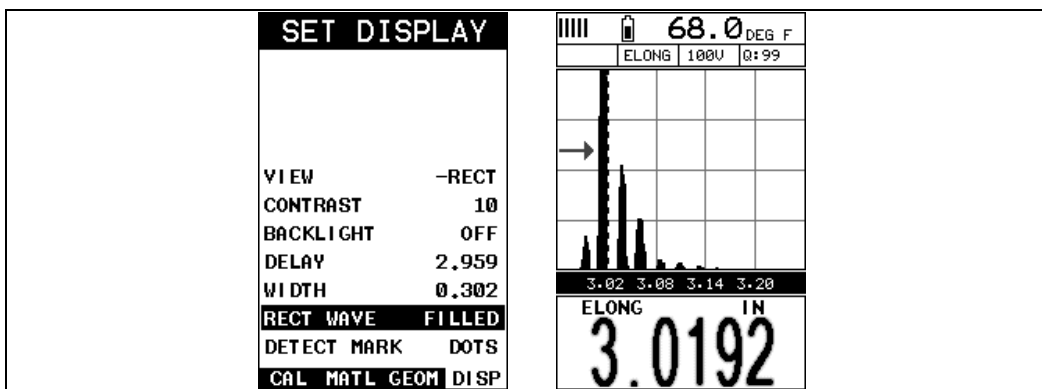

**Detect Mark:**

The detect mark is another look and feel option for displaying the detection indicator.

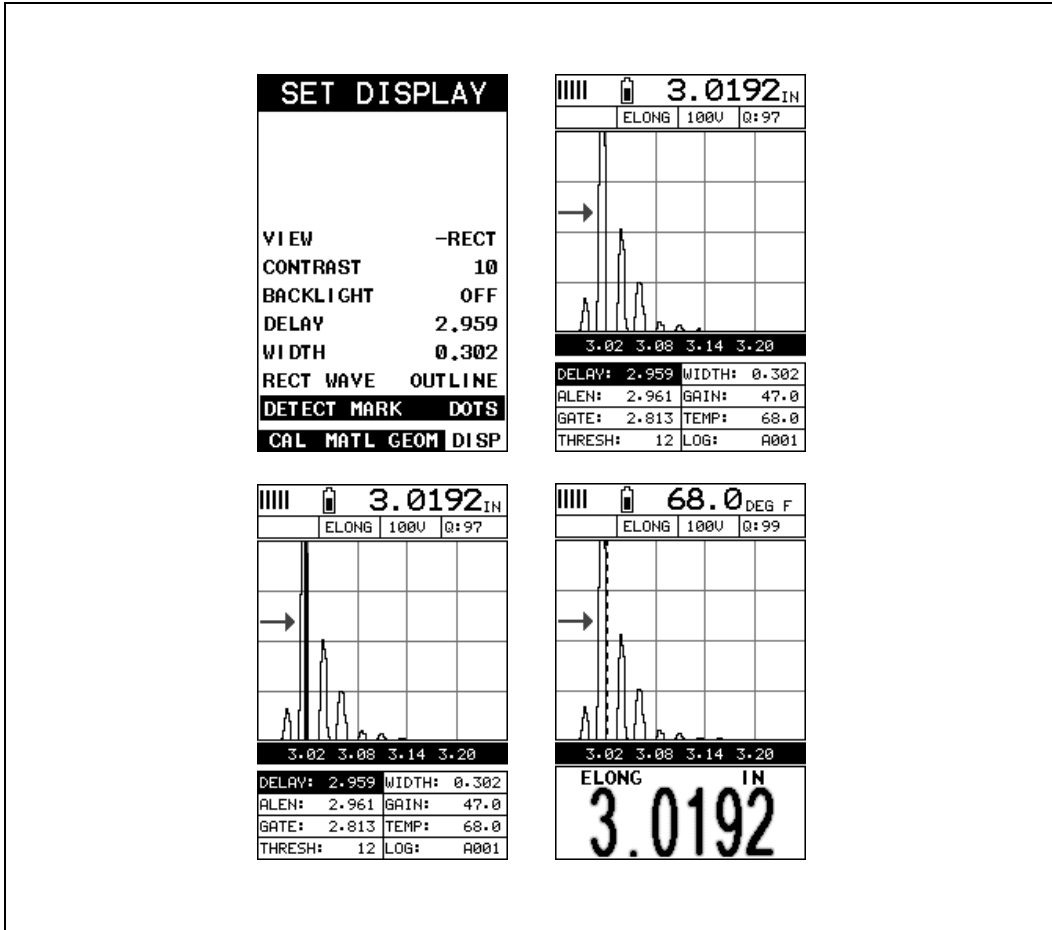









### 13.6 Pulse

The **BT1-DL** has a 200 volt square wave pulser. Pulse width, refers to the duration of time the pulser is left on. This time results in increased energy sent into the fastener. There are three pulse width options (**SPIKE**, **THIN**, and **WIDE**), with adjustable pulser voltages of 100, 150 and 200 volts. Longer bolts with attenuative material may be optimized best using the 200 volt setting with a wide pulse width, while shorter fasteners best optimized using a 100 volt setting with a spike pulse width option. The procedure to change the pulse width is outlined below:

### Selecting the Pulse Width

TUNE SIGNAL	
<b>PULSE</b>	<b>THIN</b>
PULSER VOLTAGE	100
DAMPING	50
GAIN	51.0
GAIN STEP	1.0
DIGITIZER	4X
TUNE GATE	AUTO SET

- 1) Press the  key once to activate the menu items tab. Press the  key multiple times to tab right and the  key multiple times to tab left until the **TUNE** menu is highlighted and displaying the submenu items.
- 2) Use the  and  arrow keys multiple times to scroll through the sub menu items until **PULSE** is highlighted.
- 3) Use the  and  arrow keys multiple times to scroll the **Pulse** options.
- 4) Once the **Pulse** is displayed, press the  key to return to the measurement screen.









### 13.7 Pulser Voltage

The **BT1-DL** has a 200 volt square wave pulser that can be adjusted for specific bolt lengths, geometries, materials, transducer size and frequencies. The Pulser Voltage feature offers various voltage settings of 100, 150 & 200 volts. Lower voltage selections are best for short small diameter bolts, while higher voltage are best for longer bolts with attenuative or inconsistent materials. The procedure to change the pulser voltage is outlined below:

#### Changing the Pulser Voltage



TUNE SIGNAL	
PULSE	THIN
<b>PULSER VOLTAGE</b>	<b>100</b>
DAMPING	1500
GAIN	47.0
GAIN STEP	1.0
DIGITIZER	4X
TUNE	GATE AUTO SET









- 1) Press the  key once to activate the menu items tab. Press the  key multiple times to tab right and the  key multiple times to tab left until the **TUNE** menu is highlighted and displaying the submenu items.
- 2) Use the  and  arrow keys multiple times to scroll through the submenu items until **PULSER VOLTAGE** is highlighted.
- 3) Use the  and  arrow keys multiple times to scroll the **Pulser Voltage** options.
- 4) Once the desired **Pulser Voltage** is displayed, press the  key to return to the measurement screen.

### 13.8 Damping

The **BT1-DL** has a built-in damping feature to control the impedance input of the receiver. This enables the user the ability to match and optimize the transducer for better signal quality at various frequencies. The available settings are 50, 75, 100, 300, 600 and 1500 ohms. The procedures below outline the steps for selecting an impedance setting, as follows:

#### Setting the Damping Value

TUNE SIGNAL	
PULSE	THIN
PULSER VOLTAGE	100
<b>DAMPING</b>	<b>300</b>
GAIN	47.0
GAIN STEP	1.0
DIGITIZER	4X
TUNE GATE	AUTO SET









- 1) Press the  key once to activate the menu items tab. Press the  key multiple times to tab right, and the  key multiple times to tab left, until the **TUNE** menu is highlighted and displaying the submenu items.
- 2) Use the  and  arrow keys multiple times to scroll through the sub menu items until **DAMPING** is highlighted.
- 3) Use the  and  arrow keys multiple times to scroll through the **DAMPING** values until the correct value is displayed.
- 4) Finally, press the  key to return to the measurement screen and begin taking readings.

### 13.9 Digitizer

The digitizer feature provides additional stability to the measurement by increasing the number of samples. This can be beneficial when measuring shorter length fasteners with units set to in/mm hr (high resolution), in order to increase the resolution. The reverse scenario also then applies to longer length fasteners, not requiring the increased sample size/shots. The digitizer has three setting options of 1, 2, 4x, with 4x providing the highest number of samples/shots. It should be noted that increasing the digitizer sample slows down the update speed. For shorter bolts, this won't be as noticeable as using a 4x digitizer setting for longer bolts. The procedure to change the digitizer setting is outlined below:

#### Setting the Digitizer

TUNE SIGNAL	
PULSE	THIN
PULSER VOLTAGE	100
DAMPING	300
GAIN	47.0
GAIN STEP	1.0
<b>DIGITIZER</b>	<b>4X</b>
TUNE	GATE AUTO SET

- 1) Press the  key once to activate the menu items tab. Press the  key multiple times to tab right and the  key multiple times to tab left until the **TUNE** menu is highlighted and displaying the submenu items.
- 2) Use the  and  arrow keys multiple times to scroll through the submenu items until **DIGITIZER** is highlighted.
- 3) Use the  and  arrow keys multiple times to scroll the **DIGITIZER** options.
- 4) Once the desired **DIGITIZER** setting is displayed, press the  key to return to the measurement screen.









### 13.10 Polarity

Refer to section 12.7, interpreting the Waveform, for a detailed explanation on how to select the proper polarity. It's also important to note that the **BT1-DL** auto set feature will automatically select and set the polarity, but it's important to review, understand, and check that **BT1-DL** selected the proper polarity. The user may choose to manually override the initial selection. The following procedures are the necessary steps to change the polarity only.

#### Toggle Polarity (+/-)

GATE SETTINGS	
POLARITY	NEGATIVE
GATE	2.850
THRESHOLD 1	10
TUNE	GATE AUTO SET

**Note:** Before toggling the **Polarity**, the **BT1-DL** should be set to the **RF** display view option. The **RF** view will give the user the best opportunity to correctly view the positive and negative cycles of the waveform. Please refer section 12.2 for information on selecting the **Display Views**.

- 1) Press the  key once to activate the menu items tab. Press the  key multiple times to tab right, and the  key multiple times to tab left, until the **TUNE** menu is highlighted and displaying the submenu items.
- 2) Use the  and  arrow keys multiple times to scroll through the submenu items until **POLARITY** is highlighted.
- 3) Use the  and  arrow keys multiple times to toggle the **POLARITY** negative or positive.
- 4) Press the  key to return to the measurement screen and begin taking readings.

### 13.11 Alarm Mode







The **Alarm Mode** feature of the **BT1-DL** provides the user with a method of setting tolerances, or limits, for a particular fastener. This feature may be used for a variety of applications to verify the stretch on a fastener is within predetermined tolerances. There are two limits, or alarm values, that can be setup in the **BT1-DL – ALARM LOW** and **ALARM HIGH** limits. However, the user may choose to activate and utilize only one of the limit values, depending on their specific application requirements.

**Note:** The alarm feature can also be used in conjunction with an accessory high speed shutoff box that is wired into the power of the pump and will shutdown the pump when inside of the alarm limit values.

The procedures to use the **ALARM MODE** feature are outlined below:

### Toggle Alarm (on/off)



UTILITIES	
TEMP MODE	MANUAL
<b>ALARM</b>	<b>ON</b>
ALARM LOW	0.0050
ALARM HIGH	0.0150
KEY CLICK	QUIET
SET DATE	YYMMDD
SHOW DATE	OFF
DATA UTIL XFER	

- 1) Press the  key once to activate the menu items tab. Press the  key multiple times to tab right, and the  key multiple times to tab left, until the **UTIL** menu is highlighted and displaying the submenu items.
- 2) Use the  and  arrow keys multiple times to scroll through the submenu items until **ALARM** is highlighted.
- 3) Use the  and  arrow keys multiple times to toggle the **ALARM** on/off/audible.
- 4) Continue on to the next section “**Setting the Alarm Low Limit**”.





### Setting the Alarm Low Limit

UTILITIES	
TEMP MODE	MANUAL
ALARM	ON
<b>ALARM LOW</b>	<b>0.0050</b>
ALARM HIGH	0.0150
KEY CLICK	QUIET
SET DATE	YYMMDD
SHOW DATE	OFF
DATA	UTIL XFER

UTILITIES	
TEMP MODE	MANUAL
ALARM	ON
ALARM LOW	0.0050
<b>ALARM HIGH</b>	<b>0.0150</b>
KEY CLICK	QUIET
SET DATE	YYMMDD
SHOW DATE	OFF
DATA	UTIL XFER

- 1) Assuming the **ALARM** is **ON**, press the  and  arrow keys multiple times to scroll through the sub menu items until **ALARM LOW** is highlighted.
- 2) Press the  key to display the **Digits Edit Box**.

ALARM LOW	ALARM HIGH
<b>0.0050</b>	<b>0.0150</b>
OK	OK
ESC	ESC









- 3) Press the  and  arrow keys multiple times to scroll the highlighted value.
- 4) Press the  and  arrow keys multiple times to scroll the digit locations.
- 5) Repeat steps **3 & 4** until the **ALARM LOW** value is correctly displayed.
- 6) If only one limit will be used, press the  key to return to the measurement screen and begin taking readings. Otherwise, repeat the steps outlined above to set the **ALARM HIGH** limit.

### 13.12 Key Click

When a key is pressed on the **BT1-DL** keypad, the user can control whether or not an audible beep is sounded and at what volume level, if any. The procedure for this feature/preference is outlined below:

**Setting the Key Click**

UTILITIES	
TEMP MODE	MANUAL
ALARM	ON
ALARM LOW	0.0050
ALARM HIGH	0.0150
<b>KEY CLICK</b>	<b>QUIET</b>
SET DATE	YYMMDD
SHOW DATE	OFF
<b>DATA UTIL XFER</b>	





- 1) Press the  key once to activate the menu items tab. Press the  key multiple times to tab right and the  key multiple times to tab left until the **UTIL** menu is highlighted and displaying the submenu items.
- 2) Use the  and  arrow keys multiple times to scroll through the submenu items until **KEY CLICK** is highlighted.
- 3) Use the  and  arrow keys multiple times to toggle the **KEY CLICK** loud/quiet/off.
- 4) Press the  key to return to the measurement screen.

### 13.13 Date & Time







The **BT1-DL** is equipped with an internal clock to time and date stamp the log, setup and screen capture files for reporting/documentation purposes. The procedures for setting the time and date are outlined below:

#### **Setting Date & Time**

UTILITIES	
TEMP MODE	MANUAL
ALARM	ON
ALARM LOW	0.0050
ALARM HIGH	0.0150
KEY CLICK	QUIET
SET DATE	MMDDYY
SHOW DATE	OFF
DATA UTIL XFER	

- 1) Press the  key once to activate the menu items tab. Press the  key multiple times to tab right and the  key multiple times to tab left until the **UTIL** menu is highlighted and displaying the submenu items.
- 2) Use the  and  arrow keys multiple times to scroll through the submenu items until **SET DATE** is highlighted.

ENTER DATE AND TIME	
03/18/19	
08:54:41	
OK	ESC

- 3) Press the  key to display the **Digits Edit Box**.
- 4) Press the  and  arrow keys multiple times to scroll the values.
- 5) Press the  and  arrow keys multiple times to scroll the fields.
- 6) Repeat steps **4 & 5** until the **Time & Date** is correctly displayed.
- 7) Press the  key to set the **Time & Date** and return to the menu screen, or  to cancel entering the **Time & Date**.



- 8) Finally, press the  key to return to the measurement screen and begin taking readings.

### 13.14 Upgrade Gauge





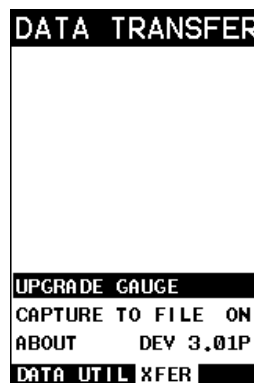

The **BT1-DL** can be upgraded very conveniently at your desk or in the field. The latest version of firmware can be found on the Dakota website, which can be compared to the current version loaded in the **BT1-DL**. The version is displayed to the right of the ABOUT menu item in the XFER menu.

With the USB cable connected to your PC, the gauge folder open, the latest firmware file downloaded to your desktop and copied into the **BT1-DL** file folder, the procedure to upgrade is outlined below:

**Note:** The firmware file extension is *.bch*, and there can only be one *.bch* file in the **BT1-DL** folder. Simply delete the old *.bch* file, or rename the extension prior to copying the new file in the **BT1-DL** folder.

#### Upgrading the BT1-DL



- 1) Press the  key once to activate the menu items tab. Press the  key multiple times to tab right and the  key multiple times to tab left until the **XFER** menu is highlighted and displaying the submenu items.
- 2) Use the  and  arrow keys multiple times to scroll through the sub menu items until **UPGRADE GAUGE** is highlighted.
- 3) Press the  key to display the file name of the new firmware just copied.

4) Press the  key to start the upgrade process.

**Note:** The gauge will power itself off, and start upgrading indicated by the red & green alarm lights periodically flashing. When the upgrade is completed, the lights will stop flashing. **DO NOT LOSE POWER!** Be sure the **BT1-DL** has plenty of battery life prior to upgrading, or the gauge is powered via PC or AC adaptor.

### 13.15 Freeze & Capture



The **BT1-DL** capture feature enables a user to immediately take a snapshot of what currently displayed on the screen and save it to a file. Each snapshot can be individually named and stored as a **.tif** (tagged image) file. This can be opened using any graphics viewer. With the storage capacity of the **BT1-DL** at 4GB, the user can store as many screens shots as needed.





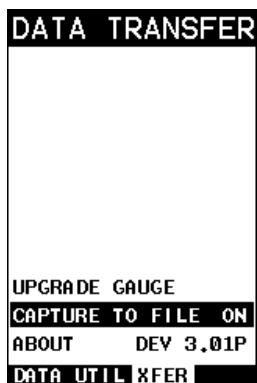











**Note:** This feature can be used to capture all lists, menus, and active waveforms for use in documentation, presentations and training materials.

The procedure to freeze and capture the display is outlined below:

#### Capturing Screen Shots



1) Press the  key once to activate the menu items tab. Press the  key multiple times to tab right and the  key multiple times to tab left until the **XFER** menu is highlighted and displaying the submenu items.

- 2) Use the  and  arrow keys multiple times to scroll through the sub menu items until **CAPTURE TO FILE** is highlighted.
- 3) Use the  and  arrow keys to toggle the **CAPTURE** on/off. **Note:** *Capture will be displayed in a toolbar cell on the active display, indicating the feature is enabled.*
- 4) Press the  key to return to the measurement screen.
- 5) To capture a file, press the  key to display the list box.
- 6) Use the  and  arrow keys to scroll through the list items until **CAPTURE TO FILE** is highlighted.
- 7) Press the  key to activate the **Alpha Edit Box**.
- 8) Press the     arrow keys to scroll to the appropriate alpha characters.
- 9) Press the  key to select a character and advance to the next field of the **Name**.
- 10) Use the  key to backspace if necessary.
- 11) Repeat steps 8 - 9 until the **Name** is completed.
- 12) Press the  key to save the **Name** and return to the screen just captured, or  to cancel entering the **Name**.





### 13.16 Capture Viewer

The capture viewer enables a user to view any of the saved screen captures on the SD card, using the **BT1-DL**. This is handy if a PC isn't available, but the user has a need to review the screen shots captured.

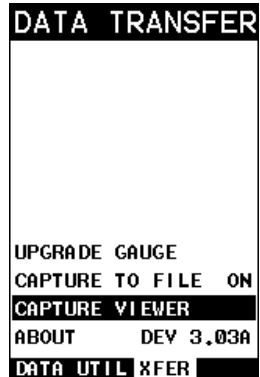



The procedure to capture the last screen displayed is outlined below:

#### Using the Viewer

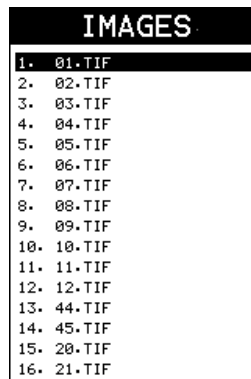

- 1) Press the  key once to activate the menu items tab. Press the  key multiple times to tab right and the  key multiple times to tab left until the **XFER** menu is highlighted and displaying the submenu items.
- 2) Press the  and  arrow keys until **CAPTURE VIEWER** is highlighted.



- 3) Press the  key to display the list of images saved on the SD card.
- 4) Use the  and  arrow keys to scroll through the list until the desired image name is highlighted.
- 5) Press the  key to display the image.
- 6) Press the  key to return to the measurement screen.

## CHAPTER FOURTEEN DATA STORAGE – SETUP, EDIT, & VIEW FILES

### 14.1 Introduction to a Project

A project is a folder or directory that can contain multiple data groups (files) for a specific job/site/other. The **BT1-DL** always contains one “default” project that can contain as many groups as needed. In other words, if a project was never created, the BT1-DL will automatically continue to store all data groups in the “default” project folder.

In order to keep data groups better organized according to a specific jobsite, or location at a jobsite, a project folder/directory can be created for a specific customer, jobsite, or jobsite location. Multiple projects can be created and used to keep better track of the data. Additionally, multiple group templates with the same file names can be stored and separated by using the individual project folders, and eliminating the need for creating multiple file names for the same group.



### 14.2 Creating a Project Folder/Directory

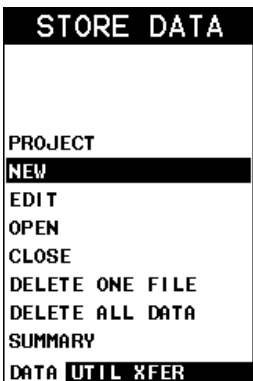

The following procedure outlines the steps to create a new project folder to store group data as follows:

**Creating a Group**





```
STORE DATA
PROJECT
NEW
EDIT
OPEN
CLOSE
DELETE ONE FILE
DELETE ALL DATA
SUMMARY
DATA UTIL XFER
```





1) Press the  key once to activate the menu items tab. Press the  key multiple times to tab right and the  key multiple times to tab left until the **DATA** menu is highlighted and displaying the submenu items.

- 2) Press the  and  arrow keys until **NEW** is highlighted.
- 3) Press the  key to display the new **Group List Items**.

NEW BOLT GROUP	
PROJECT	
NAME:	
NOTE:	
NUM BOLTS	1
NUM READS	1
START BOLT	1
INCR DIR:	NONE
CREATE GRID	

- 4) Use the  and  arrow keys to scroll through the list until **PROJECT** is highlighted.
- 5) Press the  key to activate the **Alpha Edit Box**.

PROJECT NAME									
0	1	2	3	4	5	6	7	8	9
!	'	#	/	.	-	(	)		
A	B	C	D	E	F	G	H	I	J
K	L	M	N	O	P	Q	R	S	T
U	V	W	X	Y	Z				
DAKOTA JOBSI									
OK					ESC				

- 6) Press the , , ,  arrow keys to scroll to the appropriate alpha characters.
- 7) Press the  key to select a character and advance to the next field.

**Note:** Use the **CLR** key to backspace if necessary.

- 8) Repeat steps 6 - 7 until the **PROJECT** name is completed.
- 9) Press the  key to return to the **Group List Items** menu, or **ESC** to cancel entering the **Project Name**.







**Note:** New project folders can additionally be created using a PC. Simply connect the **BT1-DL** to the PC, navigate to the USB drive, or SD card and create new folders.

### 14.3 Viewing & Opening a Project Folder



The following procedure outlines the steps to review and open a project currently stored in the **BT1-DL** as follows:

**Projects**



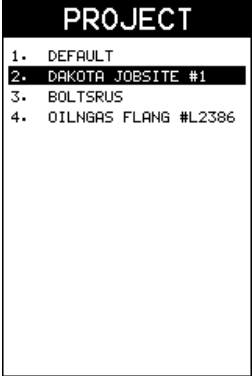

- 1) Press the  key once to activate the menu items tab. Press the  key multiple times to tab right and the  key multiple times to tab left until the **DATA** menu is highlighted and displaying the submenu items.
- 2) Press the  and  arrow keys until **PROJECT** is highlighted.
- 3) Press the  key to display the list of projects.

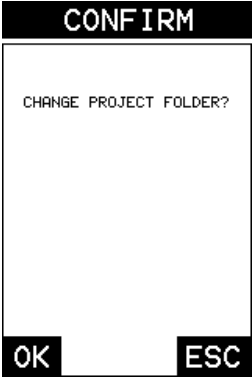

4) Use the  and  arrow keys to scroll through the list until the desired **PROJECT** is highlighted.



5) Press the  key to display the confirmation screen.

6) Press the  key to open the **PROJECT** folder, or **ESC** to cancel changing the folder.

#### 14.4 Introduction to Group (spreadsheet) format

Data is stored in the **BT1-DL** in a spreadsheet like format called a **GRID**. A **GRID** is simply a table of readings. In the case of the **BT1-DL** they will be discussed in terms of a **GROUP**. The location in a group is specified by giving a row and column coordinate. The rows are numbered from 1 to 99 and the columns are labeled from A to Z, then AA to ZZ giving a maximum of 51 possible columns.

The largest single grid that can be created in the **BT1-DL** can contain **250** bolts, **1** unloaded length (**L-REF**), and **51** elongations. Multiple groups can be created and stored until the **BT1-DL**'s memory is full, which is a massive amount. If the user attempts to store a grid in the **BT1-DL** when the memory is full, the **BT1-DL** will respond with an error message indicating that the memory is unable to store the new group.



The **BT1-DL** can store a great deal of data, considering there is a 4 GB internal SD card on the board, as well as an external SD slot that will accept up to 64 GB cards. It's not likely a user will get close to using all the memory in this gauge. Each measurement stored can be consider a page of data, as it stores the measurement, snapshot of the waveform, and all the settings of the **BT1-DL** at the time the measurement was stored. The display views and quantities can be toggled for each and every possible option of the **BT1-DL**, provided that the correct factors have been entered into the gauge and are being used. To make this as clear as possible, the Display Views (RF, RECT, and DIGITS) can be toggled with any stored measurement. Additionally, the Quantities (Time, Elongation, Load, Stress, and %Strain) can be toggled with any stored measurement. It's clear that the data recordation of **BT1-DL** is an extremely powerful tool for purposes of documentation.

### 14.5 Creating a new Group







**Important Note:** *This entire section is a step by step guide to successfully create a group.* The instructions must be used in the sequential order specified, as follows:

NEW BOLT GROUP	
NAME:	BOLTS-R-US
NOTE:	
NUM BOLTS	1
NUM READS	1
START BOLT	1
INCR DIR:	NONE
CREATE GRID	



In order to eliminate too much redundancy with multiple pass of the same exact steps for each of the group list items, the following procedure will be listed once below. This process can be repeated for the name, note, number of bolts, number of reads, starting bolt number, and the increment direction using the procedure below:

### Creating a Group



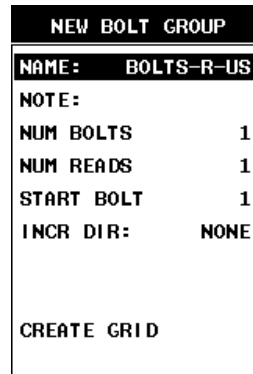







- 1) Press the  key once to activate the menu items tab. Press the  key multiple times to tab right, and the  key multiple times to tab left, until the **DATA** menu is highlighted and displaying the submenu items.
- 2) Use the  and  arrow keys multiple times to scroll through the submenu items until **NEW** is highlighted.
- 3) Press the  key to display the new **Group List Items**.







- 4) Use the  and  arrow keys multiple times to scroll through the new **Group List Items** until **NAME, NOTE, NUM. BOLTS, NUM. READS, START BOLT, or INCR DIR** is highlighted.
- 5) Press the  key to activate the **Alpha Edit Box**.

LOG NAME											
0	1	2	3	4	5	6	7	8	9		
!	"	#	\$	%	&	'	(	)	*	+	,
A	B	C	D	E	F	G	H	I	J		
K	L	M	N	O	P	Q	R	S	T		
U	V	W	X	Y	Z						
BOLTS-R-US											
OK						ESC					

- 6) Press the     arrow keys to highlight the appropriate alpha/numeric characters.
- 7) Press the  key to select a character and advance to the next field.
- Note:** Use the  key to backspace if necessary.
- 8) Repeat steps 6 - 7 until the **NAME, NOTE, NUM. BOLTS, NUM. READS, START BOLT, or INCR DIR** is completed.
- 9) Press the  key to return to the **Group List Items** menu, or  to cancel entering the **Group Name**.
- 10) When all the items have been completed, continue on to the next section **“Saving the Group”**.

### Saving the Group

NEW BOLT GROUP	
NAME:	BOLTS-R-US
NOTE:	1/2 5MHZ
NUM BOLTS	1
NUM READS	1
START BOLT	1
INCR DIR:	NONE
CREATE GRID	







- 1) Press the  and  arrow keys multiple times to scroll through the new **Group List Items** until **CREAT GRID** is highlighted.
- 2) Press the  key to display **CREATE GRID** confirmation screen.
- 3) Press the  key to save the group and return to the measurement screen.

## 14.6 Storing a reading

Now that a group has been created, it's time to make some measurements and store the measurements. The following procedures outline this process:

### Storing a Reading





**Note:** *Once the group has been created it will automatically be displayed as a grid following the create confirmation screen. It is located at the bottom of the measurement screen and can be left open for the duration of the inspection process. This section assumes the group was just created. Refer to the section on “opening a group” if the file was created at another time.*



**Key Feature:** When the **BT1-DL** is displaying a “group”, pressing the  key will initiate an advance to row number option screen. Use the     arrow keys to enter the row number. Once the row number is correctly displayed, press the  key to advance directly to that row number in the group.

**Key Feature:** When the **BT1-DL** is displaying a “group”, pressing the  key multiple times will toggle through the display options: **DIGITS**, **RF**, and **RECT** views.

NAME: BOLTS R US			
	A	B	C
1	4.01493		
2	3.05655	0.00000	
3			

### Group Log

- 1) Press the     arrow keys to move the target cell cursor to the desired storage location.
- 2) Press the  key to save the current reading in the highlighted cell location. It's as simple as that!

**Note:** The Group Log can be hidden at any time by pressing the  key. However, in order to display it again, the hot menu item **LOG** must be highlighted. When **LOG** is highlighted, press the  key to display the group.



**Note:** Once the file is open, it will remain open until it's closed or another file is opened by the user. If the gauge is powered off, the **BT1-DL** will automatically open the file when powered on. Simply press the  key to display the file from the measurement screen.

## 14.7 Viewing stored readings

It is sometimes necessary to go back and view the stored readings and waveforms using the **BT1-DL** without a PC. The following procedures outline this process:

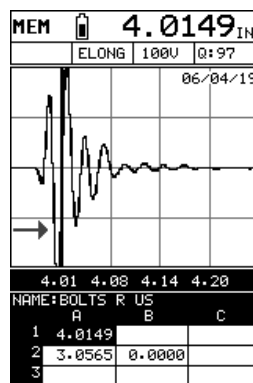



### Viewing Stored Readings





1) Press the  key once to activate measurement menu items. Press the  key multiple times to move right and the  key multiple times to move left until the **LOG** cell is highlighted.

2) Press the  key to display the **Grid Log Box**.

NAME	BOLTS	R	US
A	B	C	
1	4.01493		
2	3.05655	0.00000	
3			

3) Press the     arrow keys to scroll the stored readings and corresponding display view. Notice as the cursor is moved to a different cell, the display will be updated with the display view saved with the reading. Readings stored in memory are indicated by displaying a **MEM** in the top left corner of the measurement screen.



**Note:** The user may opt to clear a specific reading and save a new one at any time. Press the  key in the appropriate cell location to clear the reading, take a new measurement, and press the  key to save the new reading.

4) Hide the Group View at any time by pressing the  key.



## 14.8 Deleting Groups (Files)

### Deleting One or All Files from Memory





#### Deleting One File

- 1) Press the  key once to activate the menu items tab. Press the  key multiple times to tab right and the  key multiple times to tab left until the **DATA** menu is highlighted and displaying the submenu items.

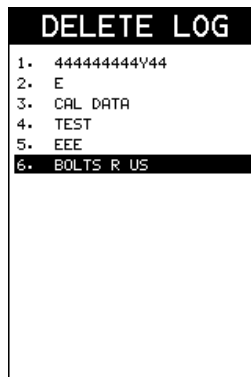



- 2) Use the  and  arrow keys to scroll through the sub menu items until **DELETE ONE FILE** is highlighted.





- 3) Press the  key to display the **File List Box**.
- 4) Use the  and  arrow keys to scroll through the stored **Files** until the target **File** to delete is highlighted.
- 5) Press the  key to delete the **File**.
- 6) Press the  key to return to the measurement screen.





### Deleting All Data

- 1) Press the  key once to activate the menu items tab. Press the  key multiple times to tab right and the  key multiple times to tab left until the **DATA** menu is highlighted and displaying the submenu items.

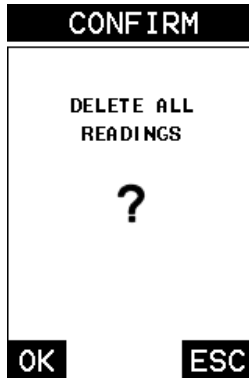

- 2) Use the  and  arrow keys to scroll through the sub menu items until **DELETE ALL DATA** is highlighted.



- 3) Press the  key to activate the confirmation screen.
- 4) Press the  key to delete **All Files** from memory, or the  key to abort.
- 5) Press the  key to return to the measurement screen.













## 14.9 Editing a Group (File)

Once a grid has been created and saved to memory, the user can edit the **Name**, **Comments**, or **Increment Direction** at a later time. The following procedures outline this process:







### Editing a Grid

LOG NOTE	
DATE:	06/04/19
NOTE: 1/2 5MHZ SER#	
JOB:	GOLDEN GATE
OPER:	JOHNNY BOLT
COM1:	JOB WENT OK
COM2:	VIEW WAS
COM3:	BETTER
COM4:	



- 1) Press the  key once to activate the menu items tab. Press the  key multiple times to tab right and the  key multiple times to tab left until the **DATA** menu is highlighted and displaying the submenu items.
- 2) Use the  and  arrow keys to scroll through the sub menu items until **EDIT** is highlighted.
- 3) Press the  key to display the **Edit List Box**.
- 4) Use the  and  arrow keys to scroll through the **Edit** options until **NAME**, **NOTE** or **INCR. DIR** is highlighted.

**Note:** If editing the **INCR. DIR**, simply press the  and  arrow keys to scroll **NONE**, **NORTH**, **EAST**, **SOUTH**, **WEST** for a Grid, or **INC**, **DEC** for a Seq Log. **Proceed to step 10.**

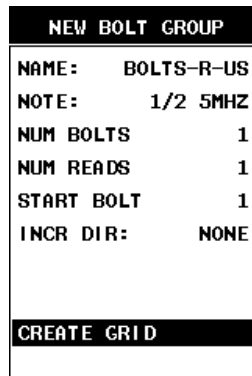

- 5) Press the  key to activate the **Alpha Edit box – Only used when editing the NOTE.**
- 6) Use the     arrow keys to highlight the appropriate alpha characters.
- 7) Press the  key to select a character and advance to the next field of the **Comments.**
- 8) Use the  key to backspace if necessary.
- 9) Repeat steps 6 - 8 until the **Comments** are completed.





- 10) Press the  and  arrow key to highlight **SAVE CHANGES**, and the  key to activate the confirmation screen.

DATA LOG

OVERWRITE  
CURRENT  
GROUP

?

OK
ESC

11) Press the  key to save the changes or the  key to cancel editing the file parameters.



12) Press the  key to return to the measurement screen.

## 14.10 Changing the active File - Open



The user may have transferred grid/seq templates from a PC to the **BT1-DL**, or setup grids/seq using the **BT1-DL** at an earlier time. The name of the currently active file is always displayed at the top of the **Grid/Seq Box** in measurement mode (refer to photo below). It's not only important to recognize what file is currently active, but also be able to change the active file at any time. The following procedures outline this process:

### Changing the Active File



NAME: BOLTS R US	A	B	C
1	4.01493		
2	3.05655	0.00000	
3			

1) Press the  key once to activate the menu items tab. Press the  key multiple times to tab right and the  key multiple times to tab left until the **DATA** menu is highlighted and displaying the submenu items.



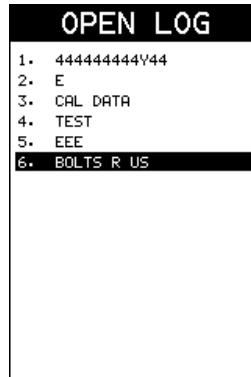

- 2) Use the  and  arrow keys to scroll through the sub menu items until **OPEN** is highlighted.

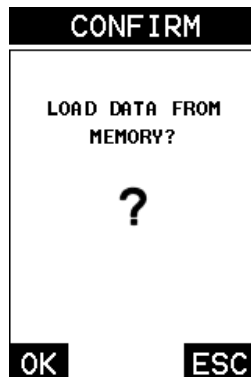

- 3) Press the  key to display the **Grid/Seq List Box**.
- 4) Use the  and  arrow keys to scroll through the grids until the target grid is highlighted.





- 5) Press the  key to activate the confirmation screen.
- 6) Press the  key to load the file from memory.

- 7) Press the  key to return to the measure screen.



### 14.11 Closing an active File - Close

A user might not have a current requirement to store measurements, but a file is currently open or active and needs to be closed. The following procedures outline how to close an open or active file:

#### Closing an Active File

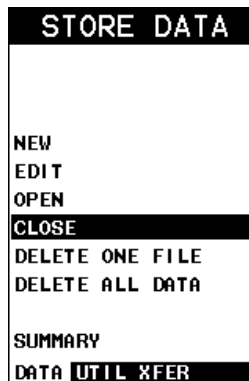
- 1) Press the  key once to activate the menu items tab. Press the  key multiple times to tab right and the  key multiple times to tab left until the **DATA** menu is highlighted and displaying the submenu items.



- 2) Use the  and  arrow keys to scroll through the sub menu items until **CLOSE** is highlighted.
- 3) Press the  key to close the active file. **Note:** *Following the key press, the **CLOSE** text will be grayed out indicating the file has been closed and is no longer active.*

## CHAPTER FIFTEEN SETUPS – CREATE, STORE, EDIT, & RECALL

### 15.1 Introduction to Setups

Often time users are faced with a variety of common bolting applications that will vary according to material type, geometry and grip lengths. It's also common that an engineer will setup and optimize a variety of configurations for a number of jobs that will be regularly monitored on a yearly basis. The **BT1-DL** has a setup feature that allows up to 64 custom setups that can be backed up to a PC and restored as needed. The user can create as many setup files, containing 64 setups per file, as is needed.

### 15.2 Opening a Setup

Once the **BT1-DL** has been loaded with a number of previously saved setup files for different bolts/jobs, the user can simply open a list of these setups and select the appropriate setup for the current job. The following procedures outline how to open factory and custom setups:





**Opening a Setup**

**SETUP OPTIONS**

OPEN  
SAVE  
DELETE  
DEFAULT SETUP



LANGUAGE    ENGLISH

**TUNE GATE AUTO SET**

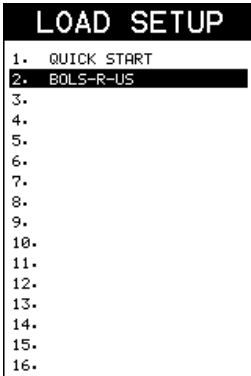
- 1) Press the  key once to activate the menu items tab. Press the  key multiple times to tab right and the  key multiple times to tab left until the **SETUP** menu is highlighted and displaying the submenu items.
- 2) Use the  and  arrow keys to scroll through the sub menu items until **OPEN** is highlighted.



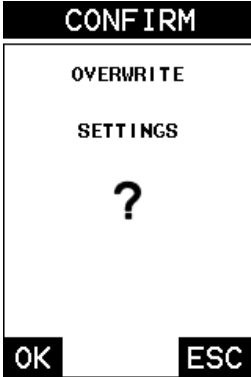

3) Press the  key to display the **Setup List Box**.

4) Use the  and  arrow keys to scroll through the setups until the target setup is highlighted.



5) Press the  key to activate the confirmation screen.

6) Press the  key to load the setup from memory.

7) Press the  key to return to the measure screen.

### 15.3 Saving a Setup





Once the **BT1-DL** parameters and features have been adjusted for an application, the user may elect to save these settings to a specific setup location for future use. This can potentially save time and reduce error between users.

It is sometimes necessary to rename a previously saved setup, or add additional comments about a particular setup. The setup name may have been entered incorrectly, or the user needs to use the setup for a completely different project. An inspector's name or other comments about the project may also be required for

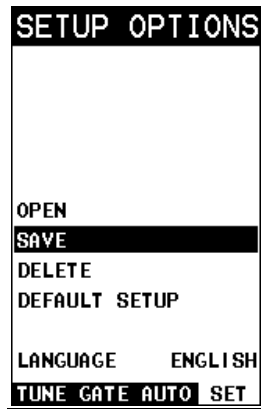

additional documentation purposes. The following procedures outline the necessary steps for saving and editing a setup:

### Saving a Setup

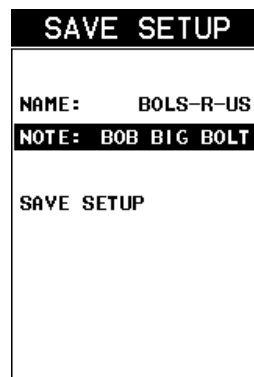

- 1) Press the  key once to activate the menu items tab. Press the  key multiple times to tab right and the  key multiple times to tab left until the **SETUP** menu is highlighted and displaying the submenu items.
- 2) Use the  and  arrow keys to scroll through the sub menu items until **SAVE** is highlighted.









- 3) Press the  key to display the **Save Setup Parameters List Box**.
- 4) Press the  and  arrow keys to scroll the **Name** and **Note** parameters.







5) When the parameter to edit is highlighted, press the  key to activate the **Alpha Edit Box**.

6) Use the     arrow keys to scroll through the characters, the  key to select characters, and the  key to backspace through the characters, until the **Name** or **Note** fields have been edited.

7) Press the  key to return to the **Save Setup Parameters List Box**.

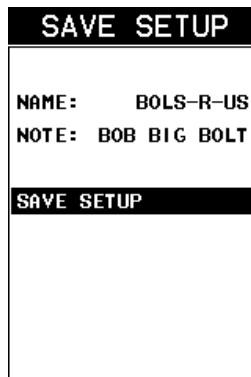

8) If both parameters will be edited, **repeat steps 4 – 7**.



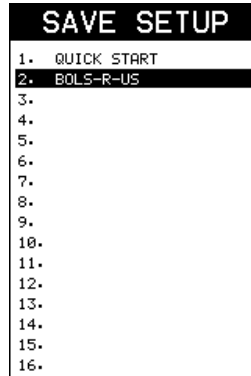

9) Use the  and  arrow keys to scroll to and highlight **SAVE SETUP**.

10) Press the  key to activate the **Setup List Box**.

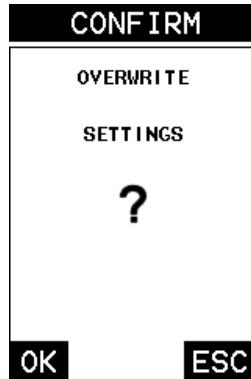

11) Use the  and  arrow keys to scroll through the setups until the target location to save the **Setup** is highlighted.



12) Press the  key to activate the confirmation screen.

13) Press the  key to save the **Setup**, or  to cancel saving the **Setup**.

14) Finally, press the  key to return to the measurement screen.





**Note:** *The **Name** and **Comments** of the **Setup** can be edited at any time by simply repeating the **Save Setup** routine described above. Therefore, **the Save Setup** function can also be considered an **Edit Function**.*

## 15.4 Deleting a Saved Setup

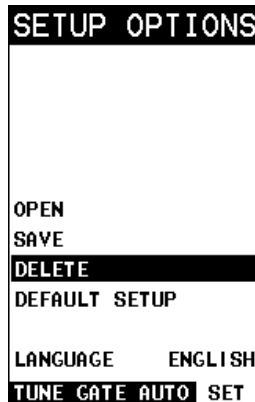



This option allows a user to delete setup files that were previously saved and no longer needed. It's a simple feature to allow the user to do a bit of "house cleaning".

## Deleting a Setup

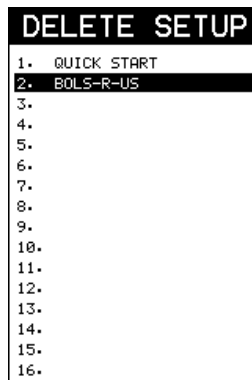



- 1) Press the  key once to activate the menu items tab. Press the  key multiple times to tab right and the  key multiple times to tab left until the **SETUP** menu is highlighted and displaying the submenu items.
- 2) Use the  and  arrow keys to scroll through the sub menu items until **DELETE** is highlighted.



- 3) Press the  key to display the **Setups List**.
- 4) Press the  and  arrow keys to scroll to the **Setup Name**.
- 5) When the **Setup Name** is highlighted, press the  key to display the confirmation screen.



6) Press the  key to delete the **Setup File**.



7) Finally, press the  key to return to the measurement screen.



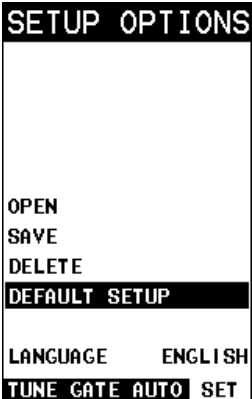

## 15.5 Using the Default Setup

The default setup feature was added to the **BT1-DL** to use, as a last resort, if there are no setups stored in the gauge –factory or otherwise. The only time this might possibly occur is if the setup file in the **BT1-DL** was somehow corrupted, and the user does not have access to a computer to re-load the factory setups back into the **BT1-DL**. This gives the user the ability to load and modify a basic setup as follows:

**Using the Default Setup**



1) Press the  key once to activate the menu items tab. Press the  key multiple times to tab right and the  key multiple times to tab left until the **SETUP** menu is highlighted and displaying the submenu items.





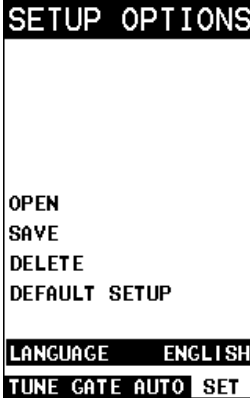

- 2) The  and  arrow keys to scroll through the sub menu items until **DEFAULT SETUP** is highlighted.
- 3) Press the  key to load default **DEFAULT SETUP**.
- 4) Finally, press the  key to return to the measurement screen.

## 15.6 Selecting a Language

The **BT1-DL** is equipped with a language option. Currently, only a few languages supported. However, be sure to update your gauge firmware often, to check for language additions. The steps to select a language are outlined as follows:

**Selecting a Language**



- 1) Press the  key once to activate the menu items tab. Press the  key multiple times to tab right and the  key multiple times to tab left until the **SETUP** menu is highlighted and displaying the submenu items.
- 2) Use the  and  arrow keys to scroll through the sub menu items until **LANGUAGE** is highlighted.
- 3) Press the  and  arrow keys multiple times to toggle the language options.

4) Once the desired language is displayed, press the  key to return to the measure screen.

## CHAPTER SIXTEEN SOFTWARE, FILE TRANSFER, & UPGRADES

### 16.1 Computer System Requirements

**DakView** will run on many different operating systems: Windows XP, Windows 2000 Professional, Windows 2000 Server, Windows 2000, Vista, Windows 7, 8, 10, or advanced Server operating systems running on Intel or AMD hardware. Additionally there is a version for the Mac OSX platform.

A Pentium 166MHz or faster processor with at least 32 megabytes of physical RAM is required. You should have 40 megabytes of free disk space before attempting to install **DakView**.

File transfer is standard USB connectivity, using a USB-C to USB transfer cable (pt# N-003-0330).

### 16.2 Installing DakView

**DakView** is available directly from our website for download free of charge. Stay current by periodically checking the website for the latest version. Simply download the .exe file from our website to your computer, and double click the icon to begin installation.

Refer to the online help section in **DakView** for operating instructions.

### 16.3 Communicating with **BT1-DL**

**DakView** will not directly communicate with the **BT1-DL** series gauges. The **BT1-DL** is equipped with USB, acting as a Thumb Drive (external storage device) when connected to a computer and powered on. Therefore, the SD memory card can be opened as a drive with *directory structure, similar to the C: on your computer*. The files stored on the internal SD can be simply copied (dragged) into any folder on your PC and opened using **DakView**. The PC software will function as a file viewer for the **BT1-DL** series gauges.

### 16.4 Line Power





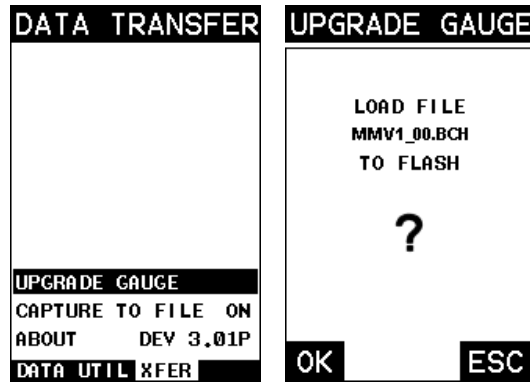

The **BT1-DL** can be powered using the standard USB-C to USB-A data cable (N-003-0330), by connecting directly to a USB port on your computer, or using a standard cell phone power adapter directly to an outlet. This is a convenient way to power the gauge for specific bench top applications in a factory line environment.

### 16.5 Upgrading the **BT1-DL**

The **BT1-DL** can be upgraded to the latest revision of firmware at any time. Simply download the latest version posted on the Dakota NDT website, copy the upgrade file to the main directory of the SD card in the **BT1-DL**, and use the upgrade utility located in the **XFER** menu. The process is very easy and convenient, allowing our users to stay current with updated feature additions and bug fixes. The procedure to upgrade your **BT1-DL** is outlined below:

### Upgrading the Firmware



- 1) Press the  key once to activate the menu items tab. Press the  key multiple times to tab right and the  key multiple times to tab left until the **XFER** menu is highlighted and displaying the submenu items.
- 2) Use the  and  arrow keys to scroll through the sub menu items until **UPGRADE GAUGE** is highlighted.
- 3) Press the  key to display the upgrade confirmation screen, followed by pressing  key to start the upgrade process.

**Note:** *The **BT1-DL** will power down during the upgrade process and the illuminate the alarm lights. The upgrade is completed once the lights stop flashing. Do not interrupt the upgrade process and be sure there is sufficient battery life, if not powering by AC.*



## WARRANTY INFORMATION

### • Warranty Statement •

Dakota NDT warrants the **BT1-DL** against defects in materials and workmanship for a period of two years from receipt by the end user. Additionally, Dakota NDT warrants transducers and accessories against such defects for a period of 90 days from receipt by the end user. If Dakota NDT receives notice of such defects during the warranty period, Dakota NDT will either, at its option, repair or replace products that prove to be defective.

Should Dakota NDT be unable to repair or replace the product within a reasonable amount of time, the customer's alternative exclusive remedy shall be refund of the purchase price upon return of the product.

### • Exclusions •

The above warranty shall not apply to defects resulting from: improper or inadequate maintenance by the customer; unauthorized modification or misuse, or operation outside the environmental specifications for the product.

Dakota NDT makes no other warranty, either express or implied, with respect to this product. Dakota NDT specifically disclaims any implied warranties of merchantability or fitness for a particular purpose. Some states or provinces do not allow limitations on the duration of an implied warranty, so the above limitation or exclusion may not apply to you. However, any implied warranty of merchantability or fitness is limited to the five-year duration of this written warranty.

This warranty gives you specific legal rights, and you may also have other rights which may vary from state to state or province to province.

### • Obtaining Service During Warranty Period •

If your hardware should fail during the warranty period, contact Dakota NDT and arrange for servicing of the product. Retain proof of purchase in order to obtain warranty service.

For products that require servicing, Dakota NDT may use one of the following methods:

- Repair the product
- Replace the product with a re-manufactured unit
- Replace the product with a product of equal or greater performance
- Refund the purchase price.

### • After the Warranty Period •

If your hardware should fail after the warranty period, contact Dakota NDT for details of the services available, and to arrange for non-warranty service.