

OPERATION MANUAL

DAKOTA ULTRASONICS

CMX^{DL+}

Material & Coating Thickness Gauge

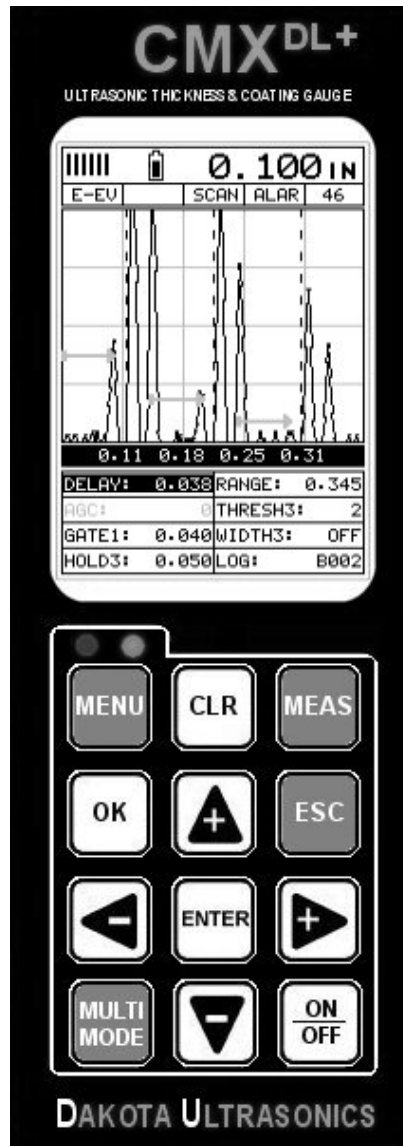

CHAPTER ONE INTRODUCTION	1
CHAPTER TWO QUICK STARTUP GUIDE	2
CHAPTER THREE KEYBOARD, MENU, & CONNECTOR REFERENCE.....	24
CHAPTER FOUR PRINCIPALS OF ULTRASONIC MEASUREMENT	36
CHAPTER FIVE SELECTING THE MEASUREMENT MODE	41
CHAPTER SIX MAKING MEASUREMENTS	44
CHAPTER SEVEN USING THE DISPLAY OPTIONS	60
CHAPTER EIGHT THRU PAINT MEASUREMENT TECHNIQUE	91
CHAPTER NINE PULSE-ECHO COATING & COATING TECHNIQUES.....	94
CHAPTER TEN ADDITIONAL FEATURES OF THE CMX ^{DL+}	109
CHAPTER ELEVEN DATA STORAGE – SETUP, EDIT, & VIEW FILES	131
CHAPTER TWELVE SETUPS – CREATE, STORE, EDIT, & RECALL.....	157
CHAPTER THIRTEEN USING THE UTILITY SOFTWARE.....	167
APPENDIX A - VELOCITY TABLE.....	169
APPENDIX B - SETUP LIBRARY.....	171

CHAPTER ONE INTRODUCTION

The Dakota Ultrasonics model **CMX^{DL+}** is an ultrasonic thickness gauge that measures with extreme versatility. It has the ability to measure simultaneously measure coatings and material thicknesses while maintaining the ability to locate pits, flaws and defects in the material. Based on the same operating principles as SONAR, the **CMX^{DL+}** is capable of measuring the thickness of various materials with accuracy as high as ± 0.001 inches, or ± 0.01 millimeters. The principle advantage of ultrasonic measurement over traditional methods is that ultrasonic measurements can be performed with access to only one side of the material being measured.

Dakota Ultrasonics maintains a customer support resource in order to assist users with questions or difficulties not covered in this manual. Customer support may be reached at any of the following:

- Dakota Ultrasonics Corporation,
1500 Green Hills Road, #107
Scotts Valley, CA 95066 USA
- Telephone: (831) 431-9722
- Facsimile: (831) 431-9723
- <http://www.dakotaultrasonics.com>

1.1 Disclaimer

Inherent in ultrasonic thickness measurement is the possibility that the instrument will use the second rather than the first echo from the back surface of the material being measured. This may result in a thickness reading that is TWICE what it should be. Responsibility for proper use of the instrument and recognition of this phenomenon rest solely with the user of the instrument. Other errors may occur from measuring coated materials where the coating is insufficiently bonded to the material surface. Irregular and inaccurate readings may result. Again, the user is responsible for proper use and interpretation of the measurements acquired.

CHAPTER TWO QUICK STARTUP GUIDE

Turn the **CMX^{DL+}** on and off using the switch located on the bottom right corner of the keypad. When **CMX^{DL+}** is initially turned on, a flash logo and blinking lights will be displayed, followed by attempting to identify the transducer (probe) currently plugged into the gauge. The **CMX^{DL+}** is equipped with an “Auto Probe Recognition” feature that attempts to identify special transducers with this built in feature. If the **CMX^{DL+}** doesn't find a transducer equipped with this feature, the user will be advanced to a list of transducers requiring the user to select a specific transducer type. The following sections outline each scenario. Note: This section is primarily written as a basic startup guide only.

2.1 CMX^{DL+} Overview

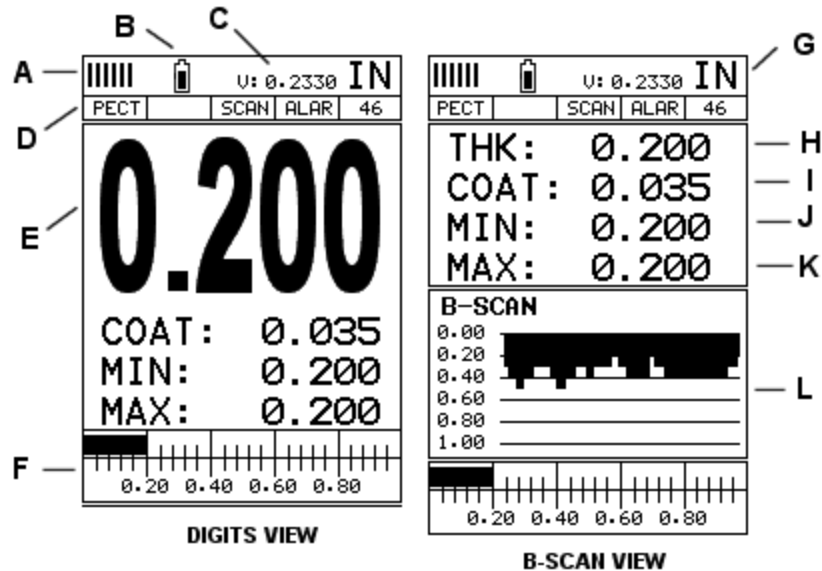

CMX DL+ SCREEN SHOTS (MENUS OFF)

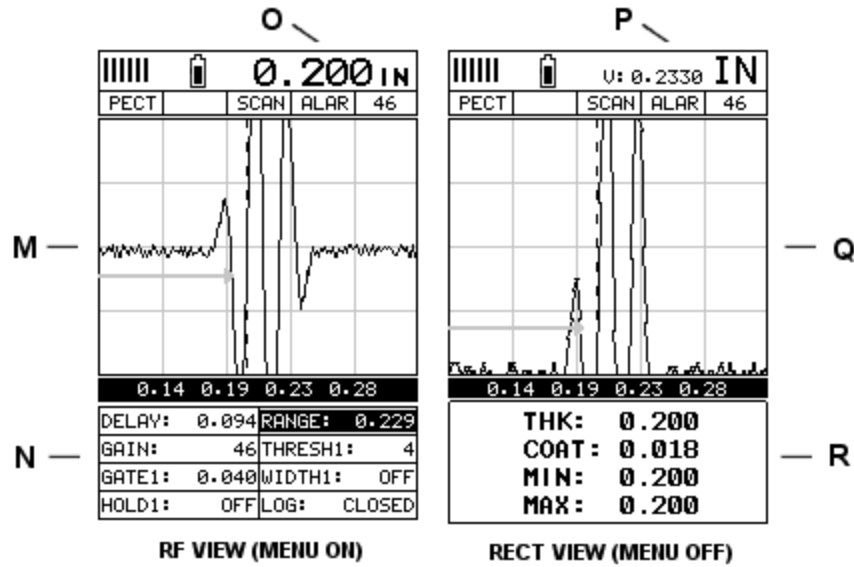

CMX DL+ SCREEN SHOTS (A-SCAN VIEWS)

In order to understand how to operate the **CMX^{DL+}**, it's best to start off with an understanding of what it is we're looking at exactly. The **CMX^{DL+}** has a lot of great features and tools that will prove to be a huge benefit for the variety of applications you're constantly facing on a continual basis. Let's have a brief look at the screens you'll be looking at most often:

- A. **Repeatability/Stability Indicator** – This indicator should be commonly used in conjunction with the digital thickness values displayed. When all the vertical bars are fully illuminated and the last digit on the digital thickness value is stable, the **CMX^{DL+}** is reliably measuring the same value 3 to 200 times per second, depending on which measurement mode and features are enabled.
- B. **Battery Icon** – Indicates the amount of battery life the **CMX^{DL+}** has remaining.
- C. **Velocity** – The material velocity value the **CMX^{DL+}** is currently using or calibrated for. Displayed in both English or Metric units, depending on the what units the gauge is set for.
- D. **Feature Status Bar** – Indicates the features currently enabled and in use in the following order:
 - Measurement Mode
 - Differential Mode
 - High Speed Scan Mode
 - Alarm Mode
 - Gain Setting
- E. **Digital Material Thickness Value** – Extra large font size for viewing ease.

- F. **Scan Bar** – Another view of material thickness in a deflection style horizontal bar. This is a visual tool that would enable the user the ability to see thickness changes during high speed scans from flaws and pits.
- G. **Units** – The current measurement units being used (English, Metric).
- H. **Digital Material Thickness Value** – Smaller font size when the B-Scan display view is enabled.
- I. **Coating Thickness Value** – Displays the actual thickness of any coating adhered to a metallic material surface (PECT Mode), or a coating adhered to a non-metallic surface (CT Mode).
- J. **Minimum Material Thickness** – Part of the Alarm feature. Displays the minimum thickness value found during a scan.
- K. **Maximum Material Thickness** – Part of the Alarm feature. Displays the maximum thickness value found during a scan.
- L. **B-Scan Display** – Cross section view of the material. Provides the user with graphical view of the opposite/blind surface (i.e. inside pipe wall surface), to give the user some idea of the condition, or integrity of the material being tested.
- M. **RF A-Scan Display** – The actual sound wave reflection that is returned from the detection of the opposite surface of the material being measured. In this view, the entire sine wave is displayed, showing both the positive and negative half cycles from the detection/reflection. This view is commonly used to initially “see the big picture” and make fine adjustments to the scope settings, prior to selecting another view option.
- N. **Hot Menu items** – We call this menu section our “hot menu”, as these items are the most commonly adjusted features, requiring quick access from the user. They can be displayed and scrolled by pressing the MEAS key at anytime. The ESC key is used in conjunction with MEAS key to reverse the direction scrolled.
- O. **Reference Note** – When the “hot menu” items are displayed/activated, the base material thickness value shown at reference point “O”. However, when the “hot menu” items have been deactivated, the current base material velocity value is displayed, as shown in reference point “P”. When the “hot menus” are deactivated, the entire “hot menu” section becomes a multiple measurement display area, allowing the user to simultaneously view: base material, coating, and base material minimum/maximum thickness values dynamically, as shown in reference point “R”.
- P. **Reference Note** – Please refer to “O”, for a detailed explanation.
- Q. **RECT A-Scan Display** – The actual sound wave reflection that is returned from the detection of the opposite surface of the material being measured. In this view, only half of the sine wave is being displayed (positive or negative). This view is commonly referred, and used as a “flaw detection” mode, once the user made all the necessary adjustments using the RF mode (refer to M).

2.2 Auto Probe Recognition

When the **CMX^{DL+}** is initially powered up, the gauge will automatically check to see if the transducer plugged into the gauge can be recognized. The steps that follow assume the **CMX^{DL+}** recognized the probe type:

Probe Automatically Recognized

CONFIRM

1/4IN - 5.0MHZ COAT
PROBE IDENTIFIED.

USE THIS PROBE?

OK

ESC

- 1) Press the **OK** key once to use the identified probe, or **ESC** to display a list of optional transducers. *Note: if the **CMX^{DL+}** recognizes a specific transducer, the user should always select **OK** to use the identified probe. The only time an alternative probe should be selected from a list is if the user switched probes following initial power up and recognition.*
- 2) Assuming the **CMX^{DL++}** recognized the probe and the **OK** key was pressed, the **CMX^{DL+}** will advance to a Zero Probe menu. If the transducer was identified as a special transducer capable of measuring coating thickness, a menu will be displayed allowing the user the ability to toggle the coating thickness display on/off as follows:

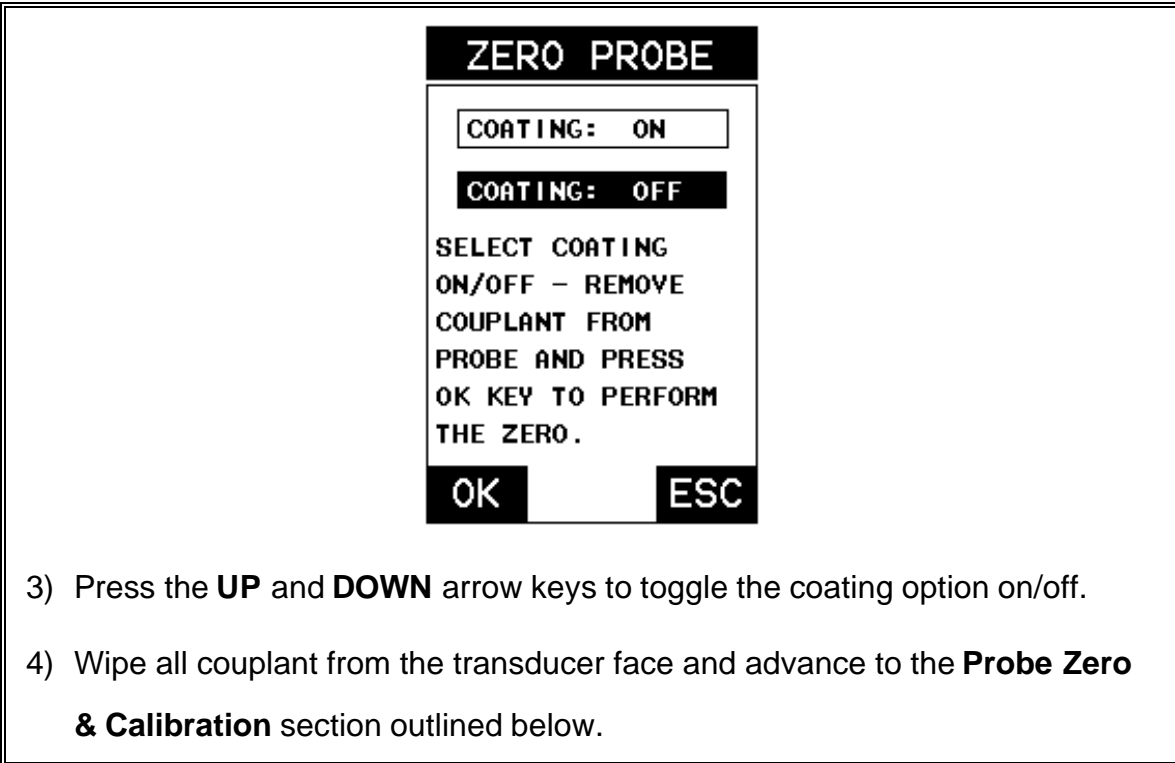

2.3 Selecting the Transducer Type

If the **CMX^{DL+}** does not identify a specific transducer type on initial power up, the user will be required to select a type from a predefined list of types by diameter and frequency. By selecting a transducer type from a predefined list, the **CMX^{DL+}** can recall specific properties about the transducer. **Note:** Once the transducer has been selected, the **CMX^{DL+}** will store and recall this transducer type every time the **CMX^{DL+}** is powered on/off. The type will only change if the user physically selects another transducer type from the list, or selects a previously saved setup. However, the **CMX^{DL+}** will continue to take you through these steps each time the gauge is powered up. You'll notice that the probe type previously selected will be highlighted every time the probe type screen is displayed. Use the following steps to select your transducer type:

Selecting the Transducer Type

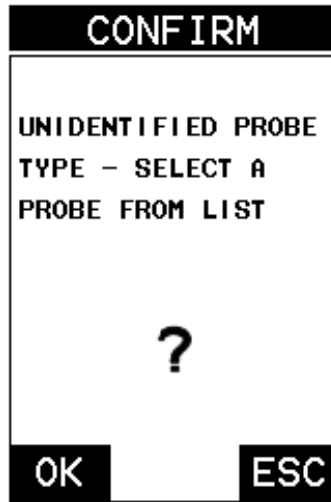

- 1) Press the **OK** or **ESC** keys to display the factory list of transducer types (by diameter and frequency).

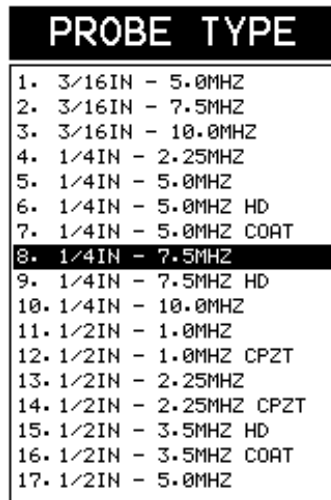

- 2) Press the **UP** and **DOWN** arrow keys to scroll through the transducer list until the appropriate type is highlighted.

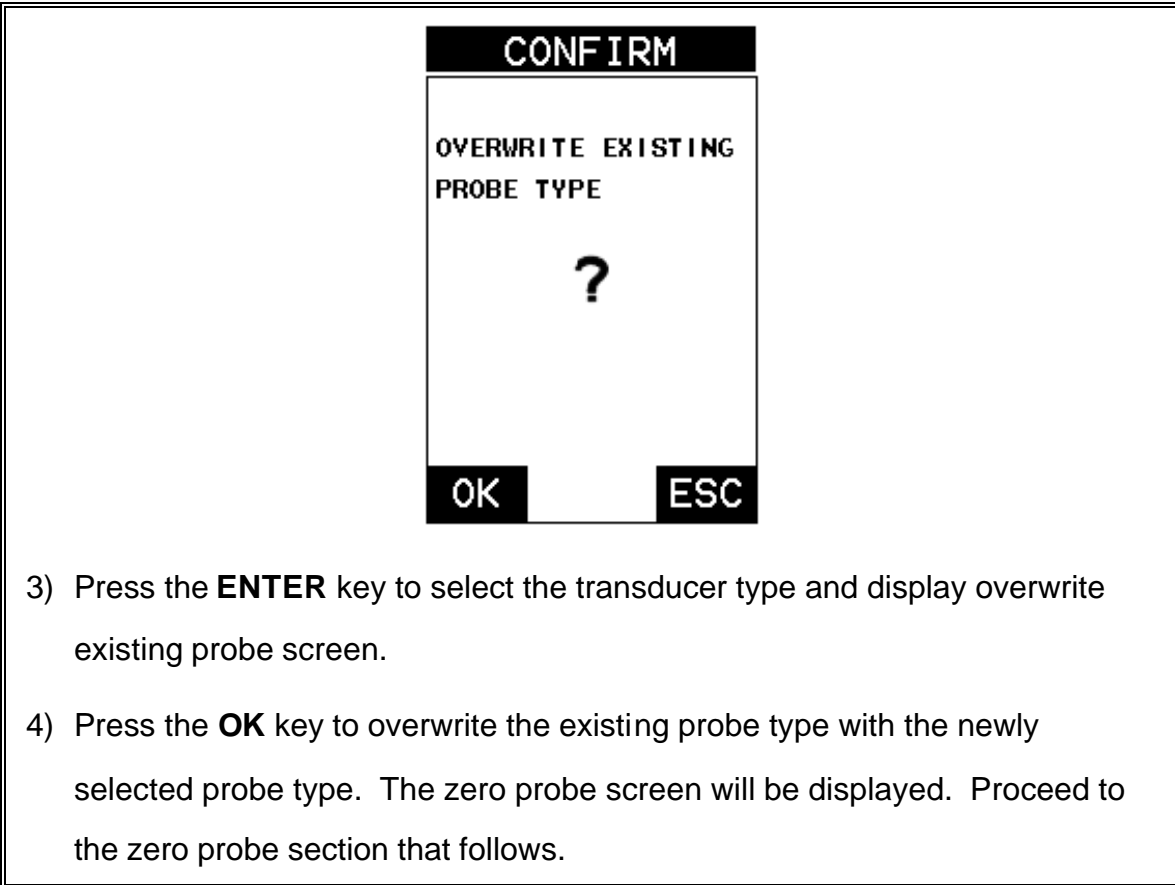

2.4 Probe Zero & Calibration

The next steps are to perform a probe zero and calibrate the **CMX^{DL+}** to the material and transducer being used. If the sound velocity is unknown, the **CMX^{DL+}** can be calibrated to a known thickness sample. This demo will briefly explain both of these techniques.

The **CMX^{DL+}** is equipped with two zero options:

- 1) **Off Block Zero (Automatic Probe Zero)** – When this feature is enabled the **CMX^{DL+}** will do an electronic zero automatically, eliminating the need for a zero disk or block.
- 2) **On Block Zero (Manual Probe Zero)** – When this feature is enabled the transducer must be placed on the probe zero disk (battery cover located on the top of the unit).

Note: Transducers of the same type will have very slight mechanical and electrical variations. If it's discovered that the linearity is off following an initial auto probe zero and extreme accuracy is required, a manual zero should be performed followed by an auto zero. This will adjust and eliminate any error. This is only required if it's discovered the transducer is non-linear following an initial auto probe zero.

The procedures are outlined as follows:

Performing an Auto Probe Zero (Off Block)

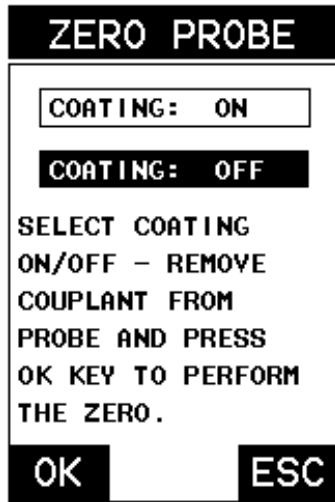

Coating Probe Identified

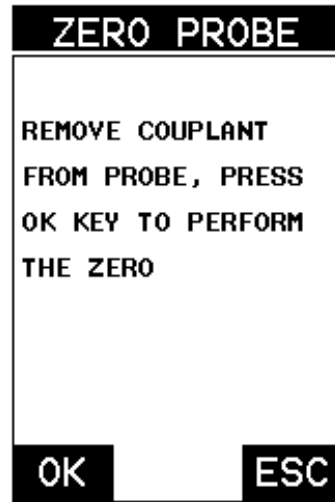

Coating Probe Not Identified

- 1) Be sure all couplant has been removed from the face of the transducer.
- 2) Press the **OK** key to perform the automatic probe zero, or **ESC** key to cancel the zero operation.

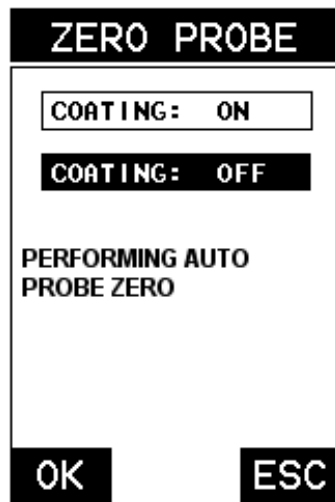

Coating Probe Identified

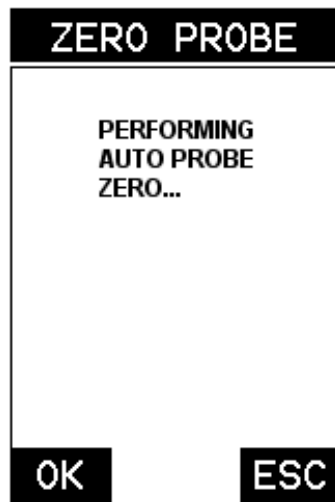

Coating Probe Not Identified

- 3) The screens illustrated above will be briefly displayed followed by the main measurement screen. The **CMX^{DL+}** is ready to be calibrated.

Performing a Manual Probe Zero (On Block)

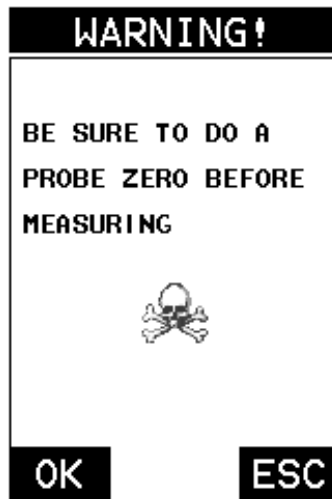

Note: When the zero probe option is set to manual, the probe zero disk (battery cap) located on the top of the gauge, will be used as a zero standard and the warning screen illustrated above will be displayed.

- 1) Press the **OK** or **ESC** keys to enter the main measurement screen and begin the manual zero process.
- 2) Apply a drop of couplant on the transducer and place the transducer in steady contact with the probe zero disk, and obtain a steady reading.
- 3) Press the **MENU** key once to activate the menu items tab. Press the **MENU** key multiple times to tab right and the **ESC** key multiple times to tab left until the **PRB** menu is highlighted and displaying the submenu items.
- 4) Press the **UP** and **DOWN** arrow keys to scroll through the sub menu items until **ZERO PROBE** is highlighted.

Coating Probe Identified Coating Probe Not Identified

- 5) Press the **ENTER** key to display the confirmation screen.
- 6) If a coating transducer was identified use the **UP** and **DOWN** arrow keys to toggle coating on/off.
- 7) Press the **OK** key to complete the probe zero function, or **ESC** key to cancel the probe zero function.
- 8) Remove the transducer from the probe zero disk, and proceed to the calibration section.

Note: The value that is displayed will change depending on the current velocity setting in the **CMX^{DL+}**. Disregard the number that is displayed. **It is not important.** What is important is accurately performing the steps outlined above to insure reliability of the probe zero calculation.

One Point Material Calibration

For the purposes of this quick start section, we'll only be covering the most common one point calibration option to determine the sound velocity of the test material. It would be very handy to carry a set of mechanical calipers to use in conjunction with the **CMX^{DL+}** for calibration in the field:

Using a Known Thickness

CALIBRATE	
MAT	CUSTOM
MATL 1PT	1.000
MATL 2PT	UNCAL
VELOCITY	0.2330
COATING 1PT	UNCAL
COATING 2PT	UNCAL
COATING VEL	0.0850
PRB	CAL
DISP	TUNE

Note: Be sure that the probe zero procedure has been performed prior to performing this calibration procedure.

- 1) Physically measure an exact sample of the material or a location directly on the material to be measured using a set of calipers or a digital micrometer.
- 2) Apply a drop of couplant on the transducer and place the transducer in steady contact with the sample or actual test material. Be sure that the reading is stable and the repeatability indicator, in the top left corner of the display, is fully lit and stable. Press the **MENU** key once to activate the menu items tab. Press the **MENU** key multiple times to tab right and the **ESC** key multiple times to tab left until the **CAL** menu is highlighted and displaying the submenu items.
- 3) Use the **UP** and **DOWN** arrow keys to scroll through the sub menu items until **MATL 1PT** is highlighted.



- 4) Press the **ENTER** key to display the **Digits Edit Box**.
- 5) Press the **UP** and **DOWN** arrow keys to scroll the highlighted value.
- 6) Press the **LEFT** and **RIGHT** arrow keys to scroll the digit locations.
- 7) Repeat steps **5 & 6** until the known thickness value is correctly displayed.
- 8) Press the **OK** key to calculate the velocity and return to the menu screen, or **ESC** to cancel the one point calibration.
- 9) Finally, press the **MEAS** key to return to the measurement screen and begin taking readings.

Note: CHECK YOUR CALIBRATION! Place the transducer back on the calibration point. The thickness reading should now match the known thickness. If the thickness is not correct, repeat the steps above.

2.5 Zero Coating

In order to account for very slight electronic differences in transducers of the same type, frequency, and diameter, the **CMX^{DL+}** has been equipped with a “zero coating” feature. This enables the **CMX^{DL+}** to obtain very accurate readings on coatings, eliminating potential errors incurred from slight differences in the manufacturing processes. The procedure is outlined below:

Performing a Coating Zero

MEASURE MODE	
COATING OFF	P-E
COATING ON	PECT
TEMP COMP	PETP
THRU COAT	E-E
THRU VERIFY	E-EV
COATING ONLY	CT

- 1) Press the **MULTI MODE** key once to activate the measurement mode options.
- 2) Use the **UP** and **DOWN** arrow keys to scroll through the sub menu items until **Coating Only (CT)** mode is highlighted.
- 3) Press the **ENTER** key to select the measurement mode and return to the measurement screen.
- 4) Apply a drop of couplant on the transducer and place the transducer in steady contact with the probe zero disk (battery cover) and obtain a steady reading.

Note: The coating measurement displayed will potentially be a value greater or less than 0.

- 5) Press the **MENU** key once to activate the menu items tab. Press the **MENU** key multiple times to tab right and the **ESC** key multiple times to tab left until the **PRB** menu is highlighted and displaying the submenu items.

SETUP PROBE	
ZERO PROBE	AUTO
ZERO COATING	
TYPE	11
FLAW MODE	OFF
PRB	CAL DISP TUNE

- 6) Use the **UP** and **DOWN** arrow keys to scroll through the sub menu items until **ZERO COATING** is highlighted.
- 7) Press the **ENTER** key to display the confirmation screen.
- 8) Press the **OK** key to zero the coating and return to the **PRB** menu, or **ESC** to cancel the coating zero process.
- 9) Press the **MULTI MODE** key once to activate the measurement mode options.
- 10) Use the **UP** and **DOWN** arrow keys to scroll through the sub menu items until **Coating On (PECT)** is highlighted.
- 11) Press the **ENTER** key to select the measurement mode and return to the measurement screen, and begin taking readings.

2.6 Coating Calibration

The **CMX^{DL+}** has been preset to a default coating velocity of 0.0850 in/ μ sec (2159 m/sec). This will be very close to the most common coating material velocities used in the field. If the velocity of the coating is known, and different than the above default setting, the user can simply enter the coating velocity into the **CMX^{DL+}**. However, if the velocity is unknown, the **CMX^{DL+}** can also be calibrated to a specific coating sample/type using the 1pt calibration option in PECT (pulse-echo coating) mode, or a two point calibration is **CT (coating only)** mode. For the purpose of this

quick start section only the 1pt option **PECT (pulse-echo coating)** mode will be covered. Refer to the calibration section of the manual for a complete explanation on the coating calibration options. The following steps below outline the necessary steps to either set the velocity of the coating, or perform a one point calibration to calculate the coating velocity:

Known Coating Velocity

If the coating velocity is known, the user may wish to simply enter the velocity number into the **CMX^{DL+}**, rather than have the **CMX^{DL+}** calculate the velocity value using a known thickness on a coating sample. The steps for entering the velocity are outlined below:

Using a Known Coating Velocity

CALIBRATE	
MAT	STEEL <4340>
MATL 1PT	UNCAL
MATL 2PT	UNCAL
VELOCITY	0.2330
COATING 1PT	UNCAL
COATING 2PT	UNCAL
COATING VEL	0.0850
PRB	CAL DISP TUNE

- 1) Press the **MENU** key once to activate the menu items tab. Press the **MENU** key multiple times to tab right and the **ESC** key multiple times to tab left until the **CAL** menu is highlighted and displaying the submenu items.
- 2) Use the **UP** and **DOWN** arrow keys to scroll through the sub menu items until **COATING VEL** is highlighted.
- 3) Press the **ENTER** key to display the **Digits Edit Box**.
- 4) Press the **UP** and **DOWN** arrow keys to scroll the highlighted value.
- 5) Press the **LEFT** and **RIGHT** arrow keys to scroll the digit locations.

- 6) Repeat steps **4 & 5** until the velocity number is correctly displayed.
- 7) Press the **OK** key to set the coating velocity and return to the menu screen, or **ESC** to cancel entering the coating velocity.
- 8) Finally, press the **MEAS** key to return to the measurement screen and begin taking readings.

Known Coating Thickness

When the exact velocity of a coating is unknown, the user has the option of performing a one point calibration on a sample of the coating with a known thickness to determine the sound velocity. It would be very handy to carry a set of mechanical calipers to use in conjunction with the **CMX^{DL+}** for calibration in the field:

Using a Coating Sample to Calibrate

CALIBRATE	
MAT	STEEL <4340>
MATL 1PT	UNCAL
MATL 2PT	UNCAL
VELOCITY	0.2330
COATING 1PT	0.030
COATING 2PT	UNCAL
COATING VEL	0.0700
PRB	CAL DISP TUNE

- 1) Physically measure a location on a coating sample using a set of calipers or a digital micrometer.

Important Note: In **PECT** (pulse-echo coating) mode, the coating sample must be coupled to metal in order to calibrate successfully. Simply place a drop of couplant on a piece of metal, lay the coating sample over the couplant on the metal and proceed to step 2.

- 2) Apply a drop of couplant on the transducer and place the transducer in steady contact with the coating (on metal) sample or actual test material. Be sure that the reading is stable and the repeatability indicator, in the top left corner of the display, is fully lit and stable. Press the **MENU** key once to activate the menu items tab. Press the **MENU** key multiple times to tab right and the **ESC** key multiple times to tab left until the **CAL** menu is highlighted and displaying the submenu items.
- 3) Use the **UP** and **DOWN** arrow keys to scroll through the sub menu items until **COATING 1PT** is highlighted.

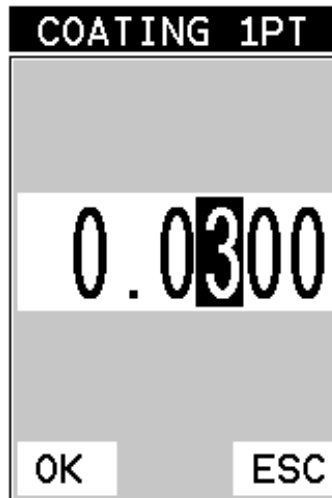

- 4) Press the **ENTER** key to display the **Digits Edit Box**.
- 5) Press the **UP** and **DOWN** arrow keys to scroll the highlighted value.
- 6) Press the **LEFT** and **RIGHT** arrow keys to scroll the digit locations.
- 7) Repeat steps **5 & 6** until the known thickness value is correctly displayed.

- 8) Press the **OK** key to calculate the coating velocity and return to the menu screen, or **ESC** to cancel the one point calibration.
- 9) Finally, press the **MEAS** key to return to the measurement screen and begin taking readings.

Note: CHECK YOUR CALIBRATION! Place the transducer back on the calibration point. The coating thickness reading should now match the known coating thickness sample. If the thickness is not correct, repeat the steps above.

2.7 Measure

The **CMX^{DL+}** is now ready to measure. There are four different measurement view options, each with a specific purpose – Digits, RF, RECT, & B-Scan. The steps below outline how to toggle between the different view mode options:

Selecting the Measurement View Option

SET DISPLAY	
VIEW	RECT
DELAY	0.094
RANGE	0.229
UNITS	IN
BACKLIGHT	OFF
CONTRAST	10
RECT WAVE	OUTLINE
DETECT MARK	DOTS
PRB	CAL
DISP	TUNE

- 1) Press the **MENU** key once to activate the menu items tab. Press the **MENU** key multiple times to tab right and the **ESC** key multiple times to tab left until the **DISP** menu is highlighted and displaying the submenu items.

- 2) Use the **UP** and **DOWN** arrow keys to scroll through the sub menu items until **VIEW** is highlighted.
- 3) Use the **LEFT** and **RIGHT** arrow keys to scroll the view options.
- 4) Once the view is displayed, press the **MEAS** key to return to measurement mode.

DIGITS: Displays the digital thickness value using a large font size. This view is useful when the CMX^{DL+} is being used as a basic thickness gauge.

RF: Displays the actual waveform signal, much like an oscilloscope, from the reflection of the opposite surface, pit, flaw, crack or void. This view shows both the positive and negative peaks, and is often used to fine tune the scope settings, prior to inspection.

RECT: Displays a half waveform signal, either positive or negative, from the reflection of the opposite surface, pit, flaw, crack or void. The user can select the polarity or “phase” displayed. This is typically determined by first using RF view to select the most optimal polarity “phase”, to fine tune the scopes settings. The RECT view is commonly used as the primary “flaw detection” view.

BSCAN: The Time Based B-Scan provides the user with a cross sectional view of the material being tested. This mode is useful when there is concern regarding the profile of the blind surface. This can also be a useful view when scanning for pits and flaws.

Once the view has been selected according to the application requirements, the **Delay** and **Range** of the screen will potentially need to be adjusted, if the view has been set to **RF** or **RECT**. Alternatively, if **BSCAN** was selected, the **B-Start** and **B-Depth** settings will need to be adjusted. These settings serve the same purpose, with only differences in terminology. The **Delay** the same as **B-Start**, and the **Range** is the same as **B-Depth**. Therefore, these items will be grouped together for the duration of this manual, as follows: **Delay (B-Start)** and **Range (B-Depth)**. Use the following steps to adjust these settings directly from the measurement screen as follows:

Note: The **Delay (B-Start)** and **Range (B-Depth)** are also used to adjust the parameters of **Scan Bar**.

Adjusting Delay (B-Start) & Range (B-DEPTH)

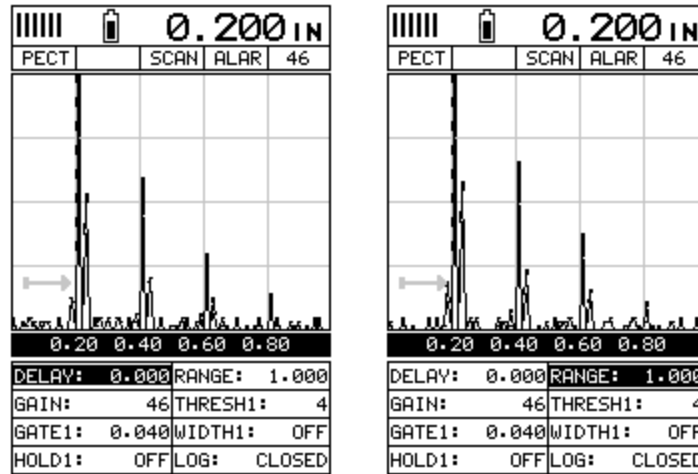

- 1) Press the **MEAS** key once to activate the measure menu items. Press the **MEAS** key multiple times to move right and the **ESC** key multiple times to move left, until the either the **DELAY (START)** or **RANGE (DEPTH)** cell is highlighted.
- 2) Use the **UP**, **DOWN**, **LEFT**, or **RIGHT** arrow keys to scroll the **DELAY (START)** and **RANGE (DEPTH)** values.
- 3) Repeat steps 1 & 2 until the range is correctly being displayed.

Alternatively, the **DELAY (START)** and **RANGE (DEPTH)** values can be changed using the **Digit Edit Box** as follows:

- 4) Press the **MEAS** key once to activate measure menu items. Press the **MEAS** key multiple times to move right and the **ESC** key multiple times to move left, until the either the **DELAY (START)** or **RANGE (DEPTH)** cell is highlighted.



- 1) Press the **ENTER** key to display the digits edit box.
- 2) Press the **UP** and **DOWN** arrow keys to scroll the highlighted value.
- 3) Press the **LEFT** and **RIGHT** arrow keys to scroll the digit locations.
- 4) Repeat steps **3 & 4** until the **DELAY (START)** or **RANGE (DEPTH)** value is correctly displayed.
- 5) Press the **OK** key to set the **DELAY (START)** and **WIDTH (DEPTH)** value and return to the measure screen, or **ESC** to cancel entering the **DELAY (START)** or **WIDTH (DEPTH)** value.
- 6) Finally, press the **MEAS** key to return to the measurement screen and begin taking readings.

Note: The **DELAY (START)** & **WIDTH (DEPTH)** can also be adjusted from the tabbed menu item **DISP**. However, using the hot menu keys is the easiest method.

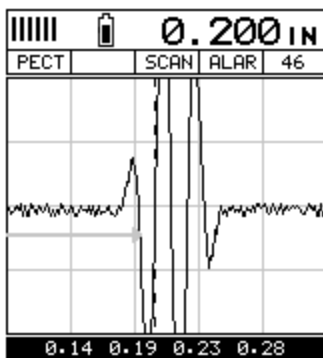

RF View

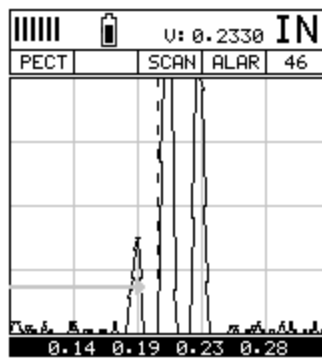

Rectified (RECT) View

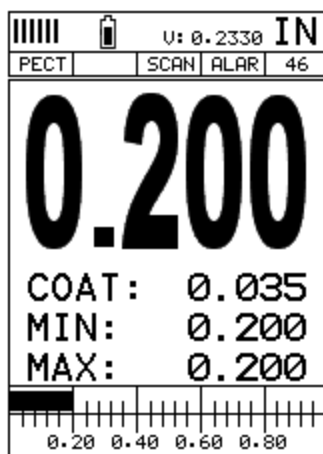

BSCAN View

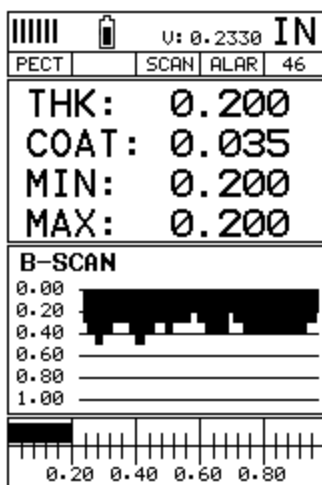

DIGITS View

In the upper left corner of each of the display photos above, is the repeatability indicator. The repeatability indicator is represented by six vertical bars and represents how repeatable the measurements are. In regular measurement mode, the **CMX^{DL+}** makes 8 measurements a second. In scan mode, the **CMX^{DL+}** makes 200 measurements a second. If the coating mode option is activated, the **CMX^{DL+}** makes 3 measurements a second in regular measurement mode and 65 measurements a second in scan mode. When the **CMX^{DL+}** is idle, only the left vertical bar will be displayed. However, when the **CMX^{DL+}** is making a measurement, four or five of the bars should be displayed on the repeatability indicator. If fewer than four bars are showing, the **CMX^{DL+}** is having difficulty achieving a stable measurement and the thickness value displayed is potentially unstable.

CHAPTER THREE KEYBOARD, MENU, & CONNECTOR REFERENCE



3.1 Menu Key (Operation & Sub Menus)

The **Menu** key activates the primary menu structure containing 8 menu tab groups. These tab groups then contain sub menu items, or functions. The sub menu items have been organized in tab groups according to how closely they are related to the individual tab group names. Let's first get familiar with how to move around in these tabs before continuing on to the sub menu functions. This procedure is outlined below:

Activating and Getting Around in the Menu Items

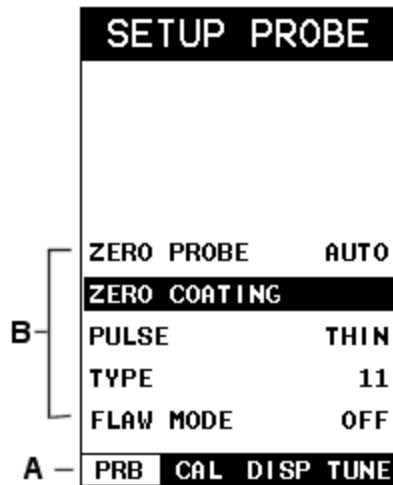

- 1) Press the **MENU** key once to activate the menu items tab. Press the **MENU** key multiple times to tab right, and the **ESC** key multiple times to tab left until the desired tab group is highlighted and displaying the submenu items. The tab groups are illustrated above **(A)**.

Now that you're familiar with activating and moving amongst the tab groups, let's have a look at how to move around in the sub menu items as follows:

Getting Around in the Sub Menu Items

- 1) Use the **UP** and **DOWN** arrow keys to scroll through the sub menu items until the desired function is highlighted. The sub menu items are illustrated in the diagram above **(B)**.
- 2) Depending on which function is highlighted, use the **LEFT**, **RIGHT**, and **Enter** keys to scroll the options or activate the **Digit Edit** and **List Box** options.

The sections to follow will provide the user with an explanation of the sub menu functions:

ZERO PROBE	MANUAL
ZERO COATING	
TYPE	11
FLAW MODE	OFF
PRB	CAL DISP TUNE

3.2 Probe – Menu

ZERO PROBE: The **CMX^{DL+}** is zeroed in much the same way that a mechanical micrometer is zeroed. If the **CMX^{DL+}** is not zeroed correctly, all of the measurements made using the **CMX^{DL+}** may be in error by some fixed value. The **CMX^{DL+}** is equipped with an optional automatic or manual zero feature. Refer to the section on page 48, for an explanation of this important procedure.

ZERO COATING: In order to account for very slight electronic differences in transducers of the same type, frequency, and diameter, the **CMX^{DL+}** has been equipped with a “zero coating” feature. This enables the **CMX^{DL+}** to obtain very accurate readings on coatings, eliminating potential errors incurred from slight differences in the manufacturing processes. Refer to the section on page 48, for a detailed explanation.

TYPE: Enables the user to select the type of transducer being used from a chart of transducer types. This provides increased linearity between transducers. Refer to page 44 for a further explanation.

FLAW MODE: Activates the flaw detection mode and view. This feature is for use with single element angle beam transducers and used as a general prove-up flaw inspection mode. Refer to page 120 for a further explanation.

MAT	STEEL <4340>
MATL 1PT	UNCAL
MATL 2PT	UNCAL
VELOCITY	0.2330
COATING 1PT	UNCAL
COATING 2PT	UNCAL
COATING VEL	0.0850
PRB	CAL DISP TUNE

3.3 CAL – Menu

MAT: Select the material velocity from a chart of basic material types when a known sample thickness, or material velocity cannot be obtained. Refer to page 57 for further info.

MATL 1PT: Performs a single point calibration. This option allows the user to automatically calculate the velocity by entering a known sample thickness. Refer to page 54 for further info.

MATL 2PT: Performs a two-point calibration. This option allows the user to automatically calculate the velocity by entering a second known sample thickness. Refer to page 56 for further info.

VELOCITY: Function to calibrate the CMX^{DL+} by setting the velocity to a known material velocity. Refer to page 52 for further info.

COATING 1PT: Performs a single point coating calibration. This option allows the user to automatically calculate the velocity by measuring a known coating sample thickness. Refer to page 104 for further info.

COATING 2PT: Performs a two-point coating calibration. This option allows the user to automatically calculate the velocity by entering a second known coating sample thickness. Refer to page 104 for further info.

COATING VEL: Function to calibrate the CMX^{DL+} to a specific coating material type by entering a coating velocity. Refer to page 16 or page 98 for further info.

VIEW	RECT	SET DISPLAY	
DELAY	0.000	VIEW	BSCAN
RANGE	1.000	B-START	0.000
UNITS	IN	B-DEPTH	1.000
BACKLIGHT	OFF	B-SCAN SPEED	6
CONTRAST	10	UNITS	IN
RECT WAVE	OUTLINE	BRIGHTNESS	20
DETECT MARK	DOTS	VIEW	GREEN 2
PRB	CAL	DISP	TUNE

3.4 DISP (display) – Menu

VIEW: Selectable BSCAN (cross section), and DIGITS (large digits) views. Refer to page 61 for further info.

DELAY (B-START): Provides the user the ability to change the start position of the B-SCAN view. Refer to page 69 for further info.

RANGE (B-DEPTH): Provides the user the ability to change the overall depth of the viewable measurement area. It functions a lot like a zoom on a camera. Refer to page 71 for further info.

B-SCAN SPEED: (color version only) – Controls the speed of the time based B-Scan with an arbitrary scale of 0-10, with 10 being the fastest scrolling speed. Default speed set at 6. Refer to page 73 for further info.

UNITS: Toggle between English or Metric units. The readout will change from inches to millimeters.

BACKLIGHT: Selectable OFF, ON, AUTO, or INVERT backlight option.

Note: Color version uses an AMOLED display, and 'Brightness' is substituted for Backlight as the menu item label, with an arbitrary scale of 1-20, with the brightest setting at 20. Refer to page 115 for further info.

CONTRAST: Adjustable display contrast for variable light conditions.

Note: This menu item is eliminated in the color version.

VIEW: (color version only) – Provides the user with 12 different color schemes to select from. There are two schemes for each main color option. Refer to page 117 for further info.

DIM: (color version only) – Allows the user to conserve battery life by dimming the display after idle for a specific amount of time – OFF, 30, 60, 90, 120 seconds. Once dimmed, a single press of any key will restore the screen brightness. Refer to page 118 for further info.

RECT WAVE: This option provides the user an outlined or filled view option when the display setting is in RECT (rectified) wave mode only. Refer to page 123 for further info.

DETECT MARK: Selectable graphics option for the point of detection on the waveform: Line, Box, Dots, None. Offers the user a graphics preference on how they prefer to view the detection on the waveform.

MEASURE MODE	PECT
POLARITY	NEGATIVE
PULSE	THIN
PULSER VOLT	150
ATTN	0 DB
GAIN	46
AGC	0
PRB	CAL DISP TUNE

TUNE	SIGNAL
MEAS MODE	PECT
POLARITY	POSITIVE
PULSE	SPIKE
PULSER VOLT	150
	50
ATTN	0 DB
GAIN	40
AGC	1
PRB	CAL DISP

3.5 TUNE – Menu

MEASURE MODE: Toggles a variety of unique measurement modes for different application requirements: Coating Off (P-E), Coating On (PECT), Temp Comp (PETP), Thru Coat (E-E), Thru Verify (E-EV), Coating Only (CT). Refer to page 37 for further info.

POLARITY: The **CMX^{DL+}** operates on a zero crossing detection principle. This feature toggles which stroke of the cycle the crossing detection uses, either positive or negative. Refer to page 125 for further info.

PULSE: The **CMX^{DL+}** has an adjustable pulse width for both high penetration and resolution applications. The pulse width refers to the duration of time the pulser is on. The options are **Spike**, **Thin**, and **Wide**. Refer to page 127 for a further explanation.

PULSER VOLTAGE: This feature offers a 50 volt cut/boost to the pulser. The standard setting is 150 volts. This enables the **CMX^{DL+}** to offer greater penetration for difficult material types, or increased resolution on noisy materials. Refer to page 128 for a further explanation.

DAMPING: (color version only) – Provides the user with multiple input impedances to match the impedance of the transducer, and optimized overall transducer performance. Refer to page 119 for further info.

ATTN: This feature is a 20dB attenuator, as well as a 20dB amplifier. The primary purpose is to offer further flexibility to the **CMX^{DL+}**, by either cutting or boosting signal strength. In instances where the 60 dB range is not enough, or too much, this feature allows you to increase/decrease the amplifier strength by a power of 10 or (20dB). The standard setting is zero, which is an arbitrary value at a constant attenuation. The attenuation value is added to the gain value. Therefore, if the attenuator is increased to 20dB, this value is added to the value of the gain setting. Refer to page 129 for a further explanation.

GAIN: The **CMX^{DL+}** has 100dB gain range from (-30 to 70 dB), used in conjunction with the attenuator feature above. This feature is used to increase/decrease the power or amplitude of the signal. This might easily be considered as similar to turning the volume up or down on a stereo receiver. Refer to page 74 for further info.

AGC: This an automatic gain control used in E-E (echo-echo), and E-EV (echo-echo verify). The **CMX^{DL+}** is equipped with an automatic gain control when operating in -E (echo-echo), and E-EV (echo-echo verify) modes only. This feature automatically increases/decreases the power or amplitude of the signal, to an optimal input to output signal ratio. This might easily be considered as similar to turning the volume up or down on a stereo receiver. Alternatively, the AGC can be manually controlled. The **CMX^{DL+}** is equipped with manual override, using an arbitrary range of 1-20 clicks. The higher the number the better the dynamic gain range, and visa versa. Refer to page 74 for further info.

GATE1	0.040		
GATE1 WIDTH	OFF		
THRESHOLD1	4		
GT1	GT2	GT3	SET

3.6 GT1 – Menu

GATE1: Gates allow the user to view a specific measurement range, or sections of the waveform, and ignore others. The Gate1 feature adjusts the start of the gate, according to time/distance. Gate 1 can be used in all pulse-echo and echo-echo measurement modes. Refer to page 83 for further info.

GATE1 WIDTH: This feature allows the user to set the overall width of the gate, in terms of distance, from the starting value of Gate1. Refer to page 83 for further info.

THRESHOLD1: Enables the user to set the sensitivity level of Gate1. The amplitude of the signal must reach or exceed the threshold level before a measurement is detected. Refer to page 83 for further info.

GATE2 WIDTH	OFF		
HOLDOFF 2	0.050		
THRESHOLD2	2		
GT1	GT2	GT3	SET

3.7 GT2 – Menu

GATE2 WIDTH: This feature allows the user to set the overall width of the gate, in terms of distance, from the starting value of HoldOff2. Refer to page 83 for further info.

HOLDOFF 2: Provides the user with the ability to delay the starting point of Gate2, a specific distance from the first detection point found inside of the boundaries of the Gate 1 settings. If no detection is found, the Gate1 width value is used as a starting value for Gate2. Refer to page 83 for further info.

THRESHOLD2: Enables the user to set the sensitivity level of Gate2. The amplitude of the signal must reach or exceed the threshold level before a measurement is detected. Refer to page 83 for further info.



3.8 GT3 – Menu

GATE3 WIDTH: This feature allows the user to set the overall width of the gate, in terms of distance, from the starting value of HoldOff3. Refer to page 83 for further info.

HOLDOFF 3: Provides the user with the ability to delay the starting point of Gate3, a specific distance from the first detection point found inside of the boundaries of the Gate 2 settings. If no detection is found, the Gate2 width value is used as a starting value for Gate3. Refer to page 83 for further info.

THRESHOLD3: Enables the user to set the sensitivity level of Gate3. The amplitude of the signal must reach or exceed the threshold level before a measurement is detected. Refer to page 83 for further info.



3.9 SETUP – Menu

OPEN: Displays a list of factory and user defined setups currently stored in memory. These setups can be recalled and used at any time. Refer to page 157 for further info.

SAVE: Provides the user with the ability to save a custom setup that has been modified or created by the user. Refer to page 159 for further info.

DELETE: Provides the user with the ability to delete specific setups previously save in memory. Refer to page 163 for further info.

DEFAULT SETUP: Loads a basic default setup. Use only as a last resort when the setups in the CMX^{DL+} have been corrupted and a computer is not accessible. Refer to page 164 for further info.

LANGUAGE: Provides the user the ability to select different languages for the CMX^{DL+}. Refer to page 166 for further info.



3.10 DATA – Menu

NEW: Allows the user the ability to create a new alpha numeric grid, or sequential log file with auto identifiers. It is equipped with custom parameters, rows, and columns depending on the user’s application reporting requirements. Refer to page 132 for further info.

EDIT: Gives the user the ability to change parameters of grid or sequential file previously saved. Note: Pre-defined coordinates cannot be changed once they have been created. Refer to page 150 for further info.

OPEN: This function provides the user with the ability to recall grids or sequential log files that currently exist in memory, from a list of grids. Refer to page 152 for further info.

CLOSE: Provides the user the ability to close a currently opened grid or sequential log file. Refer to page 154 for further info.

DELETE ONE FILE: This function provides the user with the ability to delete one individual grid or sequential log file from a list of multiple grids/files previously saved in memory. Refer to page 147 for further info.

DELETE ALL DATA: This function provides the user with the ability to delete all files currently stored in memory. Refer to page 148 for further info.

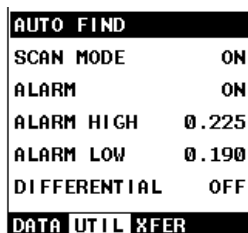

3.11 UTIL (utilities) – Menu

AUTO FIND: Automatically locates the detection point if the measurement is out of the viewable display area. Refer to page 109 for further info.

SCAN MODE: This function enables a hi speed scan mode that increases the overall sample rate from 65 to 200 measurements per second, depending on the current measurement mode used. Refer to page 109 for further info.

ALARM: Toggles alarm mode on, off, or audible. Refer to page 111 for further info.

ALARM HIGH: Gives the user the ability to set the HI limit parameter. If the measurement exceeds this value, a red light will illuminate and sound the internal beeper. Refer to page 111 for further info.

ALARM LOW: Gives the user the ability to set the LO limit parameter. If the measurement falls below this value, a red light will illuminate and sound the internal beeper. Refer to page 111 for further info.

DIFFERENTIAL: Gives the user the ability to set a nominal value and the **CMX^{DL+}** will display +/- the difference from the nominal value entered. Refer to page 113 for further info.

BACKUP	SETUPS
RESTORE	SETUPS
BACKUP	DATA
RESTORE	DATA
ABOUT	DEV 1.20A
DATA UTIL	XFER

3.12 XFER (transfer) – Menu

BACKUP SETUPS: Enables the user the ability to backup the setups currently stored in the **CMX^{DL+}** to a PC via RS232 port. Refer the help section of the **CMX^{DL+} DakView** software for a complete electronic manual.

RESTORE SETUPS: Enables the user the ability to restore the setups currently saved on a PC to an **CMX^{DL+}** via RS232 port. Refer the help section of the **CMX^{DL+} DakView** software for a complete electronic manual.

BACKUP DATA: Enables the user the ability to backup grids or sequential log files currently stored in the **CMX^{DL+}** to a PC via RS232 port. Refer the help section of the **CMX^{DL+} DakView** software for a complete electronic manual.

RESTORE DATA: Enables the user the ability to restore grids or sequential log files currently saved on a PC to an **CMX^{DL+}** via RS232 port. Refer the help section of the **CMX^{DL+} DakView** software for a complete electronic manual.

ABOUT: Provides the user with Dakota Ultrasonics contact information and the **CMX^{DL+}** software version. Refer the Dakota Ultrasonics web site for information on the latest firmware versions available for download.



3.13 CLR (clear) Key

The primary functions of the **CLR** key, is to clear a measurement from a grid or sequential log files cell location or set obstruct, and backspace in an **Alpha Edit Box**. If a user has already saved a measurement and B-Scan to a cell location, use this key to clear the measurement at any time.



3.14 MEAS (measurement mode) Key

The **MEAS** key puts the **CMX^{DL+}** into it's primary mode of operation. In this mode, the user has a complete view of the LCD.



3.15 OK Key

The primary function of the **OK** key is confirmation of a change or selection. The **OK** key also toggles the Hot Menu area, while in measurement mode, to a large digits display area. If the **CMX^{DL+}** is displaying a grid log, the **OK** key toggles an advance to row number option.



3.16 ESC Key

The **ESC** key is used in the **MENU**, **MEAS**, and **EDIT** functions as a back or escape function. If the **CMX^{DL+}** is displaying a grid or sequential log, the **OK** key toggles the display options: Digits, RF, RECT, and B-Scan views.



3.17 Arrow Keys

The **Arrow Keys** are used to navigate through the menus, increase/decrease values, and toggle specific function keys.



3.18 ENTER key

The **ENTER** key is used in the overall menu selection process, to activate list and edit boxes, display and save measurements to grid or sequential files locations.

3.19 MULTI MODE Key



The **MULTI MODE** key opens a measurement mode screen, listing all the modes that are available to the transducer specifically selected, or autodetected. The modes can be all or a combination of the entire set of modes the **CMX^{DL+}** offers, depending on which transducer is being used as follows: **Coating Off (P-E)**, **Coating On (PECT)**, **Temp Comp (PETP)**, **Thru Coat (E-E)**, **Thru Coat Verify (E-EV)**, and **Coating Only (CT)**.

3.20 ON/OFF Key



The **ON/OFF** key simply powers the unit either **ON** or **OFF**. Note: Unit will automatically power off when idle for 5 minutes. All current settings are automatically saved prior to powering off.

3.21 Top & Bottom End Caps

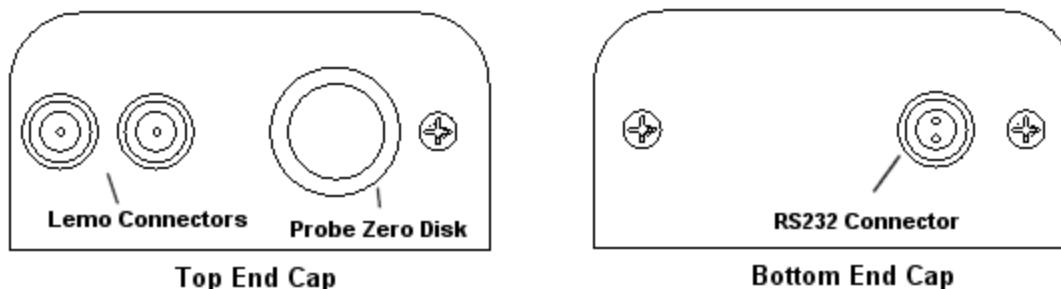

The top & bottom end panels are where all connections are made to the **CMX^{DL+}**. The diagram above shows the layout and description of the connectors:

Transducer Connectors

Refer to Diagram: The transducer connectors, and battery cover/probe zero disk are located on the **CMX^{DL+}**'s top end cap. The transducer connectors are of type Lemo "00". Note: There is no polarity associated with connecting the transducer to the **CMX^{DL+}**.

Probe Zero Disk & Battery Cover

Refer to Diagram: The Battery cover is the large round disk shown in the diagram. **Note:** This same disk is also used as a probe zero disk. Simply remove the cover when replacing the batteries (3 AA cells). When performing a manual probe zero function, simply place the transducer on disk making firm contact. **Important:** Be sure to follow the polarity labels located on the back label of the **CMX^{DL+}**. **Note:** Rechargeable batteries can be used, however they must be recharged outside of the unit in a stand alone battery charger.

RS-232 Connector

Refer to Diagram: The **RS-232** connector, located on the bottom end cap, is a 2 pin female Lemo connector. It is designed to connect directly from the **CMX^{DL+}** to a standard AT serial port on a PC. The cable supplied with the **CMX^{DL+}** is a Lemo to 9 pin serial cable. **Note:** This connector is also used to upgrade the **CMX^{DL+}** with the latest version of firmware.

USB Serial to USB Converter Cable

A converter cable can be attached to the 9 pin serial cable in needed (part no. N-402-0510).

CHAPTER FOUR PRINCIPALS OF ULTRASONIC MEASUREMENT

4.1 Time versus thickness relationship

Ultrasonic thickness measurements depend on measuring the length of time it takes for sound to travel through the material being tested. The ratio of the thickness versus the time is known as the sound velocity. In order to make accurate measurements, a sound velocity must be determined and entered into the instrument.

The accuracy of a thickness measurement therefore depends on having a consistent sound velocity. Some materials are not as consistent as others and accuracy will be marginal. For example, some cast materials are very granular and porous and as a result have inconsistent sound velocities.

While there are many different ultrasonic techniques to measure thickness, which will be discussed below, all of them rely on using the sound velocity to convert from time to thickness.

4.2 Suitability of materials

Ultrasonic thickness measurements rely on passing a sound wave through the material being measured. Not all materials are good at transmitting sound. Ultrasonic thickness measurement is practical in a wide variety of materials including metals, plastics, and glass. Materials that are difficult include some cast materials, concrete, wood, fiberglass, and some rubber.

4.3 Range of measurement and accuracy

The overall measurement capabilities, based on the wide variety of materials, is determined by the consistency of the material being measured

The range of thickness that can be measured ultrasonically depends on the material as well as the technique being used and the type of transducer. Thickness measurements can be made from a minimum of 0.010 inch to 9.999" in steel. However, the maximum attainable thickness is much less for more attenuative materials (materials that absorb sound).

Accuracy, is determined by how consistent the sound velocity is through the sound path being measured, and is a function of the overall thickness of the material. For example, the velocity in steel is typically within 0.5% while the velocity in cast iron can vary by 4%.

4.4 Couplant

All ultrasonic applications require some medium to couple the sound from the transducer to the test piece. Typically a high viscosity liquid is used as the medium. The sound frequencies used in ultrasonic thickness measurement do not travel

through air efficiently. By using a liquid couplant between the transducer and test piece the amount of ultrasound entering the test piece is much greater.

4.5 Temperature

Temperature has an effect on sound velocity. The higher the temperature, the slower sound travels in a material. High temperatures can also damage transducers and present a problem for various liquid couplants.

Since the sound velocity varies with temperature it is important to calibrate at the same temperature as the material being measured.

Normal temperature range

Most standard transducers will operate from 0°F to 180°F.

High temperature measurements

Special transducers and couplants are available for temperatures above 180°F up to 650°F with intermittent contact. It is necessary to cool the transducer, by submerging the transducer in water between readings, when measuring high temperatures.

Modes and temperature errors

In addition to errors caused by velocity changing with temperature, some modes (measurement techniques) are affected more than others. For example, dual element pulse-echo mode has larger errors due to changes in the temperature of the delay line. However, multi-echo techniques offer temperature compensation help to minimize these errors.

4.6 Measurement Modes

In this section we will discuss the different measurements modes the **CMX^{DL+}** is capable of operating in, the transducers required, and the reasons for using specific modes:

Pulse-Echo Mode (Flaw & Pit detection) – Coating Off (P-E)

Pulse-echo mode measures from the initial pulse (sometimes referred to as an artificial zero) to the first echo (reflection). In this mode, either an automatic or manual zero can be performed depending on the zero probe function setting. If the manual mode has been selected, the transducer is placed on a reference disk, located on top of the **CMX^{DL+}**, and a key is pressed to establish a zero point for the particular transducer. If the Auto Zero feature is enabled, a simple key press will perform an electronic zero to establish the same zero point.

In this mode errors result from surface coatings and temperature variations.

Since pulse-echo only requires one reflection, it is the most sensitive mode for measuring weak reflections (flaws) typically found when measuring heavily corroded metals.

V-Path Correction

Dual element delay line transducers have two piezoelectric elements mounted at an angle on one end of the delay line. One element is used for transmitting sound, while the other element only receives sound. The two elements and their delay lines are packaged in a single housing but acoustically isolated from each other with a sound barrier. This allows the transducer the ability to achieve very high sensitivity for detecting small defects. Also, the surface of the test material does not have to be as flat in order to obtain good measurements.

Dual element transducers are normally used in pulse-echo mode for finding defects, and in echo-echo mode for through coating measurements.

Dual element delay line transducers are usable over a range of 0.025 inches to 20 inches depending on the material, frequency, and diameter.

A limitation of dual element delay-line transducers is the V shaped sound path. Because the sound travels from one element to another, the time versus thickness relationship is non-linear. Therefore, a correction table in the instruments software is used to compensate for this error.

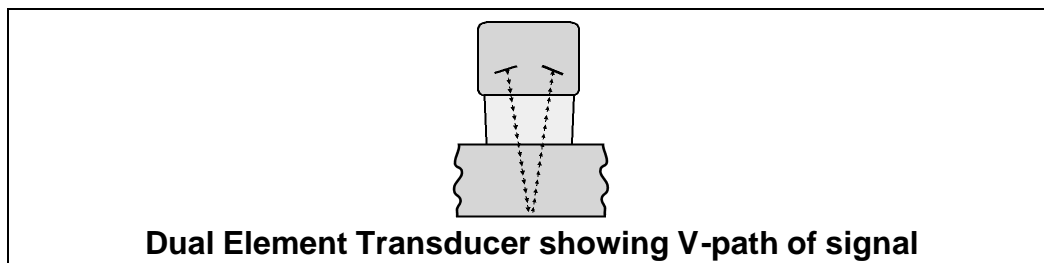

Searching for small defects

Dual element delay line transducers are especially useful in searching for small defects. In the pulse-echo mode with high amplifier gain, very small defects can be measured. This is very useful during corrosion inspections overall. The dual element style transducer will find wall deterioration, pits, and any porosity pockets during tank and pipeline inspections.

Echo-Echo Mode – Thru Coat (E-E)

The echo-echo mode measures between two reflections. This technique is commonly used to eliminate errors from surface coatings and also to make measurements in multiple layered materials. The disadvantage is that two echoes are needed which requires a much stronger echo (reflection).

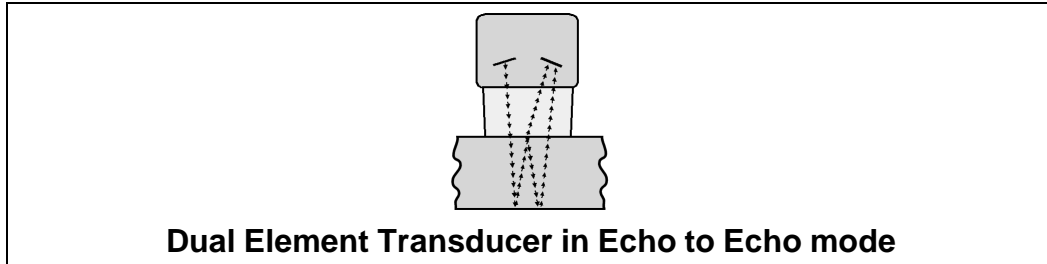

Echo-Echo Verify Mode – Thru-Verify (E-EV)

The echo-echo verify mode measures between 3 reflections. Similar to E-E mode, this technique is commonly used to eliminate errors from surface coatings and also to make measurements in multiple layered materials. The primary benefit of this mode, is that a comparison is made, between the 2nd and 3rd echoes, to verify that a peak jump has not occurred, providing an additional level of confidence to the measurement. The disadvantage is that 3 reflections are needed which requires the use of gates with controllable thresholds to adjust for sensitivity over a given measurement range.

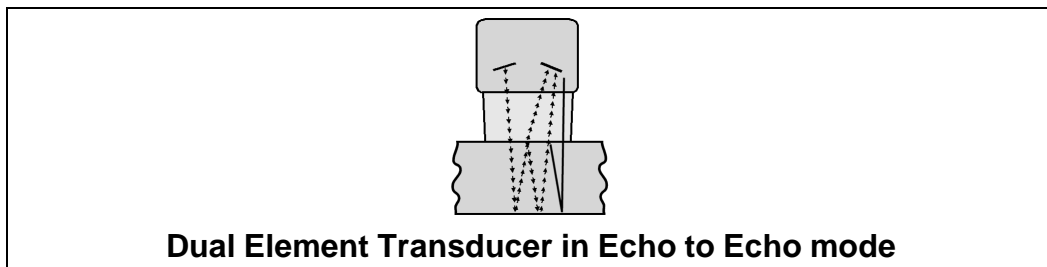

Pulse Echo Coating Mode – Coating On (PECT)

A custom hybrid combination mode using properties from the basic modes along with a group of special techniques and theoretical wave phenomena's to measure coating and material thicknesses at the same time, while still retaining the ability to locate flaws and pits in materials. Therefore, the best description for this hybrid mode is Pulse-Echo Coating mode.

Coating Mode – Coating Only (CT)

Once again, this is a custom hybrid combination mode using special techniques to effectively measure the thickness of coatings that are either adhered to metallic surfaces or in stand alone form. In this mode a two point calibration must be performed. If the user will be measuring coating that has been applied to a metal surface, the calibration must be performed using coating samples coupled to a metal surface when calibrating. To explain further, a drop of couplant must be applied in between the coating samples and metal surface. If the coating has not been applied to a metal surface, the calibration should be performed accordingly.

Pulse-Echo Temperature Compensated Mode – Temp Comp (PETP)

This is a custom mode that combines pulse-echo and electronic zero techniques to automatically adjust for temperature changes in the transducer as a result of an increasing/decreasing temperature gradient in the test material. Note: rough surface conditions can have an effect on the overall accuracy in this mode. If the surface condition is in question, the pulse-echo mode should be used in conjunction with performing an off block automatic zero as the temperature gradient changes.

CHAPTER FIVE SELECTING THE MEASUREMENT MODE

5.1 The setup library

The **CMX^{DL+}** contains 64 user configurable preset locations to store custom setups for easy recall. These setups can be optimized for the user's specific application needs and can also be stored on a PC and transferred bi-directionally using Dakota's PC interface software included with the instrument.

The setups supplied with the instrument cover some of the more typical applications commonly used with this type of instrument. These setups can be recalled, modified, and overwritten to one of 64 setup locations. Therefore, these factory setups can also be considered a good starting point to be modified for custom applications. The PC software includes a default setup file that can be uploaded to the gauge at any time to restore factory settings. However, it is recommended that the user consider saving modified setups to an empty location rather than overwriting the factory setups in the **CMX^{DL+}**. Once again, these factory settings are excellent starting points for custom setups.

5.2 Which mode & transducer do I use for my application?

High penetration plastics and castings

The most common mode for these types of applications is pulse-echo. The **CMX^{DL+}** has been optimized for cast materials. Cast iron applications require 1 - 5MHz frequencies, and cast aluminum requires a 10MHz frequency. Plastics typically require lower frequencies depending on the thickness and make-up of the material. Larger diameters offer greater penetration power because of the crystal size, for difficult to measure materials.

Corrosion & Pit Detection in steel and cast materials

Use pulse-echo mode whenever attempting to locate pits and flaws. Typically a 5MHz transducer, or higher, will be used for these types of applications. Use low frequencies for greater penetration and use higher frequencies for better resolution.

Measuring Material & Coatings

The pulse-echo coating mode should be used when both material and coating thickness are required, while still requiring the ability to detect flaws and pits. A special coating style transducer is required for use in this mode. There are a variety of coating transducers in various frequencies available from Dakota.

Thru Paint & Coatings

Often times, users will be faced with applications where the material will be coated with paint or some other type of epoxy material. Since the velocity of the coating is approximately 2.5 times slower than that of steel, pulse-echo mode will induce error if the coating or paint is not completely removed. By using echo-echo mode, the user is able to successfully measure through both, the coating and steel, and completely eliminate the thickness of the paint or coating. Therefore, the steel can be measured without having to remove the coating prior to measuring. Users will often use pulse-echo mode and echo-echo mode in conjunction when performing inspections on coated materials.

Thru coating measurements require special high damped transducers. The most common transducers are the 3.5, 5, and 7.5MHz hi damped transducers. These transducers are suitable for use in both pulse-echo and echo-echo modes. This conveniently enables the user to accurately measure overall material thickness using the thru Coating mode, and then conveniently switch to pit detection mode without changing transducers. The ¼" 5MHz Hi damped transducer is the most commonly used transducer for standard thru coating applications.

Coating Only

The coating only mode should be used when the application calls for coating measurements only and the user is not interested in the thickness of the material the coating has been applied to. This mode can also be used as a stand alone coating thickness gauge, where the coating has not been applied to another material surface. An auto identified coating probe must be attached to the **CMX^{DL+}** in order to enable this mode.

Thin materials

Use pulse echo mode and a high frequency transducer for these types of applications. The most common transducers are the 7.5MHz and 10MHz models with extra resolution. The higher frequencies provide greater resolution and a lower minimum thickness rating overall.

High temperature

Use and select a special 2.25MHz and 5 MHz High temperature transducer for these types of applications. Both pulse-echo and echo-echo modes will also work for these applications. However, echo-echo mode will eliminate error caused by temperature variations in the delay line of the transducer.

Noisy Material

Materials such as titanium, stainless steel, and aluminum may have inherent surface noise issues. This is a signal that appears at the surface of the material when using a dual element delay line probe. Select a higher frequency transducer to reduce this noise – 7.5MHz and higher for better resolution.

Restricted access

Measuring materials with extreme curvatures or restricted access, higher frequencies with smaller diameters should be considered. The smallest diameter uses 3/16" crystals with a contact area of .250". Custom transducers are available on request.

5.3 Factory Setup Chart

Num	Name	Comment 1	Gn/AGC	Velocity
1	Enter Custom Name			
2	...			
3	...			
4	...			
5	...			
6	...			
...	...			

CHAPTER SIX MAKING MEASUREMENTS

The steps involved in making measurements are detailed in this section. The following sections outline how to setup and prepare your **CMX^{DL+}** for field use.

An automatic or manual zero must always be performed. The auto zero is an off block electronic zero that does not require a zero reference block. This will most always be the zero option of choice, as it makes the zeroing process very easy and convenient to perform. However, if the manual zero option is enabled, the probe zero must be measured on the reference disk (battery disk) attached to the top of the instrument. The zero compensates for variations in the transducer. In all modes the sound velocity must be determined. The sound velocity is used to convert the transit time to a physical length. The sound velocity can be selected from a material chart in the manual, selected from a material list in the **CMX^{DL+}**, or for greater precision determined from a sample of the test material that has been mechanically measured. To enter the velocity from a table, look up the material on the chart in the appendix of this manual and refer to the section below on Calibration to a Known Velocity. To determine the velocity of a single sample, refer to the Material Calibration section on page 54.

When measuring curved materials, it is more accurate to calibrate from two test points, one at the minimum limit of the target thickness and one at the maximum limit. In this case the reference disk mounted to the **CMX^{DL+}** is not used. This is called two-point calibration and is described on page 56.

6.1 Auto Probe Recognition & Selecting The Transducer Type

The first step in using the **CMX^{DL+}** is to plug the transducer into the gauge and power the unit up. The **CMX^{DL+}** has a special built-in automatic probe recognition feature that will check to see if the probe plugged into the gauge is an auto recognized probe type. If so, the **CMX^{DL+}** will display a message indicating the transducer type and ask the user for confirmation to use the identified probe. If the transducer is not an auto recognized probe, the **CMX^{DL+}** will display a message indicating the transducer type has not been recognized, and force the user to select a transducer type from a list of transducers according to frequency and diameter. Whether the transducer is auto recognized or selected from a predefined list, the **CMX^{DL+}** will recall specific properties about the transducer. **Note:** Once the transducer has been selected, the **CMX^{DL+}** will store and recall this transducer type every time the **CMX^{DL+}** is powered on/off. The type will only change if the user physically selects another type from the list, or selects a previously saved setup. Therefore, if you have previously gone through this section and selected the transducer you are using, proceed to the next section. Use the following steps to select your transducer type. **Note:** If the transducer is not identified on power up, be sure the transducer type selected is the same as the transducer plugged into the **CMX^{DL+}**. **Failure to do this will result in erroneous measurements:**

In this first example the transducer was automatically identified:

Probe Automatically Recognized

CONFIRM

1/4IN - 5.0MHZ COAT
PROBE IDENTIFIED.

USE THIS PROBE?

OK **ESC**

- 1) Press the **OK** key once to use the identified probe, or **ESC** to display a list of optional transducers. *Note: if the **CMX^{DL+}** recognizes a specific transducer, the user should always select **OK** to use the identified probe. The only time an alternative probe should be selected from a list is if the user switched probes following initial power up and recognition, or the **CMX^{DL+}** has somehow identified the probe in error..*
- 2) Assuming the **CMX^{DL+}** recognized the probe and the **OK** key was pressed, the **CMX^{DL+}** will advance to a Zero Probe menu. If the transducer was identified as a special transducer capable of measuring coating thickness, a menu will be displayed allowing the user the ability to toggle the coating thickness display on/off as follows :



ZERO PROBE

COATING: ON

COATING: OFF

SELECT COATING
ON/OFF – REMOVE
COUPLANT FROM
PROBE AND PRESS
OK KEY TO PERFORM
THE ZERO.

OK ESC

3) Press the **UP** and **DOWN** arrow keys to toggle the coating option on/off.

4) Wipe all couplant from the transducer face and proceed to the Probe Zero section that follows .

In this second example the transducer was not identified and will force the user to select the transducer type from a predefined list of transducers:

Selecting the Transducer Type

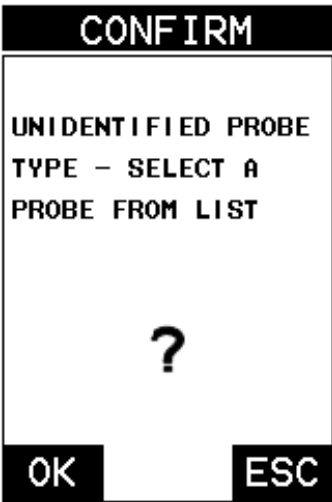

CONFIRM

UNIDENTIFIED PROBE
TYPE – SELECT A
PROBE FROM LIST

?

OK ESC

5) Press the **OK** or **ESC** keys to display the factory list of transducer types (by diameter and frequency).

PROBE TYPE	
1.	3/16IN - 5.0MHZ
2.	3/16IN - 7.5MHZ
3.	3/16IN - 10.0MHZ
4.	1/4IN - 2.25MHZ
5.	1/4IN - 5.0MHZ
6.	1/4IN - 5.0MHZ HD
7.	1/4IN - 5.0MHZ COAT
8.	1/4IN - 7.5MHZ
9.	1/4IN - 7.5MHZ HD
10.	1/4IN - 10.0MHZ
11.	1/2IN - 1.0MHZ
12.	1/2IN - 1.0MHZ CPZT
13.	1/2IN - 2.25MHZ
14.	1/2IN - 2.25MHZ CPZT
15.	1/2IN - 3.5MHZ HD
16.	1/2IN - 3.5MHZ COAT
17.	1/2IN - 5.0MHZ

- 6) Press the **UP** and **DOWN** arrow keys to scroll through the transducer list until the appropriate type is highlighted.

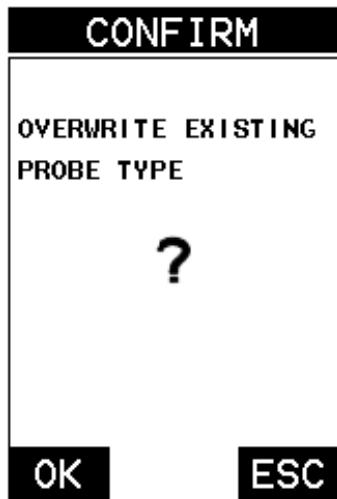

- 7) Press the **ENTER** key to select the transducer type and display overwrite existing probe screen.
- 8) Press the **OK** key to overwrite the existing probe type with the newly selected probe type. The zero probe screen will be displayed. Proceed to the zero probe section that follows.

6.2 Probe zero

The next step is to perform a probe zero. The zero function is a very important and necessary function that must be done prior to calibration. It should be done on a regular basis. In fact, the **CMX^{DL+}** has been programmed to force this issue at regular intervals during operation if it hasn't been done. If the **CMX^{DL+}** is not zeroed correctly, all the measurements taken may be in error by some fixed value. When the **CMX^{DL+}** is using the auto zero (electronic zero), the **CMX^{DL+}** can be in any measurement mode. However, when the manual zero is being used, the **CMX^{DL+}** must be in pulse-echo mode in order to perform the zero. The **CMX^{DL+}** will also see to it that this occurs by simply forcing the gauge into this mode when zero. Therefore, if the **CMX^{DL+}** is in the echo-echo measurement mode and a manual zero is being performed, the **CMX^{DL+}** will put the gauge into pulse-echo mode automatically before performing the zero. While this is a very convenient feature of the **CMX^{DL+}**, the user should be sure to check the measurement mode following calibration to be sure the **CMX^{DL+}** is in the desired mode. The following steps outline both of these techniques.

The **CMX^{DL+}** is equipped with two zero options:

- 1) **Off Block Zero (Automatic Probe Zero)** – When this feature is enabled the **CMX^{DL+}** will do an electronic zero automatically, eliminating the need for a zero disk or block.
- 2) **On Block Zero (Manual Probe Zero)** – When this feature is enabled the transducer must be placed on the probe zero disk (battery cover located on the top of the unit).

Both zero procedures are outlined as follows:

Performing an Auto Probe Zero (Off Block)

<div style="background-color: black; color: white; padding: 2px; font-weight: bold; margin-bottom: 5px;">ZERO PROBE</div> <div style="border: 1px solid black; padding: 2px; margin-bottom: 5px;">COATING: ON</div> <div style="background-color: black; color: white; padding: 2px; font-weight: bold; margin-bottom: 5px;">COATING: OFF</div> <p style="font-size: small;">SELECT COATING ON/OFF – REMOVE COUPLANT FROM PROBE AND PRESS OK KEY TO PERFORM THE ZERO.</p> <div style="display: flex; justify-content: space-around; margin-top: 5px;"> <div style="background-color: black; color: white; padding: 2px 10px; font-weight: bold;">OK</div> <div style="background-color: black; color: white; padding: 2px 10px; font-weight: bold;">ESC</div> </div>	<div style="background-color: black; color: white; padding: 2px; font-weight: bold; margin-bottom: 5px;">ZERO PROBE</div> <p style="font-size: small;">REMOVE COUPLANT FROM PROBE, PRESS OK KEY TO PERFORM THE ZERO</p> <div style="display: flex; justify-content: space-around; margin-top: 5px;"> <div style="background-color: black; color: white; padding: 2px 10px; font-weight: bold;">OK</div> <div style="background-color: black; color: white; padding: 2px 10px; font-weight: bold;">ESC</div> </div>
<i>Coating Probe Identified</i>	<i>Coating Probe Not Identified</i>

- 1) Be sure all couplant has been removed from the face of the transducer.
- 2) Press the **OK** key to perform the automatic probe zero, or **ESC** key to cancel the zero operation.

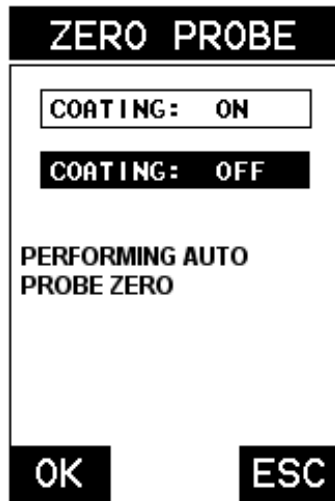

Coating Probe Identified

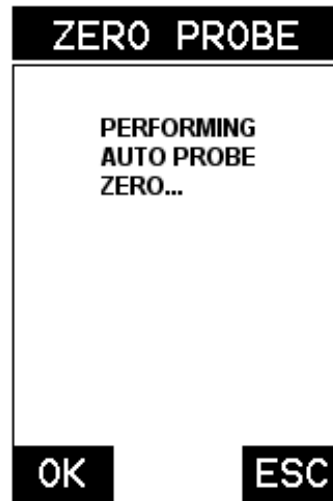

Coating Probe Not Identified

- 3) The screens illustrated above will be briefly displayed followed by the main measurement screen. The **CMX^{DL+}** is ready to be calibrated.

Performing a Manual Probe Zero (On Block)

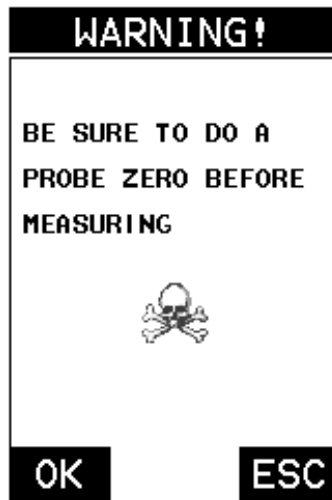

Note: When the zero probe option is set to manual, the probe zero disk (battery cap) located on the top of the gauge will be used as a zero standard and the warning screen illustrated above will be displayed.

- 1) Press the **OK** or **ESC** keys to enter the main measurement screen and begin the manual zero process.
- 2) Apply a drop of couplant on the transducer and place the transducer in steady contact with the probe zero disk and obtain a steady reading.
- 3) Press the **MENU** key once to activate the menu items tab. Press the **MENU** key multiple times to tab right and the **ESC** key multiple times to tab left until the **PRB** menu is highlighted and displaying the submenu items.
- 4) Press the **UP** and **DOWN** arrow keys to scroll through the sub menu items until **ZERO PROBE** is highlighted.

Coating Probe Identified *Coating Probe Not Identified*

- 5) Press the **ENTER** key to display the confirmation screen.
- 6) If a coating transducer was identified use the **UP** and **DOWN** arrow keys to toggle coating on/off.
- 7) Press the **OK** key to complete the probe zero function, or **ESC** key to cancel the probe zero function.
- 8) Remove the transducer from the probe zero disk, and proceed to the calibration section.

Note: The value that is displayed will change depending on the current velocity setting in the **CMX**. Disregard the number that is displayed. **It is not important.** What is important is accurately performing the steps outlined above to insure reliability of the probe zero calculation.

6.3 Material Calibration

In order for the **CMX^{DL+}** to make accurate measurements, it must be set to the correct sound velocity of the material being measured. Different types of materials have different inherent sound velocities. For example, the velocity of sound through steel is about 0.233 inches per microsecond, versus that of aluminum, which is about 0.248 inches per microsecond. If the gauge is not set to the correct sound velocity,

all of the measurements the gauge makes will be erroneous by some fixed percentage.

The **One Point** calibration is the simplest and most commonly used calibration method - optimizing linearity over large ranges. The **Two Point** calibration allows for greater accuracy over small ranges by calculating the probe zero and velocity. The **CMX^{DL+}** provides four simple methods for setting the sound-velocity outlined below:

Known Velocity

If the material velocity is known, the user may wish to simply enter the velocity number into the **CMX^{DL+}**, rather than have the **CMX^{DL+}** calculate the velocity value using a known thickness on a material sample. The steps for entering the velocity are outlined below:

Using a Known Material Velocity

CALIBRATE	
MAT	STEEL <4340>
MATL 1PT	UNCAL
MATL 2PT	UNCAL
VELOCITY	0.2330
COATING 1PT	UNCAL
COATING VEL	0.0850
PRB	CAL
DISP	TUNE

- 1) Press the **MENU** key once to activate the menu items tab. Press the **MENU** key multiple times to tab right and the **ESC** key multiple times to tab left until the **CAL** menu is highlighted and displaying the submenu items.
- 2) Use the **UP** and **DOWN** arrow keys to scroll through the sub menu items until **VELOCITY** is highlighted.

CALIBRATE	
MAT	STEEL <4340>
MATL 1PT	UNCAL
MATL 2PT	UNCAL
VELOCITY	0.2330
COATING 1PT	UNCAL
COATING VEL	0.0850
PRB	CAL DISP TUNE

- 3) Press the **ENTER** key to display the **Digits Edit Box**.
- 4) Press the **UP** and **DOWN** arrow keys to scroll the highlighted value.
- 5) Press the **LEFT** and **RIGHT** arrow keys to scroll the digit locations.
- 6) Repeat steps **4 & 5** until the velocity number is correctly displayed.
- 7) Press the **OK** key to set the velocity and return to the menu screen, or **ESC** to cancel entering the velocity.
- 8) Finally, press the **MEAS** key to return to the measurement screen and begin taking readings.

Known Thickness

Sometimes the sound velocity of a material is unknown. In this case a sample with one or two known thicknesses can be used to determine the sound velocity. As previously discussed, the **CMX^{DL+}** has a one or two point calibration option. The one point calibration option is most suited for linearity over large ranges, as noted above. The user should also consider calibrating on high side of the intended measurement range, when using the one point option, minimize overall error. For example, if the measurement range is .100" (2.54mm) to 1.0" (25.4mm), the user should calibrate on a known thickness sample close to 1.0" (25.4mm). Note: It's always handy to carry a set of mechanical calipers to use in conjunction with the **CMX^{DL+}** for calibration in the field:

One Point Calibration

CALIBRATE	
MAT	CUSTOM
MATL 1PT	1.000
MATL 2PT	UNCAL
VELOCITY	0.2330
COATING 1PT	UNCAL
COATING 2PT	UNCAL
COATING VEL	0.0850
PRB	CAL DISP TUNE

Note: Be sure that the probe zero procedure has been performed prior to performing this calibration procedure.

- 1) Physically measure an exact sample of the material or a location directly on the material to be measured using a set of calipers or a digital micrometer.
- 2) Apply a drop of couplant on the transducer and place the transducer in steady contact with the sample or actual test material. Be sure that the reading is stable and the repeatability indicator, in the top left corner of the display, is fully lit and stable. Press the **MENU** key once to activate the menu items tab. Press the **MENU** key multiple times to tab right and the

ESC key multiple times to tab left until the **CAL** menu is highlighted and displaying the submenu items.

- 3) Use the **UP** and **DOWN** arrow keys to scroll through the sub menu items until **MATL 1PT** is highlighted.



- 4) Press the **ENTER** key to display the **Digits Edit Box**.
- 5) Press the **UP** and **DOWN** arrow keys to scroll the highlighted value.
- 6) Press the **LEFT** and **RIGHT** arrow keys to scroll the digit locations.
- 7) Repeat steps **5 & 6** until the known thickness value is correctly displayed.
- 8) Press the **OK** key to calculate the velocity and return to the menu screen, or **ESC** to cancel the one point calibration.
- 9) Finally, press the **MEAS** key to return to the measurement screen and begin taking readings.

Note: CHECK YOUR CALIBRATION! Place the transducer back on the calibration point. The thickness reading should now match the known thickness. If the thickness is not correct, repeat the steps above.

At some point there may become a requirement for improved accuracy over a smaller measurement range. In this case, a two point calibration would be most suited for

the job. For example, if the measurement range was .080" (2.03mm) to .250" (6.35mm), the user would perform a one point calibration on a known thickness sample close to .250" (6.35mm), followed by a two point calibration close to .080" (2.03mm). When a two point calibration is performed, the **CMX^{DL+}** calculates the zero and the velocity. The following steps outline this procedure:

Two Point Calibration

CALIBRATE	
MAT	CUSTOM
MATL 1PT	0.250
MATL 2PT	0.080
VELOCITY	0.1865
COATING 1PT	UNCAL
COATING 2PT	UNCAL
COATING VEL	0.0850
PRB	CAL
DISP	TUNE

- 1) Physically measure an exact sample of the material or a location directly on the material to be measured using a set of calipers or a digital micrometer.
- 2) Apply a drop of couplant on the transducer and place the transducer in steady contact with the sample or actual test material. Be sure that the reading is stable and the repeatability indicator, in the top left corner of the display, is fully lit and stable. Press the **MENU** key once to activate the menu items tab. Press the **MENU** key multiple times to tab right and the **ESC** key multiple times to tab left until the **CAL** menu is highlighted and displaying the submenu items.
- 3) Use the **UP** and **DOWN** arrow keys to scroll through the sub menu items until **MATL 2PT** is highlighted.



- 4) Press the **ENTER** key to display the **Digits Edit Box**.
- 5) Press the **UP** and **DOWN** arrow keys to scroll the highlighted value.
- 6) Press the **LEFT** and **RIGHT** arrow keys to scroll the digit locations.
- 7) Repeat steps **5 & 6** until the known thickness value is correctly displayed.
- 8) Press the **OK** key to calculate the velocity and return to the menu screen, or **ESC** to cancel the one point calibration.
- 9) Finally, press the **MEAS** key to return to the measurement screen and begin taking readings.

Note: CHECK YOUR CALIBRATION! Place the transducer back on the calibration point. The thickness reading should now match the known thickness. If the thickness is not correct, repeat the steps above.

Basic Material Type

If the material velocity is unknown, and a sample thickness cannot be taken from the material, the user may opt to choose a basic material type from a list with approximate velocity values according to various material types. It's important to note that these velocities will not always be an exact representation of the material

being tested. Use these values only if a close approximation is acceptable. Follow the steps below to select a basic material type:

Selecting a Basic Material Type

CALIBRATE	
MAT	CUSTOM
MATL 1PT	1.000
MATL 2PT	UNCAL
VELOCITY	0.2330
COATING 1PT	UNCAL
COATING 2PT	UNCAL
COATING VEL	0.0850
PRB	CAL
DISP	TUNE

- 1) Press the **MENU** key once to activate the menu items tab. Press the **MENU** key multiple times to tab right and the **ESC** key multiple times to tab left until the **CAL** menu is highlighted and displaying the submenu items.
- 2) Use the **UP** and **DOWN** arrow keys to scroll through the sub menu items until **MAT** is highlighted.

MATL TYPE	
18. MONEL	0.2110
19. NICKEL	0.2220
20. NYLON	0.1060
21. PLATINUM	0.1560
22. PLEXIGLASS	0.1060
23. POLYSTYRENE	0.0920
24. PVC	0.0940
25. QUARTZ GLASS	0.2260
26. RUBBER, VULCAN	0.0910
27. SILVER	0.1420
28. STEEL (1020)	0.2320
29. STEEL (4340)	0.2330
30. STEEL, STAIN.	0.2230
31. TEFLON	0.0540
32. TIN	0.1310
33. TITANIUM	0.2400
34. TUNGSTEN	0.2040

- 3) Press the **ENTER** key to display the list of material types.

- 4) Press the **UP** and **DOWN** arrow keys to scroll through the material list until the appropriate material is highlighted.

CALIBRATE	
MAT	STEEL <4340>
MATL 1PT	1.000
MATL 2PT	UNCAL
VELOCITY	0.2330
COATING 1PT	UNCAL
COATING 2PT	UNCAL
COATING VEL	0.0850
PRB	CAL DISP TUNE

- 5) Press the **ENTER** key to overwrite the material type and display the menu items with the new material type selected.
- 6) Finally, press the **MEAS** key to return to the measurement screen and begin taking readings.

To calibrate the **CMX^{DL+}** for a specific type of coating using samples with known thicknesses, please refer to the **chapter 9 – Pulse-Echo Coating (PECT) or Coating (CT)** for a complete explanation of using the **CMX^{DL+}** for coating measurements.

CHAPTER SEVEN USING THE DISPLAY OPTIONS

A key feature of the **CMX^{DL+}** is the ability to toggle between four different display options; Digits, RF, RECT and B-Scan. All views provide a digital readout of base material and coating thickness measurements, while also displaying the alarm tolerances, if active. A key feature of the **CMX^{DL+}** is the waveform display. The waveform is a graphical representation of the sound reflections returning to the transducer. Consider standing at the base of a canyon and screaming “Hello There”. After a brief delay, you will here multiple echoes, “Hello There’s” repeated back to you. The waveform display shows the amplitude of the signal received on the vertical (Y) axis and time (shown in units of thickness) on the horizontal (X) axis. The waveform display is very useful for viewing and adjusting the location of the gates. The gates are typically used to eliminate potential surface noise by adjusting the starting point in single echo modes, for multi echo measurement modes, as well as to adjust the threshold (sensitivity) in either mode. The waveform display is also very useful for locating pits and internal flaws in materials.

The B-Scan display is also very useful when scanning surfaces and viewing the cross section of the test material. It provides a convenient way of visually profiling, or drawing a picture of, the blind surfaces during a scan. The B-Scan display is also equipped with a scan bar representing the overall thickness. The scan bar gives the user a visual indication when a flaw or defect passed over during the scan process. The scan bar will deflect off of the defect and return back to the overall thickness. Visually, this is much easier to notice than watching for changes in the digital value displayed. The scan bar has also been included in the large digits display mode for the same purpose.

Note: The following chapter outlines some of the fine adjustment features of the **CMX^{DL+}**. The **CMX^{DL+}** has four different display options (**RF A-Scan, Rectified A-Scan, B-Scan, and Large Digits**). We’ll take a better look at these options in this chapter. **Note:** In order to recall and use the new adjustments made to the **CMX^{DL+}** at a later time, the user must save the modified settings in one of the setup locations prior to powering off the unit. Refer page 157 for more information on setups.

7.1 Display Views

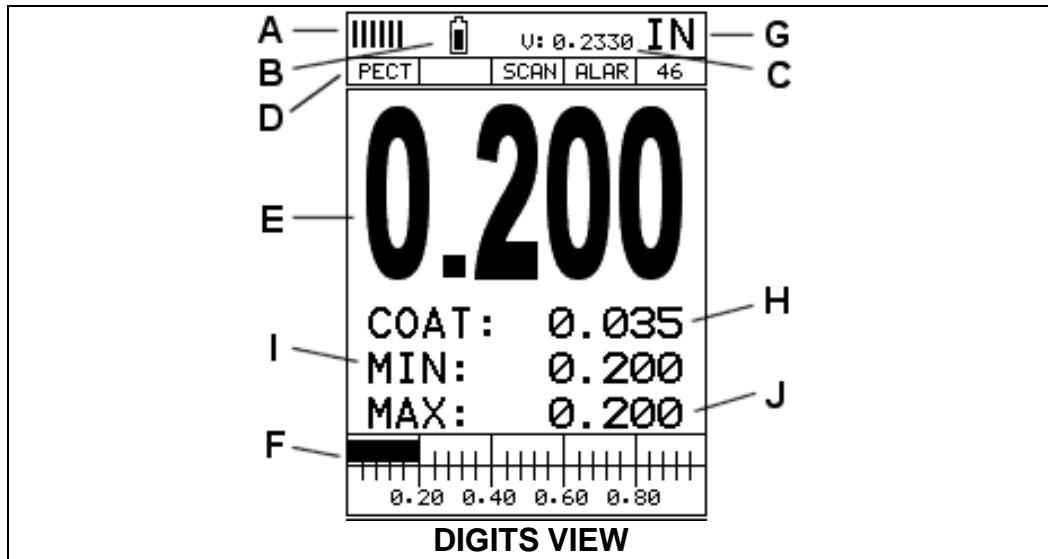

DIGITS

The Digits view is a basic digital thickness gauge look and feel. The larger digits make it much easier for the operator to monitor the thickness readings. The Scan Bar has also been added to the Digits view to provide the user with yet another visual tool for easily monitoring changes in thickness readings due to internal flaws or defects.

The following is a list of the viewable features on the display:

- A. **Repeatability/Stability Indicator** – This indicator should be commonly used in conjunction with the digital thickness values displayed. When all the vertical bars are fully illuminated and the last digit on the digital thickness value is stable, the **CMX^{DL+}** is reliably measuring the same value 3 to 200 times per second, depending on which measurement mode and features are enabled.
- B. **Battery Icon** – Indicates the amount of battery life the **CMX^{DL+}** has remaining.
- C. **Velocity** – The material velocity value the **CMX^{DL+}** is currently using or calibrated for. Displayed in English or Metric units, depending on the what units the gauge is set for.
- D. **Feature Status Bar** – Indicates the features currently enabled and in use in the following order:
 - Measurement Mode (P-E, PECT, PETP, E-E, E-EV, COAT)
 - Differential Mode (ON/OFF)
 - High Speed Scan Mode (ON/OFF)

- Alarm Mode (ON/OFF/AUDIBLE)
 - Gain Setting (VLOW, LOW, MED, HI, VHI)
- E. **Digital Material Thickness Value** – Extra large font size for viewing ease.
- F. **Scan Bar** – Another view of material thickness in a deflection style horizontal bar. This is another visual tool that would enable the user the ability to see thickness changes during high speed scans from flaws and pits.
- G. **Units** – The current measurement units being used (English, Metric).
- H. **Coating Thickness Value** – Displays the actual thickness of any coating adhered to a metallic material surface (PECT Mode), or a coating adhered to a non-metallic surface (CT Mode).
- I. **Minimum Material Thickness** – Part of the Alarm feature. Displays the minimum thickness value found during a scan.
- J. **Maximum Material Thickness** – Part of the Alarm feature. Displays the maximum thickness value found during a scan.

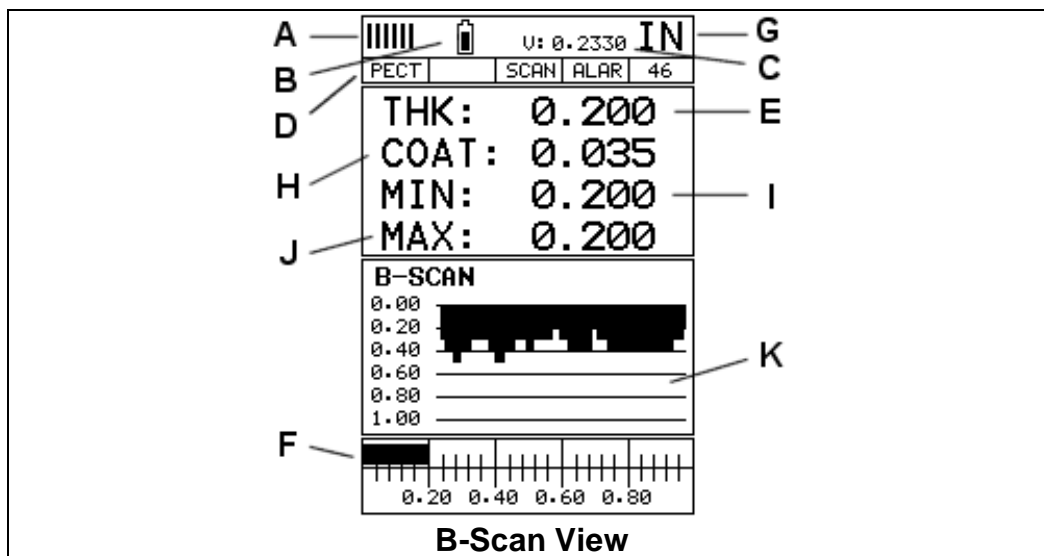

B-Scan

The B-Scan displays a time based cross section view of test material. This view is commonly used to display the contour of the blind, or underside, surface of a pipe or tank application. It is very similar to a fish finder. If a flaw or pit is located during a scan, the B-Scan will draw the pit on the screen. The solid black rectangle in the diagram at location K represents the cross section, or side view of the material. The B-Scan view draws at a rate of 7 seconds per screen from right to left. Also notice at location K, the pits and corroded bottom surface of the material.

It's important to note that the measurement range on the display be set wide enough, so that the maximum thickness of the material can be viewed on the display. Using the diagram above, if the material thickness was actually 1.75", the underside of the material would not be viewable according to the current range at 0.00" – 1.00". All

the user would see is a black screen from 0.00" – 1.00" with no view of the bottom contour at 1.75".

The following is a list of the viewable features on the display:

- A. **Repeatability/Stability Indicator** – This indicator should be commonly used in conjunction with the digital thickness values displayed. When all the vertical bars are fully illuminated and the last digit on the digital thickness value is stable, the **CMX^{DL}** is reliably measuring the same value 3 to 200 times per second, depending on which measurement mode and features are enabled.
- B. **Battery Icon** – Indicates the amount of battery life the **CMX^{DL}** has remaining.
- C. **Velocity** – The material velocity value the **CMX^{DL}** is currently using or calibrated for. Displayed in either English or Metric units, depending on the what units the gauge is set for.
- D. **Feature Status Bar** – Indicates the features currently enabled and in use in the following order:
 - Measurement Mode (P-E, PECT, PETP, E-E, COAT)
 - Differential Mode (ON/OFF)
 - High Speed Scan Mode (ON/OFF)
 - Alarm Mode (ON/OFF/AUDIBLE)
 - Gain Setting (VLOW, LOW, MED, HI, VHI)
- E. **Digital Material Thickness Value** – Smaller font size when the B-Scan display view is enabled.
- F. **Scan Bar** – Another view of material thickness in a deflection style horizontal bar. This is another visual tool that would enable the user the ability to see thickness changes during high speed scans from flaws and pits.
- G. **Units** – The current measurement units being used (English, Metric).
- H. **Coating Thickness Value** – Displays the actual thickness of any coating adhered to a metallic material surface (PECT Mode), or a coating adhered to a non-metallic surface (CT Mode).
- I. **Minimum Material Thickness** – Part of the Alarm feature. Displays the minimum thickness value found during a scan.
- J. **Maximum Material Thickness** – Part of the Scan feature. Displays the maximum thickness value found during a scan.
- K. **B-Scan Display** – Cross section view of the material. Provides the user with graphical view of the opposite/blind surface (i.e. inside pipe wall surface), to give the user some idea of the condition, or integrity of the material being tested.

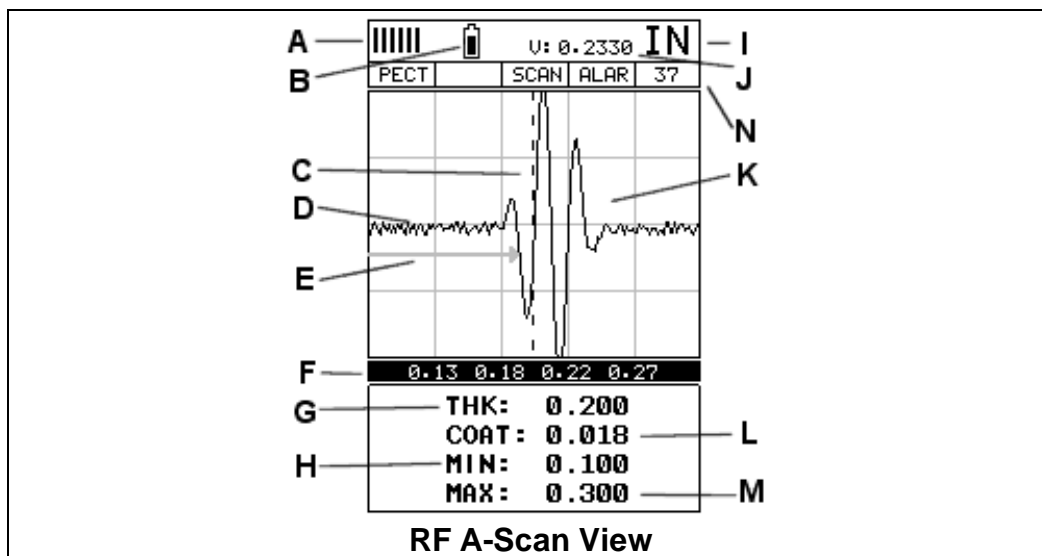

Radio Frequency (RF) A-Scan

The RF mode shows the waveform in a similar fashion to an oscilloscope. It shows both the positive and the negative peaks. The peak (either positive or negative) selected for measurement is shown in upper portion of the display.

It's important to note that a measurement must fall inside the displays viewable range in order to see the waveform. However, even if the waveform is outside of the viewable range of the display, a measurement can be taken and viewed on the digital readout. If the wave is outside of the display range, you can manually change the range by adjusting the **Delay** and **Width** values, or you can use the **Auto Find** feature located in the **UTIL** menu of the tabbed menu items. Refer to page 109 for additional information on the **Auto Find** feature.

The following is a list of the viewable features on the display:

- A. **Repeatability/Stability Indicator** – This indicator should be commonly used in conjunction with the digital thickness values displayed. When all the vertical bars are fully illuminated and the last digit on the digital thickness value is stable, the **CMX^{DL+}** is reliably measuring the same value 3 to 200 times per second, depending on which measurement mode and features are enabled.
- B. **Battery Icon** – Indicates the amount of battery life the **CMX^{DL+}** has remaining.
- C. **Detect Indicator** – The broken vertical line displays the zero crossing (flank) detection point on the waveform where the measurement has been obtained. Notice that the digital thickness readout is the same as the location of the detect indicator according to the measurements labels F, also in the diagram.
- D. **Baseline** - The horizontal trace across the A-scan presentation for a no signal condition. It represents time and is generally related to material distance or thickness.

- E. **Gate** – An electronic feature that allows the user to monitor signals inside the boundaries of the gate settings. The height of the gate from the baseline is known as the threshold, and controls the sensitivity of the reflections that trigger a detection from the opposite surface of the material.
- F. **Measurement Scale** – Represents thickness values over a defined measurement range, and labeled at the calibrated hash marks on the display (X) axis.
- G. **Digital Material Thickness Value** – The thickness of the base material.
- H. **Minimum Thickness Value** – Dynamically updates the value during a scan, and displays the minimum thickness value found. Note: Only visible when high speed scan mode is enabled.
- I. **Units** – The current measurement units being used (English, Metric).
- J. **Velocity** – The material velocity value the **CMX^{DL}** is currently using or calibrated for. Displayed in either English or Metric units, depending on what units the gauge is set for.
- K. **RF waveform** – The sine wave created by the reflected sound, or oscillation, from the material being measured. The both the positive and negative half cycles (full cycles) are displayed.
- L. **Coating Thickness Value** – Displays the actual thickness of any coating adhered to a metallic material surface (PECT Mode), or a coating adhered to a non-metallic surface (CT Mode).
- M. **Minimum Thickness Value** – Dynamically updates the value during a scan, and displays the minimum thickness value found. Note: Only visible when high speed scan mode is enabled.
- N. **Feature Status Bar** - Indicates the features currently enabled and in use in the following order:
 - Measurement Mode (P-E, PECT, PETP, E-E, COAT)
 - Differential Mode (ON/OFF)
 - High Speed Scan Mode (ON/OFF)
 - Alarm Mode (ON/OFF/AUDIBLE)
 - Gain Setting (VLOW, LOW, MED, HI, VHI)

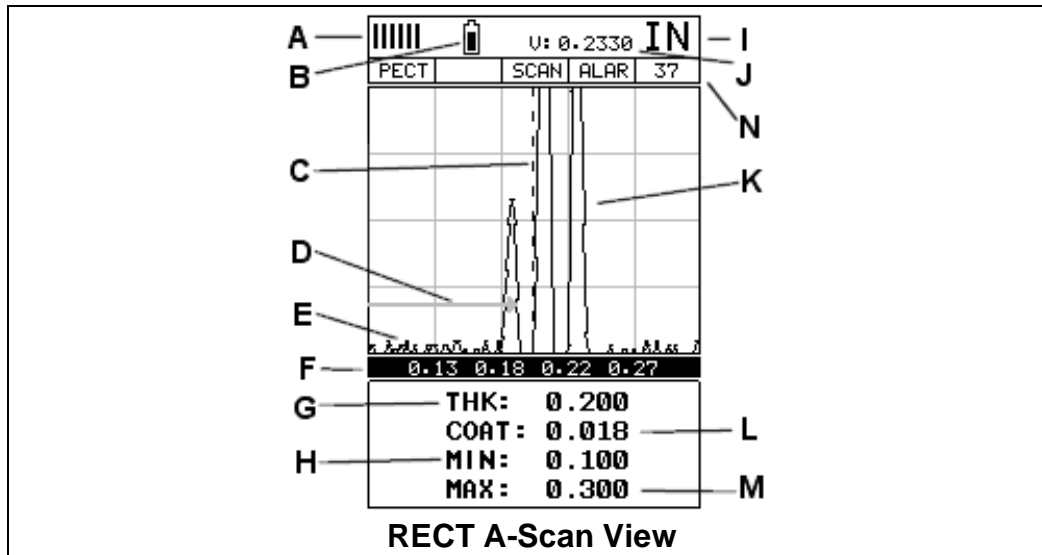

Rectified (RECT) A-Scan

The RF mode shows the waveform in a similar fashion to an oscilloscope. It shows both the positive and the negative peaks. The peak (either positive or negative) selected for measurement is shown in upper portion of the display.

It's important to note that a measurement must fall inside the displays viewable range in order to see the waveform. However, even if the waveform is outside of the viewable range of the display, a measurement can be taken and viewed on the digital readout. If the wave is outside of the display range, you can manually change the range by adjusting the **Delay** and **Width** values, or you can use the **Auto Find** feature located in the **UTIL** menu of the tabbed menu items. Refer to page 109 for additional information on the **Auto Find** feature.

The following is a list of the viewable features on the display:

- A. **Repeatability/Stability Indicator** – This indicator should be commonly used in conjunction with the digital thickness values displayed. When all the vertical bars are fully illuminated and the last digit on the digital thickness value is stable, the **CMX^{DL+}** is reliably measuring the same value 3 to 200 times per second, depending on which measurement mode and features are enabled.
- B. **Battery Icon** – Indicates the amount of battery life the **CMX^{DL+}** has remaining.
- C. **Detect Indicator** – The broken vertical line displays the zero crossing (flank) detection point on the waveform where the measurement has been obtained. Notice that the digital thickness readout is the same as the location of the detect indicator according to the measurements labels F, also in the diagram.
- D. **Baseline** - The horizontal trace across the A-scan presentation for a no signal condition. It represents time and is generally related to material distance or thickness.

- E. **Gate** – An electronic feature that allows the user to monitor signals inside the boundaries of the gate settings. The height of the gate from the baseline is known as the threshold, and controls the sensitivity of the reflections that trigger a detection from the opposite surface of the material.
- F. **Measurement Scale** – Represents thickness values over a defined measurement range, and labeled at the calibrated hash marks on the display (X) axis.
- G. **Digital Material Thickness Value** – The thickness of the base material.
- H. **Minimum Thickness Value** – Dynamically updates the value during a scan, and displays the minimum thickness value found. Note: Only visible when high speed scan mode is enabled.
- I. **Units** – The current measurement units being used (English, Metric).
- J. **Velocity** – The material velocity value the **CMX^{DL+}** is currently using or calibrated for. Displayed in either English or Metric units, depending on what units the gauge is set for.
- K. **RECT waveform** – The half cycle, either positive or negative, of the RF sine wave, created by the reflected sound, or oscillation, from the material being measured. This view is typically considered as “flaw” view.
- L. **Coating Thickness Value** – Displays the actual thickness of any coating adhered to a metallic material surface (PECT Mode), or a coating adhered to a non-metallic surface (CT Mode).
- M. **Minimum Thickness Value** – Dynamically updates the value during a scan, and displays the minimum thickness value found. Note: Only visible when high speed scan mode is enabled.
- N. **Feature Status Bar** - Indicates the features currently enabled and in use in the following order:
 - Measurement Mode (P-E, PECT, PETP , E-E, COAT)
 - Differential Mode (ON/OFF)
 - High Speed Scan Mode (ON/OFF)
 - Alarm Mode (ON/OFF/AUDIBLE)
 - Gain Setting (VLOW, LOW, MED, HI, VHI)

7.2 Changing Display Options

The following procedure outlines how to select or toggle display options:

Changing Display Options

SET DISPLAY	
VIEW	RF
DELAY	0.086
RANGE	0.229
UNITS	IN
BACKLIGHT	OFF
CONTRAST	10
RECT WAVE	OUTLINE
DETECT MARK	DOTS
PRB	CAL
DISP	TUNE

SET DISPLAY	
VIEW	RF
DELAY	0.000
RANGE	1.000
B-SCAN SPEED	6
UNITS	IN
BRIGHTNESS	20
VIEW	GREEN 2
DIM	OFF
RECT WAVE	OUTLINE
DETECT MARK	DOTS
PRB	CAL
DISP	TUNE

Grayscale VGA **Color VGA**

- 1) Press the **MENU** key once to activate the menu items tab. Press the **MENU** key multiple times to tab right, and the **ESC** key multiple times to tab left, until the **DISP** menu is highlighted and displaying the submenu items.
- 2) Use the **UP** and **DOWN** arrow keys to scroll through the sub menu items until **VIEW** is highlighted.
- 3) Use the **LEFT** and **RIGHT** arrow keys to scroll the view options. Once the appropriate view is displayed, press the **MEAS** key to return to the measurement screen and begin taking measurements.

7.3 Adjusting the display

This section will cover the procedures for adjusting the viewable range, or area, of the display, in terms of thickness. A basic overview of this section would be as follows: Suppose we had a 50" widescreen television set. Assume that you're watching the television for rest of this explanation. The left side of the television screen is considered the **Delay** for all view options other than B-Scan. In B-Scan view, it's called **B-Start**. Therefore, **Delay (B-Start)** are *identical*, with the exception of the terminology used, and represent the left side of the television screen.

The right side of the television screen is considered the **Range + Delay**, in all view options with the exception of B-Scan, once again. In B-Scan view, it would be considered **B-Depth + B-Start**. Therefore, the following should be considered: **Delay (B-Start) + Range (B-Depth) = right side of the screen**, depending on what view option is active.

Now, by adjusting the left and right side of the television screen, to control the viewable area/range, we can zoom in and out of any part of the 50" screen we'd like, and focus on only the specific areas of the screen we need to. Therefore, if I am measuring a part, and am only interested in viewing the thickness range/area from .500" – 1.0", and I'd like to zoom in a bit to get a close up look at things, I'd set my Delay (B-Start) to .500" and my Range (B-Depth) to .500". This would make the left side of my screen start at .500", and the right side of the screen at 1.0".

Setting the Delay (B-Start)

The Delay (B-Start) represents the left side of the display, and can be adjusted to start at any thickness value within the overall range of the CMX^{DL+}. The value the Delay (B-Start) is set too, is the minimum thickness value that will be displayed on the screen.

Note: Once the delay is set, it will remain the same for the views: Digits, RF, RECT. However, in B-Scan view, the B-Start is an independent setting from Delay, and allow the user to store two independent settings respectively.

The procedures to adjust the **Delay (B-Start)** are outlined below:

Adjusting Delay (B-Start) using the Hot Menu

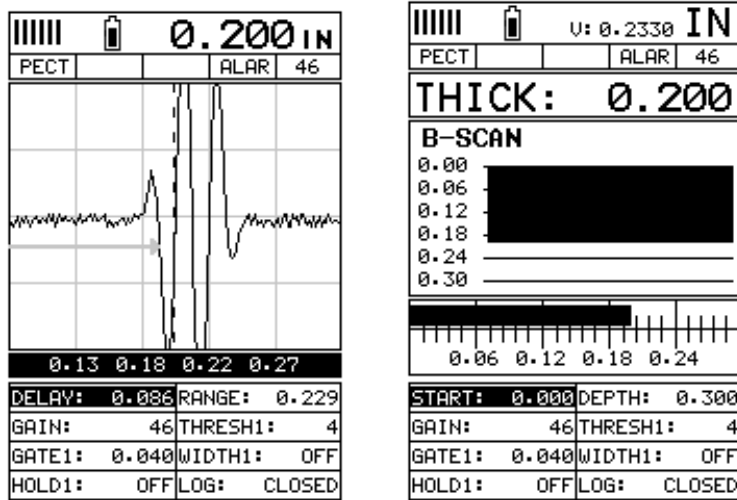

- 1) Press the **MEAS** key once to activate measure menu items. Press the **MEAS** key multiple times to move right and the **ESC** key multiple times to move left, until the **DELAY** cell is highlighted.
- 2) Press the **UP**, **DOWN**, **LEFT**, and **RIGHT** arrow keys to scroll the highlighted value.

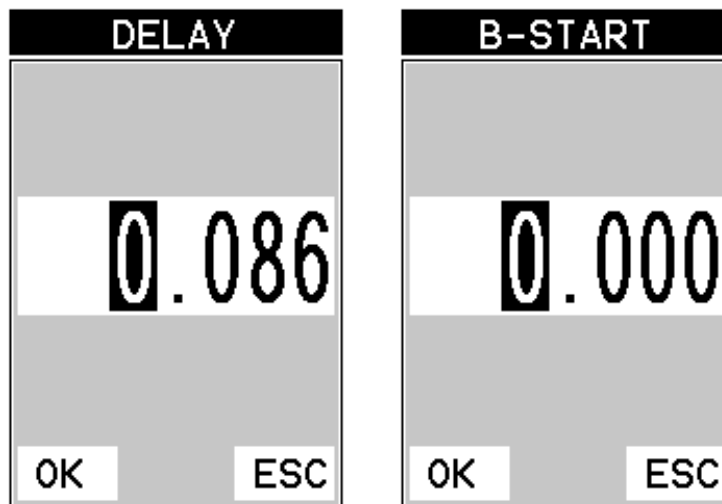

- 3) **Alternatively**, press the **ENTER** key to display the **Digits Edit Box**.
- 4) Press the **UP** and **DOWN** arrow keys to scroll the highlighted value.

- 5) Press the **LEFT** and **RIGHT** arrow keys to scroll the digit locations.
- 6) Repeat steps 4 & 5 until the **DELAY** value is correctly displayed.
- 7) Press the **OK** key to return to the measurement screen, or **ESC** to cancel entering the **DELAY**.
- 8) Finally, press the **MEAS** key to return to the measurement screen and begin taking readings.

Adjusting the Range (B-Depth)

Once again, just to reiterate, the **Range (B-Depth) + Delay (B-Start) equals the right side of the screen**. Therefore, the Range (B-Depth) is the overall area, from the delay, that will be viewable on the screen. The **CMX^{DL+}** digitizer will round up from the Range (B-Depth) that's entered. Therefore, if the Range (B-Depth) is set at 1.0", the digitizer will round this value up to the next adjustment available. The procedures to adjust the overall thickness range viewed Range (B-Depth) are outlined below:

Adjusting the Range (B-Depth) using the Hot Menus

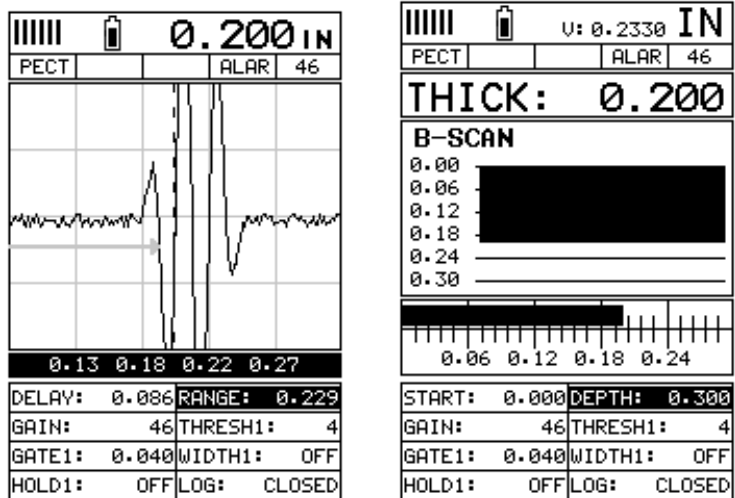

- 1) Press the **MEAS** key once to activate measure menu items. Press the **MEAS** key multiple times to move right and the **ESC** key multiple times to move left, until the **WIDTH** cell is highlighted.

- 2) Press the **UP**, **DOWN**, **LEFT**, and **RIGHT** arrow keys to scroll the highlighted value.

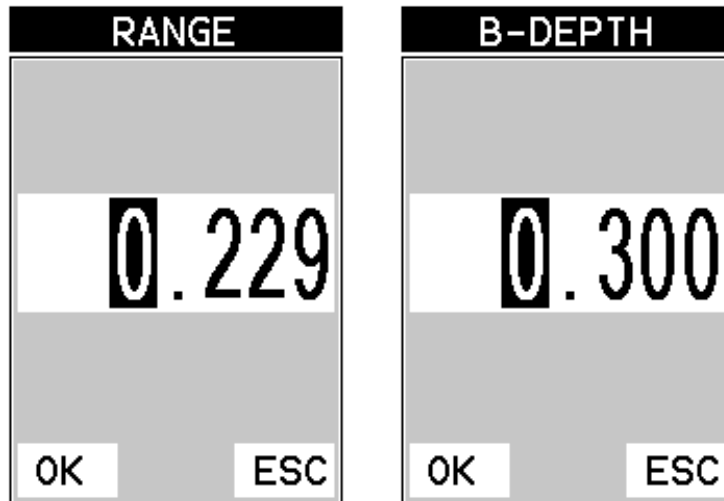

- 3) **Alternatively**, press the **ENTER** key to display the **Digits Edit Box**.
- 4) Press the **UP** and **DOWN** arrow keys to scroll the highlighted value.
- 5) Press the **LEFT** and **RIGHT** arrow keys to scroll the digit locations.
- 6) Repeat steps 4 & 5 until the **WIDTH** value is correctly displayed.
- 7) Press the **OK** key to return to the measurement screen, or **ESC** to cancel entering the **WIDTH**.
- 8) Finally, press the **MEAS** key to return to the measurement screen and begin taking readings.

Adjusting the B-Scan Speed (*color version only*)

The color version of the **CMX^{DL+}** has the capability to adjust the the scrolling speed of the time based B-Scan displayed in the gauge. The procedures to adjust the speed are outlined below:

Adjusting the B-Scan Speed

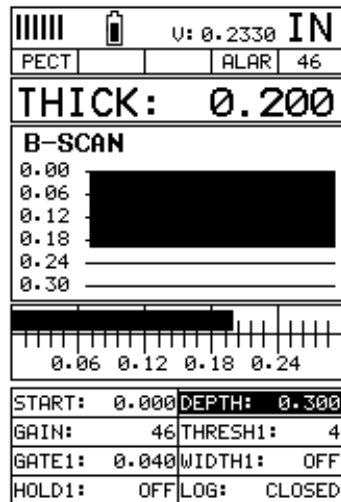

- 1) Press the **MENU** key once to activate the menu items tab. Press the **MENU** key multiple times to tab right, and the **ESC** key multiple times to tab left, until the **DISP** menu is highlighted and displaying the submenu items.
- 2) Use the **UP** and **DOWN** arrow keys to scroll through the sub menu items until **B-SCAN SPEED** is highlighted.
- 3) Use the **LEFT** and **RIGHT** arrow keys to scroll the speed from 0-10. Note: 10 representing the fastest scroll time. Once the appropriate speed is displayed, press the **MEAS** key to return to the measurement screen and begin the B-Scan process.
- 4) **Alternatively**, press the **ENTER** key to display the **Digits Edit Box**.
- 5) Press the **UP** and **DOWN** arrow keys to scroll the highlighted value.
- 6) Press the **LEFT** and **RIGHT** arrow keys to scroll the digit locations.
- 7) Repeat steps 5 & 6 until the **SPEED** is correctly displayed.

- 8) Press the **OK** key to set the speed and return to the **DISP** menu., followed by pressing the **MEAS** key to begin the B-Scan process.
- 9) Finally, press the **MEAS** key to return to the measurement screen and begin the scanning process.

7.4 Gain

The gain, or amplification of the return echoes, can be adjusted in the **CMX^{DL+}** to accommodate a variety of applications. The setting of the gain is crucial in order to obtain valid readings during the measurement process. Too much gain may result in erroneous measurements, by detecting on noise rather than the actual material back wall itself. Not enough gain may result in intermittent detection. It may also result in lack of detection on internal flaws, pits, or porosity. The gain can easily be compared to the volume control of a home stereo system. If you turn it up too much, you can't hear the music clearly. If it's turned down too much, you can't hear it at all.

The **CMX^{DL+}** has 110dB gain range, but has been limited to a 60dB gain range (-10 to 50 dB), for thickness gauge applications. The common starting point for standard thickness gauge applications is 46dB. This feature is used to increase/decrease the power or amplitude of the signal. When used in conjunction with the attenuator feature, it has a limited overall gain range of -30dB to 70dB.

The gain can be adjusted to accommodate a variety of material types. Having this feature available, provides the user with a great deal of flexibility. Some applications may require the lower or higher gain settings. When? The low settings may be necessary for noisy or granular cast materials. How do I know when to lower the gain? If the reading becomes sporadic and won't settle down or resolve on a thickness value, the user can assume that the material is either very noisy aluminum, or granular cast iron. This would be a good time to change the **CMX^{DL+}** to lower gain setting and see if the reading settles down and become stable.

How do I know when to increase the gain? Often times the user will be trying to measure a material that is hard to penetrate or pass sound through. This may be due to the material type, or overall thickness of the material. When a material is hard to pass sound through because of the thickness or general make-up, it would be a good time to consider increasing the **CMX^{DL+}** to a higher gain setting. Another example might be the need to increase overall sensitivity for locating fine pits or flaws. In any case, the adjustable gain feature offers the user some additional options to resolve and overcome application issues.

Note: When the echo-echo thru-paint, or echo-echo-verify measurement modes are selected, the manual gain feature is disabled and grayed out in the menu items. In this mode, the **CMX^{DL+}** switches to an automatic gain mode (**AGC**) that optimizes the gain setting automatically in the hardware of the **CMX^{DL+}**.

The procedures to adjust the **Gain** are outlined below:

Adjusting the Gain using the Hot Menus

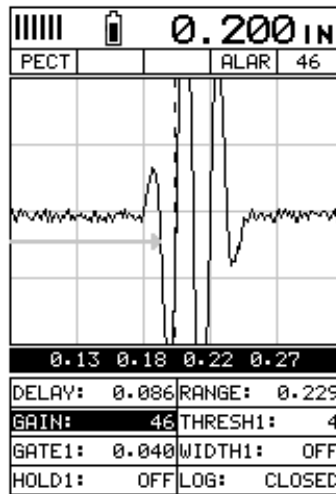

- 1) Press the **MEAS** key once to activate measure menu items. Press the **MEAS** key multiple times to move right, and the **ESC** key multiple times to move left until the **GAIN** cell is highlighted.
- 2) Press the **UP**, **DOWN**, **LEFT**, and **RIGHT** arrow keys to scroll the highlighted value.

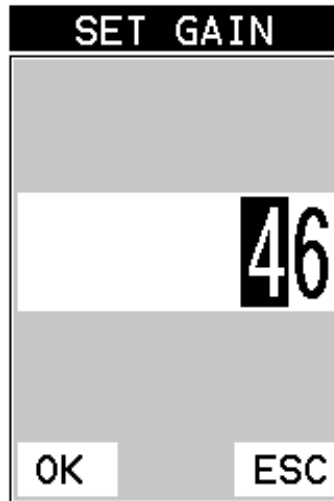

- 3) **Alternatively**, press the **ENTER** key to display the **Digits Edit Box**.
- 4) Press the **UP** and **DOWN** arrow keys to scroll the highlighted value.
- 5) Press the **LEFT** and **RIGHT** arrow keys to scroll the digit locations.
- 6) Repeat steps **4 & 5** until the **GAIN** value is correctly displayed.
- 7) Press the **OK** key to return to the measurement screen, or **ESC** to cancel entering the **GAIN**.

The user can also access and adjust the gain from the tabbed menus. However, this method is more tedious than making the adjustments using the **Hot Menu**. The procedure using the tabbed menu is outlined below:

Adjusting the Gain using the Tabbed Menus

TUNE SIGNAL	
MEASURE MODE	PECT
POLARITY	NEGATIVE
PULSE	THIN
PULSER VOLT	150
ATTN	0 DB
GAIN	46
AGC	0
PRB	CAL DISP TUNE

- 1) Press the **MENU** key once to activate the menu items tab. Press the **MENU** key multiple times to tab right, and the **ESC** key multiple times to tab left, until the **TUNE** menu is highlighted and displaying the submenu items.
- 2) Use the **UP** and **DOWN** arrow keys to scroll through the sub menu items until **GAIN** is highlighted.
- 3) Press the **LEFT** and **RIGHT** arrow keys to scroll the value. When the correct **Gain** is being displayed, **proceed to step 8**.

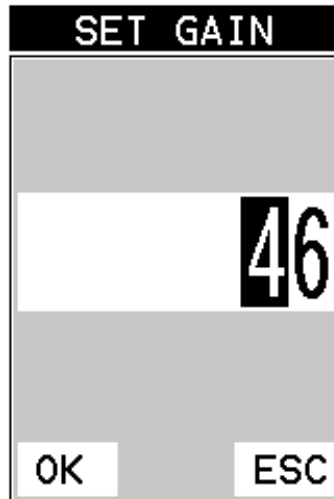

- 4) **Alternatively**, press the **ENTER** key to display the **Digits Edit Box**.
- 5) Press the **UP** and **DOWN** arrow keys to scroll the highlighted value.
- 6) Press the **LEFT** and **RIGHT** arrow keys to scroll the digit locations.
- 7) Repeat steps **5 & 6** until the **Gain** value is correctly displayed.
- 8) Press the **OK** key to set the **Gain** and return to the menu screen, or **ESC** to cancel entering the **Gain**.
- 9) Finally, press the **MEAS** key to return to the measurement screen and begin taking readings.

7.5 Threshold

The **Threshold** is the level (sensitivity) of the signal amplitude required to trigger the thickness reading. This level can be used in conjunction with the gain. Example: suppose the user can visually see a potential flaw on the display, but the **CMX^{DL+}** is not detecting on the flaw because the **Gain** is too low, or the **Threshold** too high. The **Threshold** level can be decreased (lower sensitivity) in order to detect signals with lower amplitudes. This will allow the amplitude from the reflection of the flaw to reach and exceed the **Threshold** level, and enable the **CMX^{DL+}** to detect on the flaw or defect. This can also be accomplished by increasing the **Gain**, allowing the signal to exceed the current **Threshold** level. Lowering the **Threshold** (increases sensitivity), and raising the **Threshold** decreases the sensitivity respectively.

The **CMX^{DL+}** is equipped with 3 independent gates, each with an adjustable threshold level. All three gates can be enabled in any of the pulse echo modes, and in echo-echo verify mode, and the thresholds set at varying levels of sensitivity. This allows the user to create a pseudo make-shift “time corrected gain” function, by increasing the sensitivity of each gate at different thickness values. A visual example would be an upside down stair case, where each step represented a separate gate, for a specific thickness range.

The procedures to adjust the **Thresholds** are outlined below:

Adjusting the Thresholds using the Hot Menu

DELAY: 0.086	RANGE: 0.229
GAIN: 46	THRESH1: 4
GATE1: 0.040	WIDTH1: OFF
HOLD2: 0.050	LOG: CLOSED

DELAY: 0.086	RANGE: 0.229
GAIN: 46	THRESH2: 2
GATE1: 0.040	WIDTH2: OFF
HOLD2: 0.050	LOG: CLOSED

DELAY: 0.086	RANGE: 0.229
GAIN: 46	THRESH3: 1
GATE1: 0.040	WIDTH3: OFF
HOLD3: 0.050	LOG: CLOSED

THRESHOLDS	
THRESHOLD1	4
THRESHOLD2	2
THRESHOLD3	1

- 1) Press the **MEAS** key once to activate measure menu items. Press the **MEAS** key multiple times to move right and the **ESC** key multiple times to move left, until the **THRESH(1-3)** cell is highlighted.

- 2) If the correct **THRESHOLD** is displayed, press the **UP**, **DOWN**, **LEFT**, and **RIGHT** arrow keys to scroll the highlighted value.

THRESHOLDS	
THRESHOLD1	4
THRESHOLD2	2
THRESHOLD3	1

- 3) **Alternatively**, if the correct **Threshold** is not being displayed, press the **ENTER** key to display the **List Box**.
- 4) Use the **UP** and **DOWN** arrow keys to scroll through the **List Box** items until the correct **THRESHOLD** is highlighted.
- 5) Press the **MEAS** key to return to the measure screen and **Hot Menu** items.
- 6) Press the **UP**, **DOWN**, **LEFT**, and **RIGHT** arrow keys to scroll the highlighted value.
- 7) Repeat steps **3-6** until all the **THRESH** values are correctly adjusted.

The user can also access and adjust the **Threshold** from the tabbed menus. However, this method is more tedious than making the adjustments using **the Hot Menus**. The procedure for using the tabbed menus is outlined below:

Adjusting the Thresholds using the Tabbed Menus

GATE1	0.040
GATE1 WIDTH	OFF
THRESHOLD1	4
GT1	GT2
GT3	SET

- 1) Press the **MENU** key once to activate the menu items tab. Press the **MENU** key multiple times to tab right, and the **ESC** key multiple times to tab left, until the **GT1** menu is highlighted and displaying the submenu items.
- 2) Use the **UP** and **DOWN** arrow keys to scroll through the sub menu items until **THRESHOLD1** is highlighted.
- 3) Press the **LEFT** and **RIGHT** arrow keys to scroll the value. When the correct threshold is being displayed, **proceed to step 8**.

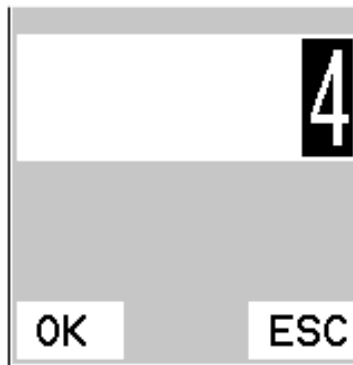

- 4) **Alternatively**, press the **ENTER** key to display the **Digits Edit Box**.
- 5) Press the **UP** and **DOWN** arrow keys to scroll the highlighted value.
- 6) Press the **LEFT** and **RIGHT** arrow keys to scroll the digit locations.
- 7) Repeat steps **5 & 6** until the **Threshold** number is correctly displayed.
- 8) Press the **OK** key to set the **Threshold** and return to the menu screen, or **ESC** to cancel entering the **Threshold**.
- 9) Repeat steps **1-8** to set any additional **Threshold** level.

10) Finally, press the **MEAS** key to return to the measurement screen and begin taking readings.

7.6 Understanding the features of the Gate

Important: It is recommended to spend some time in this section. The sections that follow are procedures for using the features associated with the Gates, in some way. There are 3 gates in the CMX^{DL+}, and as a result, operating and setting them up can become somewhat convoluted, to say the least. However, a thorough understanding of the functionality presented in this section, will reveal how easy they actually are to operate overall. The following diagrams illustrate the features of all 3 gates, according to the measurement mode selected:

Note: This is a general overview and should be referred to in conjunction with the detailed feature sections that follow.

Modes	# Gates	Gate #	Start	HoldOff	Width	Threshold
PE	1,2,or 3	1	v		v	v
		2			v	v
		3			v	v
PECT	1,2,or 3	1	v		v	v
		2			v	v
		3			v	v
PETP	1,2,or 3	1	v		v	v
		2			v	v
		3			v	v
EE	2	1	v			v
		2		v	v	v
		3				
EEV	3	1	v			v
		2		v		v
		3		v		v
CT	None	None	None	None	None	None

Diag. 1 Gate Features vs Modes

In **diagram 1**, the gates have been associated with the measurement modes, along with the features available to every gate. For example, echo-echo mode (EE) has 2 gates available, while echo-echo verify (EEV) has 3. These gates have been designed to work in order, from 1 to 3, and cannot be used any other way.

Therefore, the user must be using gate 2 before they can activate and use gate 3.

Note: Gate 1 is on at all times, as a gate must be activated to get a measurement. Each gate has a given set of features to fine adjust the settings of the gate. Let's have a look at the feature set:

Start (Gate1): This feature is only available to gate 1, and determines the start value of the left side of the gate. For example, if there's a great deal of noise from the initial

pulse, or in the material, the gate can be moved to the right of the noise and block the unwanted noise. Gates 2 and 3 will automatically start from the end of gate 1, or from a detection found inside of the boundaries of gate 1. Therefore, we use a hold-off delay as a start feature for gates 2 and 3. See Diagram 2.

Hold-Off: The hold-off is the starting point of the left side of gates 2 & 3, and is used only if a detection is found inside the previous gate. It should be considered a delay from the detection point of the previous gate. When the hold-off is off, or 0, the gate will start at the point of detection from the previous gate. As the value of the hold-off is increased, it is further delaying the start of the gate to the right of the detection of the previous gate. **Note:** Although we've used the terminology of hold-off for gate 3, it is actually a "hold-back" from the detection of the second echo. Therefore, as the value is increased, the "hold-back" moves closer to the second detection. Just the opposite of the operation of gate 2 hold-off. See diagram 2.

Width: The width determines the physical length of the gate. Therefore, the width – start (hold-ff) equals the length of the gate, as the start (hold-off) value is not equal to zero. If no detection is located inside the boundaries of a gate, the width value is used to start the next available gate. **Key point:** *When the width is activated for a gate, giving it a value, the next available gate is also activated. Therefore, activating width1 of gate1, activates gate2, and activating width2 of gate2, activates gate3.* See diagram 2.

Thresh: The threshold controls the level of sensitivity of the signal amplitude required to trigger a detection, or measurement. It is represented by the distance from the baseline, and displayed as the vertical position of a gate. The further the vertical position is from the baseline, the less sensitive the threshold is, and visa versa. This allows the user to have further control over the size of the defects considered critical, or the ability to get a detection, from the opposite surface, in very attenuative materials. This feature is used in conjunction with gain. Increasing the threshold has a similar effect of decreasing the gain, and visa versa.

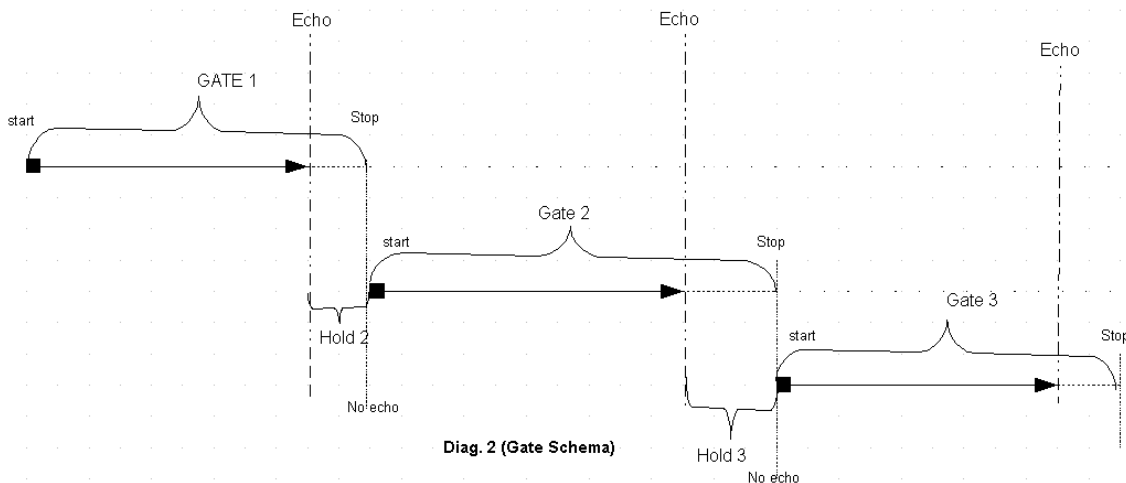

Activating the gates:

- **Automatically:** *The gates are automatically activated, when a measurement mode is selected. Gate 1 is active in all measurement modes. These modes have been internally setup at the Dakota factory. Therefore, if the user selects the **Thru Coat (E-E)** option, an internal setup will be loaded, and 2 gates will automatically be activated. This setup will work fine for the majority of all common applications. The user has the ability to fine adjust the gates settings, which will be further explained in the sections that follow.*

MEASURE MODE	
COATING OFF	P-E
COATING ON	PECT
TEMP COMP	PETP
THRU COAT	E-E
THRU VERIFY	E-EV
COATING ONLY	CT

- **Manually:** The gates can also be activated manually by using the Hot or Tabbed menus. For example: If any of the pulse echo modes (PE, PECT, PETP), shown in diagram 1, have been selected, only gate 1 will have been activated from the factory setup. However, the user may have a requirement to activate and utilize more than one gate, depending on the application.

GATE1	0.040
GATE1 WIDTH	OFF
THRESHOLD1	4
GT1	GT2
GT3	SET

Tabbed Menu

DELAY: 0.000	RANGE: 1.000
GAIN: 46	THRESH1: 4
GATE1: 0.040	WIDTH1: OFF
HOLD2: OFF	LOG: CLOSED

Hot Menu

7.7 Gates

The **CMX^{DL+}** is equipped with 3 gates, as explained in the previous section. One gate is active at all times in every measurement mode, with the exception of coating mode. These gates are full featured and completely adjustable. They can be fine tuned by the user to accommodate a variety of application scenarios. Diagram 1 in the previous section outlines the gates and features available for all measurement modes. Refer to the previous section for additional information. These features are described in more detail below:

Note: In order to adjust the gates they must be activated. The gates are automatically activated depending upon the measurement mode selected. If a gate is inactive, it will be grayed out in the hot and tabbed menus. The explanations that follow, assume that the proper measurement mode has been selected. Refer to page 41 for more information on selecting measurement modes.

Gate 1

Is used in all measurement modes, and has the following features assigned to it; start, width, and threshold. A gate can be used to overcome a great deal of application scenarios. Surface noise, for instance, close to the initial pulse can cause the erroneous measurements as the transducer receives reflections from the noise. By adjusting the start position of the gate, the noise can be blocked and eliminated. This is typical in aluminum, stainless steel, and titanium. This can also be a function of using a low frequency transducer, which are known to be inherently noisy off the initial pulse. The start feature of the gate is also used in multiple echo modes to control measurements between 2 or more echoes. As we saw in previous section, the threshold can be used to control the sensitivity level, and used in combination with the width, control the sensitivity over a specific range.

Gate 2 & 3

These gate options will most commonly be used for multiple echo measurement modes, to measure between 2 or more echoes (E-E and E-EV). They are also handy to use in a stand pulse echo mode, to create a pseudo time corrected gain feel. As the thickness of the material increases, the signal amplitude of the reflection decreases. Why not just turn up the gain? Well, this is certainly something to consider, but is not always the best answer. As the gain is increased, the noise level is also increased. At some point, increasing the gain provides little or no benefit to the quality of the signal, and the additional noise introduced makes things worse. By activating another gate, optimizing the gain level, setting the thresholds, and adjusting the widths of the gates to cover specific thickness ranges, a tough application might not be so bad after all. These gates have the following features set assigned to them; holdoff (delay), width, and threshold.

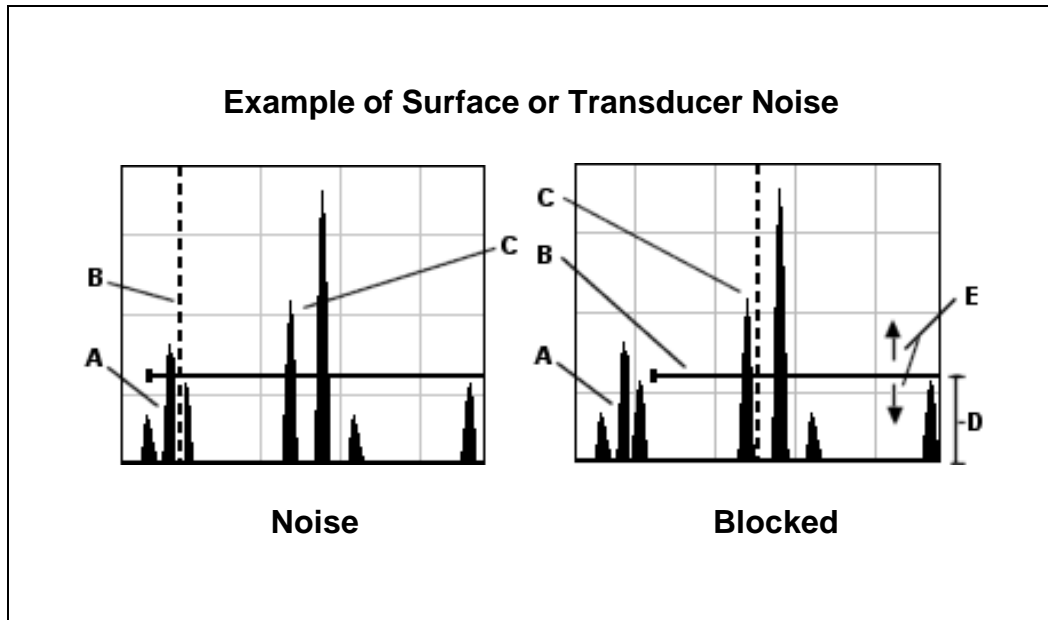

The diagrams above illustrate a typical surface noise condition. Refer to the **Noise** diagram: **(A)** refers to the noise in front of the actual back wall signal **(C)**. Notice the start position of the gate. As a result, the **CMX^{DL+}** is detecting on the noise **(A)** as shown at point **(B)**. However, the true measurement should be taken at point **(C)**. Given the start, threshold, and gain levels, the amplitude from the noise is sufficient enough to cause the **CMX^{DL+}** to detect, or measure the noise rather than the true back wall thickness **(C)**. Therefore, the **CMX^{DL+}** is making an incorrect reading at point **(B)**.

Now refer to the **Blocked** diagram. The horizontal line at the top of **(D)**, is **GATE1**. The start of **GATE1** has been moved just beyond the noise **(A)** to block the noise and detect on the correct signal **(C)**. Note: the **CMX^{DL+}** will only detect on signals that are located inside the dimensions of **GATE1 (B)**. Therefore, the **CMX^{DL+}** cannot see **(A)** at all, with respect to the starting point of **(B)**. Also notice, the position of the threshold level with respect to the baseline **(D)**, which represents the sensitivity setting of the threshold. Extreme sensitivity is indicated by the bottom of the range **(D)** at the baseline, and less sensitivity indicated by the top of the range at **(D)**. Therefore, the vertical height of **GATE1** from the baseline, is the threshold level. The threshold level can be increased to decrease sensitivity, or visa versa.

If the threshold level was increased in the **Noise** diagram, so that the vertical position of **GATE1** was higher than the amplitude of the noise **(A)**, the **CMX^{DL+}** would have detected on the true back wall **(C)**. Alternatively, if the gain level was decreased, the signal amplitude of the noise **(A)** would have decreased below the threshold level, and the **CMX^{DL+}** would have also detected the true back wall **(C)**. This example brings all the fine adjustments into consideration, and demonstrates the versatility of having a fully functional scope rather than a basic digital thickness gauge.

The procedures to adjust all of the features associated with the **Gates** are outlined below:

Note: This is a combined procedure that works the same for any of the features associated with the gates, regardless of which feature and gate number that is being adjusted. **Therefore (?) = Gate1, Hold-Off, and Width respectively**. Finally, the illustrations may not be applicable to the exact feature being adjusted, but the concepts relevant.

Adjusting the Features of the Gates Using the Hot Menu

DELAY: 0.300	RANGE: 1.000
AGC: 0	THRESH3: 1
GATE1: 0.040	WIDTH3: 0.040
HOLD3: 0.050	LOG: CLOSED

DELAY: 0.300	RANGE: 1.000
AGC: 0	THRESH2: 2
GATE1: 0.040	WIDTH2: OFF
HOLD2: 0.050	LOG: CLOSED

DELAY: 0.300	RANGE: 1.000
AGC: 0	THRESH3: 1
GATE1: 0.040	WIDTH3: 0.040
HOLD3: 0.050	LOG: CLOSED

Gate

Holdoff's

Width's

- 1) Press the **MEAS** key once to activate measure menu items. Press the **MEAS** key multiple times to move right and the **ESC** key multiple times to move left, until the (?) cell is highlighted.
- 2) If the correct (?) is displayed, press the **UP**, **DOWN**, **LEFT**, and **RIGHT** arrow keys to scroll the highlighted value.

HOLDOFFS	
HOLDOFF 2	0.050
HOLDOFF 3	0.050

- 3) **Alternatively**, if the correct (?) is not being displayed, press the **ENTER** key to display the **List Box**.

- 4) Use the **UP** and **DOWN** arrow keys to scroll through the **List Box** items until the correct **(?)** is highlighted.
- 5) Press the **MEAS** key to return to the measure screen and **Hot Menu** items.
- 6) Press the **UP**, **DOWN**, **LEFT**, and **RIGHT** arrow keys to scroll the highlighted value.
- 7) Repeat steps **3-6** until all the **(?)** values are correctly adjusted.

The user can also access and adjust the **(?)** from the tabbed menus. However, this method is more tedious than making the adjustments using **the Hot Menus**. The procedure for using the tabbed menus is outlined below:

Adjusting the Features of the Gates using the Tabbed Menu

GATE1	0.040
GATE1 WIDTH	OFF
THRESHOLD1	4
GT1	GT2
GT3	SET

- 1) Press the **MENU** key once to activate the menu items tab. Press the **MENU** key multiple times to tab right, and the **ESC** key multiple times to tab left, until the **(?)** menu is highlighted and displaying the submenu items.
- 2) Use the **UP** and **DOWN** arrow keys to scroll through the sub menu items until **(?)** is highlighted.
- 3) Press the **LEFT** and **RIGHT** arrow keys to scroll the value. When the correct **(?)** is being displayed, **proceed to step 8**.

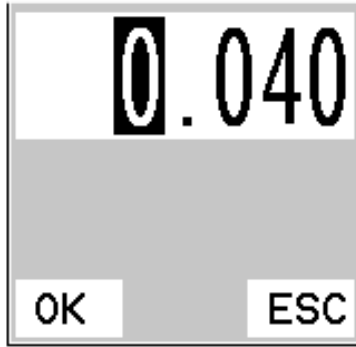

- 4) **Alternatively**, press the **ENTER** key to display the **Digits Edit Box**.
- 5) Press the **UP** and **DOWN** arrow keys to scroll the highlighted value.
- 6) Press the **LEFT** and **RIGHT** arrow keys to scroll the digit locations.
- 7) Repeat steps **5 & 6** until the **(?)** number is correctly displayed.
- 8) Press the **OK** key to set the **(?)** and return to the menu screen, or **ESC** to cancel entering the **(?)**.
- 9) Repeat steps **1-8** to set any additional **(?)** level.
- 10) Finally, press the **MEAS** key to return to the measurement screen and begin taking readings.

CHAPTER EIGHT THRU PAINT MEASUREMENT TECHNIQUE

8.1 Introduction to Thru Paint Measurement

The principle behind thru paint measurement is by measuring the time between two backwall echoes returning from the test material. Since both of these backwall echoes travel the same path through the paint or coating, the thickness of the coating is subtracted out of the measurement so that only the actual material thickness can be measured. This feature saves the user a great deal of time scraping and removing the coating from tanks and pipes during the inspection process.

The **CMX^{DL+}** also has a special echo-echo verify option, or triple echo mode. This measurement mode is identical to the echo-echo mode described above, with an additional third echo measurement performed to verify the measurement between the first 2 echoes. By doing this, the **CMX^{DL+}** can confirm that a peak jump has not occurred, and the measurement made is stable and correct. This mode is only suitable for thin materials and coatings, as the ability to achieve 3 reflections is not always possible.

The primary purpose of thru paint measurement is to determine actual or overall material thickness by eliminating the coating thickness. Thru paint mode cannot be used for flaw or pit detection. Therefore, inspectors may need to use echo-echo thru paint mode in conjunction with the standard pulse-echo flaw detection mode for some applications. The combination of using both modes is ideal for the advanced inspectors needs.

8.2 Using Thru Paint Mode

The first thing to note in this section, is that by selecting the transducer type from the list of probes stored in the **CMX^{DL+}**, a basic echo-echo thru paint configuration is recalled from memory. Each of the transducers in the list contains pre-configured echo-echo settings. However, fine adjustments may be necessary in order to be suitable for your specific applications. These configurations are general setups only. Once the transducer has been selected, or auto detected, and the appropriate calibration procedure completed, the **CMX^{DL+}** can toggle between **pulse-echo** (flaw & pits), and **echo-echo** (thru-paint) modes by simply pressing the **MULTI MODE** key located on the keypad. The standard transducer that will be used for common steel applications is a ¼" 5MHz high damped transducer (**1/4IN – 5.0MHZ HD**). However, any of the transducers with the **HD** label have been optimized for echo-echo thru paint applications. Any of the auto recognition coating transducers are also high damped transducers, and will work in echo-echo mode as well.

Note: When a transducer is selected for use, all of the measurement modes available for use with this transducer can easily be determined by pressing the multi-

mode button on the keypad. The **CMX^{DL+}** has been programmed to identify the modes available to a specific transducer.

When configuring the **CMX^{DL+}** for specific thru paint applications, all of the scope parameters will potentially be needed. The delay, range, gain (AGC), thresholds, gates, and hold-offs will be subject to change. For this reason, they have all been added to **Hot Menu** fields located directly beneath the A-Scan display for quick and easy access. **Note:** Once the values of the fields have been changed or modified, these changes must be saved to a setup location prior to powering the **CMX^{DL+}** off. **Failure to do so will result in losing your changes.** Refer to page 157 for additional information on setups.

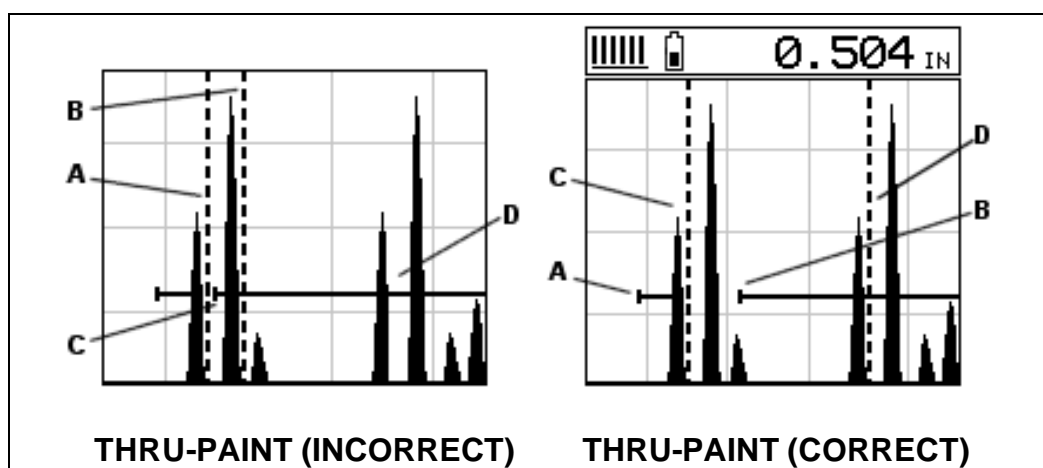

Refer to the incorrect diagram above. Point **(A)** represents the detection on the first back wall echo. The true, second back wall, reflection should be detecting at point **(D)**. However, the hold-off **(C)** is setup incorrectly and the **CMX^{DL+}** is detecting the ring down noise of the transducer, on the first reflection, rather than the true second back wall reflection shown at **(D)**.

Before we look at the diagram with the correct configuration, let's consider all of our options on how to fix the problem beforehand. Our **delay** and **Range** will simply change the view options of the screen – not needed in this example. Will a **gain(AGC)** or **threshold** adjustment fix the problem? Unfortunately, not. Why? Notice the amplitude of the cycle just to the left of **(B)**. If we tried to increase the threshold level above the height of the cycle, we would lose our detection for both echoes resulting in no reading at all. If we decrease our **gain(AGC)**, reducing the signal amplitudes, we would also lose our detection of both back wall echoes.

Notice that the amplitude of the cycle just to the left of **(C)**. The amplitude of the cycle, at **(C)**, is less than the amplitude of the cycle at **(B)**, in terms of overall height. If we decreased our **gain(AGC)**, we would lose the first cycle **(C)** long before losing the second cycle **(B)**. Therefore, adjusting the **gain(AGC)** or **threshold** levels will not help us in this example. Our final option is adjusting the **GATE2** hold-off, shown

at point **(C)** in the incorrect diagram, to point **(B)** in the correct diagram. If we adjust the **GATE2** hold-off further to the right of the first reflection, the ring down noise from the first back wall echo no longer interferes with the true detection **(D)**, shown in the correct diagram.

The adjustment considerations in the example above will typically be used for all thru paint applications respectively. In some applications the hold-off may be sufficient, while a **gain (AGC)** or **thresholds** adjustment will solve the problem. A similar process of elimination should be considered for all thru paint applications.

CHAPTER NINE PULSE-ECHO COATING & COATING TECHNIQUES

9.1 Introduction to Pulse-Echo Coating Measurement (PECT)

In the previous sections we've discussed the need for detecting pits and flaws (pulse-echo) in materials, along with the requirement to measure through and eliminate errors caused by coated materials (echo-echo). Until now, both modes were needed in order accomplish both tasks. Pulse-echo mode was used for flaw detection, and echo-echo mode was used to eliminate the coating thickness and provide a nominal material thickness only. With this in mind, it often became cumbersome toggling between both modes respectively.

In a majority of applications involving coated materials, inspectors are often interested in monitoring both the thickness of the material, as well as the thickness of the coating. Therefore, the **CMX^{DL+}** has been designed to provide the user with the ability to measure the material and coating thicknesses simultaneously, while maintaining the ability to detect flaws and pits all in a single mode called **Pulse-Echo Coating (PECT)**. This is accomplished by using a custom hybrid combination mode utilizing properties from the basic modes along with a group of special techniques and theoretical wave phenomena's.

The **CMX^{DL+}** is preset to a coating velocity of 0.0850 in/ μ sec (2159 m/sec) from the factory. This velocity is a very close approximation of the common coating velocities found in the field. However, the **CMX^{DL+}** also has a built-in one and two point calibration options to calibrate to coating samples with a known thicknesses.

There are two coating modes built into the **CMX^{DL+}**:

- 1) **Pulse-Echo Coating (PECT)** – used during inspections where both the material and coating thicknesses are required.
- 2) **Coating Only (CT)** – used during inspections where only the coating thickness is required.

9.2 Enabling Pulse-Echo Coating Mode (PECT) & Coating (CT)

When the **CMX^{DL+}** is initially powered up, the gauge will automatically check to see if the transducer plugged into the gauge can be recognized. All Dakota Ultrasonics coating enabled transducers are equipped with the auto recognition feature. If the **CMX^{DL+}** doesn't recognize that a special coating enabled transducer is plugged into the gauge, the coating feature will be disabled entirely. There are a number of coating enabled transducers available from Dakota. Please contact us with your application requirements for additional information on frequencies and diameters currently offered.

The coating modes can be enabled in three different ways:

- 1) On Power up and probe recognition.
- 2) By pressing **MULTI MODE** keypad.

3) From the tabbed menus under **TUNE, MEASURE MODE**.

The steps that follow will demonstrate all three methods in the order listed above:

Probe Automatically Recognized (PECT only)

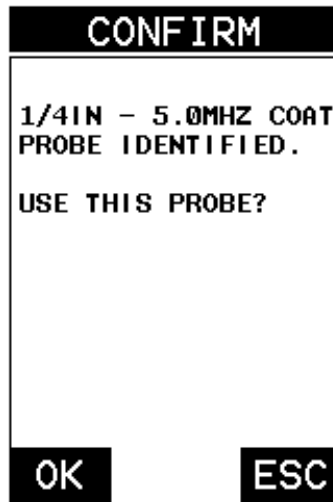

- 1) Press the **OK** key once to use the identified probe, or **ESC** to display a list of optional transducers. *Note: if the **CMX^{DL+}** recognizes a specific transducer, the user should always select **OK** to use the identified probe. The only time an alternative probe should be selected from a list is if the user switched probes following initial power up and recognition.*
- 2) Assuming the **CMX^{DL+}** recognized the probe and the **OK** key was pressed, the **CMX^{DL+}** will advance to a Zero Probe menu. If the transducer was identified as a special transducer capable of measuring coating thickness, a menu will be displayed allowing the user the ability to toggle the coating thickness display on/off as follows:

ZERO PROBE

COATING: ON

COATING: OFF

SELECT COATING
ON/OFF – REMOVE
COUPLANT FROM
PROBE AND PRESS
OK KEY TO PERFORM
THE ZERO.

OK

ESC

3) Press the **UP** and **DOWN** arrow keys to toggle the coating option on/off.

Multi Mode Key Pressed (PECT & CT)

MEASURE MODE	
COATING OFF	P-E
COATING ON	PECT
TEMP COMP	PETP
THRU COAT	E-E
THRU VERIFY	E-EV
COATING ONLY	CT

MEASURE MODE	
COATING OFF	P-E
COATING ON	PECT
TEMP COMP	PETP
THRU COAT	E-E
THRU VERIFY	E-EV
COATING ONLY	CT

Applied to Metals

Not Applied to Metals

- 1) Press the **MULTI MODE** key located on bottom left of the keypad to display the **MEASURE MODE** options menu.
- 2) Press the **UP** and **DOWN** arrow keys to highlight the **COATING ON (PECT)** or **COATING ONLY (CT)** menu option.

3) Press the **ENTER** key to enable the coating option, or **ESC** to cancel changing the measure mode, and return to the main measurement screen.

Measure Mode (Tabbed Menus) – (PECT & CT)

TUNE SIGNAL	
MEASURE MODE	PECT
POLARITY	POSITIVE
PULSE	THIN
PULSER VOLT	150
ATTN	0 DB
GAIN	46
AGC	0
PRB	CAL DISP TUNE

Applied to Metals

TUNE SIGNAL	
MEASURE MODE	CT
POLARITY	NEGATIVE
PULSE	THIN
PULSER VOLT	150
ATTN	0 DB
GAIN	46
AGC	0
PRB	CAL DISP TUNE

Not Applied to Metals

- 1) Press the **MENU** key once to activate the menu items tab. Press the **MENU** key multiple times to tab right, and the **ESC** key multiple times to tab left, until the **TUNE** menu is highlighted and displaying the submenu items.
- 2) Use the **UP** and **DOWN** arrow keys to scroll through the sub menu items until **MEASURE MODE** is highlighted.
- 3) Press the **LEFT** and **RIGHT** arrow keys to scroll the modes.
- 4) When the correct **MODE** is being displayed, press the **MEAS** key to return to the measurement screen and begin taking readings.

9.3 Zero Coating

In order to account for very slight electronic differences in transducers of the same type, frequency, and diameter, the **CMX^{DL+}** has been equipped with a “zero coating” feature. This enables the **CMX^{DL+}** to obtain very accurate readings on coatings, eliminating potential errors incurred from slight differences in the manufacturing processes. The procedure is outlined below:

Performing a Coating Zero

MEASURE MODE	
COATING OFF	P-E
COATING ON	PECT
TEMP COMP	PETP
THRU COAT	E-E
THRU VERIFY	E-EV
COATING ONLY	CT

- 1) Press the **MULTI MODE** key once to activate the measurement mode options.
- 2) Use the **UP** and **DOWN** arrow keys to scroll through the sub menu items until **Coating Only (CT)** mode is highlighted.
- 3) Press the **ENTER** key to select the measurement mode and return to the measurement screen.
- 4) Apply a drop of couplant on the transducer and place the transducer in steady contact with the probe zero disk (battery cover) and obtain a steady reading.

Note: The coating measurement displayed will potentially be a value greater or less than 0.

- 5) Press the **MENU** key once to activate the menu items tab. Press the **MENU** key multiple times to tab right and the **ESC** key multiple times to tab left until the **PRB** menu is highlighted and displaying the submenu items.

SETUP PROBE	
ZERO PROBE	AUTO
ZERO COATING	
TYPE	11
FLAW MODE	OFF
PRB	CAL DISP TUNE

- 6) Use the **UP** and **DOWN** arrow keys to scroll through the sub menu items until **ZERO COATING** is highlighted.
- 7) Press the **ENTER** key to display the confirmation screen.
- 8) Press the **OK** key to zero the coating and return to the **PRB** menu, or **ESC** to cancel the coating zero process.
- 9) Press the **MULTI MODE** key once to activate the measurement mode options.
- 10) Use the **UP** and **DOWN** arrow keys to scroll through the sub menu items until **Coating On (PECT)** is highlighted.
- 11) Press the **ENTER** key to select the measurement mode and return to the measurement screen, and begin taking readings. Proceed to the coating calibration section.

9.4 Coating Calibration (PECT)

Known Velocity

If the coating velocity is known, the user may wish to simply enter the velocity number into the **CMX^{DL+}**, rather than have the **CMX^{DL+}** calculate the velocity value using a known thickness on a coating sample(s). The steps for entering the velocity are outlined below:

Using a Known Material Velocity

CALIBRATE	
MAT	STEEL <4340>
MATL 1PT	UNCAL
MATL 2PT	UNCAL
VELOCITY	0.2330
COATING 1PT	0.050
COATING 2PT	UNCAL
COATING VEL	0.1166
PRB	CAL DISP TUNE

- 1) Press the **MENU** key once to activate the menu items tab. Press the **MENU** key multiple times to tab right and the **ESC** key multiple times to tab left until the **CAL** menu is highlighted and displaying the submenu items.
- 2) Use the **UP** and **DOWN** arrow keys to scroll through the sub menu items until **COATING VEL** is highlighted.

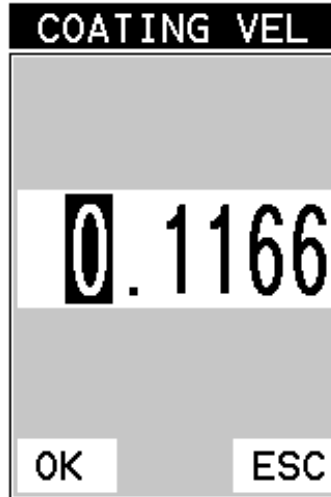

- 3) Press the **ENTER** key to display the **Digits Edit Box**.
- 4) Press the **UP** and **DOWN** arrow keys to scroll the highlighted value.
- 5) Press the **LEFT** and **RIGHT** arrow keys to scroll the digit locations.
- 6) Repeat steps **4 & 5** until the velocity number is correctly displayed.
- 7) Press the **OK** key to set the velocity and return to the menu screen, or **ESC** to cancel entering the velocity.
- 8) Finally, press the **MEAS** key to return to the measurement screen and begin taking readings.

Known Thickness

Sometimes the sound velocity of a coating material is unknown. In this case a sample with a known thickness can be used to determine the sound velocity of the coating. As previously discussed, the **CMX^{DL+}** offers a one point calibration option for coating in **PECT** measurement mode. It is also important to reiterate that the coating sample must be coupled to a metallic material in order to perform the calibration. The calibration should also consider calibrating on high side of the intended measurement range, when using the one point option, minimize overall error. For example, if the measurement range of the coating will be from .040" - .080" (1.0mm - 2.3mm), a coating closest to .080 (2.0mm) should be used. Note: It's always handy to carry a set of mechanical calipers to use in conjunction with the **CMX^{DL+}** for calibration in the field:

One Point Calibration

CALIBRATE	
MAT	STEEL <4340>
MATL 1PT	UNCAL
MATL 2PT	UNCAL
VELOCITY	0.2330
COATING 1PT	0.080
COATING 2PT	UNCAL
COATING VEL	0.1866
PRB	CAL DISP TUNE

Note: Be sure that the probe zero procedure has been performed prior to performing this calibration procedure.

- 1) Physically measure an exact sample of the coating using a set of calipers or a digital micrometer.

Note: The coating sample must be coupled to a metallic material in order to be calibrated.

- 2) Apply a drop of couplant on a piece of metal and place the coating sample on the metal over the couplant. Apply a drop of couplant on the transducer

and place the transducer in steady contact with the coating and sample or actual test material. Be sure that the reading is stable and the repeatability indicator, in the top left corner of the display, is fully lit and stable. Press the **MENU** key once to activate the menu items tab. Press the **MENU** key multiple times to tab right and the **ESC** key multiple times to tab left until the **CAL** menu is highlighted and displaying the submenu items.

- 3) Use the **UP** and **DOWN** arrow keys to scroll through the sub menu items until **COATING 1PT** is highlighted.



- 4) Press the **ENTER** key to display the **Digits Edit Box**.
- 5) Press the **UP** and **DOWN** arrow keys to scroll the highlighted value.
- 6) Press the **LEFT** and **RIGHT** arrow keys to scroll the digit locations.
- 7) Repeat steps **5 & 6** until the known thickness value is correctly displayed.
- 8) Press the **OK** key to calculate the velocity and return to the menu screen, or **ESC** to cancel the coating one point calibration.
- 9) Finally, press the **MEAS** key to return to the measurement screen and begin taking readings.

Note: CHECK YOUR CALIBRATION! Place the transducer back on the calibration point. The coating thickness reading should now match the known thickness. If the thickness is not correct, repeat the steps above.

9.5 Introduction to Coating Measurement (CT)

In the previous sections we've discussed how to setup and use the coating feature for use in conjunction with material thickness for flaw and pit detection. The **CMX^{DL+}** also has the capability to be used for general coating measurements. This measurement mode is called Coating (CT) and can be enabled using the same methods as described in a previous section above.

When the Coating Only (CT) mode is enabled, a two point calibration on the coating samples **must** be performed. This is to ensure linearity over the coating measurement range will be achieved. **Important note:** If coating measurements will be made with the coating applied to a metal surface, the calibration must be done in the same manner, with the samples coupled to a metal surface. However, if the coating will be measured as a stand alone material, the calibration must be performed the same way.

9.6 Two Point Coating Calibration (CT)

Known Thickness

The following section will demonstrate the two point coating calibration procedure. This example demonstrates a coating thickness range of .040" - .120" (1 – 3 mm) as follows:

Note: It's always handy to carry a set of mechanical calipers to use in conjunction with the **CMX^{DL+}** for calibration in the field:

One Point Calibration

CALIBRATE	
MAT	CUSTOM
MATL 1PT	UNCAL
MATL 2PT	UNCAL
VELOCITY	0.2330
COATING 1PT	0.1200
COATING 2PT	0.0400
COATING VEL	0.0933
PRB	CAL
DISP	TUNE

Note: Use the maximum coating sample for the one point calibration first.

- 1) Physically measure the thicker of the two samples of coating, as close as possible to the maximum expected coating measurement range, using a set of calipers or a digital micrometer.

Very Important: *If coating measurements will be made with the coating applied to a metal surface, the calibration must be done in the same manner, with the samples coupled to a metal surface. However, if the coating will be measured as a stand alone material, the calibration must be performed the same way.*

- 2) Apply a drop of couplant on the transducer and place the transducer in steady contact with the thicker of the two coating and samples fist. Be sure that the reading is stable and the repeatability indicator, in the top left corner of the display, is fully lit and stable. Press the **MENU** key once to activate the menu items tab. Press the **MENU** key multiple times to tab right and the **ESC** key multiple times to tab left until the **CAL** menu is highlighted and displaying the submenu items.

- 3) Use the **UP** and **DOWN** arrow keys to scroll through the sub menu items until **COATING 1PT** is highlighted.



- 4) Press the **ENTER** key to display the **Digits Edit Box**.
- 5) Press the **UP** and **DOWN** arrow keys to scroll the highlighted value.
- 6) Press the **LEFT** and **RIGHT** arrow keys to scroll the digit locations.
- 7) Repeat steps **5 & 6** until the known thickness value is correctly displayed.
- 8) Press the **OK** key to calculate the velocity and return to the menu screen, or **ESC** to cancel the coating one point calibration.
- 9) Finally, press the **MEAS** key to return to the measurement screen and begin taking readings.

Two Point Calibration

CALIBRATE	
MAT	CUSTOM
MATL 1PT	UNCAL
MATL 2PT	UNCAL
VELOCITY	0.2330
COATING 1PT	0.1200
COATING 2PT	0.0400
COATING VEL	0.0933
PRB	CAL DISP TUNE

Note: Use the minimum coating sample for the two point calibration.

- 1) Physically measure the thinner of the two samples of the coating, as close as possible to the minimum expected coating measurement range, using a set of calipers or a digital micrometer.

Very Important: *If coating measurements will be made with the coating applied to a metal surface, the calibration must be done in the same manner, with the samples coupled to a metal surface. However, if the coating will be measured as a stand alone material, the calibration must be performed the same way.*

- 2) Apply a drop of couplant on the transducer and place the transducer in steady contact with the thinner of the two coating and samples. Be sure that the reading is stable and the repeatability indicator, in the top left corner of the display, is fully lit and stable. Press the **MENU** key once to activate the menu items tab. Press the **MENU** key multiple times to tab right and the **ESC** key multiple times to tab left until the **CAL** menu is highlighted and displaying the submenu items.

- 3) Use the **UP** and **DOWN** arrow keys to scroll through the sub menu items until **COATING 2PT** is highlighted.

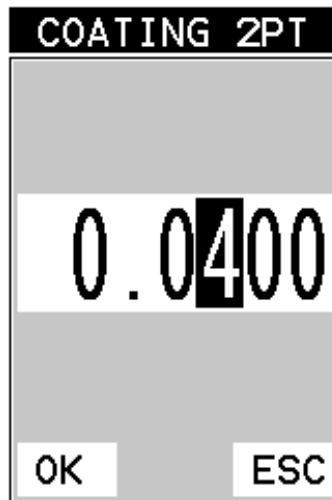

- 4) Press the **ENTER** key to display the **Digits Edit Box**.
- 5) Press the **UP** and **DOWN** arrow keys to scroll the highlighted value.
- 6) Press the **LEFT** and **RIGHT** arrow keys to scroll the digit locations.
- 7) Repeat steps **5 & 6** until the known thickness value is correctly displayed.
- 8) Press the **OK** key to calculate the velocity and return to the menu screen, or **ESC** to cancel the coating one point calibration.
- 9) Finally, press the **MEAS** key to return to the measurement screen and begin taking readings.

Note: CHECK YOUR CALIBRATION! Place the transducer back on both calibration points. The coating thickness readings should now match the known thickness values of each sample. If the thickness is not correct, repeat the steps above.

CHAPTER TEN ADDITIONAL FEATURES OF THE CMX^{DL+}

10.1 Auto Find

The **CMX^{DL+}** is equipped with a very handy feature for locating the detection point of a back wall echo that is not currently in the viewable region of the display. Suppose the **CMX^{DL+}** is currently setup with a delay of 0.0" and a width of 1.0", and the user is measuring material thickness of 2.5". The **CMX^{DL+}** will make the correct measurement and display it digitally. However, the waveform will not show up at all in both A-Scan views, and incorrectly in the B-Scan view without adjusting the range of the **Delay** and **Width** accordingly.

The **AUTO FIND** feature is a convenient way to let the **CMX^{DL+}** find the detection point and bring the waveform signal into view automatically. The user can then make small adjustments to the range once the signal is displayed on the screen. The procedure to use the **AUTO FIND** feature is outlined below:

Using Auto Find

UTILITIES	
AUTO FIND	
SCAN MODE	OFF
ALARM	ON
ALARM HIGH	0.225
ALARM LOW	0.190
DIFFERENTIAL	OFF
DATA	UTIL
XFER	

- 1) Press the **MENU** key once to activate the menu items tab. Press the **MENU** key multiple times to tab right, and the **ESC** key multiple times to tab left, until the **UTIL** menu is highlighted and displaying the submenu items.
- 2) Use the **UP** and **DOWN** arrow keys to scroll through the sub menu items until **AUTO FIND** is highlighted.
- 3) Place the transducer on the test material and obtain a reading.

- 4) Press the **ENTER** key to automatically adjust the display settings and bring the waveform into view.
- 5) Once the signal is displayed, press the **MEAS** key to return to measurement mode.

10.2 High Speed Scan

The High Speed Scan feature of the **CMX^{DL+}** increases the overall repetition rate to a maximum of 140Hz with a high speed screen refresh rate of 25 times a second. This feature enables a user to make scanned passes over an arbitrary length of the test material, while still maintaining a reasonable representation of thickness over the scanned area or region. This feature can be used in conjunction with High and Low alarm limits features to dynamically keep track of both values. The feature is typically used to provide a better representation of the area scanned, by taking more readings at a faster rate repetition rate.

The procedure to use the **SCAN MODE** feature is outlined below:

Using the Scan Mode

UTILITIES	
AUTO FIND	
SCAN MODE	ON
ALARM	ON
ALARM HIGH	0.225
ALARM LOW	0.190
DIFFERENTIAL	OFF
DATA	UTIL
XFER	

- 1) Press the **MENU** key once to activate the menu items tab. Press the **MENU** key multiple times to tab right and the **ESC** key multiple times to tab left until the **UTIL** menu is highlighted and displaying the submenu items.

- 2) Use the **UP** and **DOWN** arrow keys to scroll through the sub menu items until **SCAN MODE** is highlighted.
- 3) Use the **LEFT** and **RIGHT** arrow keys to toggle the **SCAN MODE** on/off.
- 4) Press the **MEAS** key to return to the measurement screen.

10.3 Alarm Mode

The **Alarm Mode** feature of the **CMX^{DL+}** provides the user with a method of setting tolerances, or limits, for a particular application requirement. This feature may be used for a variety of applications to verify the material is within the manufacturer specifications. There are two limits, or alarm values, that can be setup in the **CMX^{DL+}** – **ALARM LOW** and **ALARM HIGH** limits. However, the user may choose to activate and utilize only one of the limit values, depending on their specific application requirements. The procedures to use the **ALARM MODE** feature are outlined below:

Toggle Alarm (on/off)

UTILITIES	
AUTO FIND	
SCAN MODE	ON
ALARM	ON
ALARM HIGH	0.225
ALARM LOW	0.190
DIFFERENTIAL	OFF
DATA	UTIL XFER

- 1) Press the **MENU** key once to activate the menu items tab. Press the **MENU** key multiple times to tab right, and the **ESC** key multiple times to tab left, until the **UTIL** menu is highlighted and displaying the submenu items.
- 2) Use the **UP** and **DOWN** arrow keys to scroll through the sub menu items until **ALARM** is highlighted.

- 3) Use the **LEFT** and **RIGHT** arrow keys to toggle the **ALARM** on/off/audible.
- 4) Continue on to the next section “**Setting the Alarm Low Limit**”.

Setting the Alarm Low Limit

UTILITIES	
AUTO FIND	
SCAN MODE	ON
ALARM	ON
ALARM HIGH	0.225
ALARM LOW	0.190
DIFFERENTIAL	OFF
DATA UTIL XFER	

- 1) Assuming the **ALARM** is **ON**, use the **UP** and **DOWN** arrow keys to scroll through the sub menu items until **ALARM LOW** is highlighted.
- 2) Press the **LEFT** and **RIGHT** arrow keys to scroll the value. When the correct alarm value is being displayed, **proceed to step 7**.

ALARM LOW	ALARM HIGH
0.190	0.225
<div style="display: flex; justify-content: space-around; width: 100%;"> OK ESC </div>	<div style="display: flex; justify-content: space-around; width: 100%;"> OK ESC </div>

- 3) **Alternatively**, press the **ENTER** key to display the **Digits Edit Box**.
- 4) Press the **UP** and **DOWN** arrow keys to scroll the highlighted value.
- 5) Press the **LEFT** and **RIGHT** arrow keys to scroll the digit locations.
- 6) Repeat steps **4 & 5** until the **ALARM LOW** value is correctly displayed.
- 7) If only one limit will be used, press the **MEAS** key to return to the measurement screen and begin taking readings. Otherwise, continue on to set the **ALARM HIGH** limit using the same procedures.

10.4 Differential Mode

The **Differential Mode** of the **CMX^{DL+}** provides the user with the ability to set a nominal value, according to what the expected thickness should be, and measure the +/- difference from the nominal value entered. This feature is typically used in QA incoming inspections on pipes, plate stock, coils, etc. The steps below outline how to enable and enter the nominal value to use this feature:

Toggle Differential (on/off)

UTILITIES	
AUTO FIND	
SCAN MODE	ON
ALARM	ON
ALARM HIGH	0.225
ALARM LOW	0.190
DIFFERENTIAL	0.000
DATA UTIL XFER	

- 1) Press the **MENU** key once to activate the menu items tab. Press the **MENU** key multiple times to tab right, and the **ESC** key multiple times to tab left, until the **UTIL** menu is highlighted and displaying the submenu items.
- 2) Use the **UP** and **DOWN** arrow keys to scroll through the sub menu items until **DIFFERENTIAL** is highlighted.
- 3) Use the **LEFT** and **RIGHT** arrow keys to toggle the **DIFFERENTIAL** on. A value will appear to the right of **DIFFERENTIAL**.
- 4) Continue on to the next section "**Setting the Differential Value**".

Setting the Differential Value

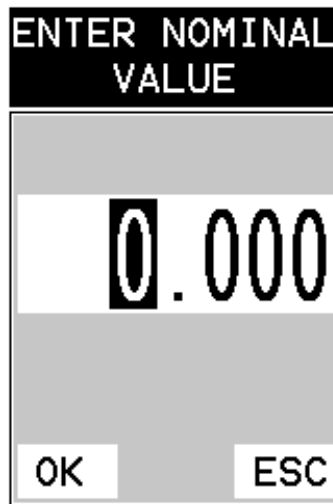

- 1) Assuming **DIFFERENTIAL** has been enabled and a value is being displayed to the right of the **DIFFERENTIAL** label, press the **ENTER** key to display the **Digits Edit Box**.
- 2) Press the **UP** and **DOWN** arrow keys to scroll the highlighted value.
- 3) Press the **LEFT** and **RIGHT** arrow keys to scroll the digit locations.
- 4) Repeat steps **2 & 3** until the **DIFFERENTIAL** value is correctly displayed.
- 5) Press the **OK** key to set the **DIFFERENTIAL** value and return to the menu screen.
- 6) Finally, press the **MEAS** key to return to the measurement screen and begin taking readings.

10.5 Brightness (*color version only*)

The **CMX^{DL+}** color version is equipped with a brightness feature to adjust the display visibility and optimize battery life. It has an arbitrary scale with a values from 1 -20, with 20 representing the brightest setting. The procedures for adjusting the brightness are outlined below:

Adjusting Brightness

SET DISPLAY	
VIEW	BSCAN
B-START	0.000
B-DEPTH	1.000
B-SCAN SPEED	6
UNITS	IN
BRIGHTNESS	20
VIEW	GREEN 2
DIM	OFF
RECT WAVE	OUTLINE
DETECT MARK	DOTS
PRB CAL	DISP TUNE

- 1) Press the **MENU** key once to activate the menu items tab. Press the **MENU** key multiple times to tab right and the **ESC** key multiple times to tab left until the **DISP** menu is highlighted and displaying the submenu items.
- 2) Use the **UP** and **DOWN** arrow keys to scroll through the sub menu items until **BRIGHTNESS** is highlighted.
- 3) Press the **LEFT** and **RIGHT** arrow keys to scroll the value. When the correct brightness value is being displayed, **proceed to step 8**.

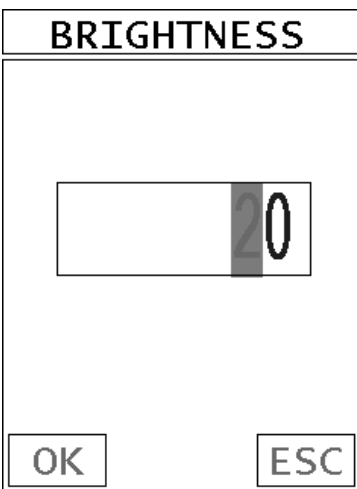

- 4) **Alternatively**, press the **ENTER** key to display the **Digits Edit Box**.

- 5) Press the **UP** and **DOWN** arrow keys to scroll the highlighted value.
- 6) Press the **LEFT** and **RIGHT** arrow keys to scroll the digit locations.
- 7) Repeat steps **5 & 6** until the brightness number is correctly displayed.
- 8) Press the **OK** key to set the brightness and return to the menu screen, or **ESC** to cancel entering the brightness.
- 9) Finally, press the **MEAS** key to return to the measurement screen and begin taking readings.

10.6 VIEW (color version only)

The **CMX^{DL+}** color version has a variety of display color options to select from. These will change the look and feel of the according to the users preference. The procedures for changing the **VIEW**, are outlined below:

Selecting a Color Scheme

SET DISPLAY	
VIEW	BSCAN
B-START	0.000
B-DEPTH	1.000
B-SCAN SPEED	6
UNITS	IN
BRIGHTNESS	20
VIEW	GREEN 2
DIM	OFF
RECT WAVE	OUTLINE
DETECT MARK	DOTS
PRB CAL	DISP TUNE

- 1) Press the **MENU** key once to activate the menu items tab. Press the **MENU** key multiple times to tab right and the **ESC** key multiple times to tab left until the **DISP** menu is highlighted and displaying the submenu items.

- 2) Use the **UP** and **DOWN** arrow keys to scroll through the sub menu items until **VIEW** is highlighted.

CHOOSE COLORS	
1.	GREEN 1
2.	GREEN 2
3.	RED 1
4.	RED 2
5.	BLUE 1
6.	BLUE 2
7.	YELLOW 1
8.	YELLOW 2 273x332
9.	PURPLE 1
10.	PURPLE 2
11.	PURPLE 3
12.	NONE B/W

- 3) Press the **ENTER** key to display a list of the color scheme options.
- 4) Press the **UP** and **DOWN** arrow keys to scroll through the material list until the appropriate material is highlighted.
- 5) Press the **ENTER** key, followed by pressing the OK key, to overwrite the current color scheme with the selected scheme.
- 6) Finally, press the **MEAS** key to return to the measurement screen and begin taking readings.

10.7 DIM (color version only)

The **CMX^{DL+}** color version has a built-in **DIM** feature to manage power more effectively. This feature has adjustable time durations, until the power of the display is dimmed and current draw reduced. The timer is constantly reset while the user is making measurements, and is only activated when the gauge is idle for the duration of time the **DIM** value is set for. This feature does not override the preset 5 min idle power off feature in any way. However, if the gauge is turned on, set for a DIM of 120sec, and then left idle for 5 minutes, the **CMX^{DL+}** will dim in 2 minutes, then power off in 5 minutes. The procedures for adjusting the **DIM** time are outlined below:

Setting a DIM time

SET DISPLAY	
VIEW	BSCAN
B-START	0.000
B-DEPTH	1.000
B-SCAN SPEED	6
UNITS	IN
BRIGHTNESS	20
VIEW	GREEN 2
DIM	60 SEC
RECT WAVE	OUTLINE
DETECT MARK	DOTS
PRB CAL	DISP TUNE

- 1) Press the **MENU** key once to activate the menu items tab. Press the **MENU** key multiple times to tab right and the **ESC** key multiple times to tab left until the **DISP** menu is highlighted and displaying the submenu items.
- 2) Use the **UP** and **DOWN** arrow keys to scroll through the sub menu items until **DIM** is highlighted.
- 3) Press the **LEFT** and **RIGHT** arrow keys to scroll the **DIM** time.
- 4) Finally, press the **MEAS** key to return to the measurement screen and begin taking readings.

10.8 Damping (*color version only*)

The color version of the CMX^{DL+} has a built-in damping feature to control the impedance input of the receiver. This enables the user the ability to match and optimize the transducer for better signal quality at various frequencies. The available settings are 50, 75, 100, 300, 600 and 1500 ohms. The procedures below outline the steps for selecting an impedance setting, as follows:

Setting the Damping Value

TUNE SIGNAL	
MEAS MODE	PECT
POLARITY	POSITIVE
PULSE	SPIKE
PULSER VOLT	150
DAMPING	50
ATTN	0 DB
GAIN	40
AGC	1
PRB CAL DISP	TUNE

- 1) Press the **MENU** key once to activate the menu items tab. Press the **MENU** key multiple times to tab right, and the **ESC** key multiple times to tab left, until the **TUNE** menu is highlighted and displaying the submenu items.
- 2) Use the **UP** and **DOWN** arrow keys to scroll through the sub menu items until **DAMPING** is highlighted.
- 3) Use the **LEFT** and **RIGHT** arrow keys to scroll through the **DAMPING** values until the correct value is displayed to the right of the **DAMPING** menu item.
- 4) Finally, press the **MEAS** key to return to the measurement screen and begin taking readings.

10.9 Introduction to Flaw Mode

The **Flaw Mode** feature was added to the **CMX^{DL+}** to provide inspectors with a basic prove-up flaw detection mode using an angle beam transducer. This mode enables inspectors to locate porosity, defects, inclusions, and cracks in a variety of test materials. Angle beam transducers, are transducers attached to a delay line wedge at specific angles. Some of the more common angles are 45°, 60°, and 70°. The sound wave is introduced into the test material at a specific angle, and converted from a longitudinal wave into a shear wave. The introduction at specific angles enables inspectors to steer the sound wave in a specific direction according to the position and location of specific types of defects.

Note: The **CMX^{DL+}** AMOLED high speed color version has a 120Hz screen redraw rate and exceeds the speed found in conventional digital flaw detectors.

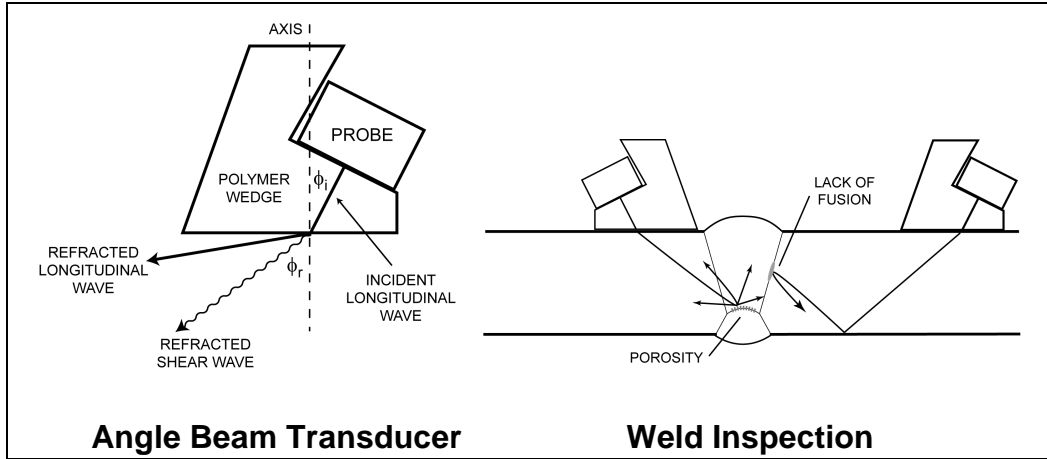

Flaw Mode View:

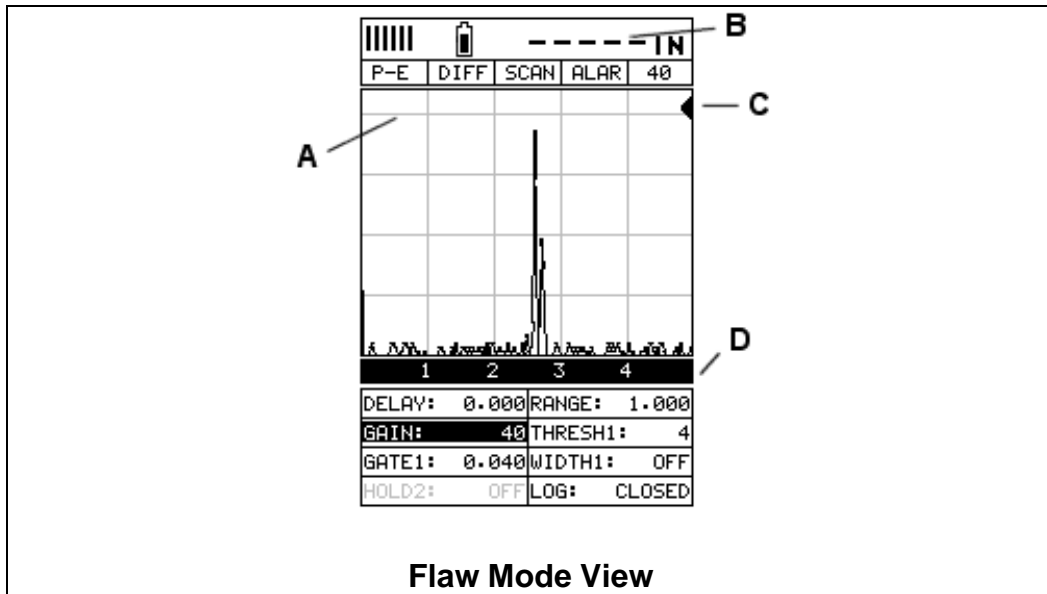

Refer to the diagram above. The grey grid line, **point (A)**, corresponds to 100% FSH (Full Screen Height). The other grid lines correspond to 25% amplitude increments, in order to calibrate the **CMX^{DL+}** in this mode. The digital thickness value has been replaced by dashed lines at **point (B)**. The digital thickness value is not applicable while operating in this mode. Notice at **point (D)**, the vertical grid lines have simply been given quadrant numbers. Again, this is because the grid lines do not correspond to a thickness value based on the delay and width of the screen. Finally,

point (C) is the peak hold symbol - carrot. The carrot is only displayed if the flaw mode is set to “peak”. The peak hold position represents the highest amplitude obtained during the scan. Pressing the **CLR** key will reset the peak hold position to zero.

Enabling the Flaw Mode:

Note: This mode requires an accessory dual lemo to single microdot cable is available from the factory. The procedures to use the **FLAW MODE** feature are outlined below:

Using the Default Setup

SETUP PROBE	
ZERO PROBE	AUTO
ZERO COATING	
TYPE	11
FLAW MODE	PEAK
PRB	CAL DISP TUNE

- 1) Attach the special dual lemo to microdot cable and angle beam transducer to the **CMX^{DL+}**.
- 2) Press the **MENU** key once to activate the menu items tab. Press the **MENU** key multiple times to tab right and the **ESC** key multiple times to tab left until the **PROBE** menu is highlighted and displaying the submenu items.
- 3) Use the **UP** and **DOWN** arrow keys to scroll through the sub menu items until **FLAW MODE** is highlighted.
- 4) Use the **LEFT** and **RIGHT** arrow keys to scroll the flaw mode options (off, on, peak).

Off: Disables the Flaw Mode option.

On: Enables the Flaw Mode option and view.

Peak: Enables the Flaw Mode and Peak Hold options and view. When this option is enabled, a carrot will appear on the right side of the display. The position of the carrot corresponds to the highest waveform amplitude value detected. In order to clear the peak hold carrot location and start another scan, the **CLR** key must be pressed. When pressed, the carrot will be displayed at the baseline, or at zero amplitude.

5) Once the desired flaw mode is displayed, press the **MEAS** key to return to measurement mode.

Note: All the features previously discussed in this manual can be used to adjust and fine tune the **CMX^{DL+}** while in Flaw Mode.

Note: When flaw mode is activated, a transducer delay will still be configured from the previously loaded transducer. This will only affect the starting point from the initial pulse from being at zero. The zero delay can be set to zero by loading the **default setup** located in the setup menu. Alternatively, the user can load a factory flaw mode setup, from the setups folder, and begin making any adjustments necessary. Refer to page 157 for further info.

10.10 Graphics Options (look & feel)

We've added a couple of graphic interface features to the **CMX^{DL+}**, accommodate customer requests we've received in the past. These features only serve as cosmetic items, and do not change the functionality of the **CMX^{DL+}** in any way.

RECT Wave:

The rectified wave feature, is only functional when using **RECT** wave view, and provides the user the following display options:

Outline – Draws the unfilled outline of the waveform.

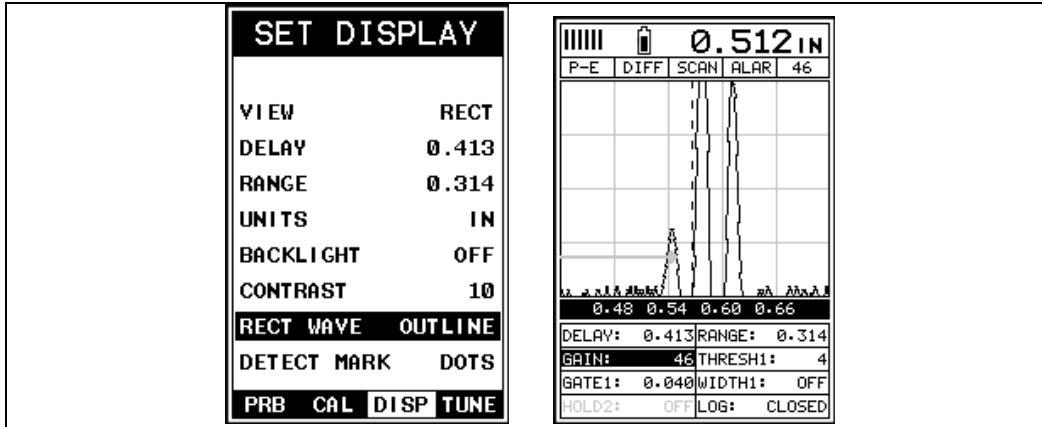

Filled – Draws a filled version of the waveform.

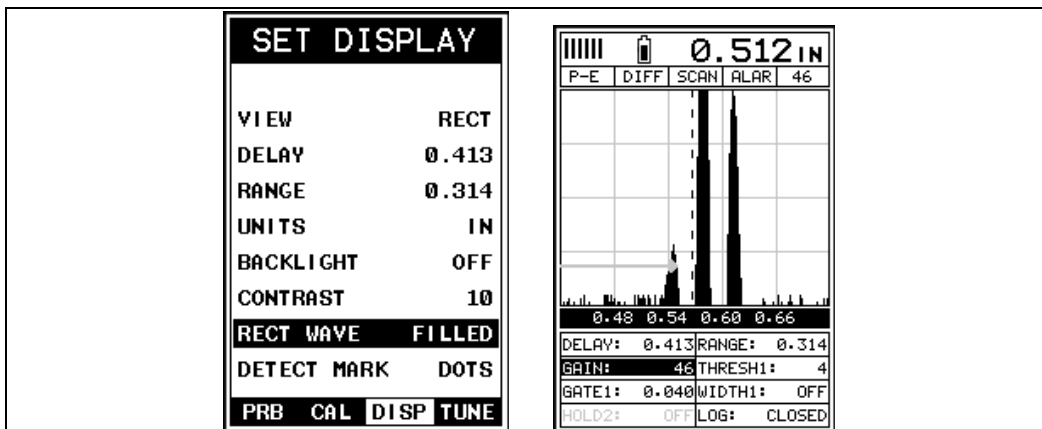

Detect Mark:

The detect mark is another look and feel option for displaying the detection indicator.

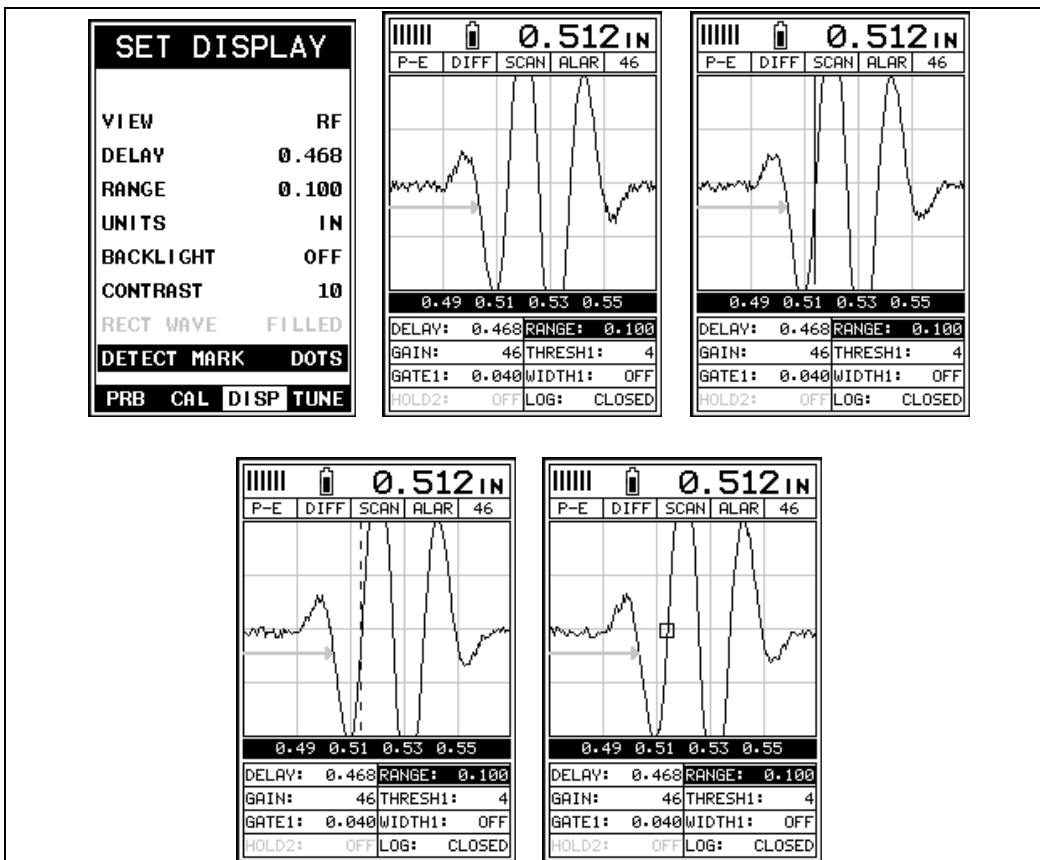

10.11 Polarity

The **CMX^{DL+}** is equipped with an option to select the polarity, or phase +/-, for the purpose of detection. The phase can be a very valuable feature to have when the signal returning from the test material is marginal, a low frequency transducer is being used, and the user has a very weak positive or negative cycle, while trying to measure very thick materials. There is a possibility that signal will become so weak that it falls below the threshold, and peak jumps to the next cycle altogether. This peak jump represents a shift of the detection further out in time, resulting in incorrect measurements. The material being measured will appear thicker than it actually is. Refer to the diagram below:

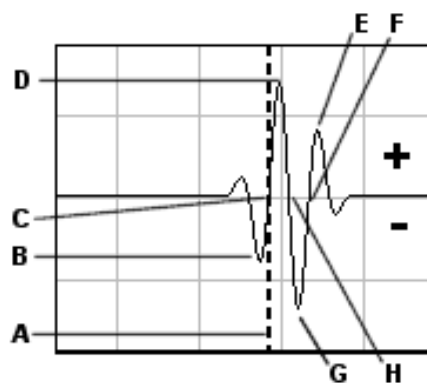

Notice the +/- positions in the diagram. The positive phase is everything above the horizontal center line, and the negative everything below the center line. The **CMX^{DL+}** uses a **zero crossing (flank) method for detection**. Therefore, the detect line **(A)** is represented by the broken vertical dotted line, and is currently detecting on the negative portion of the waveform **(B)** at the zero crossing **(C)**. The signal amplitude **(B)** is shown as the negative vertical height at **(B)** in the diagram. Refer to the height of the second negative peak at **(G)**. It's clear that the amplitude of **(G)** is much greater than that of **(B)**. Therefore, if the user was measuring thick attenuative material, and the amplitude of **(B)** decreased substantially, the **CMX^{DL+}** would lose the first cycle **(B)** and peak jump to the second cycle **(F)**. The detect **(A)**, would move to **(F)**, resulting in incorrect measurements.

If the user were to select the positive phase in the diagram above, the detect would measure at **(H)**. **(A)** would move to **(H)**. Notice the height of **(D)** with respect to the height of **(E)** in the diagram. If the user was measuring thick attenuative material using this phase, the signal **(E)** will certainly be lost long before **(D)**. Therefore, the positive phase is a much better choice in the diagram above.

Toggle Polarity (+/-)

TUNE SIGNAL	
MEASURE MODE	P-E
POLARITY	NEGATIVE
PULSE	THIN
PULSER VOLT	150
ATTN	0 DB
GAIN	46
AGC	0
PRB	CAL DISP TUNE

Note: Before toggling the **Polarity**, the **CMX^{DL+}** should be set to the **RF** display view option. The **RF** view will give the user the best opportunity to correctly view the positive and negative cycles of the waveform. Please refer to page 61 for information on selecting the **Display Views**.

- 1) Press the **MENU** key once to activate the menu items tab. Press the **MENU** key multiple times to tab right, and the **ESC** key multiple times to tab left, until the **TUNE** menu is highlighted and displaying the submenu items.
- 2) Use the **UP** and **DOWN** arrow keys to scroll through the sub menu items until **POLARITY** is highlighted.
- 3) Use the **LEFT** and **RIGHT** arrow keys to toggle the **POLARITY** negative or positive.
- 4) Press the **MEAS** key to return to the measurement screen and begin taking readings.

Important: Be sure to do a Probe Zero after changing the polarity!

10.12 Pulse Width

The **CMX^{DL+}** has an adjustable pulse width option. Pulse width, refers to the duration of time the pulser is left on. This time results in increased energy sent into the test

material. There are three width options (**SPIKE**, **THIN**, and **WIDE**). The **SPIKE** setting may be desirable for high resolution and general applications to decrease the overall noise. This can be considered the normal or standard setting. When additional energy is needed, more penetration, the **THIN** and **WIDE** options may be necessary. The procedure to change the pulse width is outlined below:

Selecting the Pulse Width

TUNE SIGNAL	
MEASURE MODE	P-E
POLARITY	NEGATIVE
PULSE	THIN
PULSER VOLT	150
ATTN	0 DB
GAIN	46
AGC	0
PRB	CAL
DISP	TUNE

- 1) Press the **MENU** key once to activate the menu items tab. Press the **MENU** key multiple times to tab right and the **ESC** key multiple times to tab left until the **TUNE** menu is highlighted and displaying the submenu items.
- 2) Use the **UP** and **DOWN** arrow keys to scroll through the sub menu items until **PULSE** is highlighted.
- 3) Use the **LEFT** and **RIGHT** arrow keys to scroll the **Pulse** options.
- 4) Once the **Pulse** is displayed, press the **MEAS** key to return to the measurement screen.

10.13 Pulser Voltage

The **CMX^{DL+}** has a 200 volt square wave pulser that can be adjusted for specific applications and transducers. The Pulser Volt feature offers a 50 volt cut/boost

option to the user. The standard setting is 150 volts. This enables the **CMX^{DL+}** to offer greater penetration for difficult material types, or increased resolution on noisy materials. The procedure to change the pulser voltage is outlined below:

Changing the Pulser Voltage

TUNE SIGNAL	
MEASURE MODE	P-E
POLARITY	NEGATIVE
PULSE	THIN
PULSER VOLT	150
ATTN	0 DB
GAIN	46
AGC	0
PRB	CAL DISP TUNE

- 1) Press the **MENU** key once to activate the menu items tab. Press the **MENU** key multiple times to tab right and the **ESC** key multiple times to tab left until the **TUNE** menu is highlighted and displaying the submenu items.
- 2) Use the **UP** and **DOWN** arrow keys to scroll through the sub menu items until **PULSER VOLT** is highlighted.
- 3) Use the **LEFT** and **RIGHT** arrow keys to scroll the **Pulser Voltage** options.
- 4) Once the desired **Pulser Voltage** is displayed, press the **MEAS** key to return to the measurement screen.

10.14 Attenuator

The **CMX^{DL+}** is equipped with a 20dB signal attenuator and amplifier. This feature offers a cut/boost to the overall signal strength. by either cutting or boosting signal strength. In instances where the 60 dB range is not enough, or too much, this feature allows you to increase/decrease the amplifier strength by a power of 10 or (20dB). The standard setting is zero, which is an arbitrary value at a constant

attenuation. The attenuation value is added to the gain value. Therefore, if the attenuator is increased to 20dB, this value is added to the value of the gain setting. The procedure to change the attenuator is outlined below:

Changing the Attenuator Setting

TUNE SIGNAL	
MEASURE MODE	P-E
POLARITY	NEGATIVE
PULSE	THIN
PULSER VOLT	150
ATTN	0 DB
GAIN	46
AGC	0
PRB	CAL DISP TUNE

- 1) Press the **MENU** key once to activate the menu items tab. Press the **MENU** key multiple times to tab right and the **ESC** key multiple times to tab left until the **TUNE** menu is highlighted and displaying the submenu items.
- 2) Use the **UP** and **DOWN** arrow keys to scroll through the sub menu items until **ATTN** is highlighted.
- 3) Use the **LEFT** and **RIGHT** arrow keys to scroll the **Attenuator** options.
- 4) Once the desired **Attenuation** is displayed, press the **MEAS** key to return to the measurement screen.

CHAPTER ELEVEN

DATA STORAGE – SETUP, EDIT, & VIEW FILES

11.1 Introduction to Grid and Sequential file formats

The **CMX^{DL+}** is equipped with two data file format options, **GRID LOG** and **SEQ LOG**. The **GRID** file format is very similar to a spreadsheet format found in popular software programs like Excel. A **GRID** is simply a table of readings. A location in a grid is specified by giving a row and column coordinate. The rows are numbered from 1 to 999 and the columns are labeled from A to ZZ (999 Rows & 52 Columns). The sequential file format can be viewed as a file as a single column of up to 512 possible rows (readings), and a column of corresponding identifiers associated with each individual reading. The identifier can be a combination of up to 10 numeric, alpha, or special characters listed above, while the file name can consist of a combination of up to 20 of the same character set. Note: *The identifier cannot start or end with a special character.* Once a start and end ID are entered into the **CMX^{DL+}** and the log created, the **CMX^{DL+}** will automatically generate all the identifiers within that range.

The following character set listed below are all the allowable characters that will be used for both file formats: **GRID & SEQ LOG**. Any combination of these characters can be used for creating a Name and Note regardless of the selected format. The allowable characters are as follows:

Numeric characters: 0 – 9 **Alpha Characters:** A – Z

Special Characters: ! ' _ # space / . – ()

Multiple grids can be created and stored until the **CMX^{DL+}**'s memory is full. If the user attempts to store a new file in the **CMX^{DL+}** and the size of the file exceeds the capacity of memory, the **CMX^{DL+}** will respond with an error message indicating that the memory is unable to store the new file.

The **CMX^{DL+}** can store a total of **16,000+ readings** with a corresponding screenshot of the **DIGITS**, **RF**, **RECT**, or **B-SCAN** views with every reading, as well as all the **CMX^{DL+}** settings for every individual reading. If the graphics option is disabled, not saving screenshots, the **CMX^{DL+}** can store a total of **210,000+ readings**. The screenshot stored with the reading will depend on what view the **CMX^{DL+}** was in at the time it was saved. For example, if the view was in **RECT**, then a **RECT** will be saved with the reading.

In the sections that follow, the procedures for creating, using, and editing **GRID's** and **SEQ LOG's** have been combined together for the purpose of similarity in overall

functionality and structure. The illustrations below are snapshots of typical **GRID** and **SEQ LOG** file formats:

Grid File Formats

<table border="1" style="width: 100%; border-collapse: collapse;"> <tr> <th colspan="4" style="background-color: black; color: white;">NAME: EX#1</th> </tr> <tr> <th style="width: 5%;"></th> <th style="width: 25%;">A</th> <th style="width: 25%;">B</th> <th style="width: 25%;">C</th> </tr> <tr> <td>1</td> <td></td> <td></td> <td></td> </tr> <tr> <td>2</td> <td></td> <td></td> <td></td> </tr> <tr> <td>3</td> <td></td> <td></td> <td></td> </tr> <tr> <td>4</td> <td></td> <td></td> <td></td> </tr> </table>	NAME: EX#1					A	B	C	1				2				3				4				<table border="1" style="width: 100%; border-collapse: collapse;"> <tr> <th colspan="4" style="background-color: black; color: white;">NAME: EX#2</th> </tr> <tr> <th style="width: 5%;"></th> <th style="width: 25%;">D</th> <th style="width: 25%;">E</th> <th style="width: 25%;">F</th> </tr> <tr> <td>6</td> <td></td> <td></td> <td></td> </tr> <tr> <td>7</td> <td></td> <td></td> <td></td> </tr> <tr> <td>8</td> <td></td> <td></td> <td></td> </tr> <tr> <td>9</td> <td></td> <td></td> <td></td> </tr> </table>	NAME: EX#2					D	E	F	6				7				8				9			
NAME: EX#1																																																	
	A	B	C																																														
1																																																	
2																																																	
3																																																	
4																																																	
NAME: EX#2																																																	
	D	E	F																																														
6																																																	
7																																																	
8																																																	
9																																																	

Sequential Log Formats

<table border="1" style="width: 100%; border-collapse: collapse;"> <tr> <th colspan="2" style="background-color: black; color: white;">NAME: EX#1</th> </tr> <tr> <td style="width: 50%;">AA</td> <td></td> </tr> <tr> <td>AB</td> <td></td> </tr> <tr> <td>AC</td> <td></td> </tr> <tr> <td>AD</td> <td></td> </tr> <tr> <td>AE</td> <td></td> </tr> </table>	NAME: EX#1		AA		AB		AC		AD		AE		<table border="1" style="width: 100%; border-collapse: collapse;"> <tr> <th colspan="2" style="background-color: black; color: white;">NAME: EX#2</th> </tr> <tr> <td style="width: 50%;">01</td> <td></td> </tr> <tr> <td>02</td> <td></td> </tr> <tr> <td>03</td> <td></td> </tr> <tr> <td>04</td> <td></td> </tr> <tr> <td>05</td> <td></td> </tr> </table>	NAME: EX#2		01		02		03		04		05	
NAME: EX#1																									
AA																									
AB																									
AC																									
AD																									
AE																									
NAME: EX#2																									
01																									
02																									
03																									
04																									
05																									
<table border="1" style="width: 100%; border-collapse: collapse;"> <tr> <th colspan="2" style="background-color: black; color: white;">NAME: EX#3</th> </tr> <tr> <td style="width: 50%;">3A</td> <td></td> </tr> <tr> <td>3B</td> <td></td> </tr> <tr> <td>3C</td> <td></td> </tr> <tr> <td>3D</td> <td></td> </tr> <tr> <td>3E</td> <td></td> </tr> </table>	NAME: EX#3		3A		3B		3C		3D		3E		<table border="1" style="width: 100%; border-collapse: collapse;"> <tr> <th colspan="2" style="background-color: black; color: white;">NAME: EX#4</th> </tr> <tr> <td style="width: 50%;">BCD-4-01</td> <td></td> </tr> <tr> <td>BCD-4-02</td> <td></td> </tr> <tr> <td>BCD-4-03</td> <td></td> </tr> <tr> <td>BCD-4-04</td> <td></td> </tr> <tr> <td>BCD-4-05</td> <td></td> </tr> </table>	NAME: EX#4		BCD-4-01		BCD-4-02		BCD-4-03		BCD-4-04		BCD-4-05	
NAME: EX#3																									
3A																									
3B																									
3C																									
3D																									
3E																									
NAME: EX#4																									
BCD-4-01																									
BCD-4-02																									
BCD-4-03																									
BCD-4-04																									
BCD-4-05																									

Important Note: For the duration of this chapter, all references to **GRIDS** and **SEQ LOGS** should be considered synonymous with references to **FILES**.

11.2 Creating a new Grid or Sequential Log (File)

Important Note: This entire section is a step by step guide to successfully create a grid or sequential log. The instructions must be used in the sequential order specified, as follows:

Creating a Name

Grid/Seq Log Name : Can contain a combination of up to 20 numeric, alpha, or special characters listed in the first section of this chapter.

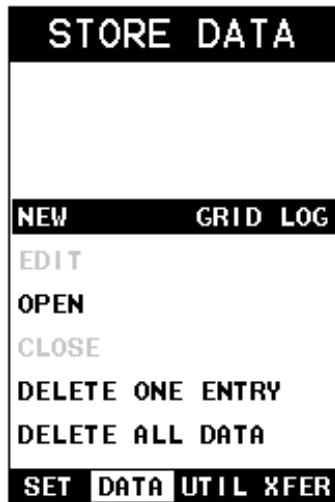

Grid Log



Sequential Log

- 1) Press the **MENU** key once to activate the menu items tab. Press the **MENU** key multiple times to tab right, and the **ESC** key multiple times to tab left, until the **DATA** menu is highlighted and displaying the submenu items.
- 2) Use the **UP** and **DOWN** arrow keys to scroll through the sub menu items until **NEW** is highlighted.
- 3) Press the **LEFT** & **RIGHT** arrow keys to toggle the data formats – **GRIG LOG** & **SEQ LOG**.

NEW GRID LOG	
NAME: BOILER 34	
NOTE:	
TOP LEFT:	A001
LOWER RIGHT	C050
INCR. DIR:	EAST
SAVE GRAPHICS	NO
CREATE GRID?	
GRID SIZE:	150

Grid Log

NEW SEQ LOG	
NAME: BOILER 34	
NOTE: INSP#99	
START:	B001
END ID:	01
DIRECTION:	NONE
SAVE GRAPHICS	NO
CREATE LOG	
LOG SIZE:	0

Sequential Log

- 4) Press the **ENTER** key to display the new **Grid** or **Seq Edit Box**.
- 5) Use the **UP** and **DOWN** arrow keys to scroll through the new **Grid** or **Seq List Items** until **NAME** is highlighted.

LOG NAME
0123456789
! ' _ # / . - ()
ABCDEFGHIJ
KLMNOPQRST
UVWXYZ
BOILER 34

OK

ESC

- 6) Press the **ENTER** key to activate the **Alpha Edit Box**.
- 7) Use the **UP, DOWN, LEFT, & RIGHT** arrow keys to highlight the appropriate alpha characters.
- 8) Press the **ENTER** key to select a character and advance to the next field of the **Grid** or **Seq Name**.

- 9) Use the **CLR** key to backspace if necessary.
- 10) Repeat steps 6 - 9 until the **Grid** or **Seq Name (File Name)** is completed.
- 11) Press the **OK** key to save the **Grid** or **Seq Name** and return to the **Grid** or **Seq List Items** menu, or **ESC** to cancel entering the **Grid** or **Seq Name (File Name)**.

Creating a Note

Grid/Seq Log Note: Can contain a combination of up to 20 numeric, alpha, or special characters listed in the first section of this chapter.

NEW GRID LOG	
NAME:	BOILER 34
NOTE: INSP#99	
TOP LEFT:	A001
LOWER RIGHT	A001
INCR. DIR:	NONE
SAVE GRAPHICS	NO
CREATE GRID?	
GRID SIZE:	1

Grid Log

NEW SEQ LOG	
NAME:	BOILER 34
NOTE: INSP#99	
START:	B001
END ID:	01
DIRECTION:	NONE
SAVE GRAPHICS	NO
CREATE LOG	
LOG SIZE:	0

Sequential Log

- 1) Assuming the **Grid** or **Seq** List Items are displayed, use the **UP** and **DOWN** arrow keys to scroll through the new **Grid** or **Seq List Items** until **NOTE** is highlighted.
- 2) Press the **ENTER** key to activate the **Alpha Edit Box**.

LOG NOTE

0123456789
 ! ' _ # █ / . - ()
 ABCDEFGHIJ
 KLMNOPQRST
 UVWXYZ

INSP#99 █

OK

ESC

- 3) Use the **UP, DOWN, LEFT, & RIGHT** arrow keys to highlight the appropriate alpha characters.
- 4) Press the **ENTER** key to select a character and advance to the next field of the **Grid** or **Seq Note**.
- 5) Use the **CLR** key to backspace if necessary.
- 6) Repeat steps **3** through **5** until the **Grid** or **Seq Note** is completed.
- 7) Press the **OK** key to save the **Grid** or **Seq Note** and return to the **Grid** or **Seq List Items** menu, or **ESC** to cancel entering the **Grid** or **Seq Note**.

Setting the Coordinates or Start & Stop ID's

Grid: A grid is defined by using coordinates to define the **Top Left** and the **Bottom Right** corners of the grid. Alpha coordinates are horizontal across the top, and numeric coordinates are vertical down the side. Therefore, to define the top left corner of the grid, there will be an (X,Y) coordinate. Where X is an alpha column location across the top and Y is a numeric row location down the side. Use the same logic when choosing the lower right corner. An individual grid can be up to 999 rows and 52 columns.

Sequential: The sequential file format can be viewed as a file as a single column of up to 512 possible rows (readings), and a column of corresponding identifiers associated with each individual reading. The identifier can be a combination of up to 10 numeric, alpha, or special characters listed above, while the file name can consist of a combination of up to 20 of the same character set. Note: *The identifier cannot start or end with a special character.* Once a start and end ID are entered into the **CMX^{DL+}** and the log created, the **CMX^{DL+}** will automatically generate all the identifiers within that range.

Setting the Top Left(Grid) or Start ID(Seq)

NEW GRID LOG	
NAME:	BOILER 34
NOTE:	INSP#99
TOP LEFT:	A001
LOWER RIGHT	A001
INCR. DIR:	NONE
SAVE GRAPHICS	NO
CREATE GRID?	
GRID SIZE:	1

Grid Log

NEW SEQ LOG	
NAME:	BOILER 34
NOTE:	
START:	B001
END ID:	01
DIRECTION:	NONE
SAVE GRAPHICS	NO
CREATE LOG	
LOG SIZE:	0

Sequential Log

- 1) Use the **UP** and **DOWN** arrow keys to scroll through the new **Grid** or **Seq List Items** until **TOP LEFT** or **START ID** is highlighted.
- 2) Press the **ENTER** key to activate the **Coordinate** or **Start ID Edit Box**.

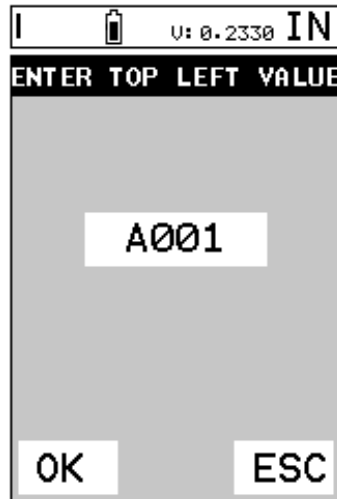

Grid Log

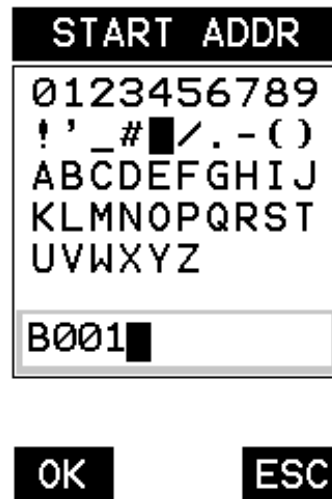

Sequential Log

- 3) **GRID LOG:** Use the **LEFT, & RIGHT** arrow keys to scroll the **Columns**, and the **UP, DOWN** arrow keys to scroll the **Rows**.

SEQ LOG: Use the **UP, DOWN, LEFT, & RIGHT** arrow keys to highlight the appropriate alpha characters. Press the **ENTER** key to select a character and advance to the next character field, in conjunction with using the **CLR** key to backspace if necessary.

- 4) Press the **OK** key to select the coordinate or start ID and return to the **Grid** or **Seq List Items** screen, or **ESC** to cancel the selection and return to the **Grid** or **Seq List Items** menu.

Setting the Bottom Right(Grid) or End ID(Seq)

NEW GRID LOG	
NAME:	BOILER 34
NOTE:	INSP#99
TOP LEFT:	A001
LOWER RIGHT	C050
INCR. DIR:	NONE
SAVE GRAPHICS	NO
CREATE GRID?	
GRID SIZE:	150

Grid Log

NEW SEQ LOG	
NAME:	BOILER 34
NOTE:	INSP#99
START:	B001
END ID:	B150
DIRECTION:	NONE
SAVE GRAPHICS	NO
CREATE LOG	
LOG SIZE:	150

Sequential Log

- 1) Use the **UP** and **DOWN** arrow keys to scroll through the new **Grid** or **Seq List Items** until **LOWER RIGHT** or **END ID** is highlighted.
- 2) Press the **ENTER** key to activate the **Coordinate** or **End ID Edit Box**.

U: 0.2338 IN	
BOTTOM RIGHT VALUE	
C050	
OK	ESC

Grid Log

STOP ADDR	
0123456789	
! ' _ # / . - ()	
ABCDEFGHIJ	
KLMNOPQRST	
UVWXYZ	
B150	
OK	ESC

Sequential Log

- 3) **GRID LOG:** Use the **LEFT**, & **RIGHT** arrow keys to scroll the **Columns**, and the **UP**, **DOWN** arrow keys to scroll the **Rows**.

SEQ LOG: Use the **UP**, **DOWN**, **LEFT**, & **RIGHT** arrow keys to highlight the appropriate alpha characters. Press the **ENTER** key to select a character

and advance to the next character field, in conjunction with using the **CLR** key to backspace if necessary.

- 4) Press the **OK** key to select the coordinate or end ID and return to the **Grid** or **Seq List Items** screen, or **ESC** to cancel the selection and return to the **Grid** or **Seq List Items** menu.

Note: If there is not enough memory available to create the grid or sequential log, an error message box “**NOT ENOUGH MEMORY**“ will be displayed. Press the **OK** or **ESC** key to return to the **Grid** or **Seq List Items** menu. It may be necessary to free some memory in the **CMX^{DL+}** at this time. Refer to page 147 for more information on **Deleting a File**.

Selecting the Auto Increment Direction

The **Auto Increment** feature gives the user the ability to specify which direction to advance the cursor after storing a reading.

NEW GRID LOG	
NAME:	BOILER 34
NOTE:	INSP#99
TOP LEFT:	A001
LOWER RIGHT	C050
INCR. DIR:	EAST
SAVE GRAPHICS	NO
CREATE GRID?	
GRID SIZE:	150

Grid Log

NEW SEQ LOG	
NAME:	BOILER 34
NOTE:	INSP#99
START:	B001
END ID:	B150
DIRECTION:	INC
SAVE GRAPHICS	NO
CREATE LOG	
LOG SIZE:	150

Sequential Log

- 5) Use the **UP** and **DOWN** arrow keys to scroll through the new **Grid** or **Seq List Items** until **INCR. DIR** or **DIRECTION** is highlighted.
- 6) Use the **LEFT & RIGHT** arrow keys to toggle the **Increment** direction **NONE, NORTH, EAST, SOUTH, or WEST** for a grid, or **INC, DEC** for a sequential log.
- 7) When the correct **Increment** direction is displayed, continue on to the next section "**Graphics**".

Saving Graphics

The **CMX^{DL+}** provides the user with the ability to save a snapshot of the display screen and all the current settings of the **CMX^{DL+}** with every reading, or just save the reading only. Saving the graphics might be advantageous to the user when the A/B-Scan views will be used to graphically save a picture of the scanned areas for reporting purposes. It might also come in handy when user requires backup of all the current **CMX^{DL+}** parameters for each reading. However, if neither of these requirements are necessary, this option should be disabled in order make more efficient use to the **CMX^{DL+}** storage capacity.

NEW GRID LOG	
NAME:	BOILER 34
NOTE:	INSP#99
TOP LEFT:	A001
LOWER RIGHT	C050
INCR. DIR:	EAST
SAVE GRAPHICS	NO
CREATE GRID?	
GRID SIZE:	150

Grid Log

NEW SEQ LOG	
NAME:	BOILER 34
NOTE:	INSP#99
START:	B001
END ID:	B150
DIRECTION:	INC
SAVE GRAPHICS	NO
CREATE LOG	
LOG SIZE:	150

Sequential Log

- 1) Use the **UP** and **DOWN** arrow keys to scroll through the new **Grid** or **Seq List Items** until **SAVE GRAPHICS** is highlighted.
- 2) Use the **LEFT & RIGHT** arrow keys to toggle the **Increment** direction to **YES** or **NO**.
- 3) Continue on to the next section "**Saving a Grid or Seq File**".

Saving a Grid

Once all the parameters are set, the user has the option of saving or canceling the new grid.

NEW GRID LOG	
NAME:	BOILER 34
NOTE:	INSP#99
TOP LEFT:	A001
LOWER RIGHT	C050
INCR. DIR:	EAST
SAVE GRAPHICS	NO
CREATE GRID?	
GRID SIZE:	150

Grid Log

NEW SEQ LOG	
NAME:	BOILER 34
NOTE:	INSP#99
START:	B001
END ID:	B150
DIRECTION:	INC
SAVE GRAPHICS	NO
CREATE LOG	
LOG SIZE:	150

Sequential Log

- 4) Use the **UP** and **DOWN** arrow keys to scroll through the new **Grid** or **Seq List Items** until **CREATE GRID** or **LOG?** is highlighted.
- 5) Press the **ENTER** key to accept the grid or seq log parameters and activate the confirmation screen.

CREATE GRID?	
CREATE A NEW DATA GRID	
?	
OK	ESC

CREATE LOG?	
CREATE A NEW DATA GRID	
?	
OK	ESC

Grid Log**Sequential Log**

- 6) Press the **OK** key to save the **New Grid** or **Seq Log**, or the **ESC** key to cancel **the New Grid or Seq Log** setup and return to the **DATA** menu.
- 7) Press the **MEAS** key to return to the measurement screen and begin storing readings.

11.3 Storing a reading

Now that a grid or sequential log has been created, it's time to make some measurements and store the readings. The following procedures outline this process:

Storing a Reading

Note: Once the grid or sequential log has been created it will automatically be displayed following the create confirmation screen. It is located at the bottom of the measurement screen, and can be left open for the duration of the inspection process. This section assumes the grid or sequential log was just created. Refer to the section on "opening a grid or seq log" if the file was created at another time.

Key Feature: When the **CMX^{DL+}** is displaying a "grid log", pressing the **OK** key will initiate an advance to row number option. Use the **Left, Right, UP,** and **DOWN** arrow keys to enter the row number. Once the row number is correctly displayed, press the **OK** key to advance directly to that row number in the grid log.

Key Feature: When the **CMX^{DL+}** is displaying a "grid log", pressing the **ESC** key multiple times, will toggle through the display options: **Digits, RF, RECT,** and **B-SCAN** views.

🔋 U: 0.2330 IN			
COAT			MED
0.250			
COAT: 0.035			
NAME: BOILER 34			
	A	B	C
1			
2			
3			
4			

Grid Log

🔋 U: 0.2330 IN			
COAT			MED
0.250			
COAT: 0.035			
NAME: BOILER 34			
	B001		
	B002		
	B003		
	B004		
	B005		

Sequential Log

- 1) Press the **UP**, **DOWN**, **LEFT**, and **RIGHT** arrow keys to scroll the target cell cursor to the desired storage location.
- 2) Press the **ENTER** key to save the current reading in the highlighted cell location. It's as simple as that!
- 3) Press the **MEAS** key to hide the **GRID/SEQ View Box**, or **ENTER** to display it as necessary.

Note: Once the file is open, it will remain open until it's closed or another file is opened by the user. If the gauge is powered off, the **CMX^{DL+}** will automatically open the file when powered on. Simply press the **ENTER** key to display the file from the measurement screen.

11.4 Viewing stored readings

It is sometimes necessary to go back and view the stored readings and B-Scans using the **CMX^{DL+}** without a PC. The following procedures outline this process:

Viewing Stored Readings & A/B Scans

MEM  U: 0.2330 IN			
COAT			MED
0.300			
COAT: 0.035			
NAME: BOILER 34			
	A	B	C
1	0.250	0.500	0.750
2	0.200	0.300	
3			
4			

Grid Log

MEM  U: 0.2330 IN	
COAT	MED
0.250	
COAT: 0.035	
NAME: BOILER 34	
B001	0.250
B002	0.500
B003	0.750
B004	1.000
B005	

Sequential Log

DELAY: 0.000	RANGE: 1.000
GAIN: 46	THRESH1: 4
GATE1: 0.040	WIDTH1: OFF
HOLD2: OFF	LOG: B002

- 1) Press the **MEAS** key once to activate measure menu items. Press the **MEAS** key multiple times to move right and the **ESC** key multiple times to move left until the **LOG** cell is highlighted.

NAME: GRID LOG			
	A	B	C
1	0.273	0.300	
2	0.523		
3			
4			

- 2) Press the **ENTER** key to display the **Grid Log Box**.
- 3) Press the **UP**, **DOWN**, **LEFT**, and **RIGHT** arrow keys to scroll the stored readings and corresponding display view. Notice as the cursor is moved to a different cell, the display will be updated with the display view saved with

the reading. Readings stored in memory are indicated by displaying a **MEM** in the top left corner of the measurement screen.

- 4) The user may opt to clear a specific reading and save a new one at any time. Press the **CLR** key in the appropriate cell location to clear the reading, take a new measurement, and press the **ENTER** key to save the new reading.
- 5) Abort the **Grid/Seq Log View Box** by pressing the **MEAS** key at any time.

11.5 Deleting Grids (Files)

Deleting One or All Files from Memory

Deleting One File

- 1) Press the **MENU** key once to activate the menu items tab. Press the **MENU** key multiple times to tab right and the **ESC** key multiple times to tab left until the **DATA** menu is highlighted and displaying the submenu items.

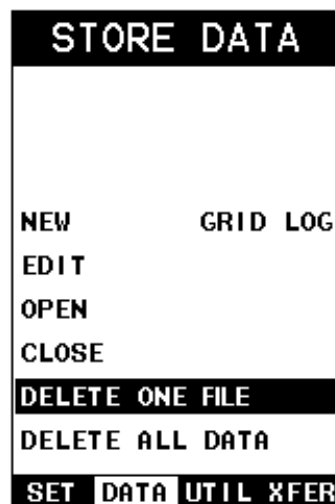

- 2) Use the **UP** and **DOWN** arrow keys to scroll through the sub menu items until **DELETE ONE FILE** is highlighted.

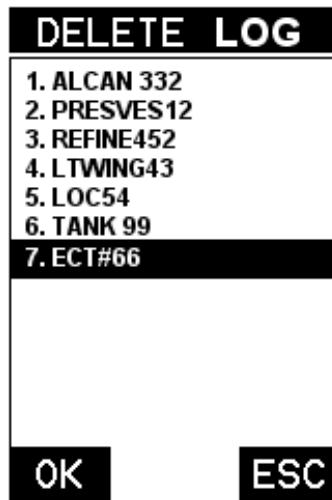

- 3) Press the **ENTER** key to display the **File List Box**.
- 4) Use the **UP** and **DOWN** arrow keys to scroll through the stored **Files** until the target **File** to delete is highlighted.
- 5) Press the **OK** key to delete the **File**.
- 6) Press the **MEAS** key to return to the measurement screen.

Deleting All Data

- 1) Press the **MENU** key once to activate the menu items tab. Press the **MENU** key multiple times to tab right and the **ESC** key multiple times to tab left until the **DATA** menu is highlighted and displaying the submenu items.

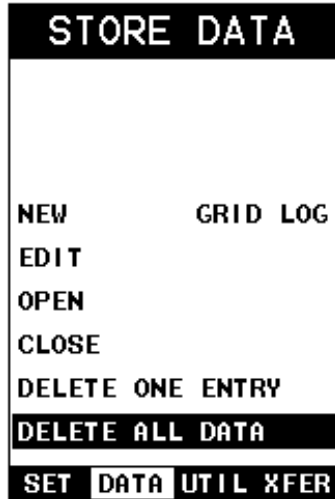

- 2) Use the **UP** and **DOWN** arrow keys to scroll through the sub menu items until **DELETE ALL DATA** is highlighted.

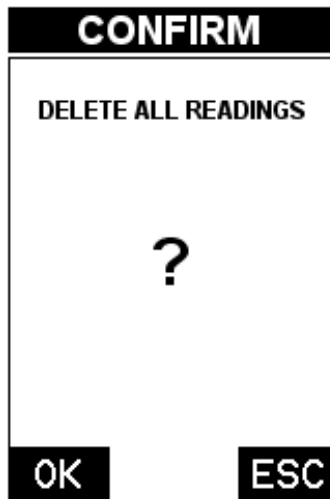

- 3) Press the **ENTER** key to activate the confirmation screen.
- 4) Press the **OK** key to delete **All Files** from memory, or the **ESC** key to abort.
- 5) Press the **MEAS** key to return to the measurement screen.

11.6 Editing a Grid (File)

Once a grid has been created and saved to memory, the user can edit the **Comments** or **Increment Direction** at a later time. The following procedures outline this process:

Editing a Grid

EDIT GRID LOG

NAME: BOILER 34

NOTE:

TOP LEFT: A001

LOWER RIGHT: C050

INCR. DIR EAST

SAVE GRAPHICS: OFF

SAVE CHANGES?

LOG SIZE 150

OK **ESC**

EDIT GRID LOG

NAME: BOILER 34

NOTE:

TOP LEFT: A001

LOWER RIGHT: C050

INCR. DIR EAST

SAVE GRAPHICS: OFF

SAVE CHANGES?

LOG SIZE 150

OK **ESC**

- 1) Press the **MENU** key once to activate the menu items tab. Press the **MENU** key multiple times to tab right and the **ESC** key multiple times to tab left until the **DATA** menu is highlighted and displaying the submenu items.
- 2) Use the **UP** and **DOWN** arrow keys to scroll through the sub menu items until **EDIT** is highlighted.
- 3) Press the **ENTER** key to display the **Edit List Box**.
- 4) Use the **UP** and **DOWN** arrow keys to scroll through the **Edit** options until **NOTE** or **INCR. DIR** is highlighted.

Note: If editing the **INCR. DIR**, simply use the **LEFT** or **RIGHT** arrow keys to scroll **NONE, NORTH, EAST, SOUTH, WEST** for a Grid, or **INC, DEC** for a Seq Log. **Proceed to step 10.**

LOG NOTE

0123456789
 ! ' _ # █ / . - ()
 ABCDEFGHIJ
 KLMNOPQRST
 UVWXYZ

 INSP#99 █

OK

ESC

- 5) Press the **ENTER** key to activate the **Alpha Edit box** – Only used when editing the **NOTE**.
- 6) Use the **UP, DOWN, LEFT, & RIGHT** arrow keys to highlight the appropriate alpha characters.
- 7) Press the **ENTER** key to select a character and advance to the next field of the **Comments**.
- 8) Use the **CLR** key to backspace if necessary.
- 9) Repeat steps **6 - 8** until the **Comments** are completed.

EDIT GRID LOG

NAME: BOILER 34
NOTE:
 TOP LEFT: A001
 LOWER RIGHT: C050
 INCR. DIR EAST
 SAVE GRAPHICS: OFF

SAVE CHANGES?

 LOG SIZE 150

OK

ESC

- 10) Press the **UP** or **DOWN** arrow key to highlight **SAVE CHANGES**, and the **OK** key to activate the confirmation screen.

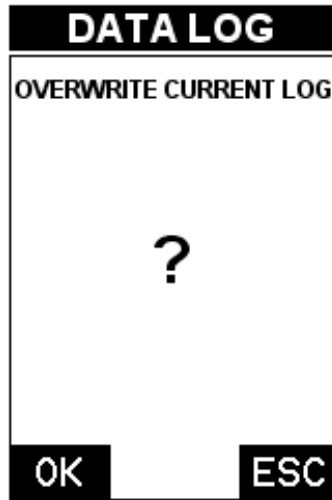

- 11) Press the **OK** key to save the changes or the **ESC** key to cancel editing the file parameters.
- 12) Press the **MEAS** key to return to the measurement screen.

11.7 Changing the active File - Open

The user may have transferred grid/seq templates from a PC to the **CMX^{DL+}**, or setup grids/seq using the **CMX^{DL+}** at an earlier time. The name of the currently active file is always displayed at the top of the **Grid/Seq Box** in measurement mode (refer to photo below). It's not only important to recognize what file is currently active, but also be able to change the active file at any time. The following procedures outline this process:

Changing the Active File

MEM  U: 0.2330 IN			
COAT			MED
0.300			
COAT: 0.035			
NAME: BOILER 34			
	A	B	C
1	0.250	0.500	0.750
2	0.200	0.300	
3			
4			

Grid Log

MEM  U: 0.2330 IN	
COAT	MED
0.250	
COAT: 0.035	
NAME: BOILER 34	
B001	0.250
B002	0.500
B003	0.750
B004	1.000
B005	

Sequential Log

- 1) Press the **MENU** key once to activate the menu items tab. Press the **MENU** key multiple times to tab right and the **ESC** key multiple times to tab left until the **DATA** menu is highlighted and displaying the submenu items.

STORE DATA	
NEW	SEQ LOG
EDIT	
OPEN	
CLOSE	
DELETE ONE ENTRY	
DELETE ALL DATA	
SET	DATA UTIL XFER

- 2) Use the **UP** and **DOWN** arrow keys to scroll through the sub menu items until **OPEN** is highlighted.

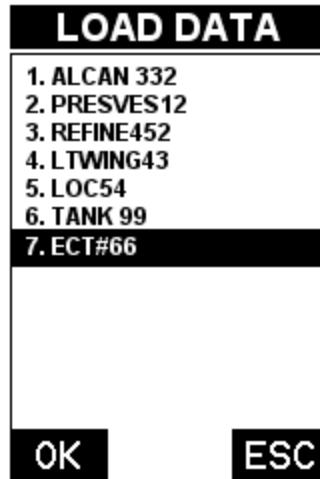

- 3) Press the **ENTER** key to display the **Grid/Seq List Box**.
- 4) Use the **UP** and **DOWN** arrow keys to scroll through the grids until the target grid is highlighted.

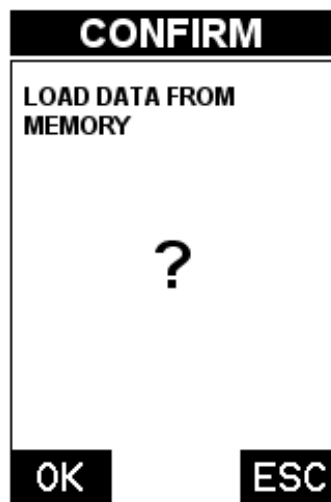

- 5) Press the **ENTER** key to activate the confirmation screen.
- 6) Press the **OK** key to load the file from memory.
- 7) Press the **MEAS** key to return to the measure screen.

11.8 Closing an active File - Close

A user might not have a current requirement to store measurements, but a file is currently open or active and needs to be closed. The following procedures outline how to close an open or active file :

Closing an Active File

- 1) Press the **MENU** key once to activate the menu items tab. Press the **MENU** key multiple times to tab right and the **ESC** key multiple times to tab left until the **DATA** menu is highlighted and displaying the submenu items.

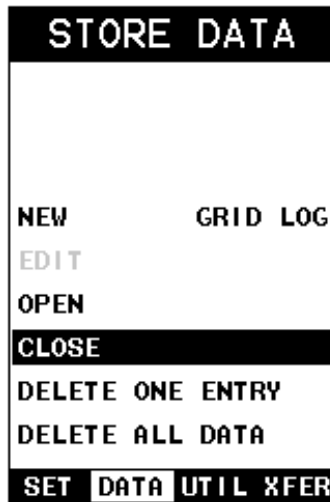

- 2) Use the **UP** and **DOWN** arrow keys to scroll through the sub menu items until **CLOSE** is highlighted.

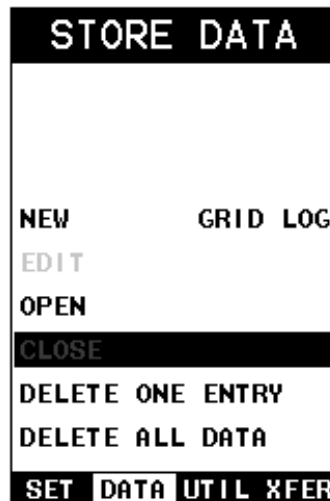

- 3) Press the **ENTER** key to close the active file. **Note:** Following the key press, the **CLOSE** text will be grayed out indicating the file has been close and is no longer active.

CHAPTER TWELVE SETUPS – CREATE, STORE, EDIT, & RECALL

12.1 Introduction to Setups

Often times, users are faced with a variety of tasks and applications that are sometimes similar, but often times very different. With a standard thickness gauge, the user would have to recalibrate for each individual application respectively. With all the features of the **CMX^{DL+}**, the number of potential applications also increases based on ability alone. This is primarily in reference to the addition of those very difficult applications, where a standard thickness gauge would not be feasible, or capable of accomplishing the tasks.

The increased number of features and parameters also adds to the overall setup time, or amount of time to set up marginal applications with perfection and understanding. Because of the additional time involved, the **CMX^{DL+}** has been equipped with the ability to save these setups to memory and be recalled at any time. The **CMX^{DL+}** can store up to **64 custom setups**. These setups can be bi-directionally transferred to and from a PC. Therefore, the user can save as many setups as necessary for all their individual applications requirements. This saves a great deal of time and knowledge for future inspections of the same job or project. This feature also eliminates error between two or more users during the setup and calibration process.

12.2 Opening a Setup

The **CMX^{DL+}** is loaded with a number of setups from the factory. These setups can be opened, edited, and saved to any one of **64 setup locations**. If a factory setup is written over, the user can simply reload the default factory setups at anytime using the utility software included with the **CMX^{DL+}**. The factory setups are general setups **Only**. However, they may serve as an excellent starting point, requiring only minor adjustments to work for custom applications. It is recommended that user customized setups be saved to an empty location, and save the factory setups for the purpose of a general starting point. The following procedures outline how to open factory and custom setups:

Opening a Setup

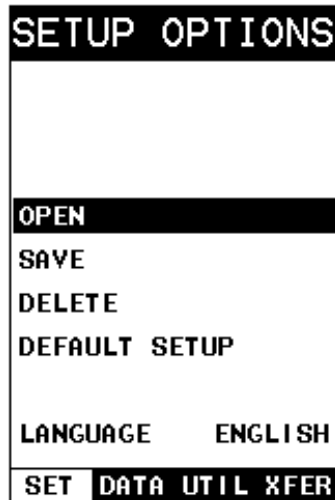

- 1) Press the **MENU** key once to activate the menu items tab. Press the **MENU** key multiple times to tab right and the **ESC** key multiple times to tab left until the **SETUP** menu is highlighted and displaying the submenu items.
- 2) Use the **UP** and **DOWN** arrow keys to scroll through the sub menu items until **OPEN** is highlighted.

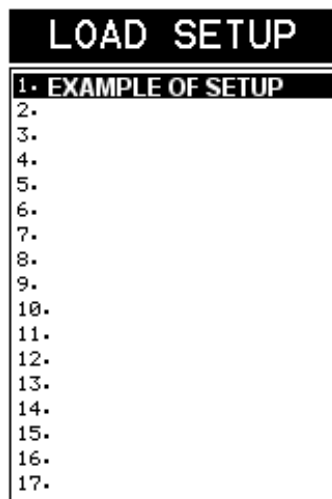

- 3) Press the **ENTER** key to display the **Setup List Box**.

- 4) Use the **UP** and **DOWN** arrow keys to scroll through the setups until the target setup is highlighted.

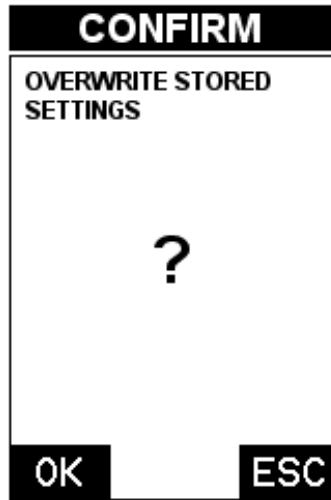

- 5) Press the **ENTER** key to activate the confirmation screen.
- 6) Press the **OK** key to load the setup from memory.
- 7) Press the **MEAS** key to return to the measure screen.

12.3 Saving a Setup

Once the **CMX^{DL+}** parameters and features have been adjusted for an application, the user may elect to save these settings to a specific setup location for future use. This can potentially save time and reduce error between users.

It is sometimes necessary to rename a previously saved setup, or add additional comments about a particular setup. The setup name may have been entered incorrectly, or the user needs to use the setup for a completely different project. An inspector's name or other comments about the project may also be required for additional documentation purposes. The following procedures outline the necessary steps for saving and editing a setup:

Saving a Setup

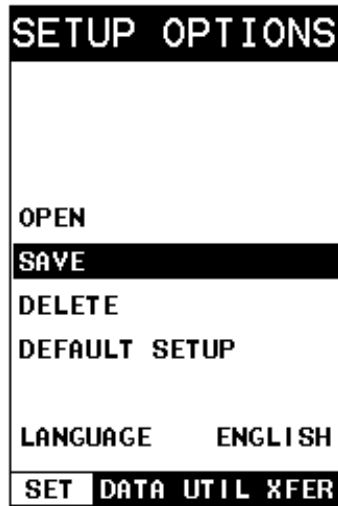

- 1) Press the **MENU** key once to activate the menu items tab. Press the **MENU** key multiple times to tab right and the **ESC** key multiple times to tab left until the **SETUP** menu is highlighted and displaying the submenu items.
- 2) Use the **UP** and **DOWN** arrow keys to scroll through the sub menu items until **SAVE** is highlighted.

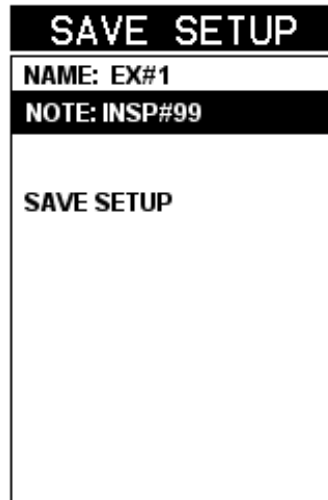
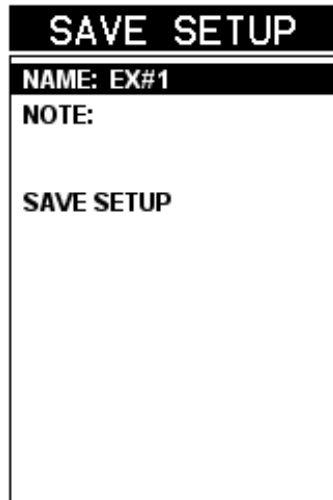

- 3) Press the **ENTER** key to display the **Save Setup Parameters List Box**.
- 4) Press the **UP** and **DOWN** arrow keys to scroll the **Name** and **Note** parameters.

SETUP NAME	SETUP NOTE
0123456789 ! ' _ # █ / . - () ABCDEFGHIJ KLMNOPQRST UVWXYZ EX#1 █	0123456789 ! ' _ # █ / . - () ABCDEFGHIJ KLMNOPQRST UVWXYZ INSP#99 █
OK	ESC
OK	ESC

- 5) When the parameter to edit is highlighted, press the **ENTER** key to activate the **Alpha Edit Box**.
- 6) Use the **UP**, **DOWN**, **LEFT**, and **RIGHT** arrow keys to scroll through the characters, the **ENTER** key to select characters, and the **CLR** key to backspace through the characters, until the **Name** or **Note** fields have been edited.
- 7) Press the **OK** key to return to the **Save Setup Parameters List Box**.
- 8) If both parameters will be edited, repeat steps 4 – 7.

SAVE SETUP
NAME: EX#1 NOTE: INSP#99
SAVE SETUP
(Empty space for scrolling)

- 9) Use the **UP** and **DOWN** arrow keys to scroll to and highlight **SAVE SETUP**.

10) Press the **ENTER** key to activate the **Setup List Box**.

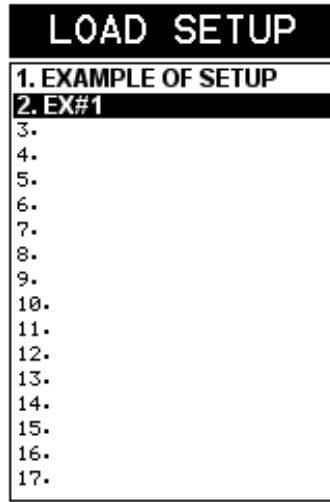

11) Use the **UP** and **DOWN** arrow keys to scroll through the setups until the target location to save the **Setup** is highlighted.

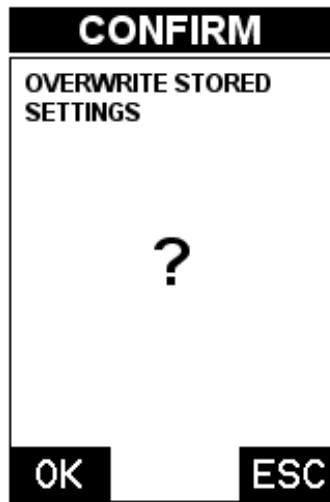

12) Press the **OK** key to activate the confirmation screen.

13) Press the **OK** key to save the **Setup**, or **ESC** to cancel saving the **Setup**.

14) Finally, press the **MEAS** key to return to the measurement screen.

Note: The **Name** and **Comments** of the **Setup** can be edited at any time by simply repeating the **Save Setup** routine described above. Therefore, the **Save Setup** function can also be considered an **Edit Function**.

12.4 Deleting a Saved Setup

This option allows a user to delete setup files that were previously saved and no longer needed. It's a simple feature to allow the user to do a bit of "house cleaning".

Deleting a Setup

SETUP OPTIONS

OPEN

SAVE

DELETE

DEFAULT SETUP

LANGUAGE ENGLISH

SET DATA UTIL XFER

- 1) Press the **MENU** key once to activate the menu items tab. Press the **MENU** key multiple times to tab right and the **ESC** key multiple times to tab left until the **SETUP** menu is highlighted and displaying the submenu items.
- 2) Use the **UP** and **DOWN** arrow keys to scroll through the sub menu items until **DELETE** is highlighted.

DELETE SETUP

1. EXAMPLE OF SETUP

2. EX#1

3.

4.

5.

6.

7.

8.

9.

10.

11.

12.

13.

14.

15.

16.

17.

- 3) Press the **ENTER** key to display the **Setups List**.
- 4) Press the **UP** and **DOWN** arrow keys to scroll to the **Setup Name**.
- 5) When the **Setup Name** is highlighted, press the **ENTER** key to display the confirmation screen.

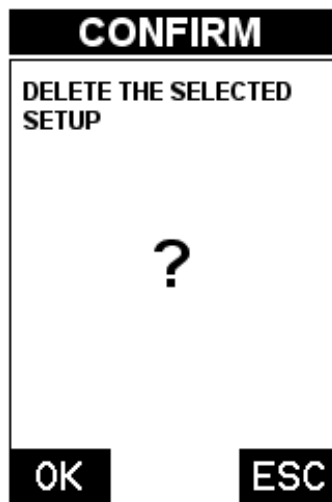

- 6) Press the **OK** key to delete the **Setup File**.
- 7) Finally, press the **MEAS** key to return to the measurement screen.

12.5 Using the Default Setup

The default setup feature was added to the **CMX^{DL+}** to use, as a last resort, if there are no setups stored in the gauge –factory or otherwise. The only time this might possibly occur is if the setup file in the **CMX^{DL+}** was somehow corrupted, and the user does not have access to a computer to re-load the factory setups back into the **CMX^{DL+}**. This gives the user the ability to load and modify a basic setup as follows:

Note: The default file contains no probe zero data. Therefore, a zero must be performed after loading. Also, the default setup can be loaded when using the flaw mode feature, to eliminate the probe zero delay value, and start at the initial pulse or zero.

Using the Default Setup



- 1) Press the **MENU** key once to activate the menu items tab. Press the **MENU** key multiple times to tab right and the **ESC** key multiple times to tab left until the **SETUP** menu is highlighted and displaying the submenu items.
- 2) Use the **UP** and **DOWN** arrow keys to scroll through the sub menu items until **DEFAULT SETUP** is highlighted.

12.6 Selecting a Language

The **CMX^{DL+}** is equipped with a language option. Currently, the only languages supported are English, Spanish, and German. The steps to select one of these languages are outlined as follows:

Selecting a Language



```
SETUP OPTIONS
OPEN
SAVE
DELETE
DEFAULT SETUP
LANGUAGE ENGLISH
SET DATA UTIL XFER
```

- 1) Press the **MENU** key once to activate the menu items tab. Press the **MENU** key multiple times to tab right and the **ESC** key multiple times to tab left until the **SETUP** menu is highlighted and displaying the submenu items.
- 2) Use the **UP** and **DOWN** arrow keys to scroll through the sub menu items until **LANGUAGE** is highlighted.
- 3) Press the **LEFT** and **RIGHT** arrow keys to toggle the language options.
- 4) Once the desired language is displayed, press the **MEAS** key to return to the measurement screen.

CHAPTER THIRTEEN USING THE UTILITY SOFTWARE

13.1 Computer System Requirements

DakView will run on many different operating systems: Windows 98 (1st or 2nd edition), Windows NT 4.0 with Service Pack 5, Windows ME, Windows XP, Windows 2000 Professional, Windows 2000 Server, or Windows 2000 Advanced Server operating systems running on Intel or AMD hardware.

A Pentium 166MHz or faster processor with at least 32 megabytes of physical RAM is required. You should have 40 megabytes of free disk space before attempting to install **DakView**.

DakView requires an available communications port in order to transfer data to and from the **CMX^{DL+}**. **DakView** supports COM1, COM2, COM3, and COM4.

USB to Serial Converter

Some newer laptop computers do not have standard serial ports. In this case it is possible to use a USB to Serial converter. If a serial to USB cable is needed, Contact Dakota Ultrasonics (pt# N-402-0510).

13.2 Installing DakView

DakView comes on a CD-ROM with an automatic installer program. Place the CD in your computer's CD tray and close the door. Open the CD-ROM by double clicking on the My Computer ICON, then double click on the CD. Finally, double click on the **SETUP** icon to begin the installation.

Refer to the help section in **DakView** software for the complete operating manual, setup, and operation.

13.3 Using the XFER menu (*CMX^{DL+}*)

The **XFER** menu of the *CMX^{DL+}* will be used in conjunction with the **DakView** PC software. The steps below outline the procedure for accessing the **XFER** menu and basic operation as follows:

Accessing and Using the XFER Menu

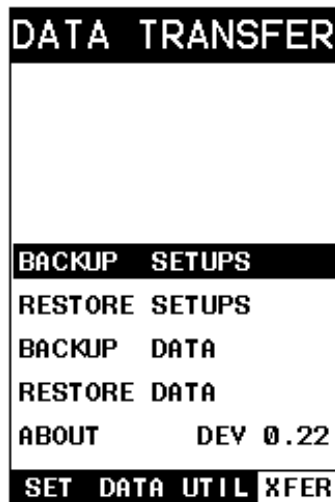

```
DATA TRANSFER
BACKUP SETUPS
RESTORE SETUPS
BACKUP DATA
RESTORE DATA
ABOUT DEV 0.22
SET DATA UTIL XFER
```

- 1) Press the **MENU** key once to activate the menu items tab. Press the **MENU** key multiple times to tab right, and the **ESC** key multiple times to tab left, until the **XFER** menu is highlighted and displaying the submenu items.
- 2) Use the **UP** and **DOWN** arrow keys to scroll through the sub menu items until the desired option is highlighted.
- 3) Press the **ENTER** key to activate the option selected.
- 4) Once the **Backup** or **Restore** function has been completed, press the **MEAS** key once to return to the menu items, or twice to return to the measurement mode.

APPENDIX A - VELOCITY TABLE

Material	sound velocity in/us		sound velocity m/s
Aluminum	0.2510		6375
Beryllium	0.5080		12903
Brass	0.1730		4394
Bronze	0.1390		3531
Cadmium	0.1090		2769
Columbium	0.1940		4928
Copper	0.1830		4648
Glass (plate)	0.2270		5766
Glycerine	0.0760		1930
Gold	0.1280		3251
Inconel	0.2290		5817
Iron	0.2320		5893
Cast Iron	0.1800	(approx)	4572
Lead	0.0850		2159
Magnesium	0.2300		5842
Mercury	0.0570		1448
Molybdenum	0.2460		6248
Monel	0.2110		5359
Nickel	0.2220		5639
Nylon	0.1060	(approx)	2692
Platinum	0.1560		3962
Plexiglas	0.1060		2692
Polystyrene	0.0920		2337
PVC	0.0940		2388
Quartz glass	0.2260		5740
Rubber vulcanized	0.0910		2311
Silver	0.1420		3607
Steel (1020)	0.2320		5893
Steel (4340)	0.2330		5918
Steel Stainless"	0.2230		5664
Teflon	0.0540		1372

Tin	0.1310		3327
Titanium	0.2400		6096
Tungsten	0.2040		5182
Uranium	0.1330		3378
Water	0.0580		1473
Zinc	0.1660		4216
Zirconium	0.1830		4648

APPENDIX B - SETUP LIBRARY

Num	Name	Comment 1	Gn/AGC	Velocity
1	Enter Custom Name			
2	...			
3	...			
4	...			
5	...			
6	...			
...	...			

WARRANTY INFORMATION

· Warranty Statement ·

Dakota Ultrasonics warrants the **CMX DL+** against defects in materials and workmanship for a period of two years from receipt by the end user. Additionally, Dakota Ultrasonics warrants transducers and accessories against such defects for a period of 90 days from receipt by the end user. If Dakota Ultrasonics receives notice of such defects during the warranty period, Dakota Ultrasonics will either, at its option, repair or replace products that prove to be defective.

Should Dakota Ultrasonics be unable to repair or replace the product within a reasonable amount of time, the customer's alternative exclusive remedy shall be refund of the purchase price upon return of the product.

· Exclusions ·

The above warranty shall not apply to defects resulting from: improper or inadequate maintenance by the customer; unauthorized modification or misuse; or operation outside the environmental specifications for the product.

Dakota Ultrasonics makes no other warranty, either express or implied, with respect to this product. Dakota Ultrasonics specifically disclaims any implied warranties of merchantability or fitness for a particular purpose. Some states or provinces do not allow limitations on the duration of an implied warranty, so the above limitation or exclusion may not apply to you. However, any implied warranty of merchantability or fitness is limited to the five-year duration of this written warranty.

This warranty gives you specific legal rights, and you may also have other rights which may vary from state to state or province to province.

· Obtaining Service During Warranty Period ·

If your hardware should fail during the warranty period, contact Dakota Ultrasonics and arrange for servicing of the product. Retain proof of purchase in order to obtain warranty service.

For products that require servicing, Dakota Ultrasonics may use one of the following methods:

- Repair the product
- Replace the product with a re-manufactured unit
- Replace the product with a product of equal or greater performance
- Refund the purchase price.

· After the Warranty Period ·

If your hardware should fail after the warranty period, contact Dakota Ultrasonics for details of the services available, and to arrange for non-warranty service.

MATERIAL SAFETY DATA SHEET

N/A = not applicable or not available

(To comply with 29 CFR 1910.1200)

SECTION 1 – PRODUCT IDENTIFICATION

Product Name: **SOUNDSAFE®**
Generic Name: Ultrasonic Couplant
Manufacturer: Sonotech, Inc.
774 Marine Dr., Bellingham, WA 98225
(360) 671-9121

NFPA Hazardous Materials
Identification System (est)
Health.....0
Flammability.....0
Reactivity.....0

SECTION 2 – HAZARDOUS INGREDIENTS

This material does not contain any ingredients having known health hazards in concentrations greater than 1%.

This material does not contain any known or suspected carcinogens.

SECTION 3 – PHYSICAL DATA (nominal)

Boiling Point: >220°F pH: 7.35 – 7.9
Freezing Point: <20°F Acoustic Imp.: 1.726x10⁶
Vapor Pressure: N/A Vapor Density: N/A
Evaporation Rate: N/A Specific Gravity: >1.02
Solubility in Water: complete
Appearance and Odor: water white, opaque gel;
bland odor

SECTION 4 – FIRE AND EXPLOSION HAZARD DATA

Flash Point: none
Upper Exposure Limit: none
Lower Exposure Limit: none
Special Fire Fighting Procedures: N/A
Extinguishing media: N/A
Unusual Fire and Explosion Hazards: none

SECTION 5 – REACTIVITY DATA

Stability: Stable
Conditions to Avoid: none
Incompatibility (Materials to Avoid): none known
Hazardous Polymerization: will not occur
Hazardous Decomposition or Byproducts: none known

SECTION 6 – HEALTH HAZARD AND FIRST AID DATA

Routes of Entry:¹
Skin: not likely Ingestion: not normally
Eyes: not normally Inhalation: no
Effects of Overexposure: *Acute:* May cause temporary
eye irritation
Chronic: none expected

First Aid Procedures:
Skin: Remove with water if desired.
Eyes: Flush with water for 15 minutes.
Ingestion: For large quantities, induce vomiting and
call a physician.
Inhalation: N/A

SECTION 7 – STORAGE AND HANDLING INFORMATION

Precautions to be taken in handling and storage: Store
between 20°F and 120°F. Spills are slippery and should
be cleaned up immediately.
Steps to be taken in case material is released or spilled:
Pick up excess for disposal. Clean with water.
Waste disposal method: Dispose of in accordance with
federal, state, and local regulations.

SECTION 8 – CONTROL MEASURES

Respiratory Protection: not required
Ventilation: not required
Protective Gloves: on individuals demonstrating
sensitivity to SOUNDSAFE®
Eye Protection: as required by working conditions
Other Protective Equipment: not required

¹SOUNDSAFE® contains only food grade and cosmetic grade ingredients.

SONOTECH, INC.

774 Marine Dr., Bellingham, WA 98225
Telephone: (360) 671-9121

Toll Free: 1-800-458-4254

Fax: (360) 671-9024

