



DMIII MultiTest

User's Manual

CE



INDEX

1. SAFETY PRECAUTIONS AND PROCEDURES	4
1.1. Forwards.....	4
1.2. Preliminary Instruction	4
1.3. During Use.....	5
1.4. After Use.....	5
2. GENERAL DESCRIPTION	6
2.1. Introduction	6
2.2. Functions	6
3. PREPARATION FOR USE	7
3.1. Initial Control.....	7
3.2. Power Supply.....	7
3.3. Calibration.....	8
3.4. Storage	8
4. INSTRUMENT DESCRIPTION	9
4.1. Display Description	10
4.2. Initial Screen	10
4.3. Backlight function.....	10
5. INITIAL SETTINGS.....	11
5.1. How To Adjust The Contrast.....	11
5.2. How To Set Date And Time	11
5.3. How To Set The Language.....	11
5.4. How To Adjust The Country.....	11
5.5. RESET	12
6. SAFETY TEST FUNCTIONS	13
6.1. LOW Ω : Continuity Test with 200mA Test Current.....	13
6.1.1. Calibrating the test leads ("CAL" Mode).....	14
6.1.2. Measurement Procedure	16
6.1.3. Results of "AUTO" mode	17
6.1.4. Results of "RT+" and "RT-" modes.....	17
6.1.5. "AUTO", RT+, "RT-" faulty cases.....	19
6.2. INSULATION TEST: Insulation Resistance Measurement.....	21
6.2.1. Measurement Procedure	21
6.2.2. Results of "MAN" mode	23
6.2.3. Results of "TMR" mode.....	24
6.2.4. "MAN" and "TIMER" mode faulty cases.....	25
6.3.  : Phase Sequence Indicator	26
6.3.1. Measurement procedure and results of "  " mode.....	26
6.3.2.  Faulty Cases	28
6.4. GROUND TEST: Soil Resistance and Resistivity Measurements	30
6.4.1. Measurement procedure and results of "2-W" and "3-W" mode.....	30
6.4.2. Measurement procedure and results of " ρ " mode	32
6.4.3. "2-W", "3-W" and " ρ " faulty cases.....	34
7. POWER QUALITY.....	36
7.1. Basic Setting: ANALYZER CONFIG	37
7.1.1. Type of electrical system under test	37
7.1.2. How to set the fundamental frequency	37
7.1.3. How to set the Clamp Type.....	38
7.1.4. How to set the current range.....	38
7.1.5. How to set the value of the transformer voltage ratio (TV RATIO)	38
7.1.6. How to enable/disable the password	38
7.2. Basic Setting: RECORDER CONFIG.....	39
7.3. POWER QUALITY FUNCTIONS	46

7.4. "VOLTAGE" function.....	47
7.4.1. Symbols.....	47
7.4.2. "METER" mode.....	48
7.4.3. "HARM" mode.....	49
7.4.4. "WAVE" mode.....	51
7.5. "CURRENT" function.....	52
7.5.1. Symbols.....	52
7.5.2. "METER" mode.....	53
7.5.3. "HARM" mode.....	54
7.5.4. "WAVE" mode.....	56
7.6. "POWER" function.....	57
7.6.1. Symbols.....	57
7.6.2. "METER" mode.....	58
7.6.3. "WAVE" mode.....	60
7.7. "ENERGY" function.....	61
7.7.1. Symbols.....	61
7.7.2. "METER" mode.....	62
8. MEASURING PROCEDURES.....	63
8.1. Using the instrument in a single-phase system.....	63
8.2. Using the Instrument in a three-phase 4-wire system.....	64
8.3. Using the Instrument in a three-phase 3-wire system.....	65
9. SAVING RESULTS.....	67
9.1. Saving Safety Test Results.....	67
9.2. Saving Displayed Values of POWER QUALITY Function.....	67
10.RECORDINGS.....	68
10.1. Start A Recording.....	68
10.2. During A Recording.....	70
10.2.1. MENU key.....	70
10.2.2. Rotary Switch during a recording.....	71
10.3. Stopping a Recording / Energy Measurement.....	71
11.INSTRUMENT'S MEMORY.....	72
11.1. SAFETY TEST MEMORY.....	72
11.2. ANALYZER MEMORY.....	73
12.CONNECTING THE INSTRUMENT TO A PC.....	74
13.MAINTENANCE.....	75
13.1. General Instruction.....	75
13.2. Battery Replacement.....	75
13.3. Instrument Cleaning.....	75
14.TECHNICAL SPECIFICATIONS.....	76
14.1. Technical Features.....	76
14.1.1. Safety Test functions.....	76
14.1.2. POWER QUALITY function.....	77
14.2. Standards.....	78
14.2.1. General.....	78
14.2.2. Safety Test.....	78
14.2.3. POWER QUALITY.....	78
14.3. General Specifications.....	79
14.3.1. Mechanical Data.....	79
14.3.2. Power supply.....	79
14.3.3. Display.....	79
14.3.4. Memory.....	79
14.4. ENVIRONMENT.....	79
14.5. ACCESSORIES.....	80
15.SERVICE.....	81
15.1. WARRANTY CONDITIONS.....	81
15.2. SERVICE.....	81
16.PRACTICAL REPORTS FOR ELECTRICAL TESTS.....	82

16.1. Continuity Test On Protective Conductors	82
16.2. Check of the Circuit Separation	83
16.3. Measurement Of Floor Insulation Resistance In Medical Rooms Cei 64-4.....	86
16.4. Ground Resistance Measurement	88
16.5. Ground Resistivity Measurement.....	89
16.6. Voltage Anomalies (Voltage Sag and Surge).....	91
16.7. Voltage and current Harmonics	91
16.7.1. Theory.....	91
16.7.2. Limit values for harmonics	93
16.7.3. Presence of harmonics: causes.....	93
16.7.4. Presence of harmonics: consequences.....	94
16.8. Power and Power Factor definition	94
16.8.1. Conventions on powers and power factors.....	96
16.8.2. 3 Phase 3 Wire System	97
16.9. Measuring Method: outlines.....	98
16.9.1. Integration periods	98
16.9.2. Power factor calculations	98
16.9.3. Voltage Anomalies and Periods Analysis comparison.....	98
17.APPENDIX 1 – MESSAGES DISPLAYED	100
18.APPENDIX 2 – RECORDABLE PARAMETERS: SYMBOLS.....	101

Release EN 1.00 of the 31/06/2005

1. SAFETY PRECAUTIONS AND PROCEDURES

1.1. FORWARDS

This instrument conforms to the safety standards EN61557 and EN 61010-1 relating to electronic measuring instruments.



WARNING

For your own safety as well as that of the instrument you are recommended to follow the procedures described in this instruction manual and carefully read all the notes preceded by the symbol .

Strictly adhere to the following instructions before and during measurements:

- ☞ Do not measure voltage or current in wet or dusty places;
- ☞ Do not measure in presence of gas, explosive materials or combustibles;
- ☞ Do not touch the circuit under test if no measurement is being taken;
- ☞ Do not touch exposed metal parts, unused terminals, circuits and so on;
- ☞ Do not effect any measurement in case of unusual conditions of the instrument such as deformation, breakage, leakage of substances, absence of display reading etc;
- ☞ Do not use the External power supply adapter (code **DMT-EXTPS**) if you notice deformation, or breakage in the case, in the wire or in the plugs;
- ☞ Pay careful attention when measuring voltages exceeding 25V in particular places (building yards, swimming pools, etc.) and 50V in ordinary places because of the risk of electric shock;
- ☞ Use only cables and accessories approved by Amprobe;

The following symbols are used in this manual:



Caution: refer to the instructions in this manual; improper use may damage the apparatus or its components.



AC Voltage or Current.



Unidirectional pulsating Voltage or Current.



Rotary switch of the instrument.

1.2. PRELIMINARY INSTRUCTION

- ☞ This instrument has been designed for use in environments with a pollution level 2 and up to (and no more than) 2000 meters altitude.
- ☞ It can be used for Safety Test on Installation with Over voltage Category III 300V~ (phase to earth) and for **voltage and current** measurements on installations with over voltage category III 600 V~ phase-to-phase / 300 V~ phase to earth or CATII 350 V phase to earth.

- ☞ Please keep to the usual safety standards aimed at:
 - ◆ Protecting against dangerous currents;
 - ◆ Protecting the instrument against incorrect operations.
- ☞ Only the accessories supplied with the instrument guarantee compliance with the safety standards. Accordingly, they must be in good conditions and, if necessary, they must be replaced with identical models.
- ☞ Do not take measurements on circuits exceeding the specified current and voltage limits.
- ☞ Before connecting cables, alligator clips and clamps to the circuit under test, make sure that the right function has been selected.
- ☞ Do not take any measurements under environmental conditions beyond the limits specified in paragraph 14.4.
- ☞ Check that batteries are not weak and are installed correctly.
- ☞ Before connecting test leads to the circuit under test, check that rotary switch position is correct.

1.3. DURING USE

Please read the following recommendations carefully and instructions:



WARNING

Non-compliance with the Warnings and/or Instructions may damage the apparatus and/or its components or injure the operator.

- ☞ Before selecting any function disconnect the test leads from the circuit under test.
- ☞ When the instrument is connected to the circuit under test do not touch any unused terminal.
- ☞ Avoid taking resistance measurements in the presence of external voltages; even though the instrument is protected, a high voltage may cause malfunctions.
- ☞ When measuring current, other currents located near the leads may affect the measuring accuracy.
- ☞ When measuring current, always position the wire in the middle of the jaws in order to obtain the highest accuracy.
- ☞ A measured value remains constant if the "HOLD" function is active. Should you notice that the measured value remains unchanged, disable the "HOLD" function.



WARNING

The symbol "■" shows the battery charge: When it is completely black the batteries are full charged, while the "□" symbol indicates weak batteries. When the batteries are too low to execute a test, the instrument will show a warning message.

In this case, interrupt testing and replace batteries, following the procedure described in paragraph 13.2. **The instrument is capable of keeping the data stored even though batteries are not installed. The Instrument Date and Time settings aren't lost if you change the batteries within 24hours.**

1.4. AFTER USE

- After use, turn off the instrument by pressing & holding ON/OFF for a few seconds.
- Remove batteries when the apparatus remains unused for long periods. Please follow the storage instructions described at paragraph 14.4.

2. GENERAL DESCRIPTION

2.1. INTRODUCTION

Dear Customer, we thank you for your patronage. The instrument you have just purchased will grant you accurate and reliable measurements provided that it is used according to the present manual's instructions.

The instrument was designed to grant the user the utmost safety conditions thanks to a new concept assuring double insulation and over voltage category III.

2.2. FUNCTIONS

The instrument is able to perform the following tests:

- ☞ **LOWΩ:** Continuity Test of Protection and Equalising conductors with a test current higher than 200mA and open circuit voltage ranging from 4V to 24V.
- ☞ **INSULATION TEST:** Measurement of insulation resistance with DC test voltage 50V, 100V, 250V, 500V or 1000V.
- ☞ : Indication of phase rotation sequence
- ☞ **GROUND TEST** Measurement of Ground Resistance and Resistivity using Earth rods.
- ☞ **POWER QUALITY:** The Instrument allows the following operations:
 - ✓ **Display in real time** the electrical parameters of a single-phase and three-phase systems and the harmonic analysis of voltage and current.
 - ✓ **Conduct a direct Energy measurement** (without memorizing).
 - ✓ **Memorize** (by pressing the SAVE key) the sampled values of the Parameters present at instrument input generating a "Smp" record inside instrument memory. **It will be possible to analyze the memorized data ONLY by transferring it to a PC.**
 - ✓ **Record simultaneously** (pressing the START key after a proper set up): RMS values of voltages, currents, corresponding harmonics, active, reactive and apparent powers, power factors and $\cos\phi$, active, reactive and apparent energies, voltage anomalies (voltage sag and surge) with 10ms resolution. **It will be possible to analyze the recorded data ONLY by transferring them to a PC.**

WARNING



Please note the difference between **memorize** and **record**. These terms will be used repeatedly in this manual. Please focus on their definitions and distinctions.

3. PREPARATION FOR USE

3.1. INITIAL CONTROL

This instrument has been checked mechanically and electrically prior to shipment. Care has been taken to ensure that the instrument reaches you under safe conditions.

You are recommended, however, to carry out a rapid check to detect any possible damage, which might have been caused during transport. Should this be the case, immediately contact Amprobe.

Also, check that the packaging contains all the parts listed under paragraph 14.5. In case of discrepancies contact the dealer.



In case you have to send the instrument back please follow the instructions reported in paragraph 15.

3.2. POWER SUPPLY

The instrument can be powered by:

- ✓ 6 batteries 1.5V AA series located in the compartment on the back of the instrument (not included in the package). For battery life see paragraph 14.3.2.
- ✓ An external power supply adapter (code **DMT-EXTPS**) **to be used only for POWER QUALITY functions**. We recommend that you use only **DMT-EXTPS** Amprobe Power Supply adapter.

For your own safety you're not able to use the external power supply adapter during Safety Test (LOW Ω , INSULATION TEST, , GROUND TEST rotary Switch positions). If you press the START button the Instrument will show the message "v REMOVE POWER".

The symbol  shows the battery charge: If it is completely "black" the batteries are fully charged, while the  symbol indicates weak batteries. When the batteries are too low to execute the test the instrument will show a warning message. In this case interrupt testing and replace the batteries following the procedure described in paragraph 13.2. **The instrument is capable of keeping the data stored even though batteries are not installed. The Instrument Date and Time settings aren't lost if you change the batteries within 24hours.**

WARNING



For recordings (POWER QUALITY function) ALWAYS use the external power supply adapter (code **DMT-EXTPS**) even the instrument allows the operator to perform a recording using internal batteries. If during a recording the external power supply adapter is de-energized, the instrument will continue the recording using the internal battery power until the batteries are exhausted (the data stored up to the point the instrument shuts down won't get lost). Because of this we recommend you **ALWAYS insert a new set of batteries before a long recording.**

The instrument uses sophisticated algorithms to prolong the battery life. Specifically:

- ✓ The instrument switches OFF the backlight Automatically after 5 seconds.
- ✓ If the instrument is displaying in real time (and the external power supply adapter is not connected), after about 5 minutes from the last key press or switch rotation the instrument turns off automatically ("AUTOPOWER OFF" procedure).
- ✓ If the instrument is recording or is measuring energy (and the external power supply is not connected), after about 5 minutes from the last key press or switch rotation the instrument starts a special procedure to save the batteries ("ECONOMY MODE"): the instrument keeps recording but the display is turned off.

3.3. CALIBRATION

The instrument fulfils the technical specifications listed in this manual. The performance of the specifications is guaranteed for one year.

3.4. STORAGE

In order to maintain the accuracy of the measurements, after a period of storage in extreme environmental conditions, wait the necessary time for the apparatus to return to normal operating conditions (see environmental specifications listed in paragraph 14.4).

4. INSTRUMENT DESCRIPTION

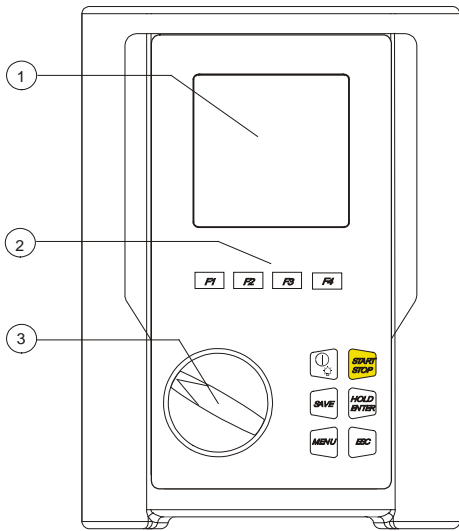

LEGEND:

- 1. Display
- 2. Function Keys
- 3. Rotary switch

Front panel of the Instrument

F1 F2 F3 F4 ➔ Multifunction Keys.

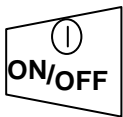

➔ **ON/OFF** and backlight key. Press it for few seconds to switch OFF the instrument, press it briefly to activate the backlight function.



➔ This key starts (and stops) the measurements.



➔ This key saves the result displayed.



➔ This key has 2 functions: it is the confirmation key inside the configuration menu and it freezes the displayed results using the POWER QUALITY function.



➔ This key opens the General Configuration Menu.



➔ This key cancels modification in the configuration menus or the selected working modes.

4.1. DISPLAY DESCRIPTION

The display is a graphic module with a resolution of 128 x 128 pixels
 The first line of the display shows date and time. If not correct, you can set the exact ones according to the procedure described at paragraph 5.2.
 On the top right corner of the display you can always see the battery indicator and, if the external power supply adapter (code **DMT-EXTPS**) is connected, the corresponding symbol.

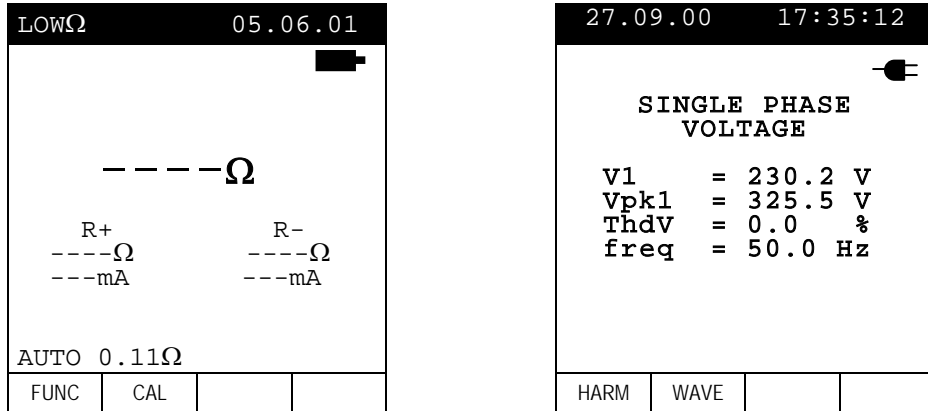

These symbols will be omitted in the following illustrations.

4.2. INITIAL SCREEN

When turning on the instrument by pressing ON/OFF, this screen will appear for a few seconds:

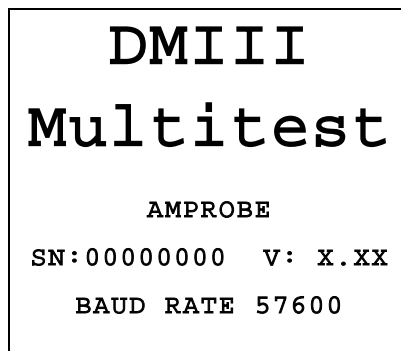

Here you can see:

- Serial number of the instrument (SN.:
- Firmware software release (V.X.XX:)
- Transmission speed through serial RS232 (Baud Rate)

4.3. BACKLIGHT FUNCTION

When the instrument is turned on, pressing, briefly, the **ON/OFF** button, the backlight will be enabled. The light will be automatically turned off after 5 seconds.
 If the batteries are too low the instrument will automatically disable the backlight function.

5. INITIAL SETTINGS

By pressing the **MENU** key the following screen will be displayed:

MENU GENERAL			
SAFETY TEST MEMORY			
ANALYZER MEMORY			
RESET			
ANALYZER CONFIG			
RECORDER CONFIG			
CONTRAST			
DATE&TIME			
LANGUAGE			
COUNTRY			
↓	↑		

It's not possible to enter the **MENU** during a recording or a Real Time Energy measurement. Pressing this button during a recording will display the main recording parameters (see paragraph 10.2).

5.1. HOW TO ADJUST THE CONTRAST

By pressing the multifunction keys **F1** and **F2**, position the cursor on the **CONTRAST** item and then press the **ENTER** key.

By pressing the multifunction keys **F3** and **F4**, adjust the contrast (higher values correspond to a higher contrast while lower values correspond to a lower contrast) and press the **ENTER** key to SAVE the change or press **ESC** to quit the modification.

This setting will remain unchanged after turning off the instrument.

5.2. HOW TO SET DATE AND TIME

By pressing the multifunction keys **F1** and **F2**, position the cursor on the **DATE&TIME** item and then press the **ENTER** key.

The time is expressed as **hh:mm** (2 digit for hours, 2 digit for minutes) military time.

Press the **ENTER** key to SAVE the change or press **ESC** to quit the modification.

This setting will remain unchanged after turning off the instrument.

5.3. HOW TO SET THE LANGUAGE

By pressing the multifunction keys **F1** and **F2**, position the cursor on the **LANGUAGE** (EN) or **LINGUA** (IT) item and confirm it by pressing the **ENTER** key.

By pressing the multifunction keys **F1** and **F2**, position the cursor on the desired language and press the **ENTER** key to SAVE the change or press **ESC** to cancel the modification.

This setting will remain unchanged after turning off the instrument.

5.4. HOW TO ADJUST THE COUNTRY

By pressing the multifunction keys **F1** and **F2**, position the cursor on the **COUNTRY** item and confirm it by pressing the **ENTER** key. By pressing the multifunction keys **F1** and **F1**, select the Country among the following possibilities:

UE_m: European Countries: Distance setting in "meter" for Resistivity measurement
Date format DD/MM/YY

US_m: United States: Distance setting in "meter" for Resistivity measurement
Date format MM/DD/YY

US_ft: United States: Distance setting in "feet" for Resistivity measurement
Date format MM/DD/YY

Press the **ENTER** key to SAVE the change or press **ESC** to quit the modification.

This setting will remain unchanged after turning off the instrument.

5.5. RESET

This option re-establishes the default settings of the instrument.

✓ ANALYZER CONFIG:

Type of electrical equipment:	Three Phase 4 wires
<i>Frequency:</i>	<i>not modified</i>
<i>Clamp full scale:</i>	<i>not modified</i>
<i>Clamp type:</i>	<i>not modified</i>
Transforming ratio of voltmetric transformers:	1
Password:	disabled

✓ RECORDER CONFIG:

Start:	manual (the recording is started at 00 sec mark on clock after pressing START/STOP)
Stop:	manual
Integration period:	15min
Recording of harmonics:	ON
Recording of voltage anomalies (sags and surges):	ON
Voltage reference for detection of sags and surges:	110V
Upper limit for detection of sags and surges:	6%
Lower limit for detection of sags and surges:	10%
Selected voltages:	V1, V2, V3
Selected voltage harmonics:	THD, 01, 03, 05, 07
Selected currents:	I1, I2, I3, IN
Selected current harmonics:	THD, 01, 03, 05, 07
CO-GENERATION:	OFF
Selected powers, Pf and $\cos\varphi$:	Pt, P1, P2, P3 Qti, Q1i, Q2i, Q3i Qtc, Q1c, Q2c, Q3c St, S1, S2, S3 Pft, Pf1, Pf2, Pf3 dpft, dpf1, dpf2, dpf3
Energies:	Eat, Ea1, Ea2, Ea3 Erit, Eri1, Eri2, Eri3 Erct, Erc1, Erc2, Erc3 Est, Es1, Es2, Es3

The RESET command will not erase the instrument's memory.

6. SAFETY TEST FUNCTIONS

6.1. LOWΩ: CONTINUITY TEST WITH 200mA TEST CURRENT

The measurement is taken according to EN 61557-2 and VDE 0413 part 4.



WARNING

Before carrying out the continuity test be sure that there is no voltage at the ends of the conductor under test.

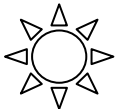

Turn the rotary knob to the **LOWΩ** position.

F1

This key allows the operator to select one of the following measuring modes:

- ☞ **AUTO** mode (the instrument carries out two measurements with reversed polarity and displays their average value). This mode is recommended for the continuity test.
- ☞ **RT+** mode (measurement with positive polarity and the ability to set the duration time of the test). In this case the operator can set a measuring time long enough to permit them to move the protective conductors while the instrument is carrying out the test so as to detect any bad connections.
- ☞ **RT-** mode (measurement with negative polarity and the ability to set the duration time of the test). In this case the operator can set a measuring time long enough to permit him to move the protective conductors while the instrument is carrying out the test so as to detect any bad connection.

F2

This key permits the operator to perform a calibration (compensation for the resistance of the cables used for the measurement).

N.B. If the resistance is lower than 5Ω (including the resistance of the calibration) the continuity test is executed by the instrument with a test current higher than 200mA. If the resistance is higher than 5Ω the continuity test is executed by the instrument with a current lower than 200mA.

We recommend that you check the calibration of the test leads before executing a measurement according to next paragraph.

6.1.1. Calibrating the test leads ("CAL" Mode)

1. Connect the black and yellow test leads to T1 and T4 input terminals respectively.

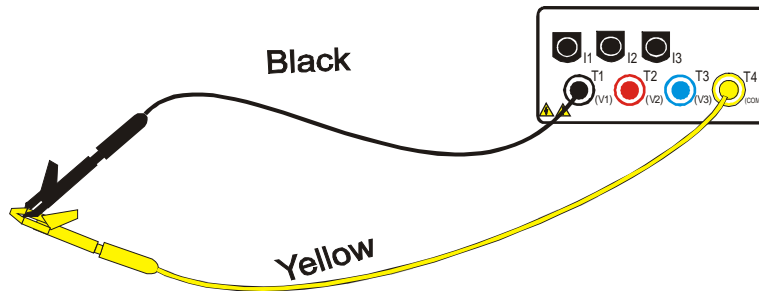

Connection of instrument terminals during calibration procedure.

2. If the test leads supplied with the instrument are not long enough for the measurement you can extend the black cable.
3. Short-circuit the measuring cable ends making sure that the conductive parts of the alligator clips make good contact with each other (see previous picture).
4. Press the **F2** key. The instrument performs the calibration.

F2

WARNING



Never disconnect the test leads when the message "MEASURING" is displayed.

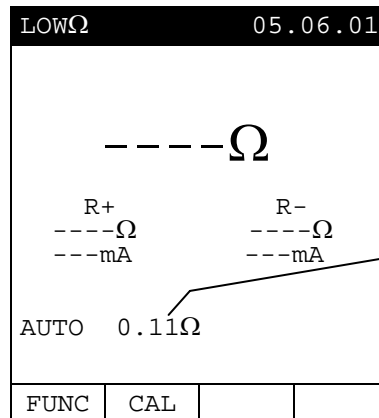

A numerical value in this field means that the instrument has been calibrated; this value **remains on the display for any further measurement** even though the unit is switched off and on again.

5. At the end of the test the result is stored and used as **OFFSET (that is to say that it is subtracted from any continuity test carried out)** for all the subsequent measurements.

Note:

The instrument performs the calibration only if the resistance of the test leads is lower than 5Ω.

TEST LEADS

Before each measurement always assure that the calibration is for the cables in use. During a continuity test, if the resistance value free of calibration (that is the resistance value less the calibration offset value) is **negative**, the symbol ν is displayed. Probably the calibration resistance value stored in the instrument memory is not for the cables in use, therefore a new calibration must be performed.

6.1.1.1. Procedure to reset test leads calibration parameters

☞ To cancel calibration parameters it is necessary to perform a **calibration procedure with a resistance of test leads higher than 5Ω** (for example with open test leads). When a cancellation is effected **the screen to the right** is displayed temporarily.

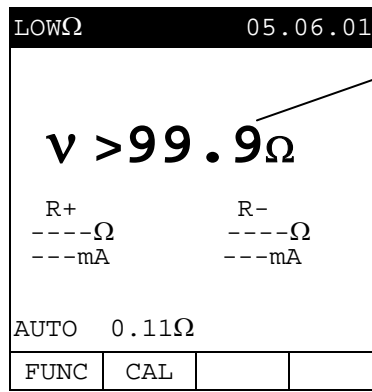

Message >99.9Ω: means that the instrument detected a resistance higher than 5Ω therefore it will proceed with Reset procedure.

6.1.2. Measurement Procedure

F1

1. Select the desired mode using the **F1** key.
2. Connect the black and yellow test leads to **T1** and **T4** input terminals respectively

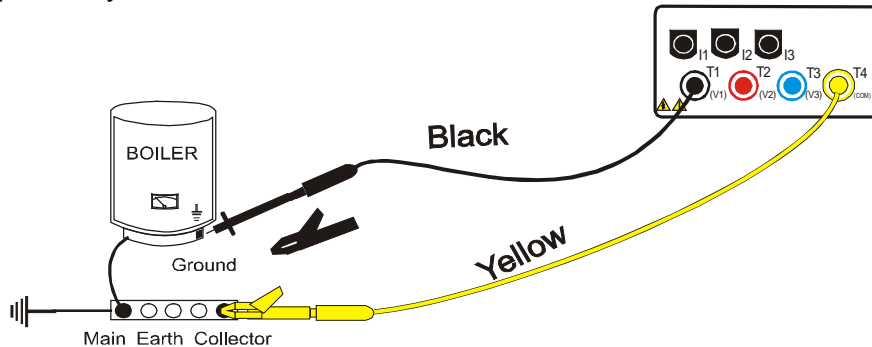

Connection of the test leads during LOWΩ test.

3. If the cables supplied with the instrument are not long enough for the measurement you can extend the black cable.
4. Short-circuit the test leads making sure that the conductive parts of the alligator clips make a good contact to each other. Press the **START** key. **If the display doesn't show 0.00Ω repeat the test leads calibration** (see paragraph 6.1.1).
5. Connect the instrument terminals to the ends of the conductor under test (see previous picture).
6. **If the mode "RT+" or "RT-" was selected use the F3, F4 keys to set the duration of the test.**
7. Press the **START** key. The instrument will execute the measurement. In RT+/RT- (Timer mode) you can press **START** key again if you want to stop the test before the duration set is expired.

F3

F4

START
STOP



ATTENTION

Never disconnect the test leads when the message **"Measuring"** is displayed.

6.1.3. Results of "AUTO" mode

☞ At the end of the test, if the **average resistance value Ravg is lower than 5Ω** the instrument emits a **double sound signal** indicating the **positive outcome of the test** and displays a screen similar to the screen to the right.

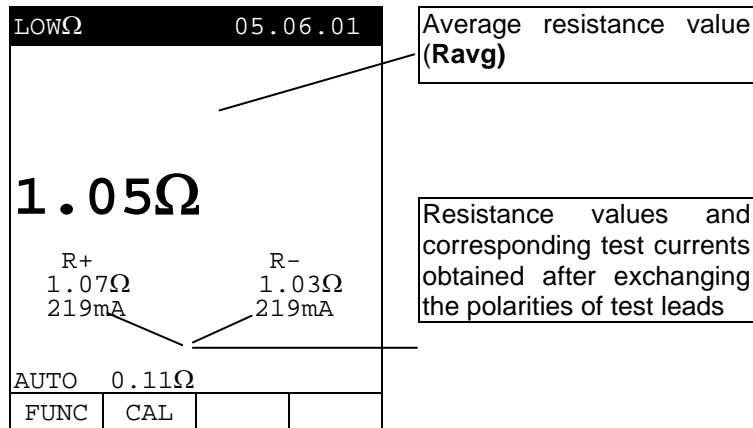

The displayed result can be stored by pressing the **SAVE** key **twice** (refer to paragraph 9.1).

6.1.4. Results of "RT+" and "RT-" modes

☞ If a **resistance value RT+ or RT- lower than 5Ω** is detected, the instrument emits a **double sound signal** indicating the **positive outcome** of the test displays a screen similar to the screen to the right.

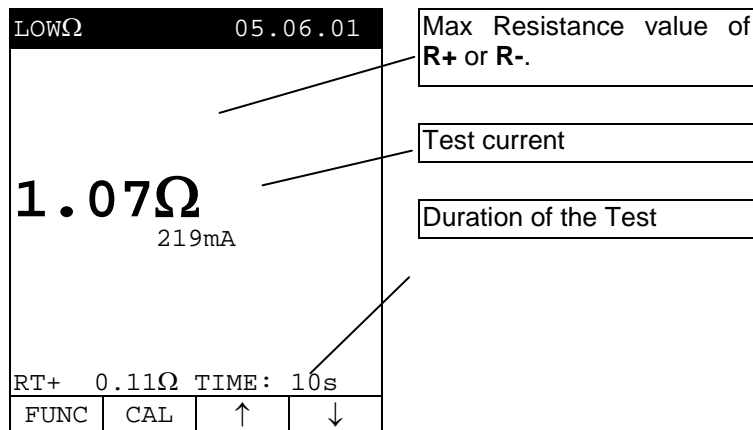

Note: We recommend the use of alligator clips and to assure the alligator clips make good contact with the conductor under test. Indeed, in this test the instrument gives as a final result the maximum measured value of R+ or R- and using test leads instead of alligator clips could give you faulty results due to faulty contact between the test leads and conductor under test



The displayed result can be stored by pressing the **SAVE** key **twice** (refer to paragraph 9.1).

6.1.5. "AUTO", RT+", "RT-" faulty cases

If the instrument detect the External Power supply adapter connected to instrument will show the message displayed to the right.

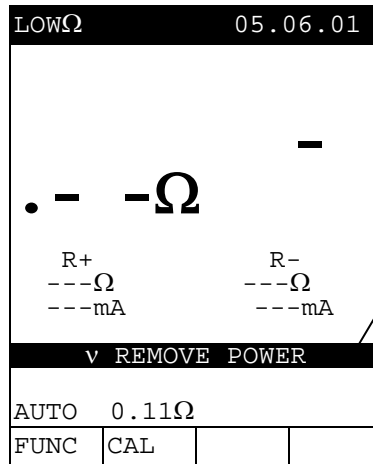

Disconnect the External Power Supply Adapter

If the terminal voltage is higher than 15V, the instrument does not perform the test and displays the screen to the right for 5 seconds.

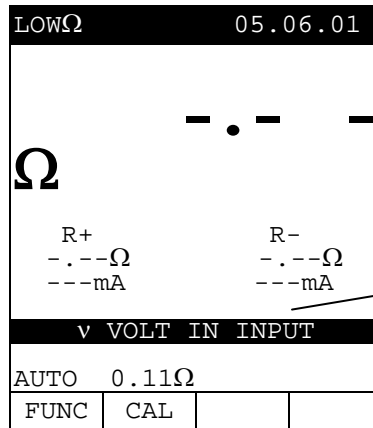

ATTENTION: the test was not performed because of voltage at the terminal ends.

In the case that: $R_{CALIBRATION} > R_{MEASURED}$ the instrument displays the screen to the right.

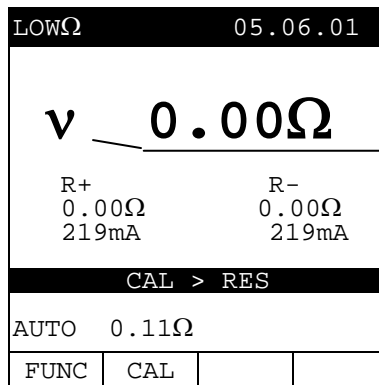

ATTENTION: $R_{CALIBRATION} > R_{MEASURED}$

THE PREVIOUS RESULTS CAN'T BE SAVED.

If the value of **Resistance is higher than 5Ω** (but lower than 99.9Ω) the instrument emits a long beep and displays a screen similar to the screen to the right

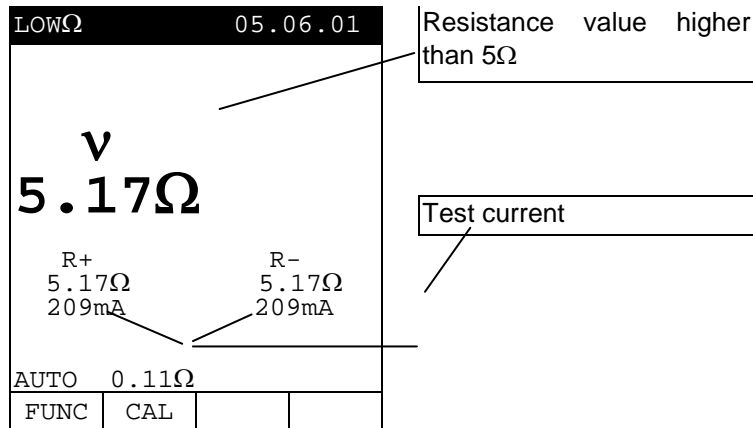

The displayed result can be stored pressing the **SAVE** key **twice** (refer to paragraph 9.1).

If the value of **Resistance is higher than 99.9Ω** the instrument emits a long beep and displays the screen to the right.

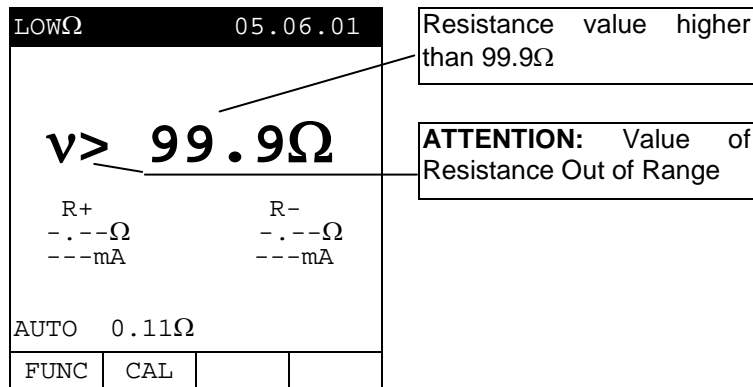

The displayed result can be stored pressing the **SAVE** key **twice** (refer to paragraph 9.1).

6.2. INSULATION TEST: INSULATION RESISTANCE MEASUREMENT

The measurements comply with IEC 61557-2 and VDE 0413 part 1.

ATTENTION



Before performing an insulation test make sure that the circuit under test is not energised and all the loads are disconnected.

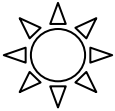

Turn the rotary knob to the **INSULATION TEST** position.

F1

The **F1** key allows the operator to select one of the following measuring modes:

- ☞ **MAN** mode (Manual mode) Recommended test.
- ☞ **TMR** mode (Timer mode: test duration depends on the selected interval from 10 to 999 seconds). This test can be executed when the test required a defined duration.

6.2.1. Measurement Procedure

F1

1. Select the desired mode using the **F1** key.
2. Connect the test leads to the instrument input terminals **T1** and **T4** respectively,

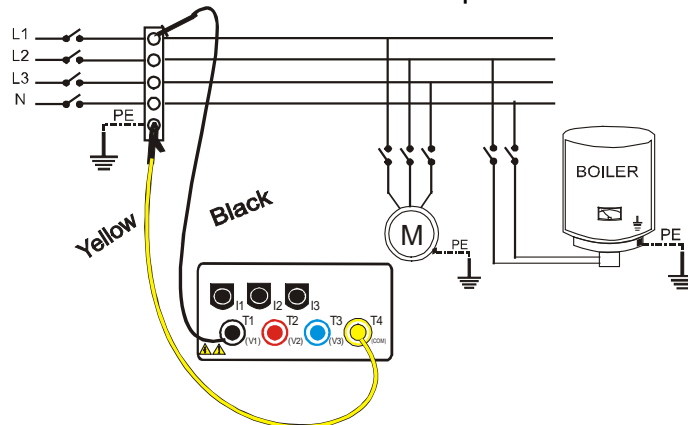

Example: insulation measurement between phase and earth in an electrical installation using untied cables.

3. If the cables supplied with the instrument are not long enough for the measurement you can extend the black cable.
4. Connect the instrument terminals to the object that is to be submitted to the insulation test **after de-energizing the circuit under test and all the relative loads** (see previous picture).

F2

5. By means of **F2** select the test voltage suitable for the type of test to be performed (see Table1). The values to be selected are:
 - 50V (test on telecommunication system)
 - 100V
 - 250V
 - 500V
 - 1000V

Standard	Brief description	Test voltage	Maximum limit value
CEI 64-8/6	Systems SELV or PELV	250VDC	> 0.250MΩ
	Systems up to 500V (Civil installations)	500VDC	> 0.500MΩ
	Systems over 500V	1000VDC	> 1.0MΩ
CEI 64-8/4	Floor and wall insulation in civil installations	500VDC	> 50kΩ (se V<500V)
	Floor and wall insulation in systems over 500V	1000VDC	> 100kΩ (se V>500V)
EN60439	Electrical panel boards 230/400V	500VDC	> 230kΩ
EN60204	Electrical equipment of machines	500VDC	> 1MΩ
CEI 64-4	Floor insulation in medical rooms	500VDC	<1MΩ (if the floor is at least 1 year old) <100MΩ (if the floor is at least 1year old)

Table1: Table reporting the test voltage and the corresponding limit values for few Guidelines.

Rated voltage selected for the test	R _{MAX} = Maximum resistance value
50VDC	99.9MΩ
100VDC	199.9MΩ
250VDC	499MΩ
500VDC	999MΩ
1000VDC	1999MΩ

Table2: Table of maximum resistance values which can be measured under MΩ mode depending on the rated voltage selected.

- F3** 6. If the "TMR" mode was selected use the **F3**, **F4** keys to set the duration time of the test:
- F4**



ATTENTION

Never disconnect the test leads from the circuit under test when the message "**MEASURING**" is being displayed, as the circuit under test may remain charged at a dangerous voltage. The instrument has an internal "safety resistor" which is connect to output terminal before the end of the test in order to discharge the parasite capacities of the installation.



7. Press the **START** key.
- The instrument will start the test.
- ✓ MAN Mode: The test will take 4 seconds (maximum). If you keep the START key pressed longer than 4 seconds the test continues until the key is released.
 - ✓ TMR mode: The test will take the time set. If you want to stop the test when it's running, press the START/STOP key again.

6.2.2. Results of "MAN" mode

☞ At the end of the test if the insulation resistance is **lower than R_{MAX}** (see Table2) and the instrument generates the **Nominal test Voltage**, the instrument emits a **double beep**, indicating the **positive outcome of the test** and displays a screen similar to the screen to the right.

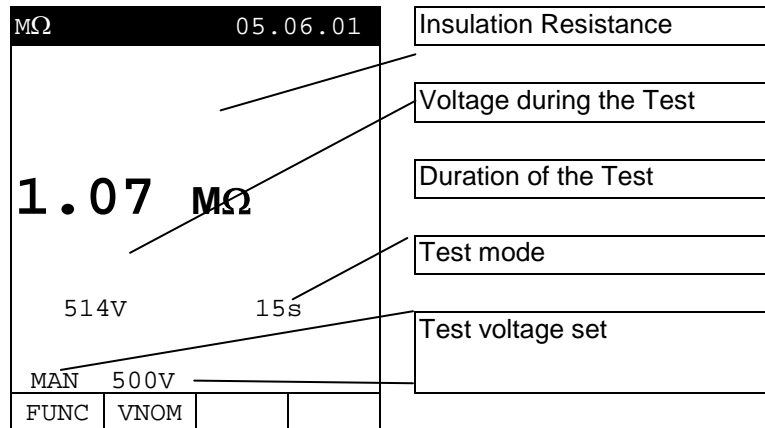

In order to evaluate the test you must compare the result with the limits indicated in the Guidelines (see Table1).

SAVE The displayed result can be stored pressing the **SAVE** key **twice** (according to paragraph 9.1).

☞ If the Insulation resistance is **higher than R_{MAX}** (see Table2), the instrument emits a **double beep** at the end of the test **indicating the positive outcome of the test** and displays one screen similar to the screen to the right.

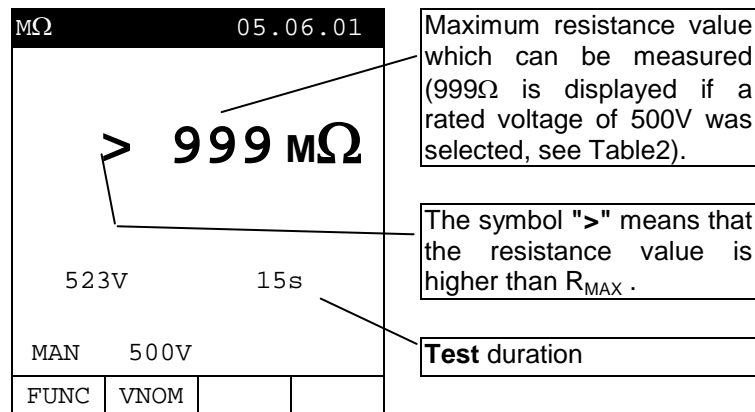

SAVE The displayed result can be stored by pressing the **SAVE** key **twice** (refer to paragraph 9.1).

6.2.3. Results of "TMR" mode

At the end of the test if the Insulation resistance is **lower than R_{MAX}** (see Table2) and the instrument generated the **Nominal test Voltage**, the instrument emits a **double beep** indicating the **positive outcome of the test** and displays a screen similar to the screen to the right.

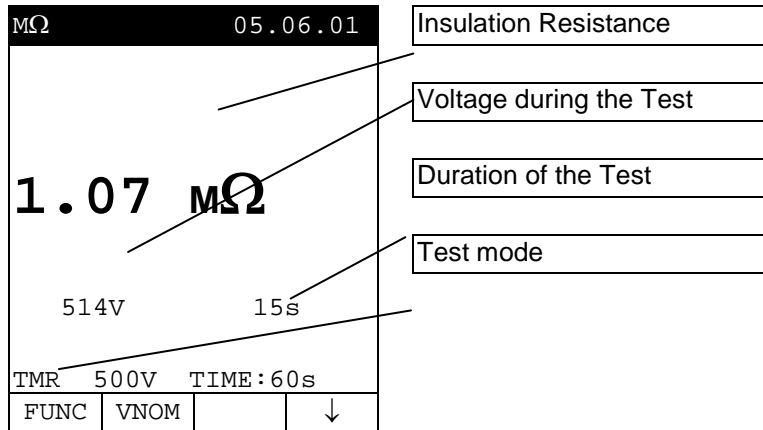

The displayed result can be stored by pressing the **SAVE** key **twice** (according to paragraph 9.1).

If the Insulation resistance is **higher than R_{MAX}** (see Table2), the instrument emits a **double beep** at the end of the test **indicating the positive outcome of the test** and displays a screen similar to the screen to the right.

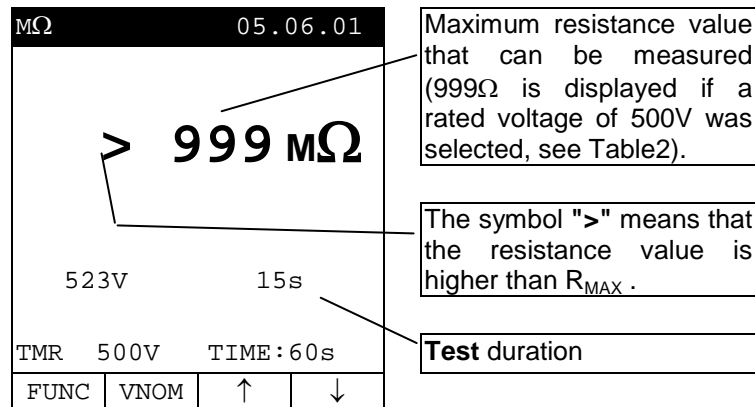

The displayed result can be stored pressing the **SAVE** key **twice** (according to paragraph 9.1).

6.2.4. "MAN" and "TIMER" mode faulty cases

If the instrument detects the External Power supply adapter the instrument will show the message displayed to the right.

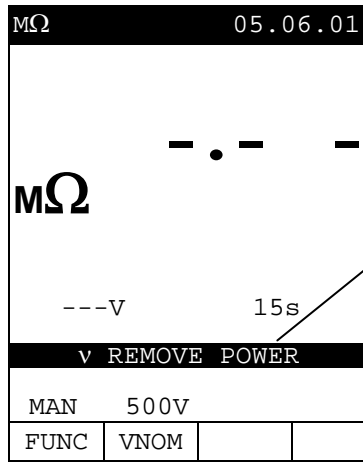

Disconnect the External Power Supply Adapter

If the instrument detects a Voltage between the input terminals higher than 15V, the instrument does not perform the test and displays the screen to the right for 5 seconds.

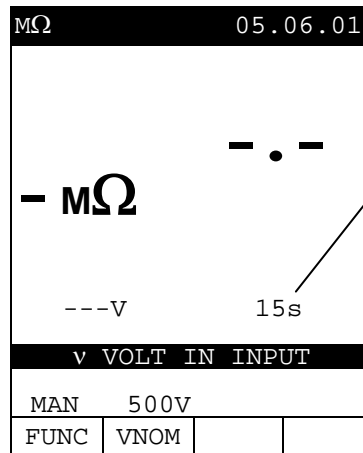

ATTENTION: the test can't be executed. Check that the circuit is not energized.

This result can't be saved

If the instrument can't generate the Nominal Test Voltage it will emit a long beep and displays a screen similar to the screen to the right.

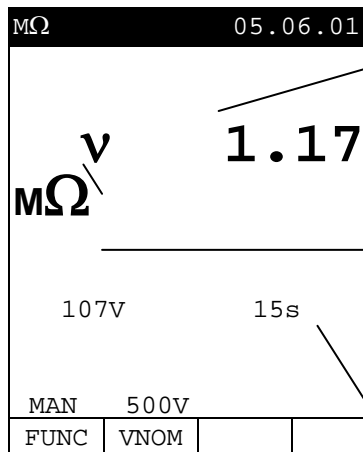

Insulation Resistance

ATTENTION: the test of resistance R_{ISO} was taken at a voltage value lower than the set rated voltage. Low insulation case. This case occurs under low insulation conditions or in the presence of capacitance on the installation.

Test Duration



The displayed result can be stored by pressing the **SAVE** key **twice** (refer to paragraph 9.1).

6.3. PHASE SEQUENCE INDICATOR

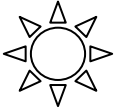

Turn the rotary knob to the position.

6.3.1. Measurement procedure and results of "☺" mode



1. Connect the Black, Red and Blue connectors of the split cables to their corresponding input terminals of the instrument **T1**, **T2**, **T3**.

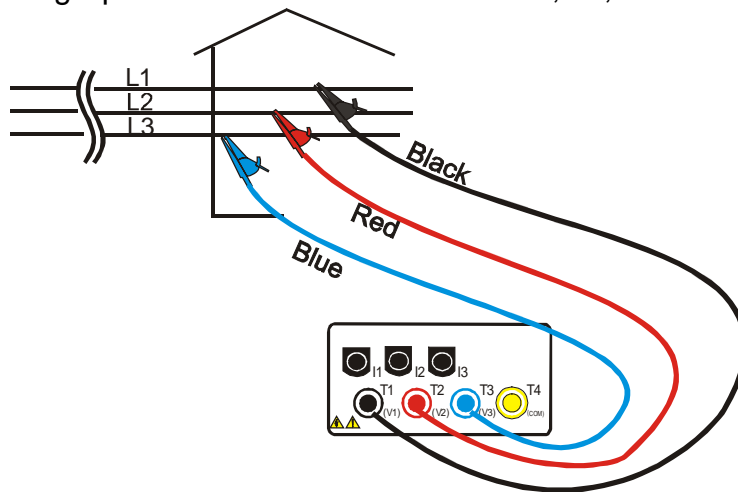

Instrument connection for Phase Sequence Detection in a 400V three-phase system

2. Press the **START** key to execute a test.

At the end of the test the instrument emits a double **beep** indicating that the test has **correctly terminated** and displays the values to the right.

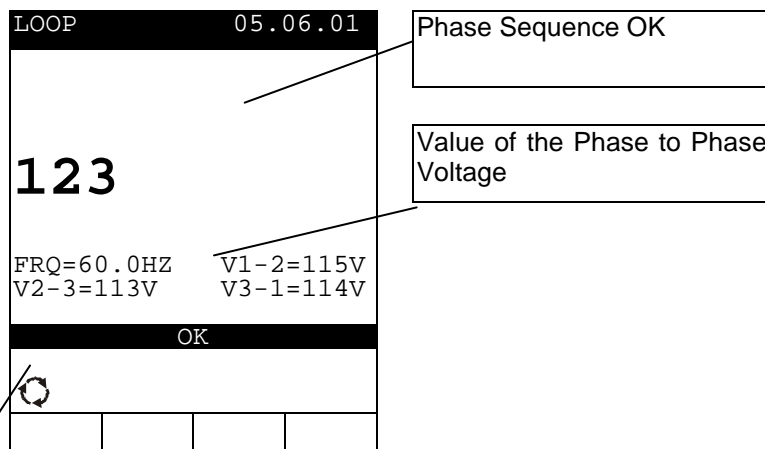

Working mode



This result can be stored pressing the **SAVE** key **twice** (refer to paragraph 9.1).

6.3.2.  Faulty Cases

In the "" mode, if a Phase-to-Phase voltage is lower than 100V, the instrument displays the screen to the right.

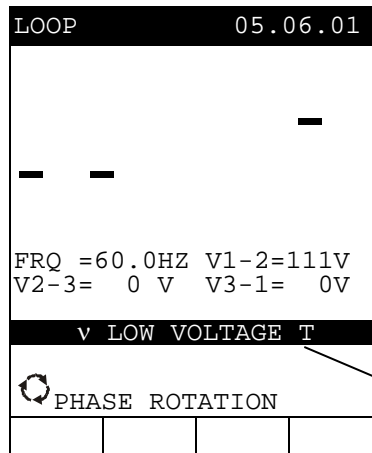

Phase "T2 Voltage is lower than 100V

In the "" mode, if the instrument detects two phases connected together it displays the screen to the right.

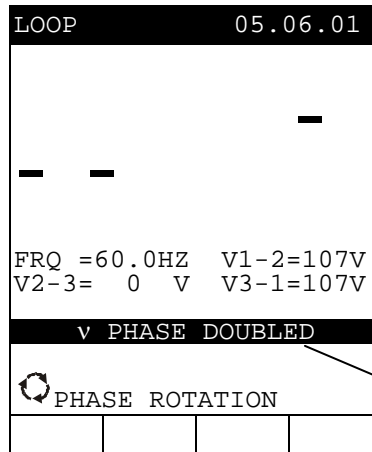

Two phases are connected together.

THE PREVIOUS RESULTS CANNOT BE SAVED.

In the  mode, if the voltage of one or more phase is too low, one or more phases has a low voltage the instrument will show a screen similar to the along side displayed.

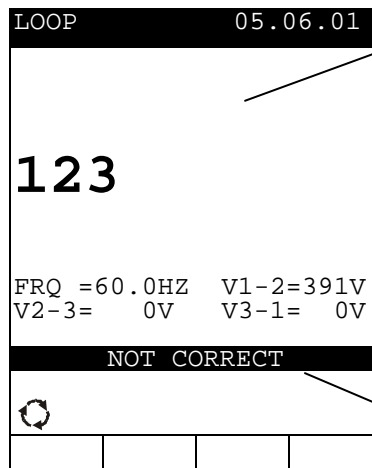

Phase Sequence not correct

Message "LOW Voltage Phase T": means that Phase T has a low voltage value. Similar message for Phase R and S.

This result can be stored pressing the **SAVE** key **twice** (refer to paragraph 9.1).

6.4. GROUND TEST: SOIL RESISTANCE AND RESISTIVITY MEASUREMENTS

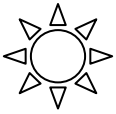

Turn the rotary knob to the **GROUND TEST** position.

F1

The **F1** key permits to select one of the following measuring modes (which can be shown cyclically when pressing the key):

- ☞ Mode "2-W" (the instrument measures the resistance between 2 points).
- ☞ Mode "3-W" (the instrument measures the resistance using two auxiliary earth rods).
- ☞ Mode "ρ" (the instrument measures the ground resistivity).

ATTENTION



Never disconnect the test leads from the circuit under test when the message "**MEASURING**" is displayed

6.4.1. Measurement procedure and results of "2-W" and "3-W" mode

F1

1. Select "2-W" or "3-W" Ground measurement mode by means of the **F1** key.
2. Connect the Black, Red, Blue and Yellow cables to the corresponding input terminals of the instrument **T1**, **T2**, **T3**, **T4** (see possible connections in the following pictures).

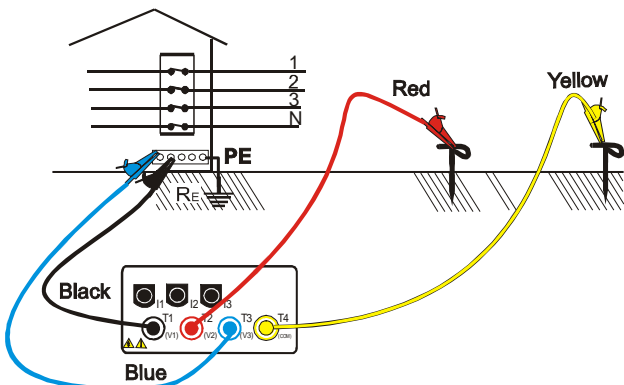

Connection for 3 point Earth resistance measurement

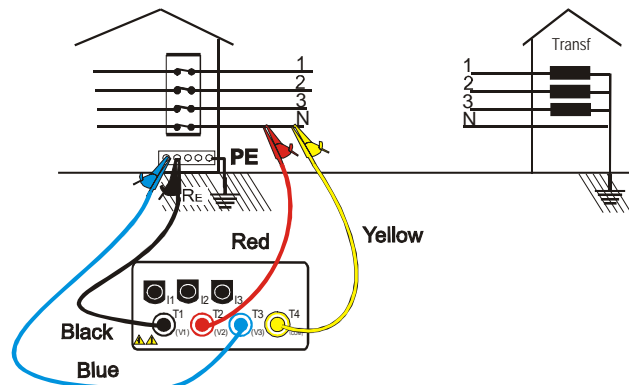

Connection for 2 point Earth Resistance measurement

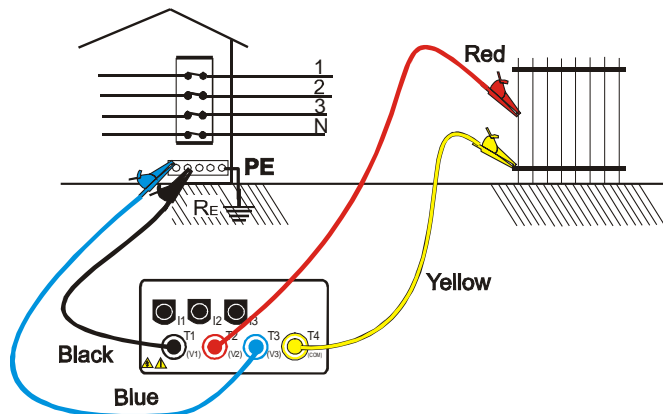

Connection for measuring the resistance between an extraneous conductive part and the earth system



3. Press the **START** key. The instrument starts the test.

☞ At the end of the test the instrument emits a **double beep** indicating that the test is correctly terminated and displays the values to the right.

"3 Point" Working mode

4. The instrument will show automatically the average value of the Ground resistance calculate over the tests performed. Press **F2** to RESET this value and the number of Test.



This result can be stored by pressing the **SAVE** key **twice** (refer to paragraph 9.1).

6.4.2. Measurement procedure and results of "ρ" mode

- F1** 1. Select ρ measurement mode by means of the **F1** key.
- 2. Select the distance **d** between the earth rods by means the **F3** and **F4** keys.
The Distance measuring unit comply with Country setting (see par. 5.4).
- 3. Connect the 4 Black, Red, Blue and Yellow connectors of the single cables in the corresponding input terminals of the instrument **T1, T2, T3, T4**.

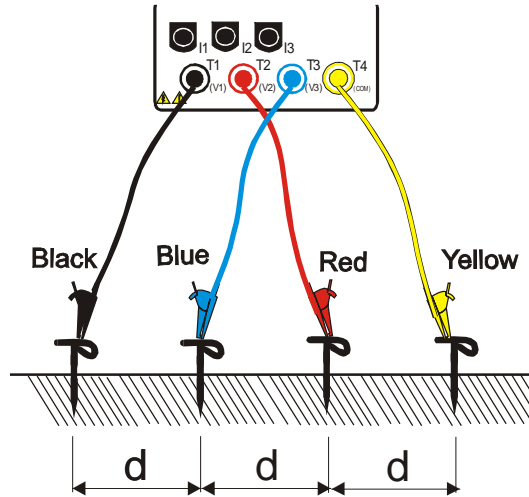

Instrument connection for Earth resistivity measurement



- 4. Press the **START** key. The instrument starts the test.

At the end of the test the instrument emits a **double beep** indicating that the **test is correctly terminated** and displays the values to the right.

EARTH		05.06.01		Ground Resistivity value expressed in Ωm.
1.77 Ωm		vd= 1v		Voltage value of electrical noise
				Number of Test
Test: 04		ρAVG=0.74Ω		Average Value of Ground Resistivity calculated over the Number of Test displayed.
ρ		DIST= 2m		
FUNC	CLR	↑	↓	

"ρ" Working mode

- 5. The instrument will show automatically the Average value of the Ground Resistivity calculate over the tests performed. Press **F2** to RESET this value and the number of Test.



This result can be stored by pressing the **SAVE** key **twice** (refer to paragraph 9.1).

6.4.3. "2-W", "3-W" and "ρ" faulty cases

If the instrument detects the External Power supply adapter connected to instrument will show the message displayed to the right.

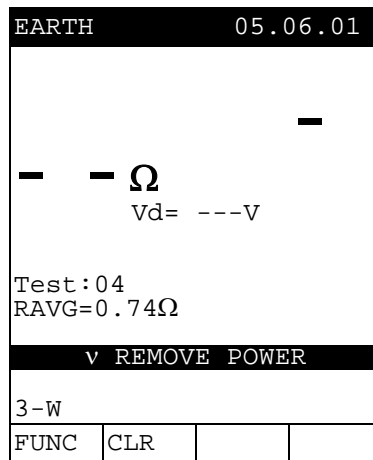

Disconnect the External Power Supply Adapter

If the Instrument detect a voltage values higher than 5V the instrument will shows the screen displayed to the right.

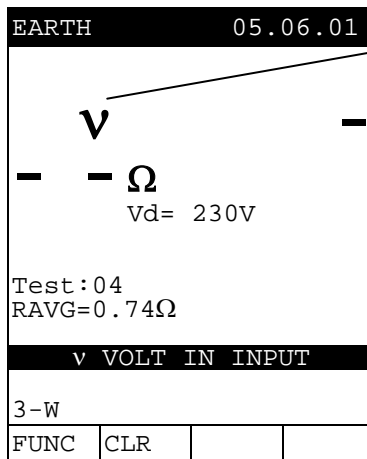

Warning symbol: Voltage noise in input.

The message "Rc high" indicates that the instrument can't produce the minimum current necessary for measurement. Check that the terminals are correctly connected and the Auxiliary earth rod connected to T4 (yellow conductor) has not been inserted in a pebbly or poorly conductive ground. If necessary pour some water around the rod.

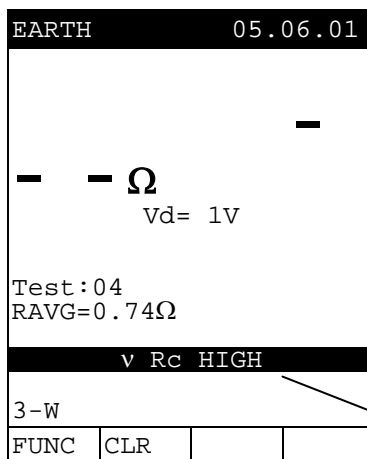

Message "Rc": Check Auxiliary Earth rods.

THE PREVIOUS RESULTS CANNOT BE SAVED.

If the Instrument detects a Resistance value higher than 1999Ω , the instrument will show the screen to the right.

EARTH		05.06.01	
<p>> 1999Ω Vd= 1V</p>			
Test:04 RAVG=0.74 Ω			
3-W			
FUNC	CLR		

Message ">1999" means that the resistance value is higher than the maximum measurable.



This result can be stored pressing the **SAVE** key **twice** (refer to paragraph 9.1).

If the Instrument detects a Resistivity value higher than $1999k\Omega m$, the instrument will show the screen to the right.

EARTH		05.06.01	
<p>> 1999kΩm Vd= 1V</p>			
Test:04 ρ AVG=0.74k Ωm			
ρ		DIST=5m	
FUNC	CLR	↑	↓

Message ">1999" means that the resistivity value is higher than the maximum measurable.



This result can be stored pressing the **SAVE** key **twice** (refer to paragraph 9.1).

7. POWER QUALITY

This function allows the following operations:

- ✓ **display in real time** the electrical parameters of a single phase system or a three phase system (with and without neutral wire) and the harmonic analysis of voltage and current.
- ✓ **conduct a direct Energy measurement** (without memorizing).
- ✓ **memorize** (pressing SAVE key) the sampled values of the Parameters present at instrument input generating a "Smp" record inside instrument memory. **It will be possible to analyse the memorized data ONLY by transferring it to a PC.**
- ✓ **record simultaneously** (pressing the START key after a proper setting): RMS values of voltage, current, corresponding harmonics, active, reactive and apparent powers, power factors and $\cos\phi$, active, reactive and apparent energies, voltage anomalies (voltage sag and surge) with 10ms resolution. **It will be possible to analyse the recorded data ONLY by transferring them to a PC.**

It's fundamental the Instrument settings correspond to the Installation type under test and accessories is use. For this we recommend you to check instrument's setting before execute an ANALYSIS measurement.

Select the **POWER QUALITY** rotary switch position. By pressing the **MENU** key the following screen will be displayed:

MENU GENERAL			
SAFETY TEST MEMORY			
ANALYZER MEMORY			
RESET			
ANALYZER CONFIG			
RECORDER CONFIG			
CONTRAST			
DATE&TIME			
LANGUAGE			
COUNTRY			
↓	↑		

It's not possible to enter the **MENU** during a recording or a Real Time Energy measurement.

Generally to check instrument's settings you must check "ANALYZER CONFIG" and "RECORDER CONFIG" items.

7.1. BASIC SETTING: ANALYZER CONFIG

Place the rotary switch in the **POWER QUALITY** position, press the **MENU** key, using the **F1/F2** keys select the **ANALYZER CONFIG** item and press the **ENTER** Key.

The following page will be displayed:

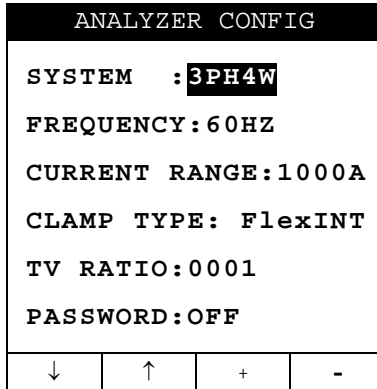

This page of setting can be confirmed by pressing the **ENTER** key or cancelled by pressing the **ESC** key.

7.1.1. Type of electrical system under test

This parameter allows to select the type of electrical system under test among the following configurations:

- ✓ **SINGLE:** single-phase system
- ✓ **3PH3W:** 3-wire system (three-phase system without neutral)
- ✓ **3PH4W:** 4-wire system (three-phase system with neutral)

The connections to the instrument inputs will have to comply with the selected type of system.

Position the cursor on the corresponding word by pressing the multifunction keys **F1** and **F2** and set the desired value by pressing the multifunction keys **F3** and **F4**.

7.1.2. How to set the fundamental frequency

Position the cursor on the corresponding word by pressing the multifunction keys **F1** and **F2** and select the network frequency between the possible values **50Hz** and **60Hz** by pressing the multifunction keys **F3** and **F4**. This parameter is important **ONLY** if the input voltage is not sufficient to recognise the value of the frequency (for example, only the clamps for the current measurement are connected). In this case the instrument generates an internal synchronism equal to the value of the set frequency.

7.1.3. How to set the Clamp Type

The value of this parameter **must be always equal to the type of clamp being used.**

Three types of clamps are available:

- ✓ STD: STANDARD clamps or current transformers
- ✓ FlexEXT: FLEXIBLE clamps with EXTERNAL power supply.
- ✓ FlexINT: FLEXIBLE clamps **AM-Flex33** (coils directly connected to the instrument inputs). These clamps allow 1000A and 3000A range.

Set the desired value by pressing the multifunction keys **F3** and **F4**.

7.1.4. How to set the current range

Position the cursor on the corresponding word by pressing the multifunction keys **F1** and **F2** and set the desired value by pressing the multifunction keys **F3** and **F4**.

For STD and FlexEXT the value of this parameter **must be always equal to the full scale of the current clamp** used to take the measurement. In case multi-scale clamp is used, the value of this parameter must be equal to the scale selected on the clamp.

For FlexINT (**AM-Flex33**) only two ranges are available: 1000A and 3000A.

7.1.5. How to set the value of the transformer voltage ratio (TV RATIO)

The instrument can also be interfaced with step-down transformers in the equipment under test: it can display the value of the voltages present on the primary winding of these transformers. To do this it will be necessary to set the value of the transformers' windings ratio from 2:1 to 3000:1. The default is set at 1:1 for measurements of none transformer systems.

Select "TV RATIO" in the ANALYZER CONFIG menu. Set the desired value by pressing the multifunction keys **F3** and **F4**.

7.1.6. How to enable/disable the password

The instrument is provided with a protective routine to avoid the risk of being disturbed or interrupted during a recording or an energy measurement. Once a recording or a direct energy measurement has been started (with the option "PASSWORD" enabled), after about 3 minutes from the last key pressure or switch rotation it won't be possible to press START/STOP to stop the recording, "PASSWORD" will be displayed and it will be necessary to insert the password.

In order to insert the password (which is not changeable), press the multifunction keys in the following sequence (within 10 seconds):

F1, F4, F3, F2

If you wait more than about 10 seconds the display will return to the meter mode and the instrument will continue recording. If you insert a wrong password the message "Password error" will be displayed under "PASSWORD". After a few seconds the display will return to meter mode and the instrument will continue recording. In order to enable/disable this option the correct password will have to be entered. The display will return to meter mode and START/STOP will have to be pressed again to stop the recording. You will then need to re-enter the "ANALYZER CONFIG" menu and scroll up or down to the item "PASSWORD: ON" using the multifunction keys **F1** and **F2**. Then turn the password off by pressing the multifunction keys **F3** and **F4**.

7.2. BASIC SETTING: RECORDER CONFIG

Place the rotary switch in the **POWER QUALITY** position, press the **MENU** key, using the **F1/F2** keys select the **RECORDER CONFIG** item and press the **ENTER** Key.

This option allows you to check and eventually modify the recording parameters and the selected parameters (up to a maximum of 62+Frequency). If the number of selected values exceeds 63 the message "**too many param**" will be displayed. The RECORDER CONFIG mode is divided into 4 separate sub-pages:

- ✓ 1st page: This page allows you to set the START/ STOP mode (AUTO or MANUAL), the START and STOP time if AUTO mode is selected, the Integration Period value, the Enabling/Disabling of Voltage Anomalies detection, the Enabling/Disabling of Harmonics detection. Press **ENTER** to confirm the settings and pass to the following page.
Press **ESC** to leave the Menu without modifying the existing parameters.
- ✓ 2nd page: This page is devoted to the settings relevant to the **VOLTAGE** recording. Press **ENTER** to confirm the settings and pass to the following page.
Press **ESC** to leave this page without modifying the existing parameters.
From this page you can enter the sub-page "Harmonics" which permits to select the voltage harmonics to be recorded.
Press **ENTER** to confirm the settings and leave the "Menu Harmonics".
Press **ESC** to leave the "Menu Harmonics" without modifying the existing parameters.
- ✓ 3rd page: This page is devoted to the settings relevant to the **CURRENT** recording. Press **ENTER** to confirm the settings and pass to the following page.
Press **ESC** to leave this page without modifying the existing parameters.
From this page you can enter the sub-page "Harmonics" which permits to select the current harmonics to be recorded.
Press **ENTER** to confirm the settings and leave the "Menu Harmonics".
Press **ESC** to leave the "Menu Harmonics" without modifying the existing parameters.
- ✓ 4th page: Menu composed of two sub-pages devoted to the selection of the **POWERS and ENERGIES** to be recorded. From this page you can enter the sub-page "POWER" and "ENERGY" which permits to select the parameters to be recorded.
Selecting the active powers for the recording, the corresponding active energies will be automatically selected.
Selecting the reactive powers for the recording, the corresponding reactive energies will be selected.
Press **ENTER** to leave this page confirming the modifications made.
Press **ESC** to leave the "Menu" without modifying the existing parameters.

The various pages of the "**RECORDER CONFIG**" can be schematised as follows:

MENU

RECORDER CONFIG

START
MANU

STOP
MANU

INT. PERIOD: 15min
HARM REC: ON
ANOM REC: ON

↓ ↑ + -

1st Page of the RECORDER CONFIG MENU

To Select **MANUAL** or **AUTOMATIC** start/stop mode, place the cursor on **MANU** or **AUTO** using the multifunction key **F1** or **F2** and select the desired mode using **F3** or **F4**.

Use the multifunction keys **F1**, **F2** to position the cursor on the desired word and use the multifunction keys **F3** / **F4** to modify the value.

Press **ENTER** to confirm this page and proceed inside the Menu keeping the settings made.

Press **ESC** to leave this page without modifying the existing parameters.

ENTER

RECORDER CONFIG

VOLTAGE:
V1 V2 V3

V12 V23 V31

HARM. REC:Pg (ON)

Vref P-N: 110V
LIM+: 06% (116.6V)
LIM-: 10% (99.0V)

↓ ↑ + -

Example of 2nd page with ANOM flag enabled

Use the multifunction keys **F1**, **F2** to position the cursor on the desired symbol and use the multifunction keys **F3** / **F4** to select / deselect the desired parameter (it's selected if marked in black). Press **ENTER** to confirm and leave the Menu keeping the settings made.

Press **ESC** to leave this page without modifying the existing parameters.

If you want to change Voltage Harm. Selection place the cursor on the corresponding "Pg" symbol then Press **F3**

ENTER

RECORDER CONFIG

VOLTAGE HARMONICS

	Thd	DC	01	02	03	04
05	06	07	08	09	10	11
12	13	14	15	16	17	18
19	20	21	22	23	24	25
26	27	28	29	30	31	32
33	34	35	36	37	38	39
40	41	42	43	44	45	46
47	48	49				

↓ ↑ + -

Example of sub-page "VOLTAGE HARMONICS"

Use the multifunction keys **F1**, **F2** to position the cursor on the desired voltage harmonic and use the multifunction keys **F3** / **F4** to select / deselect (it's selected if highlighted in black).

Press **ENTER** to confirm this page.

Press **ESC** to leave the Menu without modifying the existing settings.

The instrument will record the values of the selected harmonics corresponding to the voltages selected in one of the two pages of the Menu previously illustrated.

From 2nd page
of RECORDER CONFIG MENU

ENTER

RECORDER CONFIG

CURRENT:

I1 I2 I3 IN

HARM. REC: Pg (ON)

↓ ↑ + -

Use the multifunction keys F1, F2 to position the cursor on the desired word and use the multifunction keys F3 / F4 to modify the value or select / deselect the desired parameter (it's selected if marked in black). Press ENTER to confirm. Press ESC to leave the Menu without modifying the existing settings.

Example of 3rd page

If you want to change Current Harm. Selection place Cursor on the corresponding "Pg" symbol then Press F3

ENTER

RECORDER CONFIG

CURRENT HARMONICS

	Thd	DC	01	02	03	04
05	06	07	08	09	10	11
12	13	14	15	16	17	18
19	20	21	22	23	24	25
26	27	28	29	30	31	32
33	34	35	36	37	38	39
40	41	42	43	44	45	46
47	48	49				

↓ ↑ + -

Use the multifunction keys F1, F2 to position the cursor on the desired current harmonic and use the multifunction keys F3 / F4 to select / deselect (it's selected if marked in black). Press ENTER to confirm this page. Press ESC to leave this page without modifying the existing settings. The instrument will record the values of the selected harmonics corresponding to the currents selected in one of the two pages of the Menu previously illustrated.

Example of sub-page
"CURRENT HARMONICS"

From 3rd page
of RECORDER CONFIG MENU

ENTER

```

RECORDER CONFIG
CO-GENERATION : ON
POWER : Pg
ENERGY : Pg
    
```

Example of 4th page

ENTER

In order to select the POWER to be recorded use the multifunction keys F1, F2 to position the cursor on the corresponding "Pg" Symbol and then press F3

```

RECORDER CONFIG
Pt  P1  P2  P3
Qti Q1i Q2i Q3i
Qtc Q1c Q2c Q3c
St  S1  S2  S3
Pft Pf1 Pf2 Pf3
dPft dPf1 dPf2 dPf3
    
```

Example of POWER sub-page

Selecting the active powers for the recording, the corresponding active energies will be automatically selected.
 Selecting the reactive powers for the recording, the corresponding reactive energies will be selected.

From 3rd page
of RECORDER CONFIG MENU

ENTER

```

RECORDER CONFIG
CO-GENERATION : ON
POWER : Pg
ENERGY : Pg
    
```

Example of 4th page

In order to select the ENERGIES to be recorded use the multifunction keys F1, F2 to position the cursor on the corresponding "Pg" Symbol and then press F3

ENTER

```

RECORDER CONFIG
Eat Ea1 Ea2 Ea3
Erit Eri1 Eri2 Eri3
Erct Erc1 Erc2 Erc3
Est Es1 Es2 Es3
    
```

Example of ENERGY sub-page
in single-phase mode

Selecting/deselecting the active energies for the recording, the corresponding active powers will be automatically selected/deselected.

Selecting/deselecting the reactive energies for the recording, the corresponding reactive powers will be selected/deselected

Selecting/deselecting the reactive energies for the recording, the corresponding reactive powers will be selected/deselected.

Symbols	Description	Advised settings
START:MAN	The recording of all the selected parameters will start at 00 seconds after pressing START/STOP (see paragraph 10).	☺
STOP:MAN	The recording of all the selected parameters will be interrupted manually by pressing START/STOP (see paragraph 10).	☺
START:AUTO STOP:AUTO	The recording of all the selected values will be started / interrupted at the set dates and times. In order to start the recording the user will have to press START/STOP to set the instrument in Stand-by mode until the start date and time previously set (see paragraph 10).	
INT. PERIOD	The value of this parameter determines how many seconds the values of all the selected parameters will be memorized. Available choices: 5sec, 10sec, 30sec, 1min, 2min 5min, 10min, 15min, 60min.	15min ☺
HARM REC.	ON = the instrument will record the values of the selected voltage and current harmonics corresponding to the voltages and currents selected in the corresponding pages "Voltage" and "Current". Example: If the following Parameters are selected: a) Phase Voltage 1 and 2, Thd, Harmonics 1,3,5. b) Phase Current 2 and 3, Thd, Harmonics 3,5,7. The instrument will record: a) The Phase Voltage 1 and 2, Thd and Harmonics 1,3,5 of the Phase Voltage 1 and 2 while it will not record anything about Phase Voltage 3 b) The Phase Current 2 and 3, Thd and Harmonics 3,5,7 of the Phase Current 2 and 3 while it will not record nothing about Phase Current 1	☺
	OFF = the instrument will not record any voltage or current harmonic selected	
ANOM REC.	ON = the Instrument will record Voltage Sag and Surge (see paragraph 16.6)	☺
	OFF = the instrument will not record any voltage Sag and Surge	
V1, V2, V3 V12, V23 or V32, V31	RMS value of the voltage of phase 1, phase 2, phase 3 respectively, values of the phase-to-phase voltages 1-2, 2-3 or 3-2 and 3-1.	☺ Single phase: V1 3 wires V₁₂ V₃₂ V₃₁ 4 wires V₁, V₂, V₃
Thd, DC, 01...49	Voltage Total Harmonic Distortion, DC Component, 01..49 Harmonics respectively	☺ Thd,01,03,05,07
Vref (only if ANOM. REC flag has been set ON)	RMS reference value for Voltage used in Voltage Anomalies detection (Voltage Sag and Surge). The Reference is: a) Voltage Phase to Neutral for Single Phase and 4 wires three phase system b) Voltage Phase to Phase for 3 wires three phase system	☺ Single phase: 110V 3 wires: 480V 4 wires 277V
LIM+, LIM- (only if ANOM. REC flag has been set ON)	High and Low Voltage Percent threshold used in Voltage Anomalies detection (Voltage Sag and Surge). Example: Three Phase System 4 wires. Vref = 110, LIM+= 6%, LIM-=10% => High Lim = 121.0V, Low Lim = 99.0V The Instrument will detect a voltage Anomalies if the RMS Voltage Values (calculated every 10ms) beyond the above calculated thresholds (see paragraph 16.6).	☺ +6% / -10%
I1, I2, I3, IN	RMS value of the current of phase 1, phase 2, phase 3 and of the neutral respectively.	☺ Single phase: I1 3 wires: I1, I2, I3 4 wires I1, I2, I3, IN
Thd, DC, 01..49	Current Total Harmonic Distortion, DC Component, 01..49 Harmonics respectively	☺ Thd,01,03,05,07

CO-GENERATION	ON = the instrument is able to face situations of CO-GENERATION of electrical equipment (that is, the equipment under test is able to generate energy besides absorbing it). Accordingly, the instrument will record the powers and energies both absorbed and generated (see paragraph 16.8.1). If this flag is enabled the maximum number of parameters which can be selected decrease to 38.	
	OFF = the instrument will record ONLY the powers and energies absorbed.	☺
Pt, P1, P2, P3, P12, P32	Values of the active power (total, of phase1, phase2 and phase3) (only for 3 wires measurement) value of the power measured by the Wattmeter 1-2 and 3-2 respectively	☺ Single phase: P1 3 wires: Pt 4 wires Pt, P1, P2, P3
Qti, Q1i, Q2i, Q3i, Q12i, Q32i	Values of the inductive reactive power (total, of phase 1, phase 2, phase 3) (only for 3 wires measurement) value of the reactive inductive power measured by the VAR meters 1-2 and 3-2 respectively	☺ Single phase: Q1i Q1c 3 wires: Qti Qtc 4 wires Qti Q1i Q2i, Q3i
Qtc, Q1c, Q2c, Q3c, Q12c, Q32c	Values of the capacitive reactive power (total, of phase 1, phase 2, phase 3) (only for 3 wires measurement) value of the reactive capacitive power measured by the VA meters 1-2 and 3-2 respectively	Qtc Q1c Q2c, Q3c
St, S1, S2, S3, S12, S32	Values of the apparent power (total, of phase1, phase2, phase3) (only for 3 wires measurement) value of the power measured by the VA meters 1-2 and 3-2 respectively	☺ Single phase: S1 3 wires: St 4 wires St, S1, S2, S3
Pft, Pf1, Pf2, Pf3	Values of the power factors (total, of phase 1, phase 2 and phase 3 respectively)	☺ Single phase: Pf1 dPf1 3w: Pft dPft 4w: Pft Pf1 Pf2 Pf3 dPft dPf1 dPf2 dPf3
dpft, dpf1, dpf2, dpf3	Values of the $\cos\varphi$ (total, of phase 1, phase 2 and phase 3 respectively)	
Eat, Ea1, Ea2, Ea3	Values of the active energy (total, of phase1, phase2 and phase3)	☺ Single phase: Ea1 3 wires: Eat 4 wires Eat Ea1 Ea2 Ea3
Erit, Eri1, Eri2, Eri3	Values of the inductive reactive energy (total, of phase 1, phase 2 and phase 3)	☺ Single phase: Eri1 Erc1
Erct, Erc1, Erc2, Erc3	Values of the capacitive reactive energy (total, of phase 1, phase 2, phase 3)	3 wires: Erit Erct 4 wires Erit Eri1 Eri2 Eri3 Erct Erc1 Erc2 Erc3
Est, Es1, Es2, Es3	Values of the Apparent Energy (total, of phase1, phase2 and phase3)	☺ Single phase: Es1 3 wires: Est 4 wires Est Es1 Es2 Es3

The value of the network frequency is automatically selected if at least one phase voltage (for the single-phase mode or the 4 wires three phase mode) or at least one phase-to-phase voltage (for the 3 wires three phase mode) is selected.

The symbols "i" and "c" stand for reactive powers (Q), power factors (Pf) and $\cos\varphi$ (dpf) inductive and capacitive respectively.

Selecting a power factor (Pf) or a $\cos\varphi$ (dPf) for the recording automatically their inductive value and their capacitive value will be recorded separately.

For eventual messages displayed see appendix 1 – MESSAGES DISPLAYED.

7.3. POWER QUALITY FUNCTIONS

F3 ☞ For a simple usage, the main working mode of the POWER QUALITY function can be selected by means of **F3** and **F4**.

F4

- ☞ "**VOLTAGE**" function: to be used to display **voltages and corresponding harmonics** (see paragraph 7.4)
- ☞ "**CURRENT**" function: to be used to display **currents and corresponding harmonics** (see paragraph 7.5)
- ☞ "**POWER**" function: it permits to display **all the parameters measurable by the instrument**: voltages, currents, active, reactive and apparent powers, power factors, $\cos\varphi$ and energies (see paragraph 7.6)
- ☞ "**ENERGY**" function: to be used to display **active, reactive and apparent power, power factor, $\cos\varphi$ and energy** (see paragraph 7.7)

More practically, we may schematise the right procedure of use the **POWER QUALITY** function as follows:

1. Check and eventually modify the "ANALYZER CONFIG" settings of the instrument
2. Using **F3** and **F4**, select the type of measurement to be taken
3. Connect the instrument to the electrical system to be tested
4. Evaluate the values of the parameters under test
5. If you want to record:
 - a) Decide what to record
 - b) Press **MENU** and check if the "RECORDER CONFIG" settings meet your requirements
6. Connect the External Power Supply adapter.
7. Start the recording by pressing START/STOP.

7.4. "VOLTAGE" FUNCTION

This function permits to display in real time the RMS value of AC/DC voltage, the peak and Thd values of the 3 phase voltages, the waveform and the harmonic spectrum of the 3 phase voltages.

7.4.1. Symbols

The VOLTAGE position has three working modes:

- ✓ METER
- ✓ WAVE
- ✓ HARM

These modes will be described in detail in the next paragraphs. The used symbols are described below:

Symbol	Description
V1, V2, V3	RMS value of voltage (phase 1, phase 2, phase 3 respectively)
V12, V23 or V32, V31	RMS value of phase to phase voltage
Vpk1, Vpk2, Vpk3, Vpk12, Vpk32	peak value of voltage (phase 1, phase 2, phase 3 and phase-to-phase voltage 12 and 32 respectively)
h01 ÷ h49	Harmonic 01 ÷ Harmonic 49
ThdV	Factor of total harmonic distortion of voltage
freq	Network frequency
Phseq	Phase sequence indicator "123" → correct "132" → inverted "023" → null voltage on black wire "103" → null voltage on red wire "120" → null voltage on blue wire "100" → null voltages on red and blue wires "020" → null voltages on black and blue wires "003" → null voltages on black and red wires

Tab. 1: Symbols used in **VOLTAGE** function

7.4.2. "METER" mode

By selecting this function the instrument selects automatically the METER mode corresponding to one of the screens below according to the settings made as per paragraph 7.1.

27.09.00 17:35:12			
SINGLE PHASE VOLTAGE			
V1	=	230.2	V
Vpk1	=	325.5	V
ThdV	=	0.0	%
freq	=	50.0	Hz
HARM.	WAVE	PG-	PG+

Example of screen in single-phase mode

27.09.00 17:35:12			
VOLTAGE			
V12	=	384.2	V
V32	=	385.4	V
V31	=	383.7	V
freq	=	50.0	Hz
HARM.	WAVE	PG-	PG+

Example of screen in "3-wire" three-phase mode

27.09.00 17:35:12			
VOLTAGE			
V1	=	230.2	V
V2	=	230.5	V
V3	=	230.6	V
V12	=	384.2	V
V23	=	385.4	V
V31	=	383.7	V
freq	=	50.0	Hz
Phseq	=	123	
HARM.	WAVE	PG-	PG+

Example of screen in "4-wire" three-phase mode

The symbols used are described in Tab. 1.

For eventual messages displayed see appendix 1 – MESSAGES DISPLAYED.

Following keys are active:

- ☞ **F1:** to pass to "HARMONIC" mode (see paragraph 7.4.3)
- ☞ **F2:** to pass to "WAVE" mode (see paragraph 7.4.4)
- ☞ **F3/F4:** to pass to previous/next function respectively
- ☞ **SAVE:** to save in the instrument memory a record of "Smp" type containing the instantaneous values of voltage and current present at the instrument inputs. This function is disabled during a recording
- ☞ **ENTER/HOLD:** to enable/disable the HOLD function (updating interruption) of displayed data. All previous functions remain however available. When the HOLD function is activated, the word **HOLD** is displayed. When this function is enabled it's not possible to record nor perform energy measurements. This function is disabled during a recording or an energy measurement
- ☞ **MENU:** to enter the **MENU** mode and change the instrument settings (see paragraph 7.1 and 7.2). It's not possible to enter the configuration MENU during a recording or an energy measurement
- ☞ **START/STOP:** to record **selected parameters** according to the instrument's settings

7.4.3. "HARM" mode

By selecting the HARM mode one of the screens below will be displayed according to the settings made. The screens show the harmonics of the phase or phase-to-phase voltage.

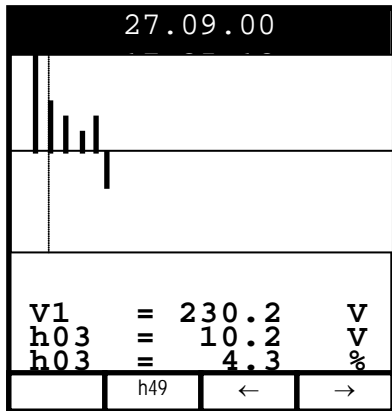

Example of screen in single-phase system

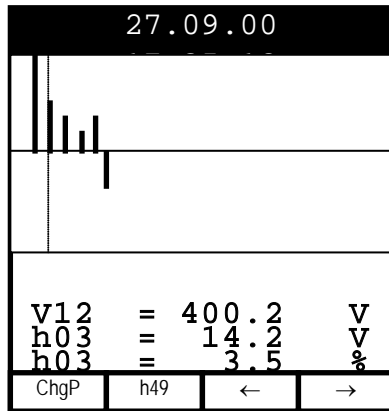

Example of screen in "3-wire" three-phase system

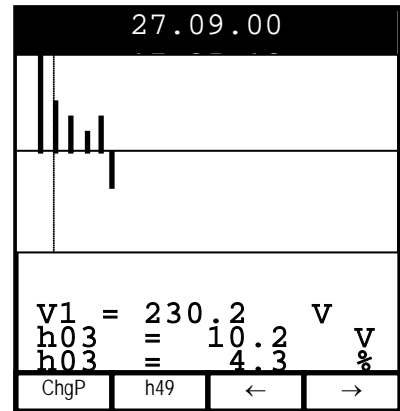

Example of screen in "4-wire" three-phase system

The symbols used are described in Tab. 1.

For eventual messages displayed see appendix 1 – MESSAGES DISPLAYED.

The displayed histograms represent the harmonic content of the voltage under test. The value of the first harmonic h01 (fundamental at 50Hz) is not represented in scale along with the other harmonics in order to maximize the display of the latter. In case both voltage and current are connected to the instrument inputs, eventual negative values of harmonics (therefore represented under the horizontal axis), indicate that such voltage harmonics are "generated" by the load.

Following keys are active:

- ☞ **F3, F4:** to move the cursor of the selected harmonic leftwards and rightwards respectively. At the same time the values related to the order no. of the selected harmonic and to the corresponding absolute and relative values (calculated on the basis of the fundamental) are updated
- ☞ **F1** (only for three-phase mode): to display the values of the harmonics of the other voltages available. The voltage displayed is indicated above the F3 key
- ☞ **F2:** to display the page of the harmonics h01 ÷ h24 (symbol **h24**) or the page of the harmonics h25 ÷ h49 (symbol **h49**)
- ☞ **ESC:** to return back to METER mode (see paragraph 7.4.2)
- ☞ **SAVE:** to save in the instrument memory a record of "Smp" type and the instantaneous values of voltage and current present at the instrument inputs. This function is disabled during a recording
- ☞ **ENTER/HOLD:** to enable/disable the HOLD function (updating interruption) of displayed data. All previous functions remain however available. When the HOLD function is activated, the word **HOLD** is displayed. When this function is enabled it's not possible to record nor perform energy

measurements. This function is disabled during a recording or an energy measurement

- ☞ **MENU:** to enter the **MENU** mode and change the instrument settings (see paragraph 7.1 and 7.2). It's not possible to enter the configuration MENU during a recording or an energy measurement
- ☞ **START/STOP:** to record **selected parameters** according to the instrument's settings

7.4.4. "WAVE" mode

By selecting the WAVE mode one of the screens below will be displayed according to the settings made as per paragraph 7.1. The screens show the waveform of the phase or phase-to-phase voltage.

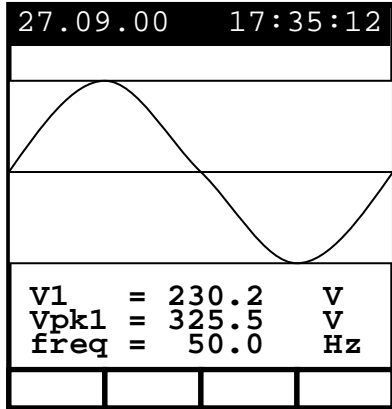

Example of screen in single-phase system

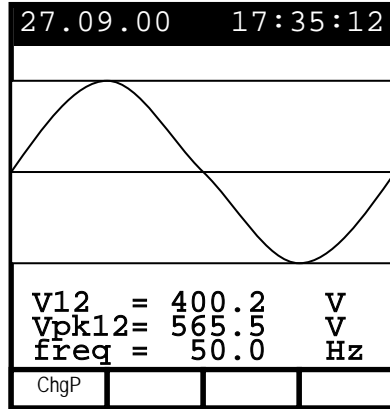

Example of screen in "3-wire" three-phase system

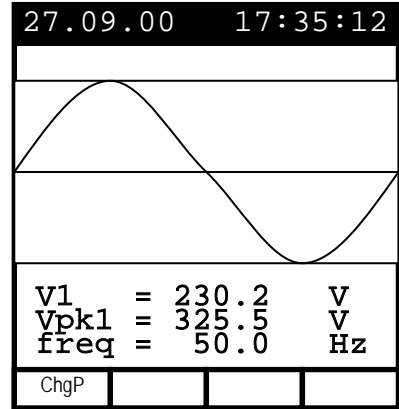

Example of screen in "4-wire" three-phase system

The symbols used are described in Tab. 1.

For eventual messages displayed see appendix 1 – MESSAGES DISPLAYED.

Following keys are active:

- ☞ **F1:** (only for three-phase mode): to display the values corresponding to the following phase
- ☞ **ESC:** to return back to METER mode (see paragraph 7.4.2)
- ☞ **SAVE:** to save in the instrument memory a record of "Smp" type containing the instantaneous values of voltage and current present at the instrument inputs. This function is disabled during a recording
- ☞ **ENTER/HOLD:** to enable/disable the HOLD function (updating interruption) of displayed data. All previous functions remain however available. When the HOLD function is activated, the word **HOLD** is displayed. When this function is enabled it's not possible to record nor perform energy measurements. This function is disabled during a recording or an energy measurement
- ☞ **MENU:** to enter the **MENU** mode and change the instrument settings (see paragraph 7.1 and 7.2). It's not possible to enter the configuration MENU during a recording or an energy measurement
- ☞ **START/STOP:** to record **selected parameters** according to the instrument's settings

7.5. "CURRENT" FUNCTION

This function permits to display in real time the RMS value of AC/DC currents, the peak and Thdl value of the 3 phase currents, the waveform and the harmonic spectrum of the 3 phase currents.

7.5.1. Symbols

The CURRENT position has three working modes:

- ✓ METER
- ✓ WAVE
- ✓ HARM

These modes will be described in detail in the next paragraphs.
The symbols used are described below:

Symbol	Description
I1, I2, I3	RMS value of current (phase 1, phase 2, phase 3 respectively)
IN	RMS value of current on neutral
Ipk1, Ipk2, Ipk3	Peak value of current (phase 1, phase 2, phase 3 respectively)
h01 ÷ h49	Harmonic 01 ÷ harmonic 49
Thdl	Total harmonic distortion factor of current
freq	Network frequency

Tab. 2: Symbols used in the **CURRENT** function

7.5.2. "METER" mode

By selecting this function the instrument selects automatically the METER mode corresponding to one of the screens below according to the settings made as per paragraph 7.1.

27.09.00 17:35:12			
SINGLE PHASE CURRENT			
I1	=	30.21	A
Ipk1	=	49.53	A
ThdI	=	23.06	%
freq	=	50.0	Hz
HARM.	WAVE	PG-	PG+

Example of screen in single-phase mode

27.09.00 17:35:12			
CURRENT			
I1	=	30.21	A
I2	=	23.53	A
I3	=	23.06	A
freq	=	50.0	Hz
HARM.	WAVE	PG-	PG+

Example of screen in "3-wire" three-phase mode

27.09.00 17:35:12			
CURRENT			
I1	=	30.21	A
I2	=	23.53	A
I3	=	23.06	A
IN	=	8.4	A
freq	=	50.0	Hz
HARM.	WAVE	PG-	PG+

Example of screen in "4-wire" three-phase mode

The symbols used are described in Tab. 2.

For eventual messages displayed see appendix 1 – MESSAGES DISPLAYED.

Following keys are active:

- ☞ **F1:** to pass to "HARMONIC" mode (see paragraph 7.5.3)
- ☞ **F2:** to pass to "WAVE" mode (see paragraph 7.5.4)
- ☞ **F3/F4:** to pass to previous/next function respectively
- ☞ **SAVE:** to save in the instrument memory a record of "Smp" type containing the instantaneous values of voltage and current present at the instrument inputs. This function is disabled during a recording
- ☞ **ENTER/HOLD:** to enable/disable the HOLD function (updating interruption) of displayed data. All previous functions remain however available. When the HOLD function is activated, the word **HOLD** is displayed. When this function is enabled it's not possible to record nor perform energy measurements. This function is disabled during a recording or an energy measurement.
- ☞ **MENU:** to enter the **MENU** mode and change the instrument settings (see paragraph 7.1 and 7.2). It's not possible to enter the configuration MENU during a recording or an energy measurement
- ☞ **START/STOP:** to record **selected parameters** according to the instrument's settings

7.5.3. "HARM" mode

By selecting the HARM mode one of the screens below will be displayed according to the settings made. The screens show the harmonics of the phase currents.

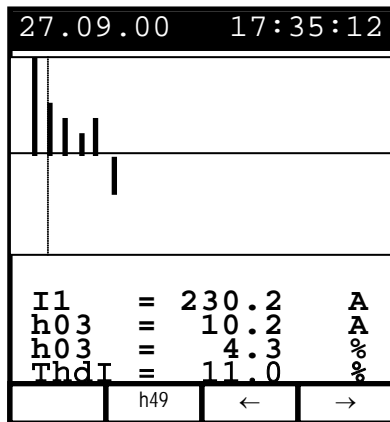

Example of screen in single-phase mode

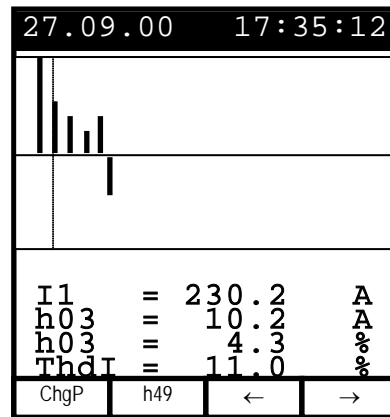

Example of screen in "3-wire" or "4-wire" three-phase mode

The symbols used are described in Tab. 2.

For eventual messages displayed see appendix 1 – MESSAGES DISPLAYED.

The displayed histograms represent the harmonic content of the current under test. The value of the first harmonic h01 (primary at 50Hz) is not represented in scale along with the other harmonics in order to maximise the display of the latter. In case both voltage and current are connected to the instrument inputs, eventual negative values (therefore represented under the horizontal axis), indicate that such current harmonics are "generated" by the load.

Following keys are active:

- ☞ **F3, F4:** to move the cursor of the selected harmonic leftwards and rightwards respectively. At the same time the values related to the order no. of the selected harmonic and to the corresponding absolute and relative values (calculated on the basis of the fundamental) are updated
- ☞ **F1** (only for three-phase mode): to display the values of the harmonics of the other voltages available. The voltage displayed is indicated above the F3 key
- ☞ **F2:** to display the page of the harmonics h01 ÷ h24 (**h24** symbol) or the page of the harmonics h25 ÷ h49 (**h49** symbol)
- ☞ **ESC:** to return back to METER mode (see paragraph 7.5.2)
- ☞ **SAVE:** to store in the instrument memory a record of "Smp" type and the instantaneous values of voltage and current present at the instrument inputs. This function is disabled during a recording
- ☞ **ENTER/HOLD:** to enable/disable the HOLD function (updating interruption) of displayed data. All previous functions remain however available. When the HOLD function is activated, the word **HOLD** is displayed. When

this function is enabled it's not possible to record nor perform energy measurements. This function is disabled during a recording or an energy measurement

- ☞ **MENU:** to enter the **MENU** mode and change the instrument settings (see paragraph 7.1 and 7.2). It's not possible to enter the configuration MENU during a recording or an energy measurement
- ☞ **START/STOP:** to record **selected parameters** according to the instrument's settings

7.5.4. "WAVE" mode

By selecting the WAVE mode one of the screens below will be displayed according to the settings made. The screens show the waveform of the phase currents.

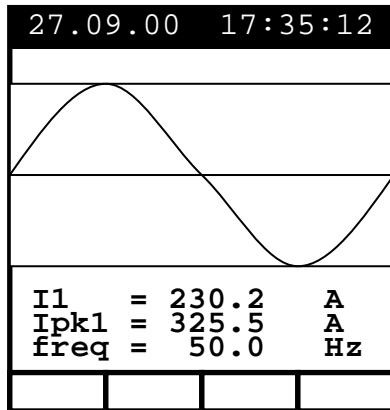

Example of screen in single-phase mode

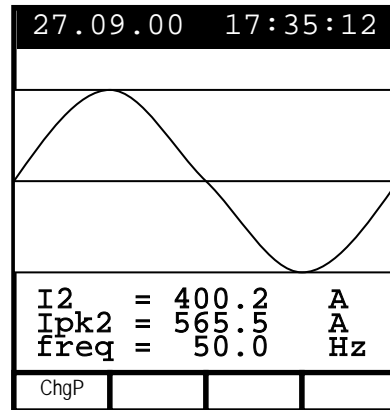

Example of screen in "3-wire" or "4-wire" three-phase mode

The symbols used are described in Tab. 2.

For eventual messages displayed see appendix 1 – MESSAGES DISPLAYED.

Following keys are active:

- ☞ **F1:** (only for three-phase mode): to display the values related to the following phase
- ☞ **ESC:** to return back to METER mode (see paragraph 7.5.2)
- ☞ **SAVE:** to save in the instrument memory a record of "Smp" type containing the instantaneous values of voltage and current present at the instrument inputs. This function is disabled during a recording
- ☞ **ENTER/HOLD:** to enable/disable the HOLD function (updating interruption) of displayed data. All previous functions remain however available. When the HOLD function is activated, the word **HOLD** is displayed. When this function is enabled it's not possible to record nor perform energy measurements. This function is disabled during a recording or an energy measurement
- ☞ **MENU:** to enter in the **MENU** mode and change the instrument settings (see paragraph 7.1 and 7.2). It's not possible to enter the configuration MENU during a recording or an energy measurement
- ☞ **START/STOP:** to record **selected parameters** according to the instrument's settings

7.6. "POWER" FUNCTION

This function permits to display in real time the RMS value of AC/DC voltage, the peak and ThdV value of the 3 phase voltages, the waveform of the 3 phase voltages, the RMS value of AC/DC currents, the peak and ThdI of the 3 phase currents and the waveform of the 3 phase currents. Furthermore, the instrument calculates and displays the value of phase and total active powers, the value of phase and total reactive and capacitive powers, the value of phase and total power factors and $\cos\phi$.

7.6.1. Symbols

The position POWER has two working modes:

- ✓ METER
- ✓ WAVE

For voltage and current harmonics see paragraphs 7.4.3 and 7.5.3 respectively.

These modes will be described in detail in the next paragraphs.

The symbols used are described below:

Symbol	Description
V1, V2, V3	RMS value of voltage (phase 1, phase 2, phase 3 respectively)
V12, V23, V32, V31	RMS value of phase to phase voltages
freq	Network frequency
Phseq	Phase sequence indicator "123" → correct "132" → inverted "023" → null voltage on black wire "103" → null voltage on red wire "120" → null voltage on blue wire "100" → null voltages on red and blue wires "020" → null voltages on black and blue wires "003" → null voltages on black and red wires
I1, I2, I3	RMS value of current (phase 1, phase 2, phase 3 respectively)
IN	RMS value of current of neutral
Pt, P1, P2, P3	Values of active power (total, phase 1, phase 2, phase 3 respectively)
P12, P32	(only for 3-wire measurement) value of power measured by Wattmeter 1-2 and 3-2 respectively
Qt, Q1, Q2, Q3	Values of reactive power (total, phase 1, phase 2, phase 3 respectively)
Q12, Q32	(only for 3-wire measurement) Value of power measured by VAR meter Va1-2 and 3-2 respectively
St, S1, S2, S3	Values of apparent power (total, phase 1, phase 2, phase 3 respectively)
S12, S32	(only for 3-wire measurement) Value of power measured by VA meter Va1-2 and 3-2 respectively
Pft, pf1, pf2, pf3	Values of power factors (total, phase 1, phase 2, phase 3 respectively)
dPft, dpf1, dpf2, dpf3	Value of the $\cos\phi$ (total, phase 1, phase 2, phase 3 respectively)
Ead, Pd	Values of total active energy and active power on demand respectively
Esd, Sd	Values of total apparent energy and apparent power on demand respectively

Tab. 3: Symbols used in the **POWER** function

The symbols "i" and "c" stand for reactive powers (Q), power factors (Pf) and $\cos\phi$ (dpf), inductive and capacitive respectively.

7.6.2. "METER" mode

By selecting this function the instrument selects automatically the METER mode corresponding to one of the screens below according to the settings made as per paragraph 7.1.

27.09.00 17:35:12			
SINGLE PHASE POWER			
V1	=	230.0	V
I1	=	145.3	A
P1	=	32.91	kW
Q1	=	5.767	kVAR
S1	=	33.41	kVA
pf1	=	0.99	i
dpf1	=	0.99	i
WAVE	PG-	PG+	

Example of screen in single-phase mode

27.09.00 17:35:12			
POWER THREE WIRE			
Pt	=	64.19	kW
Ot	=	10.99	kVAR
St	=	65.12	kVA
pft	=	0.99	i
dpft	=	1.00	i
ChgP	WAVE	PG-	PG+

Example of screen in "3-wire" three-phase mode

27.09.00 17:35:12			
POWER THREE PHASE			
Pt	=	135.8	kW
Ot	=	24.59	kVAR
St	=	138.0	kVA
pft	=	0.98	i
dpft	=	1.00	i
Phseq	=	123	
ChgP	WAVE	PG-	PG+

Example of screen in "4-wire" three-phase mode

The symbols used are described in Tab. 3.

For eventual messages displayed see appendix 1 – MESSAGES DISPLAYED.

Following keys are active:

- ☞ **F2:** to pass to "WAVE" mode (see paragraph 7.6.3).
- ☞ **F1:** (only for three-phase measurement) to display the previous or the following screen. On the basis of the settings made as per paragraph 7.1 following screens are displayed cyclically:
 - ✓ Three-phase 3 wires: total three-phase values, Wattmeter phases 1-2 and 2-3 values, peak demand
 - ✓ Three-phase 4 wires: total three-phase values, phase1, phase2 and phase3 values, peak demand
- ☞ **F3/F4:** to pass to previous/next function respectively
- ☞ **SAVE:** to save in the instrument memory a record of "Smp" type and the instantaneous values of voltage and current present at the instrument inputs. This function is disabled during a recording
- ☞ **ENTER/HOLD:** to enable/disable the HOLD function (updating interruption) of displayed data. All previous functions remain however available. When the HOLD function is activated, the word **HOLD** is displayed. When this function is enabled it's not possible to record nor perform energy measurements. This function is disabled during a recording or an energy measurement
- ☞ **MENU:** to enter the **MENU** mode and change the instrument settings (see paragraph 7.1 and 7.2). It's not possible to enter the configuration MENU during a recording or an energy measurement
- ☞ **START/STOP:** to record **selected parameters** according to the instrument's settings

7.6.2.1. PEAK ENERGY DEMAND

In three-phase systems, by selecting the POWER function and pressing **F1** thrice you can reach the “Peak Demand” mode. This mode shows the values corresponding to the recording being performed or to the last performed recording (if no recording is being performed).

The “Peak Demand” screen shows the max average value of active Power (and the corresponding energy) or max average value of apparent power (and the corresponding energy) measured during the last (or running) recording. The average value is evaluated with reference to the integration period set for the recording. This screen also shows the corresponding active energy and the corresponding peak date and time.

27.09.00 17:35:12			
PEAK DEMAND THREE PHASE			
Ead	=	98.36 kWh	
Pd	=	24.59 kW	
Peak Date			
25.09.00 17:00			
Int Period: 15min			
Rec n: 06			
ChgP	Wh	PG-	PG+

27.09.00 17:35:12			
PEAK DEMAND THREE PHASE			
Esd	=	120.84 kVAh	
Sd	=	30.21 kVA	
Peak Date			
25.09.00 18:15			
Int Period: 15min			
Rec n: 06			
ChgP	VAh	PG-	PG+

Example of “PEAK ENERGY DEMAND” screen

- ☞ **F1:** to display the previous or the following screen. On the basis of the settings made as per paragraph 7.1 following screens are displayed cyclically:
 - ✓ Three-phase 3 wires: total three-phase values, Wattmeter phases 1-2 and 2-3 values, peak demand
 - ✓ Three-phase 4 wires: total three-phase values, phase1, phase2 and phase3 values, peak demand
- ☞ **F3:** to show active power and active energy values
- ☞ **F4:** to show apparent power and apparent energy values
- ☞ **SAVE:** to save in the instrument memory a record of “Smp” type and the instantaneous values of voltage and current present at the instrument inputs. This function is disabled during a recording
- ☞ **ENTER/HOLD:** to enable/disable the HOLD function (updating interruption) of displayed data. All previous functions remain however available. When the HOLD function is activated, the word **HOLD** is displayed. When this function is enabled it’s not possible to record nor perform energy measurements. This function is disabled during a recording or an energy measurement
- ☞ **MENU:** to enter the **MENU** mode and change the instrument settings (see paragraph 7.1 and 7.2). It’s not possible to enter the configuration MENU during a recording or an energy measurement
- ☞ **START/STOP:** to record **selected parameters** according to the instrument’s settings

7.6.3. "WAVE" mode

By selecting the WAVE mode one of the screens below will be displayed according to the settings made as per paragraph 7.1. The screens show the waveform of phase currents and phase (or phase-to-phase) voltage.

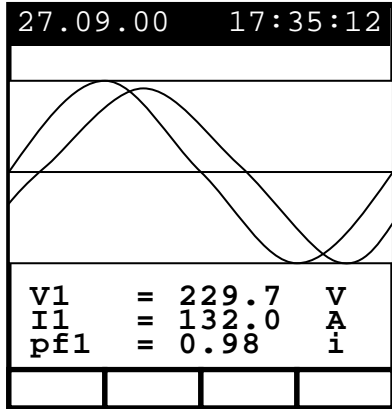

Example of screen in single-phase mode

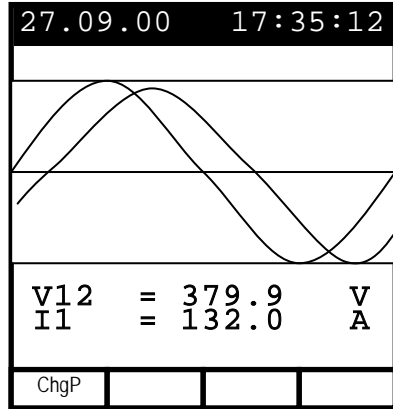

Example of screen in "3-wire" three-phase mode

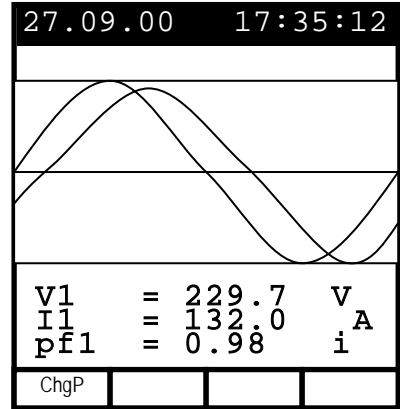

Example of screen in "4-wire" three-phase mode

The symbols used are described in Tab. 3.

For eventual messages displayed see appendix 1 – MESSAGES DISPLAYED.

Following keys are active:

- ☞ **F1:** (only for three-phase mode): to display the values related to the following phase. On the basis of the settings made as per paragraph 7.1 following screens are displayed cyclically:
 - ✓ 3 wires three-phase: values of Wattmeter 1-2, values of Wattmeter 2-3
 - ✓ 4 wires three-phase: values of phase 1, phase 2 and phase 3
- ☞ **ESC:** to return back to METER mode (see paragraph 7.6.2)
- ☞ **SAVE:** to save in the instrument memory a record of "Smp" type containing the instantaneous values of voltage and current present at the instrument inputs. This function is disabled during a recording
- ☞ **ENTER/HOLD:** to enable/disable the HOLD function (updating interruption) of displayed data. All previous functions remain however available. When the HOLD function is activated, the word **HOLD** is displayed. When this function is enabled it's not possible to record nor perform energy measurements. This function is disabled during a recording or an energy measurement
- ☞ **MENU:** to enter the **MENU** mode and change the instrument settings (see paragraph 7.1 and 7.2). It's not possible to enter the configuration MENU during a recording or an energy measurement
- ☞ **START/STOP:** to record **selected parameters** according to the instrument's settings

7.7. "ENERGY" FUNCTION

This function permits to display the values of phase and total active powers, phase and total capacitive and inductive reactive powers, power factors and phase and total $\cos\phi$. Furthermore, the instrument is able to measure directly (see 7.7.2) the values of phase and total active energies and the values of phase and total capacitive and inductive reactive energies.

7.7.1. Symbols

The position ENERGY has one working mode:

- ✓ METER

This mode will be described in detail in the next paragraphs.

The symbols used are described below:

Symbol	Description
Pt, P1, P2, P3	Values of active power (total, phase 1, phase 2, phase 3 respectively)
P12, P32	(only for 3-wire measurement) Value of power measured by Wattmeter 1-2 and 3-2 respectively
Qt, Q1, Q2, Q3	Values of reactive power (total, phase 1, phase 2, phase 3 respectively)
Q12, Q32	(only for 3-wire measurement) Value of power measured by VARmeter 1-2 and 3-2 respectively
St, S1, S2, S3	Values of the apparent power (total, phase 1, phase 2, phase 3 respectively)
S12, S32	(only for 3-wire measurement) Value of power measured by VAmeter 1-2 and 3-2 respectively
Eat, Ea1, Ea2, Ea3	Values of active energy (total, phase 1, phase 2, phase 3 respectively)
Erit, Eri1, Eri2, Eri3	Values of inductive reactive energy (total, phase 1, phase 2, phase 3 respectively)
Erct, Erc1, Erc2, Erc3	Values of capacitive reactive Energy (total, phase 1, phase 2, phase 3 respectively)
Est, Es1, Es2, Es3	Values of apparent energy (total, phase 1, phase 2, phase 3 respectively)

Tab. 4: Symbols used in the **ENERGY** function

The symbols "**i**" and "**c**" stand for reactive powers (Q) and energies (Er), inductive and capacitive respectively.

7.7.2. "METER" mode

By selecting this function the instrument selects automatically the METER mode corresponding to one of the screens below according to the settings made as per paragraph 7.1.

27.09.00		17:35:12	
ENERGY SINGLE PHASE			
Ea1	=	0.000	kWh
Erc1	=	0.000	kVARh
Eri1	=	0.000	kVARh
Es1	=	0.000	kVAh
P1	=	36.38	kW
Q1	=	6.375	kVAR
S1	=	36.94	kVA
Meas	Time:	00:00:00	
	Meas	PG-	PG+

Example of screen in single-phase mode

27.09.00		17:35:12	
ENERGY THREE PHASE			
Eat	=	0.000	kWh
Erct	=	0.000	kVARh
Erit	=	0.000	kVARh
Est	=	0.000	kVAh
Pt	=	36.38	kW
Qt	=	6.375	kVAR
St	=	36.94	kVA
Meas	Time:	00:00:00	
	Meas	PG-	PG+

Example of screen in "3-wire" three-phase mode

27.09.00		17:35:12	
ENERGY THREE PHASE			
Eat	=	0.000	kWh
Erct	=	0.000	kVARh
Erit	=	0.000	kVARh
Est	=	0.000	kVAh
Pt	=	167.7	kW
Qt	=	30.47	kVAR
St	=	170.4	kVA
Meas	Time:	00:00:00	
ChgP	Meas	PG-	PG+

Example of screen in "4-wire" three-phase mode

The symbols used are described in Tab. 4.

For eventual messages displayed see appendix 1 – MESSAGES DISPLAYED.

Following keys are active:

- ☞ **F2:** to start / stop immediately a **direct energy measurement**. The energy counters will start increasing proportionally to the active power absorbed by the load.
The results obtained cannot be memorised.
If the active power is negative the counters will not increase.
- ☞ **F1:** (only for 4-wire measurement) to display the following screen. On the basis of the settings made as per paragraph 7.1 following screens are displayed cyclically:
total three-phase values, values of phase 1, phase 2 and phase 3
- ☞ **F3/F4:** to pass to previous/next function respectively
- ☞ **SAVE:** to save in the instrument memory a record of "Smp" type containing the instantaneous values of voltage and current present at the instrument inputs. This function is disabled during a recording
- ☞ **ENTER/HOLD:** to enable/disable the HOLD function (updating interruption) of displayed data. All previous functions remain however available. When the HOLD function is activated, the word **HOLD** is displayed. When this function is enabled it's not possible to record nor perform energy measurements. This function is disabled during a recording or an energy measurement
- ☞ **MENU:** to enter the **MENU** mode and change the instrument settings (see paragraph 7.1 and 7.2). It's not possible to enter the configuration MENU during a recording or an energy measurement
- ☞ **START/STOP:** to record **selected parameters** according to the instrument's settings

8. MEASURING PROCEDURES

8.1. USING THE INSTRUMENT IN A SINGLE-PHASE SYSTEM



CAUTION

The maximum voltage between V1 and COM inputs is 600 V~ (CATII) / 350V~ phase – earth or 600V~ (CATIII) / 300 V~ phase to earth. Do not measure voltages exceeding the limits prescribed by this manual. Should you exceed the voltage limits you could damage the instrument and/or its components or endanger your safety.

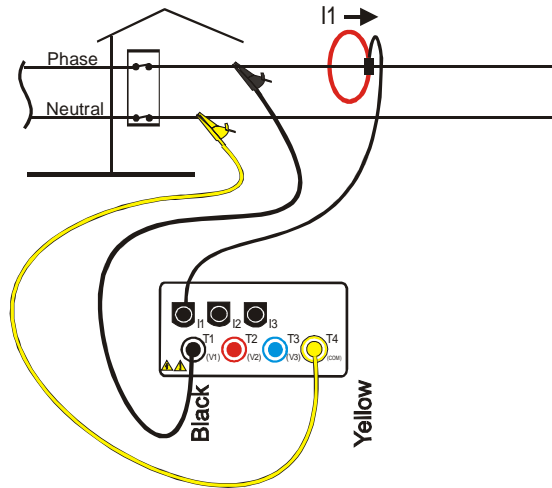

Instrument connection in a single-phase system

1. Check, and if needed modify, the basic settings of the instrument (see paragraphs 7.1 and 7.2). Particularly, the **single-phase** mode must be set.
2. Rotate the switch to the position corresponding to the type of analysis desired.
3. Connect the phase and neutral voltage wires respecting the connections shown in the picture.
4. If you want to measure current and power, connect the clamp meter to the phase conductor respecting the specifications shown on the clamp and the connections shown in the picture.
 In case of doubt, select the position **POWER** and check if the active power P is positive. If it's negative, remove current transducer from the wire and reconnect it so the transducer label faces the opposite direction.
5. Apply voltage to the electrical equipment under test (if previously shut off for the instrument connection).
6. The values of the available electrical parameters will be displayed on the display of the instrument. For further details see the paragraph relevant to the position of the switch.
7. You can press **HOLD** to interrupt the updating in real time of the displayed values.
8. If you want to record:
 - a) Check, and if needed modify, the values of the basic parameters (see paragraphs 7.1 and 7.2).
 - b) Check, and if needed modify, the recording parameters by pressing **MENU** (see the paragraph corresponding to the position of the rotary switch selected).
 - c) To start the recording press **START** (see paragraph 10.1).

8.2. USING THE INSTRUMENT IN A THREE-PHASE 4-WIRE SYSTEM



CAUTION

The maximum voltage between V1, V2, V3, COM inputs is 600 V~ (CATII) / 350V~ phase to earth or 600V~ (CATIII) / 300 V~ phase to earth. Do not measure voltages exceeding the limits prescribed by this manual. Should you exceed the voltage limits you could damage the instrument and/or its components or endanger your own safety.

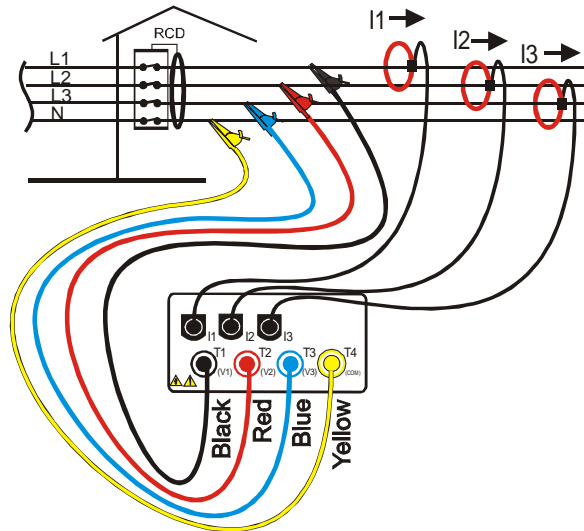

Instrument connection in a three phase 4-wire system

1. Check, and if needed modify, the basic settings of the instrument (see paragraphs 7.1 and 7.2). Particularly, the **3PH4W** mode must be set.
2. Rotate the switch to the position corresponding to the type of analysis desired.
3. Connect the phase and neutral voltage wires following the connections shown in the picture above.
4. To measure current and power, connect the clamp meter to the phase conductor following the specifications shown on the clamp and the connections shown in the picture above. In case of doubts select the position **POWER** and, connecting one clamp a time, check if:
 - a) the phase sequence is correct (see paragraph 7.4.2).
 - b) the active power P of each phase is positive. If it's negative, remove current transducer from the wire and reconnect it so the transducer label faces the opposite direction.
 - c) the value of the Pf of each phase is not excessively low (typically it's not lower than 0.4). In case the Pf is lower than 0.4, check if the phase voltage is associated to the right clamp meter (for example the voltage of phase 1 must be associated to the clamp meter no. 1).
5. Apply voltage to the electrical equipment under test (if previously shut off for the instrument connection).
6. The values of the available electrical parameters will be displayed. For further details see the paragraph relevant to the position of the switch.
7. You can press **HOLD** to interrupt the real time updating of the displayed values.
8. If you want to record:
 - a) Check and modify the values of the basic parameters (see paragraphs 7.1 and 7.2).
 - b) Check and, if needed, modify the recording parameters by pressing **MENU** (see the paragraph corresponding to the position of the rotary switch selected).
 - c) To start the recording press **START** (see paragraph 10.1).

8.3. USING THE INSTRUMENT IN A THREE-PHASE 3-WIRE SYSTEM



CAUTION

The maximum voltage between V1, V2, V3 inputs is 600 V~ (CATII) / 350V~ phase to earth or 600V~ (CATIII) / 300 V~ phase to earth. Do not measure voltages exceeding the limits prescribed by this manual. Should you exceed the voltage limits you could damage the instrument and/or its components or endanger your own safety.

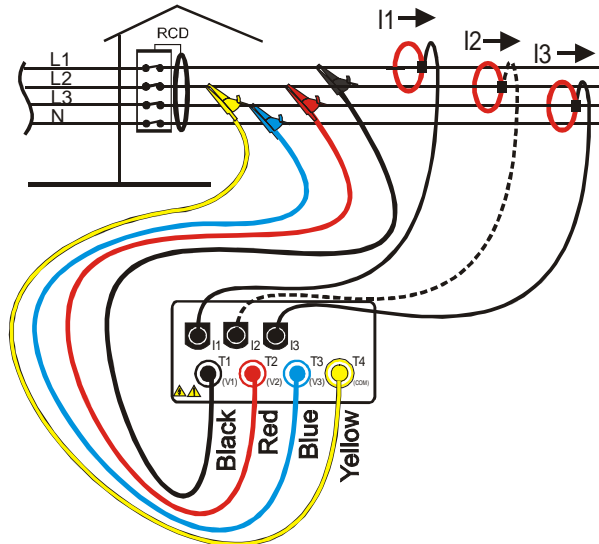

Instrument connection in a three-phase 3-wire system



CAUTION

Please note that in this case the Yellow cable is connected with the red cable on phase 2.

Note: The connection of Clamp 2 isn't necessary for Power measurement.

1. Check, and if needed modify, the basic settings of the instrument (see paragraphs 7.1 and 7.2). Particularly, the **3 wires** mode must be set.
2. Rotate the switch to the position corresponding to the type of analysis desired.
3. Connect the phase and neutral voltage wires following the connections shown in the picture above.
4. To measure current and power, connect the clamp to the phase conductor following the specifications shown on the clamp and the connections shown in the picture above. In case of doubts set **temporarily** the **3PH3W** mode, select the **POWER** position, connect the yellow wire of the instrument to earth and, connecting one clamp a time, check if:
 - a) The phase sequence is correct (see paragraph 7.4.2).
 - b) The active power P of each phase is positive. If negative, turn the clamp of the phase in question.
 - c) The value of the Pf of each phase is excessively low (typically it's not lower than 0.4). If the Pf is lower than 0.4, check if the phase voltage is associated to the right clamp meter (ex. the voltage of phase 1 must be associated to the clamp n. 1).

- d) After checking, and if needed modifying, the connection of the instrument to the equipment re-set the **3 wires** mode and the connections shown in the picture above (yellow and red wires together).
5. Energize the electrical equipment under test.
6. The values of the available electrical parameters will be displayed on the instrument. For further details see the paragraph relevant to the position of the switch.
7. You can press **HOLD** to interrupt the updating in real time of the displayed values.
8. If you want to record:
 - a) Check and modify the values of the basic parameters (see paragraphs 7.1 and 7.2).
 - b) Check and eventually modify the recording parameters by pressing **MENU** (see the paragraph corresponding to the position of the rotary switch selected).
 - c) To start the recording press **START** (see paragraph 10.1).

9. SAVING RESULTS

The **SAVE** button can be used to store the displayed results related to the rotary switch position:

- ✓ SAFETY TEST (LOW Ω , Insulation Test, Phase sequence, Ground Test): pressing this key the instrument will store the displayed result generating a corresponding record in the SAFETY TEST MEMORY (see paragraph 11.1)
- ✓ POWER QUALITY: pressing this key the instrument will store the displayed result generating a "Smp" record in the ANALYZER MEMORY (see paragraph 11.2)

Please note that Saving results is different from recording.

9.1. SAVING SAFETY TEST RESULTS

After a SAFETY TEST (LOW Ω , Insulation Test, Phase sequence, Ground Test) the user can press the SAVE button to store the displayed result.

The REMINDER PLACE parameter isn't related to Measurement Order Number and can help the user to remind the place where he performed the measurement.

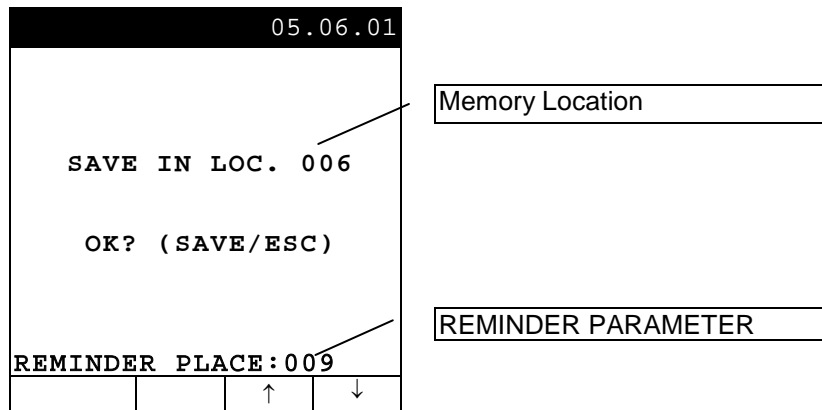

The following keys are available:

- ☞ **F3, F4:** to adjust the REMINDER PLACE.
- ☞ **SAVE:** to store the test result associating to the actual REMINDER PLACE
- ☞ **ESC:** to quit this mode without saving.

9.2. SAVING DISPLAYED VALUES OF POWER QUALITY FUNCTION

During a Real Time measurement (in POWER QUALITY function) if the user press the SAVE button, a "Smp" record will be generate in the "ANALYZER MEMORY". This file contains the Voltage and Current values present at instrument's input when the user pressed the SAVE key.

Downloading these values to a PC (using the management Software) the Power, Energy, Harmonics, etc values can be calculated and displayed as well.

10. RECORDINGS

10.1. START A RECORDING

The recording function is available only for **POWER QUALITY** rotary switch position. As you can read in the paragraph 7.2, a recording can be started manually or automatically. Therefore, after setting all the parameters **and leaving the Menu**, the instrument will start to record:

- ✓ **MANUALLY:** the recording will start when Instrument time reach the "00" seconds value after pressing START/STOP.
- ✓ **AUTOMATICALLY:** **If the operator has pressed START/STOP** the instrument will remain in stand-by until the date and time previously set, then the recording will start. **While if the operator doesn't press START/STOP the recording will never start.**

CAUTION



For recordings **we recommend to use the external power supply adapter** (code **DMT-EXTPS**) even the instrument allows the operator to perform a recording using internal batteries.

If you press Start a recording without the external power supply adapter (code **DMT-EXTPS**) the instrument will display a warning message "**No ext supply**". Press **START** key again to run the recording or press **ESC** to quit.

If during a recording the external power supply adapter (code **DMT-EXTPS**) is de-energised, the instrument will continue the recording using the internal battery power until the batteries are exhausted (the data stored until the definitive turning off won't get lost). For this we recommend you **ALWAYS insert a new set of batteries before a long recording.**

The instrument uses sophisticated algorithms to prolong the battery life. Particularly:

- ✓ The instrument switches OFF the backlight Automatically after 5 seconds.
- ✓ If the Battery level is too low the Backlight function will be disabled.
- ✓ If the instrument is just displaying in real time (and the external power supply is not connected), after about 5 minutes from the last key pressure or switch rotation the instrument turns off automatically ("AUTOPOWER OFF" function).
- ✓ If the instrument is recording or is measuring energy (and the external power supply is not connected), after about 5 minutes from the last key pressure or switch rotation the instrument starts a special procedure to save the batteries ("ECONOMY MODE"): the instrument keeps recording but the display is turned off.

Before starting a recording the operator should first evaluate the state of the equipment, decide what to record and set the instrument accordingly.

In order to facilitate this task we have decided to supply the instrument pre-set with a general configuration which should fit most cases.

The chosen configuration is the following (for POWER QUALITY function)

✓ ANALYZER CONFIG:

Frequency:	60Hz
Full scale of the clamps:	1000A
Transforming ratio of voltmetric transformers:	1
Type of electrical equipment:	4 wires
Password:	enabled

✓ RECORDER CONFIG:

Start:	Manual (the recording is started at 00 sec mark on clock after pressing the START/STOP key)
Stop:	Manual
Integration period:	15min
Recording of harmonics:	ON
Recording of Sag and Surge:	ON
Voltage Reference for Sag and Surge detection:	110V
Upper Limit for Sag and Surge detection:	6%
Lower Limit for Sag and Surge detection:	10%
Selected voltages:	V1, V2, V3
Selected voltage harmonics:	Thd, 01, 03, 05, 07
Selected currents:	I1, I2, I3, IN
Selected current harmonics:	Thd, 01, 03, 05, 07
CO-GENERATION:	OFF
Powers, Pf and $\cos\phi$ selected:	Pt, P1, P2, P3 Qti, Q1i, Q2i, Q3i Qtc, Q1c, Q2c, Q3c St, S1, S2, S3 Pft, Pf1, Pf2, Pf3 dpft, dpf1, dpf2, dpf3
Energies:	Eat, Ea1, Ea2, Ea3 Erit, Eri1, Eri2, Eri3 Erct, Erc1, Erc2, Erc3 Est, Es1, Es2, Es3

If the user changed the instrument's settings can quickly resume the above configuration using the RESET option (see paragraph 5.5).

By pressing **START/STOP** the recording of the selected parameters is started according to the settings made in the MENU (see paragraphs 7.1 and 7.2). The rotary switch position doesn't affect the recording setting.

The instrument will Start the recording when the Time reach hh:mm:00sec (MAN mode) or when the START Date and Time (see paragraphs 7.1 and 7.2) will be reached. Before of that the instrument will display the message "Please wait...".

As the default value of the integration periods is set at 15 minutes the instrument will store data in the temporary memory for 15 minutes. Afterwards the instrument will elaborate the results saved in the temporary memory and will save the result of this elaboration (min, avg, and max values) in the definitive memory. Therefore, if an integration period of 15 minutes has been set, the recording will continue for about 15 minutes before producing a series of recorded values. If the recording is interrupted before the selected integration period has completely elapsed the data stored in the temporary memory will not be

elaborated and the corresponding series of values won't be transferred to the definitive memory.

10.2. DURING A RECORDING

If during a recording the external power supply is de-energised, the instrument will continue the recording using the internal battery power until the batteries are exhausted (the data stored up to the point the instrument shuts down won't get lost). For this we recommend you **ALWAYS insert a new set of batteries before a long recording.**

The instrument uses sophisticated algorithms to prolong the battery life. Particularly if the instrument is recording or is measuring energy (and the external power supply is not connected), after about 5 minutes from the last key pressure or switch rotation the instrument starts a special procedure to save the batteries ("ECONOMY MODE"): the instrument keeps recording but the display is turned off.

During a recording the following are disabled:

- ✓ **AUTOPOWER OFF function**
- ✓ **ON/OFF key**
- ✓ **HOLD key**
- ✓ **SAVE key**

10.2.1. MENU key

If you press the **MENU** key during a recording the following screen will appear:

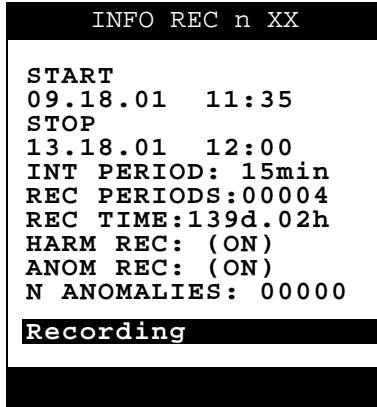

This page includes:

1. START Date and Time
2. STOP Date and Time (or Manual).
3. Integration Period
4. Actual Number of Elapsed Integration Periods
5. Actual Recording Time
6. Status of Harmonic Flag
7. Status of Voltage Anomalies Flag
8. Number of Voltage anomalies occurred during the recording

10.2.2. Rotary Switch during a recording

If You move the rotary switch during a recording the following screen will appear:



This page means that a recording is running but the actual rotary switch position doesn't correspond to this.

The instrument will continue to record.

10.3. STOPPING A RECORDING / ENERGY MEASUREMENT

The instrument uses a protective routine to avoid the risk of being disturbed or interrupted during a recording or an energy measurement. Once a recording or a direct energy measurement (see paragraph 7.7.2) has been started (with the option PASSWORD enabled), after about 3 minutes from the last key pressure or switch rotation it won't be sufficient to press START/STOP (if a recording is running) or **F2** (if an energy measuring is running) to stop the recording, it will be necessary to insert the password.

In order to insert the password (which is not changeable), press the multifunction keys in the following sequence (within 10 seconds):

F1, F4, F3, F2

In order to enable/disable this option see paragraph 7.1.

If a wrong password is inserted, the instrument will display an error message and will repeat the request.

If no key is pressed after about 10 seconds the instrument returns back to the original screen.

11. INSTRUMENT'S MEMORY

By pressing the **MENU** key the following screen will be displayed:

MENU GENERAL			
SAFETY TEST MEMORY			
ANALYZER MEMORY			
RESET			
ANALYZER CONFIG			
RECORDER CONFIG			
CONTRAST			
DATE&TIME			
LANGUAGE			
COUNTRY			
↓	↑		

It's not possible to enter the **MENU** during a recording or a Real Time Energy measurement.

11.1. SAFETY TEST MEMORY

Selecting the SAFETY TEST MEMORY item and pressing ENTER the instrument display the following screen:

SAFETY TEST MEMORY		
MEM	TYPE	PLACE
001	LOWΩ	003
002	EARTH	003
003	MΩ	004
TOT:003 FREE:996		
↑	↓	LAST ALL

Example of SAFETY TEST MEMORY screen

- ✓ MEM: **Order Number of the measurement**
- ✓ TYPE: Measurement TYPE
- ✓ PLACE: Mnemonic parameter associated by User to Measurement
- ✓ TOT: Total Number of Measurement
- ✓ FREE: Available Memory Location

Following keys are enabled:

- ☞ **F1, F2:** (to select the Measurement).
- ☞ **F3:** to cancel the last recording effected.
- ☞ **F4:** to cancel all the recordings effected.
- ☞ **ENTER:** to see the measurement results of the selected test
- ☞ **ESC:** to quit this mode

11.2. ANALYZER MEMORY

This option permits you to display:

- ✓ The present content of the instrument memory
- ✓ The size of the memorised data
- ✓ The residual space available for future recordings (expressed in days and hours)

All the stored data can be displayed and analyzed only downloading them into a PC with the operating software.

After selecting “ANALYZER MEMORY” from the Main Menu the screen below will be displayed

ANALYZER MEMORY			
01	Smp	02.01	01:23
02	Rec	02.01-02.01	
03	R&a	02.01-02.01	
04	Rec	02.01-02.01	
05	R&a	02.01-02.01	
06	Rec	04.01-05.01	
DATA SIZE:0.11Mb			
REC TIME: 0d.06h			
↑	↓	LAST	ALL

Example of ANALYZER MEMORY screen

- ✓ Rec: **recordings** effected with respective Start and Stop dates expressed in the format “day.month” (start) – “day.month” (stop) **without** Voltage Sag and Surge detection.
- ✓ R&a: **recordings** effected with respective Start and Stop dates expressed in the format “day.month” (start) – “day.month” (stop) **with** Voltage Anomalies (Sag and Surge) detection .
- ✓ Smp: values of the **samples** of voltage and current stored by pressing SAVE.
- ✓ DATA SIZE: dimensions of the data saved in the instrument memory.
- ✓ REC TIME: amount of memory available, calculated on the basis of the parameters selected for recording, therefore the most complete one (expressed in the format “days.hours”) to make recordings.

The maximum quantity of Rec + R&a + Smp which can be contained by the instrument is **35**.

Following keys are enabled:

- ☞ **F1, F2:** (only if the quantity of Rec+R&a+Smp is higher than 7) to run over all the recordings stored in the instrument memory.
- ☞ **F3:** to cancel the last recording effected.
- ☞ **F4:** to cancel all the recordings effected.
- ☞ **ESC:** to quit this mode

12. CONNECTING THE INSTRUMENT TO A PC

In order to connect the instrument to a PC you must connect the Optical serial cable code C2001 shipped with the instrument to a PC COM port.

The available transmission speeds are the following:

9600, 19200, 57600 (default value)

The value of the transmission speed (Baud Rate) is displayed on the initial screen (immediately after turning on the instrument, see paragraph 4.2). The value of this parameter can be modified only with the management software.

For download instructions please refer to software help file.

In order to transfer the memorized data from the instrument to the PC the following procedure must be followed (after Sw installation):



- 1. Switch ON the instrument and wait that Initial screen disappears (the rotary Switch position isn't relevant).**
- 2. Connect the Optical serial output of the instrument to the serial output of the PC through the Original C2001 serial cable**
- 3. Run the program**
- 4. Select the "Download" command**
- 5. Refer to software help ON Line for further instructions.**

13. MAINTENANCE

13.1. GENERAL INSTRUCTION

1. The tester you have purchased is a precision instrument. Strictly follow the instructions for use and storage reported in this manual to avoid any possible damage or danger during use.
2. Do not use this tester under unfavourable conditions of high temperature or humidity. Do not expose to direct sunlight.
3. Be sure to turn off the tester after use. If the instrument is not to be used for a long period you are recommended to remove batteries to avoid acid leakage which may damage the internal circuits of the instrument.

13.2. BATTERY REPLACEMENT

The symbol  shows the battery charge: If it is completely "black" the battery are full charge, while the  symbol indicate weak batteries. When the batteries are too low to execute the test the instrument will show a warning message.

In the case interrupt testing and replace batteries according the following the procedure. **The instrument is capable of keeping the data stored even though batteries are not installed. The Instrument Date and Time settings aren't lost if you change the batteries within 24hours.**



ATTENTION

Only skilled technicians can perform this operation. Before replacing batteries make sure that all test leads have been disconnected from input terminals.

1. Switch OFF the instrument.
2. Remove all the test leads from the input terminals.
3. Unscrew the fixing screws from the battery compartment cover and remove it.
4. Remove all batteries replacing them with 6 new ones of the same type (1.5V – LR6 – AA – AM3 – MN 1500) respecting the polarity signs.
5. Fix the screws on the battery compartment cover. Then put the holster on.

13.3. INSTRUMENT CLEANING

Use a soft dry cloth to clean the instrument. Never use wet cloths, solvents, water, etc.

14. TECHNICAL SPECIFICATIONS

14.1. TECHNICAL FEATURES

Accuracy is indicated as [% of reading + number of digits]. It refers to the following atmospheric conditions: a temperature of $23^{\circ}\text{C} \pm 5^{\circ}\text{C}$ with a relative humidity $< 60\%$.

14.1.1. Safety Test functions

● LOWΩ: 200mA CONTINUITY TEST (AUTO, RT+, RT- MODE)

Range [Ω]	Resolution [Ω]	Accuracy(*)
0.01 ÷ 9.99	0.01	±(2% Reading + 2 digit)
10.0 ÷ 99.9	0.1	

(*) After Test leads calibration
 Test Current > 200mA DC per $R \leq 5\Omega$ (Test leads included)
 Resolution for Test current: 1mA
 Open Circuit Voltage $4V \leq V_0 \leq 24V$

● INSULATION TEST

Test Voltage [V]	Range [MΩ]	Resolution [MΩ]	Accuracy
50	0.01 ÷ 9.99	0.01	±(2% Reading + 2 digit)
	10.0 ÷ 49.9	0.1	
	50.0 ÷ 99.9	0.1	±(5% Reading + 2 digit)
100	0.01 ÷ 9.99	0.01	±(2% Reading + 2 digit)
	10.0 ÷ 99.9	0.1	
	100.0 ÷ 199.9	0.1	±(5% Reading + 2 digit)
250	0.01 ÷ 9.99	0.01	±(2% Reading + 2 digit)
	10.0 ÷ 199.9	0.1	
	200 ÷ 249	1	±(5% Reading + 2 digit)
	250 ÷ 499	1	
500	0.01 ÷ 9.99	0.01	±(2% Reading + 2 digit)
	10.0 ÷ 199.9	0.1	
	200 ÷ 499	1	±(5% Reading + 2 digit)
	500 ÷ 999	1	
1000	0.01 ÷ 9.99	0.01	±(2% Reading + 2 digit)
	10.0 ÷ 199.9	0.1	
	200 ÷ 999	1	±(5% Reading + 2 digit)
	1000 ÷ 1999	1	

Open circuit Test Voltage < 1.3 x Nominal Test Voltage
 Short Circuit Current < 6.0mA with 500V Test Voltage
 Nominal Test Current 500V > 2.2mA with 230kΩ
 other > 1mA with $1k\Omega \cdot V_{nom}$

● FREQUENCY MEASUREMENT

Range [Hz]	Resolution [Hz]	Accuracy
47.0 ÷ 63.6	0.1	±(0.1% Reading + 1 digit)

RCD and LOOP function are active only for $50\text{Hz} \pm 0.5\text{Hz}$ frequency

● PHASE ROTATION : VOLTAGE MEASUREMENT

Range [V]	Resolution [V]	Accuracy
0 ÷ 460V	1	±(3% Reading + 2 digit)

● GROUND TEST: RESISTANCE MEASUREMENT WITH EARTH RODS

Range RE [Ω]	Resolution [Ω]	Accuracy
0.01 – 19.99	0.01	±(5% Reading + 3 digit)
20.0 – 199.9	0.1	
200 - 1999	1	

Test Current < 10mA – 77.5Hz
 Open circuit Test Voltage < 20V RMS

● GROUND TEST: RESISTIVITY MEASUREMENT

Range ρ	Resolution	Accuracy
0.60 ÷ 19.99 Ωm	0.01 Ωm	±(5% Reading + 3 digit)
20.0 ÷ 199.9 Ωm	0.1 Ωm	
200 ÷ 1999 Ωm	1 Ωm	
2.00 ÷ 99.99 kΩm	0.01 kΩm	
100.0 ÷ 125.6 kΩm(*)	0.1 kΩm	

(*) setting distance = 10m
 Test Current < 10mA – 77.5Hz
 Open circuit Test Voltage < 20V RMS

14.1.2. POWER QUALITY function

● VOLTAGE MEASUREMENT – (AUTORANGE)

Range [V]	Resolution [V]	Accuracy	Input Impedance
15 ÷ 310V	0.2V	±(0.5% Reading+2digit)	300kΩ (Phase-Neutral) 300kΩ (Phase-Phase)
310 ÷ 600V	0.4V		

● VOLTAGE SAG AND SURGE DETECTION –(MANUAL RANGE)

Range [V]	Resolution (Voltage)	Resolution (Time)	Accuracy (Voltage)	Accuracy (rif. 50Hz) (Time)	Input Impedance
15 ÷ 310V	0.2V	10ms (½ period)	±(1.0% Reading+2digit)	± 10ms (½ period)	300kΩ (Phase-Neutral) 300kΩ (Phase-Phase)
30 ÷ 600V	0.4V				

● CURRENT MEASUREMENT – STD & FlexEXTclamps

Range [V]	Resolution [mV]	Accuracy	Input Impedance	Overload Protection
0.005÷0.26V	0.1	±(0.5% Reading+2digit)	200kΩ	5V
0.26÷1V	0.4			

(*) Example: with a 1000A/1V full scale clamp , the instrument detect only current higher than 5A

● CURRENT MEASUREMENT – FlexINT clamp – 1000A Range

Current Range	Input Voltage Range	Resolution	Accuracy	Input Impedance	Overload Protection
5.00 ÷ 20.00A	425μV ÷ 1.7mV	0.850μV	± (4.0%rdg + 8.5μV)	9.166kΩ	5V
20.00 ÷ 99.99A	1.7mV ÷ 8.499mV	0.850μV	± (1.0% rdg + 8.5μV)		
100.0 ÷ 999.9A	8.5mV ÷ 84.99mV	8.5μV	± (1.0% rdg + 85μV)		

● CURRENT MEASUREMENT – FlexINT clamp – 3000A Range

Current Range	Input Voltage Range	Resolution	Accuracy	Input Impedance	Overload Protection
15.00 ÷ 99.99A	1.27mV ÷ 8.499mV	0.850μV	± (1.0% rdg + 8.5μV)	9.7kΩ	5V
100.0 ÷ 270.0A	8.5mV ÷ 22.75mV	8.5μV	± (1.0% rdg + 42.5uV)		
270.0 ÷ 999.9A	22.75mV ÷ 84.99mV	8.5μV	± (1.0% rdg + 85uV)		
1.00 ÷ 3.00kA	85mV ÷ 255mV	850μV	± (0.5% rdg + 8.5mV)		

● POWER MEASUREMENT – (AUTORANGE)

Quantity	Range	Accuracy	Resolution
ACTIVE POWER	0 ÷ 999.9W	±(1.0%Reading+2digit)	0.1W
	1 ÷ 999.9kW		0.1kW
	1 ÷ 999.9MW		0.1MW
	1000 ÷ 9999MW		1MW
REACTIVE POWER	0 ÷ 999.9VAR		0.1VAR
	1 ÷ 999.9kVAR	0.1kVAR	
	1 ÷ 999.9MVAR	0.1MVAR	
	1000 ÷ 9999MVAR	1MVAR	
APPARENT POWER	0 ÷ 999.9VA	0.1VA	
	1 ÷ 999.9kVA	0.1kVA	
	1 ÷ 999.9MVA	0.1MVA	
	1000 ÷ 9999MVA	1MVA	
ACTIVE ENERGY (Classe2 EN61036)	0 ÷ 999.9Wh	0.1Wh	
	1 ÷ 999.9kWh	0.1kWh	
	1 ÷ 999.9MWh	0.1MWh	
	1000 ÷ 9999MWh	1MWh	
REACTIVE ENERGY (Classe3 IEC1268)	0 ÷ 999.9VARh	0.1VARh	
	1 ÷ 999.9kVARh	0.1kVARh	
	1 ÷ 999.9MVARh	0.1MVARh	
	1000 ÷ 9999MVARh	1MVARh	

● Cos φ MEASUREMENT

Cos φ	Resolution	Accuracy [°]
1.00 – 0.80	0.01	0.6
0.80 - 0.50		0.7
0.50 – 0.20		1.0

● VOLTANGE AND CURRENT HARMONICS MEASUREMENT

Range	Accuracy	Resolution
DC – 25H	±(5% + 2 digit)	0.1V / 0.1A
26H – 33H	±(10% + 2 digit)	
34H – 49H	±(15% + 2 digit)	

Harmonics values are null under fixed threshold:

- DC: its values is null if it is < 2%of Fundamental or is <2% of Full Scale clamp
- 1st Current Harmonic: its values is null if it is < 0.2% Full Scale clamp
- 2nd ÷ 49th : its values is null if it is < 0.5% of fundamental or is < 0.1% of Full Scale clamp

14.2. STANDARDS

14.2.1. General

Safety	EN 61010-1 + A2 (1997)
Protection classification	Class 2 - Double Insulation
Pollution degree	2
Degree of Protection:	IP50
Over-Voltage Category	CAT II 600V~ / 350V~ (phase –earth) CAT III 600V~ / 300V~ (phase –earth)
Usage:	Indoor; max height 2000m
EMC	EN61326-1 (1997) + A1 (1998)

The Instrument comply with European Guidelines for CE mark

14.2.2. Safety Test

LOW Ω (200mA):	IEC 61557-4
INSULATION TEST	IEC 61557-2
PHASE SEQUENCE:	IEC 61557-7
GROUND TEST:	IEC 61557-5

14.2.3. POWER QUALITY

Voltage Sag and Surge	EN50160
Alternating Current Static Watt-hour meters for Active Energy	EN61036 (CLASS 2)
Alternating Current Static VAR-hour meters for Reactive Energy	IEC1268 (CLASS 3)

14.3. GENERAL SPECIFICATIONS

14.3.1. Mechanical Data

Dimensions 225 (L)x165 (W) x 105 (H)mm
 Weight 1,2Kg approx

14.3.2. Power supply

Batteries 6 x 1.5-LR6-AA-AM3-MN 1500
 Battery Life: LOW Ω : ~ 800 test
 INSULATION TEST: ~ 500 test
 GROUND TEST: ~ 1000 test
 PHASE SEQUENCE: ~ 1000 test
 POWER QUALITY (recording): ~20 hours
 Code **DMT-EXTPS**

External Power Supply Adapter
 (only for POWER QUALITY function)

14.3.3. Display

Display Type Graphic with Backlight
 Resolution 128x128
 Visible Area 73mmx73mm

14.3.4. Memory

Safety Test Memory 999 measurement
 POWER QUALITY: 2MByte (with 63 channels select and
 Integration Period = 15min ->more than 30
 days).

14.4. ENVIRONMENT

Reference Temperature 23° ± 5°C
 Working Temperature Range 0° ÷ 40°C
 Working Humidity < 80%
 Storage Humidity Range -10 ÷ 60°C
 Storage Humidity < 80%

14.5. ACCESSORIES

Standard accessories

Description	Code
Set with 4 cables (2m), 4 alligator clips, 2 test leads	MTL-VOLT
Set with 4 cables (banana-banana) and 4 earth rods	MTL-EARTH
Clamp 1000A diameter 54 mm - cable 2m	DM-CT-HTA
Flexible Clamp 1000A/3000A - cable 2m	AM-Flex33
External Power Supply Adapter	DMT-EXTPS
Management Software	www.amprobe.com (Download Suite)
RS232 Optical-Serial Cable	C-2001
Carrying Case	HW1254A
User's Manual	www.amprobe.com

15. SERVICE

15.1. WARRANTY CONDITIONS

Congratulations! Your new instrument has been quality crafted according to quality standards and contains quality components and workmanship. It has been inspected for proper operation of all of its functions and tested by qualified factory technicians according to the long-established standards of our company.

Your instrument has a limited warranty against defective materials and/or workmanship for **one year** from the date of purchase provided that, in the opinion of the factory, the instrument has not been tampered with or taken apart.

Should your instrument fail due to defective materials, and/or workmanship during this **one year period, a no charge repair or replacement will be made to the original purchaser. Please have your dated bill of sale, which must identify the instrument model number and serial number and call the number listed below:**

**Repair Department
ATP – Amprobe, TIF, Promax
Miramar, FL**

**800-327-5060
Fax: 954-499-5454
Website: www.amprobe.com**

Please obtain an RMA number before returning product for repair.

Outside the U.S.A. the local representative will assist you. Above limited warranty covers repair and replacement of instrument only and no other obligation is stated or implied.

15.2. SERVICE

If the instrument does not operate properly, before contacting the after-sales service check cables as well as test leads and replace them if necessary.

Should the instrument still operate improperly check that the operation procedure is correct and conforms with the instructions given in this manual.

If the instrument is to be returned to the after-sales service or to a dealer transportation costs are on the customer's behalf. Shipment shall be however agreed upon.

A report must always be enclosed to a rejected product stating the reasons of its return.

To ship the instrument use only the original packaging material; any damage that may be due to no-original packing shall be charged to the customer.

16. PRACTICAL REPORTS FOR ELECTRICAL TESTS

16.1. Continuity Test On Protective Conductors

PURPOSE OF THE TEST

- Check the continuity of:
- ☞ protective conductors (PE), main equalising potential conductors (EQP), secondary equalising potential conductors (EQS) in TT and TN-S systems.
 - ☞ neutral conductors having functions of protective conductors (PEN) in TN-C system.

NOTE: This test is to be preceded by a visual check verifying the existence of yellow-green protective and equalizing potential conductors as well as compliance of the sections used with the standards' requirements.

INSTALLATION PARTS TO BE CHECKED

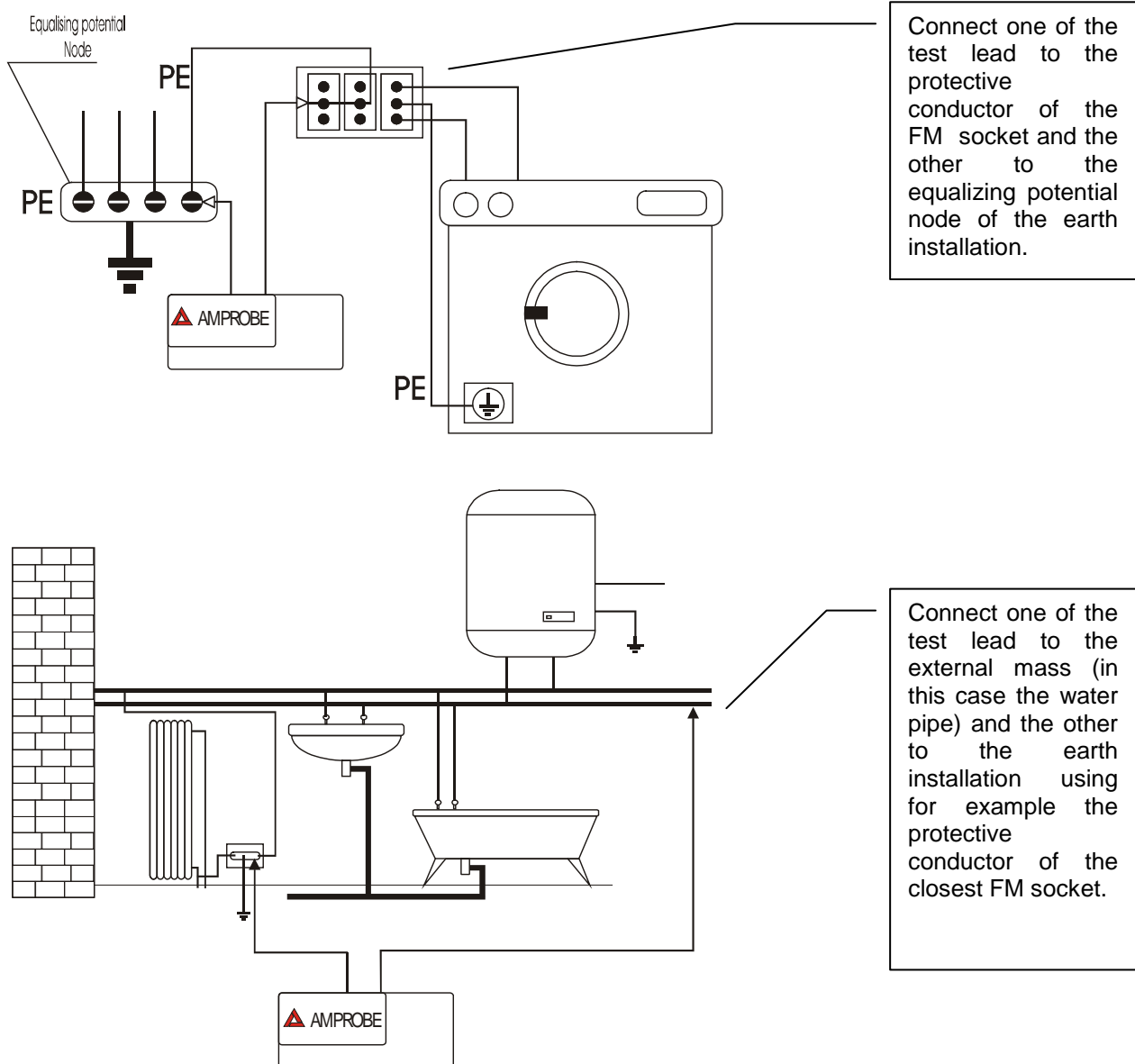

Examples for continuity measurement on conductors

Check the continuity among:

- a) Earth poles of **all** the plugs and earth collector or node.
- b) Earth terminals of class I instruments (Boiler etc.) and earth collector or node.
- c) Main external masses (water, gas pipes etc.) and earth collector or node.
- d) Auxiliary external masses to the earth terminal.

ALLOWABLE VALUES

The standards CEI 64-8/6 do not give any indication on the maximum resistance values that cannot be overcome, in order to be able to declare the positive outcome of the continuity test.

The standard CEI 64-8/6 simply requires that the instrument in use warn the operator if the test was not carried out with a **current of at least 0.2 A** and an **open circuit voltage ranging from 4 V to 24 V**.

The resistance values can be calculated according to the sections and lengths of the conductors under test, anyway if the instrument detects values of some ohm the test can be considered as passed.

16.2. Check of the Circuit Separation

PURPOSE OF THE TEST

The test, to be effected in case the protection is realized through separation (64-8/6 612.4, SELV or PELV or electrical separation), shall check that the insulation resistance measured according to the indications below (depending on the separation type) complies with the limits reported in the table relative to the insulation measurements.

☞ INSTALLATION PARTS TO BE CHECKED

- **SELV** system (Safety Extra Low Voltage):
 - ✓ Measure the resistance between the active parts of the circuit under test (separate) and the active parts of the other circuits.
 - ✓ Measure the resistance between the active parts of the circuit under test (separate) and the ground.

The resistance shall not be lower than 0.25MΩ with a test voltage of 250VDC.

- **PELV** system (Protective Extra Low Voltage):
 - ✓ Measure the resistance between the active parts of the circuit under test (separate) and the active parts of the other circuits.

The resistance shall not be lower than 0.25MΩ with a test voltage of 250VDC.

- **Electrical separation:**
 - ✓ Measure the resistance between the active parts of the circuit under test (separate) and the active parts of the other circuits.
 - ✓ Measure the resistance between the active parts of the circuit under test (separate) and the ground.

The resistance shall not be lower than 0.5MΩ with a test voltage of 500VDC and 1MΩ with a test voltage of 1000VDC.

EXAMPLE OF CHECKING THE SEPARATION AMONG ELECTRICAL CIRCUITS

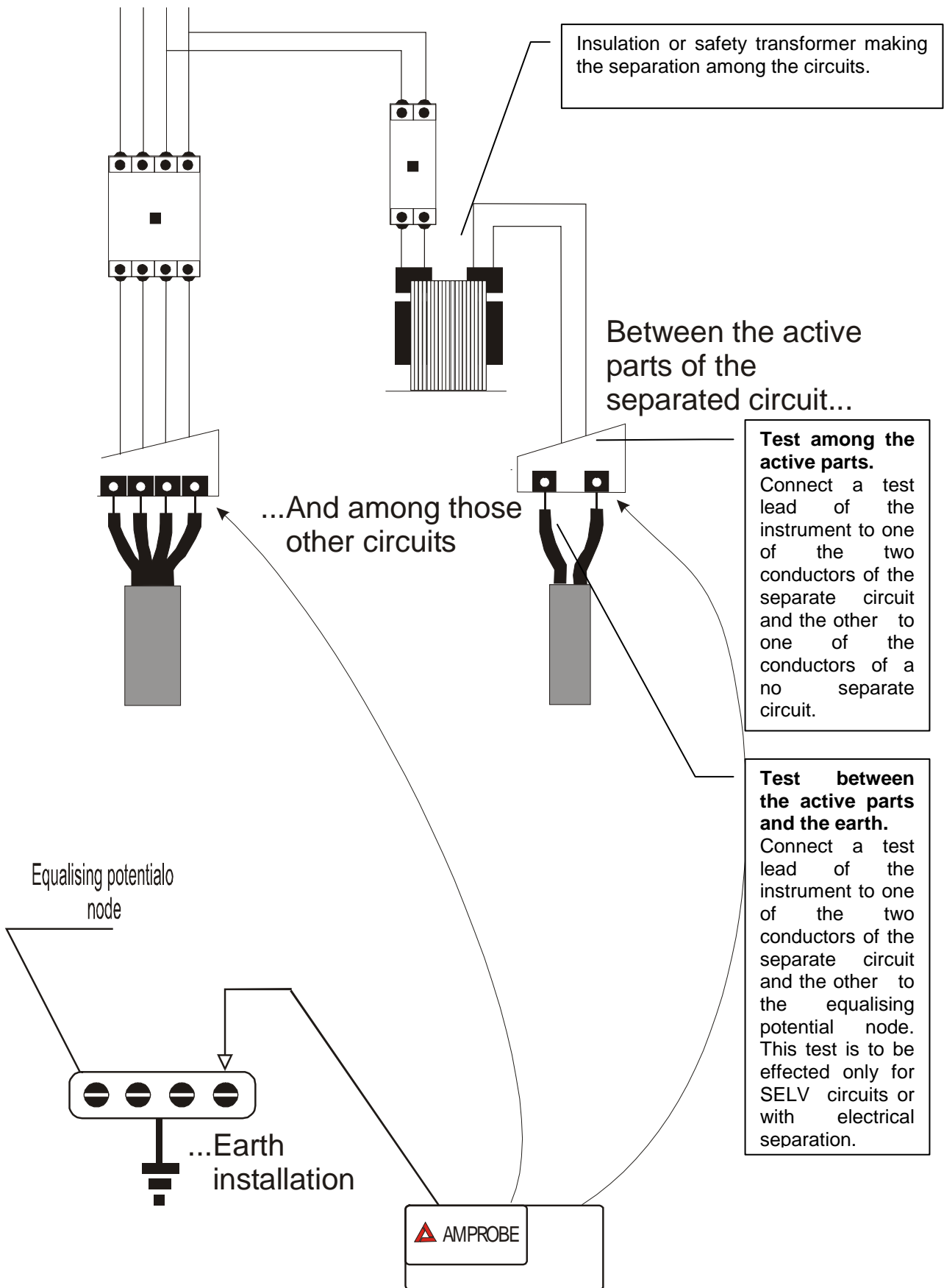

Measurement of separation among the installation circuits

ALLOWABLE VALUES

The test result is positive when the insulation resistance indicates values higher or equal to those indicated in the table reported in the section relative to insulation tests.

Notes:

- **SELV** system: is a system of category zero or very low safety voltage featured by:
 - ✓ Power supply: autonomous source (ex. batteries, small generator) or safety (ex. safety transformer).
 - ✓ Protection separation to other electrical systems (double or reinforced insulation or a metal screen connected to the ground).
 - ✓ There are no earthed points (insulated from the ground).

- **PELV** system: is a system of category zero or very low safety voltage featured by:
 - ✓ Power supply: autonomous source (ex. batteries, small generator) or safety (ex. safety transformer).
 - ✓ Protection separation to other electrical systems (double or reinforced insulation or a metal screen connected to the ground).
 - ✓ There are earthed points (not insulated from the ground).

- **Electrical separation**: is a system featured by:
 - ✓ Power supply: insulation transformer or autonomous source with equivalent features (ex. generator).
 - ✓ Protection separation to other electrical systems (insulation not lower than that of the insulation transformer).
 - ✓ Protection separation to the ground (insulation not lower than that of the insulation transformer).

16.3. Measurement Of Floor Insulation Resistance In Medical Rooms Cei 64-4

PURPOSE OF THE TEST

Check that the floor is made of material whose insulation resistance complies with the requirements of the standards CEI 64-4 (3.05.03).

INSTALLATION PARTS TO BE CHECKED

The test shall be effected between:

- a) Two electrodes whose distance to each other shall be one meter.
- b) One electrode on the floor and the equalising potential node.

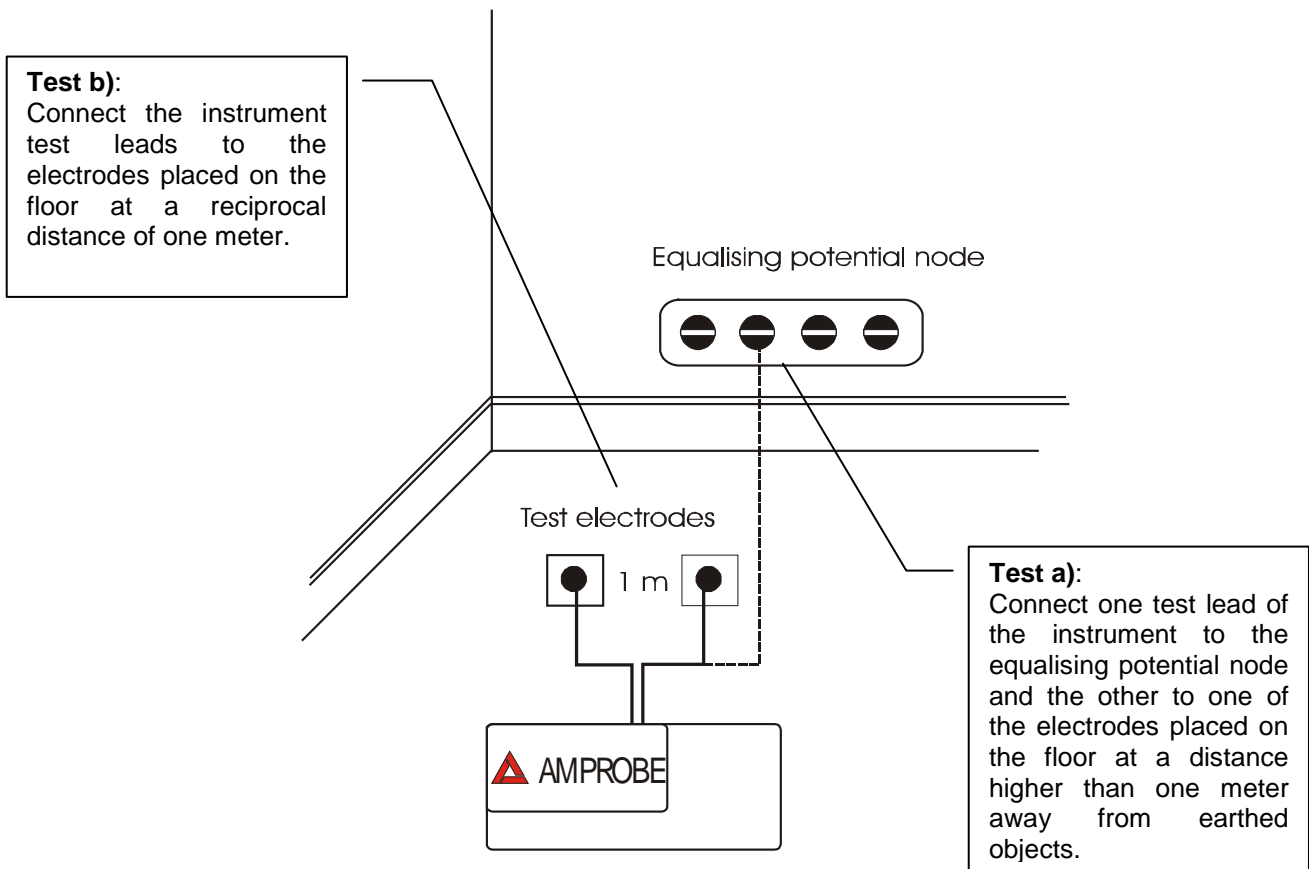

Measurements of floor insulation resistance in medical rooms

The electrodes shall consist of a plate having a surface of 20 cm², weight equal to approx. 1 Kg (10N), and a humid absorbing paper (or humid thin cotton cloth) with the same surface placed between the metal plate and the floor.

The insulation resistance is represented, both for the measurements indicated in "a" and for the measurements indicated in "b", by the average of 5 or more tests effected in different positions at a distance higher than 1 m away from grounded objects.

ALLOWABLE VALUES

The maximum values of the calculated resistance are the following:

- **1 M Ω** for measurements effected on a new floor.
- **100 M Ω** for the periodical tests effected after the first year after the floor construction and for the periodical check every 4 year.

All the values shall be registered on a protocol of the initial tests (64-4 5.1.02) and, for the periodical controls, on the register of periodical tests (64-4 5.2.02).

16.4. Ground Resistance Measurement

PURPOSE OF THE TEST

Check if the Automatic protection is coordinated with the ground resistance value. It is not possible to assume a ground resistance value as reference limit when controlling the test result, while it is necessary to check every time that the co-ordination complies with the requirements of the standards.

INSTALLATION PARTS TO BE CHECKED

The ground installation under working conditions. The check is to be effected without disconnecting the earth plates.

Method for small earth plant

Let current circulate between the earth rod and a current probe positioned at a distance corresponding to fivefold the diagonal of the area delimiting the earth equipment. Position the voltage probe at half-way between the earth rod and the current probe, then measure the voltage between the two.

Use several rods in parallel and moisten the surrounding ground if the instrument does not manage to supply the current necessary to perform the test because of an high earth resistance.

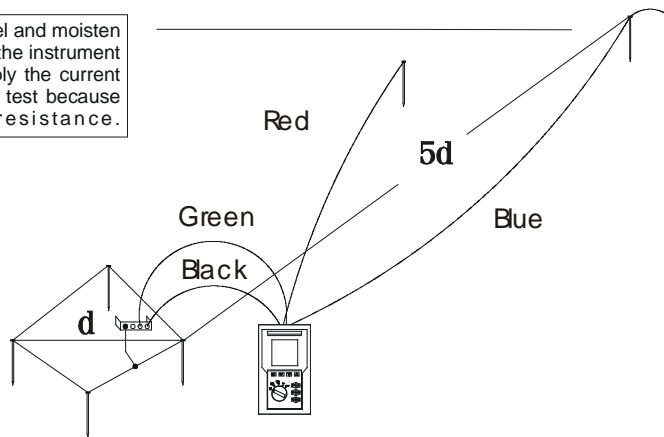

Ground resistance measurement for small Ground plant

Method for big Ground plant

Also this procedure is based on the voltamperometric method, but it's mainly used when it's difficult to position the auxiliary current rod at a distance corresponding to fivefold the diagonal of the area of the earth equipment. Position the current probe at a distance equal to the diagonal of the area of the earth equipment. To make sure that the voltage probe is positioned outside the area affected by the rod under test, take more measurements, first positioning the voltage probe at half-way between the rod and the current probe, then moving the probe both towards the earth rod and towards the current probe.

Use several rods in parallel and moisten the surrounding ground if the instrument does not manage to supply the current necessary to perform the test because of an high earth resistance.

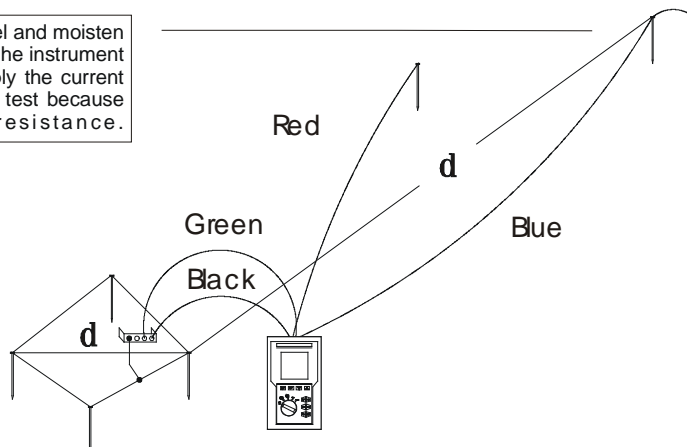

16.5. Ground Resistivity Measurement

PURPOSE OF THE TEST

This test analyzes the resistivity value of the ground in order to define the type of rods to use.

EQUIPMENT PARTS TO BE TESTED

For the resistivity test admissible values do not exist. The various values measured by positioning the rods at growing distances “a” must be quoted in a graph. According to the resulting curve, suitable rods will be chosen. The test result can be affected by metal parts buried underground (e.g. pipes, cables or other rods), in case of doubts take a second measurement positioning the rods at an equal distance “a”, but rotating their axis by 90°.

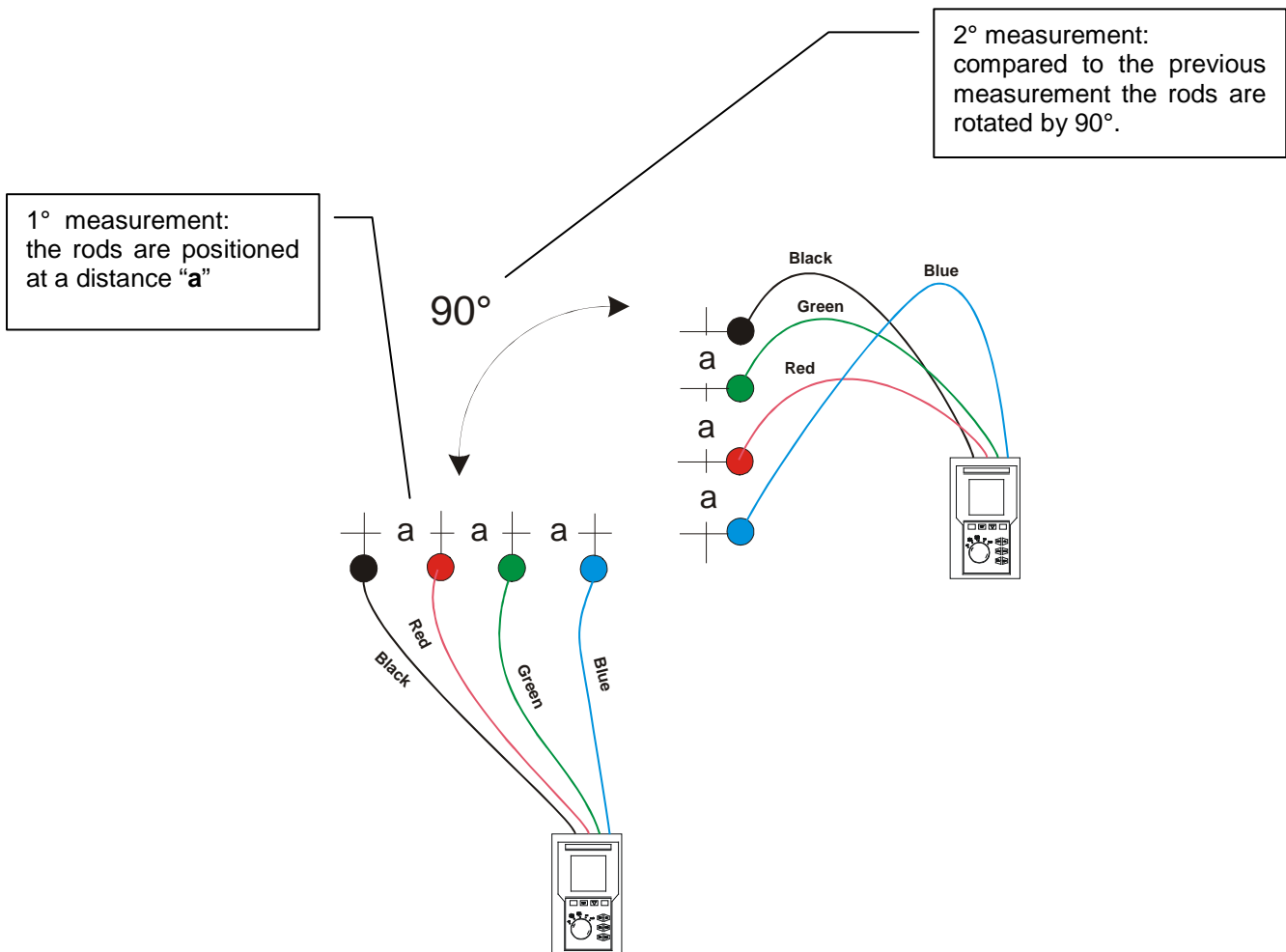

The resistivity value is calculated with the following formula:

$$\rho = 2\pi aR$$

Where: ρ = specific resistivity of the ground
 a = distance between the rods (m)
 R = resistance measured by the instrument (Ω)

The measuring method allows the operator to define the specific resistance up to the depth corresponding approximately to the distance "a" between the rods. If you increase the distance "a" you can reach deeper ground layers and check the ground homogeneity. After several ρ measurements, at growing distances "a", you can trace a profile like the following ones, after which the most suitable rod is chosen:

Curve1: as ρ decreases only in depth, it's possible to use only a rod in depth.

Curve2: as ρ decreases only until the depth A, it's not useful to increase the depth of the rod beyond A.

Curve3: even at an increased depth, ρ does not decrease, therefore a ring rod must be used.

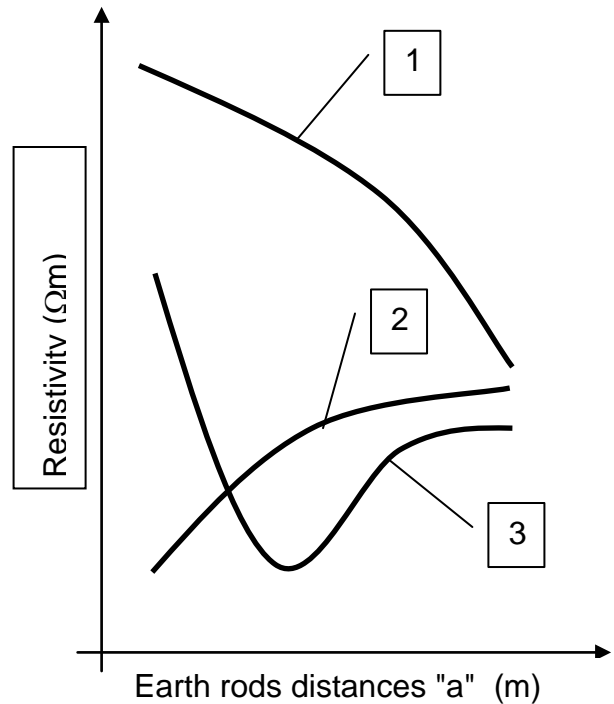

APPROXIMATE EVALUATION OF THE CONTRIBUTION OF INTENTIONAL RODS (64-12 2.4.1)

The resistance of a rod R_d can be calculated with the following formulas (ρ = medium resistivity of the ground).

a) Resistance of a vertical rod

$$R_d = \rho / L$$

L= length of the element touching the ground

b) Resistance of an horizontal rod

$$R_d = 2\rho / L$$

L= length of the element touching the ground

c) Resistance of linked elements

The resistance of a complex system with more elements in parallel is always higher than the resistance that could result from a simple calculation of elements in parallel, especially if those elements are close and therefore interactive. For this reason, in case of a linked system the following formula is quicker and more effective than the calculation of the single horizontal and vertical elements:

$$R_d = \rho / 4r$$

r= radius of the circle which circumscribes the link.

16.6. VOLTAGE ANOMALIES (VOLTAGE SAG AND SURGE)

The Multitest 2000 is able to record as voltage anomalies all those rms values, calculated every 10ms, beyond the percent thresholds of Voltage Reference (Vref) set during the programming from 3% to 30 % (with step of 1%).

The Reference must be set to:

Nominal Voltage Phase to Neutral: for Single Phase and 4 wires three phase system

Nominal Voltage Phase to Phase: for 3 wires three phase system

Example1: Three Phase System 3 wires.

Vref = 400V, LIM+= 6%, LIM-=10% =>

High Lim = 400 x (1+6/100) = 424,0V

Low Lim = 400 x (1-10/100) = 360

Example2: Three Phase System 4 wires.

Vref = 230V, LIM+= 6%, LIM-=10% =>

High Lim = 230 x (1+6/100) = 243,08V

Low Lim = 230 x (1-10/100) = 207,0V

The instrument will detect Voltage Anomalies if the RMS Voltage Values (calculated every 10ms) beyond the above calculated thresholds. These limits remain unchanged throughout the recording period.

When a Voltage anomaly occurs the instrument records:

- The number corresponding to the phase where the anomaly occurred.
- The "direction" of the anomaly: "Surge" and "Sag" identify respectively voltage drops (Sag) and peaks (Surge).
- The date and time of the beginning of the event in the form day, month, year, hour, minutes, seconds, hundredths of second.
- The duration of the event, in seconds with a resolution of 10ms.
- The minimum (or maximum) value of voltage during the event.

16.7. VOLTAGE AND CURRENT HARMONICS

16.7.1. Theory

Any periodical non-sine wave can be represented as a sum of sinusoidal waves having each a frequency that corresponds to an entire multiple of the fundamental, according to the relation:

$$v(t) = V_0 + \sum_{k=1}^{\infty} V_k \sin(\omega_k t + \varphi_k) \quad (1)$$

where:

V_0 = Average value of $v(t)$

V_1 = Amplitude of the fundamental of $v(t)$

V_k = Amplitude of the k^{th} harmonic of $v(t)$

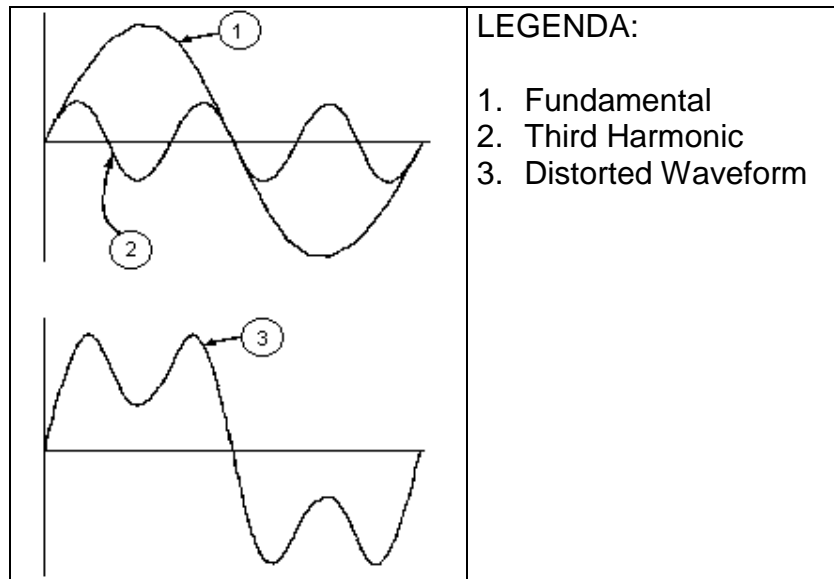

Effect of the sum of 2 multiple frequencies.

In the mains voltage, the fundamental has a frequency of 60 Hz, the second harmonic has a frequency of 120 Hz, the third harmonic has a frequency of 180 Hz and so on. Harmonic distortion is a constant problem and should not be confused with short events such as sags, surges or fluctuations.

It can be noted that in (1) the index of the sigma is from 1 to the infinite. What happens in reality is that a signal does not have an unlimited number of harmonics: a number always exists after which the harmonics value is negligible. The EN 50160 standard recommends stopping the index in the expression (1) in correspondence of the 40th harmonic.

A fundamental element to detect the presence of harmonics is THD defined as:

$$THD_v = \frac{\sqrt{\sum_{h=2}^{40} V_h^2}}{V_1}$$

This index takes all the harmonics into account. The higher it is, the more distorted the waveform gets.

16.7.2. Limit values for harmonics

EN-50160 fixes the limits for the harmonic voltages, which can be introduced into the network by the power supplier. In normal conditions, during whatever period of a week, 95% of the RMS value of each harmonic voltage, mediated on 10 minutes, will have to be less than or equal to the values stated in the following table.

The total harmonic distortion (THD) of the supply voltage (including all the harmonics up to 40th order) must be less than or equal to 8%.

Odd harmonics				Even harmonics	
Not multiple of 3		Multiple of 3		Order h	Relative voltage %Max
Order h	Relative voltage % Max	Order h	Relative voltage % Max		
5	6	3	5	2	2
7	5	9	1,5	4	1
11	3,5	15	0,5	6..24	0,5
13	3	21	0,5		
17	2				
19	1,5				
23	1,5				
25	1,5				

These limits, theoretically applicable only for the supplier of electric energy, provide however a series of reference values within which the harmonics introduced into the network by the users must be contained.

16.7.3. Presence of harmonics: causes

Any apparatus that alters the sine wave or uses only a part of such a wave causes distortions to the sine wave and therefore harmonics.

All current signals result in some way virtually distorted. The most common situation is the harmonic distortion caused by non-linear loads such as electric household appliances, personal computers or speed control units for motors. Harmonic distortion causes significant currents at frequencies that are odd multiples of the fundamental frequency. Harmonic currents affect considerably the neutral wire of electric installations.

In most countries, the mains power is three-phase 50/60Hz with delta primary and star secondary transformers. The secondary generally provides 230V AC from phase to neutral and 400V AC from phase to phase. Balancing the loads on each phase has always represented a headache for electrical systems designers.

Until some ten years ago, in a well-balanced system, the vectorial sum of the currents in the neutral was zero or quite low (given the difficulty of obtaining a perfect balance). The devices were incandescent lights, small motors and other devices that presented linear loads. The result was an essentially sinusoidal current in each phase and a low current on the neutral at a frequency of 50/60Hz.

“Modern” devices such as TV sets, fluorescent lights, video machines and microwave ovens normally draw current for only a fraction of each cycle thus causing non-linear loads and subsequent non-linear currents. All this generates odd harmonics of the 50/60Hz line frequency. For this reason, the current in the transformers of the distribution boxes contains only a 50Hz (or 60Hz) component but also a 150Hz (or 180Hz) component, a 50Hz (or 300Hz) component and other significant components of harmonic up to 750Hz (or 900Hz) and higher.

The vectorial sum of the currents in a well-balanced system that feeds non-linear loads may still be quite low. However, the sum does not eliminate all current harmonics. The odd multiples of the third harmonic (called “TRIPLENS”) are added together in the neutral and can cause overheating even with balanced loads.

16.7.4. Presence of harmonics: consequences

In general, even harmonics, i.e. the 2nd, 4th etc., do not cause problems. Triple harmonics, odd multiples of three, are added on the neutral (instead of cancelling each other) thus creating a condition of overheating of the wire, which is extremely dangerous.

Designers should take into consideration the three issues given below when designing a power distribution system that will contain harmonic current:

- The neutral wire must be of sufficient gauge.
- The distribution transformer must have an additional cooling system to continue operating at its rated capacity when not suited to the harmonics. This is necessary because the harmonic current in the neutral wire of the secondary circuit circulates in the delta-connected primary circuit. This circulating harmonic current heats up the transformer.
- Phase harmonic currents are reflected on the primary circuit and continue back to the power source. This can cause distortion of the voltage wave so that any power factor correction capacitors on the line can be easily overloaded.

The 5th and the 11th harmonic contrast the current flow through the motors making its operation harder and shortening their average life.

In general, the higher the ordinal harmonic number, the smaller its energy is and therefore the impact it will have on the devices (except for transformers).

16.8. POWER AND POWER FACTOR DEFINITION

In a standard electric installation powered by three sine voltages the following is defined:

Phase Active Power: (n=1,2,3)	$P_n = V_{nN} \cdot I_n \cdot \cos(\varphi_n)$
Phase Apparent Power: (n=1,2,3)	$S_n = V_{nN} \cdot I_n$
Phase Reactive Power: (n=1,2,3)	$Q_n = \sqrt{S_n^2 - P_n^2}$
Phase Power Factor: (n=1,2,3)	$P_{Fn} = \frac{P_n}{S_n}$
Total Active Power:	$P_{TOT} = P_1 + P_2 + P_3$
Total Reactive Power:	$Q_{TOT} = Q_1 + Q_2 + Q_3$
Total Apparent Power:	$S_{TOT} = \sqrt{P_{TOT}^2 + Q_{TOT}^2}$
Total Power Factor:	$P_{FTOT} = \frac{P_{TOT}}{S_{TOT}}$

where:

V_{nN} = RMS value of voltage between phase n and Neutral.

I_n = RMS value of n phase current.

φ_n = Phase displacement angle between voltage and current of n phase.

In presence of distorted voltages and currents the previous relations vary as follows:

Phase Active Power: (n=1,2,3)	$P_n = \sum_{k=0}^{\infty} V_{k_n} I_{k_n} \cos(\varphi_{k_n})$
Phase Apparent Power: (n=1,2,3)	$S_n = V_{nN} \cdot I_n$
Phase Reactive Power: (n=1,2,3)	$Q_n = \sqrt{S_n^2 - P_n^2}$
Phase Power Factor: (n=1,2,3)	$P_{F_n} = \frac{P_n}{S_n}$
Distorted Power Factor (n=1,2,3)	dPF _n =cosε _{1n} = phase displacement between the fundamentals of voltage and current of n phase
Total Active Power:	$P_{TOT} = P_1 + P_2 + P_3$
Total Reactive Power:	$Q_{TOT} = Q_1 + Q_2 + Q_3$
Total Apparent Power:	$S_{TOT} = \sqrt{P_{TOT}^2 + Q_{TOT}^2}$
Total Power Factor:	$P_{F_{TOT}} = \frac{P_{TOT}}{S_{TOT}}$

where:

V_{kn} = RMS value of kth voltage harmonic between n phase and Neutral.

I_{kn} = RMS value of kth current harmonic of n phase.

ε_{kn} = Phase displacement angle between kth voltage harmonic and kth current harmonic of n phase.

Note:

It is to be noted that the expression of the phase Reactive Power with non sine waveforms, would be wrong. To understand this, it may be useful to consider that both the presence of harmonics and the presence of reactive power produce, among other effects, an increase of line power losses due to the increased current RMS value. With the above given relation the increasing of power losses due to harmonics is added to that introduced by the presence of reactive power. In effect, even if the two phenomena contribute together to the increase of power losses in line, it is not true in general that these causes of the power losses are in phase between each other and therefore that can be added one to the other mathematically.

The above given relation is justified by the relative simplicity of calculation of the same and by the relative discrepancy between the values obtained using this relation and the true value.

It is to be noted moreover, how in case of an electric installation with harmonics, another parameter called distorted Power Factor (dPF) is defined. In practice, this parameter represents the theoretical limit value that can be reached for Power Factor if all the harmonics could be eliminated from the electric installation.

16.8.1. Conventions on powers and power factors

As for the recognition of the type of reactive power, of the type of power factor and of the direction of the active power, the below conventions must be applied. The stated angles are those of phase-displacement of the current compared to the voltage (for example, in the first panel the current is in advance from 0° to 90° compared to the voltage):

Equipment under test = Inductive Generator ←		90°	→ Equipment under test = Capacitive Load	
	$P+ = 0$	$P- = P$	$P+ = P$	$P- = 0$
	$Pfc+ = -1$	$Pfc- = -1$	$Pfc+ = Pf$	$Pfc- = -1$
	$Pfi+ = -1$	$Pfi- = Pf$	$Pfi+ = -1$	$Pfi- = -1$
	$Qc+ = 0$	$Qc- = 0$	$Qc+ = Q$	$Qc- = 0$
	$Qi+ = 0$	$Qi- = Q$	$Qi+ = 0$	$Qi- = 0$
180°			0°	
	$P+ = 0$	$P- = P$	$P+ = P$	$P- = 0$
	$Pfc+ = -1$	$Pfc- = Pf$	$Pfc+ = -1$	$Pfc- = -1$
	$Pfi+ = -1$	$Pfi- = -1$	$Pfi+ = Pf$	$Pfi- = -1$
	$Qc+ = 0$	$Qc- = Q$	$Qc+ = 0$	$Qc- = 0$
	$Qi+ = 0$	$Qi- = 0$	$Qi+ = Q$	$Qi- = 0$
Equipment under test = Capacitive Generator ←		270°	→ Equipment under test = Inductive Load	

where:

Symbol	Significance	Remarks
P+	Value of the active power +	Positive parameter (user)
Pfc+	Capacitive power factor +	
Pfi+	Inductive power factor +	
Qc+	Value of the capacitive reactive power +	
Qi+	Value of the inductive reactive power +	
P-	Value of the active power -	Negative parameter (generator)
Pfc-	Capacitive power factor -	
Pfi-	Inductive power factor -	
Qc-	Value of the capacitive reactive power -	
Qi-	Value of the inductive reactive power -	

Value	Significance
P	The active power (positive or negative) is defined in the panel and therefore acquires the value of the active power in that moment.
Q	The reactive power (inductive or capacitive, positive or negative) is defined in the panel and therefore acquires the value of the reactive power in that moment.
Pf	The power factor (inductive or capacitive, positive or negative) is defined in the panel and therefore acquires the value of the power factor in that moment.
0	The active power (positive or negative) or the reactive power (inductive or capacitive, positive or negative) is NOT defined in the panel and therefore acquires a null value.
-1	The power factor (inductive or capacitive, positive or negative) is NOT defined in the panel.

16.8.2. 3 Phase 3 Wire System

In the electrical systems distributed without neutral, the phase voltages and the power factors and phase $\cos\phi$ lose importance. Only the phase-to-phase voltages, the phase currents and the total powers remain defined.

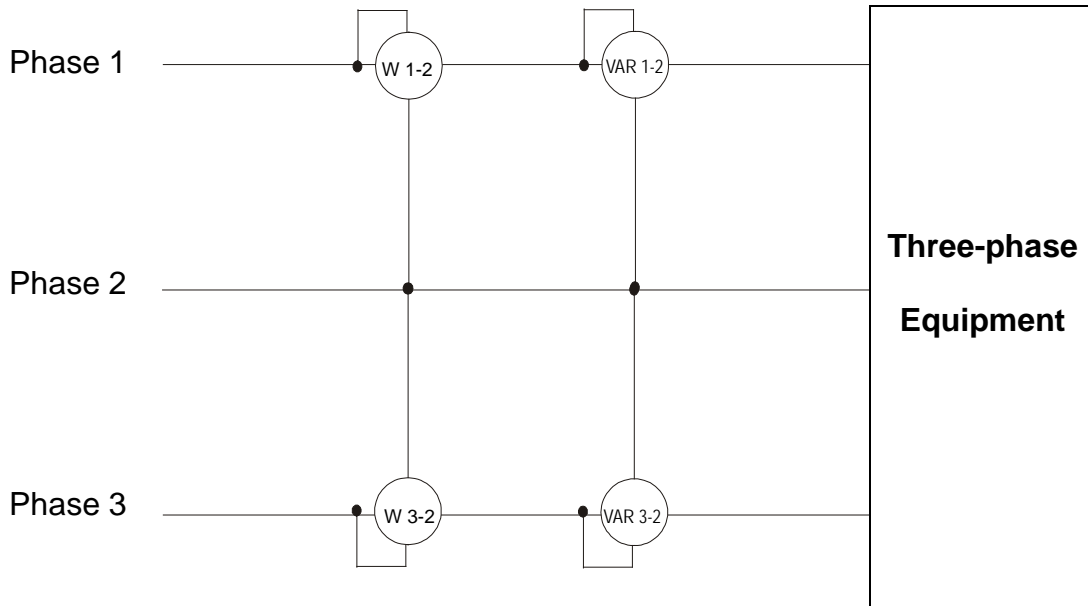

In this case the potential of one of the three phases (for example, phase 2) is taken on as reference potential. The total values of the active, reactive and apparent power are expressed as sum of the indications of the couples of Wattmeters, VARmeters and VAmeters.

$$P_{TOT} = W_{1-2} + W_{3-2}$$

$$Q_{TOT} = VAR_{1-2} + VAR_{3-2}$$

$$S_{TOT} = \sqrt{(W_{1-2} + W_{3-2})^2 + (VAR_{1-2} + VAR_{3-2})^2}$$

16.9. MEASURING METHOD: OUTLINES

The instrument is able to measure: voltages, currents, active powers, inductive and capacitive reactive powers, apparent powers, inductive and capacitive power factors, analogic or impulse parameters. All these parameters are analyzed in a digital way: for each phase (voltage and current), 6 x 128 samples are acquired on a module of 16 x 20ms, repeated for the three phases.

16.9.1. Integration periods

The storage of all the data would require a huge memory capacity.

Therefore we've tried to find out a storage method that compresses the information to be memorized, while providing significant data.

The chosen method is that of integration: after a certain period called "integration period", which can be set from 5 seconds to 60 minutes (3600sec), the instrument extracts from the sampled values the following data:

- Minimum value of the parameter during the integration period (harmonics excluded)
- Medium value of the parameter (intended as arithmetic average of all the values registered during the integration period)
- Maximum value of the parameter during the integration period (harmonics excluded)

Only this information (repeated for each parameter to be memorised) is saved in the memory along with starting time and date of the integration period.

Once these data are memorized, the instrument restarts to take measurements for a new period.

16.9.2. Power factor calculations

According to the standards in force, the medium power factor can't be calculated as average of the instantaneous power factors. It must be obtained from the medium values of active and reactive power.

Each single medium power factor (of phase or total) is therefore calculated, at the end of each integration period, on the medium value of the corresponding powers independently on the fact that they must be registered or not.

Besides, for a better analysis of the type of load present on the line and in order to have terms of comparison when studying the invoicing of the low $\cos\phi$, the values of inductive and capacitive $\cos\phi$ are treated as independent parameters.

16.9.3. Voltage Anomalies and Periods Analysis comparison

If You want to compare Voltage Anomaly and Periods Analysis results You should note that::

1. Voltage anomalies calculate RMS values over 10ms time while Periods Analysis calculate MAX, MIN, RMS value over a module of 16 waveforms (16 x 16.66ms = 0.266ms). This generally implicates different values between Voltage Anomalies and Periods Analysis results because the "Integration" time is different.

Example:

Integration Time = 60sec

If Your signal consists of 3600 waveforms (7200 half waveforms) and only the first half waveform reach 246,6V while 7199 half waveforms stay at 240.6V You will get:

Voltage anomaly = 246.6V

Max of Periods analysis = 240.79V

AVG of Periods analysis = 240.6008V

MIN of Periods analysis = 240.6V

2. The Voltage anomalies routine "starts" a Voltage anomaly if the RMS value (calculated over 10ms) is over/under the High/low Threshold and "stops" it when the RMS value (calculated over 10ms) is under/over the High/low Threshold +/- 3% of Threshold (where 3% is a fixed percentage of High / Low threshold which introduces a hysteresis between "Start" and "Stop" voltage values).

Example: $V_{ref} = 230V \pm 6\% \rightarrow$

High Threshold for start = 243.8, High Threshold for stop: = $243.8 - 7.3 = 236.5V$.

Low Threshold for start = 216.2, Low Threshold for stop: = $216.2 + 6.5 = 222.7V$.

3. The voltage anomalies routine informs you about:
- Starting time of the Voltage anomaly
 - Duration
 - Extreme RMS value (calculated over 10ms) during the whole Voltage anomaly.

Example: a voltage anomaly of

Extreme = 246.6V

Duration = 20244,09s

means that:

i): during 20244,09s the RMS voltage value reached 246,6 for 10ms

ii): during 20244,09s the RMS voltage value (calculated over 10ms) was over 236.5V (High Threshold for stop)

4. Both Voltage anomalies routine and Periods routines have an accuracy of +/- (0.5% rdg + 2dgt). As the routines, the calculation, rounding, etc are different in order to compare the results, You should consider a double global uncertainty. So theoretically a nominal voltage of 245.2V could become:
- 246,6V ($245.2 + 1.433$) measured by Voltage Anomalies routine
 - 243.7V ($245.2 - 1.433$) measured by Periods Analysis routine.

17. APPENDIX 1 – MESSAGES DISPLAYED

Message	Description	Advices 
AUTONOM:	Available memory autonomy for the recording which is being effected	
CLEAR ALL? (Enter)	The operator is trying to cancel all the recordings effected	Press ESC in order not to cancel the whole memory, press ENTER to confirm
CLEAR LAST? (Enter)	The operator is trying to cancel the last recording effected	Press ESC in order not to cancel the last recording, press ENTER to confirm
Data saved	The data have been saved	
DATA SIZE:	Dimensions of the stored data	
HOLD	By pressing the proper key, the HOLD function has been activated	Press HOLD again to disable this function
Password:	A recording has been started and at least 5 minutes have passed from the last activity of the instrument (see paragraph 7.1.6).	Insert the password: F1, F4, F3, F2
Invalid date	The inserted date is not correct	Check the inserted date
Energy Measuring	The instrument is taking an energy measurement	Press F1 to stop it
Memory Full	The memory of the instrument is full	Cancel some recordings after transferring them to a PC
No ext supply!	A recording has been started without connecting the external power supply (optional code A0051)	Verify if you really want to start the recording without the external power supply. In that case press START again.
No parameter sel	A recording has been started without selecting any value to be recorded	Press START/STOP and select at least a value entering the MENU
No Phase selected	Voltage and/or current harmonics have been selected and the corresponding flag has been enabled (HARMONICS ON) but no phase voltage or current has been selected	Select at least one phase voltage and/or current
PASSWORD ERROR	The inserted password is wrong (see paragraph 10.3).	Check the password
PASSWORD OK	The inserted password is correct	
Please wait	The instrument is waiting for the recording to be started (see paragraph 10.1)	
Recording	The instrument is recording (see paragraph 10.2)	
Too many param	More than 63 parameters have been selected (harmonics included) or More than 38 parameters with CO-GENERATION Flag enabled	Deselect some values
Too many records	The quantity of recorded data + Smp exceeds the maximum allowed (35)	Cancel some recordings after transferring them to a PC
No Unit selected		
ERR: SEQ	The Phase Sequence isn't correct.	Check the Phase Sequence connection.
ERR: P-	The active powers shown on the right side of the message are negative	If there isn't a situation of co-generation check if the clamps are properly connected
ERR: SEQ & P-	The active powers shown on the right side of the message are negative and the Phase Sequence isn't correct.	If there isn't a situation of co-generation check if the clamps are properly connected / check the Phase Sequence connection.
ERR: CONNECTION	The instrument has detected a wrong connection to Voltage inputs	Check the Voltage connections
Error Vref	The user set a Voltage reference not compatible with voltage at instrument's input.	Check Voltage Reference set in "CONFIG RECORDER"
ERR: SYNC	The System Frequency is out of range	Check the System Frequency, check setting in ANALYZER CONFIG.
Error1 ÷ Error 5		Contact assistance

18. APPENDIX 2 – RECORDABLE PARAMETERS: SYMBOLS

Symbol	Description
V1, V2, V3	RMS value of the voltage of phase 1, phase 2, phase 3 respectively
V12, V23 V31	Value of phase to phase voltages
I1, I2, I3	RMS value of the current of phase 1, phase 2, phase 3 respectively
IN	RMS value of the current of the neutral
DC	Continuous component of voltage or current
h01 ÷ h49	Harmonic 01 ÷ Harmonic 49 of voltage or current
ThdV	Factor of total harmonic distortion of the voltage (see paragraph 16.7)
ThdI	Factor of total harmonic distortion of the current (see paragraph 16.7)

Pt, P1, P2, P3	Values of the total active power, of phase 1, phase 2, phase 3 respectively
P12, P32	(only for 3 wires measurement) Value of the power measured by the Wattmeter 1-2 and 3-2 respectively (see paragraph 16.8.2).
Qt, Q1, Q2, Q3	Values of the total reactive power, of phase 1, phase 2, phase 3 respectively
Q12, Q32	(only for 3 wires measurement) Value of the power measured by the VARmeter 1-2 and 3-2 respectively (see paragraph 16.8.2).
St, S1, S2, S3	Values of the total apparent power, of phase 1, phase 2, phase 3 respectively
S12, S32	(only for 3 wires measurement) Value of the power measured by the VAmeter 1-2 and 3-2 respectively (see paragraph 16.8.2).
Pft, pf1, pf2, pf3	Value of the total power factors, power factors of phase 1, phase 2, phase 3 respectively
dPft, dpf1, dpf2, dpf3	Values of the total $\cos\phi$, of phase 1, phase 2, phase 3 respectively

Eat, Ea1, Ea2, Ea3	Values of the total active energy, of phase 1, phase 2, phase 3 respectively
Erit, Eri1, Eri2, Eri3	Values of the total inductive reactive Energy, of phase 1, phase 2, phase 3 respectively
Erct, Erc1, Erc2, Erc3	Values of the total capacitive reactive Energy, of phase 1, phase 2, phase 3 respectively
Est, Es1, Es2, Es3	Values of the total Apparent Energy, of phase 1, phase 2, phase 3 respectively



Miramar, FL
Phone: 954-499-5400
Fax: 954-499-5454
www.amprobe.com