

**Infrared thermometer
for measurement of
smallest temperature
differences of 0.025 °C
(32.05 °F)**

Features:

- New benchmark in low noise IR-thermometry
- Suitable for relative measurement of smallest temperature differences of 0.025 °C (32.05 °F)
- Touches the physical limits ensuring low ambient temperature drift
- Green LED alarm indication, aiming support, self diagnostic or temperature code indication
- Complete solid state design without any moving parts
- Assures usability of a new class of ultra low noise level IR thermometers
- Stainless steel housing with compact dimensions



Measurement Specifications

Temperature range	-20 °C ... 150 °C (-4 °F ... 302 °F)
Spectral range	8 – 14 µm
Optical resolution (90 % energy)	15:1
CF-lens (optional)	0.8 mm @ 10 mm (0.03 in @ 0.39 in)
System accuracy	±1.0 % or ±1.0 °C ^{3), 4), 5)} (±1.0 % or ±1.8 °F ^{3), 4), 5)})
Repeatability	±0.3 % or ±0.3 °C ^{3), 4), 5)} (±0.3 % or ±0.5 °F ^{3), 4), 5)})
Temperature coefficient	±0.05 K/K or ±0.05 %/K ⁶⁾
Temperature resolution	0.025 K ⁵⁾ (AVG >0,2 s)
Response time	150 ms (adjustable up to 999 s via optional programming device)
Emissivity / Amplification (adjustable via software)	0.100 – 1.100
Transmissivity (adjustable via software)	0.100 – 1.100
Signal processing (parameter adjustable via software)	Peak hold, valley hold, average; extended hold function with threshold and hysteresis
Dimensions of electronics	Length: 35 mm (1.38) in Diameter: 12 mm (0.47 in)
Software	optris® Compact Connect

General Specifications

Environmental rating	IP 65 (NEMA-4)
Ambient temperature	-20 °C ... 75 °C ¹⁾ (-4 °F to 167 °F ¹⁾)
Storage temperature	-40 °C ... 85 °C (-40 °F ... 185 °F)
Relative humidity	10–95 %, non condensing
Vibration	IEC 68-2-6: 3 G, 11 – 200 Hz, any axis
Shock	IEC 68-2-27: 50 G, 11 ms, any axis
Weight	200 g (7.1 oz)

Electrical Specifications

Output / analog	4 – 20 mA
Loop impedance	Max. 1000 Ω ²⁾
Output / alarm	0–30 V/500 mA (open collector)
Output / digital	Uni-/ bidirectional, 9.6 kBaud, 0/3 V digital level, USB optional
LED-functions	Alarm indication, automatic aiming support, self diagnostic, temperature indication (via. temp.code)
Input	Programmable functional input for triggered signal output or peakhold function
Cable length	1 m standard, 3.5 m optional (0.5 m between sensing head and electronics) (3.3 ft standard, 11.5 ft optional [1.6 ft between sensing head and electronics])
Power supply	5–30 V DC

¹⁾ For Vcc (supply voltage) 5–12 V DC/ at Vcc >12 V DC the max. ambient temperature of the electronics is 65 °C (149 °F)

²⁾ In dependence on supply voltage

³⁾ Whichever is greater

⁴⁾ At ambient temperature 23 ±5 °C (23 ±41 °F)

⁵⁾ For temperatures >20 °C (>68 °F)

⁶⁾ For ambient temperatures <18 °C and >28 °C (<64 °F and <83 °F) ; whichever is greater

optris® CSmicro 2W hs LT

Optical Specifications

Optics, D:S = 15:1

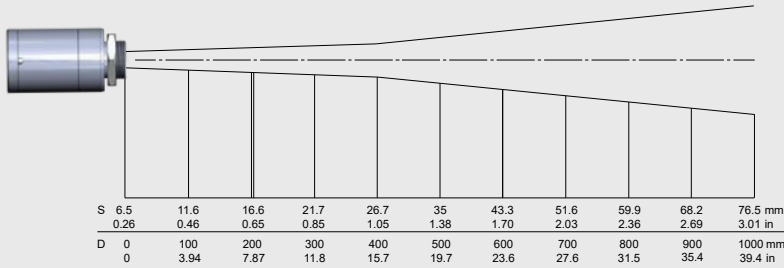

Optics with CF-lens, D:S = 15:1

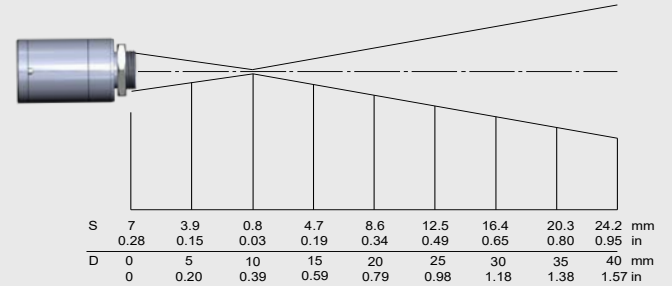

Dimensions / Interfaces

Analog Mode (Two wire connection)

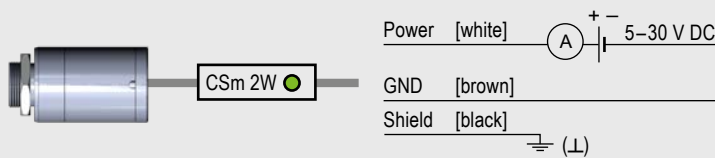

Dimensions CSmicro 2W hs LT

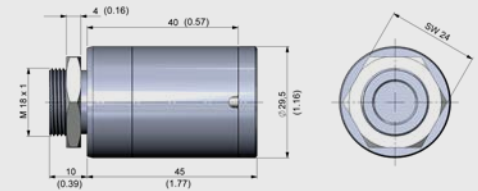

Connection analog with open collector alarm output

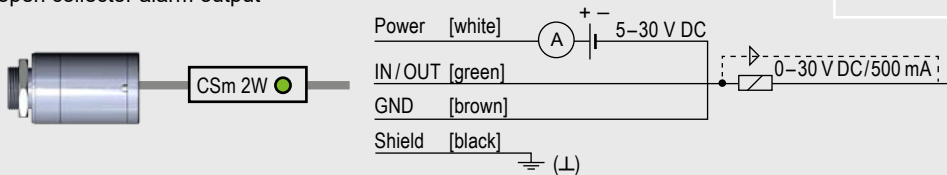

Combined Mode (analog and digital)



Accessories (examples)

CF-lens with external thread (ACCTCFE)

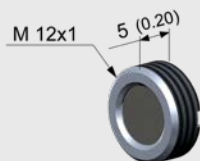

Mounting bracket, adjustable in one axis (ACCTFBMH)

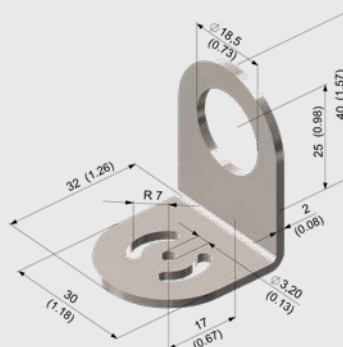

Air purge collar (ACCTAPMH)

