

Operating Instructions

Ceraphant PTC31B, PTP31B, PTP33B

Process pressure measurement

Pressure switch for safe measurement and monitoring of
absolute and gauge pressure

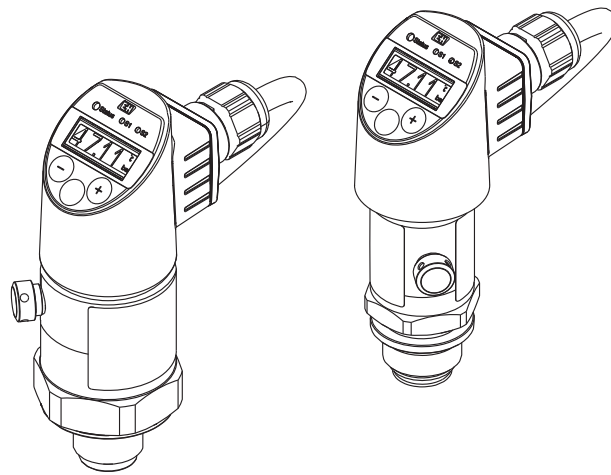

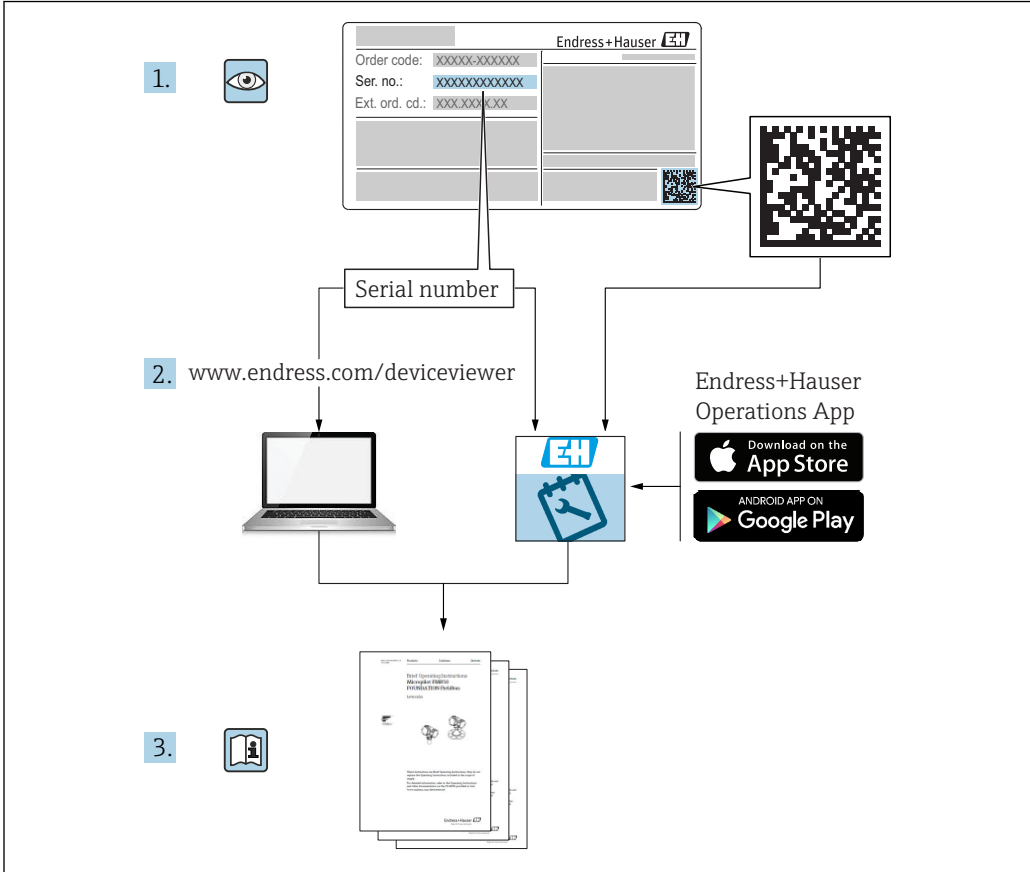

A0023555

- Make sure the document is stored in a safe place such that it is always available when working on or with the device.
- To avoid danger to individuals or the facility, read the "Basic safety instructions" section carefully, as well as all other safety instructions in the document that are specific to working procedures.
- The manufacturer reserves the right to modify technical data without prior notice. Your Endress+Hauser distributor will supply you with current information and updates to these Instructions.

Table of contents

1	Document information	5	8	Commissioning	28
1.1	Document function	5	8.1	Function check	28
1.2	Symbols used	5	8.2	Enabling configuration/operation	28
1.3	Documentation	6	8.3	Commissioning with an operating menu	28
1.4	Terms and abbreviations	7	8.4	Configuring pressure measurement (only for devices with a current output)	28
1.5	Turn down calculation	8	8.5	Performing position adjustment	30
2	Basic safety instructions	9	8.6	Configuring process monitoring	33
2.1	Requirements concerning the staff	9	8.7	Functions of switch output	33
2.2	Designated use	9	8.8	Current output	36
2.3	Workplace safety	10	8.9	Application examples	38
2.4	Operational safety	10	8.10	Configuring the local display	38
2.5	Product safety	10	8.11	Protecting settings from unauthorized access	39
3	Product description	11	9	Diagnostics and troubleshooting ...	40
3.1	Product design	11	9.1	Troubleshooting	40
3.2	Function	11	9.2	Diagnostic events	41
4	Incoming acceptance and product identification	13	9.3	Behavior of the device in the event of a fault	43
4.1	Incoming acceptance	13	9.4	Response of output to errors	43
4.2	Product identification	14	9.5	Behavior of the device in the event of a voltage drop	44
4.3	Storage and transport	15	9.6	Behavior of the device in the event of an incorrect entry	44
5	Installation	16	9.7	Disposal	45
5.1	Mounting dimensions	16	10	Maintenance	45
5.2	Installation conditions	16	10.1	Exterior cleaning	45
5.3	Influence of the installation position	16	11	Repairs	46
5.4	Mounting location	17	11.1	General notes	46
5.5	Mounting instructions for oxygen applications	19	11.2	Return	46
5.6	Post-installation check	19	11.3	Disposal	46
6	Electrical connection	20	12	Overview of the operating menu	47
6.1	Connecting the measuring unit	20	13	Description of device parameters ...	49
6.2	Switching capacity	21	13.1	Switch output 1 and switch output 2	49
6.3	Connection conditions	22	13.2	Current output	53
6.4	Connection data	22	13.3	EF menu (extended functions)	54
6.5	Post-connection check	22	13.4	DIAG menu (diagnosis)	64
7	Operation options	23	14	Accessories	66
7.1	Operation with an operating menu	23	14.1	Weld-in adapter	66
7.2	Structure of the operating menu	23	14.2	Process adapter M24	66
7.3	Operation with local display	23	14.3	M12 plug connectors	67
7.4	General value adjustment and rejection of illegal entries	24	15	Technical data	68
7.5	Navigation and selection from list	24	15.1	Input	68
7.6	Locking and unlocking operation	25	15.2	Output	71
7.7	Navigation examples	27			
7.8	Status LEDs	27			
7.9	Resetting to factory settings (reset)	27			

15.3	Performance characteristics of ceramic process isolating diaphragm	74
15.4	Performance characteristics of metal process isolating diaphragm	76
15.5	Environment	78
15.6	Process	80
Index	82





1 Document information

1.1 Document function



These Operating Instructions contain all the information that is required in various phases of the life cycle of the device: from product identification, incoming acceptance and storage, to mounting, connection, operation and commissioning through to troubleshooting, maintenance and disposal.

1.2 Symbols used

1.2.1 Safety symbols

Symbol	Meaning
	DANGER! This symbol alerts you to a dangerous situation. Failure to avoid this situation will result in serious or fatal injury.
	WARNING! This symbol alerts you to a dangerous situation. Failure to avoid this situation can result in serious or fatal injury.
	CAUTION! This symbol alerts you to a dangerous situation. Failure to avoid this situation can result in minor or medium injury.
	NOTICE! This symbol contains information on procedures and other facts which do not result in personal injury.



1.2.2 Electrical symbols





Symbol	Meaning	Symbol	Meaning
	Protective ground connection A terminal which must be connected to ground prior to establishing any other connections.		Ground connection A grounded terminal which, as far as the operator is concerned, is grounded via a grounding system.

1.2.3 Tool symbols

Symbol	Meaning
 A0011222	Open-ended wrench

1.2.4 Symbols for certain types of information

Symbol	Meaning
	Permitted Procedures, processes or actions that are permitted.
	Forbidden Procedures, processes or actions that are forbidden.
	Tip Indicates additional information.

Symbol	Meaning
	Reference to documentation
	Reference to page
	Reference to graphic
1. 2. 3. ...	Series of steps
	Result of a step
	Visual inspection

1.2.5 Symbols in graphics

Symbol	Meaning
1, 2, 3 ...	Item numbers
1. 2. 3. ...	Series of steps
A, B, C, ...	Views

1.3 Documentation

 The document types listed are available:
In the Download Area of the Endress+Hauser Internet site: www.endress.com →
Download

1.3.1 Technical Information (TI): planning aid for your device

PTC31B: TI01130P

PTP31B: TI01130P

PTP33B: TI01246P

The document contains all the technical data on the device and provides an overview of the accessories and other products that can be ordered for the device.

1.3.2 Brief Operating Instructions (KA): getting the 1st measured value quickly

KA01163P:

These instructions contain all the essential information from incoming acceptance to initial commissioning.

1.4 Terms and abbreviations

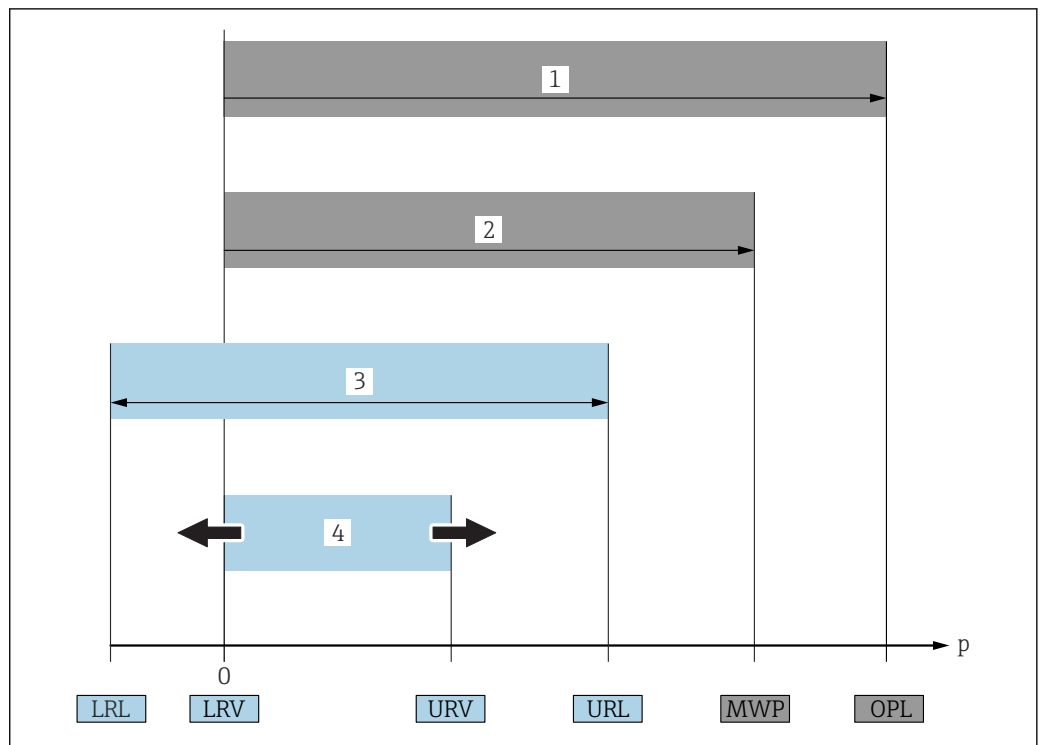

A0029505

Item	Term/ abbreviation	Explanation
1	OPL	The OPL (over pressure limit = sensor overload limit) for the measuring device depends on the lowest-rated element, with regard to pressure, of the selected components, i.e. the process connection has to be taken into consideration in addition to the measuring cell. Also observe pressure-temperature dependency. For the relevant standards and additional notes, see the "Pressure specifications" section → 81 . The OPL may only be applied for a limited period of time.
2	MWP	The MWP (maximum working pressure) for the sensors depends on the lowest-rated element, with regard to pressure, of the selected components, i.e. the process connection has to be taken into consideration in addition to the measuring cell. Also observe pressure-temperature dependency. For the relevant standards and additional notes, see the "Pressure specifications" section → 81 . The MWP may be applied at the device for an unlimited period. The MWP can also be found on the nameplate.
3	Maximum sensor measuring range	Span between LRL and URL This sensor measuring range is equivalent to the maximum calibratable/adjustable span.
4	Calibrated/adjusted span	Span between LRV and URV Factory setting: 0 to URL Other calibrated spans can be ordered as customized spans.
p	-	Pressure
-	LRL	Lower range limit
-	URL	Upper range limit
-	LRV	Lower range value
-	URV	Upper range value
-	TD (turn down)	Turn down Example - see the following section.

1.5 Turn down calculation

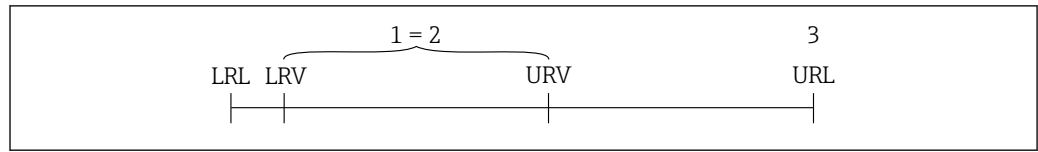

A0029545

- 1 *Calibrated/adjusted span*
- 2 *Zero point-based span*
- 3 *URL sensor*

Example	
<ul style="list-style-type: none"> ■ Sensor: 10 bar (150 psi) ■ Upper range value (URL) = 10 bar (150 psi) <p>Turn down (TD):</p> $TD = \frac{URL}{ URV - LRV }$ $TD = \frac{10 \text{ bar (150 psi)}}{ 5 \text{ bar (75 psi)} - 0 \text{ bar (0 psi)} } = 2$	<ul style="list-style-type: none"> ■ Calibrated/adjusted span: 0 to 5 bar (0 to 75 psi) ■ Lower range value (LRV) = 0 bar (0 psi) ■ Upper range value (URV) = 5 bar (75 psi)
<p>In this example, the TD is 2:1. This span is based on the zero point.</p>	

2 Basic safety instructions

2.1 Requirements concerning the staff

The personnel for installation, commissioning, diagnostics and maintenance must fulfill the following requirements:

- ▶ Trained, qualified specialists: must have a relevant qualification for this specific function and task
- ▶ Are authorized by the plant owner/operator
- ▶ Are familiar with federal/national regulations
- ▶ Before beginning work, the specialist staff must have read and understood the instructions in the Operating Instructions and supplementary documentation as well as in the certificates (depending on the application)
- ▶ Following instructions and basic conditions

The operating personnel must fulfill the following requirements:

- ▶ Being instructed and authorized according to the requirements of the task by the facility's owner-operator
- ▶ Following the instructions in these Operating Instructions

2.2 Designated use

2.2.1 Application and media

The Ceraphant is a pressure switch for measuring and monitoring absolute and gauge pressure in industrial systems. The process-wetted materials of the measuring device must have an adequate level of resistance to the media.

The measuring device may be used for the following measurements (process variables)

- in compliance with the limit values specified under "Technical data"
- in compliance with the conditions that are listed in this manual.

Measured process variable

Gauge pressure or absolute pressure

Calculated process variable

Pressure

2.2.2 Incorrect use

The manufacturer is not liable for damage caused by improper or non-designated use.

Verification for borderline cases:

- ▶ For special fluids and fluids for cleaning, Endress+Hauser is glad to provide assistance in verifying the corrosion resistance of process-wetted materials, but does not accept any warranty or liability.

2.2.3 Residual risks

When in operation, the housing may reach a temperature close to the process temperature.

Danger of burns from contact with surfaces!

- ▶ For elevated process temperatures, ensure protection against contact to prevent burns.

2.3 Workplace safety

For work on and with the device:

- ▶ Wear the required personal protective equipment according to federal/national regulations.
- ▶ Switch off the supply voltage before connecting the device.

2.4 Operational safety

Risk of injury!

- ▶ Operate the device in proper technical condition and fail-safe condition only.
- ▶ The operator is responsible for interference-free operation of the device.

Conversions to the device

Unauthorized modifications to the device are not permitted and can lead to unforeseeable dangers.

- ▶ If, despite this, modifications are required, consult with Endress+Hauser.

Hazardous area

To eliminate the risk of danger to persons or the facility when the device is used in the approval-related area (e.g. pressure equipment safety):

- ▶ Check the nameplate to verify if the device ordered can be put to its intended use in the approval-related area.





2.5 Product safety

This measuring device is designed in accordance with good engineering practice to meet state-of-the-art safety requirements, has been tested, and left the factory in a condition in which it is safe to operate.

It meets general safety standards and legal requirements. It also complies with the EU directives listed in the device-specific EU Declaration of Conformity. Endress+Hauser confirms this by affixing the CE mark to the device.

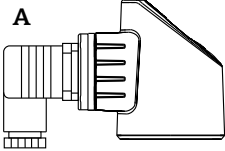
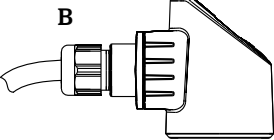
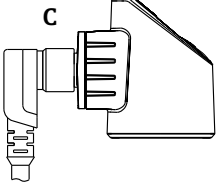
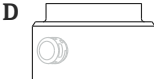
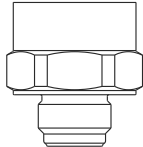
3 Product description

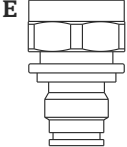
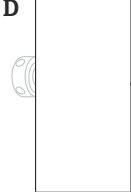
3.1 Product design

Overview	Position	Description
  	A	Valve plug
	B	Cable
	C	M12 plug Housing cap made of plastic
	D	Housing
	E	Process connection (sample illustration)
		
		
		
		

3.2 Function

3.2.1 Calculating the pressure

Devices with ceramic process isolating diaphragm (Ceraphire®)

The ceramic sensor is an oil-free sensor, i.e. the process pressure acts directly on the robust ceramic process isolating diaphragm and causes it to deflect. A pressure-dependent

change in capacitance is measured at the electrodes of the ceramic substrate and the process isolating diaphragm. The measuring range is determined by the thickness of the ceramic process isolating diaphragm.

Devices with metallic process isolating diaphragm

The process pressure deflects the metal process isolating diaphragm of the sensor and a fill fluid transfers the pressure to a Wheatstone bridge (semiconductor technology). The pressure-dependent change in the bridge output voltage is measured and evaluated.

4 Incoming acceptance and product identification

4.1 Incoming acceptance

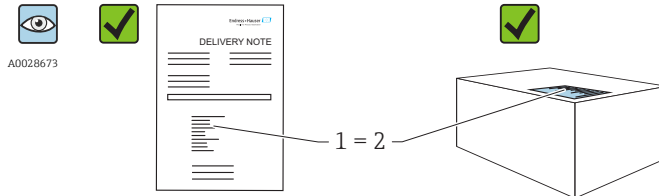

Is the order code on the delivery note (1) identical to the order code on the product sticker (2)?

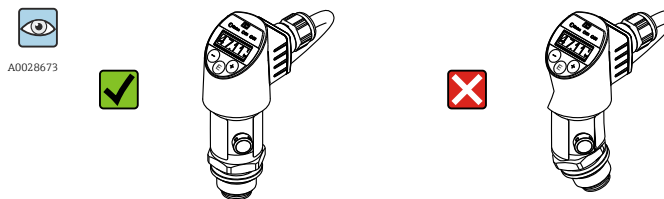
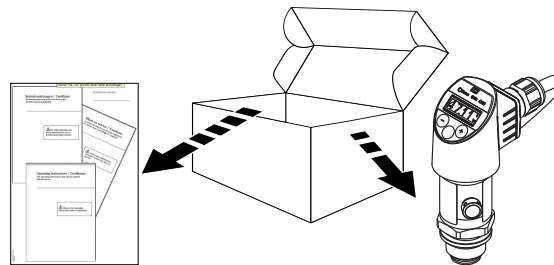

Are the goods undamaged?

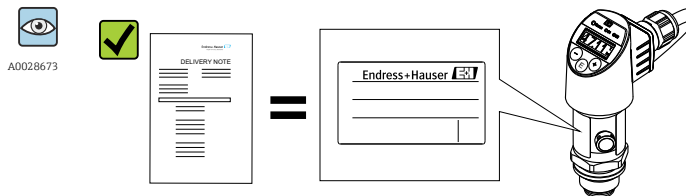

Do the data on the nameplate correspond to the order specifications and the delivery note?

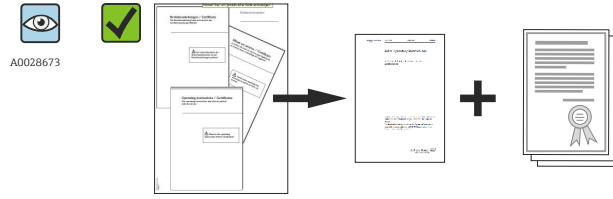

A0022106

Is the documentation available?
 If required (see nameplate): Are the safety instructions (XA) provided?

i If one of these conditions does not apply, please contact your Endress+Hauser sales office.

4.2 Product identification

The following options are available for the identification of the measuring device:

- Nameplate specifications
- Order code with a breakdown of the device features on the delivery note
- Enter the serial numbers from the nameplates in *W@M Device Viewer* (www.endress.com/deviceviewer): All the information about the measuring device is displayed.

For an overview of the technical documentation provided, enter the serial number from the nameplates in *W@M Device Viewer* (www.endress.com/deviceviewer)

4.2.1 Manufacturer address

Endress+Hauser SE+Co. KG
 Hauptstraße 1
 79689 Maulburg, Germany
 Address of the manufacturing plant: See nameplate.

4.2.2 Nameplate

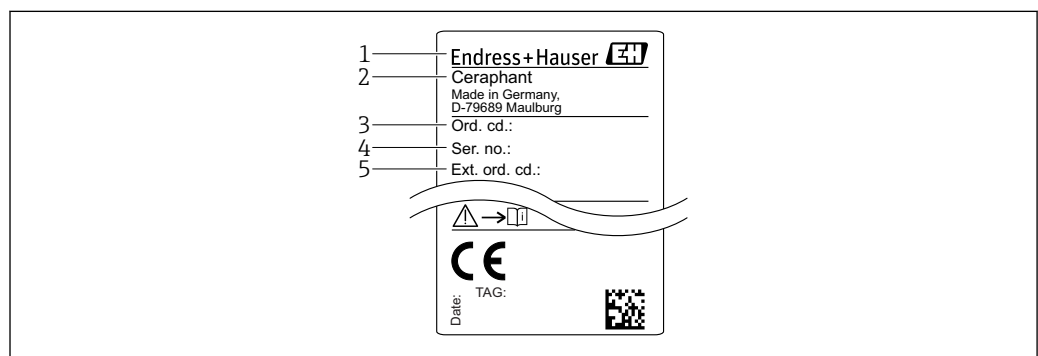

A0030101

- 1 *Manufacturer's address*
- 2 *Device name*
- 3 *Order number*
- 4 *Serial number*
- 5 *Extended order number*

4.3 Storage and transport

4.3.1 Storage conditions

Use original packaging.

Store the measuring device in clean and dry conditions and protect from damage caused by shocks (EN 837-2).

Storage temperature range

-40 to +85 °C (-40 to +185 °F)

4.3.2 Transporting the product to the measuring point

WARNING

Incorrect transport!

Housing and diaphragm may become damaged, and there is a risk of injury!

- ▶ Transport the measuring device to the measuring point in its original packaging or by the process connection.

5 Installation

5.1 Mounting dimensions

For dimensions, see the "Mechanical construction" section in the Technical Information.

5.2 Installation conditions

- Moisture must not penetrate the housing when mounting the device, establishing the electrical connection and during operation.
- Do not clean or touch process isolating diaphragms with hard and/or pointed objects.
- Do not remove process isolating diaphragm protection until shortly before installation.
- Always tighten the cable entry firmly.
- Point the cable and connector downwards where possible to prevent moisture from entering (e.g. rain or condensation water).
- Protect housing against impact.
- For devices with gauge pressure sensor and M12 or valve plug, the following applies:

NOTICE

If a heated device is cooled in the course of a cleaning process (by cold water, for example), a vacuum develops for a short time causing moisture to penetrate the sensor via the pressure compensation element (1).

Device could be destroyed!

- ▶ In the event of this happening, mount the device in such a way that the pressure compensation element (1) is pointing downwards at an angle or to the side, if possible.

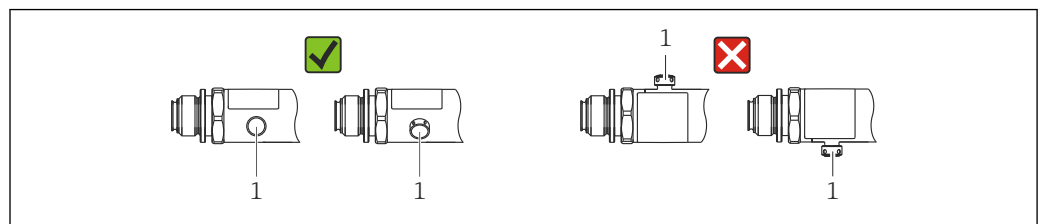

A0022252

5.3 Influence of the installation position

Any orientation is possible. However, the orientation may cause a zero point shift i.e. the measured value does not show zero when the vessel is empty or partially full.

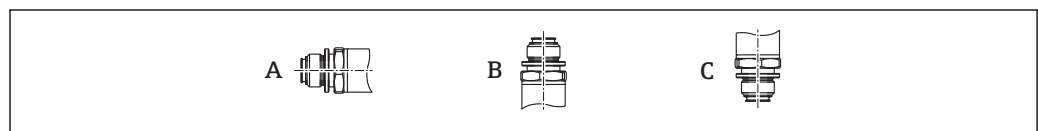

A0024708

Type	Process isolating diaphragm axis is horizontal (A)	Process isolating diaphragm pointing upwards (B)	Process isolating diaphragm pointing downwards (C)
PTP31B PTP33B	Calibration position, no effect	Up to +4 mbar (+0.058 psi)	Up to -4 mbar (-0.058 psi)
PTC31B < 1 bar (15 psi)	Calibration position, no effect	Up to +0.3 mbar (+0.0044 psi)	Up to -0.3 mbar (-0.0044 psi)
PTC31B ≥ 1 bar (15 psi)	Calibration position, no effect	Up to +3 mbar (+0.0435 psi)	Up to -3 mbar (-0.0435 psi)

 A position-dependent zero shift can be corrected on the device .

5.4 Mounting location

5.4.1 Pressure measurement

Pressure measurement in gases

Mount the device with shutoff device above the tapping point so that any condensate can flow into the process.

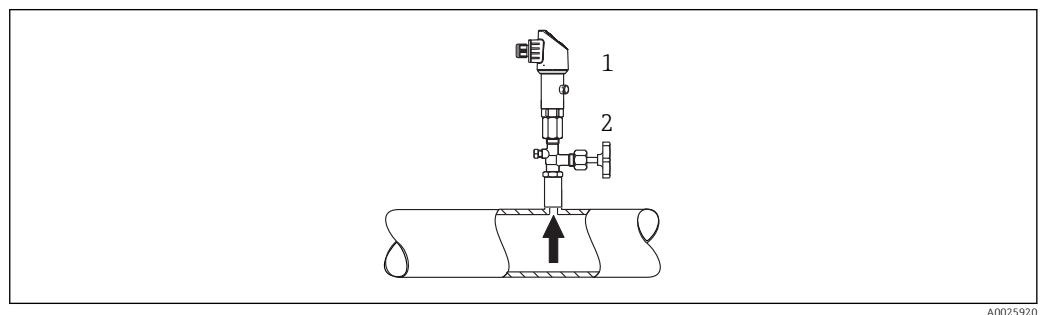

- 1 Device
2 Shutoff device

Pressure measurement in vapors

For pressure measurement in vapors, use a siphon. The siphon reduces the temperature to almost ambient temperature. Preferably mount the device with the shutoff device and siphon below the tapping point.

Advantage:

- defined water column causes only minor/negligible measuring errors and
- only minor/negligible heat effects on the device.

Mounting above the tapping point is also permitted.

Note the max. permitted ambient temperature of the transmitter!

Take the influence of the hydrostatic water column into consideration.

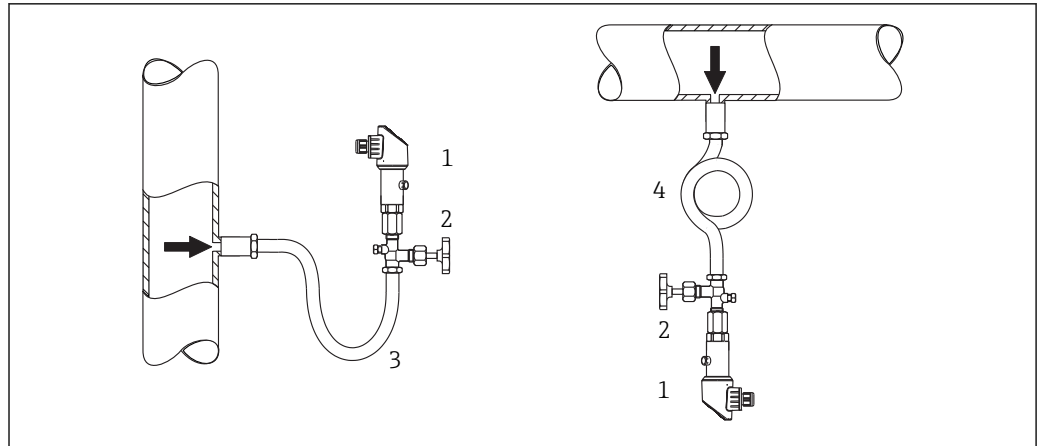

A0025921

- 1 Device
- 2 Shutoff device
- 3 Siphon
- 4 Siphon

Pressure measurement in liquids

Mount the device with a shutoff device and siphon below or at the same height as the tapping point.

Advantage:

- defined water column causes only minor/negligible measuring errors and
- air bubbles can be released to the process.

Take the influence of the hydrostatic water column into consideration.

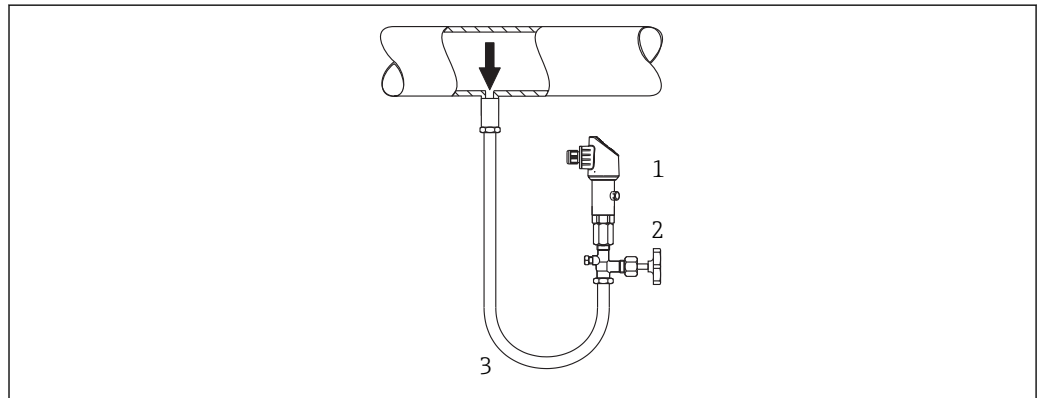

A0025922

- 1 Device
- 2 Shutoff device
- 3 Siphon

5.4.2 Level measurement

- Always install the device below the lowest measuring point.
- Do not install the device at the following positions:
 - In the filling curtain
 - In the tank outlet
 - in the suction area of a pump
 - Or at a point in the tank which could be affected by pressure pulses from the agitator.
- A functional test can be carried out more easily if you mount the device downstream from a shutoff device.

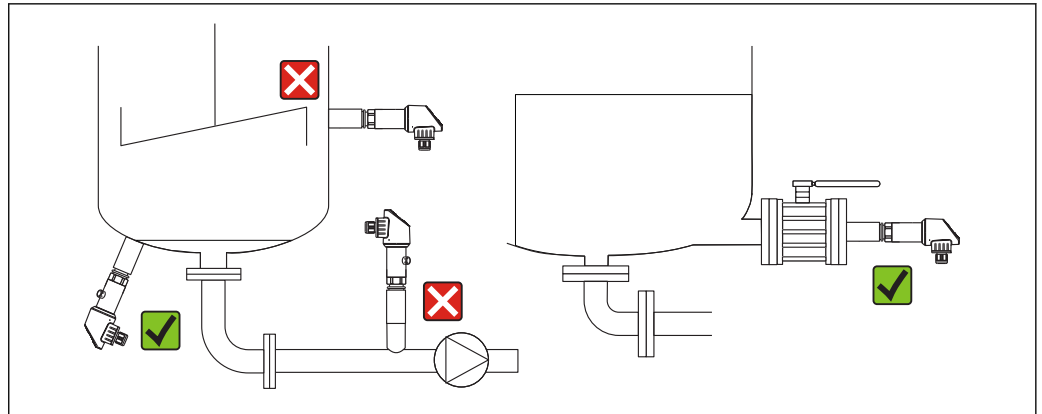

A0025923

5.5 Mounting instructions for oxygen applications

Oxygen and other gases can react explosively to oils, grease and plastics, such that, among other things, the following precautions must be taken:

- All components of the system, such as measuring devices, must be cleaned in accordance with the BAM requirements.
- Dependent on the materials used, a certain maximum temperature and a maximum pressure for oxygen applications must not be exceeded.
- The following table lists devices (devices only, not accessories or enclosed accessories), which are suitable for gaseous oxygen applications.

Device	p _{max} for oxygen applications	T _{max} for oxygen applications	Option ¹⁾
PTC31B	40 bar (600 psi)	-10 to +60 °C (+14 to +140 °F)	HB

1) Product Configurator, order code for "Service"

5.6 Post-installation check

<input type="checkbox"/>	Is the device undamaged (visual inspection)?
<input type="checkbox"/>	Does the device comply with the measuring point specifications? For example: <ul style="list-style-type: none"> ▪ Process temperature ▪ Process pressure ▪ Ambient temperature range ▪ Measuring range
<input type="checkbox"/>	Are the measuring point identification and labeling correct (visual inspection)?
<input type="checkbox"/>	Is the device adequately protected against precipitation and direct sunlight?
<input type="checkbox"/>	Are the securing screws tightened securely?
<input type="checkbox"/>	Is the pressure compensation element pointing downwards at an angle or to the side?
<input type="checkbox"/>	To prevent moisture from penetrating, ensure that the connecting cables/plugs are pointing downwards.

6 Electrical connection

6.1 Connecting the measuring unit

6.1.1 Terminal assignment

⚠ WARNING

Risk of injury from the uncontrolled activation of processes!

- ▶ Switch off the supply voltage before connecting the device.
- ▶ Make sure that downstream processes are not started unintentionally.

⚠ WARNING

Limitation of electrical safety due to incorrect connection!

- ▶ In accordance with IEC/EN61010 a separate circuit breaker must be provided for the device .
- ▶ The device must be operated with a 630 mA fine-wire fuse (slow-blow).
- ▶ Protective circuits against reverse polarity are integrated.

NOTICE

Damage to analog input of PLC resulting from incorrect connection

- ▶ Do not connect the active PNP switch output of the device to the 4 to 20 mA input of a PLC.

Connect the device in the following order:

1. Check that the supply voltage corresponds to the supply voltage indicated on the nameplate.
2. Connect the device in accordance with the following diagram.

Switch on the supply voltage.

For devices with a cable connection: do not close reference air hose (see (a) in the following drawings)! Protect reference air hose against penetration by water/condensate.

1 x PNP switch output R1

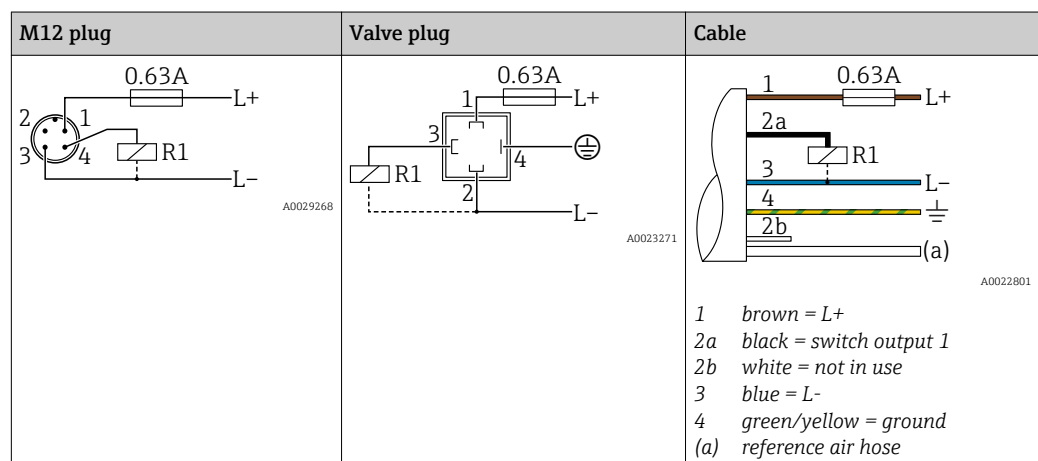

2 x PNP switch output R1 and R2

M12 plug	Valve plug	Cable
<p style="text-align: right;">A0023248</p>	-	<p style="text-align: right;">A0023282</p> <p>1 brown = L+</p> <p>2a black = switch output 1</p> <p>2b white = switch output 2</p> <p>3 blue = L-</p> <p>4 green/yellow = ground</p> <p>(a) reference air hose</p>

1 x PNP switch output R1 with additional analog output 4 to 20 mA (active)

M12 plug	Valve plug	Cable
<p style="text-align: right;">A0023249</p>	-	<p style="text-align: right;">A0030519</p> <p>1 brown = L+</p> <p>2a black = switch output 1</p> <p>2b white = analog output 4 to 20 mA</p> <p>3 blue = L-</p> <p>4 green/yellow = ground</p> <p>(a) reference air hose</p>

6.1.2 Supply voltage

Supply voltage: 10 to 30 V DC

6.1.3 Current consumption and alarm signal

Intrinsic power consumption	Alarm current (for device with analog output)
≤ 60 mA	≥21 mA (factory setting)

6.2 Switching capacity

- Switch state ON: $I_a \leq 250$ mA; switch state OFF: $I_a \leq 1$ mA
- Switch cycles: >10,000,000
- Voltage drop PNP: ≤2 V
- Overload protection: Automatic load testing of switching current;
 - Max. capacitive load: 14 μ F at max. supply voltage (without resistive load)
 - Max. cycle duration: 0.5 s; min. t_{on} : 4 ms
 - Periodic disconnection from protective circuit in the event of overcurrent ($f = 2$ Hz) and "F804" displayed

6.3 Connection conditions

6.3.1 Cable specification

For valve plug: < 1.5 mm² (16 AWG) and Ø4.5 to 10 mm (0.18 to 0.39 in)

6.4 Connection data

6.4.1 Load (for devices with analog output)

The maximum load resistance depends on the terminal voltage and is calculated according to the following formula:

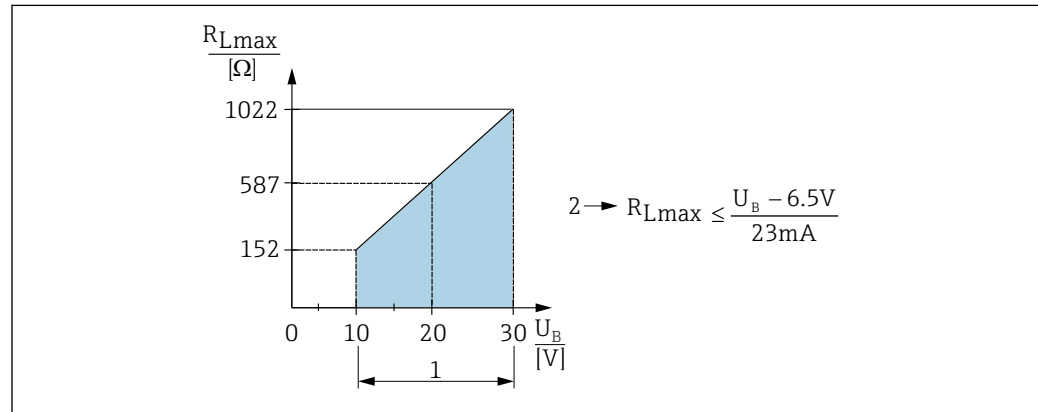

A0031107

- 1 Power supply 10 to 30 V DC
 2 R_{Lmax} maximum load resistance
 U_B Supply voltage

If load is too great:

- Failure current is output and "S803" displayed (output: MIN alarm current)
- Periodic checking to establish if it is possible to quit fault state

6.5 Post-connection check

<input type="checkbox"/>	Is the device or cable undamaged (visual check)?
<input type="checkbox"/>	Do the cables comply with the requirements?
<input type="checkbox"/>	Do the mounted cables have adequate strain relief?
<input type="checkbox"/>	Are all the cable glands installed, firmly tightened and leak-tight?
<input type="checkbox"/>	Does the supply voltage match the specifications on the nameplate?
<input type="checkbox"/>	Is the terminal assignment correct ?
<input type="checkbox"/>	If required: has protective ground connection been established?
<input type="checkbox"/>	If supply voltage is present, is the device ready for operation and do values appear on the display module or is the green LED lit on the electronic insert?

7 Operation options

7.1 Operation with an operating menu

7.1.1 Operating concept

Operation with an operating menu is based on an operation concept with "user roles" .

User role	Meaning
Operator (display level)	Operators are responsible for the devices during normal "operation". This is usually limited to reading process values either directly at the device or in a control room. Should an error occur, these users simply forward the information on the errors but do not intervene themselves.
Maintenance (user level)	Service engineers usually work with the devices in the phases following device commissioning. They are primarily involved in maintenance and troubleshooting activities for which simple settings have to be made on the device. Technicians work with the devices over the entire life cycle of the product. Thus, commissioning and advanced settings and configurations are some of the tasks they have to carry out.

7.2 Structure of the operating menu

The menu structure has been implemented according to VDMA 24574-1 and complemented by Endress+Hauser-specific menu items.

User role	Submenu	Meaning/use
Operator (display level)	Display/operat.	Display of measured values, fault and information messages
Maintenance (user level)	Parameters on the topmost menu level.	Contains all the parameters that are needed to commission measuring operations. A wide range of parameters, which can be used to configure a typical application, is available at the start. After making settings for all these parameters, the measuring operation should be completely configured in the majority of cases.
	EF	The submenu "EF" (Extended Functions) contains additional parameters which allow more accurate configuration of the measurement, conversion of the measured value and scaling of the output signal.
	DIAG	Contains all the parameters that are needed to detect and analyze operating errors.

 For an overview of the entire operating menu, see the →  47

7.3 Operation with local display

7.3.1 Overview

A 1-line liquid crystal display (LCD) is used for display and operation. The local display shows measured values, fault messages and information messages and therefore supports the user through each operating step.

The display is fixed to the housing and can be electronically rotated 180° (see parameter description for "DRO" →  62). This ensures optimum readability of the local display and allows the device to be mounted upside down also.

During measuring operation, the display shows measured values, fault messages and notice messages. In addition, it is possible to switch to menu mode via the operating keys.

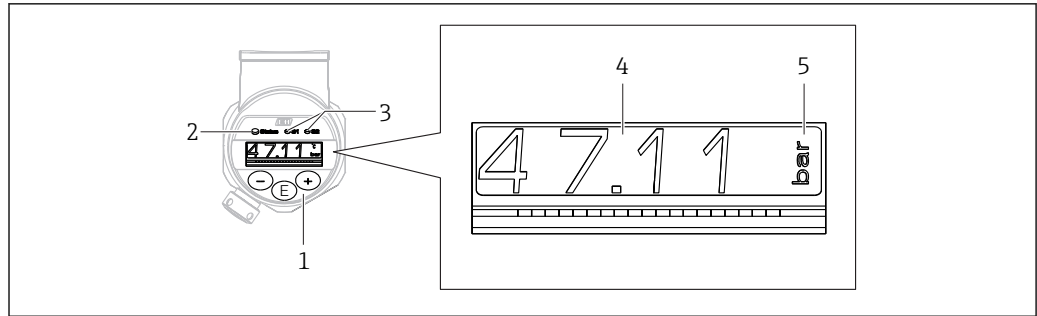

A0022121

- 1 Operating keys
- 2 Status LED
- 3 Switch output LEDs
- 4 Measured value
- 5 Unit

The second switch output is not used for the device version with current output.

7.4 General value adjustment and rejection of illegal entries





Parameter (not numerical value) is flashing: parameter can be adjusted or selected.

When adjusting a numerical value: the numerical value does not flash. The first digit of the numerical value starts to flash only when the \boxed{E} key is pressed by way of confirmation. Enter the desired value with the $\boxed{-}$ or $\boxed{+}$ key and press the \boxed{E} key to confirm. Following confirmation, the data are recorded directly and are active.

- Entry is OK: value is accepted and shown for one second on the display against a white background.
- Entry is not OK: the message "FAIL" appears for one second on the display against a red background. The value entered is rejected. In the event of an incorrect setting which affects the TD, a diagnostic message is displayed.

7.5 Navigation and selection from list

The capacitive operating keys are used for navigation in the operating menu and to select an option from a picklist.

Operating key(s)	Meaning
 <small>A0017879</small>	<ul style="list-style-type: none"> ▪ Navigate downwards in the picklist ▪ Edit the numerical values or characters within a function
 <small>A0017880</small>	<ul style="list-style-type: none"> ▪ Navigate upwards in the picklist ▪ Edit the numerical values or characters within a function
 <small>A0017881</small>	<ul style="list-style-type: none"> ▪ Confirm entry ▪ Jump to the next item ▪ Select a menu item and activate the edit mode ▪ The key lock function (KYL) is accessed by pressing the key for longer than 2 seconds
Simultaneously  and  <small>A0017879</small> and <small>A0017880</small>	ESC functions: <ul style="list-style-type: none"> ▪ Exit edit mode for a parameter without saving the changed value. ▪ You are in a menu at a selection level. Each time you press the keys simultaneously, you go up a level in the menu. ▪ Long ESC: press the keys for longer than 2 seconds

7.6 Locking and unlocking operation

The device features

- Automatic key locking
- Parameter settings lock.

Key locking is indicated on the local display by "E > 2".

Locking of the parameter settings is indicated as soon as an attempt is made to change a parameter.

7.6.1 Disabling the key lock

The keys are locked automatically if the device remains at the topmost menu level (display of pressure measurement value) for 60 seconds.

Call up the key lock function (KYL)

1. Press the $\boxed{\text{E}}$ key for at least 2 seconds and then release it
2. By confirming with $\boxed{\text{E}}$ "ON" is displayed
3. Use $\boxed{\text{+}}$ and $\boxed{\text{-}}$ to toggle between "ON" and "OFF"
4. Key locking is disabled as soon as $\boxed{\text{E}}$ is pressed to confirm "OFF"

The display changes to the main value level (topmost menu level) if the $\boxed{\text{E}}$ key is pressed briefly. The display changes to the key locking if the $\boxed{\text{E}}$ key is pressed for at least 2 seconds.

If in the case of "KYL", "ON" or "OFF", more than 10 seconds elapse without a key being pressed, you return to the topmost menu level with active key locking.

The function can be accessed anytime outside the main measured value display and within the operating menu, i.e. if the $\boxed{\text{E}}$ key is pressed for at least 2 seconds key locking can be performed anytime at any menu item. Locking is effective immediately. If you quit the context menu, you will return to the same point from which key locking was selected.

7.6.2 Locking parameter settings

COD locking code	
<hr/>	
Navigation	EF → ADM → COD
Description	A code can be entered to protect parameter settings against unauthorized and unwanted access.
Selection	To lock: Enter a number ≠ the LCK release code (value range: 1 to 9999).
Factory setting	0000

7.6.3 Unlocking parameter settings

If parameters are locked, the word "LCK" appears on the local display as soon as an attempt is made to change a parameter.

LCK unlocking code









Navigation	EF → ADM → LCK
Description	<p>Use this function to enter the code (which was defined in the COD parameter) to enable configuration.</p> <p>Keys are evaluated but parameters are read only. The parameters can only be changed after unlocking.</p> <p>If an attempt is made to write to a parameter, a prompt for the device access code appears. To unlock, enter the user-defined device access code (which was specified in the COD parameter).</p>
User entry	To unlock: Enter the access code.
Factory setting	0000
Note	The access code is "0000" in the order configuration. Another access code can be defined in the parameter "COD".

7.7 Navigation examples

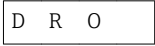
7.7.1 Parameters with a picklist

Example: Display measured value rotated by 180°



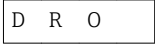







Menu path: EF → DIS → DRO

Press  or  key until "DRO" is displayed.	
The default setting is "NO" (display is not rotated).	
Press  or  until "YES" appears (display is rotated by 180°).	
Press  to confirm the setting.	

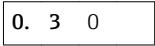
7.7.2 User-definable parameters

Example: setting the "TAU" damping parameter.

Menu path: EF → TAU

Press  or  key until "TAU" is displayed.	
Press  to set the damping (min. = 0.0 s; max.= 999.9 s).	
Press  or  to go up or down. Press  to confirm the entry and to go to the next position.	
Press  to quit the setting function and to go to the "TAU" menu item.	

7.8 Status LEDs

The Ceraphant also uses LEDs to signal the status:

- Two LEDs indicate the status of the switch outputs (switch output 2 can optionally be used as a current output)
- One LED indicates if the device is switched on or if an error or fault has occurred

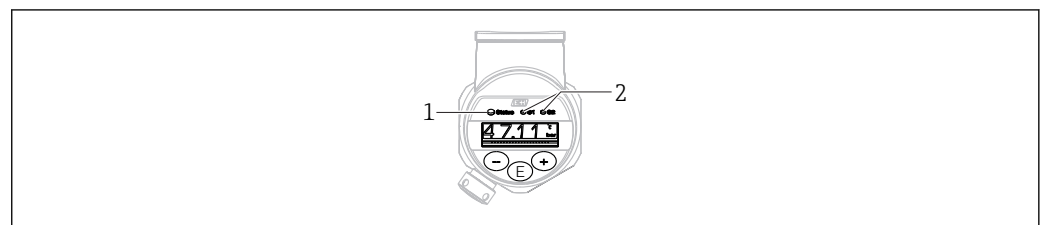

A0032027

- 1 Status LED
- 2 Switch output LEDs

7.9 Resetting to factory settings (reset)

See parameter description for RES →  54

8 Commissioning

If an existing configuration is changed, measuring operation continues! The new or modified entries are only accepted once the setting has been made.

⚠ WARNING

Risk of injury from the uncontrolled activation of processes!

- ▶ Make sure that downstream processes are not started unintentionally.



⚠ WARNING

If a pressure smaller than the minimum permitted pressure or greater than the maximum permitted pressure is present at the device, the following messages are output in succession:

- ▶ S971 (displayed only in the case of devices with current output)
- ▶ S140
- ▶ F270

8.1 Function check

Before commissioning your measuring point, ensure that the post-installation and post-connection check have been performed:

- "Post-installation check" checklist →  19
- "Post-connection check" checklist →  22





8.2 Enabling configuration/operation

The device features

- Automatic key locking →  25
- Parameter locking →  25.

8.3 Commissioning with an operating menu

Commissioning comprises the following steps:

- Configuration of pressure measurement →  28
- If necessary, perform position adjustment →  30
- If necessary, Configuration of process monitoring if necessary →  33
- If necessary, Configuration of the local display if necessary →  38
- If necessary, Protection of settings from unauthorized access if necessary →  39

8.4 Configuring pressure measurement (only for devices with a current output)

8.4.1 Calibration without reference pressure (dry calibration = calibration without medium)

Example:





In this example, a device with a 400 mbar (6 psi) sensor is configured for the measuring range 0 to 300 mbar (0 to 4.4 psi).

The following values should be assigned:

- 0 mbar = 4 mA value
- 300 mbar (4.4 psi) = 20 mA value

Prerequisite:

This is a theoretical calibration, i.e. the pressure values for the lower and upper range are known. It is not necessary to apply pressure.

-  Due to the orientation of the device, there may be pressure shifts in the measured value, i.e. the measured value is not zero in a pressureless condition. For information on how to perform position adjustment, see the "Performing position adjustment" section →  30.
-  For a description of the parameters mentioned and possible error messages, see the "Description of device parameters" section →  49 and →  42.

Performing the calibration

1. Select a pressure engineering unit via the "UNI" parameter, here "BAR" for example.
Menu path: EF → UNI
2. Select the "STL" parameter. Menu path: STL. Enter the value (0 bar (0 psi)) and confirm.
 - ↳ This pressure value is assigned to the lower current value (4 mA).
3. Select the "STU" parameter. Menu path: STU. Enter the value (300 mbar (4.4 psi)) and confirm.
 - ↳ This pressure value is assigned to the upper current value (20 mA).

The measuring range is configured for 0 to 300 mbar (0 to 4.4 psi).

8.4.2 Calibration with reference pressure (wet calibration = calibration with medium)

Example:



In this example, a device with a 400 mbar (6 psi) sensor is configured for the measuring range 0 to 300 mbar (0 to 4.4 psi).



The following values should be assigned:

- 0 mbar = 4 mA value
- 300 mbar (4.4 psi) = 20 mA value

Prerequisite:

The pressure values 0 mbar and 300 mbar (4.4 psi) can be specified. For example, the device is already installed.

 Due to the orientation of the device, there may be pressure shifts in the measured value, i.e. the measured value is not zero in a pressureless condition. For information on how to perform position adjustment, see the "Performing position adjustment" section →  30.

 For a description of the parameters mentioned and possible error messages, see the "Description of device parameters" section →  49 and →  42.

Performing the calibration

1. Select a pressure engineering unit via the "UNI" parameter, here "BAR" for example. Menu path: EF → UNI
2. The pressure for the LRV (4 mA value) is present at the device, here 0 bar (0 psi) for example. Select the "GTL" parameter. Menu path: EF → I → GTL. Confirm the present value by selecting "YES".
 - ↳ The present pressure value is assigned to the lower current value (4 mA).
3. The pressure for the URV (20 mA value) is present at the device, here 300 mbar (4.4 psi) for example. Select the "GTU" parameter. Menu path: EF → I → GTU. Confirm the present value by selecting "YES".
 - ↳ The present pressure value is assigned to the upper current value (20 mA).

The measuring range is configured for 0 to 300 mbar (0 to 4.4 psi).

8.5 Performing position adjustment

ZRO manual position adjustment (typically for absolute pressure sensor)

Navigation

EF → ZRO

Description

The pressure resulting from the orientation of the device can be corrected here. The pressure difference between zero (set point) and the measured pressure must be known.

Prerequisite	<p>An offset is possible (parallel shifting of the sensor characteristic) to correct the orientation and any zero point drift. The set value of the parameter is subtracted from the "raw measured value". The requirement to be able to perform a zero point shift without changing the span is met with the offset function.</p> <p>Maximum offset value = $\pm 20\%$ of the sensor nominal range.</p> <p>If an offset value is entered that shifts the span beyond the physical limits of the sensor, the value is admitted but a warning message is generated and shown on the display. The warning message only disappears when the span is within the sensor limits, taking the offset value currently configured into consideration.</p> <p>The sensor can</p> <ul style="list-style-type: none"> ■ be operated in a physically unfavorable range, i.e. outside its specifications, or ■ be operated by making appropriate corrections to the offset or span. <p>Raw measured value – (manual offset) = display value (measured value)</p>
Example	<ul style="list-style-type: none"> ■ Measured value = 2.2 mbar (0.033 psi) ■ Set the measured value in the parameter to 2.2. ■ Measured value (after position adjustment) = 0.0 mbar ■ The current value is also corrected.
Note	Setting in increments of 0.1. As the value is entered numerically, the increment depends on the measuring range
Options	No selection. The user is free to edit the values.
Factory setting	0

GTZ automatic position adjustment (typically for gauge pressure sensor)

Navigation	EF → GTZ
Description	<p>The pressure resulting from the orientation of the device can be corrected here.</p> <p>The pressure difference between zero (set point) and the measured pressure need not be known.</p>
Prerequisite	<p>An offset is possible (parallel shifting of the sensor characteristic) to correct the orientation and any zero point drift. The set value of the parameter is subtracted from the "raw measured value". The requirement to be able to perform a zero point shift without changing the span is met with the offset function.</p> <p>Maximum offset value = $\pm 20\%$ of the sensor nominal range.</p> <p>If an offset value is entered that shifts the span beyond the physical limits of the sensor, the value is admitted but a warning message is generated and shown on the display. The warning message only disappears when the span is within the sensor limits, taking the offset value currently configured into consideration.</p> <p>The sensor can</p> <ul style="list-style-type: none"> ■ be operated in a physically unfavorable range, i.e. outside its specifications, or ■ be operated by making appropriate corrections to the offset or span. <p>Raw measured value – (manual offset) = display value (measured value)</p>

Example 1

- Measured value = 2.2 mbar (0.033 psi)
- You use the "GTZ" parameter to correct the measured value with the value, e.g. 2.2 mbar (0.033 psi). This means that you are assigning the value 0 mbar (0 psi) to the pressure present.
- Measured value (after pos. zero adjust) = 0 mbar (0 psi)
- The current value is also corrected.
- If necessary, check and correct switch points and span settings.

Example 2

Sensor measuring range: -0.4 to +0.4 bar (-6 to +6 psi) (SP1 = 0.4 bar (6 psi); STU = 0.4 bar (6 psi))

- Measured value = 0.08 bar (1.2 psi)
- You use the "GTZ" parameter to correct the measured value with the value, e.g. 0.08 bar (1.2 psi). This means that you are assigning the value 0 mbar (0 psi) to the pressure present.
- Measured value (after pos. zero adjust) = 0 mbar (0 psi)
- The current value is also corrected.
- Warnings C431 or C432 appear because the value 0 bar (0 psi) was assigned to the real value of 0.08 bar (1.2 psi) present and the sensor measuring range was thus exceeded by $\pm 20\%$.
SP1 and STU values must be readjusted downwards by 0.08 bar (1.2 psi).

Factory setting

0.0

8.6 Configuring process monitoring

To monitor the process, it is possible to specify a pressure range which is monitored by the limit switch. Depending on the device version, the process can be monitored using one PNP switch output, and optionally using a second PNP switch output or an analog 4 to 20 mA output. Both monitoring versions are described below. The monitoring function allows the user to define optimum ranges for the process (with high yields etc.) and deploy limit switches to monitor the ranges.



8.6.1 Digital process monitoring (switch output)

It is possible to select defined switch points and switchback points which act as NO or NC contacts depending on whether a window function or hysteresis function is configured →  33.

Function	Output	Abbreviation for operation
Hysteresis	Closing	HNO
Hysteresis	NC contact	HNC
Window	Closing	FNO
Window	NC contact	FNC

If the device is restarted within the specified hysteresis, both switch outputs are open (0 V present at the output).

8.6.2 Analog process monitoring (4 to 20 mA output)

- The 3.8 to 20.5 mA signal range is controlled according to NAMUR NE 43.
- The alarm current and current simulation are exceptions:
 - If the defined limit is exceeded, the device continues measuring in a linear fashion. The output current increases linearly up to 20.5 mA and holds the value until the measured value drops below 20.5 mA again or the device detects an error →  43.
 - If the defined limit is undershot, the device continues measuring in a linear fashion. The output current decreases linearly to 3.8 mA and holds the value until the measured value rises above 3.8 mA again or the device detects an error →  43.

8.7 Functions of switch output

The switch output can be used for two-point control (hysteresis) or for monitoring a process pressure range (window function).

8.7.1 Hysteresis

SP1/SP2 switch point value, output 1/2
 RP1/RP2 switchback point value, output 1/2

Navigation

SP1/SP2
 RP1/RP2

Note The hysteresis is implemented using the "SP1/SP2" and "RP1/RP2" parameters. Since the parameter settings depend on one another, the parameters are described all together.

- SP1 = switch output 1
- SP2 = switch output 2 (optional)
- RP1 = switchback point 1
- RP2 = switchback point 2 (optional)

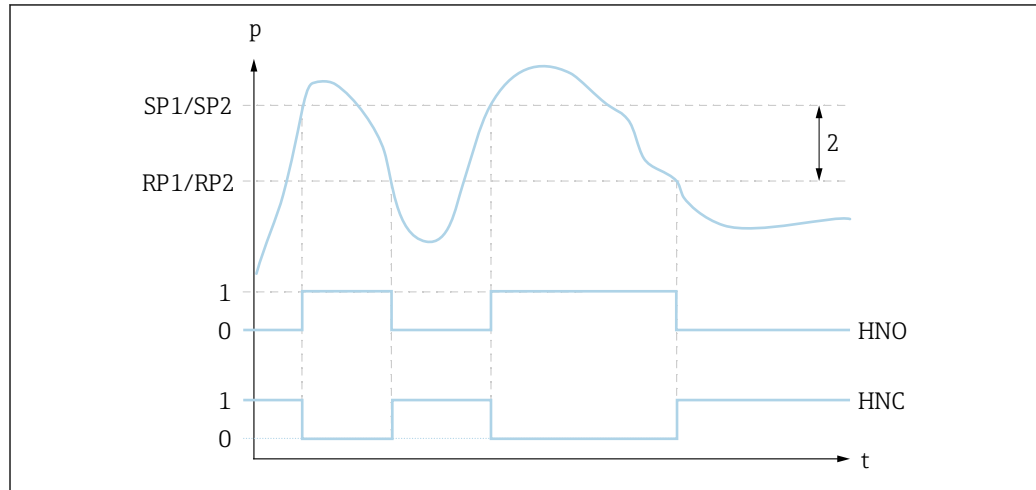

A0022943

1 SP1/SP2: switch point 1/2; RP1/RP2: switch-back point 1/2

0 0-signal. Output open in quiescent state.

1 1-signal. Output closed in quiescent state.

2 Hysteresis

HNO Closing

HNC NC contact

Description

The switch point "SP1/SP2" and the switchback point "RP1/RP2" can be defined with these functions (e.g. for pump control).

When the set switch point "SP1/SP2" is reached (with increasing pressure), an electrical signal change takes place at the switch output.

When the set switchback point "RP1/RP2" is reached (with decreasing pressure), an electrical signal change takes place at the switch output.

The difference between the value of the switch point "SP1/SP2" and the switchback point "RP1/RP2" is known as the hysteresis.

Prerequisite

- These functions are only available if the hysteresis function has been defined for the switch output.
- The configured value for the switch point "SP1/SP2" must be greater than the switchback point "RP1/RP2"!
A diagnostic message is displayed if a switch point "SP1/SP2" is entered that is \leq the switchback point "RP1/RP2". While it is possible to make this entry, it does not take effect in the device. The entry must be corrected!

Note

To prevent constant switch-on and switch-off if values are around the switch point "SP1/SP2" and switchback point "RP1/RP2", a delay can be set for the relevant points. See the parameter description for "dS1/dS2" and "dR1/dR2" for this purpose.

Options

No selection. The user is free to edit the values.

Factory setting

Factory setting (if no customer-specific setting is ordered):

Switch point SP1: 90%; switchback point RP1: 10%

Switch point SP2: 95 %; switchback point RP2: 15 %

8.7.2 Window function

- SP1 = switch output 1
- SP2 = switch output 2 (optional)

FH1/FH2 Upper value for pressure window, output 1/2
FL1/FL2 Lower value for pressure window, output 1/2

Navigation FH1/FH2
 FL1/FL2

Note The window function is implemented using the "FH1/FH2" and "FL1/FL2" parameters. Since the parameter settings depend on one another, the parameters are described all together.

- FH1 = Upper value of pressure window 1
- FH2 = Upper value of pressure window 2 (optional)
- FL1 = Lower value of pressure window 1
- FL2 = Lower value of pressure window 2 (optional)

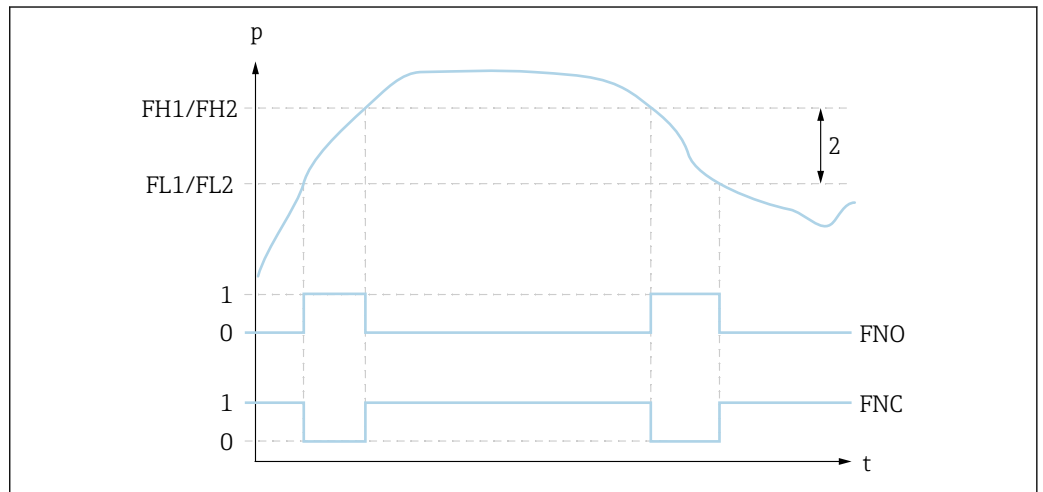

2 FH1/FH2: upper value of pressure window; FL1/FL2: lower value of pressure window
 0 0-signal. Output open in quiescent state.
 1 1-signal. Output closed in quiescent state.
 2 Pressure window (difference between the value of the high window "FH1/FH2" and the low window "FL1/FL2")
 FNO Closing
 FNC NC contact

Description The upper value of the pressure window "FH1/FH2" and the lower value of the pressure window "FL1/FL2" can be defined with these functions (e.g. for monitoring a certain pressure range).

When the lower value of the pressure window "FL1/FL2" is reached (with increasing or decreasing pressure), an electrical signal change takes place at the switch output.

When the upper value of the pressure window "FH1/FH2" is reached (with increasing or decreasing pressure), an electrical signal change takes place at the switch output. The difference between the upper value of the pressure window "FH1/FH2" and the lower value of the pressure window "FL1/FL2" is known as the pressure window.

Prerequisite	<ul style="list-style-type: none"> ■ This function is only available if the window function has been defined for the switch output. ■ The upper value of the pressure window "FH1/FH2" must be greater than the lower value of the pressure window "FL1/FL2"! A diagnostic message is displayed if the upper value entered for the pressure window "FH1/FH2" is smaller than the lower value of the pressure window "FL1/FL2". While it is possible to make this entry, it does not take effect in the device. The entry must be corrected!
Note	To prevent constant switch-on and switch-off if values are around the switch point "SP1/SP2" and switchback point "RP1/RP2", a delay can be set for the relevant points. See the parameter description for "dS1/dS2" and "dR1/dR2" for this purpose.
Options	No selection. The user is free to edit the values.
Factory setting	Factory setting if no customer-specific setting is ordered: Switch point FH1: 90 %; switchback point FL1: 10 % Switch point FH2: 95 %; switchback point FH2: 15 %

8.8 Current output

STL value for 4 mA (LRV)

Navigation	STL
Description	Assignment of the pressure value which should correspond to the 4 mA value. It is possible to invert the current output. To do so, assign the pressure upper range value to the lower measuring current.
Prerequisite	Electronic version with current output
Note	Enter the value for 4 mA in the selected pressure unit anywhere within the measuring range. The value can be entered in increments of 0.1 (increment depends on the measuring range).
Selection	No selection. The user is free to edit the values.
Factory setting	0.0 or as per order specifications

STU value for 20 mA (URV)

Navigation	STU
Description	Assignment of the pressure value which should correspond to the 20 mA value. It is possible to invert the current output. To do so, assign the pressure lower range value to the upper measuring current.
Prerequisite	Electronic version with current output

Note	Enter the value for 20 mA in the selected pressure unit anywhere within the measuring range. The value can be entered in increments of 0.1 (increment depends on the measuring range).
Selection	No selection. The user is free to edit the values.
Factory setting	Upper measuring limit or as per order specifications.

GTL Pressure applied for 4mA (LRV)

Navigation	EF → I → GTL
Description	<p>The pressure value present is automatically adopted for the 4 mA current signal. Parameter for which the current range can be assigned to any section of the nominal range. This occurs by assigning the pressure lower range value to the lower measuring current and the pressure upper range value to the upper measuring current. The pressure lower range value and upper range value can be configured independently of one another so the pressure measuring span does not remain constant. The LRV and URV pressure measuring span can be edited over the entire sensor range. An invalid TD value is indicated by diagnostic message S510. An invalid position offset is indicated by diagnostic message C431. The editing operation cannot result in the device being operated outside the minimum and maximum sensor limits. If the entry is not OK, it is rejected, the message "FAIL" appears on the local display and the last valid value before the change is used again. The measured value currently present is accepted as the value for 4mA anywhere within the measuring range. There is a parallel shift of the sensor characteristic so that the pressure present becomes the zero value.</p>
Selection	<ul style="list-style-type: none"> ▪ NO ▪ YES
Factory setting	NO

GTU Pressure applied for 20 mA (URV)

Navigation	EF → I → GTU
-------------------	--------------

Description	<p>The pressure value present is automatically adopted for the 20 mA current signal. Parameter for which the current range can be assigned to any section of the nominal range. This occurs by assigning the pressure lower range value to the lower measuring current and the pressure upper range value to the upper measuring current. The pressure lower range value and upper range value can be configured independently of one another so the pressure measuring span does not remain constant. The LRV and URV pressure measuring span can be edited over the entire sensor range. An invalid TD value is indicated by diagnostic message S510. An invalid position offset is indicated by diagnostic message C431. The editing operation cannot result in the device being operated outside the minimum and maximum sensor limits. If the entry is not OK, it is rejected, the message "FAIL" appears on the local display and the last valid value before the change is used again. The measured value currently present is accepted as the value for 20 mA anywhere within the measuring range. There is a parallel shift of the sensor characteristic so that the pressure present becomes the max value.</p>
Selection	<ul style="list-style-type: none"> ▪ NO ▪ YES
Factory setting	NO

8.9 Application examples

8.9.1 Compressor control with hysteresis function

Example: The compressor is started when the pressure drops below a certain value. The compressor is switched off when a certain value is exceeded.

1. Set the switch point to 2 bar (29 psi)
2. Set the switchback point to 1 bar (14.5 psi)
3. Configure the switch output as an "NC contact" (HNC function)

The compressor is controlled by the defined settings.

8.9.2 Pump control with hysteresis function

Example: The pump should switch on when 2 bar (29 psi) is reached (increasing pressure) and switch off when 1 bar (14.5 psi) is reached (decreasing pressure).

1. Set the switch point to 2 bar (29 psi)
2. Set the switchback point to 1 bar (14.5 psi)
3. Configure the switch output as an "NO contact" (HNO function)

The pump is controlled by the defined settings.

8.10 Configuring the local display

8.10.1 Adjusting the local display

The local display can be adjusted in the following menu:

EF → DIS

8.11 Protecting settings from unauthorized access

→  25

9 Diagnostics and troubleshooting

9.1 Troubleshooting

If an inadmissible configuration exists in the device, the device switches to error mode.

Example:

- Diagnostic message "C469", for example, appears on the local display, the status LED is lit red and the background of the local display changes from white to red.
- The switch outputs are opened. The current output adopts the configured alarm current.
- If the device configuration is corrected, e.g. by resetting the device, the device quits the fault state and switches to the measuring mode.
- Errors and warning messages relating to several channels appear on the display with the same error number and associated output.

General errors

Error	Possible cause	Solution
Device is not responding.	Supply voltage does not match that specified on the nameplate.	Apply correct voltage.
	Supply voltage has incorrect polarity.	Reverse polarity of supply voltage.
	Connecting cables are not in contact with the terminals.	Check the contacting of the cables and correct it if necessary.
No display	The local display might be switched off.	Switch on the local display (see the "DOF" parameter description).
Output current ≤ 3.6 mA	Signal cable is not wired correctly.	Check wiring.
Device measures incorrectly.	Configuration error.	Check and correct the parameter configuration.

9.2 Diagnostic events

9.2.1 Diagnostic message

Faults detected by the self-monitoring system of the measuring device are displayed as a diagnostic message in alternation with the measured value display.

Status signals

The table →  42 lists the messages that may occur. The ALARM STATUS parameter shows the message with the highest priority. The device has four different status information codes according to NE107:

F <small>A0013956</small>	"Failure" A device error has occurred. The measured value is no longer valid.
M <small>A0013957</small>	"Maintenance required" Maintenance is required. The measured value remains valid.
C <small>A0013959</small>	"Function check" The device is in service mode (e.g. during a simulation).
S <small>A0013958</small>	"Out of specification" The device is being operated: <ul style="list-style-type: none"> ▪ Outside its technical specifications (e.g. during warmup or cleaning processes) ▪ Outside the parameter configuration undertaken by the user (e.g. level outside of configured range)

Diagnostics event and event text

The fault can be identified by means of the diagnostic event.

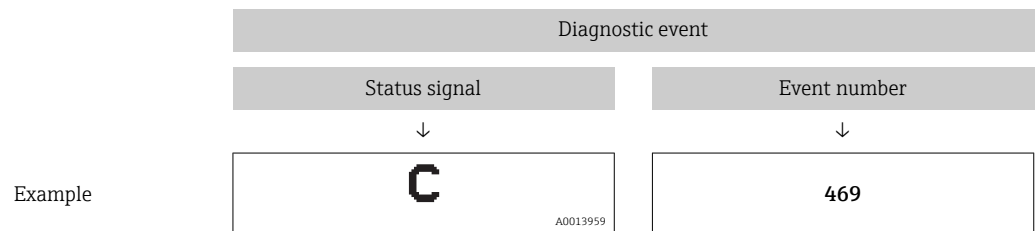

If two or more diagnostic events are pending simultaneously, only the message with the highest priority is shown.

 The last diagnostic message is displayed - see the LST parameter in the **DIAG** submenu →  64.

9.2.2 List of diagnostic events

Diagnostic event		Cause	Corrective measure
Code	Description		
0	No error	-	-
C431 ¹⁾ in the case of an absolute pressure device.	Invalid position adjustment	The adjustment performed would cause the sensor nominal range to be exceeded or undershot.	Position adjustment + parameter of the current output must be within the sensor nominal range <ul style="list-style-type: none"> Check the position adjustment (see the ZRO parameter) Check the measuring range (see the STU and STL parameters)
C432 alternating with Ou1 or Ou2, depending on the switch output selected ¹⁾	Invalid position adjustment, output 1 or 2	The adjustment performed causes switch points to be outside the sensor nominal range.	Position adjustment + parameter of the hysteresis and window function must be within the sensor nominal range <ul style="list-style-type: none"> Check the position adjustment (see the ZRO parameter) Check the switch point, switchback point for hysteresis and window function
C469 alternating with Ou1 or Ou2	Switch points for output 1 or 2 violated	Switch point \leq switchback point	Check switch points at output
C485	Simulation active	During simulation of the switch output or current output, the device issues a warning message for the duration of the simulation.	Switch off simulation
F270 ^{2) 3)}	Overpressure/low pressure	Overpressure or low pressure present	<ul style="list-style-type: none"> Check the process pressure Check the sensor range Restart the device
	Defect in electronics/sensor	Defect in electronics/sensor	Replace device
F437 ²⁾	Incompatible configuration	Invalid device configuration	<ul style="list-style-type: none"> Restart the device Reset device Replace device
F804	Overload at switch output 1 or 2 or at both switch outputs	Load current $>$ 250 mA per output ⁴⁾	Increase load resistance at switch output
		Switch output defective	<ul style="list-style-type: none"> Check output circuit Replace device
S140 ²⁾	Sensor signal outside of permitted ranges	Overpressure or low pressure present	Operate device in the specified measuring range
		Sensor defective	Replace device
S510 ²⁾	Turn down violated	A change in the span results in a violation of the turn down (max. TD 5:1) Values for calibration (lower range value and upper range value) are too close together	<ul style="list-style-type: none"> Operate device in the specified measuring range Check the measuring range
S803 ²⁾	Current loop 2	Impedance of load resistance at analog output is too high	<ul style="list-style-type: none"> Check the cabling and load at the current output. If the current output is not required, switch the current output off via the configuration.

Diagnostic event		Cause	Corrective measure
Code	Description		
	Current output not connected	Current output not connected	<ul style="list-style-type: none"> ■ Connect current output with load. ■ If the current output is not required, switch the current output off via the configuration.
S971	Measured value is outside sensor range	<p>The current is outside the permitted range from 3.8 to 20.5 mA.</p> <p>The present pressure value is outside the configured measuring range (but within the sensor range, if applicable).</p>	Operate the device within the set span

- 1) If no remedial measures are taken, the warning messages are displayed following a device restart if configuration (span, switch points and offset) is performed with a gauge pressure device and readings are $> URL + 10\%$ or $< LRL + 5\%$, and if readings are $> URL + 10\%$ or $< LRL$.
- 2) The switch outputs are opened and the current output adopts the configured alarm current. Therefore, errors affecting the switch output are not displayed since the switch output is in the safe state.
- 3) The device outputs an error current of 0 mA if an internal communication error occurs. In all other cases the device returns the configured error current.
- 4) The device can be subject to a total maximum load current of 500 mA at the switch outputs. This load can be distributed asymmetrically between the two outputs.

9.3 Behavior of the device in the event of a fault



The device displays warnings and faults on the local display and indicates them via the status LEDs. All the device warnings and faults are for information purposes only and do not have a safety function. The errors diagnosed by the device are shown on the local display in accordance with NE107. In accordance with the diagnostic message, the device behaves as per a warning or fault condition. It is necessary to distinguish between the following types of errors here:

- Warning:
 - The device continues measuring if this type of error occurs. The output signal is not affected (exception: simulation is active).
 - The local display alternates between the warning and the main measured value.
 - The switch outputs remain in the state defined by the switch points.
 - Status LED flashes red.
 - The background remains white in the event of a warning
- Fault:
 - The device does **not** continue measuring if this type of error occurs. The output signal adopts its fault state (value in the event of an error - see the following section).
 - The fault state is indicated on the local display.
 - The switch outputs assume the "opened" state.
 - For the analog output option, an error is signaled with the configured alarm current behavior.

9.4 Response of output to errors

The response of the output to error is regulated in accordance with NAMUR NE43.

The response of the current output to errors is defined in the following parameters:

- FCU "MIN": Lower alarm current (≤ 3.6 mA) (optional, see the following table) →  58
- FCU "MAX" (factory setting): Upper alarm current (≥ 21 mA) →  58
- FCU "HLD" (HOLD) (optional, see the following table): Last measured current value is held. When the device starts, the current output is set to "Lower alarm current" (≤ 3.6 mA). →  58

-  ■ The selected alarm current is used for all errors.
- Errors and warning messages are displayed only on the primary value page (topmost display level) and are not displayed in the operating menu.
- In the operating menu the error is only indicated by the color of the display background.
- The status LED always indicates an error.
- It is not possible to acknowledge errors and warnings. The relevant message disappears if the event is no longer pending.
- The failsafe mode can be changed directly when a device is running (see the following table).

Changing the failsafe mode	After confirming with 
from MAX to MIN	active immediately
from MIN to MAX	active immediately
from HLD (HOLD) to MAX	active immediately
from HLD (HOLD) to MIN	active immediately
from MIN to HLD (HOLD)	active outside the fault state
from MAX to HLD (HOLD)	active outside the fault state

9.4.1 alarm current

Device	Description	Option
PTC31B PTP31B PTP33B	Adjusted min. alarm current	IA ¹⁾
PTC31B PTP31B PTP33B	1 low ≤ 3.6 mA 2 high ≥ 21 mA 3 last current value	U ²⁾

1) Product Configurator order code for "Service"

2) Product Configurator order code for "Calibration/unit"

9.5 Behavior of the device in the event of a voltage drop

A diagnostic message is not output. The configuration and the settings made are retained.

9.6 Behavior of the device in the event of an incorrect entry

In the case of incorrect entries, the value entered is not accepted. No fault or warning is issued in this case. The value to be adjusted cannot be changed to a value outside the specified limit. This makes it impossible to configure the device using incorrect values. An exception to this is the configuration of the span that results in a violation of the turn down, which in turn gives rise to a fault state.

9.7 Disposal

When disposing, separate and recycle the device components based on the materials.

10 Maintenance

No special maintenance work is required.

Keep the pressure compensation element (1) free from contamination.

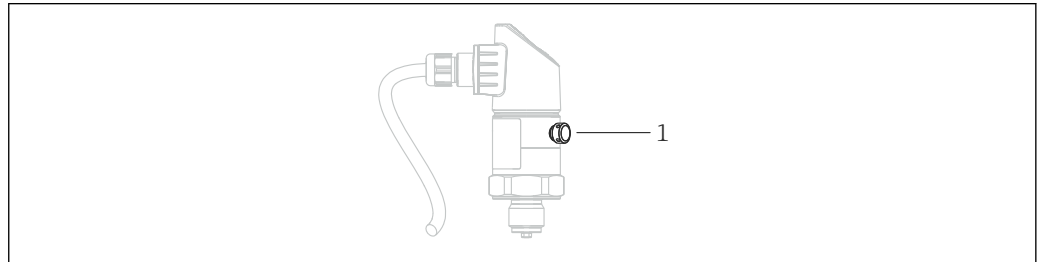

A0022140

10.1 Exterior cleaning

Please note the following points when cleaning the device:

- The cleaning agents used should not corrode the surface and the seals.
- Mechanical damage to the process isolating diaphragm, e.g. due to sharp objects, must be avoided.
- Observe the degree of protection of the device. See the nameplate if necessary →  14.

11 Repairs

11.1 General notes

11.1.1 Repair concept

Repairs are not possible.

11.2 Return

The measuring device must be returned if the wrong device has been ordered or delivered.





























As an ISO-certified company and also due to legal regulations, Endress+Hauser is obliged to follow certain procedures when handling any returned products that have been in contact with medium. To ensure swift, safe and professional device returns, please read the return procedures and conditions on the Endress+Hauser website at www.services.endress.com/return-material

11.3 Disposal

When disposing, separate and recycle the device components based on the materials.

12 Overview of the operating menu

 Depending on the parameter configuration, not all submenus and parameters are available. Information on this can be found in the parameter description under "Prerequisite".

Switch output ¹⁾			Level 0	Level 1	Level 2	Level 3	Description	Details
1 x PNP	2 x PNP	1 x PNP + 4 to 20 mA						
✓	✓	✓	KYL				If "KYL" is shown on the display, this means that the keys of the device are locked. To unlock the keys, see →  25	
✓	✓	✓	SP1				Switch point value, output 1	→  33
✓	✓	✓	RP1				Switchback point value, output 1	→  33
✓	✓	✓	FH1				Upper value for pressure window, output 1	→  35
✓	✓	✓	FL1				Lower value for pressure window, output 1	→  35
		✓	STL				Value for 4 mA (LRV)	→  36
		✓	STU				Value for 20 mA (URV)	→  36
	✓		SP2				Switch point, output 2	→  33
	✓		RP2				Switchback point, output 2	→  33
	✓		FH2				Upper value for pressure window, output 2	→  35
	✓		FL2				Lower value for pressure window, output 2	→  35
✓	✓	✓	EF				Extended functions	
✓	✓	✓	RES				Reset	→  54
✓	✓	✓	dS1				Switching delay time, output 1	→  54
✓	✓	✓	dR1				Switchback delay time, output 1	→  54
	✓		dS2				Switching delay time, output 2	→  54
	✓		dR2				Switchback delay time, output 2	→  54
✓	✓	✓	Ou1				Output 1	
					HNO		NO contact for hysteresis function	→  55
					HNC		NC contact for hysteresis function	→  56
					FNO		NO contact for window function	→  56
					FNC		NC contact for window function	→  56
	✓		Ou2				Output 2	
					HNO		NO contact for hysteresis function	→  55
					HNC		NC contact for hysteresis function	→  56
					FNO		NO contact for window function	→  56
					FNC		NC contact for window function	→  56
		✓	I				Current output	
		✓	GTL				Pressure applied for 4mA (LRV)	→  37
		✓	GTU				Pressure applied for 20mA (URV)	→  37
		✓	FCU				Alarm current	→  58
					MIN		In the event of an error: MIN (≤ 3.6 mA)	
					MAX		In the event of an error: MAX (≥ 21 mA)	
					HLD		Last current value (HOLD)	
		✓	OFF				Switch off the current output (only visible if switch output is "ON")	→  58
		✓	ON				Switch on the current output (only visible if switch output is "OFF")	→  59

Switch output ¹⁾			Level 0	Level 1	Level 2	Level 3	Description	Details
1 x PNP	2 x PNP	1 x PNP + 4 to 20 mA						
✓	✓	✓		UNI			Unit changeover	→ 59
					BAR		Unit bar	
					KPA		Unit kPa (depends on the sensor measuring range))	
					MPA		Unit MPa (depends on the sensor measuring range)	
					PSI		Unit psi	
✓	✓	✓		HI			Max value (maximum indicator)	→ 59
✓	✓	✓		LO			Min value (minimum indicator)	→ 60
✓	✓	✓		ZRO			Zero point configuration	→ 30
✓	✓	✓		GTZ			Zero point adoption	→ 31
✓	✓	✓		TAU			Damping	→ 61
✓	✓	✓		DIS			Display	→ 62
✓	✓	✓			DVA	PV	Display measured value	→ 62
						PV/,	Display the measured value as a percentage of the set span	
						SP	Display set switch point	
✓	✓	✓		DRO			Display measured value rotated by 180°	→ 62
✓	✓	✓		DOF			Display off	→ 62
✓	✓	✓		ADM			Administration	
					LCK		Unlocking code	→ 25
					COD		Locking code	→ 25
✓	✓	✓		DIAG			Diagnostics	
					STA		Current device status	→ 64
					LST		Last device status	→ 64
					RVC		Revision counter	→ 64
✓	✓	✓		SM1			Simulation output 1	→ 64
					OFF			
					OPN		Switch output opened	
					CLS		Switch output closed	
	✓	✓			SM2 ²⁾		Simulation output 2	→ 65
	✓	✓			OFF			
	✓				OPN		Switch output opened	
	✓				CLS		Switch output closed	
		✓			3.5		Simulation value for analog output in mA	
		✓			4.0		Simulation value for analog output in mA	
		✓			8.0		Simulation value for analog output in mA	
		✓			12.0		Simulation value for analog output in mA	
		✓			16.0		Simulation value for analog output in mA	
		✓			20.0		Simulation value for analog output in mA	
		✓			21.95		Simulation value for analog output in mA	

1) The assignment of the outputs cannot be modified.

2) For devices with current output: can only be selected if the current output is switched on.

13 Description of device parameters

13.1 Switch output 1 and switch output 2

13.1.1 Hysteresis (switch point and switchback point)

SP1/SP2 switch point value, output 1/2
 RP1/RP2 switchback point value, output 1/2

Navigation

SP1/SP2
 RP1/RP2

Note

The hysteresis is implemented using the "SP1/SP2" and "RP1/RP2" parameters. Since the parameter settings depend on one another, the parameters are described all together.

- SP1 = switch output 1
- SP2 = switch output 2 (optional)
- RP1 = switchback point 1
- RP2 = switchback point 2 (optional)

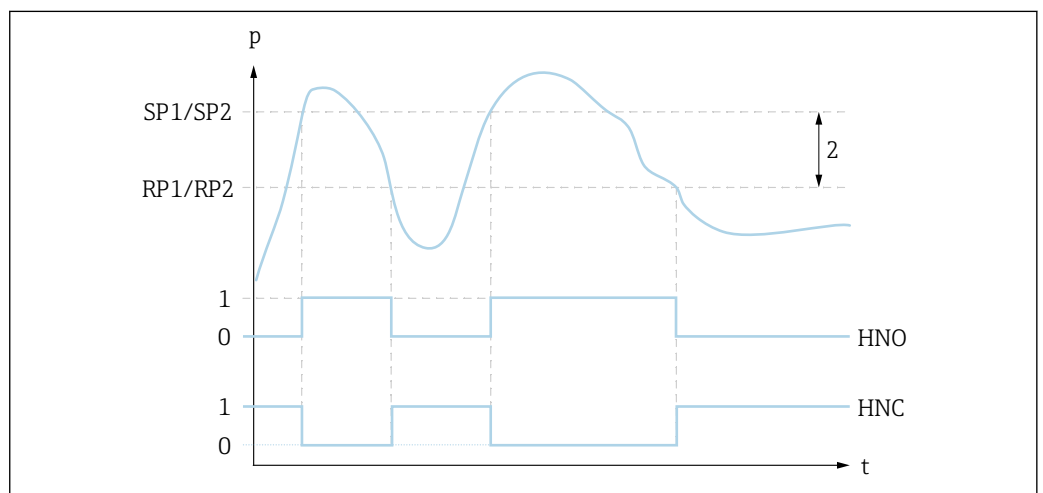

3 SP1/SP2: switch point 1/2; RP1/RP2: switch-back point 1/2

- 0 0-signal. Output open in quiescent state.
- 1 1-signal. Output closed in quiescent state.
- 2 Hysteresis
- HNO Closing
- HNC NC contact

Description

The switch point "SP1/SP2" and the switchback point "RP1/RP2" can be defined with these functions (e.g. for pump control).

When the set switch point "SP1/SP2" is reached (with increasing pressure), an electrical signal change takes place at the switch output.

When the set switchback point "RP1/RP2" is reached (with decreasing pressure), an electrical signal change takes place at the switch output.

The difference between the value of the switch point "SP1/SP2" and the switchback point "RP1/RP2" is known as the hysteresis.

Prerequisite	<ul style="list-style-type: none">■ These functions are only available if the hysteresis function has been defined for the switch output.■ The configured value for the switch point "SP1/SP2" must be greater than the switchback point "RP1/RP2"! A diagnostic message is displayed if a switch point "SP1/SP2" is entered that is \leq the switchback point "RP1/RP2". While it is possible to make this entry, it does not take effect in the device. The entry must be corrected!
Note	To prevent constant switch-on and switch-off if values are around the switch point "SP1/SP2" and switchback point "RP1/RP2", a delay can be set for the relevant points. See the parameter description for "dS1/dS2" and "dR1/dR2" for this purpose.
Options	No selection. The user is free to edit the values.
Factory setting	Factory setting (if no customer-specific setting is ordered): Switch point SP1: 90%; switchback point RP1: 10% Switch point SP2: 95 %; switchback point RP2: 15 %

13.1.2 Window function

- SP1 = switch output 1
- SP2 = switch output 2 (optional)

FH1/FH2 Upper value for pressure window, output 1/2

FL1/FL2 Lower value for pressure window, output 1/2

Navigation

FH1/FH2
FL1/FL2

Note

The window function is implemented using the "FH1/FH2" and "FL1/FL2" parameters. Since the parameter settings depend on one another, the parameters are described all together.

- FH1 = Upper value of pressure window 1
- FH2 = Upper value of pressure window 2 (optional)
- FL1 = Lower value of pressure window 1
- FL2 = Lower value of pressure window 2 (optional)

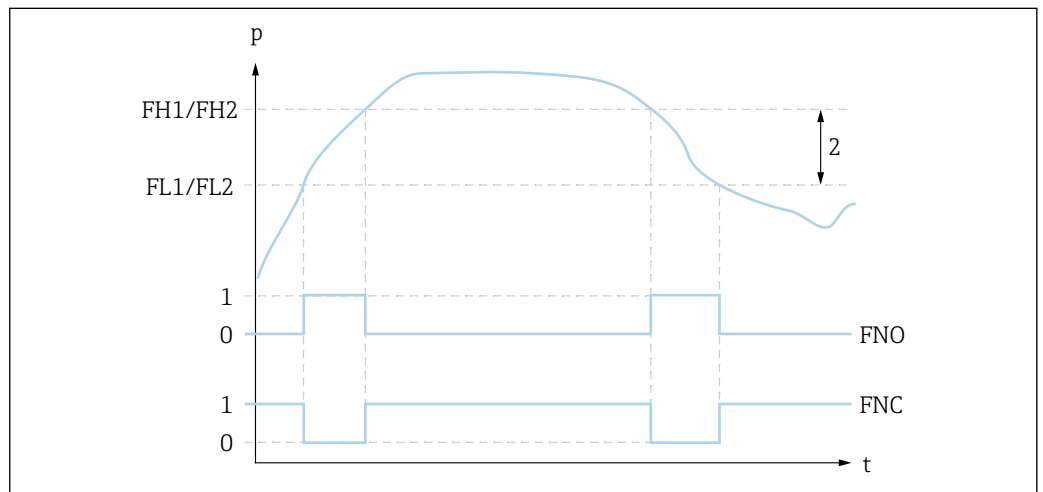

4 FH1/FH2: upper value of pressure window; FL1/FL2: lower value of pressure window

0 0-signal. Output open in quiescent state.

1 1-signal. Output closed in quiescent state.

2 Pressure window (difference between the value of the high window "FH1/FH2" and the low window "FL1/FL2")

FNO Closing

FNC NC contact

Description

The upper value of the pressure window "FH1/FH2" and the lower value of the pressure window "FL1/FL2" can be defined with these functions (e.g. for monitoring a certain pressure range).

When the lower value of the pressure window "FL1/FL2" is reached (with increasing or decreasing pressure), an electrical signal change takes place at the switch output.

When the upper value of the pressure window "FH1/FH2" is reached (with increasing or decreasing pressure), an electrical signal change takes place at the switch output. The difference between the upper value of the pressure window "FH1/FH2" and the lower value of the pressure window "FL1/FL2" is known as the pressure window.

Prerequisite	<ul style="list-style-type: none">■ This function is only available if the window function has been defined for the switch output.■ The upper value of the pressure window "FH1/FH2" must be greater than the lower value of the pressure window "FL1/FL2"! A diagnostic message is displayed if the upper value entered for the pressure window "FH1/FH2" is smaller than the lower value of the pressure window "FL1/FL2". While it is possible to make this entry, it does not take effect in the device. The entry must be corrected!
Note	To prevent constant switch-on and switch-off if values are around the switch point "SP1/SP2" and switchback point "RP1/RP2", a delay can be set for the relevant points. See the parameter description for "dS1/dS2" and "dR1/dR2" for this purpose.
Options	No selection. The user is free to edit the values.
Factory setting	Factory setting if no customer-specific setting is ordered: Switch point FH1: 90 %; switchback point FL1: 10 % Switch point FH2: 95 %; switchback point FH2: 15 %

13.2 Current output

STL value for 4 mA (LRV)

Navigation	STL
Description	Assignment of the pressure value which should correspond to the 4 mA value. It is possible to invert the current output. To do so, assign the pressure upper range value to the lower measuring current.
Prerequisite	Electronic version with current output
Note	Enter the value for 4 mA in the selected pressure unit anywhere within the measuring range. The value can be entered in increments of 0.1 (increment depends on the measuring range).
Selection	No selection. The user is free to edit the values.
Factory setting	0.0 or as per order specifications

STU value for 20 mA (URV)

Navigation	STU
Description	Assignment of the pressure value which should correspond to the 20 mA value. It is possible to invert the current output. To do so, assign the pressure lower range value to the upper measuring current.
Prerequisite	Electronic version with current output
Note	Enter the value for 20 mA in the selected pressure unit anywhere within the measuring range. The value can be entered in increments of 0.1 (increment depends on the measuring range).
Selection	No selection. The user is free to edit the values.
Factory setting	Upper measuring limit or as per order specifications.

13.3 EF menu (extended functions)

RES Reset

Navigation

EF → RES

Description

Confirming the reset by selecting "YES" causes an immediate device reset to the factory settings of the order configuration.

If the factory settings have been changed, downstream processes might be affected following a reset (the behavior of the switch output or current output might be changed).

- ▶ Make sure that downstream processes are not started unintentionally.

To carry out a reset, you must answer the query with "Yes". The reset is not subject to additional locking, such as in the form of device locking. The reset also depends on the device status.

Any customer-specific configuration carried out at the factory is not affected by a reset (customer-specific configuration remains).

The following parameters are **not** reset when a reset is performed:

- LO (Min value (minimum indicator))
- HI (Max value (maximum indicator))
- LST (Last device status)
- RVC (Revision counter)



A reset to the factory settings also includes the locking code configured in the "COD" parameter. The locking code is reset to "0000".

Value at switch-on

NO

Note

Must be actively changed to "YES".
The last error is not reset in a reset.

Options

- NO
- YES

Factory setting

NO

dS1/dS2 switching delay time, output 1/2 dR1/dR2 switchback delay time, output 1/2

Note

The switch delay time/switchback delay time function is implemented using the "dS1/dS2" and "dR1/dR2" parameters. Since the parameter settings depend on one another, the parameters are described all together.

- dS1 = switching delay time, output 1
- dS2 = switching delay time, output 2
- dR1 = switchback delay time, output 1
- dR2 = switchback delay time, output 2

Navigation

EF → dS1/dS2
EF → dR1/dR2

Description

To prevent constant switch-on and switch-off if values are around the switch point "SP1/SP2" or the switchback point "RP1/RP2", a delay in a range of 0 – 50 seconds, to two decimal places, can be set for the individual points.
 If the measured value leaves the switching range during the delay time, the delay time starts again from scratch.

Example

- SP1/SP2 = 2 bar (29 psi)
- RP1/RP2 = 1 bar (14.5 psi)
- dS1/dS2 = 5 seconds
- dR1/dR2 = 2 seconds

dS1/dS2: ≥2 bar (29 psi) must be present for at least 5 seconds for SP1/SP2 to become active.

dR1/dR2: ≤1 bar (14.5 psi) must be present for at least 2 seconds for RP1/RP2 to become active.

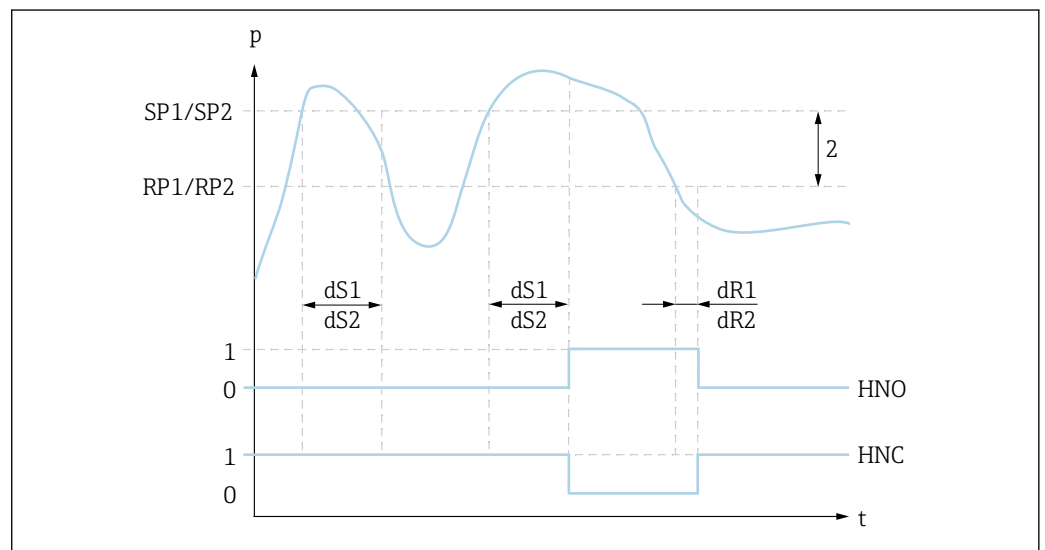

A0022944

- 0 0-signal. Output open in quiescent state.
- 1 1-signal. Output closed in quiescent state.
- 2 Hysteresis (difference between the value of the switch point "SP1/SP2" and the value of the switchback point "RP1/SP2")

HNO Closing
 HNC NC contact
 SP1/ Switch point 1/2
 SP2
 RP1/Switchback point 1/2
 RP2

dS1/ Set time for which the specific switch point must be reached continuously without interruption until an dS2 electrical signal change takes place.
 dR1/ Set time for which the specific switchback point must be reached continuously without interruption until an dR2 electrical signal change takes place.

Value at switch-on 0

Input range 0.00 - 50.00 seconds

Factory setting 0

HNO NO contact for hysteresis function

Navigation	EF → Ou1 → HNO EF → Ou2 → HNO
Description	If this parameter is selected, the switch output is defined as an NO contact with a hysteresis property. Navigate to the parameter and press the  key.
Factory setting	The switch output is opened in the quiescent state (not actuated) and returns a "0" signal.

HNC NC contact for hysteresis function

Navigation	EF → Ou1 → HNC EF → Ou2 → HNC
Description	If this parameter is selected, the switch output is defined as an NC contact with a hysteresis property. Navigate to the parameter and press the  key.
Factory setting	The switch output is closed in the quiescent state (not actuated) and returns a "1" signal.

FNO NO contact for window function

Navigation	EF → Ou1 → FNO EF → Ou2 → FNO
Description	If this parameter is selected, the switch output is defined as an NO contact with a window property. Navigate to the parameter and press the  key.
Factory setting	The switch output is opened in the quiescent state (not actuated) and returns a "0" signal.

FNC NC contact for window function

Navigation	EF → Ou1 → FNC EF → Ou2 → FNC
Description	If this parameter is selected, the switch output is defined as an NC contact with a window property. Navigate to the parameter and press the  key.
Factory setting	The switch output is closed in the quiescent state (not actuated) and returns a "1" signal.

GTL Pressure applied for 4mA (LRV)

Navigation	EF → I → GTL
Description	<p>The pressure value present is automatically adopted for the 4 mA current signal. Parameter for which the current range can be assigned to any section of the nominal range. This occurs by assigning the pressure lower range value to the lower measuring current and the pressure upper range value to the upper measuring current. The pressure lower range value and upper range value can be configured independently of one another so the pressure measuring span does not remain constant. The LRV and URV pressure measuring span can be edited over the entire sensor range. An invalid TD value is indicated by diagnostic message S510. An invalid position offset is indicated by diagnostic message C431. The editing operation cannot result in the device being operated outside the minimum and maximum sensor limits. If the entry is not OK, it is rejected, the message "FAIL" appears on the local display and the last valid value before the change is used again. The measured value currently present is accepted as the value for 4mA anywhere within the measuring range. There is a parallel shift of the sensor characteristic so that the pressure present becomes the zero value.</p>
Selection	<ul style="list-style-type: none"> ■ NO ■ YES
Factory setting	NO

GTU Pressure applied for 20 mA (URV)

Navigation	EF → I → GTU
Description	<p>The pressure value present is automatically adopted for the 20 mA current signal. Parameter for which the current range can be assigned to any section of the nominal range. This occurs by assigning the pressure lower range value to the lower measuring current and the pressure upper range value to the upper measuring current. The pressure lower range value and upper range value can be configured independently of one another so the pressure measuring span does not remain constant. The LRV and URV pressure measuring span can be edited over the entire sensor range. An invalid TD value is indicated by diagnostic message S510. An invalid position offset is indicated by diagnostic message C431. The editing operation cannot result in the device being operated outside the minimum and maximum sensor limits. If the entry is not OK, it is rejected, the message "FAIL" appears on the local display and the last valid value before the change is used again. The measured value currently present is accepted as the value for 20 mA anywhere within the measuring range. There is a parallel shift of the sensor characteristic so that the pressure present becomes the max value.</p>
Selection	<ul style="list-style-type: none"> ■ NO ■ YES
Factory setting	NO

FCU Alarm current

Navigation EF → FCU

Description The device displays warnings and faults. This is done on the local display via the diagnostic message stored in the device. The purpose of all device diagnostics is solely to provide information to the user; they do not have a safety function. The errors diagnosed by the Ceraphant are shown on the display in accordance with NE107. In accordance with the diagnostic message, the device behaves as per a warning or fault condition:

Warning (S971, S140, C485, C431, C432):

With this type of error, the device continues to measure. The output signal does not adopt its fault state (value in the event of an error). The local display alternates (0.5 Hz) between the main measured value and the state in the form of the letter plus a defined number. The switch outputs remain in the state defined by the switch points. The status LED flashes red in addition to the display output.

Fault (F437, S803, F270, S510, C469, F804):

With this type of error, the device does not continue to measure. The output signal adopts its fault state (value in the event of an error). The fault state is shown on the local display in the form of the letter plus a defined number. For a device with 2 outputs, the display alternates (0.5 Hz) between the error and the respective channel assignment (OuX) (exception F804). The switch outputs assume the defined state (open). For the analog output option, an error is also signaled and transmitted via the 4 to 20mA signal. In NE43, NAMUR defines a current ≤ 3.6 mA and ≥ 21 mA as a device failure. A corresponding diagnostic message is displayed. Current levels available for selection:

The selected alarm current is used for all errors. Diagnostic messages are displayed only on the primary value page (topmost display level) with digits and a letter and not in the operating menu – only the display color and LED provide an indication here. It is not possible to acknowledge all the diagnostic messages. The relevant message disappears if the event is no longer pending.

The messages are displayed in order of priority:

- Highest priority = first message displayed
- Lowest priority = last message displayed

Options

- MIN: Lower alarm current (≤ 3.6 mA)
- MAX: Upper alarm current (≥ 21 mA)
- HLD (HOLD): Last measured current value is held. When the device starts, the current output is set to "Lower alarm current" (≤ 3.6 mA). If error S803 or S510 has occurred, the device always outputs a MIN failure current ≤ 3.6 mA irrespective of the configuration. If error S803 occurs during a device restart, the device switches briefly to the measuring mode and by doing so displays the HLD value of the process pressure present and does not output ≤ 3.6 mA.

Factory setting MAX

OFF Switch off current output

Navigation EF → I → OFF

Description Switches off the current output.

Prerequisite Is only displayed if the current output is switched on.

- Selection**
- NO (current output remains switched on)
 - YES (current output is switched off)

Factory setting NO

ON Switch on current output

Navigation EF → I → ON

Description Switches on the current output.

Prerequisite Is only displayed if the current output is switched off.

- Selection**
- NO (current output remains switched off)
 - YES (current output is switched on)

Factory setting NO

UNI unit changeover

Navigation EF → UNI

Description Select the pressure engineering unit. If a new pressure engineering unit is selected, all pressure-specific parameters are converted and displayed with the new unit.

Value at switch-on Depends on order specifications.

- Selection**
- BAR (bar)
 - KPA (kPa) (depends on the sensor measuring range)
 - MPA (Mpa) (depends on the sensor measuring range)
 - PSI (psi)

Factory setting Depends on order specifications.

HI Max value (maximum indicator)

Navigation EF → HI

Description This parameter (also known as the maximum indicator) makes it possible to call up retroactively the highest value ever measured for pressure. A pressure that is present for at least 2.5 ms is logged to the maximum indicator. The maximum indicators cannot be reset.

LO Min value (minimum indicator)

Navigation EF → LO**Description** This parameter (also known as the minimum indicator) makes it possible to call up retroactively the lowest value ever measured for pressure.
A pressure that is present for at least 2.5 ms is logged to the maximum indicator.
The maximum indicators cannot be reset.

ZRO manual position adjustment (typically for absolute pressure sensor)

Navigation EF → ZRO**Description** The pressure resulting from the orientation of the device can be corrected here.
The pressure difference between zero (set point) and the measured pressure must be known.**Prerequisite** An offset is possible (parallel shifting of the sensor characteristic) to correct the orientation and any zero point drift. The set value of the parameter is subtracted from the "raw measured value". The requirement to be able to perform a zero point shift without changing the span is met with the offset function.
Maximum offset value = $\pm 20\%$ of the sensor nominal range.
If an offset value is entered that shifts the span beyond the physical limits of the sensor, the value is admitted but a warning message is generated and shown on the display. The warning message only disappears when the span is within the sensor limits, taking the offset value currently configured into consideration.

The sensor can

- be operated in a physically unfavorable range, i.e. outside its specifications, or
- be operated by making appropriate corrections to the offset or span.

Raw measured value – (manual offset) = display value (measured value)

Example

- Measured value = 2.2 mbar (0.033 psi)
- Set the measured value in the parameter to 2.2.
- Measured value (after position adjustment) = 0.0 mbar
- The current value is also corrected.

Note Setting in increments of 0.1. As the value is entered numerically, the increment depends on the measuring range**Options** No selection. The user is free to edit the values.**Factory setting** 0

GTZ automatic position adjustment (typically for gauge pressure sensor)

Navigation EF → GTZ

Description	The pressure resulting from the orientation of the device can be corrected here. The pressure difference between zero (set point) and the measured pressure need not be known.
Prerequisite	<p>An offset is possible (parallel shifting of the sensor characteristic) to correct the orientation and any zero point drift. The set value of the parameter is subtracted from the "raw measured value". The requirement to be able to perform a zero point shift without changing the span is met with the offset function. Maximum offset value = $\pm 20\%$ of the sensor nominal range. If an offset value is entered that shifts the span beyond the physical limits of the sensor, the value is admitted but a warning message is generated and shown on the display. The warning message only disappears when the span is within the sensor limits, taking the offset value currently configured into consideration.</p> <p>The sensor can</p> <ul style="list-style-type: none"> ■ be operated in a physically unfavorable range, i.e. outside its specifications, or ■ be operated by making appropriate corrections to the offset or span. <p>Raw measured value – (manual offset) = display value (measured value)</p>
Example 1	<ul style="list-style-type: none"> ■ Measured value = 2.2 mbar (0.033 psi) ■ You use the "GTZ" parameter to correct the measured value with the value, e.g. 2.2 mbar (0.033 psi). This means that you are assigning the value 0 mbar (0 psi) to the pressure present. ■ Measured value (after pos. zero adjust) = 0 mbar (0 psi) ■ The current value is also corrected. ■ If necessary, check and correct switch points and span settings.
Example 2	<p>Sensor measuring range: -0.4 to +0.4 bar (-6 to +6 psi) (SP1 = 0.4 bar (6 psi); STU = 0.4 bar (6 psi))</p> <ul style="list-style-type: none"> ■ Measured value = 0.08 bar (1.2 psi) ■ You use the "GTZ" parameter to correct the measured value with the value, e.g. 0.08 bar (1.2 psi). This means that you are assigning the value 0 mbar (0 psi) to the pressure present. ■ Measured value (after pos. zero adjust) = 0 mbar (0 psi) ■ The current value is also corrected. ■ Warnings C431 or C432 appear because the value 0 bar (0 psi) was assigned to the real value of 0.08 bar (1.2 psi) present and the sensor measuring range was thus exceeded by $\pm 20\%$. SP1 and STU values must be readjusted downwards by 0.08 bar (1.2 psi).
Factory setting	0.0

TAU damping

Navigation	EF → TAU
Description	The damping affects the speed at which the measured value reacts to changes in pressure. Damping causes a change in the current value in the "HLD" (HOLD) error current mode.
Input range	0.0 to 999.9 seconds in increments of 0.1 seconds
Factory setting	2 seconds

DVA Measured value display

Navigation	EF → DIS → DVA
Description	Configuration of the measured value display and display of the configured switch point.
Selection	<ul style="list-style-type: none">■ PV = display measured value■ PV,/' = display measured value as a percent (only for devices with a current output)<ul style="list-style-type: none">- 0% is equivalent to LRV- 100% is equivalent to URV■ SP = display set switch point
Factory setting	PV PV,/' (only for devices with a current output)

DRO Display measured value rotated by 180°

Navigation	EF → DIS → DRO
Description	Use this function to rotate the measured value display by 180°.
Selection	<ul style="list-style-type: none">■ NO■ YES

DOF Switch display on or off

Navigation	EF → DIS → DOF
Description	Use this function to switch the display on or off. When the user exits the menu, a 30 second delay elapses until the display (including the back-lighting) switches off.
Selection	<ul style="list-style-type: none">■ NO■ YES

LCK unlocking code

Navigation	EF → ADM → LCK
-------------------	----------------

Description	Use this function to enter the code (which was defined in the COD parameter) to enable configuration. Keys are evaluated but parameters are read only. The parameters can only be changed after unlocking. If an attempt is made to write to a parameter, a prompt for the device access code appears. To unlock, enter the user-defined device access code (which was specified in the COD parameter).
User entry	To unlock: Enter the access code.
Factory setting	0000
Note	The access code is "0000" in the order configuration. Another access code can be defined in the parameter "COD".

COD locking code

Navigation	EF → ADM → COD
Description	A code can be entered to protect parameter settings against unauthorized and unwanted access.
Selection	To lock: Enter a number ≠ the LCK release code (value range: 1 to 9999).
Factory setting	0000

13.4 DIAG menu (diagnosis)

STA Current device status

Navigation	DIAG → STA
Description	Displays the current device status.

LST Last device status

Navigation	DIAG → LST
Description	Displays the last device status (error or warning) which has been rectified during operation.

RVC Revision counter

Navigation	DIAG → RVC
Description	Counter that indicates the number of parameter changes.

SM1 Simulation output 1

Navigation	DIAG → SM1
Description	Switch output simulation. If a simulation is active, a warning to this effect is displayed so that it is obvious to the user that the device is in the simulation mode. A visual warning is indicated on the local display (C485 - Simulation Active). The simulation must be ended actively via the menu. If the device is disconnected from the power supply during the simulation and then power is resupplied afterwards, the simulation mode is not resumed, and instead the device continues operation in the measuring mode.
Selection	<ul style="list-style-type: none">■ OFF■ OPN (switch output open)■ CLS (switch output closed)

SM2 Simulation output 2 (for devices with a 4 to 20 mA current output)

Navigation	DIAG → SM2
-------------------	------------

Description	Analog output simulation. If a simulation is active, a warning to this effect is displayed so that it is obvious to the user that the device is in the simulation mode. A visual warning is indicated on the local display (C485 - Simulation Active). The simulation must be ended actively via the menu. If the device is disconnected from the power supply during the simulation and then power is resupplied afterwards, the simulation mode is not resumed, and instead the device continues operation in the measuring mode.
Selection	<ul style="list-style-type: none">■ OFF■ 3.5■ 4■ 8■ 12■ 16■ 20■ 21.95

SM2 Simulation output 2 (for devices with 2 switch outputs)

Navigation	DIAG → SM2
Description	Switch output simulation. If a simulation is active, a warning to this effect is displayed so that it is obvious to the user that the device is in the simulation mode. A visual warning is indicated on the local display (C485 - Simulation Active). The simulation must be ended actively via the menu. If the device is disconnected from the power supply during the simulation and then power is resupplied afterwards, the simulation mode is not resumed, and instead the device continues operation in the measuring mode.
Selection	<ul style="list-style-type: none">■ OFF■ OPN (switch output open)■ CLS (switch output closed)

14 Accessories

14.1 Weld-in adapter

Various weld-in adapters are available for installation in vessels or pipes.

Device	Description	Option ¹⁾	Order number
PTP33B	Weld-in adapter M24, d=65, 316L	PM	71041381
PTP33B	Weld-in adapter M24, d=65, 316L 3.1 EN10204-3.1 material, inspection certificate	PN	71041383
PTP31B	Weld-in adapter G½, 316L	QA	52002643
PTP31B	Weld-in adapter G½, 316L 3.1 EN10204-3.1 material, inspection certificate	QB	52010172
PTP31B	Weld-in tool adapter G½, brass	QC	52005082
PTP33B	Weld-in adapter G1, 316L, conical metal joint	QE	52005087
PTP33B	Weld-in adapter G1, 316L, 3.1, conical metal joint, EN10204-3.1 material, inspection certificate	QF	52010171
PTP33B	Weld-in tool adapter G1, brass	QG	52005272
PTP33B	Weld-in adapter G1, 316L, silicone O-ring seal	QJ	52001051
PTP33B	Weld-in adapter G1, 316L, 3.1, silicone O-ring seal, EN10204-3.1 material, inspection certificate	QK	52011896

1) Product Configurator, order code for "Enclosed accessories"

If installed horizontally and weld-in adapters with a leakage hole are used, ensure that the leakage hole is pointing down. This allows leaks to be detected as quickly as possible.

14.2 Process adapter M24

The following process adapters can be ordered for the process connections with order option X2J and X3J:

Device	Description	Order number	Order number with inspection certificate 3.1 EN10204
PTP33B	Varivent F DN32 PN40	52023996	52024003
PTP33B	Varivent N DN50 PN40	52023997	52024004
PTP33B	DIN11851 DN40	52023999	52024006
PTP33B	DIN11851 DN50	52023998	52024005
PTP33B	SMS 1½"	52026997	52026999
PTP33B	Clamp 1½"	52023994	52024001
PTP33B	Clamp 2"	52023995	52024002

14.3 M12 plug connectors

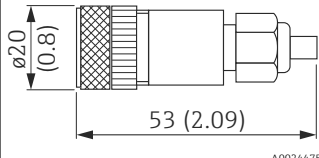
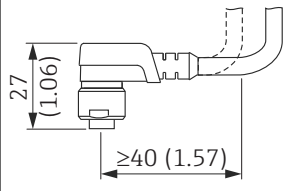
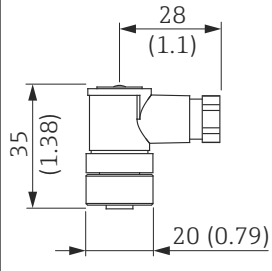
Connector	Degree of protection	Material	Option ¹⁾	Order number
<p>M12 (self-terminated connection at M12 plug)</p>  <p style="text-align: right; font-size: small;">A0024475</p>	IP67	<ul style="list-style-type: none"> ■ Union nut: Cu Sn/Ni ■ Body: PBT ■ Seal: NBR 	R1	52006263
<p>M12 90 degrees with 5m (16 ft) cable</p>  <p style="text-align: right; font-size: small;">A0024476</p>	IP67	<ul style="list-style-type: none"> ■ Union nut: GD Zn/Ni ■ Body: PUR ■ Cable: PVC <p>Cable colors</p> <ul style="list-style-type: none"> ■ 1 = BN = brown ■ 2 = WT = white ■ 3 = BU = blue ■ 4 = BK = black 	RZ	52010285
<p>M12 90 degrees (self-terminated connection at M12 plug)</p>  <p style="text-align: right; font-size: small;">A0024478</p>	IP67	<ul style="list-style-type: none"> ■ Union nut: GD Zn/Ni ■ Body: PBT ■ Seal: NBR 	RM	71114212

1) Product Configurator, order code for "Enclosed accessories"

15 Technical data

15.1 Input

15.1.1 Measured variable

Measured process variable

Gauge pressure or absolute pressure

Calculated process variable

Pressure

15.1.2 Measuring range

Ceramic process isolating diaphragm

Sensor	Device	Maximum Sensor measuring range		Lowest calibratable span ¹⁾	MWP	OPL	Factory settings ²⁾	Option ³⁾
		lower (LRL)	upper (URL)					
		[bar (psi)]	[bar (psi)]					
Devices for gauge pressure measurement								
100 mbar (1.5 psi) ⁴⁾	PTC31B	-0.1 (-1.5)	+0.1 (+1.5)	0.02 (0.3)	2.7 (40.5)	4 (60)	0 to 100 mbar (0 to 1.5 psi)	1C
250 mbar (4 psi) ⁵⁾	PTC31B	-0.25 (-4)	+0.25 (+4)	0.05 (1)	3.3 (49.5)	5 (75)	0 to 250 mbar (0 to 4 psi)	1E
400 mbar (6 psi) ⁶⁾	PTC31B	-0.4 (-6)	+0.4 (+6)	0.08 (1.2)	5.3 (79.5)	8 (120)	0 to 400 mbar (0 to 6 psi)	1F
1 bar (15 psi) ⁶⁾	PTC31B	-1 (-15)	+1 (+15)	0.2 (3)	6.7 (100.5)	10 (150)	0 to 1 bar (0 to 15 psi)	1H
2 bar (30 psi) ⁶⁾	PTC31B	-1 (-15)	+2 (+30)	0.4 (6)	12 (180)	18 (270)	0 to 2 bar (0 to 30 psi)	1K
4 bar (60 psi) ⁶⁾	PTC31B	-1 (-15)	+4 (+60)	0.8 (12)	16.7 (250.5)	25 (375)	0 to 4 bar (0 to 60 psi)	1M
10 bar (150 psi) ⁶⁾	PTC31B	-1 (-15)	+10 (+150)	2 (30)	26.7 (400.5)	40 (600)	0 to 10 bar (0 to 150 psi)	1P
40 bar (600 psi) ⁶⁾	PTC31B	-1 (-15)	+40 (+600)	8 (120)	40 (600)	60 (900)	0 to 40 bar (0 to 600 psi)	1S
Devices for absolute pressure measurement								
100 mbar (1.5 psi) ⁶⁾	PTC31B	0	+0.1 (+1.5)	0.1 (1.5)	2.7 (40.5)	4 (60)	0 to 100 mbar (0 to 1.5 psi)	2C
250 mbar (4 psi) ⁶⁾	PTC31B	0	+0.25 (+4)	0.25 (4)	3.3 (49.5)	5 (75)	0 to 250 mbar (0 to 4 psi)	2E
400 mbar (6 psi) ⁶⁾	PTC31B	0	+0.4 (+6)	0.4 (6)	5.3 (79.5)	8 (120)	0 to 400 mbar (0 to 6 psi)	2F
1 bar (15 psi) ⁶⁾	PTC31B	0	+1 (+15)	0.4 (6)	6.7 (100.5)	10 (150)	0 to 1 bar (0 to 15 psi)	2H
2 bar (30 psi) ⁶⁾	PTC31B	0	+2 (+30)	0.4 (6)	12 (180)	18 (270)	0 to 2 bar (0 to 30 psi)	2K
4 bar (60 psi) ⁶⁾	PTC31B	0	+4 (+60)	0.8 (12)	16.7 (250.5)	25 (375)	0 to 4 bar (0 to 60 psi)	2M
10 bar (150 psi) ⁶⁾	PTC31B	0	+10 (+150)	2 (30)	26.7 (400.5)	40 (600)	0 to 10 bar (0 to 150 psi)	2P
40 bar (600 psi) ⁶⁾	PTC31B	0	+40 (+600)	8 (120)	40 (600)	60 (900)	0 to 40 bar (0 to 600 psi)	2S

- 1) Highest turn down that can be set at the factory: 5:1. The turn down is preset and cannot be changed.
- 2) Other measuring ranges (e.g. -1 to +5 bar (-15 to 75 psi)) can be ordered with customer-specific settings (see the Product Configurator, order code for "Calibration; Unit" option "U"). It is possible to invert the output signal (LRV = 20 mA; URV = 4 mA). Prerequisite: URV < LRV
- 3) Product Configurator, order code for "Sensor range"
- 4) Vacuum resistance: 0.7 bar (10.5 psi) abs
- 5) Vacuum resistance: 0.5 bar (7.5 psi) abs
- 6) Vacuum resistance: 0 bar (0 psi) abs

Maximum turn down which can be ordered for absolute pressure and gauge pressure sensors

Devices for gauge pressure measurement

- 6 bar (90 psi), 16 bar (240 psi), 25 bar (375 psi): TD 1:1 to TD 2.5:1
- All other measuring ranges: TD 1:1 to TD 5:1

Devices for absolute pressure measurement

- 100 mbar (1.5 psi), 250 mbar (4 psi), 400 mbar (6 psi): TD 1:1
- 1 bar (15 psi): TD 1:1 to TD 2.5:1
- All other measuring ranges: TD 1:1 to TD 5:1

Metal process isolating diaphragm

Sensor	Device	Maximum Sensor measuring range		Lowest calibratable span ¹⁾	MWP	OPL	Factory settings ²⁾	Option ³⁾
		lower (LRL)	upper (URL)					
		[bar (psi)]	[bar (psi)]					
Devices for gauge pressure measurement								
400 mbar (6 psi) ⁴⁾	PTP31B PTP33B	-0.4 (-6)	+0.4 (+6)	0.4 (6)	1 (15)	1.6 (24)	0 to 400 mbar (0 to 6 psi)	1F
1 bar (15 psi) ⁴⁾	PTP31B PTP33B	-1 (-15)	+1 (+15)	0.4 (6)	2.7 (40.5)	4 (60)	0 to 1 bar (0 to 15 psi)	1H
2 bar (30 psi) ⁴⁾	PTP31B PTP33B	-1 (-15)	+2 (+30)	0.4 (6)	6.7 (100.5)	10 (150)	0 to 2 bar (0 to 30 psi)	1K
4 bar (60 psi) ⁴⁾	PTP31B PTP33B	-1 (-15)	+4 (+60)	0.8 (12)	10.7 (160.5)	16 (240)	0 to 4 bar (0 to 60 psi)	1M
10 bar (150 psi) ⁴⁾	PTP31B PTP33B	-1 (-15)	+10 (+150)	2 (30)	25 (375)	40 (600)	0 to 10 bar (0 to 150 psi)	1P
40 bar (600 psi) ⁴⁾	PTP31B PTP33B	-1 (-15)	+40 (+600)	8 (120)	100 (1500)	160 (2400)	0 to 40 bar (0 to 600 psi)	1S
100 bar (1 500 psi) ⁴⁾	PTP31B	-1 (-15)	+100 (+1500)	20 (300)	100 (1500)	160 (2400)	0 to 100 bar (0 to 1 500 psi)	1U
400 bar (6 000 psi) ⁴⁾	PTP31B	-1 (-15)	+400 (+6000)	80 (1200)	400 (6000)	600 (9000)	0 to 400 bar (0 to 6 000 psi)	1W
Devices for absolute pressure measurement								
400 mbar (6 psi) ⁴⁾	PTP31B PTP33B	0 (0)	0.4 (+6)	0.4 (6)	1 (15)	1.6 (24)	0 to 400 mbar (0 to 6 psi)	2F
1 bar (15 psi) ⁴⁾	PTP31B PTP33B	0 (0)	1 (+15)	0.4 (6)	2.7 (40.5)	4 (60)	0 to 1 bar (0 to 15 psi)	2H
2 bar (30 psi) ⁴⁾	PTP31B PTP33B	0 (0)	2 (+30)	0.4 (6)	6.7 (100.5)	10 (150)	0 to 2 bar (0 to 30 psi)	2K
4 bar (60 psi) ⁴⁾	PTP31B PTP33B	0 (0)	4 (+60)	0.8 (12)	10.7 (160.5)	16 (240)	0 to 4 bar (0 to 60 psi)	2M
10 bar (150 psi) ⁴⁾	PTP31B PTP33B	0 (0)	10 (+150)	2 (30)	25 (375)	40 (600)	0 to 10 bar (0 to 150 psi)	2P
40 bar (600 psi) ⁴⁾	PTP31B PTP33B	0 (0)	+40 (+600)	8 (120)	100 (1500)	160 (2400)	0 to 40 bar (0 to 600 psi)	2S
100 bar (1 500 psi) ⁴⁾	PTP31B	0 (0)	+100 (+1500)	20 (300)	100 (1500)	160 (2400)	0 to 100 bar (0 to 1 500 psi)	2U
400 bar (6 000 psi) ⁴⁾	PTP31B	0 (0)	+400 (+6000)	80 (1200)	400 (6000)	600 (9000)	0 to 400 bar (0 to 6 000 psi)	2W

1) Highest turn down that can be set at the factory: 5:1. The turn down is preset and cannot be changed.

2) Other measuring ranges (e.g. -1 to +5 bar (-15 to 75 psi)) can be ordered with customer-specific settings (see the Product Configurator, order code for "Calibration; Unit" option "U"). It is possible to invert the output signal (LRV = 20 mA; URV = 4 mA). Prerequisite: URV < LRV

3) Product Configurator, order code for "Sensor range"

4) Vacuum resistance: 0.01 bar (0.145 psi) abs

Maximum turn down which can be ordered for absolute pressure and gauge pressure sensors

Ranges 0.5%/0.3%: TD 1:1 to TD 5:1

15.2 Output

15.2.1 Output signal

Designation	Option ¹⁾
PNP switch output + 4 to 20 mA output (4-wire)	3
PNP switch output (3-wire)	4
2 x PNP switch output (4-wire)	5

1) Product Configurator, order code for "Output"

15.2.2 Range of adjustment

- Switch output
Switch point (SP): 0.5 to 100 % in increments of 0.1% (min. 1 mbar * (0.015 psi)) of the upper range limit (URL) switchback point (RSP): 0 to 99.5% in increments of 0.1% (min. 1 mbar * (0.015 psi)) of the upper range limit (URL)
Minimum distance between SP and RSP: 0.5 % URL
- Analog output (if available)
Lower range value (LRV) and upper range value (URV) can be set anywhere within the sensor range (LRL - URL). Turn down for analog output up to 5:1 of upper sensor limit (URL).
- Factory setting (if no customer-specific setting is ordered):
Switch point SP1: 90 %; switchback point RP1: 10 %;
Switch point SP2: 95 %; switchback point RP2: 15 %;
Analog output: LRV 0 %; URV 100 %

* For measuring ranges with a negative gauge pressure up to 4 bar (60 psi), the increment when setting the switch point is min. 10 mbar (0.15 psi)

15.2.3 Switching capacity

- Switch state ON: $I_a \leq 250$ mA; switch state OFF: $I_a \leq 1$ mA
- Switch cycles: >10,000,000
- Voltage drop PNP: ≤ 2 V
- Overload protection: Automatic load testing of switching current;
 - Max. capacitive load: 14 μ F at max. supply voltage (without resistive load)
 - Max. cycle duration: 0.5 s; min. t_{on} : 4 ms
 - Periodic disconnection from protective circuit in the event of overcurrent ($f = 2$ Hz) and "F804" displayed

15.2.4 Signal range 4 to 20 mA

3.8 mA to 20.5 mA

15.2.5 Load (for devices with analog output)

The maximum load resistance depends on the terminal voltage and is calculated according to the following formula:

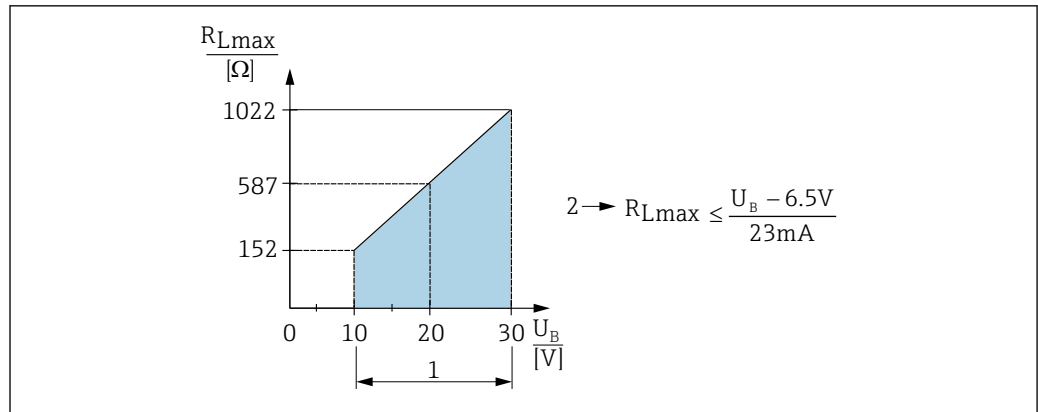

A0031107

- 1 Power supply 10 to 30 V DC
- 2 R_{Lmax} maximum load resistance
- U_B Supply voltage

If load is too great:

- Failure current is output and "S803" displayed (output: MIN alarm current)
- Periodic checking to establish if it is possible to quit fault state

15.2.6 Signal on alarm 4 to 20 mA

The response of the output to error is regulated in accordance with NAMUR NE43.

The response of the current output to errors is defined in the following parameters:

- FCU "MIN": Lower alarm current (≤ 3.6 mA) (optional, see the following table) → 58
- FCU "MAX" (factory setting): Upper alarm current (≥ 21 mA) → 58
- FCU "HLD" (HOLD) (optional, see the following table): Last measured current value is held. When the device starts, the current output is set to "Lower alarm current" (≤ 3.6 mA). → 58

- i** ■ The selected alarm current is used for all errors.
- Errors and warning messages are displayed only on the primary value page (topmost display level) and are not displayed in the operating menu.
- In the operating menu the error is only indicated by the color of the display background.
- The status LED always indicates an error.
- It is not possible to acknowledge errors and warnings. The relevant message disappears if the event is no longer pending.
- The failsafe mode can be changed directly when a device is running (see the following table).

Changing the failsafe mode	After confirming with \square
from MAX to MIN	active immediately
from MIN to MAX	active immediately
from HLD (HOLD) to MAX	active immediately
from HLD (HOLD) to MIN	active immediately
from MIN to HLD (HOLD)	active outside the fault state
from MAX to HLD (HOLD)	active outside the fault state

alarm current

Device	Description	Option
PTC31B PTP31B PTP33B	Adjusted min. alarm current	IA ¹⁾
PTC31B PTP31B PTP33B	1 low ≤3.6 mA 2 high ≥21 mA 3 last current value	U ²⁾

- 1) Product Configurator order code for "Service"
- 2) Product Configurator order code for "Calibration/unit"

15.2.7 Dead time, time constant

Presentation of the dead time and the time constant:

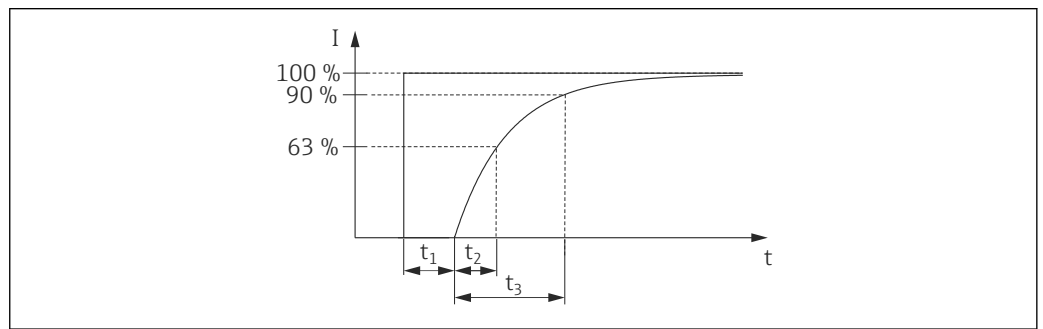

A0019786

15.2.8 Dynamic behavior

Analog electronics

Dead time (t ₁) [ms]	Time constant (T63), t ₂ [ms]	Time constant (T90), t ₃ [ms]
7 ms	11 ms	16 ms

15.2.9 Dynamic behavior of switch output

PNP switch output and 2 x PNP switch output: response time ≤20 ms

15.3 Performance characteristics of ceramic process isolating diaphragm

15.3.1 Reference operating conditions

- As per IEC 60770
- Ambient temperature T_A = constant, in the range of: +21 to +33 °C (+70 to +91 °F)
- Humidity φ = constant, in the range of 5 to 80 % rH
- Ambient pressure p_A = constant, in the range of: 860 to 1 060 mbar (12.47 to 15.37 psi)
- Position of measuring cell = constant, in range: horizontal $\pm 1^\circ$ (see also "Influence of the installation position" section →  16)
- Zero based span
- Material of process isolating diaphragm: Al_2O_3 (aluminum-oxide ceramic, Ceraphire®)
- Supply voltage: 24 V DC ± 3 V DC
- Load: 320 Ω (at 4 to 20 mA output)

15.3.2 Measuring uncertainty for small absolute pressure measuring ranges

The smallest extended uncertainty of measurement that can delivered by our standards is:

- in range 1 to 30 mbar (0.0145 to 0.435 psi): 0.4 % of reading
- in range < 1 mbar (0.0145 psi): 1 % of reading.

15.3.3 Influence of the installation position

→  16

15.3.4 Resolution

Current output: min. 1.6 μ A

Display: can be set (factory setting: presentation of the maximum accuracy of the transmitter)

15.3.5 Reference accuracy

The reference accuracy contains the non-linearity [DIN EN 61298-2 3.11] including the pressure hysteresis [DIN EN 61298-23.13] and non-repeatability [DIN EN 61298-2 3.11] in accordance with the limit point method as per [DIN EN 60770].

Device	% of the calibrated span to the maximum turn down		
	Reference accuracy	Non-linearity ¹⁾	Non-repeatability
PTC31B - standard	± 0.5	± 0.1	± 0.1
PTC31B - platinum	± 0.3	± 0.1	± 0.1

1) The non-linearity for the 40 bar (600 psi) sensor can be up to $\pm 0.15\%$ of the calibrated span up to the maximum turn down.

Overview of the turn down ranges →  69

15.3.6 Thermal change of the zero output and the output span

Measuring cell	-20 to +85 °C (-4 to +185 °F)	-40 to -20 °C (-40 to -4 °F) +85 to +100 °C (+185 to +212 °F)
	% of URL for TD 1:1	
<1 bar (15 psi)	<1	<1.2
≥ 1 bar (15 psi)	<0.8	<1

15.3.7 Long-term stability

1 year	5 years	8 years
% of URL		
±0.2	±0.4	In preparation

15.3.8 Switch-on time

≤2 s (For small measuring ranges, pay attention to the thermal compensation effects.)

15.4 Performance characteristics of metal process isolating diaphragm

15.4.1 Reference operating conditions

- As per IEC 60770
- Ambient temperature T_A = constant, in the range of: +21 to +33 °C (+70 to +91 °F)
- Humidity φ = constant, in the range of 5 to 80 % rH
- Ambient pressure p_A = constant, in the range of: 860 to 1 060 mbar (12.47 to 15.37 psi)
- Position of measuring cell = constant, in range: horizontal $\pm 1^\circ$ (see also "Influence of the installation position" section →  16)
- Zero based span
- Process isolating diaphragm material: AISI 316L (1.4435)
- Filling oil: synthetic oil polyalphaolefin FDA 21 CFR 178.3620, NSF H1
- Supply voltage: 24 V DC ± 3 V DC
- Load: 320 Ω (at 4 to 20 mA output)

15.4.2 Measuring uncertainty for small absolute pressure measuring ranges

The smallest extended uncertainty of measurement that can delivered by our standards is:

- in the range 1 to 30 mbar (0.0145 to 0.435 psi): 0.4 % of reading
- in the range < 1 mbar (0.0145 psi): 1 % of reading.

15.4.3 Influence of the installation position

→  16

15.4.4 Resolution

Current output: min. 1.6 μ A

Display: can be set (factory setting: presentation of the maximum accuracy of the transmitter)

15.4.5 Reference accuracy

The reference accuracy contains the non-linearity [DIN EN 61298-2 3.11] including the pressure hysteresis [DIN EN 61298-23.13] and non-repeatability [DIN EN 61298-2 3.11] in accordance with the limit point method as per [DIN EN 60770].

Device	% of the calibrated span to the maximum turn down		
	Reference accuracy	Non-linearity	Non-repeatability
PTP31B - standard	± 0.5	± 0.1	± 0.1
PTP31B - platinum	± 0.3	± 0.1	± 0.1
PTP33B - standard	± 0.5	± 0.1	± 0.1
PTP33B - platinum	± 0.3	± 0.1	± 0.1

Overview of the turn down ranges →  70

15.4.6 Thermal change of the zero output and the output span

PTP31B

Measuring cell	-20 to +85 °C (-4 to +185 °F)	-20 to -40 °C (-4 to -40 °F) +85 to +100 °C (+185 to +212 °F)
	% of the calibrated span for TD 1:1	
<1 bar (15 psi)	<1	<1.2
≥ 1 bar (15 psi)	<0.8	<1

PTP33B

Measuring cell	-10 to +85 °C (+14 to +185 °F)	+85 to +100 °C (+185 to +212 °F)
	% of the calibrated span for TD 1:1	
<1 bar (15 psi)	<1	<1.2
≥ 1 bar (15 psi)	<0.8	<1

15.4.7 Long-term stability

Device	1 year	5 years	8 years
	% of URL		
PTP31B PTP33B	±0.2	±0.4	In preparation

15.4.8 Switch-on time

≤2 s

15.5 Environment

15.5.1 Ambient temperature range

Device	Ambient temperature range ¹⁾
PTC31B PTP31B PTP33B	-20 to +70 °C (-4 to +158 °F) (in the range of the temperature limits with restrictions in optical properties, such as display speed and contrast)

1) Exception: the following cable is designed for an ambient temperature range of -25 to +70 °C (-13 to +158 °F): Product Configurator order code for "Enclosed accessories" option "RZ".

15.5.2 Storage temperature range

-40 to +85 °C (-40 to +185 °F)

15.5.3 Climate class

Device	Climate class	Note
PTC31B PTP31B PTP33B	Class 3K5	Air temperature: -5 to +45 °C (+23 to +113 °F), relative humidity: 4 to 95 % satisfied according to IEC 721-3-3 (condensation not possible)

15.5.4 Degree of protection

Device	Connection	Degree of protection	Option ¹⁾
PTC31B PTP31B PTP33B	Cable 5 m (16 ft)	IP66/67 NEMA type 4X enclosure	D
PTC31B PTP31B PTP33B	Cable 10 m (33 ft)	IP66/67 NEMA type 4X enclosure	E
PTC31B PTP31B PTP33B	Cable 25 m (82 ft)	IP66/67 NEMA type 4X enclosure	F
PTC31B PTP31B PTP33B	M12 plug	IP65/67 NEMA type 4X enclosure	M
PTC31B PTP31B PTP33B	Valve plug ISO4400 M16	IP65 NEMA type 4X enclosure	U
PTC31B PTP31B PTP33B	Valve plug ISO4400 NPT ½	IP65 NEMA type 4X enclosure	V

1) Product Configurator order code for "Electrical connection"

15.5.5 Vibration resistance

Test standard	Vibration resistance
IEC 60068-2-64:2008	Guaranteed for 5 to 2000Hz: 0.05g ² /Hz

15.5.6 Electromagnetic compatibility

- Interference emission as per EN 61326-1 equipment B
- Interference immunity as per EN 61326-1 (industrial environment)
- Maximum deviation: 1.5% with TD 1:1

For more details, please refer to the Declaration of Conformity.

15.6 Process

15.6.1 Process temperature range for devices with ceramic process isolating diaphragm

Device	Process temperature range
PTC31B	-25 to +100 °C (-13 to +212 °F)

- For saturated steam applications, use a device with a metal process isolating diaphragm, or provide a siphon for temperature isolation when installing.
- Pay attention to the process temperature range of the seal. See also the following table.

Seal	Notes	Process temperature range	Option
FKM	-	-20 to +100 °C (-4 to +212 °F)	A ¹⁾
FKM	Cleaned for oxygen service	-10 to +60 °C (+14 to +140 °F)	A ¹⁾ and HB ²⁾
EPDM 70	-	-25 to +100 °C (-13 to +212 °F)	J ¹⁾

- 1) Product Configurator, order code for "Seal"
 2) Product Configurator, order code for "Service"

Applications with changes in temperature

Frequent extreme changes in temperatures can temporarily cause measuring errors. Temperature compensation takes place after a few minutes. Internal temperature compensation is faster the smaller the change in temperature and the longer the time interval.

For further information please contact your local Endress+Hauser Sales Center.

15.6.2 Process temperature range for devices with metallic process isolating diaphragm

Device	Process temperature range
PTP31B	-40 to +100 °C (-40 to +212 °F)
PTP33B	-10 to +100 °C (+14 to +212 °F)
PTP33B Sterilization in place (SIP)	At +135°C (+275 °F) for a maximum of one hour (device in operation but not within measuring specification)

Applications with changes in temperature

Frequent extreme changes in temperatures can temporarily cause measuring errors. Internal temperature compensation is faster the smaller the change in temperature and the longer the time interval.

For further information please contact your local Endress+Hauser Sales Center.

15.6.3 Pressure specifications

⚠ WARNING

The maximum pressure for the measuring device depends on the lowest-rated element with regard to pressure.

- ▶ For pressure specifications, see the "Measuring range" section and "Mechanical construction" section in the Technical Information.
- ▶ The Pressure Equipment Directive (2014/68/EU) uses the abbreviation "PS". The abbreviation "PS" corresponds to the MWP (maximum working pressure) of the measuring device.
- ▶ MWP (maximum working pressure): The MWP (maximum working pressure) is specified on the nameplate. This value is based on a reference temperature of +20 °C (+68 °F) and may be applied to the device for an unlimited period of time. Observe the temperature dependency of the MWP.
- ▶ OPL (over pressure limit): The test pressure corresponds to the over pressure limit of the sensor and may only be applied temporarily to ensure that the measurement is within the specifications and no permanent damage develops. In the case of sensor range and process connections where the over pressure limit (OPL) of the process connection is smaller than the nominal value of the sensor, the device is set at the factory, at the very maximum, to the OPL value of the process connection. If you want to use the entire sensor range, select a process connection with a higher OPL value.
- ▶ Devices with ceramic process isolating diaphragm: avoid steam hammering! Steam hammering can cause zero point drifts. Recommendation: Residue (water droplets or condensation) may remain on the process isolating diaphragm following CIP cleaning and can result in local steam hammering the next time steam cleaning takes place. In practice, drying the process isolating diaphragm (e.g. by blowing) has proved to prevent steam hammering.

Index

A

Application 9

C

CE mark (declaration of conformity) 10

Cleaning 45

COD (locking code) 25, 63

Configuration of a pressure measurement 28

Configuring pressure measurement 28

D

Declaration of Conformity 10

Designated use 9

DIAG level 64

Diagnostic event 41

Diagnostic events 41

Diagnostic message 41

Diagnostics

 Symbols 41

Disposal 45, 46

DOF 62

dR1/dR2 54

DRO 62

dS1/dS2 54

DVA 62

E

EF level 54

Event text 41

Exterior cleaning 45

F

FCU 58

FH1/FH2 35, 51

Field of application

 Residual risks 9

FL1/FL2 35, 51

FNC 56

FNO 56

G

GTL 37, 56

GTU 37, 57

GTZ 31, 60

H

HI 59

HNC 56

HNO 55

L

LCK (unlocking code) 25, 62

LO 60

Local display

 see Diagnostic message

 see In alarm condition

LST 64

M

Maintenance 45

Media 9

Menu

 Overview 47

 Parameter description 49

N

Nameplate 14

O

OFF 58

ON 59

Operating menu

 Overview 47

 Parameter description 49

Operational safety 10

P

Product safety 10

R

Repair concept 46

RES 54

RP1/RP2 33, 49

RVC 64

S

Safety instructions

 Basic 9

SM1 64

SM2 for devices with 2 switch outputs 65

SM2 for devices with 4 to 20 mA current output 64

SP1/SP2 33, 49

STA 64

Staff

 Requirements 9

Status signals 41

STL 36, 53

STU 36, 53

T

TAU 61

Troubleshooting 40

U

UNI 59

Using measuring device

 Borderline cases 9

 Incorrect use 9

 see Designated use

W

Workplace safety 10

Z

ZRO 30, 60



71404632

www.addresses.endress.com
