

Industrial Pressure Controller

CPC4000





Warning

This Warning symbol indicates that danger of injury for persons and the environment and/or considerable damage (mortal danger, danger of injury) will occur if the respective safety precautions are not taken.



Caution

This Caution symbol indicates danger for the system and material if the respective safety precautions are not taken.



Notice

This Notice symbol does not indicate safety notices but information for a better understanding of the facts.

Table of Contents

1. General Information	8
1.1 Warranty	8
1.2 Important Notice	8
1.3 Radio Frequency Emission Notices	8
1.3.1 FCC Emission Notice	8
1.3.2 CE Emission Notice	9
1.4 Trademarks and Copyrights	9
1.5 Software License Agreement	9
1.6 Mensor Service Plus	9
1.6.1 After the Warranty	9
1.6.2 Calibration Services	9
1.6.3 Certifications and Accreditations	9
1.7 Packaging for Shipment	9
2. Safety Notices	10
2.1 User Responsibilities	10
2.2 General Safety Notices	10
2.3 Warnings and Caution Notices	11
3. General Description	12
3.1 Features	12
3.2 Turning On	13
3.3 Front Panel	14
3.3.1 Power Switch	14
3.3.2 USB Port	14
3.4 Display	15
3.5 Chassis Assembly	16
3.5.1 Control Module	16
3.6 Electrical Block Diagram	17
4. Specifications	18
4.1 Measure Specification	18
4.2 Base Instrument	19
4.3 Approvals and Certificates	20
4.4 Working Ranges of the Controller Modules	20
5. Installation	21
5.1 Unpacking the Instrument	21
5.2 Dimensions (mm)/ inches	22
5.3 Mounting	23
5.4 Rear Panel	23

5.4.1	Pressure Connections	23
5.4.2	Supply Port	24
5.4.3	Exhaust Port	24
5.4.4	Vent Port	24
5.4.5	Measure/Control Port	24
5.4.6	Reference Port	24
5.4.7	Barometric Reference Port	24
5.5	Remote Communication Connections	24
5.6	Power Up	24
6.	Local Operation and Setup	25
6.1	General Operation	25
6.1.1	Setup Applications	25
6.1.2	Display Screen Features	25
6.2	Initial Setup	26
6.2.1	Contact and Version Information Application	26
6.2.2	Language Selection	26
6.3	Application Selection and Parameter Inputs	27
6.4	Applications	28
6.4.1	Home Application	28
6.4.1.1	Range Hold / Autorange	29
6.4.1.2	Control Setpoint	29
6.4.1.3	Units and Pressure Type	33
6.4.1.4	Bar Graph	33
6.4.1.5	Auxiliary Displays	33
6.4.1.6	Zero Button	35
6.4.1.7	Tare Button	36
6.4.1.8	Operating Mode Selection	37
6.4.2	Settings Application	38
6.4.2.1	Languages	38
6.4.2.2	Brightness	39
6.4.2.3	Volume	39
6.4.2.4	User Base Units / Base Units Multiplier	40
6.4.2.5	Barometer Units	40
6.4.2.6	Configuration	41
6.4.3	Control Settings Application	42
6.4.3.1	Control Behavior	43
6.4.3.2	Rate Setpoint	43
6.4.3.3	Stability Parameters	44

6.4.3.4	Control Volume	44
6.4.3.5	Control Limits	45
6.4.3.6	Vent Rate	45
6.4.3.7	Rate Stability Parameters	46
6.4.3.8	Detection Flags	47
6.4.4	Display Settings Application	48
6.4.4.1	Reading Filter	48
6.4.4.2	Reading Resolution	49
6.4.4.3	Cal Functions	49
6.4.4.4	Zero Reference Standard	50
6.4.5	Programs Application	51
6.4.5.1	Edit Programs	51
6.4.6	Favorites Application	53
6.4.7	Information Application	53
6.4.8	Troubleshooting Application	54
6.4.9	Remote Application	55
6.4.9.1	Remote Command Set	55
6.4.9.2	Remote Communication Settings	56
6.4.10	Step Settings Application	58
6.4.10.1	Preset Steps	59
6.4.11	Leak Test Application	60
6.4.12	Burst Test Application	61
6.4.13	Service Application	62
6.4.14	Unlocked Service Application	63
7.	Remote Operation	64
7.1	Command Set	64
7.2	IEEE-488	64
7.2.1	IEEE-488.2 Commands	64
7.3	Ethernet	65
7.4	Serial	66
7.4.1	Serial Cable Requirements	66
7.5	Mensor Command Set	67
7.5.1	Command and Query Format	67
7.5.2	Command Set Definitions	67
7.5.3	Output Formats	68
7.5.4	Mensor Command Set and Queries	68
7.5.5	Units Command Syntax for Measurement Units	79
7.5.6	Error Messages	80

7.6 SCPI Command Set	80
7.6.1 SCPI Commands and Queries	80
7.6.2 Error Messages	83
7.7 DPI 510 Emulation Command Set	85
7.7.1 DPI 510 Supported Commands and Queries	85
7.7.2 DPI 510 Unsupported Commands and Queries	87
7.7.3 DPI 510 Measurement Units	88
7.8 GE PACE (SCPI) Emulation Command Set	89
7.8.1 SCPI GE Supported Commands and Queries	89
7.8.2 Error Messages	97
7.9 USB Software Upgrade	98
8. Options	99
8.1 Barometric Reference (CPX-A-C4-6)	99
8.1.1 Gauge Pressure Emulation	99
8.1.2 Absolute Pressure Emulation	99
8.1.3 Emulation Mode Accuracy	99
8.1.4 Barometric Reference Calibration	100
8.1.5 Barometric Reference Specifications	100
8.2 Additional Transducers (CPR4000)	100
8.2.1 Secondary Transducer Installation	100
8.3 Rack Mount Kit (CPX-A-C4-R)	100
8.4 Fittings	101
8.5 Remote Calibration	101
8.5.1 Remote Calibration Kit for Internal Transducers (CPX-A-C4-4)	101
8.5.2 Barometric Reference Calibration Sled (CPX-A-C4-5)	102
8.5.3 External Calibration Procedures	102
8.6 Automatic Contamination Prevention System	103
8.6.1 Automatic CPS Installation	104
8.6.2 Automatic CPS Specification	105
8.6.2.1 Technical Specification	105
8.6.2.2 Dimensions [mm]/in	106
8.6.3 Automatic CPS Operation	106
8.7 Contamination Prevention Accessories	108
8.7.1 Coalescing Filter (CPX-A-C4-9)	108
8.7.2 Block and Bleed Valve (CPX-A-C4-8)	109
8.8 Pressure Booster	110
9. Maintenance	111

9.1	Beyond the Warranty	111
9.2	Spare Parts	111
9.3	Transducer Removal	112
9.3.2.1	Barometric Reference Removal	113
10.	Calibration	115
10.1	Calibration Services by Mensor or WIKA worldwide	115
10.2	Environment	115
10.3	Pressure Standards	115
10.4	Media	115
10.5	Setup	116
10.6	Calibration Data	117
10.7	One Point Cal Application	117
10.8	Two Point Cal Application	118
10.9	Linearization	119
10.10	Head Pressure	121
11.	Technical Assistance	122
11.1	Options	122
11.2	Logging	123
11.2.1	Remote Logging	123
11.2.2	Pressure Logging	124
11.3	Touchscreen Calibration	125
11.4	Usage	126
12.	Appendix	127
12.1	Measurement Units	127
12.2	Conversion Factors, PSI	128
12.3	Conversion Factors, Millitorr	129
12.4	Conversion Factors, Pascal	130

1 General Information

1.1 Warranty

All products manufactured by Mensor are warranted to be free of defects in workmanship and materials for a period of two year from the date of shipment. No other express warranty is given, and no affirmation of Seller, by words or actions, shall constitute a warranty. SELLER DISCLAIMS ANY IMPLIED WARRANTIES OF MERCHANTABILITY OR FITNESS FOR ANY PARTICULAR PURPOSES WHATSOEVER. If any defect in workmanship or material should develop under conditions of normal use and service within the warranty period, repairs will be made at no charge to the original purchaser, upon delivery of the product(s) to the factory, shipping charges prepaid. If inspection by Mensor or its authorized representative reveals that the product was damaged by accident, alteration, misuse, abuse, faulty installation or other causes beyond the control of Mensor, this warranty does not apply. The judgment of Mensor will be final as to all matters concerning condition of the product, the cause and nature of a defect, and the necessity or manner of repair. Service, repairs or disassembly of the product in any manner, performed without specific factory permission, voids this warranty.

MENSOR MAKES NO WARRANTY OF ANY KIND WITH REGARD TO THIS MANUAL, INCLUDING, BUT NOT LIMITED TO, THE IMPLIED WARRANTIES OF MERCHANTABILITY AND FITNESS FOR A PARTICULAR PURPOSE. Mensor shall not be liable for errors contained herein or for incidental or consequential damages in connection with the furnishing, performance, or use of this material.

1.2 Important Notice

The product specifications and other information contained in this manual are subject to change without notice.

Mensor has made a concerted effort to provide complete and current information for the proper use of the equipment. If there are questions regarding this manual or the proper use of the equipment, contact Mensor at:

Mensor
201 Barnes Drive
San Marcos, TX 78666
tel: 1-512-396-4200
1-800-984-4200 (USA only)
website: www.mensor.com
fax: 1-512-396-1820
email: sales@mensor.com
tech.support@mensor.com

WIKA Alexander Wiegand SE & Co. KG
Alexander-Wiegand-Straße 30
D-63911 Klingenberg / Germany
tel: (+49) 93 72/132-5015
website: www.wika.de
fax: (+49) 93 72/132-8767
email: CTsales@wika.com

1.3 Radio Frequency Emission Notices



Warning

WARNING: USE SHIELDED CABLES TO CONNECT EXTERNAL DEVICES TO THIS INSTRUMENT TO MINIMIZE RF RADIATION.

1.3.1 FCC Emission Notice

This equipment has been tested and found to comply with the limits for a Class A digital device, pursuant to part 15 of the FCC Rules. These limits are designed to provide reasonable protection against harmful interference when the equipment is operated in a commercial environment. This equipment generates, uses, and can radiate radio frequency energy and, if not installed and used in accordance with the instruction manual, may cause harmful interference to radio communications. Operation of this equipment in a residential area is likely to cause harmful interference in which case the user will be required to correct the interference at his or her own expense.

1.3.2 CE Emission Notice

This equipment is of the emission class A, intended for operation in industrial environments. It can cause interference under certain circumstances if operated in other environments, i.e. residential or commercial areas. In this case, the user may be asked to take appropriate measures to correct it.

1.4 Trademarks and Copyrights

Mensor is a registered trademark of Mensor, LP. All other brand and product names are trademarks or registered trademarks of their respective companies. ©2015, Mensor, LP. All rights reserved.

1.5 Software License Agreement

This product contains intellectual property, i.e., software programs, that are licensed for use by the end user/customer (hereinafter “end user”).

This is not a sale of such intellectual property.

The end user shall not copy, disassemble or reverse compile the software program.



Notice

The software programs are provided to the end user “as is” without warranty of any kind, either express or implied, including, but not limited to, warranties of merchantability and fitness for a particular purpose. The entire risk of the quality and performance of the software program is with the end user.

Mensor and its suppliers shall not be held to any liability for any damages suffered or incurred by the end user (including, but not limited to, general, special, consequential or incidental damages including damages for loss of business profits, business interruption, loss of business information and the like), arising from or in connection with the delivery, use or performance of the software program.

1.6 Mensor Service Plus

If you have problems and you don't find the answer in this manual, contact Mensor at 1-800-984-4200 (USA only) or 1-512-396-4200 for personal assistance, or at any of the contact addresses listed on the rear cover of this manual. We are ready to help.

1.6.1 After the Warranty

Mensor's concern with the performance of this instrument is not limited to the warranty period. We provide complete repair, calibration and certification services after the warranty for a nominal fee.

1.6.2 Calibration Services

In addition to servicing our own products Mensor can perform a complete pressure calibration service, up to 30,000 psi, for all of your pressure instruments. This service includes an accredited calibration.

1.6.3 Certifications and Accreditations

Mensor is registered to ISO 9001:2008. The calibration program at Mensor is accredited by A2LA, as complying with both the ISO/IEC 17025:2005 and the ANSI/NCSL Z540-1-1994 standards.

1.7 Packaging for Shipment

If the product must be shipped to a different location or returned to Mensor for any reason through a common carrier it must be packaged properly to minimize the risk of damage.

The recommended method of packing is to place the instrument in a container, surrounded on all sides with at least four inches of shock attenuation material such as styrofoam peanuts.

2 Safety Notices

2.1 User Responsibilities

To ensure safety, the user must make sure that:

- The system is used properly, no dangerous media are used and that all technical specifications are observed.
- The system is operated in perfect operating condition.
- This operation manual is legible and accessible to the user at the system's location.
- The system is operated, serviced and repaired only by authorized and qualified personnel.
- The operator receives instruction on industrial safety and environmental protection, and is knowledgeable of the operating instructions and the safety notices contained therein.

2.2 General Safety Notices



Notice

The system should only be operated by trained personnel who are familiar with this manual and the operation of the instrument.



Warning

WARNING: A condition for trouble-free and safe operation of this system is proper transport, proper storage, installation, assembly and proper use as well as careful operation and maintenance.

Any operation not described in the following instructions should be prohibited. The system must be handled with care required for an electronic precision instrument (protect from humidity, impacts, strong magnetic fields, static electricity and extreme temperatures). Do not insert any objects into the instrument.

The system is powered via the power cable with a voltage that can cause physical injury. Even after disconnecting the system from the power supply, dangerous voltages can temporarily occur due to capacitance.

Extreme care must be taken with pressure connections when using hazardous or toxic media.

Repairs must only be performed by authorized service personnel.



Notice

Additional safety notices are found throughout this manual.

2.3 Warnings and Caution Notices



Warning

WARNING: HIGH PRESSURE! High pressure gases are potentially hazardous. Energy stored in these gases and liquids can be released suddenly and with extreme force. High pressure systems should be assembled and operated only by personnel who have been trained in proper safety practices.



Warning

WARNING: NOT EXPLOSION PROOF! Installation of this instrument in an area requiring devices rated as intrinsically safe is not recommended.



Warning

WARNING: POSSIBLE INJURY! The tubing, valves, and other apparatus attached to the gauge must be adequate for the maximum pressure which will be applied, otherwise physical injury to the operator or bystanders is possible.



Caution

CAUTION: USE THE PROPER PRESSURE MEDIUM! Use only clean, dry, non-corrosive gases unless otherwise specified by Mensor. This instrument is not designed for oxygen use.



Caution

CAUTION: As with most sensitive electronic equipment, switch the power switch off before connecting or disconnecting to a power source to prevent data loss. Do not position the equipment so that it is difficult to disconnect the power jack.



Warning

WARNING: Detachable main power supply cord with inadequate ratings should not be used. See Section 4.0 - Specifications for power ratings.



CAUTION: ESD PROTECTION REQUIRED. The proper use of grounded work surfaces and personal wrist straps are required when coming into contact with exposed circuits (printed circuit boards) to prevent static discharge to sensitive electronic components.

Additional Warning and Caution notices are found throughout this manual.

3 General Description

The CPC4000 Industrial Pressure Controller is a single-channel/multi-range automatic pressure controller designed to test and calibrate a variety of pressure devices such as pressure gauges, pressure switches, sensors, transducers and transmitters in either absolute or gauge pressure modes. The CPC4000 can have up to two highly stable precision transducers and an optional barometric reference. The CPC4000 is available as a desktop or a rack mountable instrument.



Figure 3.1 - Desk top version

3.1 Features

Here is a short list of significant features designed into the CPC4000:

- Up to two highly stable, temperature compensated, internal pressure transducers.
- Broad operating pressure range from -15 ... 3,045 psig/ -1 ... 210 bar or 0 ... 3,060 psia/ 0 ... 211 bar absolute.
- 0.02% Intelliscale-50 accuracy.
- An optional removable / interchangeable internal high accuracy barometric reference transducer providing gauge pressure emulation for absolute ranges and absolute pressure emulation for gauge ranges.
- Auto-ranging between the two pressure transducers to provide seamless transition between all ranges.
- 7" Color LCD with touch screen.
- Leak test and burst test application.
- Multiple languages; change the language for on-screen text and number/date formats by simply touching one of the "national flag" icons available in the setup screen.
- Desk top or rack mount
- Local operation, or command and read remotely.

3.2 Turning On

You can confirm that your CPC4000 is operational right now. Apply power to the power connector on the rear of the instrument with the included power cord, remove any plastic plugs from the rear panel pressure ports, and press the power switch to ON. The system will go through an initialization process, which takes about 30 seconds, and then a display will appear similar to the screen shown below.



Earth Ground! Any power adaptors or surge protection devices that negate the protective earth ground should not be used. The power cord must be accessible and contain a protective earth ground. Do not position the equipment so that it is difficult to remove the power cord.



Ventilation! Do not block airflow to ventilating fans located on rear of instrument.

To see information about the configuration of your new CPC4000, touch the Next Page Button [▶] then the Information Application (App) icon [ⓘ] on the menu and a window will appear listing the Mensor customer service contact, model number and the transducers that are installed. Press the Previous Page Button [◀] then the Home App [🏠] to return to the main screen.



Information Application

Industrial Pressure Controller CPC4000

3.3 Front Panel

The CPC4000 front panel includes a 7" color LCD with touch screen. Operator input is accomplished by pressing the words or symbols and the App icons presented on the display. There is a single discrete on/off button and a USB port on the right hand side. The front panel also shows the model number designation and brand logos.



3.3.1 Power Switch

The power switch is a two-state device with an action similar to that of a ball point pen. Push the button with enough force to latch it in to turn the unit ON. Push it again to release it to turn the system OFF.



Notice

If power to the instrument is interrupted while ON it will shut down until the power is restored, then immediately resume operation.

3.3.2 USB Port

The front panel USB port acts like the Host USB and is intended for future expansion or software upgrades.

3.4 Display

The display is made up of two sections. In the main screen (“Home Application”), the left three fourths shows the operating screen with the control channel. The control channel displays the active pressure reading, units, mode (absolute or gauge), active range of the internal transducer, pressure control setpoint, a bar graph (if enabled), a zero or tare button (if enabled) and any auxiliary displays that have been chosen. The right one fourth of the screen has Application Icons (“Apps”) for setting general instrument settings, control settings, display settings, program settings, favorites plus a “Next Page” button [] that, when pressed, shows a second and third page of icons for information, troubleshooting, remote communication, step setting, leak test, burst test and service applications.

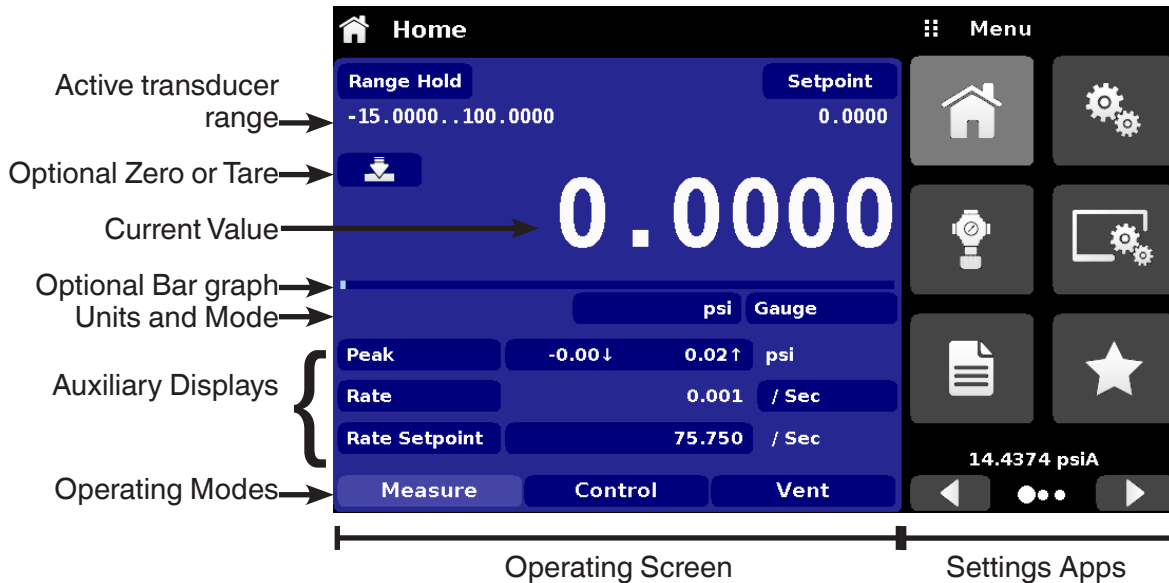

Buttons, Labels and Windows: The CPC4000 touch screen has many buttons with relevant graphic icons or text which, when pressed, will open a related window where changes can be made or information viewed. Some of these buttons will toggle from one state to another, others present choices or display a numerical data entry screen. Text or icons that are displayed, but do not respond to being touched, are called labels or windows. Operators will quickly become accustomed to the particular characteristics of the frequently used buttons.

Main Screen: The main screen or “Home Application”, appears after power-up. This screen contains the operating screen and Settings application screen. It will remain as configured after a power cycle.

Operating screen: The operating screen (left 3/4 of the screen) contains information relevant to the measurement. Up to three auxiliary displays can be shown simultaneously along with the current pressure value. The operating mode of the instrument can be selected and changed in this screen between “Measure”, “Control” and “Vent”.

3.5 Chassis Assembly

The chassis assembly is the housing for the system. The transducers are self-contained inside the chassis and can be replaced using basic hand tools. Figure 3.5 shows the top view of the chassis with the cover removed.

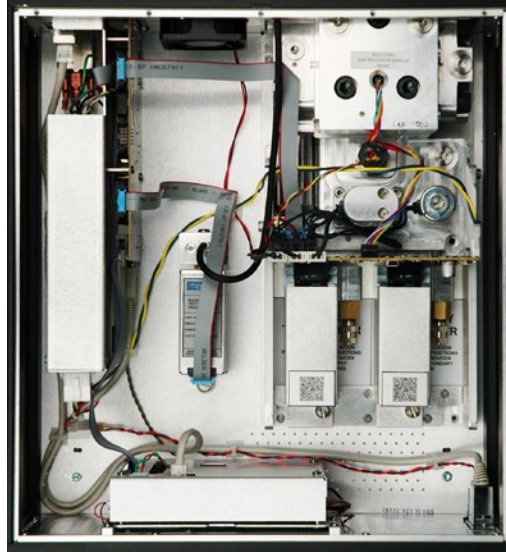

Figure 3.5 – Chassis Assembly

3.5.1 Control Module

The control module is referred to as the “Solenoid Valve Regulator” (SVR Module). The SVR Module is available in four variations depending on the working pressure range:

- Low Pressure SVR Module (LPSVR)
- Medium Pressure SVR Module (MPSVR)
- High Pressure SVR Module (HPSVR)
- Extra High Pressure SVR Module (EPSVR)

Pressure limits for all of these are specified in Section 4, Specifications.

Each control module includes platforms for up to two high performance pressure transducers, CPR4000, which are traceable to NIST standards. Both of these transducers can be used in conjunction with the highly stable pressure regulator to produce a precise output. Each transducer includes its own on-board compensation and calibration data so that any transducer can be replaced in the instrument without requiring a recalibration.



Figure 3.5.1 – Pressure Transducer

3.6 Electrical Block Diagram

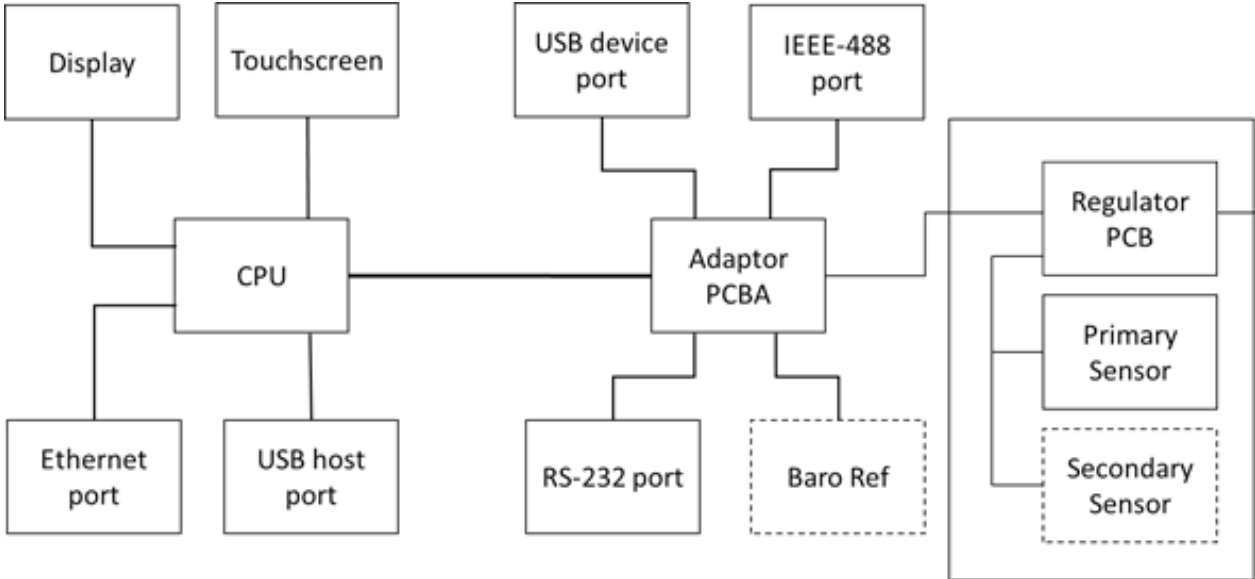

Figure 3.6 – Electrical Block Diagram

4 Specifications

Accuracy specifications presented herein are obtained by comparison with primary standards traceable to a national metrology institute or recognized international standard organization. These specifications are obtained in accordance with the ISO Guide to the Expression of Uncertainty in Measurement (GUM). The calibration program at Mensor is accredited by the American Association of Laboratory Accreditation (A2LA) as complying with both the ISO/IEC 17025:2005 and the ANSI/NC SL Z540-1-1994 standards. If there is an exception to the requirements and recommendations of Z540 during a calibration the exception is noted on the individual calibration certificate.

Mensor reserves the right to change specifications without notice.

4.1 Measure Specification

Reference pressure transducer model CPR4000

Pressure range	Standard	Optional
Accuracy ⁽¹⁾	0.02% FS ⁽²⁾	0.02% IS-50 ⁽³⁾
Gauge pressure	0 ... 0.35 to 0 ... 210 bar (0 ... 5 to 0 ... 3,045 psi)	0 ... 1 to 0 ... 210 bar (0 ... 15 to 0 ... 3,045 psi)
Bi-directional pressure	-0.17 ... 0.17 to -1 ... 210 bar (-2.5 ... 2.5 to -15 ... 3,045 psi)	-1 ... 10 to -1 ... 210 bar (-15 ... 145 to -15 ... 3,045 psi)
Absolute pressure ⁽⁴⁾	0 ... 1 to 0 ... 211 bar abs. (0 ... 15 to 0 ... 3,060 psi abs.)	0 ... 1 to 0 ... 211 bar abs. (0 ... 15 to 0 ... 3,060 psi abs.)
Precision ⁽⁵⁾	0.008% FS	0.008% FS
Calibration interval	365 days	365 days

Optional barometric reference

Function	The barometric reference can be used to switch pressure types ⁽⁶⁾ , absolute <=> gauge. With gauge pressure transducers the measuring range of the transducers must begin with -15 psi (-1 bar) in order to carry out a complete absolute pressure emulation
Measuring range	8 ... 17 psi abs. (552 ... 1,172 mbar abs.)
Pressure units	39 and two freely programmable

1) It is defined by the total measurement uncertainty, with the coverage factor (k = 2) and includes the intrinsic performance of the instrument, the measurement uncertainty of the reference instrument, long-term stability, influence of ambient conditions, drift and temperature effects over the compensated range with recommended zero point adjustment every 30 days.

2) FS = full span

3) 0.02% IS-50 accuracy: Between 0 ... 50% of the full scale, the accuracy is 0.02% of half of the full scale value and between 50 ... 100% of the full scale, the accuracy is 0.02% of reading.

4) The minimum calibrated range of absolute transducer(s) is 600mTorr

5) It is defined as the combined effects of linearity, repeatability and hysteresis throughout the stated compensated temperature range

6) For a pressure type emulation, we recommend a native absolute pressure transducer, since the zero point drift can be eliminated through a zero point adjustment.

4.2 Base Instrument

Instrument	
Instrument version	Standard: desktop case Option: 19" rack-mounting kit
Dimensions	See technical drawings
Weight	approx. 127 kg (28 lbs) with all internal options
Warm-up time	approx. 15 min
Display	
Screen	7.0" color LCD with resistive touchscreen
Resolution	4 ... 6 digits depending on range and units
Connections	
Pressure connections	4 ports with 7/16"- 20 F SAE, 1 port with 1/8" F NPT and 1 port with 10-32 UNF female
Filter elements	The instrument has a 40-micron filters on all pressure ports.
Pressure port adapters	Standard: without Option: 6 mm tube fitting, 1/4" tube fitting, 1/4" female NPT fittings, 1/8" female NPT fittings or 1/8" female BSP fittings
Barometer port adaptors	Standard: barb fitting Option: 6mm tube fitting, 1/4" tube fitting
Permissible pressure media	Dry, clean air or nitrogen (ISO8573-1:2010 Class 5.5.4 or better)
Wetted parts	Aluminum, brass, 316 and 316L stainless steel, Buna N, FKM/FPM, PCTFE, PEEK, PTFE, PPS, glass-filled epoxy, RTV, ceramic, silicone, silicone grease, Urethane
Overpressure protection	Safety relief valve fixed to reference pressure transducer and adjusted to specific measuring range
Permissible pressure	
Supply port	110% FS or 0.69 bar (10 psi), whichever is greater
Measure/Control port	max. 105 % FS
Voltage supply	
Power supply	AC 100 ... 120 V, 50/60 Hz; AC 220 ... 240 V, 50/60 Hz
Power consumption	max. 150 VA
Permissible ambient conditions	
Storage temperature	-20 ... 70 °C (-4 ... 158 °F)
Humidity	5 ... 95 % r. h. (relative humidity, non-condensing)
Compensated temperature range	15 ... 45 °C (59 ... 113 °F)
Mounting position	horizontal
Control parameter	
Control stability	< 0.005% FS of the primary range, in precision mode
Control mode	precision, high speed and custom
Control time	10 s (regarding a 10% FS pressure increase above atm. in a 50 ml test volume, in high speed mode)
Control range	0 ... 100% FS
Minimum control pressure	0.0017 bar (0.025 psi) over exhaust pressure or 0.05% FS whichever is greater
Overshoots	< 1% FS in high speed control mode (typical <0.1% FS in precision control mode)
Test volume	50 ... 1,000 ccm
Communication	
Interface	Standard: Ethernet, IEEE-488, USB, RS-232.
Command sets	Mensor, WIKA SCPI, others optional
Response time	approx. 100 ms
Internal program	up to 24 sequences of 99 steps each

Industrial Pressure Controller CPC4000

4.3 Approvals and Certificates

EC declaration of conformity

EMC directive ⁷⁾	EN 61326-1 emission (group 1, class A) and interference immunity (industrial application)
Low voltage directive	EN 61010-1
RoHS directive	2011/65/EU, article 4

Certificate

Calibration ⁸⁾	Standard: A2LA calibration certificate (standard on factory) Option: DKD/DAkkS calibration certificate
---------------------------	---

7) **Warning!** This is class A equipment for emissions and is intended for use in industrial environments. In other environments, e.g. residential or commercial installations, it can interfere with other equipment under certain conditions. In such circumstances the operator is expected to take the appropriate measures.

8) Calibration in a horizontal position/operating position.

4.4 Working Ranges of the Controller Modules

Bi-directional or gauge pressure [bar (psi)] ¹⁾

-1 (-15)	0	3.4 (50)	10 (150)	100 (1,500)	210 (3,045)
LPSVR MODULE ± 0.17 bar (± 2.5 psi) ²⁾					
MPSVR MODULE ± 0.35 bar (± 5 psi) ²⁾					
HPSVR MODULE -1 ... 5 bar (-15 ... +75 psi) ²⁾					
EPSVR MODULE -1 ... 10 bar (-15 ... +150 psi) ²⁾					

Absolute pressure [bar (psi)] ¹⁾

0	4.4 (65)	11 (165)	101 (1,515)	211 (3,060)
LPSVR MODULE 0 ... 1 bar (0 ... 15 psi) ²⁾				
MPSVR MODULE 0 ... 1 bar (0 ... 15 psi) ²⁾				
HPSVR MODULE 0 ... 6 bar (0 ... +90 psi) ²⁾				
EPSVR MODULE 0 ... 11 bar (0 ... 165 psi) ²⁾				

1) Mixing of absolute pressure and gauge pressure transducers in a module is not possible.

2) Smallest acceptable transducer range

For controlling absolute pressure a vacuum pump connected at the exhaust port is required.

5 Installation



Warning

WARNING: READ THESE INSTRUCTIONS BEFORE INSTALLATION!

5.1 Unpacking the Instrument

In addition to functional testing, each unit is inspected for appearance prior to leaving the factory. Upon receipt, please examine the instrument for shipping damage. Report any apparent damage to the carrier immediately.

In addition to this manual you should have:

- CPC4000 Industrial Pressure Controller
- Power Cord
- Fitting adapters ordered
- Any accessories ordered
- An envelope containing the calibration certificate(s)
- A Quick Start Guide for all Mensor products
- A USB drive containing all Mensor manuals

Industrial Pressure Controller CPC4000

5.2 Dimensions (mm)/ inches

Front view

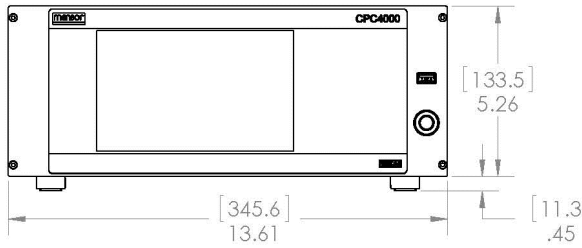

Side view

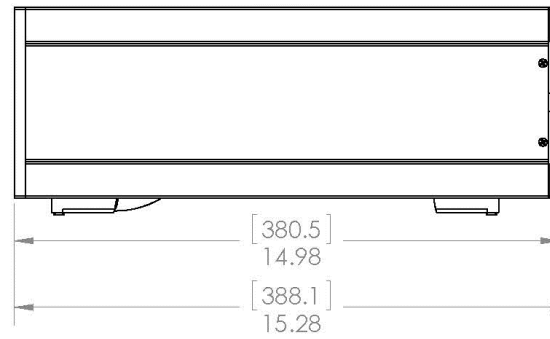

19" rack mount

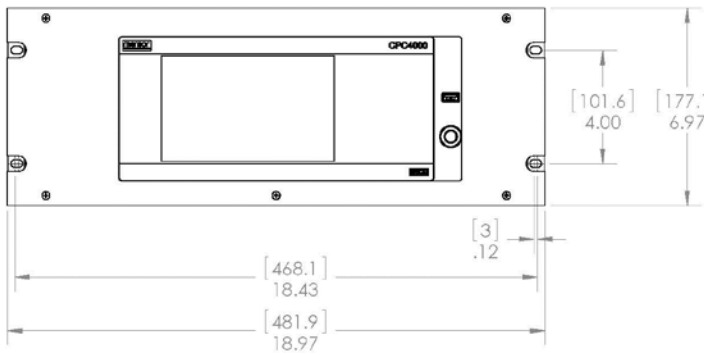

Rear Panel

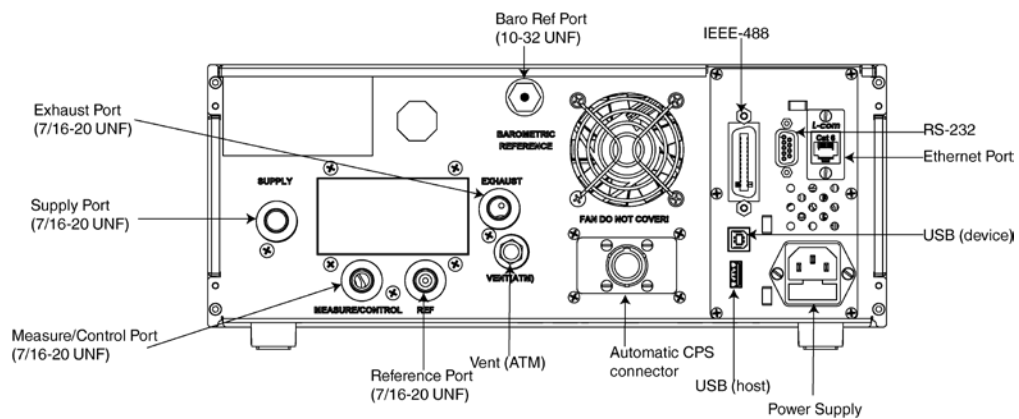

5.3 Mounting

The instrument can be set up on a desk top or it can be rack-mounted. Rack mount hardware is optional on the CPC4000 (see Section 5.2 Dimensions and Section 8, Options).

The special transducers used in the CPC4000 are relatively insensitive to tilt and vibration. However to further assure stability and accuracy, avoid mounting the instrument on surfaces subject to excessive motor or machinery vibration.

5.4 Rear Panel

Five pneumatic pressure ports are located across the rear panel. Any instrument containing sub-atmospheric pressure ranges needs a vacuum pump to be connected at the exhaust port. The instruments with pressures above or at atmospheric pressures will have the exhaust port open. Next to the ventilation fan is a 10-32 UNF fitting which is connected to the barometric reference if installed. Below the ventilation fan is the connection to drive the automatic contamination prevention system. Positioned on the right side is a remote communication connections; RS-232, Ethernet, IEEE- 488, USB along with the USB host connection.

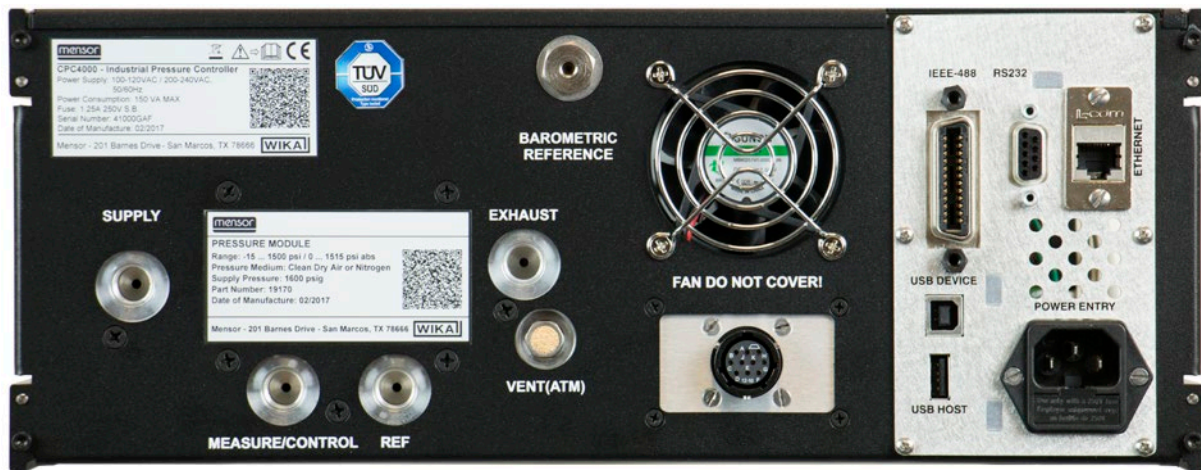

Figure 5.4 A – Rear Panel

5.4.1 Pressure Connections



Warning! The pressure connections must be installed according to the following instructions, observing the relevant regulations. The installation is to be performed by trained, authorized personnel, knowledgeable in the safety regulations for working on pneumatic/hydraulic systems.



Five pressure connections are on the rear panel. Plugged connections are not used.

All pressure ports on the rear apart from the Vent Port are female 7/16 - 20 SAE/MS straight threads per MS16142 and SAE J514 table 14. Connected adaptors require a tube fitting boss seal with an o-ring per MS33656. Mensor can provide a variety of adapter fittings (see Section 8 Options) with the instrument. Do not use sealant on fittings sealed with an o-ring. The integrity of each seal is particularly important since even microscopic leaks can cause errors in pressure measurements.

5.4.2 Supply Port

The pressure supplied to the pressure connection labeled “Supply” should be approximately 10% higher than the full scale of the highest pressure transducer installed in the controller or 10 psi, whichever is greater (see section 6.2.1).

5.4.3 Exhaust Port

The pressure connection labeled “Exhaust” is for the vacuum supply. In a gauge pressure version it can be left open to atmospheric pressure.

5.4.4 Vent Port

The pressure connection labeled “Vent” is the exhaust port where the system pressure is vented to the atmosphere under certain conditions. This port has a breather vent installed that acts like a muffler. Leave this port open.

5.4.5 Measure/Control Port

The Measure/ Control port (when in the Control mode) supplies pressure that is precisely controlled by the controller. In the Measure mode, a pressure applied to the Measure/Control port is measured by the internal transducers.

5.4.6 Reference Port

The pressure connection labeled “Reference” is the reference port, it is available to connect to the reference side of the transducer. This port is normally left open to atmosphere but may be connected to a stable reference pressure. In an absolute pressure transducer this port is not used.

5.4.7 Barometric Reference Port

The Barometric Reference port is connected to the optional internal barometer and should be left open to atmospheric pressure.

5.5 Remote Communication Connections

See Section 7, Remote Operation, for connections and commands for operation over IEEE-488, Ethernet, USB or RS-232 ports.

5.6 Power Up

Apply power to the power connector on the rear of the instrument using the power cord included, and switch the power switch on the front of the unit ON. The instrument will go through an initialization process and system check. As soon as the system check is completed the system will default to a screen similar to the one shown in Section 6.1.2 - Display Screen Features. The main screen may be configured in many different ways but initially it will be in a default configuration. Subsequently, the unit will power up in the configuration that it was in when last powered off. Allow at least 15 minutes of warm up before performing critical pressure measurements.

Do not position the equipment so that it is difficult to remove the power cord. The instrument is not intended for connection of long-distance lines, i.e. lines within a building that are longer than 30 m, or that leave the building (including lines of outdoor installations).

6 Local Operation and Setup

6.1 General Operation

This section describes the procedures for operating the CPC4000 from the front panel. Instructions for operating the device remotely from an external computer are covered in Section 7, Remote Operation. By following the procedures provided in these two sections and Section 10, Calibration, you can expect your CPC4000 to deliver maximum accuracy and dependability for many years of useful service.

6.1.1 Setup Applications

Configuration of the CPC4000 is achieved by changing settings accessed through the Application (“App”) buttons. Local operation is accomplished by observing the data presented in the display. The appearance and functionality of the display can be changed by pressing the App button for the related function. After an app has been chosen, a set of related parameters will appear. After choosing one of these parameters, a set of selections related to that parameter will appear or a data entry keypad.

The desired selection or data can be entered here.

6.1.2 Display Screen Features

The screen shown below provides an overview of the features shown on the display after initialization. The left three fourths of the display contains the area where information is displayed (in this case the Home Application) and the right one fourth contains the selection icons for each application. A zero or tare button, bar graph and auxiliary displays (Peak, Rate, Rate Setpoint, Uncertainty, Units or Barometer) will appear in the Home App if activated. All of the CPC4000 screen features are described in more detail throughout this manual. The active App is represented in a lighter gray color as compared to the other Apps.

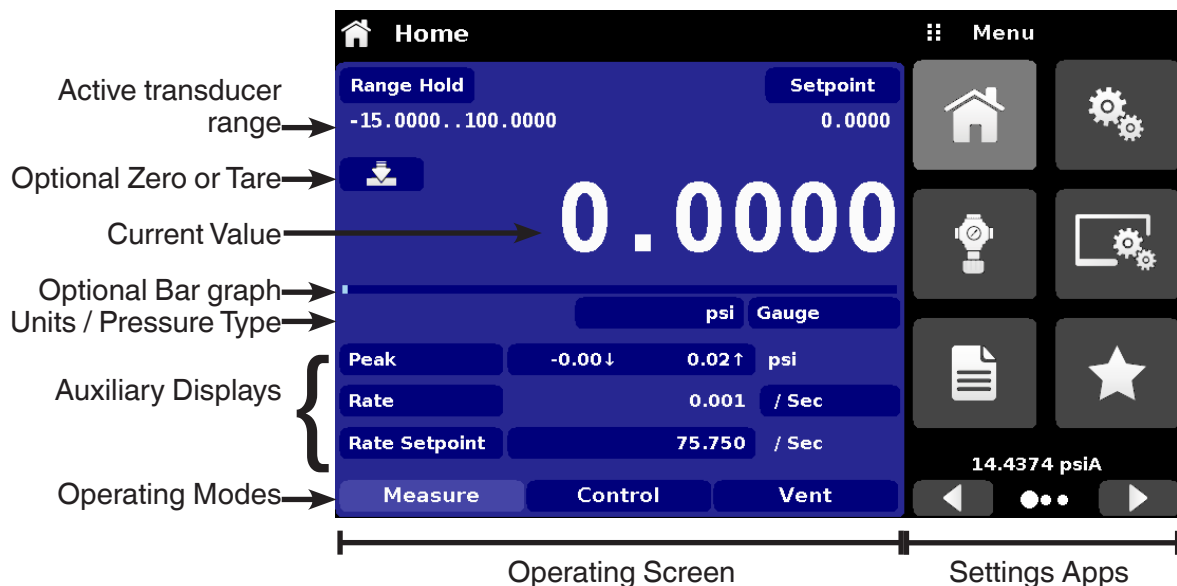

Figure 6.1.2 – Display Screen Features

Industrial Pressure Controller CPC4000

6.2 Initial Setup

Section 6.2.1 and 6.2.2 are provided first so that the operator can initially check the information screen to verify the installed components and to change the language if needed.

6.2.1 Contact and Version Information Application



Navigate to the App selection area by pressing the Next Page button [] at the right bottom under the App buttons. This gives access to the second page of the App selection area. Press the Information App button [] to display Mensor contact, installed transducers, installed regulator along with instrument and software version information.

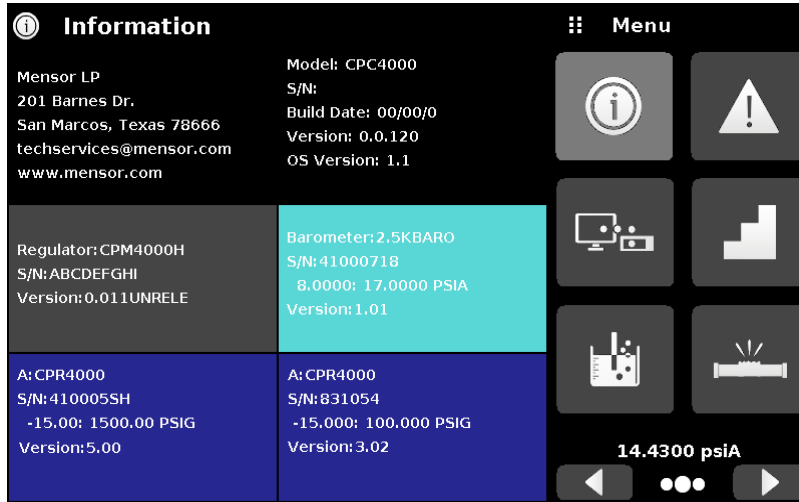

Figure 6.2.1 – Information

6.2.2 Language Selection



Pressing the settings application button will open a screen where the language, display brightness, volume, user base units/multiplier and configuration loading/saving, can be changed. The current language selections available are shown in the table below. Additional language choices will appear on the screen after pushing the Next Page button []:

Language	Country
English	USA
German	Germany
French	France
Spanish	Spain
Italian	Italy
Chinese	China
English	Great Britain
German	Switzerland
French	Switzerland
Spanish	Mexico
Russian	Russia
Korean	Korea
English	Canada
French	Canada
Polish	Poland
Japanese	Japan

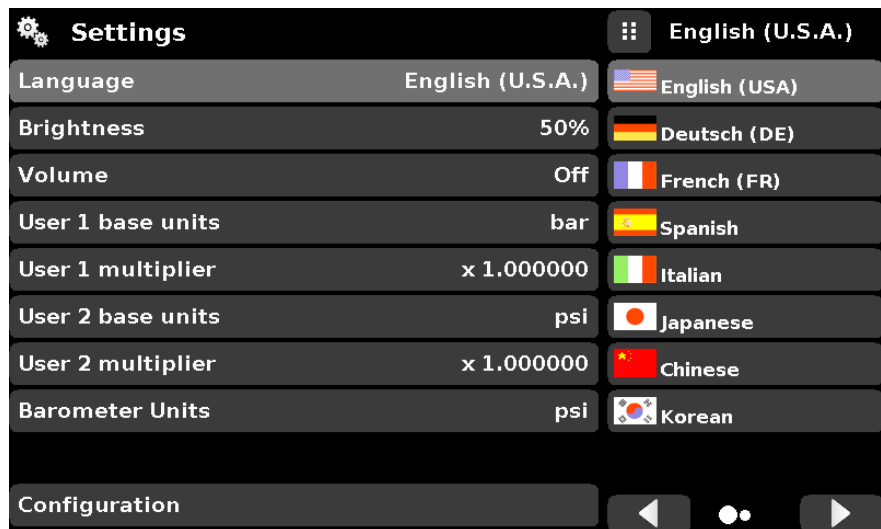

6.3 Application Selection and Parameter Inputs

The application selection/input area on the right one fourth of the screen (see Figure 6.1.2 - Display Screen Features) is the area where setup, information, calibration, service and other Apps can be chosen. Multiple pages of application selections can be accessed by pressing the Next Page button [▶] or by pressing the Previous Page button [◀]. A series of horizontally placed circles on the bottom right represents the number of pages and indicate the active page by a larger circle. As each App is chosen, related application parameters will appear on the left three fourths of the screen along with the name of the application, and a reduced size icon in the top title section. When a parameter is chosen, related selections, sliding scales or a data entry key pad will appear in the input area on the right where the application selection buttons were previously displayed. An example of each type of input is shown below. To return to the App selection menu, simply press the Menu button [☰] above the input area. The purpose and use of each selection and menu is intuitively apparent and will become second nature with minimal exposure to the menu structure.

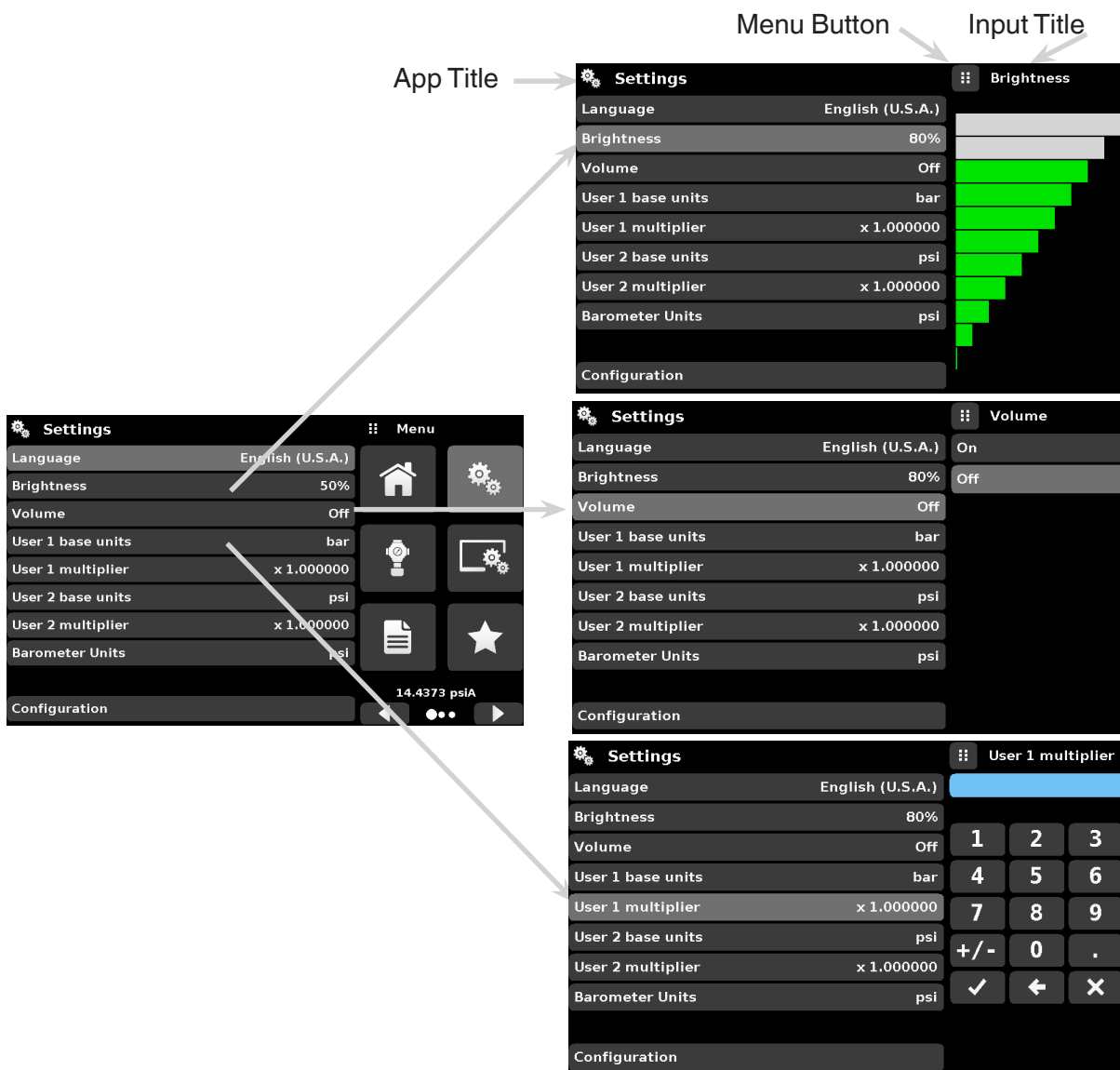

6.4 Applications

6.4.1 Home Application



The Home App is the normal operation screen. This application is different from the others in that it is not used to setup the configuration but is used to monitor the pressure applied to the installed transducers and the device under test through the measure / control port.

The screen in figure 6.4.1-A shows the basic Home App in an instrument. The user can change the display to show multiple auxiliary displays by pressing the auxiliary button on the left corner of the screen (figure 6.4.1-B). The Units button is always displayed. When the Units button is pressed a selection of imperial and metric units will be displayed on the right (figure 6.4.1-C); notice that the Units button has a lighter background when the selection menu is active. If a barometric reference is installed, the Mode button, described below, will toggle from Gauge to Absolute mode when pressed.



Figure 6.4.1-A – Basic Home App

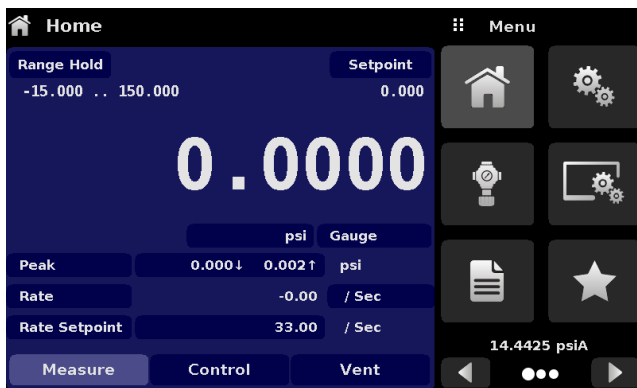

Figure 6.4.1-B – Single Channel Display

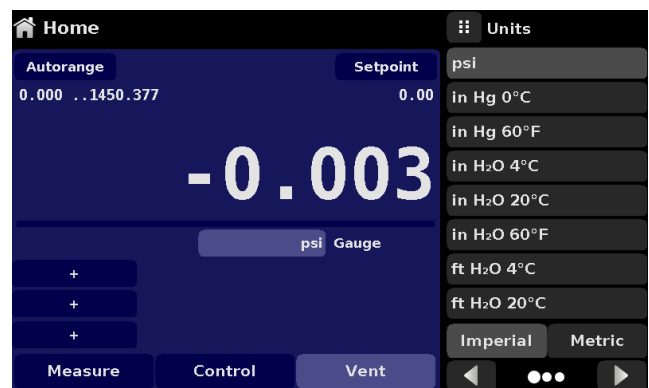

Figure 6.4.1-C – Pressure Units

6.4.1.1 Range Hold / Autorange

The Range Hold / Autorange button allows the user to select the active range. By clicking the Range Hold button, the user can select the active transducer from the primary and secondary transducers or utilize the “Autorange” feature to let the instrument automatically select the active range based on the current pressure value.

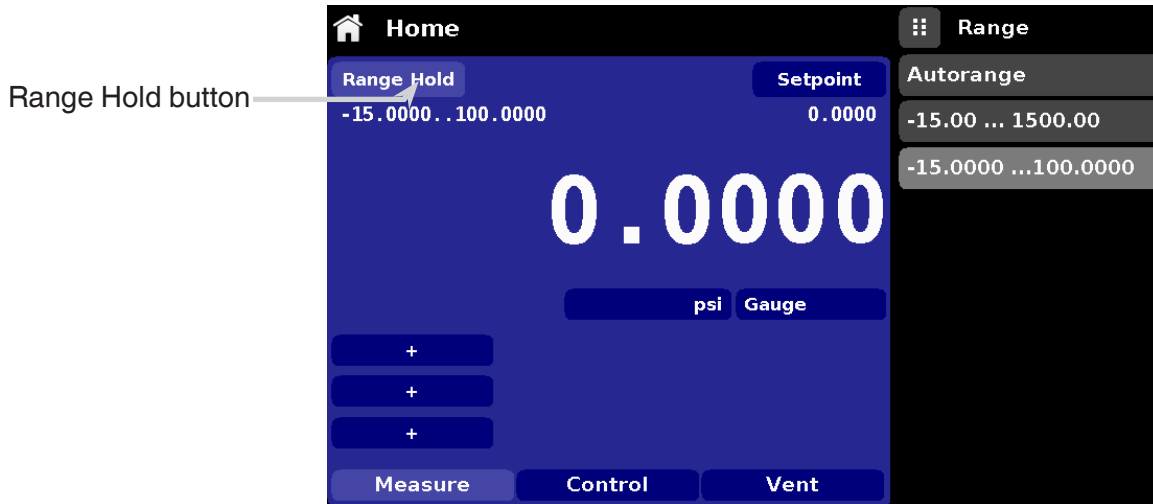

Figure 6.4.1.1 – Mode Label

6.4.1.2 Control Setpoint

The Setpoint button allows the user to enter the desired pressure value to be controlled by the instrument. There are multiple ways of entering the control setpoint: numeric keypad, step increments, percentage entry, digital step or a program data entry. These methods can be accessed by the user by pressing the “Setpoint” button and the various setpoint entry methods can be navigated with the Next Page [▶] and Previous Page [◀] buttons.

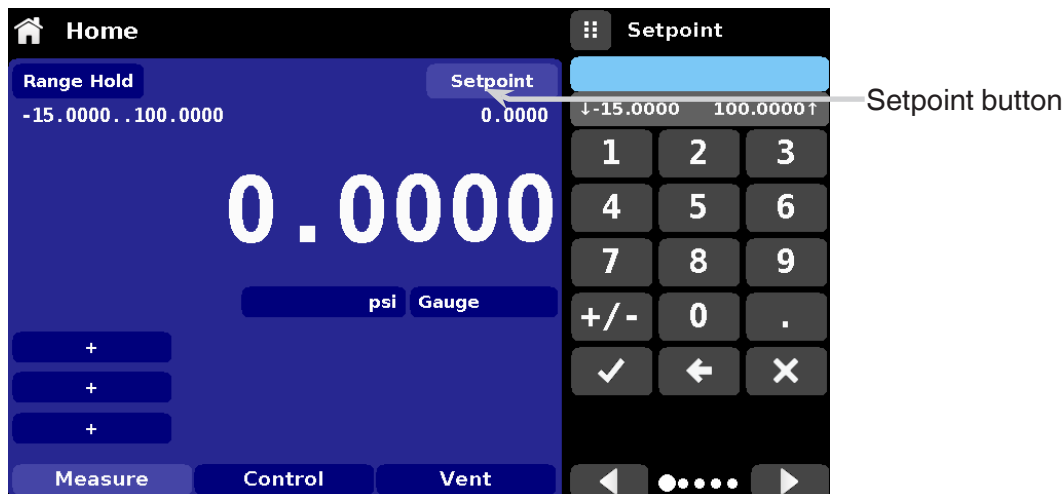

Figure 6.4.1.2 – Setpoint Button

6.4.1.2.1 Numeric Keypad

The first entry method provides 10 digits for numeric entry, plus the decimal point and a sign key (figure 6.4.1.2.1). The sign key [+/-] will toggle between positive and negative values. Each stroke on the keypad will echo in the blue input value window above the pad. A change between plus and minus values [+/-] can be entered at any time during the string entry. Pressing the Enter [✓] button will accept the value and it will become the setpoint.

If the input window holds an illegal value when the Enter button is pressed the system will respond with an error tone and the entry will turn red. When that happens determine the cause of rejection, delete the entry using the Delete [X] button and then enter a valid number. The setpoint can only be entered within the minimum and maximum control range set in the Control Settings App (section 6.4.3.5). These limits are shown above the numeric entry keypad.

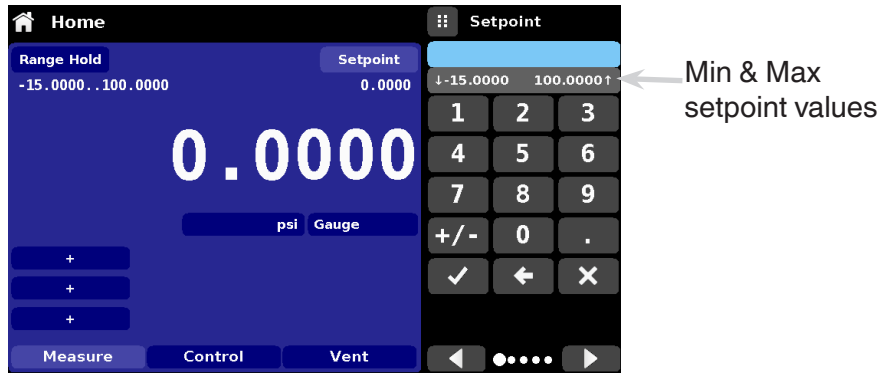

Figure 6.4.1.2.1 – Numeric Keypad Setpoint Entry

6.4.1.2.2 Step Increments

The second entry method allows the user to enter the setpoint in the same way as the Numeric Keypad by keying in the value and then pressing the Enter [✓] button. The user can then enter the desired value of step increment and press the Step Up [▲] or Step Down [▼] button, without pressing the Enter button. This number will then be used to decrease or increase the existing setpoint value. Subsequent touches of the Step Up or Step Down button will continue to increase or decrease the setpoint by the step value. If the Enter button is pressed the newly entered value will register as a new setpoint value on the Home Screen rather than a step value.

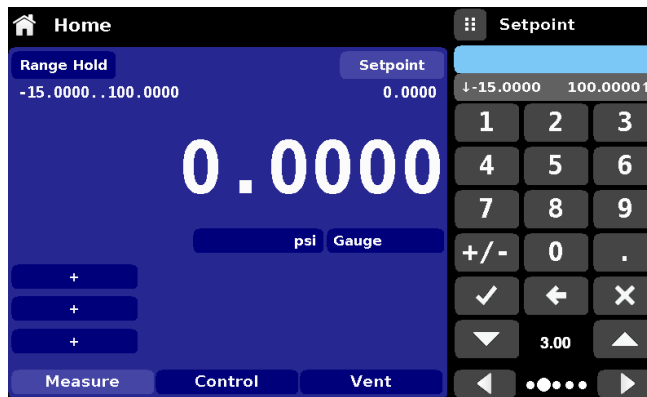

Figure 6.4.1.2.2 – Numeric Keypad with Step Increments

6.4.1.2.3 Percentage Entry

The third entry method is the Percentage Entry method (figure 6.4.1.2.3-A) which allows the user to select a setpoint value as a percentage of the pressure range of device under test (DUT). The user can choose between various percentage values by clicking on the desired button. The setpoint will instantly change to the selected percentage value of the DUT. Alternatively, the setpoint can also be selected as a specific pressure value within the range of the DUT. The user can also configure the minimum and maximum pressure values of DUT by clicking the button displaying pressure range (figure 6.4.1.2.3-B). This would take the user to the Step Settings App (figure 6.4.1.2.3-C) which is explained in Section 6.4.10, Step Settings.



Figure 6.4.1.2.3-A – DUT Percentage Entry



Figure 6.4.1.2.3-B – DUT Pressure Value Entry

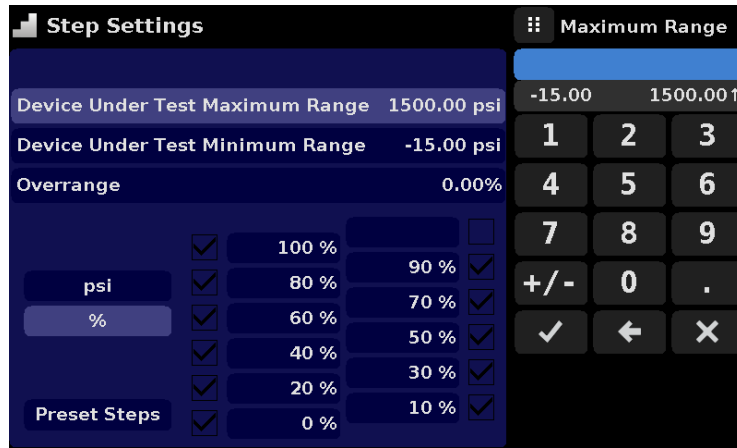

Figure 6.4.1.2.3-C - Step Settings App

6.4.1.2.4 Digital Step Entry

The fourth entry method is the Digital Step data entry method. This method allows the user to increase or decrease the setpoint value by one digit at a time. The digit to be changed can be selected from a string of five zeroes (0) and one blue numeral one (1) by sliding a finger across the zeroes and converting the desired digit to a blue 1. The right most digit in the Digital Step corresponds to the least significant digit of the setpoint. Each digit of the setpoint can then be increased or decreased by pressing the Up [▲] or Down [▼] button.

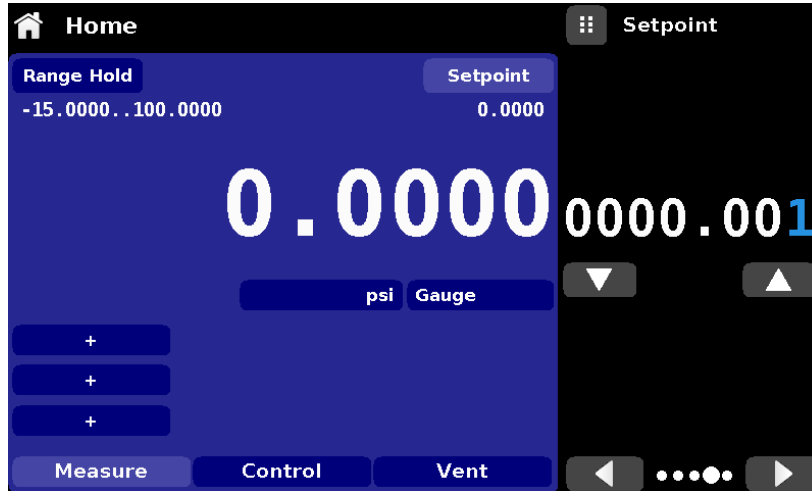

Figure 6.4.1.2.4 – Digital Step Entry

6.4.1.2.5 Program Data Entry

The fifth entry method is through the automated Programs stored in the CPC4000 memory. The Program Player allows the user to select one of the stored Programs and use it for setpoint entry. A Program can be chosen either by using the Up [▲] or Down [▼] buttons or by clicking the program name. After selecting the desired program, press the Play [▶] button to start the program. More information on the Program Player and how to create/ edit programs is available in section 6.4.5, Programs Application.

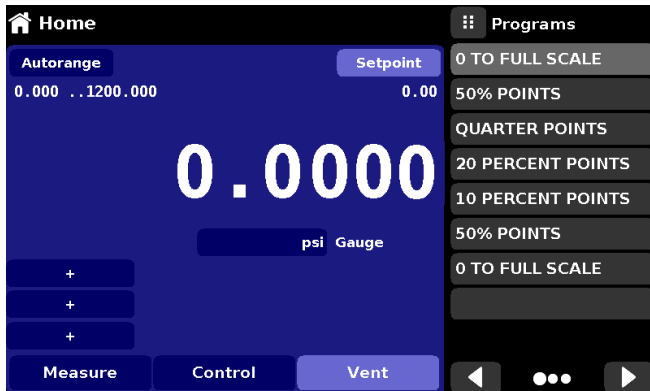

Figure 6.4.1.2.5-A - Program Selection

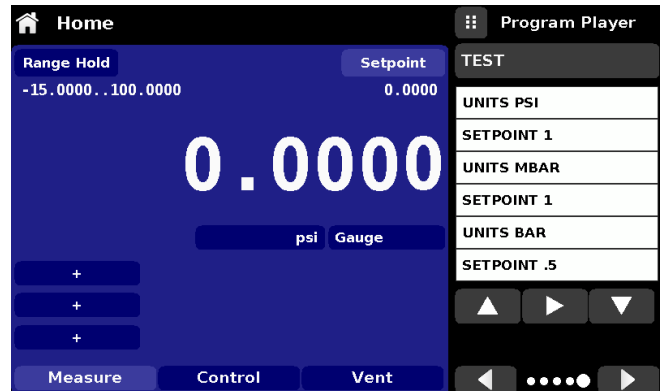

Figure 6.4.1.2.5-B – Program Data Entry

6.4.1.3 Units and Pressure Type

The Units button is always displayed. When the Units button is pressed a selection of imperial and metric units will be displayed on the right (figure 6.4.1.3 - A). The Pressure Type button is only active if there is an optional barometer installed. Otherwise, the Pressure Type button becomes a label (figure 6.4.1.3 - B) indicating the native pressure type of the channel (absolute or gauge). When an optional barometer is installed, a native gauge transducer can emulate absolute pressure using the barometric reference. Alternatively, a native absolute transducer can emulate gauge pressure. Emulation can be activated simply by pressing the Pressure Type button. The Pressure Type button becomes a label when the selected pressure unit is “% of F.S. value”.

Pressure Units button

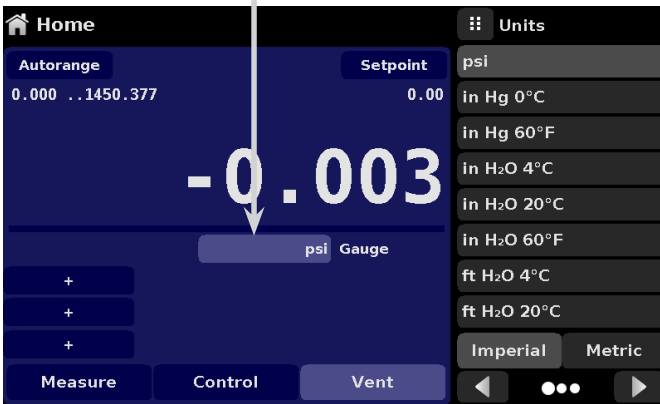

Figure 6.4.1.3-A

Pressure Type button

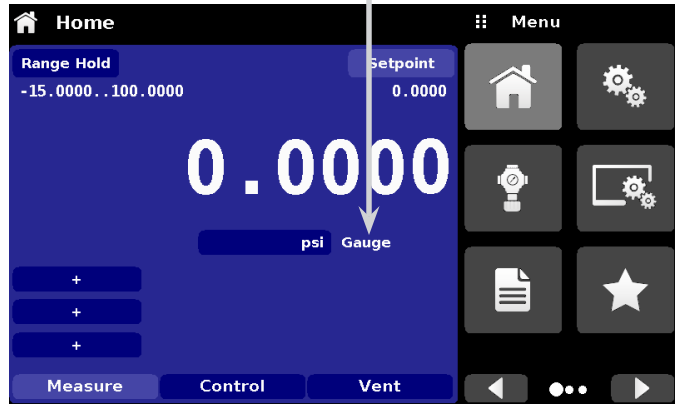

Figure 6.4.1.3-B

6.4.1.4 Bar Graph

An optional bar graph can be displayed below the current pressure value. The bar graph indicates the position of the current value with the maximum range of the primary transducer in that channel. This bar graph will appear in the Home App when selected from the Display Settings App (section 6.4.4).

6.4.1.5 Auxiliary Displays

The screen in figure 6.4.1.5 - A shows all of the possible auxiliary display items that can be included in the Home App. The Home App can have up to three auxiliary displays which can be chosen by clicking on each button and then selecting the display item from the menu on the right side of the screen (figure 6.4.1.5-B).

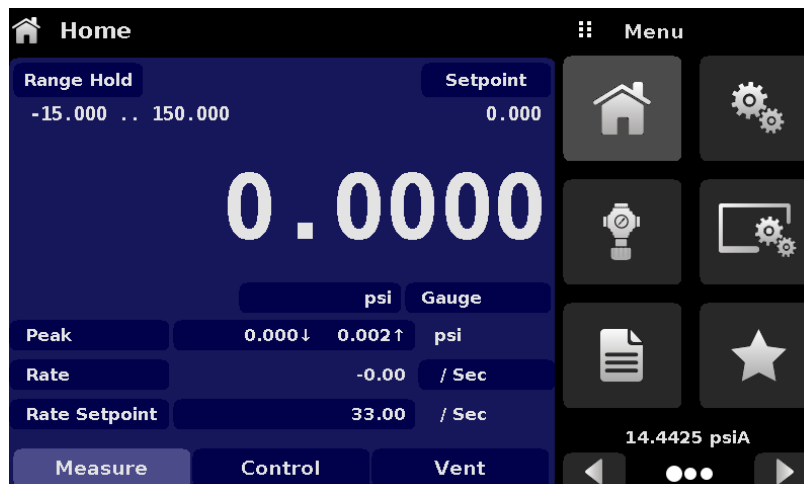

Figure 6.4.1.5-A – Home App with Auxiliary Displays

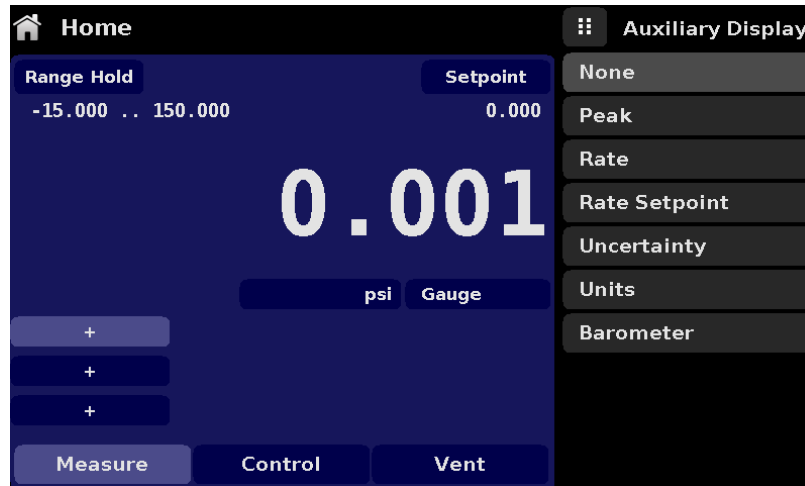

Figure 6.4.1.5-B – Auxiliary Display Selection

Each auxiliary display can be modified by pressing the displayed button.

Peak: Pressing the Peak button will reset the upper and lower peak value to the current reading, subsequent negative or positive divergence from that reading will be recorded in the button.

Rate: Pressing the Rate button will display a choice of time rate units for the rate denominator.

Rate Setpoint: Pressing the Rate Setpoint button will let the user enter the new Rate Setpoint via multiple entry methods

Uncertainty: Displays the accuracy in current units at the pressure being displayed.

Units: Pressing the Auxiliary Units button will display the same set of units available for the primary units. Pressing any of these units will change the auxiliary units to that chosen unit.

Barometer: Displays the reading of the optional barometric reference in current pressure units

6.4.1.6 Zero Button

If the Zero Calibration function has been chosen in the Display Settings App (section 6.4.4), then the Zero Cal Button [] will appear in the Home App. If the instrument is measuring absolute pressure, and the Zero Cal Button is pressed, a keyboard will appear to allow a single point calibration. If the instrument is measuring gauge pressure, pressing the button will set the current reading to zero. If the instrument is in emulation mode (absolute or gauge) then the value will not be saved to the transducer but only as a temporary adjustment while in emulation mode. After exiting the emulation mode or after a power cycle, the temporary adjustment will be cleared. The zero adjustment not in emulation mode will be saved to the transducer as if single point calibration had been performed.

Figure 6.4.1.6 shows the instrument with zero cal function enabled. The screen on the left shows instrument in gauge mode. The screen on the right shows the same instrument, but the zero button on the absolute mode has been pressed, showing the keypad enabled to accept a new single point calibration value.

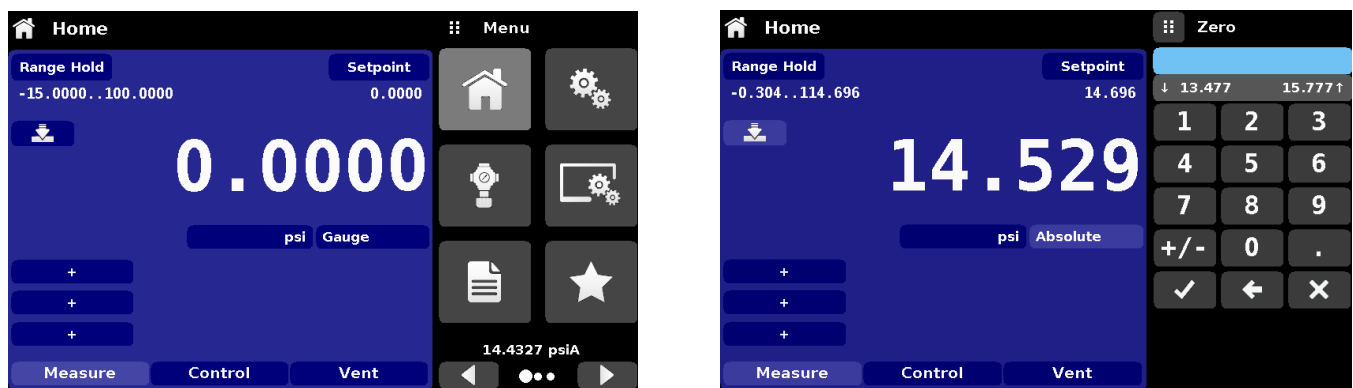

Figure 6.4.1.6 – Zero Button, Gauge - Absolute

The background color of the zero button will momentarily change to a lighter color as the zero calibration is performed then will revert back to a darker color when complete.

6.4.1.7 Tare Button

If the Tare calibration function has been chosen in the Display Settings App (section 6.4.4), then the Tare Button [**T**] will appear in the channel screen. For safety reasons, the tare button will be highlighted in yellow when active. The Tare button and the Zero Button cannot appear on the screen at the same time. When the Tare button is pressed, the instrument will subtract the current pressure reading (the tare pressure) so that the indicator will display zero. Subsequent deviations in pressure will be relative to the tare pressure.



Figure 6.4.1.7 – Tare Button

Pressing the tare button again will deactivate the tare and change the pressure indication back to the reading corresponding to the calibrated output of the transducer. An active tare will revert to a deactivated state after a power cycle.

6.4.1.8 Operating Mode Selection

The operating modes are permanently displayed on bottom of the Home App. The CPC4000 has three operating modes: Measure, Control and Vent. After the system has switched on, the instrument will automatically be placed in Vent mode. The user can switch from one mode to the other by using the mode selection keys





Notice

When switching from Control mode to Measure mode, the system will not be vented and the last applied pressure will be locked in the system by means of a solenoid valve.

Measure Mode: In Measure mode the CPC4000 acts like a precision pressure measuring instrument and measures the pressure applied at the Measure/Control port. If the Control mode was the last used mode before switching into Measure mode, the last controlled pressure is held in the test assembly.

Control Mode: In Control mode the CPC4000 provides a controlled pressure at the Measure/Control port equal to the setpoint value. It is activated by pressing the Control button. In order to ensure smooth operation in the control mode, following measures must be taken and respective parameters must be set.

- In order to control pressures close to or below atmospheric pressure, a vacuum pump should be connected to the Exhaust port
- The control speed can be set in the Control Settings App []. The Control rate can be set between 0.001% of range/sec to 20% of range/sec.
- Control limits can be set in the Control Settings App [].

Vent Mode: The Vent function will vent the system to the atmosphere, including the test assembly connected to the Measure/ Control port. The Vent mode can be activated from the Measure or Control mode by pressing the Vent button. The vent rate can be set in the Control Settings App []. The vent rate can be set between 0.001% of range/sec to 20% of range/sec.



Warning

WARNING! Venting will cause a loss of pressure at the vent rate in the system and the plumbing connected to the Measure/Control port. Care must be taken that the device under test is not damaged during venting.

6.4.2 Settings Application



The Settings App is used to set up general settings for the display. Settings parameters include Language, Brightness, Volume, User 1 base units, User 1 multiplier, User 2 base units, User 2 multiplier, Barometer units, and Configuration. Figure 6.4.2 shows these parameters as indicated when the Settings App has been chosen. As each parameter is pressed, an input screen will appear on the right where selections can be made.

The Settings App provides a place to change the language, display brightness, volume, user units, and barometer units. Configuration settings of the unit can also be saved within this application plus the default configuration can be activated.

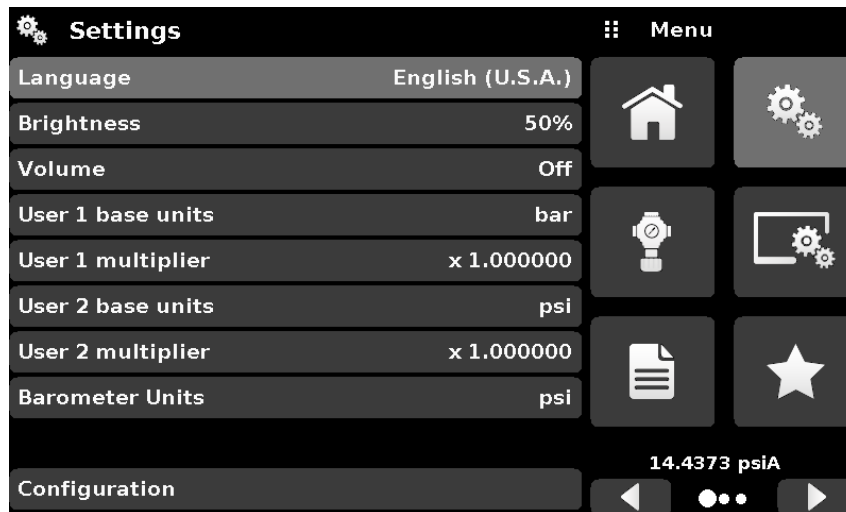

Figure 6.4.2 – Settings application

6.4.2.1 Languages

The Language parameter provides a selection of different languages. Once a language is chosen all words within all menus will appear in the chosen language and the radix character (decimal mark) will change from a dot (.) to a comma (,) depending on the language chosen. More languages can be accessed by navigating to the next page of the language selection menu on the right side of the screen.



Figure 6.4.2.1 – Languages

6.4.2.2 Brightness

The Brightness setting provides a sliding scale to increment the screen brightness in all screens. Sliding your finger along the bar graph or touching anywhere in the bar graph will change the brightness of the screen. After the setting is made and your finger is removed from the screen the menu will show the brightness percent selected.

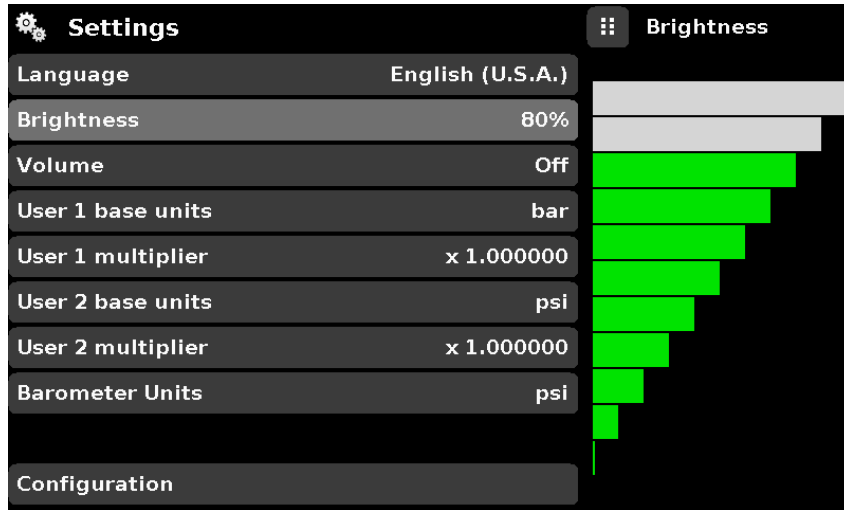

Figure 6.4.2.2 – Brightness

6.4.2.3 Volume

The Volume setting provides a way to turn on or off the touch screen audio feedback.

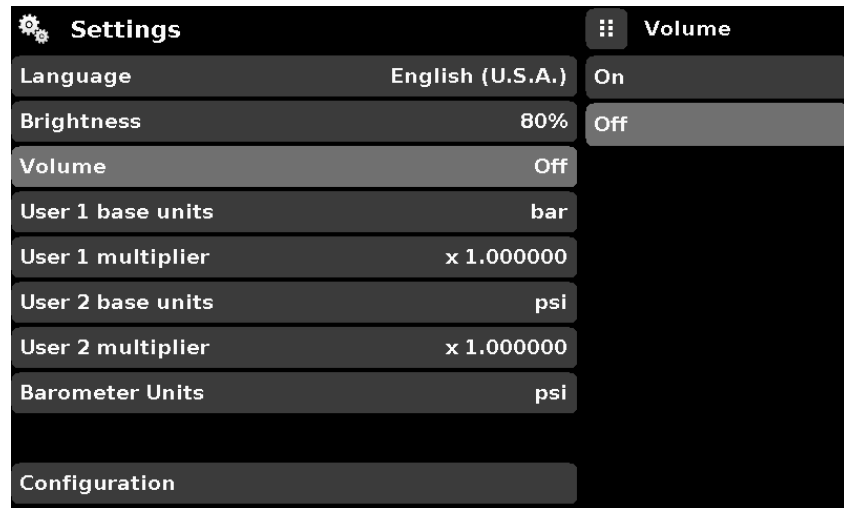

Figure 6.4.2.3 – Volume

6.4.2.4 User Base Units / Base Units Multiplier

When choosing a unit of measure from the Home Application (main screen), standard units can be chosen in addition to two user defined units. User units 1 and 2 are defined in the Settings App using “User 1 base units”, “User 1 multiplier” and / or “User 2 base units”, “User 2 multiplier”. For example, if the display of one atmosphere (atm) was needed, then psi could be chosen as the “User 1 base unit” and the “User 1 multiplier”, in this case, would be 0.068045. When set this way and the user 1 unit has been chosen, the user 1 unit will now display the pressure in atm.



Figure 6.4.2.4 – User base units / Base units multiplier

6.4.2.5 Barometer Units

When the Barometer Units Parameter has been chosen, a list of Imperial or Metric units is presented on the right side of the screen. Any of these units can be chosen from this list for the barometric readout that can be seen on the bottom right of the Home App.

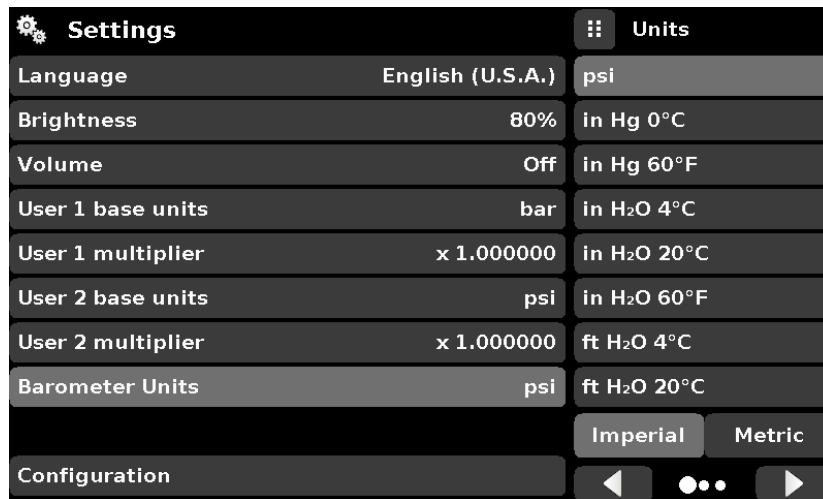

Figure 6.4.2.5 – Barometer units

6.4.2.6 Configuration

Configuration is the last parameter in the Settings App. It allows the operator to save instrument settings and load them, as needed, in the future. Parameters that are set in the Settings App, the Frames App, the Transducer App, and the Remote App can be saved using the Configuration “Save” button and recalled using the Configuration “Load” button. Simply set all desired parameters then go to Settings-Configuration, press one of the numbered Configuration buttons then press the “Save” button. This will save the current configuration in that button. To reload a saved configuration at a later time, go to Settings-Configuration and press the numbered configuration button corresponding to the saved configuration and then press the “Load” button.

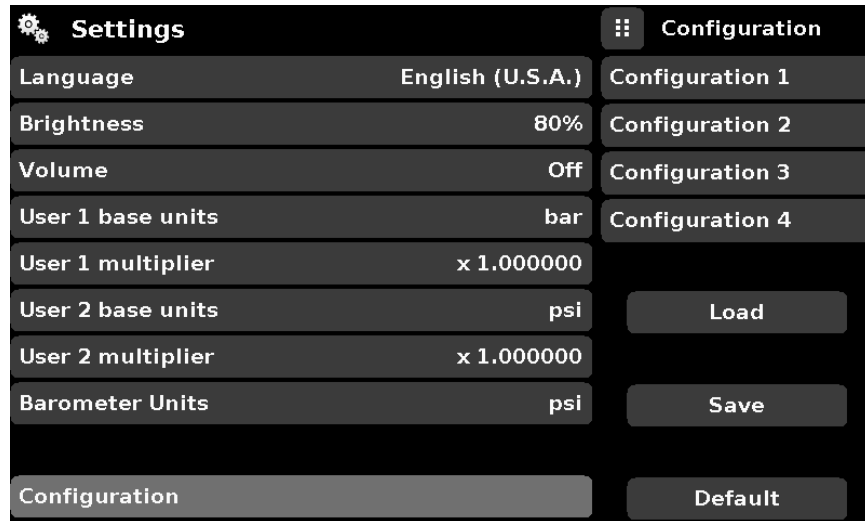

Figure 6.4.2.6 – Configuration

The instrument default configuration can be activated simply by pressing the “Default” Button.

6.4.3 Control Settings Application



The Control Settings App allows the user to select and configure the control parameters for the solenoid valve regulator in the instrument. This display remains the same for either one or two transducer instruments. The Control Settings screen is divided into two pages and can be navigated using the Next Page [▶] and Previous Page [◀] buttons. The Control Settings App provides two preset control modes “Precision” and “High Speed” which affect the “Control Behavior”, “Rate Setpoint”, “Stable Window” and “Stable Delay”. The Precision control mode is set as default and provides a stable control rate at medium overshoots. The High Speed control mode provides faster control rate at a higher overshoot. Each of the control parameters can be changed by the user to best suit their application in the “Custom” control mode. The “Custom” control mode retains the values of the parameters entered by the user until the user changes it again. Figure 6.4.3-A and Figure 6.4.3-B show the App display for Control Settings App. Figure 6.4.3-C shows the first page of the Control Settings App in “High-Speed” control modes.



Figure 6.4.3-A – Control Settings App

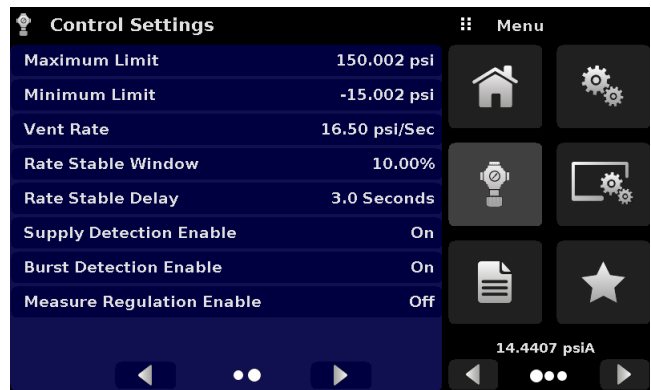

Figure 6.4.3-B – Control Setting App

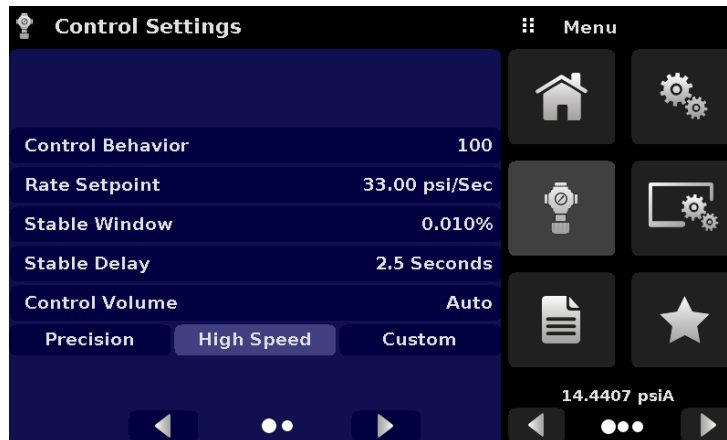

Figure 6.4.3-C – High Speed control mode

6.4.3.1 Control Behavior

The Control Behavior button in the Control Settings App provides a choice between different levels of control behavior ranging from “0” to “100” where “0” represents lowest overshoot control mode and “100” represents High Speed control mode. The Control Behavior is preset to “50” for Precision control mode and to “100” for High Speed control mode. The Control Behavior can be changed using the sliding scale. Figure 6.4.3.1 shows the sliding bar to adjust control behavior in the Custom control mode.

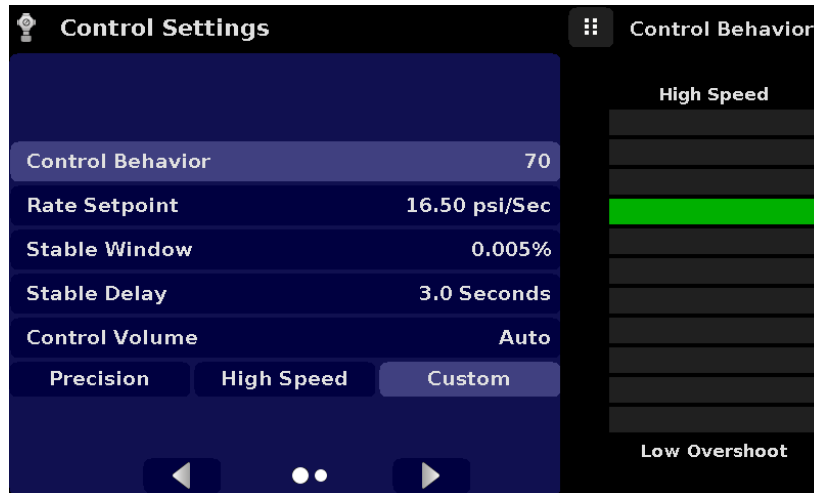

Figure 6.4.3.1 – Control Limit Setting

6.4.3.2 Rate Setpoint

The Rate Setpoint button allows the user to set the rate of pressure change when the CPC4000 is controlling up or down to a setpoint (figure 6.4.3.2). The rate is limited to 0.1% of span of primary range of the transducer/second to 20% of the full scale range/second.

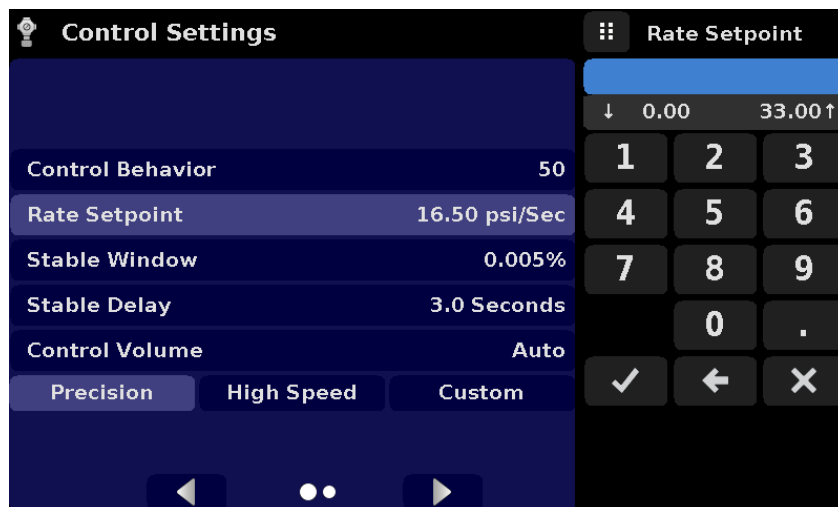

Figure 6.4.3.2 – Rate Setpoint

6.4.3.3 Stability Parameters

Stability parameters for the controlled pressure can be found in the Control Settings App and can be configured using the Stable Window and Stable Delay buttons. When the controller enters a stable condition the pressure indication color on the Home App will change from white to green. The Stable Window button allows the user to enter a value as a percentage of the highest range transducer. This value represents the pressure window within which any setpoint value would be considered stable by the user. The Stable Delay button lets the user add a desired delay until the pressure value is considered stable while being in the stable window.

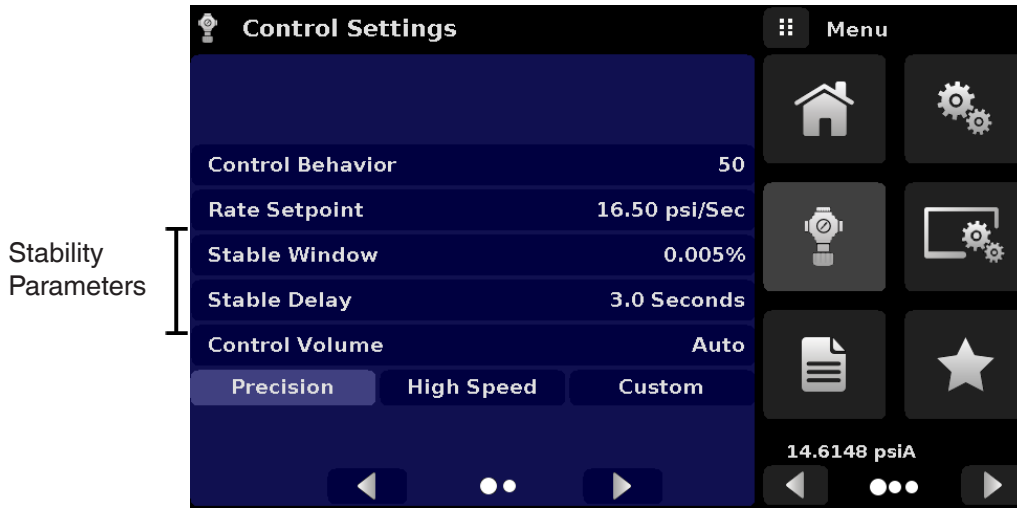

Figure 6.4.3.3 – Stability Parameters

6.4.3.4 Control Volume

The Control Volume button in the Control Settings App allows the user to control pressure volume in “cc”. The CPC4000 is capable of automatically identifying the control pressure volume and adjusting the control parameters based on it. By default this button is set on “Auto”. Figure 6.4.3.4 displays the control volume setting for the instrument.

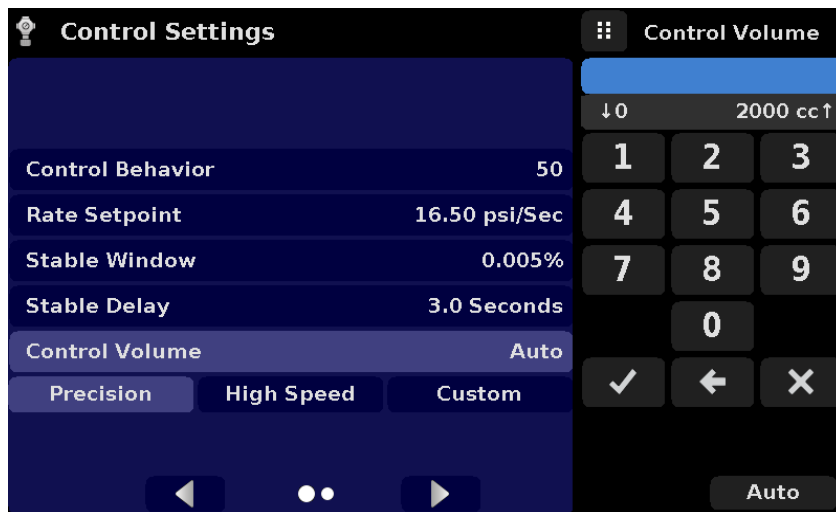



Figure 6.4.3.4 – Control Volume

6.4.3.5 Control Limits

The Maximum and Minimum Limit buttons can be accessed by clicking the Next Page [] button in the Control Settings App. These buttons provide a place to limit the setpoint value that can be chosen in the Home App. These limits can only be set within the range of the active transducer. When the instrument is in Autorange the limits can only be set within the range of the primary transducer which, by convention, will have the widest range. The minimum limit must be lower than the maximum limit. The user cannot enter setpoints and thereby not control to pressures outside of these limits.

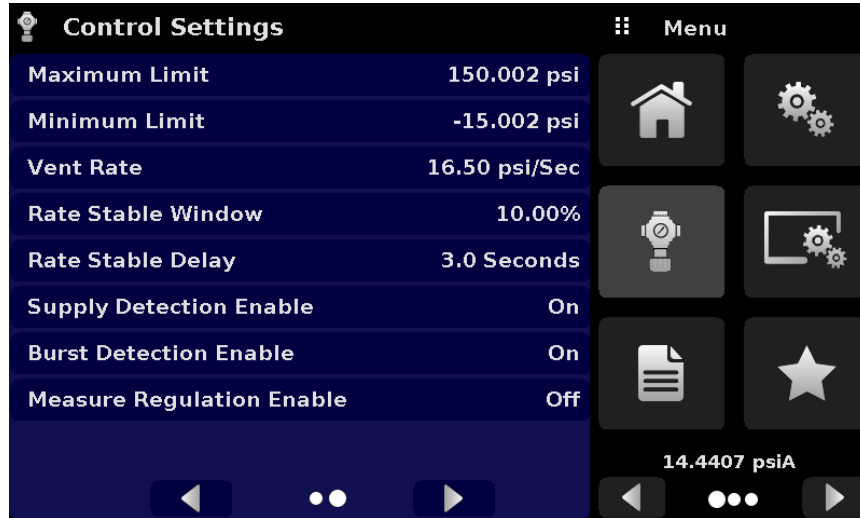

Figure 6.4.3.5 – Control limits

6.4.3.6 Vent Rate

The Vent Rate button in the Control Settings App lets the user to determine the rate at which pressure will vent in vent mode. By default the rate of the vent is set similar to the control rate. The rate is limited to a maximum of 20% of the full scale range/ second. Figure 6.4.3.6 displays the vent rate setting for the instrument.

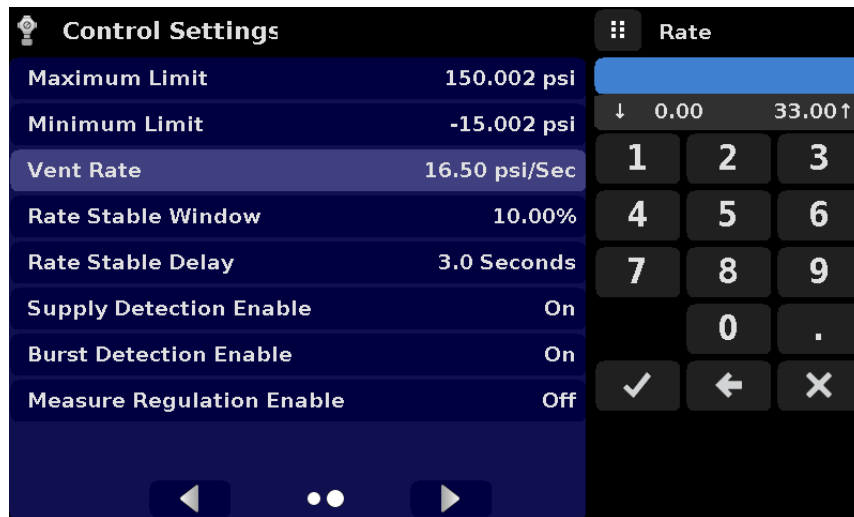

Figure 6.4.3.6 – Vent rate

6.4.3.7 Rate Stability Parameters

Rate parameters for the control rate can be found in the Control Settings App and can be configured using the Rate Stable Window and Rate Stable Delay buttons. The Rate Stable Window button allows the user to enter a value as a percentage of the active range of transducer. This value represents the pressure window within which the control rate value would be considered stable by the user. The Rate Stable Delay button lets the user add a desired delay until the control rate is considered stable while being in the rate stable window.

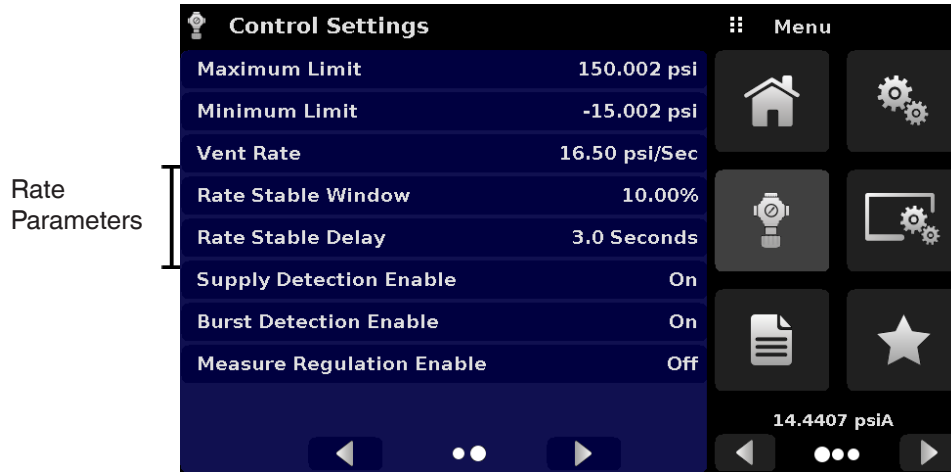



Figure 6.4.3.7 – Rate Parameters

6.4.3.8 Detection Flags

The CPC4000 Industrial Pressure Controller is equipped with three detection flags that can be enabled or disabled by the user as needed. These detection flags appear in the Control Settings App. The primary purpose of these detection flags is to protect the instrument and to ensure desired operation. Each of these flags can be turned “On” or “Off” as per user’s need. Figure 6.4.3.8 shows the detection flag settings.

- **Supply Detection Enable:** If turned “On”, this flag allows the user to check for sufficient supply pressure at the Supply Port of the instrument. In case the supply pressure is less than over 10% of the control setpoint, an error is reported which can be seen in the Troubleshoot App by clicking the error symbol []. This flag is turned “Off” by default.
- **Burst Detection Enable:** If turned “On”, this flag allows the user to protect the instrument against sudden bursts in the pressure at the Measure/ Control Port. In case a burst is detected, an error is reported which can be seen in the Troubleshoot App. This flag is turned “On” by default.
- **Measure Regulation Enable:** If turned “On”, this flag allows pressure to be controlled while the instrument is in “Measure” mode to prevent pressure leaks in the system over time. This will turn on the internal pressure regulator periodically to control pressure in a certain range of the measured pressure value. This flag is turned “Off” by default.

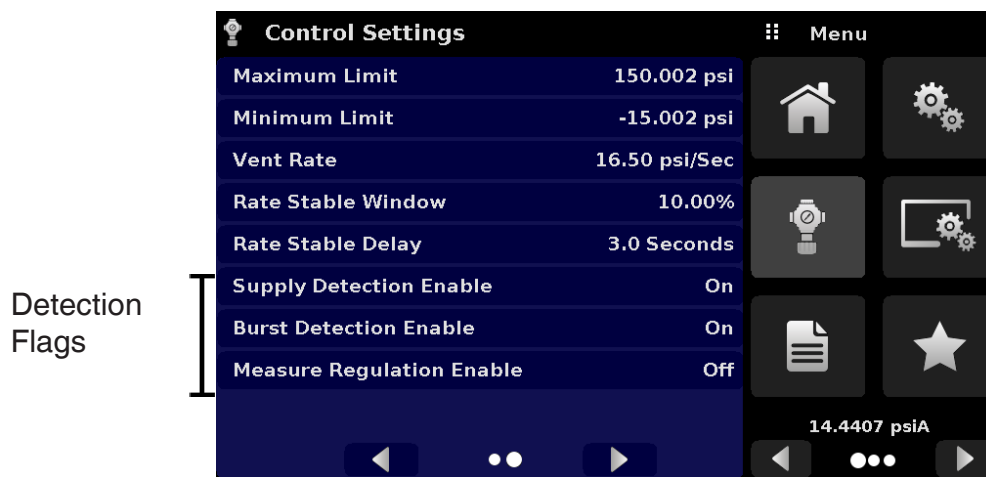

Figure 6.4.3.8 – Detection Flags

6.4.4 Display Settings Application



The Display Settings Application allows the user to configure display properties like the filter for the reading to reduce fluctuations due to electrical noise, and to set the resolution of the reading. In addition, the bar graph display and calibration function can be specified here.

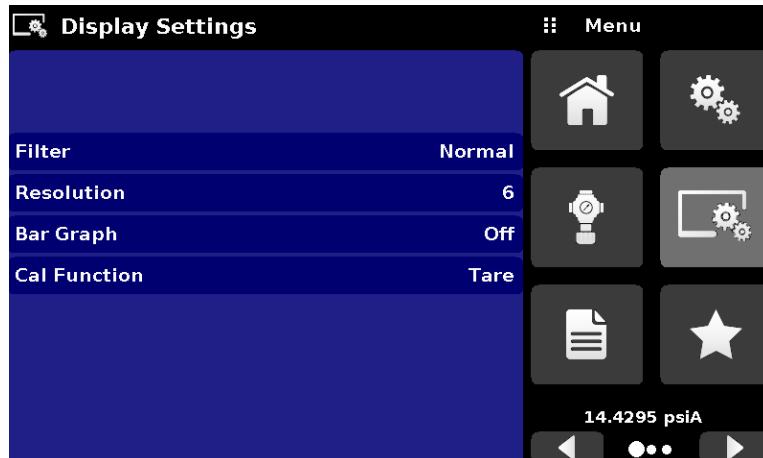

Figure 6.4.4 – Display Settings Application

6.4.4.1 Reading Filter

The Filter is an electronic filter to smooth out the pressure readings. Because of differences in resolution, greater filtering may display a more stable reading for some pressure units. Turn off the Filter by selecting “Off”, select varying degrees of filtering for the current units by selecting “Low”, “Normal” or “High”.

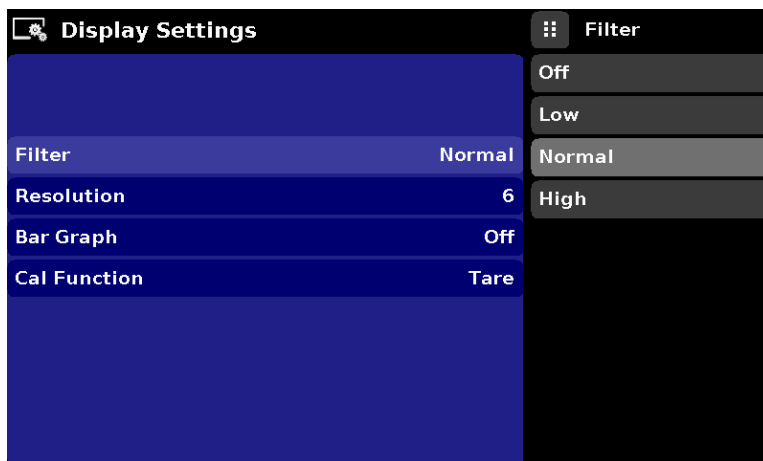

Figure 6.4.4.1 – Channel Selection



6.4.4.2 Reading Resolution

The Resolution of the displayed pressure value for each Channel can be set in the Display Settings Application using the resolution Parameter. The resolution can be set to 4, 5 or 6 digits.



Figure 6.4.4.2 – Reading Resolution

6.4.4.3 Cal Functions

The Cal Function presents a choice of None, Tare or Zero. Choosing Zero will enable the Zero Cal Button [] in the Home App. Choosing Tare will enable the Tare Button [] in the Home App. The Tare button and the Zero Button cannot appear on the screen at the same time. See section 6.4.1.6 and 6.4.1.7 for operation of the Zero and Tare buttons in the Home App (main screen).

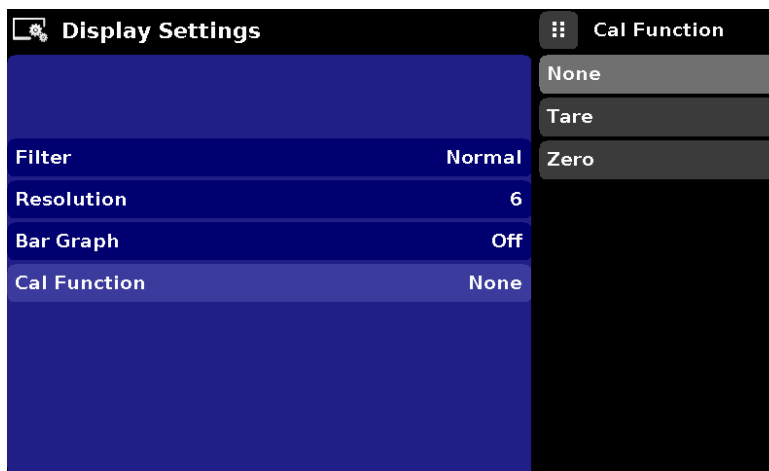

Figure 6.4.4.3 – Cal Function

6.4.4.4 Zero Reference Standard

The Zero Reference Standard selection appears on the Display Settings App when an instrument with absolute transducers is selected. It presents a choice of Input, Barometer and Lowest Range of the transducer as a reference for zeroing the absolute transducers. By default, keypad entry (Input) is selected as the reference which allows the user to enter a value from an external zero reference.

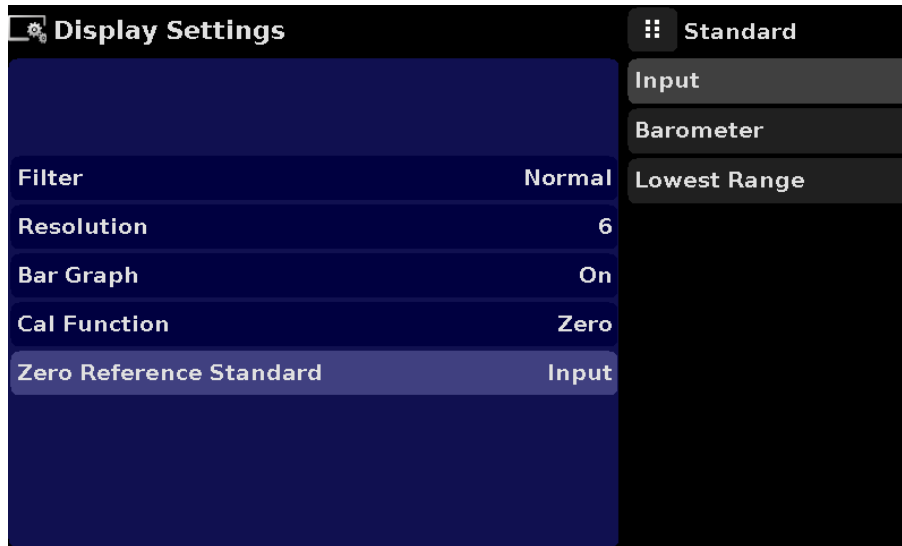

Figure 6. 4.4.5 - Zero Reference Standard

6.4.5 Programs Application



The Programs Application is used to create, view and edit programs that are used to automatically run a sequence of commands within the CPC4000. The Programs App screen displays the contents of the first written program in read only mode by default (figure 6.4.5-A). User can load, edit and delete other saved and predefined programs by clicking on the title of the current program and then selecting the desired program sequence from the sidebar (figure 6.4.5-B).

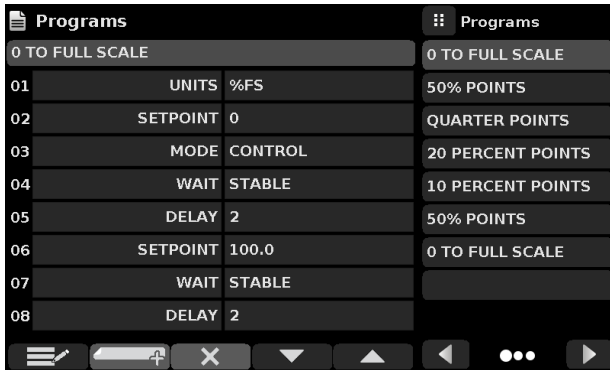

Figure 6.4.5-A – Programs Application

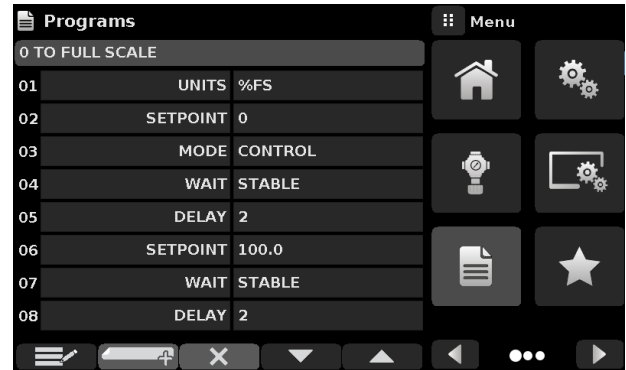

Figure 6.4.5-B – Programs Selection

6.4.5.1 Edit Programs

By default the programs are available in read only mode to prevent accidental changes to existing programs. The users can edit existing programs or create steps in new ones by clicking on Edit Program [] button (figure 6.4.5.1-A). This makes the program editable and also activates the Insert [] and Delete [] buttons which are otherwise just labels and can't be clicked by the user. A series of predefined commands can be chosen to write the steps of a program. Selection of commands and data in each sequential line will create a draft of resulting command sequence in the selected program (figure 6.4.5.1-B). Upon exiting the edit mode by pressing the Edit Program [] button, the system will ask "Save changed programs?" Pressing the [] button will accept the changes, pressing the [] will revert back to the old program. A list of available commands, data values and their functions are listed in table 6.4.5.1.

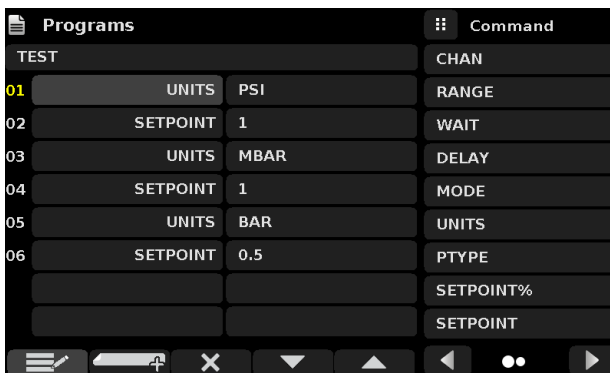

Figure 6.4.5.1-A – Editable Programs App

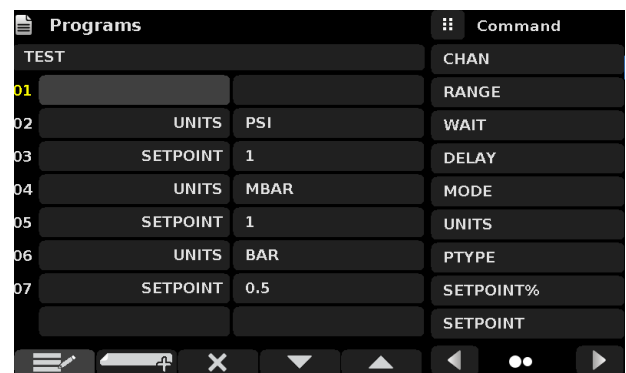

Figure 6.4.5.1-B – New Line Creation

Table 6.4.5.1 – Sequence Commands

Command	Function (data selection)
CHAN	Sets the active channel for subsequent commands
RANGE	Sets the active range for the active channel
WAIT	Waits for a manual input or stable condition (Stable or Input)
DELAY	Delays for time = 1 to 3600 seconds (Numerical Entry)
MODE	Sets the control mode (Measure, Control or Vent)
UNITS	Sets the pressure unit for operation
PTYPE	Sets the pressure type (Gauge or Absolute)
SETPOINT%	Sets the control setpoint in % of current range (Numerical Entry)
SETPOINT	Sets the control setpoint for the instrument (Numerical Entry)
STEP%	Increases or decreases the current setpoint by the percent full scale specified
STEP	Increases or decreases the current setpoint in current units (Numerical Entry)
RSETPT	Sets the rate setpoint in current units (Numerical Entry)
SEQZERO	Set the zero for the current active transducer
SEQSTART	Starts the sequence from the beginning (None)
RUNITS	Sets the rate denominator time unit (min or sec)

6.4.6 Favorites Application





The Favorites Application is used to select programs that will appear in the Home App when the Favorites [] is pressed. The purpose of the Favorites App is to provide quick access to frequently used programs. The current list of favorites is shown in figure 6.4.8 and the desired program can be run by clicking on its name which takes the user to the Programs App. The list of favorites can be edited by clicking on the Play [] button. The list of programs in the Favorites App can be chosen by clicking a program from the list on the left and replaced by clicking a predefined or saved programs shown on the right side of the screen. A maximum of eight programs can be stored as favorites.



Figure 6.4.6 – Favorites Application

6.4.7 Information Application



The Information Application displays information about the instrument, including:

- Sensor address, and email
- Model number, serial number and operating software version.
- Regulator model number, serial number and software version.
- Transducer model numbers, serial number, range and software version

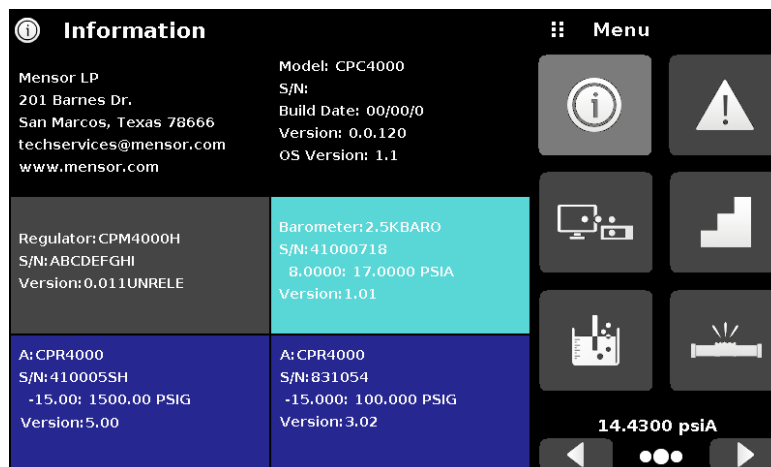



Figure 6.4.7 – Information Application

6.4.8 Troubleshooting Application



The Troubleshoot Application can be found by navigating to the second page in Apps section by clicking on the Next Page [] button. The Troubleshoot App will display information about error conditions and remote communications. Within the troubleshoot screen (Figure 6.4.8 -B), push the Error button to display any errors that have occurred in the instrument due to a communication or network error. Push the Remote Settings button (Figure 6.4.8-C) to show commands and responses that have been sent over the remote communication connection.

If there are any errors in the error queue an error symbol [] will appear in all screens (Figure 6.4.8 -A) of the instrument. Pressing this error button from any screen will open the Troubleshoot application where the error can be viewed.

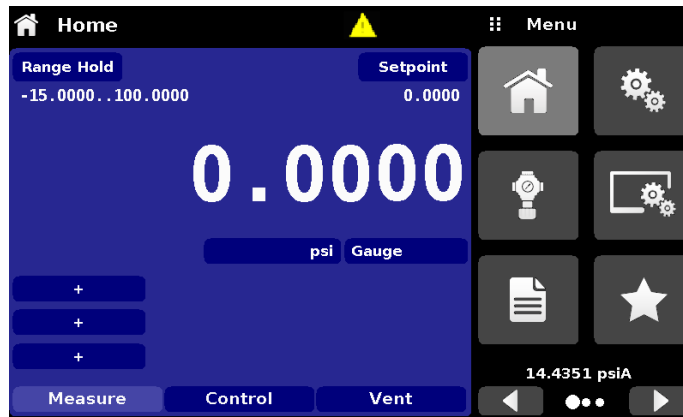

Figure 6.4.8-A – Error indication

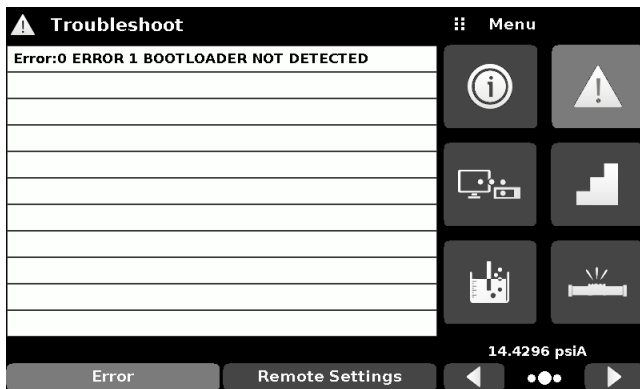

Figure 6.4.8-B – Troubleshoot error screen

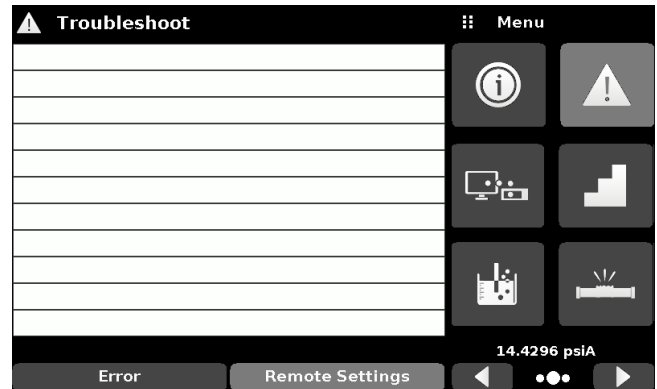
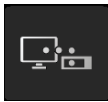

Figure 6.4.8-C – Troubleshoot remote screen

6.4.9 Remote Application



With the Remote Settings application user can select the remote command set for all interfaces. The GPIB address, Ethernet network parameters and Serial parameters can also be set here. Details about the Remote Operation (command sets, cable requirements, etc.) can be found in Section 7, Remote Operation.

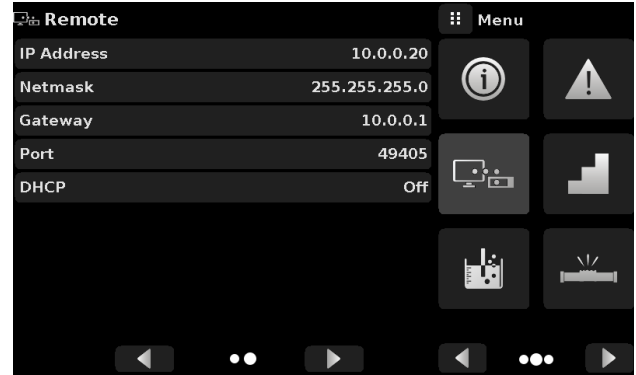

Figure 6.4.9 – Remote Application

6.4.9.1 Remote Command Set

The remote command set parameter provides a choice of the Mensor command set or the WIKA SCPI / DPI command set (Figure 6.4.9.1 -A). Both sets of commands are listed in Section 7, Remote Operation.



Figure 6.4.9.1 - A – Remote Command Set

The DPI5xx command also provides an option to set the Checksum (Figure 6.4.9.1 - B) which when set to ON or AUTO appends a mod base 100 checksum to end of any remote communication response. A proper mod base 100 checksum must be sent to the instrument when the checksum is ON. Sending the checksum is optional when set to AUTO. The flow control is set to NONE as default internally. The termination character sets the output termination character for all remote communication command sets (Figure 6.4.9.1 - C). The commands are listed in Section 7, Remote Operation.

Industrial Pressure Controller CPC4000



Figure 6.4.9.1 - B – Checksum



Figure 6.4.9.1 - C - Termination character

6.4.9.2 Remote Communication Settings

The remainder of the Parameters in the Remote Application present the choice of a numeric entry, a numeric address entry, or a radio button selection. The parameters that require a numeric entry will present a numeric keypad with min and max limits for the variable. The parameters that require a numeric address (for example an IP address) will also present a keypad. Address entries should conform to the format of the parameter selected. The three screens below show examples of each type.



Numeric entry

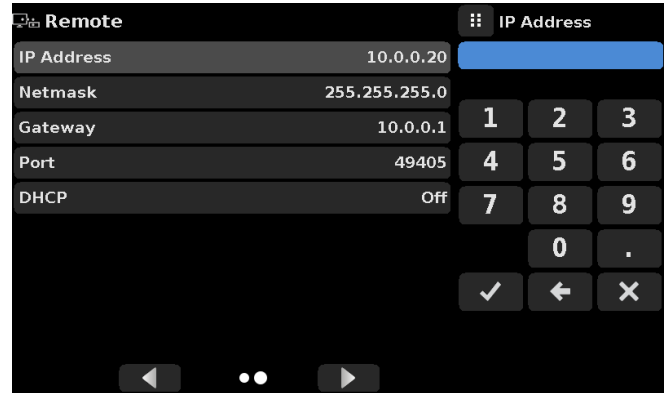

Numeric address entry

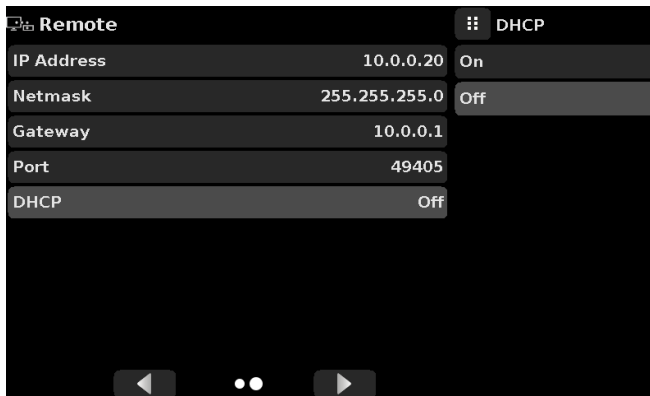

Radio button selection



Setting the Ethernet DHCP to yes will have a short delay while the DHCP server is contacted. If a DHCP server is not found, an error will be indicated. If DHCP is enabled, the IP address, Netmask and Gateway are greyed out and locked, these are controlled by the DHCP server.

Figure 6.4.9.2-A – Remote Communication Settings

A successful communication link between the instrument and the various interfaces is indicated by a Remote Settings Icon at the top of the screen (figure 6.4.9.2-B).

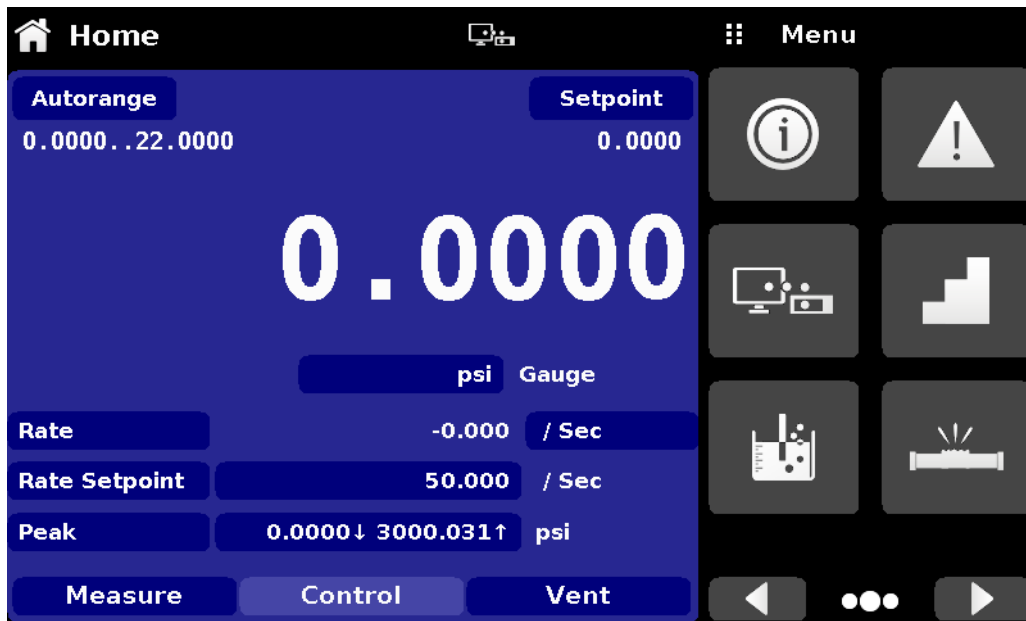

Figure 6.4.9.2-B – Remote Settings Icon

6.4.10 Step Settings Application



The Step Settings Application allows the user to enter control setpoint value or write program sequences as a factor of the percentage of the device under test operating pressure range or as fixed pressure values (figure 6.4.10). The user can enter the minimum and maximum range of the device under test (figure 6.4.10-A) and then select the desired percentage value(s) or desired fixed pressure value(s) for setpoint(s). These ranges should be within the maximum range of the primary transducer.. The user can also enter the control point up to a maximum of 5% over the range of the device under test limits by entering the overrange percentage (figure 6.4.10-B). CPC4000 automatically calculates the pressure value of the setpoint based on this selection. The user can be directed to this application from the setpoint entry menu in the Home App (section 6.4.1.2).

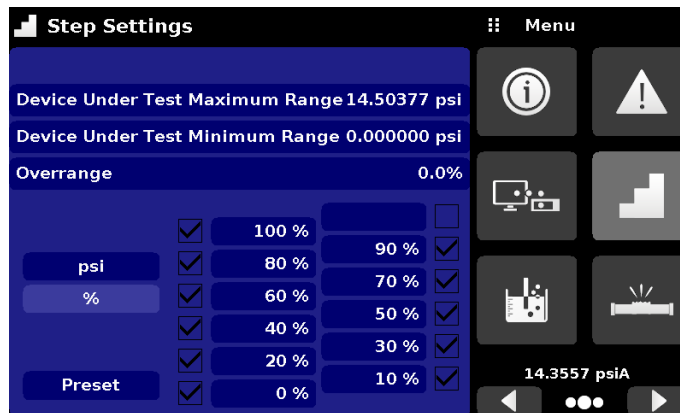

Figure 6.4.10 – Step Settings Application

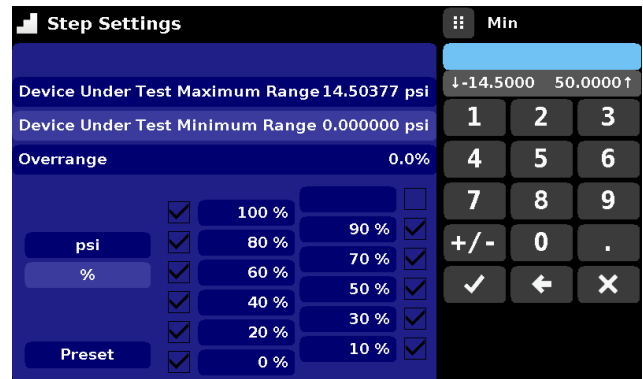
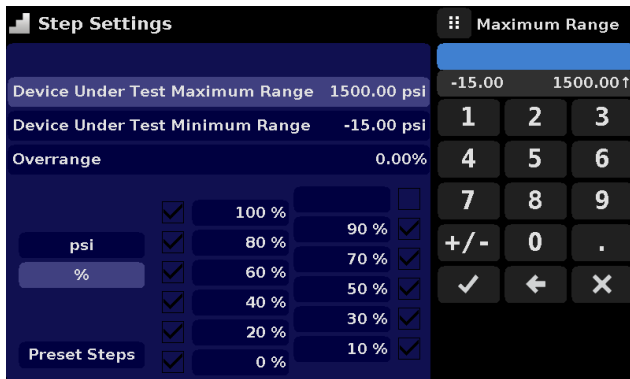

Figure 6.4.10-A – Range Selection

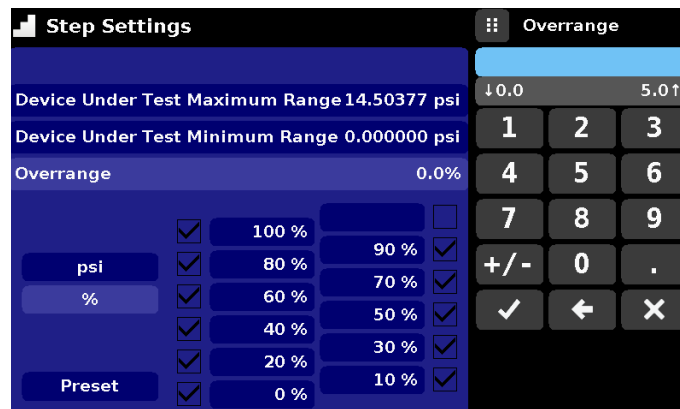

Figure 6.4.10-B - Overrange Selection

6.4.10.1 Preset Steps

The user can have up to 12 different points along the range of the device under test (DUT). The Preset Steps button allows the user to enter the number of points and then automatically divides the range in equivalent percentages. For example if the user needs 5 distinct points along the DUT range then enter 5 in the numeric keypad and press Enter [] button. CPC4000 will create setpoints at 20%, 40%, 60%, 80% and 100% of the DUT range. The user also has the option of changing these percentage values as per his/ her desire by clicking on the individual Percentage button on the Step Settings app. The user can enter any percentage between 0 and 100. The desired value can then be chosen by checking the box [] beside the Percentage button.

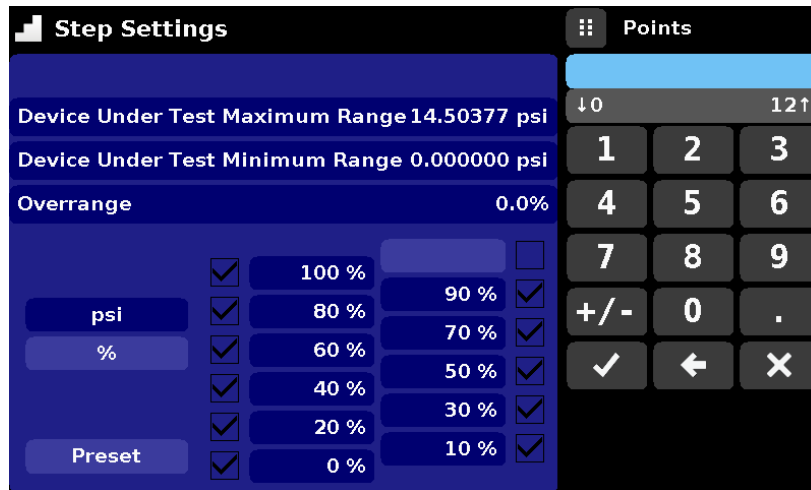

Figure 6.4.10.1-A – Preset Steps Entry

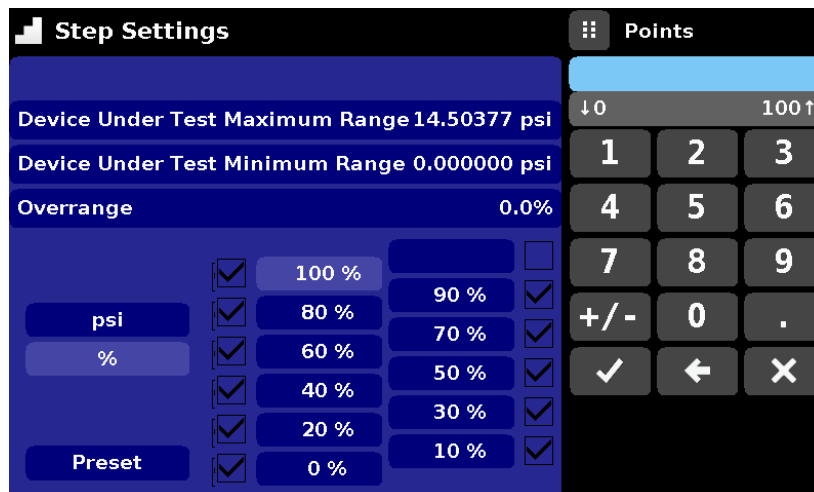

Figure 6.4.10.1-B – Percentage Value Entry

6.4.11 Leak Test Application



Leak test is a device under test specific feature (figure 6.4.11). The user selects the transducer first and then defines a leak by setting the Dwell Delay and the Dwell Time, Delta and Setpoint parameters. The leak test is initiated by pressing the Start button.

Dwell Delay: The amount of time the controller remains at the Setpoint before the test begins.

Dwell Time: The amount of time the controller is monitoring the pressure change.

Delta: The change in pressure during the test that determines a pass or fail result.

Setpoint: The controller pressure at which the test begins.

If the change in pressure exceeds the Delta parameter before the allotted time in the Dwell Time parameter, then the Leak Test App will return a red status indication showing initial, final and the actual difference (delta) in pressure recorded, and indicate a “failed” test. Otherwise it will return a green status indication showing the delta was not exceeded for the Dwell Time, and indicate a “passed” test. See Figure 6.4.11-A for examples of a failed and a passed test.



Figure 6.4.11 – Leak Test

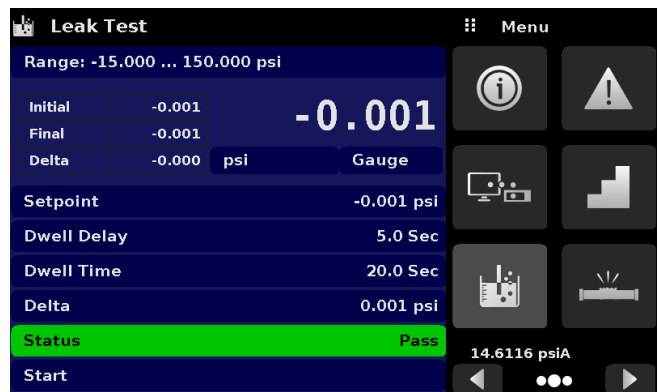
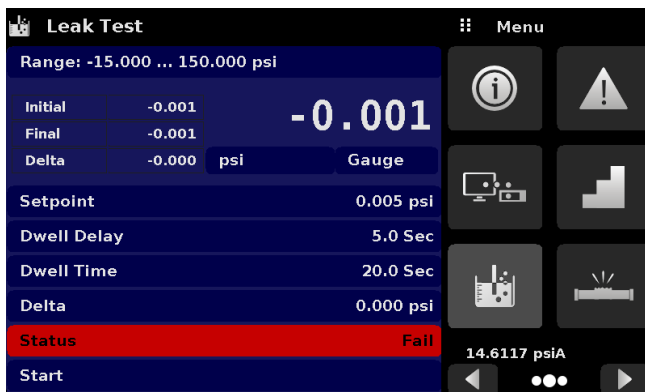

Figure 6.4.11-A – Leak test fail (left) & Leak test pass (right)

6.4.12 Burst Test Application



The Burst Test Application tests the burst pressure of an external device. A device such as a rupture disk or any device that must be tested for burst pressure can be connected to the Measure / Control port. Enter the Parameters below then press start to initiate the test.

- Burst Detection Rate: The threshold rate used by the controller to identify a burst.
- High Point: The highest pressure that the controller will control to during the test and should be set at a value above the point where the burst pressure is expected to be.
- Low Point: The pressure point below the value where the burst pressure is expected to be. It is also the point where the controller switches from Fast Rate to Slow Rate.
- Fast Rate: the rate at which the controller will control pressure to the Low Point.
- Slow Rate: The rate at which the controller will control between the Low Point and the High point.

If the Device under test must experience a burst condition between the Low Point and the High Point the instrument will indicate the burst point at the end of the test. If the device under test does not experience a burst condition the burst test screen will indicate a complete status. The burst test is initiated by pressing the Start button. Figure 6.4.12-A, 6.4.12-B and 6.4.12-C show the different status messages during a burst test.

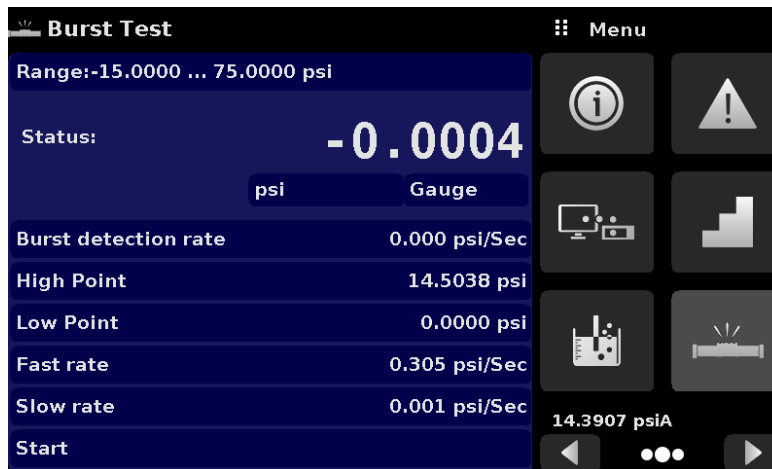

Figure 6.4.12 - A – Burst test screen

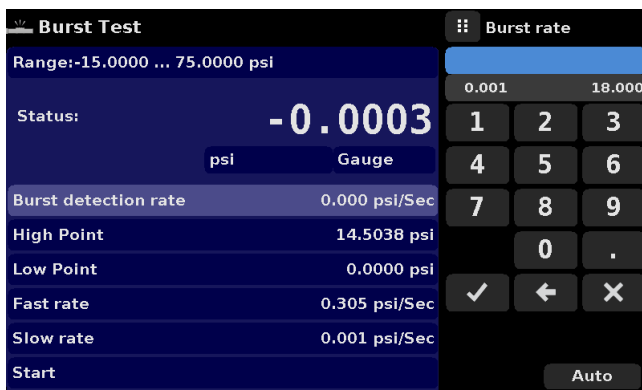

Figure 6.4.12-B – Burst detected

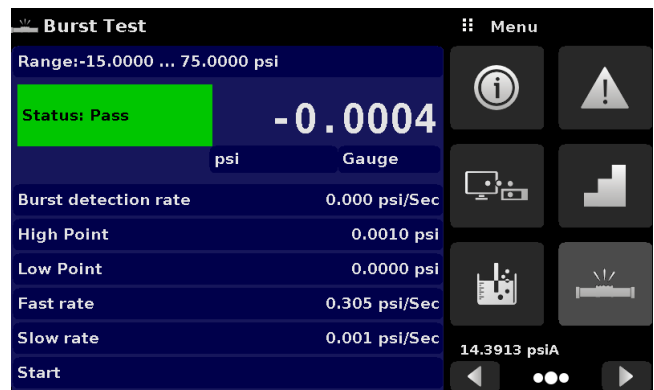

Figure 6.4.12-C – No burst detected

6.4.13 Service Application



The service application can be found by navigating to the third page by clicking the Next Page [▶] button at the bottom right corner of the App section of the screen. It is a password protected area allowing access to calibration menu for all the sensors and technical assistance menu. In addition, this is where the password for entering this area can be changed.



Figure 6.4.13-A – Service Application (locked)

Press the Enter button to show the numeric keypad to enter a password. This will unlock other applications.

- Default password for calibration menu is 123456
- Default password for technical assistance menu is 111111

Enter password and press the check mark [✓] to unlock the Service Application.

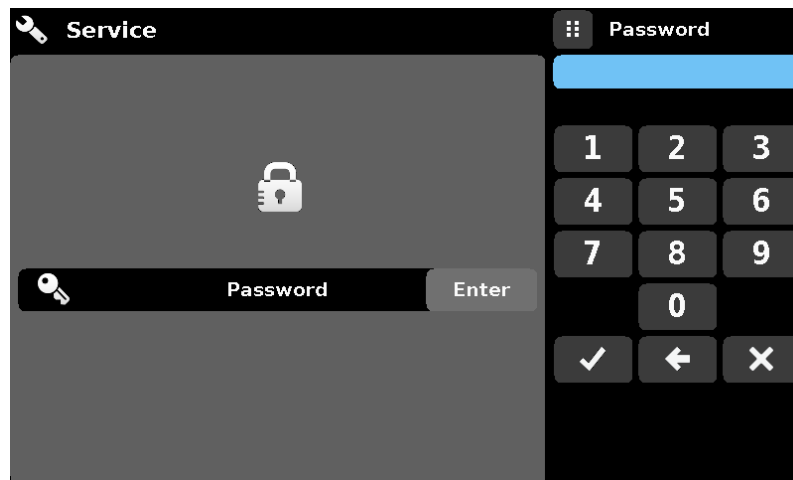

Figure 6.4.13-B – Service Application (Enter Password)



Note: After entering the default password for the first time, the password can be changed.

6.4.14 Unlocked Service Application

After the Password has been entered, the unlocked Service Application will appear (Figure 6.4.14-A & B). To re-lock this screen, press the lock button.

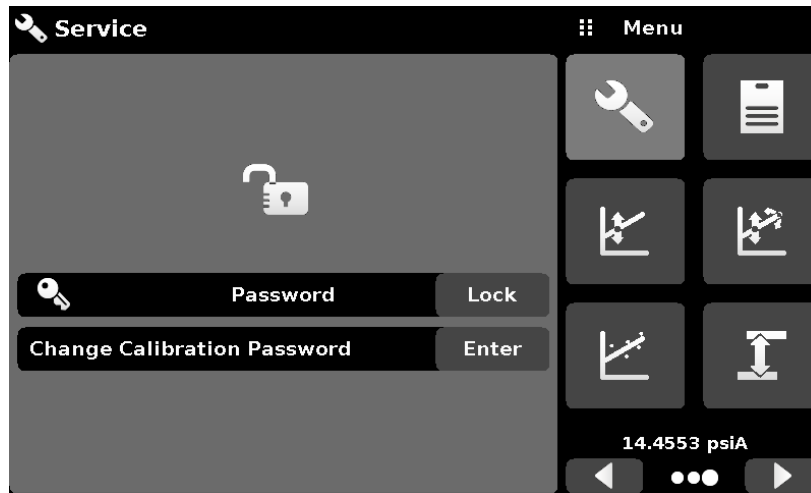

Figure 6.4.14-A – Unlocked Service Application - Calibration Menu

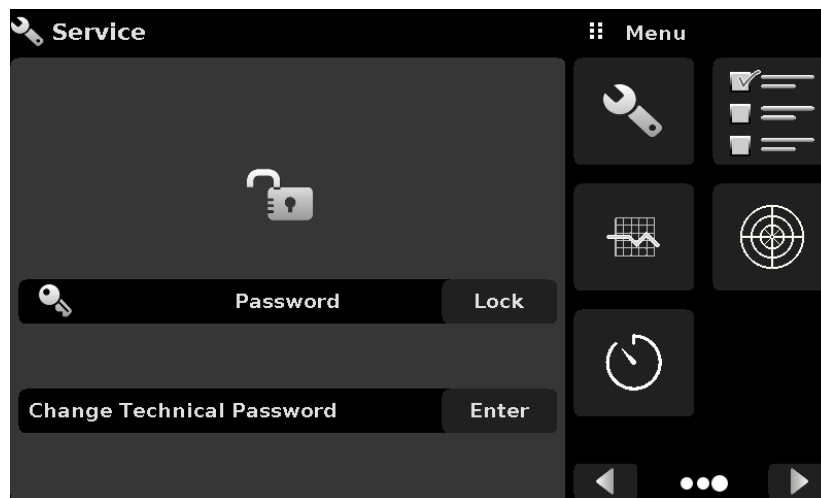



Figure 6.4.14-B - Unlocked Service Application - Technical Assistance Menu

From the Unlocked Service Application, the Password can be changed by pressing the Enter button next to the Change Password label. This will open a keypad where a new password can be entered and accepted by pressing the Check Mark [].



Note: Please make note of a password change and save the new password in a secure location.

The Unlocked Service Application is the access point to all calibration screens described in Section 10 of this manual or all the technical screens described in Section 11 of this manual.



Note: Recommended calibration setup and explanation of calibration screen applications is covered in Section 10 of this manual.

7 Remote Operation

Use the screens in Section 6.4.9 Remote Application to set the operating parameters for the instrument command set, Ethernet, Serial (RS-232) and IEEE-488 (GPIB) information.

7.1 Command Set

Command Set button – Users' can select which model remote protocol they would like to emulate for simulation and testing purposes. Selections may include the standard command sets or the optional command sets selected in the Technical Assistance menu (Section 11) :

Standard:

- Mensor (default)
- SCPI WIKA (The SCPI WIKA mode emulates the WIKA command set in SCPI format.)
- DPI 5XX

Optional:

- SCPI GE (The SCPI GE mode emulates the GE PACE command set in SCPI format.)

7.2 IEEE-488

IEEE-488 address button – Allows the user to set the GPIB address by inputting a numeric value utilizing the touch screen.

7.2.1 IEEE-488.2 Commands

Command or Query	Response / Function
*IDN?	Returns identification string
*TST?	Returns OK
*OPC	Operation completed
*WAI	Returns operation completed state
*CLS	Clear status and error queue
*ESE	Enable status event
*ESE?	Returns enable status event value
*ESR	Event status register
*ESR?	Returns event status register value
*SRE	Service request enable
*SRE?	Returns service request enable value
*STB?	Returns status byte

7.3 Ethernet

The Ethernet function allows the user to set the following by inputting a numeric value in each separate field:

- IP
- Netmask
- Gateway
- Port
- DHCP settings

Set the Ethernet communication parameters as described in Section 6.4.9.



Caution

CAUTION: Please contact your network administrator for proper settings.



Caution

CAUTION: Please consult your computer resources department prior to connecting this instrument to your network to verify there are no conflicts with existing IP addresses.

The Ethernet communication port allows the CPC4000 to communicate with computers using 10/100Based-T specifications.

Before using Ethernet communication, four parameters must be set up: IP, Netmask, Gateway, and Port.

Industrial Pressure Controller CPC4000

7.4 Serial

Set the Serial communication parameters as shown in Section 6.4.9 Remote Application. The serial communication port allows the CPC4000 to communicate in RS-232 format with computers, terminals, PDAs, or similar hosts.

These parameters should be set to match your host computer. Default settings are: 9600 baud, 8 data bits, 1 stop bit, no parity, and no echo.

If echo is ON, the CPC4000 will immediately echo back characters sent over the serial port. The Serial function allows the user to set the RS-232 serial port settings by selecting from the choices provided:

- Baud
 - 9600
 - 19200
 - 38400
 - 57600
 - 115200
- Data Bits
 - 7
 - 8
- Stop Bits
 - 1
 - 2
- Parity
 - Even
 - Odd
 - None
- Echo settings
 - On
 - Off

7.4.1 Serial Cable Requirements

RS-232 communications are transmitted over a three conductor, shielded cable terminated in a standard DB9 connector on the instrument end, and a different gender connector on the host end. The proper pin-outs are shown in the following illustration.



7.5 Mensor Command Set

This Mensor command set is the default on the CPC4000. For queries (ending with a ?), the Data column represents the response of the CPC4000. All response strings begin with a space character or an “E” representing that there is an error in the error queue. All response strings are terminated with a <CR> and a <LF>. The error queue holds the last 10 errors identified.

For all commands (no ?), the data column represents the required parameters to be sent to the CPC4000 following the string in the command column. For any command that requires multiple parameters to be sent, the parameters must be separated by commas.

7.5.1 Command and Query Format

Commands must be sent in ASCII format and terminated with either a carriage return (<cr>), linefeed (<lf>), or both. Commands are not case sensitive. Each query returns a response. If an error is detected the response will include an error flag.

Command or Query field: Unless otherwise specified, commands are typically converted to queries by appending a question mark to the command. Table 7.5.4 lists all of the CPC4000 command or query keywords.

Data field: The data field is either in ASCII {string} or numeric {value} form. In the case of multiple data fields, commas are required to separate the fields. Queries do not have a data field. String (text) or value (numeric) data are acceptable in any of the following formats:

Examples of {string} data: ON, OFF, mBar, inHg

Examples of {value} data: 1, 1.0, -5.678, 25.68324e-5

7.5.2 Command Set Definitions

In this manual, a data entry made up of alpha characters is defined as a string, as opposed to data containing only numbers, such as “Enter 1 for ON or 0 for OFF” where 1 and 0 are defined as values.

Command: Any command or query listed in Table 7.5.4. For commands that take boolean data the following strings are acceptable:

0	1
False	True
No	Yes
Off	On

Separator: Space (SP).

Data: ASCII representations of numbers, {value}, or alpha characters, {string}, data as defined above. When sending code a literal variable replaces the brackets and the enclosed character(s) shown in the following examples.

Termination: Linefeed (LF) or carriage return (CR) is used to signal the end of a command statement. For IEEE-488.2 operation “EOI” is an acceptable alternative.

Always send commands in one of the following formats:

1. [Command] [Termination];
2. [Command] [Separator] [Data] [Termination];
3. Queries are special instructions in the form: [Command?] [Termination] where the question mark, “?”, immediately precedes the terminator.

When a valid query is received, the CPC4000 will return {data} terminated by CR and LF. Floating point data is returned in the current engineering units in exponential format.

7.5.3 Output Formats

Pressure readings are returned in exponential notation in a format according to the **OUTFORM** command as follows.

Output formats

1. <sp> pressure value <cr><lf>
2. <sp> pressure, units, mode <cr><lf>
3. <sp> pressure, pressure rate <cr><lf>
4. <sp> pressure, minimum peak, maximum peak <cr><lf>
5. <sp> pressure, active sensor (P or S) active turndown (1)<cr><lf>
6. <sp> pressure, control point, “stable” or “slewing”<cr><lf>
7. <sp> pressure, “no barometer” or baro reading<cr><lf>

7.5.4 Mensor Command Set and Queries

Table 7.5.4 lists all of the current CPC4000 commands and queries.

Optional emulation modes are available in which a CPC4000 can emulate remote functions of different brands of pressure gauges. Please contact Mensor for more details.

Table 7.5.4 - CPC4000 Mensor Command Set

Command	Data	Response/Function
?	See Section 7.5.3	Returns data per the current output format
Acquire?	15 char string. Ex: Acquire? Test_stand_1 Returns: <sp>(YES or NO), CCC... CCC<cr><lf>	This command is used when multiple computers would like to control the instrument. Yes if acquisition is successful No if instrument is being controlled with another computer CCC... = name of controlling computer (see Release? and Unlock)
Address	1-31	Sets the GPIB Address
Address?	<sp>nn<cr><lf>	Returns the GPIB Address
Asset_tag	16 char string	General purpose string for customer use
Asset_tag?	<sp>ssssssssssssssss<cr><lf>	Return customer asset tag string
Autorange	ON or OFF	Sets whether the autorange function is enabled or disabled
Autorange?	<sp>(ON or OFF)<cr><lf>	Returns whether the autorange function is enabled or disabled.

Autozero	none	Re-zero all the ranges. These adjustments are not password protected and are saved permanently through power cycles while the instrument is in native mode (temporary while in emulation mode). This command takes approximately 60 seconds but may take longer depending on the time to become stable.
Autozero?	S,T,X,X	Returns autozero data where S represents state (0 = complete, 1 = local autozero, 2 = remote autozero), T represents the estimated time to complete in seconds, and x is a (0) character since this data location is not used at this time.
Autozeroabort	none	Aborts autozero. Any transducers that have been zeroed will not revert to previous zero offsets.
Auxdisp <n>	NONE,PEAK,RATE,RATE SETPOINT,UNCERTAINTY,UNITS	Sets the auxiliary display setting for index <n> (0 to 2). If <n> is left out, defaults to index 0.
Auxdisp? <n>	<sp>NONE,PEAK,RATE,RATE SETPOINT,UNCERTAINTY,UNITS<cr><lf>	Returns the auxiliary display setting for index <n>. If <n> is left out, defaults to index 0.
Baro?	<sp>+n.nnnnnE+nn<cr><lf>	Returns reading from barometric transducer or “NO BAROMETER” if one isn’t installed
Barounits	units code or text in table below	Sets the barometer pressure units
Barounits?	<sp>CCCC<cr><lf>	Returns the barometer units in a text string
Burst_Detect	YES,NO	Sets burst detection enable, see Section 6.4.3.8 Detection Flags
Burst_Detect?	<sp>(YES or NO)<cr><lf>	Returns whether burst detection is enabled or not
Burst_Start		Changes the screen to the Burst Test if on another screen, begins the burst test with current parameters.
Burst_Stop		Stops the test and vents the system.
Burst_State?	<sp>(IDLE or RUNNING or COMPLETE)<cr><lf>	Returns state of the burst test
Burst_Low	value inside upper and lower limits	This is the lower pressure of the anticipated “burst range”
Burst_Low?	<sp>n.nnnnnE+nn<cr><lf>	Returns the lower pressure limit for burst test
Burst_High	value inside upper and lower limits	This is the higher pressure limit of the anticipated “burst range”

Industrial Pressure Controller CPC4000

Burst_High?	<sp>n.nnnnnE+nn<cr><lf>	Returns the higher pressure limit for burst test
Burst_Slow	value inside upper and lower limits	This is the rate used during the transition from low setpt to high setpt in the anticipated "burst range"
Burst_Slow?	<sp>n.nnnnnE+nn<cr><lf>	Returns the slow rate for burst test
Burst_Fast	value inside upper and lower limits	This is the rate used during the transition from atmosphere to the low setpt
Burst_Fast?	<sp>n.nnnnnE+nn<cr><lf>	Returns the fast rate for burst test
Burst_Result?	<sp>n.nnnnnE+nn<cr><lf>	Pressure at which burst was detected. Will return 0 if no burst found.
Calculate_as_found_linearity		Calculate linearity slopes and intercepts from true/actual pressures
Caldisable	YES,NO	Sets whether or not calibration of the active transducer is disabled.
Caldisable?	<sp>(YES or NO)<cr><lf>	Returns whether or not calibration of the active transducer is disabled.
Calibration_mode?	<sp>(YES or NO)<cr><lf>	Returns the current calibration mode setting
Calibration_mode	YES, NO	Enable/ disable the calibration mode, which when on, disables the sensor overpressure error and forces range hold to lock the secondary shutoff valve. Normally the secondary range is always allowed to go to its maximum pressure to avoid a large pressure disturbance when switching to it.
Cerr	None	Clears the error queue
Cmdset	Mensor, DPI510, SCPI	Activates remote command set for instrument emulation modes.
Cmdset?	<sp><CCCCCC><cr><lf>	Returns active command set identifier
Control		Instrument placed in Control Mode
Control?	<sp>(YES or NO)<cr><lf>	Returns YES if instrument is in control. NO if otherwise
Control_behavior <n>	0 to 100	100 = highspeed, 0 = low overshoot. May be set between 0 and 100.
Control_behavior?	<sp>NNN<cr><lf>	Returns the control behavior number
Control_default	PRECISION, HIGHSPEED, CUSTOM or NONE	Sets the current control settings
Control_default?	<sp>(PRECISION, HIGHSPEED, CUSTOM or NONE)<cr><lf>	Returns the current control settings
Crate	Slow, Medium, Fast, Variable	Sets the control rate, Variable mode is a predetermined user defined rate setpt.

Crate?	<sp>CCCCC<cr><lf>	Returns the control rate – CCCC is variable in length and corresponds to the parameters for the CRATE command
Ctype?		Returns the type of regulator
Decpt?	<sp>n<cr><lf>	Returns the number of decimal points (see Resolution)
Default	None	Sets the default values
DHCP	ON or OFF	Reserved for DHCP setup
DHCP?	<sp>(YES or NO)<cr><lf>	Reserved for DHCP setup
DOC	mm/dd/yyyy	Sets the date of cal for the active transducer.
DOC?	<sp>mm/dd/yyyy<cr><lf>	Returns the date of cal for the active transducer.
DOM?	<sp>mm/dd/yyyy<cr><lf>	Returns the date of manufacture
Error?	<sp> text description <cr><lf>	Returns the next error in the error queue
Errorno?	<sp>Enn-text<cr><lf>	Returns pcs400 error code and text
Filter	OFF, LOW, NORMAL, HIGH	Sets the reading filter 0, 80%, 92%, 95%
Filter?	<sp> (filter)<cr><lf>	Returns the reading filter.
Gasdensity	Value in lb/cuft, or “NITROGEN” or “DRYAIR”	Sets the head pressure gas density in lb/cuft
Gasdensity?	<sp>+n.nnnnnE+nn<cr>	Gets the head pressure gas density in lb/cuft
Gastemp	Value in degrees F	Sets the head pressure gas temperature
Gastemp?	<sp>+n.nnnnnE+nn<cr><lf>	Gets the head pressure gas temperature
Gateway	nnn.nnn.nnn.nnn	Sets the Ethernet gateway address
Gateway?	<sp>nnn.nnn.nnn.nnn<cr><lf>	Gets the Ethernet gateway address
Height	Value in inches	Sets the head pressure height in inches
Height?	<sp>+n.nnnnnE+nn<cr><lf>	Gets the head pressure height in inches
Highspeed	ON or OFF	Sets the highspeed control mode, which sets the control behavior, stable window, stable delay, and rate set-point
Highspeed?	<sp>(YES or NO)<cr><lf>	Returns the status of the highspeed mode
Id?	<sp>MENSOR,CPC4000, ssssss,v.v.vv<cr><lf>	Ssssss is the serial number,v.v.vv is the CPC 4000 software version.

Industrial Pressure Controller CPC4000

Instrument_control_time_on?	<sp>NNNNN<cr><lf>	Returns the amount of time the instrument has been in control mode since the last reset of the counter, in minutes
Instrument_total_control_time_on?	<sp>NNNNN<cr><lf>	Returns the lifetime amount of time the instrument has been in control mode, in minutes
Instrument_time_on?	<sp>NNNNN<cr><lf>	Returns the amount of time the instrument has been on since the last reset of the counter, in minutes
Instrument_total_time_on?	<sp>NNNNN<cr><lf>	Returns the lifetime amount of time the instrument has been on, in minutes
IP	nnn.nnn.nnn.nnn	Sets the IP address of the instrument
IP?	<sp>nnn.nnn.nnn.nnn<cr><lf>	Returns the IP address of the instrument
Keylock	YES or NO	Locks or unlocks the entire touch screen
Keylock?	<sp>(YES or NO)<cr><lf>	Returns Yes or No
Leak_External	ON or OFF	Sets the leak test external valve setting in Single output A or B mode only
Leak_External?	<sp>(YES or NO)<cr><lf>	Returns the leak test external valve setting
Leak_Start		Changes the screen to the Leak Test if on another screen, begins the leak test with current parameters.
Leak_Stop		Stops the test and vents the system.
Leak_State?	<sp>(IDLE or RUNNING or COMPLETE)<cr><lf>	Returns state of the leak test
Leak_Setpt	value inside upper and lower limits	Starting point for the leak test to begin at
Leak_Setpt?	<sp>n.nnnnnE+nn<cr><lf>	Returns starting setpt
Leak_Dwell	0 to 3600	The duration of the test during which a leak is measured
Leak_Dwell?	<sp>n.nnnnnE+nn<cr><lf>	Returns the dwell time in seconds
Leak_Pre_Dwell	0 to 3600	Pre-dwell parameter is the time in between going to measure mode, and the dwell time. Useful if there are pressure transients after switching to measure.
Leak_Pre_Dwell?	<sp>n.nnnnnE+nn<cr><lf>	Returns the pre-dwell time.
Leak_Delta_Limit	Value within the range of the primary transducer	Threshold for a passing/failing leak test.
Leak_Delta_Limit?	<sp>n.nnnnnE+nn<cr><lf>	Returns the maximum pressure change allowed before failure

Leak_Delta?	<sp>n.nnnnnE+nn<cr><lf>	Returns the change in pressure since start of test.
Leak_Initial?	<sp>+n.nnnnnE+nn<cr>	Returns the leak test initial pressure
Leak_Final?	<sp>+n.nnnnnE+nn<cr>	Returns the leak test final pressure
Leak_Pass?	<sp>(YES or NO)<cr><lf>	
List?	<sp>Pri,1;Sec,1;Bar,1<cr><lf>	Returns list of available transducers and turndowns. Turndowns are unavailable for CPC4000 but returns 1 for backwards compatibility.
Listcal?	<sp>PRI,{sn},1,{mmddy};SEC,{sn},1,{mmddy},{sn},1,{mmddy},BAR,{sn},{ mmddy}<cr><lf>	Returns list of available transducers including serial number and date of calibration
Listrange?	PRI,1,min,max;SEC,1,min,max;Bar,min,max	Returns the ranges of the installed transducers.
Listsensorinfo?	<sp>PRI,SN,PTYPE,ACCURACY,1,min,max,2,min,max;SEC,SN,PTYPE,ACCURACY,1,min,max,2,min,max;<cr><lf>	Returns the serial number, pressure type, accuracy, and ranges of the installed sensors for the active channel
Listconfig?	CHA, Regtype;PRI,1,min,max;SEC,1,min,max;CHB, Regtype;PRI,1,min,max;SEC,1,min,max;CHbaro,Baro;Bar,min,max	Returns the regulator types (Regtype: Pump, LPSVR, MPSVR, HPSVR, EPSVR) along with all the ranges of the installed transducers.
Localgravity	Value in ft/s ²	Sets the local gravity in feet/sec ²
Localgravity?	<sp>+n.nnnnnE+nn<cr><lf>	Returns the local gravity in feet/sec ²
LowerLimit	Value inside primary xducer range in current units.	Sets the lower control limit for the instrument
LowerLimit?	<sp>n.nnnnnE+nn<cr><lf>	Returns the lower control limit for the instrument in current units.
Macaddress?	<sp>cc-cc-cc-cc-cc-cc<cr><lf>	Returns Ethernet MAC address
Measure	None	Instrument placed in Measure Mode
Measure?	<sp>(YES or NO)<cr><lf>	Returns YES if instrument is in measure. NO if otherwise
Meas_Reg	ON or OFF	Sets the regulation of the pressure across the Measure/Control solenoid, see Section 6.4.3.8 Detection Flags
Meas_Reg?	<sp>(YES or NO)<cr><lf>	Returns whether measure regulation is enabled
Mode	MEASURE, CONTROL, VENT	Sets the operation mode
Mode?	<sp>XXXXXX<cr><lf>	Returns the operation mode
Netmask	nnn.nnn.nnn.nnn	Sets the Ethernet network mask
Netmask?	<sp>nnn.nnn.nnn.nnn<cr><lf>	Gets the Ethernet network mask
OSversion?	<sp>n.n<cr><lf>	Returns the operating system version
Outform	1 to 7 – see table in Section 7.8	Sets the output format

Industrial Pressure Controller CPC4000

Outform?	<sp>X<cr><lf>	Returns the output format – see table in Section 7.8
Peakmax?	<sp>n.nnnnnE+nn<cr><lf>	Returns the maximum pressure since peakreset was sent.
Peakmin?	<sp>n.nnnnnE+nn<cr><lf>	Returns the minimum pressure since peakreset was sent.
Peakreset	None	Resets the peak values.
Port	nnnnnn	Sets the Ethernet port of the instrument
Port?	<sp>nnnnn<cr><lf>	Returns the Ethernet port of the instrument
Precision	ON or OFF	Sets the precision control mode, which sets the control behavior, stable window, stable delay, and rate set-point
Precision?	<sp>(YES or NO)<cr><lf>	Returns the status of the precision mode
Ptype	Absolute or Gauge	Sets the instrument pressure type – emulation only works if the optional barometric transducer is installed. If no barometer is present, standard atmosphere is used for the barometric reading when in emulation mode.
Ptype?	<sp>CCCCC<cr><lf>	Returns “Absolute” or “Gauge” for the pressure type in native mode and “Absolute Emulated” or “Gauge Emulated” for the emulated pressure types
Purge	Value inside upper and lower limits, never in the vacuum region	Start purge sequence with DUT pressure as the setpoint. Only applicable with option PURGE enabled
Purge?	<sp>S,T<cr><lf>	Returns purge data where S represents state (0 = complete, 1 = local purge, 2 = remote purge), T represents the estimated time to complete in seconds
Purgeabort?		Aborts purge sequence if currently running. Only applicable with option PURGE enabled
RangeMax?	<sp>n.nnnnnE+nn<cr><lf>	Returns the maximum range of the active transducer in the current units.
RangeMin?	<sp>n.nnnnnE+nn<cr><lf>	Returns the minimum range of the active transducer in the current units.
Rate?	<sp>n.nnnnnE+nn<cr><lf>	Returns the rate reading of the instrument in current units/current time unit (see Runits)
Rdecpt?	<sp>n<cr><lf>	Returns the number of rate decimal points.(see Resolution)

Reference	{EXTVAC or ATM}	Sets the reference type for vacuum pump connected to the reference, or vented to atmosphere. This option is available only on native gauge units.
Reference?	<sp>{EXTVAC or ATM}<cr><lf>	Returns the current reference type. (see Reference)
Release?	15 char string. Ex: Release? Test_stand_1 Returns: <sp>(YES or NO), CCC... CCC<cr><lf>	This command is used to release control of the instrument in a multiple computer environment. Yes if release is successful No if instrument is being controlled with another computer CCC... = name of controlling computer or AVAILABLE (see Acquire? and Unlock)
Reset_instrument_time_on		Resets the instrument's time on counter. See usage application for more details
Reset_instrument_control_time_on		Resets the instrument's time on counter. See usage application for more details
Resolution	<n>	Sets the number of significant digits. (see decpt)
Resolution?	<sp>n<cr><lf>	Returns the number of significant digits. (see decpt)
Rfilter	Value in %	Sets the % of the rate filter
Rfilter?	<sp>n.nnnnnE+nn<cr><lf>	Returns the rate filter.
Rsetpt	Value in current units	Sets the rate setpoint
Rsetpt?	<sp>n.nnnnnE+nn<cr><lf>	Returns the rate setpoint
Runits	Sec, min, hr	Sets the rate time unit
Runits?	<sp>XXXX<cr><lf>	Returns the rate time unit
Save_cal		Save calibration values
Save_linearity		Save linearity values
Sbaud	9600, 19200, 38400, 57600, 115200	Sets the serial baud rate
Sbaud?	<sp>XXXX<cr><lf>	Returns the serial baud data
Sdata	7 or 8	Sets the serial data bits
Sdata?	<sp>n<cr><lf>	Returns the serial data bits number
Sensor	1,2, P,S, PRIMARY, SECONDARY	Sets the active transducer. Accepts multiple format types. Sensor may be specified with P, S, 1 or 2.

Industrial Pressure Controller CPC4000

Sensor?	<sp>XXXXXXXX,1<cr><lf>	Returns active transducer in long string format
Sensorid?	<sp>Mensor,SN XXXXXX, VN.NN	Returns the active transducer's serial number and firmware version
Setpt	value inside upper and lower limits	Sets the control setpoint for the instrument
Setpt?	<sp>XXXXXXXX<cr><lf>	Returns the control setpoint in current units.
Setpt%	Value in % of primary range	Sets the control setpoint in % of primary range
Setptpct	Value in % of primary range	Sets the control setpoint in % of primary range
Setptpct?	<sp>n.nnnnnE+nn<cr><lf>	Returns the current setpoint in % of primary range
Setpoint	Value in % of primary range	Sets the control setpoint in % of primary range
Setpoint?	<sp>n.nnnnnE+nn<cr><lf>	Returns the current setpoint in % of primary range
Setpointpct	Value in % of primary range	Sets the control setpoint in % of primary range
Setpointpct?	<sp>n.nnnnnE+nn<cr><lf>	Returns the current setpoint in % of primary range
Span	desired pressure or ?	Sets span on active transducer or for ?, clears previous value, must be > 50% FS and has a 1% limit. CALDIS-ABLE must be OFF/NO.
Span?	<sp>XXXXXXXX<cr><lf>	Returns span scale factor for active transducer
Sparity	Even, ODD, NONE	Sets the serial and USB parity
Sparity?	<sp>CCCC<cr><lf>	Returns the serial and USB parity
Srqmask	Stable,Error or both	Sets the CPC 4000 to issue a service request(SRQ) over the IEEE when the pressure Control is stable, or an error occurs. These are 80 hex and 40 hex respectively
Srqmask?	<sp>{string}<cr><lf>	Returns "stable", "error" or "error, stable" depending on the SRQ.
Sstop	1 or 2	Sets the serial and USB stop bits
Sstop?	<sp>X<cr><lf>	Returns the serial and USB stop bits
Stable?		Returns YES if instrument is stable or No
Stabledelay	0 to 3600	Sets the stable time to the number of seconds specified
Stabledelay?	<sp>XXXXXXXX<cr><lf>	Returns the stable time.
Stabletime	0 to 3600	Sets the stable time to the number of seconds specified

Stabletime?	<sp>XXXXXXX<cr><lf>	Returns the stable time.
StableWin	%FS value	Sets the stable window as a %FS
StableWin?	<sp>n.nnnnnE+nn<cr><lf>	Returns the stable window.
Standby	None	Instrument placed in Standby Mode
Standby?	<sp>(YES or NO)<cr><lf>	Returns yes if instrument is in Standby, no if otherwise
Step	Value inside upper and lower limits and inside the range of the active transducer.	Sets the control step size for the instrument
Step-		Jogs the setpoint down one step
Step+		Jogs the setpoint up one step
Step?	<sp>+n.nnnnnE+nn<cr><lf>	Returns the control step for the instrument
Step%	Value in % of current range	Sets the control step in % of current range
Steppct	Value in % of current range	Sets the control step in % of current range
Steppct?	<sp>n.nnnnnE+nn<cr><lf>	Returns the current step in % of current range
Supply_Detect	YES or NO	Detects whether enough supply pressure is connected, see Section 6.4.3.8 Detection Flags
Supply_Detect?	<sp>(YES or NO)<cr><lf>	Returns whether detection is enabled
Tare	ON / OFF	Tares the reading to zero
Tare?	<sp> n.nnnnnE+nn <cr><lf>	Returns value of Tare
Termchar	CCCC	Set the output termination character(s). CR, LF, CRLF, DEFAULT, EOI, NONE
Termchar?		Returns the termination character setting
Transfer_factory_to_linearity		Copy factory linearity coefficients to customer
Units	units code or text in table below	Sets the instrument engineering units
Units?	c	Returns the instrument units in a text string
Unlock	None	Releases Acquire locks
UpperLimit	Value inside primary transducer range in current units.	Sets the Upper control limit for the active transducer.
UpperLimit?	<sp>xxxxxxx<cr><lf>	Returns the upper control limit for the active transducer.
Vent	None	Instrument placed in Vent Mode
Vent?	<sp>(YES or NO)<cr><lf>	Returns yes if instrument is in Vent, no if otherwise
Volume	AUTO or Value in cc between 0-2000	Sets the system volume in cc's

Industrial Pressure Controller CPC4000

Volume?	<sp>AUTO or Xxxx<cr><lf>	Returns the system volume in cc's
Window	Value in current units	Sets the exponential filter window for the active transducer
Window?	<sp>n.nnnnnE+nn<cr><lf>	Returns the exponential filter window for the active transducer
Zero	desired pressure or ?	Sets zero to set pressure or for ?, clears previous value. CALDISABLE must be OFF/NO.
Zero?	<sp>n.nnnnnE+nn<cr><lf>	Returns zero offset for active transducer

7.5.5 Units Command Syntax for Measurement Units

n	Description	Output Format	Type
1	pounds per square inch	PSI	Imperial
2	inches of mercury @ 0°C	INHG	Imperial
3	inches of mercury @ 60°F	INHG	Imperial
4	inches of water @ 4°C	INH2O	Imperial
5	inches of water @ 20°C	INH2O	Imperial
6	inches of water @ 60°F	INH2O	Imperial
7	feet of water @ 4°C	FTH2O	Imperial
8	feet of water @ 20°C	FTH2O	Imperial
9	feet of water @ 60°F	FTH2O	Imperial
10	millitorr	MTORR	Metric
11	inches of sea water @ 0°C	INSW	Imperial
12	feet of sea water @ 0°C	FTSW	Imperial
13	atmospheres	ATM	Imperial
14	bars	BAR	Metric
15	millibars	MBAR	Metric
16	millimeters of water @ 4°C	MMH2O	Metric
17	centimeters of water @ 4°C	CMH2O	Metric
18	meters of water @ 4°C	MH2O	Metric
19	millimeters of mercury @ 0°C	MMHG	Metric
20	centimeters of mercury @ 0°C	CMHG	Metric
21	torr	TORR	Metric
22	kilopascals	KPA	Metric
23	pascals	PA	Metric
24	dynes per square centimeter	DY/CM ²	Metric
25	grams per square centimeter	G/CM ²	Metric
26	kilograms per square centimeter	KG/CM ²	Metric
27	meters of sea water @ 0°C	MSW	Metric
28	ounce per square inch	OSI	Imperial
29	pounds per square foot	PSF	Imperial
30	tons per square foot	TSF	Imperial
32	micron of mercury @ 0°C	mHG	Metric
33	tons per square inch	TSI	Imperial
34	meters of mercury @ 0°C	MHG	Metric
35	hectapascals	HPA	Metric
36	megapascals	MPA	Metric
37	millimeters of water @ 20°C	MMH2O	Metric
38	centimeters of water @ 20C	CMH2O	Metric
39	meters of water @ 20°C	MH2O	Metric

7.5.6 Error Messages

All remote commands sent to the CPC4000 are shown in the Trouble Shooting App, under the “Remote” button. If there is a syntax error, an error message will appear below the errant command. Local errors and remote command errors will appear under the “Error” button. Maximum of 100 errors are stored and can be retrieved.

The error messages can also be seen remotely by sending “Error?” to the instrument.

Error String Returned
NO ERRORS
Parameter error: <s>; where <s> is the input from the remote interface
Syntax error: <s>; where <s> is the input from the remote interface
Command error: zero 10: see: caldisable; occurs when calibration mode is disabled

7.6 SCPI Command Set

7.6.1 SCPI Commands and Queries

The WIKA SCPI command is compatible with older WIKA instruments such as the original CPC8000

Notes:

1. Note that WIKA and Ruska 7010 Emulation return slightly different responses to some queries.
2. Except for the engineering units selection, the numeric suffix selects the applicable transducer [R]:

- 1 = Sensor 1
- 2 = Sensor 2

This numeric suffix [R] always defaults to the active transducer if not specified.

Table 7.6.1 - CPC4000 SCPI Command Set

Command	Response/Function
STATus	
:OPERation	
:CONDition?	Returns an integer value representing instrument status that can be decoded. Bit 0: Zeroing active Bit 1: Control Setpoint has not been reached. Bit 2: Reserved 0. Bit 3: Reserved 0. Bit 5: Measuring. The instrument is actively measuring
MEASure	
[:PRESsure][R]?	Returns the pressure from range R
:TEMPerature[R]?	Returns the temperature from range R
:RATE[R]?	Returns the rate/sec from range R
:BAROmetric?	Returns the barometric pressure

CALibration	
[:PRESsure][R]	
:MODE?	Returns 1=calibrated or 0=not calibrated
:DATE?	Returns date of cal "MM/DD/YY"
:DATE <i,i,i>	Sets date of cal YYYY,MM,DD
:ZERO?	Returns zero offset
:ZERO <n>	Sets the zero offset
:ZERO:RUN	Start Autozero sequence
:ZERO:STOP	Stop Autozero sequence
:ZERO:INITiate?	Returns zero status
:ZERO:INITiate	Ignored
SENSe	
[:PRESsure][R]	
:NAME?	Returns transducer name string
:MODE?	Returns "ABSOLUTE" or "GAUGE"
:MODE ABS GAUGE	Sets pressure type
:ABS?	Returns native transducer type 0=GAUGE 1=ABSOLUTE
:RESolution?	Returns resolution (float)
:RANGe	
[:UPPer]?	Returns maximum range
:LOWer?	Returns minimum range
:UNIT	
[:NAME]?	Returns ASCII units (mixed case)
:VALue?	Returns the units conversion factor
:REFerence	
[:HEIGHt] <n>	Sets the head pressure height
:HEIGHt?	Returns the head pressure height
:MODE?	Returns "OFF", "HELIUM", "DRYAIR", or "NITROGEN"
:MODE OFF HELIUM DRY AIR NITROGEN	Sets the head pressure mode
:MEDium<n>	Sets the medium density
:MEDium?	Returns medium
:ACTive <n>	Sets the active transducer
ACTive?	Returns the active transducer
SYSTem	
:DATE <i,i,i>	Not used, kept for backwards compatibility
:DATE?	Not used, does not cause an error, does not return a response
:TIME <i,i,i>	Not used, kept for backwards compatibility

Industrial Pressure Controller CPC4000

:TIME?	Not used, does not cause an error, dose not return a response																																																																																												
:ERRor[:NEXT]?	Returns error code, description																																																																																												
:KLOCK ON OFF 1 0	Sets the keylock state																																																																																												
:PRESet	Load known state values																																																																																												
:SAVe	No function (not needed)																																																																																												
:VERSion?	Returns SCPI version 1994.0																																																																																												
TEST																																																																																													
:ELECTronic?	Returns "OK"																																																																																												
:RELay<n>?	Returns status of digital output <n>																																																																																												
:RELay<n> ON OFF	Turns the digital output on or off <n>																																																																																												
UNIT																																																																																													
:[PRESsure] bar mbar Pa psi	Sets the pressure units																																																																																												
:[PRESsure]?	Returns the pressure units																																																																																												
:NAME<n>?	Returns the units string for units code <n>																																																																																												
:FACTor <n>?	Returns the units conversion for units code <n>																																																																																												
:INDEX <n>	Sets the index number.																																																																																												
:INDEX?	<p>Returns the index number.</p> <table border="1"> <thead> <tr> <th>index</th> <th>unit</th> <th>index</th> <th>unit</th> </tr> </thead> <tbody> <tr><td>0</td><td>bar</td><td>21</td><td>OSI</td></tr> <tr><td>1</td><td>mbar</td><td>22</td><td>TSI</td></tr> <tr><td>2</td><td>Pa</td><td>23</td><td>TSF</td></tr> <tr><td>3</td><td>psi</td><td>24</td><td>ftH2O(20°C)</td></tr> <tr><td>4</td><td>atm</td><td>25</td><td>ftH2O(60°F)</td></tr> <tr><td>5</td><td>kp/cm2</td><td>26</td><td>inSW</td></tr> <tr><td>6</td><td>lbf/ft2</td><td>27</td><td>ftSW</td></tr> <tr><td>7</td><td>kPa</td><td>28</td><td>hPa</td></tr> <tr><td>8</td><td>cmH2O(4°C)</td><td>29</td><td>Mpa</td></tr> <tr><td>9</td><td>inH2O(4°C)</td><td>30</td><td>dyn/cm2</td></tr> <tr><td>10</td><td>inH2O(60°F)</td><td>31</td><td>mHg 0°C</td></tr> <tr><td>11</td><td>ftH2O(4°C)</td><td>32</td><td>Torr</td></tr> <tr><td>12</td><td>µmHg(0°C)</td><td>33</td><td>mTorr</td></tr> <tr><td>13</td><td>mmHg(0°C)</td><td>34</td><td>uHg 0°C</td></tr> <tr><td>14</td><td>cmHg(4°C)</td><td>35</td><td>mmH2O 4°C</td></tr> <tr><td>15</td><td>inHg(0°C)</td><td>36</td><td>mH2O 4°C</td></tr> <tr><td>16</td><td>inHg(60°F)</td><td>37</td><td>mmH2O 20°C</td></tr> <tr><td>17</td><td>--</td><td>38</td><td>cmH2O 20°C</td></tr> <tr><td>18</td><td>user</td><td>39</td><td>mH2O 20°C</td></tr> <tr><td>19</td><td>user</td><td>40</td><td>mSW</td></tr> <tr><td>20</td><td>user</td><td>41</td><td>g/cm2</td></tr> <tr><td></td><td></td><td>42</td><td>Kg/m2</td></tr> </tbody> </table>	index	unit	index	unit	0	bar	21	OSI	1	mbar	22	TSI	2	Pa	23	TSF	3	psi	24	ftH2O(20°C)	4	atm	25	ftH2O(60°F)	5	kp/cm2	26	inSW	6	lbf/ft2	27	ftSW	7	kPa	28	hPa	8	cmH2O(4°C)	29	Mpa	9	inH2O(4°C)	30	dyn/cm2	10	inH2O(60°F)	31	mHg 0°C	11	ftH2O(4°C)	32	Torr	12	µmHg(0°C)	33	mTorr	13	mmHg(0°C)	34	uHg 0°C	14	cmHg(4°C)	35	mmH2O 4°C	15	inHg(0°C)	36	mH2O 4°C	16	inHg(60°F)	37	mmH2O 20°C	17	--	38	cmH2O 20°C	18	user	39	mH2O 20°C	19	user	40	mSW	20	user	41	g/cm2			42	Kg/m2
index	unit	index	unit																																																																																										
0	bar	21	OSI																																																																																										
1	mbar	22	TSI																																																																																										
2	Pa	23	TSF																																																																																										
3	psi	24	ftH2O(20°C)																																																																																										
4	atm	25	ftH2O(60°F)																																																																																										
5	kp/cm2	26	inSW																																																																																										
6	lbf/ft2	27	ftSW																																																																																										
7	kPa	28	hPa																																																																																										
8	cmH2O(4°C)	29	Mpa																																																																																										
9	inH2O(4°C)	30	dyn/cm2																																																																																										
10	inH2O(60°F)	31	mHg 0°C																																																																																										
11	ftH2O(4°C)	32	Torr																																																																																										
12	µmHg(0°C)	33	mTorr																																																																																										
13	mmHg(0°C)	34	uHg 0°C																																																																																										
14	cmHg(4°C)	35	mmH2O 4°C																																																																																										
15	inHg(0°C)	36	mH2O 4°C																																																																																										
16	inHg(60°F)	37	mmH2O 20°C																																																																																										
17	--	38	cmH2O 20°C																																																																																										
18	user	39	mH2O 20°C																																																																																										
19	user	40	mSW																																																																																										
20	user	41	g/cm2																																																																																										
		42	Kg/m2																																																																																										
OUTPut																																																																																													

:STATe ON OFF 1 0	ON or 1 = Control OFF or 0 = Measure
:STATe?	Returns 0 for measure 1 for control
:MODE MEASure CONTrol VENT	Sets the mode indicated
:MODE?	Returns the mode string
:STABLE?	Returns 1 if stable 0 if not
:AUTOvent ON OFF 1 0	Autovent is always true on CPC4000
:AUTOvent?	Returns the state of the Vent mode
:AUTORange ON OFF 1 0	Turns autorange on or off
:AUTORange?	Returns "ON" or "OFF"
[SOURce]	
:PRESsure	
[:LEVel]	
[:IMMediate]	
[:AMPLitude] <n>	Sets the setpoint
[:AMPLitude]?	Returns the setpoint
:RSETPT <n>	Sets the rate setpoint in current units
:RSETPT?	Returns the rate setpoint in current units
:SLEW <n>	Sets the rate setpoint in %FS/sec
:SLEW?	Returns the rate setpoint in %FS/sec
:TOLerance?	Returns the stable window
:TOLerance<n>	Sets the stable window
CALCulate	
:LIMit	
:LOWer<n>	Set the minimum control limit
:LOWer?	Set the minimum control limit
:UPPer<n>	Set the maximum control limit
:UPPer?	Set the maximum control limit
:SYSTem	
:DETECT SLOW FAST CANCEL	Not used, kept for backwards compatibility
:DETECT?	Returns "0"

7.6.2 Error Messages

All remote commands sent to the CPC4000 are shown in the Trouble Shooting App, under the "Remote" button. If there is a syntax error, an error message will appear below the errant command. Local errors and remote command errors will appear under the "Error" button. Maximum of 100 errors are stored and

Industrial Pressure Controller CPC4000

can be retrieved.

The error messages can also be seen remotely when “SYST:ERR?” is sent any error in the error queue is returned, otherwise the following is returned: 0, “No Error”.

Error String Returned
0, “No error”
1, “Overflow”
102, “Syntax error”
114, “Parameter Out Of Range”
500, “<s>” (where <s> is the undefined error error string generated by the pneumatic module)
602, “Sensor not available”
999, “<s>” (where <s> is the undefined (unique) error string)

7.7 DPI 510 Emulation Command Set

The CPC4000 will accept and respond to Druck Model DPI 510 remote commands over a GPIB as listed below. These commands can be sent individually, or ganged together. Delimiters (separators) between commands are not required.

7.7.1 DPI 510 Supported Commands and Queries

Table 7.7.1 - DPI 510 Supported Commands and Queries

case '#':		
	usage "#L{nn}"	Simulate GPIB listener at address nn over serial port. Does not support multidrop.
	usage "#T{nn}"	Simulate GPIB talker at address ad over serial port. Does not support multidrop.
case '@':		/*Error Status (on/off)*/
	usage "@0"	sets error checking off
	usage "@1"	sets error checking on
case 'C':		/*Control_Mode / Measure_Mode*/
	usage "C0"	go to measure mode
	usage "C1"	go to control mode
	usage "C2"	go to standby mode
case 'D':		/*Display_Mode*/
	usage "D0"	returns active reading in any mode
	usage "D1"	returns setpoint only if in control mode, otherwise it returns 0.000
case 'E':		/*Clear_Error_Mode*/
	usage "E"	The PCS 400 will accept all types of termination; CR/LF/EOI. It will also accept the strings E0, E1 and E2, but will not respond to these.
	Note: Send "E?" to clear an error from the buffer (this is an added function, not part of the Druck command set).	
case 'F':		/*Function*/
	usage "F00"	does not apply to CPC4000
	usage "F01"	puts instrument into vent mode when C0 or controller is off
	usage "F02"	does not apply to CPC4000
	usage "F03"	does not apply to CPC4000
case 'I':		/*IO Service Request*/
	usage "I0"	dummy function accepts the string and returns what was entered
	usage "I1"	dummy function accepts the string and returns what was entered
	usage "I2"	dummy function accepts the string and returns what was entered
	usage "I3"	dummy function accepts the string and returns what was entered
	usage "I4"	dummy function accepts the string and returns what was entered
	usage "I5"	dummy function accepts the string and returns what was entered
	usage "I6"	dummy function accepts the string and returns what was entered
case 'J':		/*Rate_Mode*/
	usage "J0"	sets the rate mode to variable rate mode

Industrial Pressure Controller CPC4000

	usage "J1"	sets the rate mode to variable rate mode
	usage "J2"	sets the rate mode to regular control mode (default) MAX
	Note: All of the notation formats have a leading space!	
case 'N':		/*Notation_Mode*/
	usage "N0"	output format default responds with pressure/remote/range/scale/display/error
	usage "N1"	output format responds with pressure or setpoint depending on the display mode setting
	usage "N2"	output format responds with range/scale/display/control mode/IO/function/error
	usage "N3"	output format returns 0 for not stable or 1 for stable
	usage "N4"	output format returns error/error(on/off)/rate/variable rate/units
	N0	if display is set to 1 the pressure reading is the setpoint reading example 200.00REMR1S3D1@01 if display is set to 0 the pressure reading is the pressure reading example 199.98REMR1S3D0@01
	N1	if display is set to 1 the pressure reading is the setpoint reading example 200.00 if display is set to 0 the pressure reading is the pressure reading example 199.98
	N2	example R1S3D1C0I0F00@01
	N3	example 1
	N4	@01@1J0V+00009U BAR
case 'P':		/*Pressure_Setpoint_Mode*/
	usage "PXXXX.XXXX"	X = sets the pressure setpoint (ex. P13.5)
case 'R':		/*Range(xducer)*/
	usage "R0"	no range
	usage "R1"	range 1 if available (main range)
	usage "R2"	range 2 if available (secondary range)
case 'S':		/*Scale*/
	usage "S1"	sets the scale with one unit selection
	usage "S2"	sets another scale with another unit selection
	usage "S3"	sets the global scale enables all units to be selected
case 'U':		/*Units*/
	usage "UX"	X = the unit number (ex. U16 = psi)
case 'V':		/*Variable_Rate_Mode*/
	usage "VXXXXX"	X = the desired control rate setting (ex. V1)
case 'W':		/*Wait_Value_Mode*/
	usage "WXXX"	X = the desired stable delay setting in seconds (ex. W005 = 5 sec)

7.7.2 DPI 510 Unsupported Commands and Queries

Table 7.7.2 - DPI 510 Unsupported Commands and Queries

usage "A"	does nothing
usage "E "	does nothing
usage "O"	Zeroing, software will accept the command but does not affect the zero status of the instrument
usage "R0"	setting remote to local
usage "R1"	setting to remote
usage "I0"	does nothing
usage "I1"	does nothing
usage "I2"	does nothing
usage "I3"	does nothing
usage "I4"	does nothing
usage "I5"	does nothing
usage "I6"	does nothing
UNITNO 7	(kg/m ²) does nothing
UNITNO 10	(mHg) does nothing
UNITNO 17	(lb/ft ²) does nothing
UNITNO 21	(Special) does nothing

7.7.3 DPI 510 Measurement Units

The Measurement units below use conversion factors as listed in this manual's Appendix:

Table 7.7.3 - DPI 510 Measurement units

Druck Unitno	Units	Comments
1	Pa	
2	kPa	
3	mPa	
4	mbar	
5	bar	
6	kg/cm2	
7	kg/m2	not supported
8	mmHg	
9	cmHg	
10	mHg	not supported
11	mmH2O	
12	cmH2O	
13	mH2O 20c	
14	torr	
15	Atm	
16	psi	
17	1b/ft2	not supported
18	inHg	
19	"H2O 04c	
20	'H2O 04c	
21	Special	not supported
22	"H2O 20c	
23	'H2O 20c	

7.8 GE PACE (SCPI) Emulation Command Set

The CPC4000 will accept and respond to the SCPI remote commands of GE PACE 5000/6000 remote commands using the option SCPI_GE. Section 11, Technical Assistance explains the process of enabling the SCPI GE command set. Table 7.8.1 shows a complete list of supported commands.

7.8.1 SCPI GE Supported Commands and Queries

Table 7.8.1 SCPI GE Supported Commands and Queries

Command	Response/Function
CALCulate	
[:LIMit]	
:LOWer<n>	Set the minimum control limit *
:LOWer?	Set the minimum control limit *
:UPPer<n>	Set the maximum control limit *
:UPPer?	Set the maximum control limit *
CALibration	
[:PRESSure][R]	
:POINt?	Returns the number of calibration points used in the active sensor's linearity correction. Calibration functionality must be enabled by sending the calibration password. See SYST:PASS:CEN
:ZERO	
:AUTO	Start autozero process
:AUTO?	Returns 1 if autozero process is running, 0 otherwise
VALVe ON OFF 1 0	ON or 1 puts in vent mode, OFF or 0 puts in measure mode
:VALVe?	Returns 1 if in vent mode, 0 otherwise
INPut	
:LOGic?	Returns a single digit number that is a mask of the digital input states, i.e. a number of 7 in binary is 111 which indicates all digital inputs are on. Then current pressure reading. Ex// INP:LOG? :INP:LOG 7, 14.50021
:STATe?	Returns a single digit number that is a mask of the digital input states, i.e. a number of 7 in binary is 111 which indicates all digital inputs are on. Ex// INP:LOG:STAT? :INP:LOG :STAT 0

Industrial Pressure Controller CPC4000

INSTrument	
:CATalog[R]?	Returns the sensor pressure maximum in native units, native pressure units, native pressure type. Ex// INST:CAT? :INST:CAT "1000.000psig"
:CATalog	
:ALL?	Returns the primary sensor's pressure maximum in native units, native pressure units, native pressure type, secondary sensor's pressure maximum in native units, native pressure units, native pressure type, Barometer. If a sensor does not exist, it is not included. Ex// INST:CAT:ALL? :INST:CAT "1000.000psig", "300.0000psig", BAROMETER
:LIMits?	Returns the instrument's pressure maximum in native units, native pressure units, native pressure type, current upper control limit, current lower control limit. Ex// INST:LIM? :INST:LIM "1000.000psig", 1000.000, -15.0000
:MACaddress?	Returns the ethernet interface medium access control (MAC) hardware address in XX-XX-XX-XX-XX-XX format. Any letters will be upper case. Ex// :INST:MAC?" :INST:MAC "84-EB-18-B2-97-AB"
:SENSe[R]?	Returns the sensor pressure maximum in native units, native pressure units, native pressure type. Ex// INST:SENS? :INST:SENS "1000.000psig"
:SENSe[R]	
:CALD?	Returns the sensor calibration date in the format YYYY, MM, DD
:FULLscale?	Returns the sensor maximum pressure, minimum pressure in active units
:NEGCal?	Returns 1. Negative calibration support is always available
:SN?	Returns the sensor serial number

:SN[N]?	<p>Returns the serial number of device N. When N is not specified, default is 1. If the device does not exist, 0 is returned.</p> <table border="1" style="width: 100%; border-collapse: collapse;"> <thead> <tr> <th style="text-align: center;">N</th> <th style="text-align: center;">Device</th> </tr> </thead> <tbody> <tr> <td style="text-align: center;">1</td> <td>Instrument</td> </tr> <tr> <td style="text-align: center;">2</td> <td>Regulator</td> </tr> <tr> <td style="text-align: center;">3</td> <td>0</td> </tr> <tr> <td style="text-align: center;">4</td> <td>0</td> </tr> <tr> <td style="text-align: center;">5</td> <td>0</td> </tr> <tr> <td style="text-align: center;">6</td> <td>0</td> </tr> <tr> <td style="text-align: center;">7</td> <td>0</td> </tr> </tbody> </table>	N	Device	1	Instrument	2	Regulator	3	0	4	0	5	0	6	0	7	0
N	Device																
1	Instrument																
2	Regulator																
3	0																
4	0																
5	0																
6	0																
7	0																
:TASK?	<p>Returns the active task set remotely. The short string format is returned.</p> <p style="margin-left: 20px;">BAS (BASIC) BURST (BURSTTEST) DIV (DIVIDER) LEAK (LEAKTEST) PRE (PRESET) SWITCH (SWITCHTEST) PROG (TESTPROGRAM)</p>																
:TASK <CCC>	<p>Set the instrument task. Either the long or short version may be sent. Makes the active screen on the instrument be loaded. Loading a new task will force any other tasks being run to be stopped. Does not put the screen in keylock mode.</p> <p style="margin-left: 20px;">BAS/BASIC – loads home application BUR/BURST/BURSTTEST – loads burst test application DIV/DIVIDER – loads step settings application LEAK/LEAKTEST – loads leak test application PRE/PRES/PRESET – loads step settings application SWI/SWITCH/SWITCHTEST – loads switch test application PROG/TEST/TESTPROGRAM – loads the programs application</p>																
:UNIT?	<p>Returns the active units string.</p> <p>Ex// INST:UNIT? :INST:UNIT PSI</p>																

:VERSion[n]?	<p>Returns the software version of the device N in double quotes. When N is not specified, default is 1.</p> <p>Ex// INST:VERS2? :INST:VERS "v1.2"</p> <table border="1" data-bbox="841 432 1455 1050"> <thead> <tr> <th>N</th> <th>Device</th> </tr> </thead> <tbody> <tr> <td>1</td> <td>Instrument Software</td> </tr> <tr> <td>2</td> <td>Operating System (OS)</td> </tr> <tr> <td>3</td> <td></td> </tr> <tr> <td>4</td> <td>Regulator PIC</td> </tr> <tr> <td>5</td> <td>Regulator FPGA</td> </tr> <tr> <td>6</td> <td></td> </tr> <tr> <td>7</td> <td></td> </tr> <tr> <td>8</td> <td>Sensor 1</td> </tr> <tr> <td>9</td> <td>Sensor 2</td> </tr> <tr> <td>10</td> <td></td> </tr> <tr> <td>11</td> <td></td> </tr> <tr> <td>12</td> <td>Barometer</td> </tr> <tr> <td>13</td> <td>GPIO</td> </tr> </tbody> </table> <p>Ex// INST:VERS? :INST:VERS "v2.27.0"</p>	N	Device	1	Instrument Software	2	Operating System (OS)	3		4	Regulator PIC	5	Regulator FPGA	6		7		8	Sensor 1	9	Sensor 2	10		11		12	Barometer	13	GPIO
N	Device																												
1	Instrument Software																												
2	Operating System (OS)																												
3																													
4	Regulator PIC																												
5	Regulator FPGA																												
6																													
7																													
8	Sensor 1																												
9	Sensor 2																												
10																													
11																													
12	Barometer																												
13	GPIO																												
OUTPut																													
[:ISOLation]																													
:STATe?	Returns 1 if in Measure mode, 0 otherwise																												
:STATe ON OFF 1 0	ON or 1 puts in Measure mode, 0 puts in Vent mode																												
:LOGic?	Returns a single digit number that is a mask of the digital output states, e.g. a number of 7 in binary is 111 which indicates all digital outputs are on																												
:LOGic	Set the digital outputs with a mask (number from 0 to 7 for setting the three outputs). Note: the digital output functions will be automatically changed to "USER" and show up as "None" in the Application screen																												
:MODE Measure Control Vent	Sets the mode indicated. May use as low as 1 character in the data, i.e. 'V' for Vent, or 'VENT' for vent, etc.																												
:MODE?	Returns the mode string																												

:STABLE?	Returns 1 if in Control mode and pressure is stable, 0 otherwise
:STATe ON OFF 1 0	ON or 1 puts in Control mode , OFF or 0 puts in Measure mode
[:STATe]?	Returns 1 if in Control mode, 0 otherwise
SENSe	
[:PRESSure][R]	
:BARometer?	Returns the current barometer reading in active channel's units
:CORRection	
:OFFSet?	Returns the tare value in current units
:OFFSet <f>	Set the head pressure correction value in current units
:OFFSet	
:STATe?	Returns 1 if the tare value is currently enabled, 0 if not.
:STATe ON OFF 1 0	
:HEAD?	Returns the gas type, current head pressure correction in current units for the active channel. Ex// SENS:PRES:CORR:HEAD? :SENS:PRES:CORR:HEAD DRY AIR, 0.000000
:HEAD <"CCC", f>	Set the gas type and head pressure correction value in current units. Requires the gas type(CCC = AIR, HELIUM, NITROGEN) in double quotes, numeric value (float)
:STATe?	Returns 1 if the head pressure correction is currently enabled, 0 if not.
:STATe ON OFF 1 0	Enable or disable the head pressure correction
:VOLume?	Returns the calculated volume by the regulator in cubic centimeters. This value is constantly changing while in control mode
:VOLume	
:VALue?	Returns the regulator control volume. May be AUTO or a number in cubic centimeters
:VALue <f>	Set the regulator control volume to AUTO or a number (0 to 1000 for a pump, 0 to 2000 for a SVR)
:FILTer	
[:LPASs]	

Industrial Pressure Controller CPC4000

:STATe?	Returns if the filter is enabled (0 is off, 1 is on)
:STATe ON OFF 1 0	Set the filter enable
:BAND?	Returns the filter window
:BAND <f>	Set the filter window
:FREQUency?	Returns the filter frequency
:FREQUency <f>	Set the filter frequency
:INLimits?	Returns current pressure reading (float), stable flag (0 not stable, 1 stable)
:INLimits	
:TIME?	Returns the stable delay in seconds
:TIME<f>	Set the stable delay in seconds
:RANGe?	Returns primary sensor maximum pressure, units, and pressure type, i.e. "1000.000psig"
:RESolution?	Returns sensor resolution (integer 4 to 6)
:RESolution <n>	Set the sensor resolution
:SLEW?	Returns the rate in current units
SOURce	
[:PRESsure]	
[:LEVel]	
[:IMMEDIATE]	
[:AMPLitude]?	Returns the setpoint in current units
[:AMPLitude] <f>	Sets the setpoint in current units
:VENT?	Returns 1 if in vent mode and pressure is not fully vented (stable) yet, 0 otherwise. Proper usage: put in vent mode, then query this value until it is 0 again to know the system is vented.
:VENT ON OFF 1 0	ON or 1 puts in vent mode , OFF or 0 puts in Measure mode
:SLEW?	Returns the rate setpoint in current units
:SLEW <f>	Sets the rate setpoint in current units
:SLEW	
:MODE?	Returns MAX when highspeed mode is active. Returns LIN otherwise.
:MODE <CCC>	Set the control mode by putting in either High-speed or Custom mode. Note: the overshoot flag and control mode are not independent in Mensor products.
:OVERshoot?	Returns 1 if the channel's control behavior is >50. Returns 0 if the control behavior <=50.

:OVERshoot ON OFF 1 0	ON or 1 puts in “overshoot allowed” mode, where if the control behavior <90, it will be set to 100. OFF or 0 puts in low overshoot mode, where if the control behavior is >10, it will be set to 10.
:TOLerance?	Returns the stable window *
:TOLerance<n>	Sets the stable window *
:COMPensate?	Returns 0.0. Note: Mensor products do not have a source pressure sensor. †
:EFFort?	Returns the current channel’s regulator output, which is a number between -100 to +100 indicating how much % effort the regulator is using to achieve the setpoint.
STATus	
:[OPERation]?	Returns 0
:[OPERation]	
: CONDition?	Returns 0
: EVEnt?	Returns 0
[:QUESTionable]?	Returns 0
[:EVENT]?	Returns 0
[:ENABLE]?	Returns 0
SYSTem	
:AREA?	Returns the system locale area.
:AREA	Set the system locale area. Accepts the following (lower case letters are not required): EURope JAPan USA ASIA ROW (abbreviation for Rest of World)
:DATE?	Returns the system date in YY, MM, DD format
:DATE <i,i,i>	Set the system date
:PASSword	
:CEN	Enter the calibration password to enable calibration functionality. Applies to the entire instrument device. Once enabled, cannot be disabled until a power cycle. Calibration password is 2317100
:TIME?	Returns the system time in HH, MM, SS

Industrial Pressure Controller CPC4000

:TIME <i,i,i>	Set the system time
:ERRor?	Returns error code, description
:KLOCK?	Returns if keylock state
:KLOCK ON OFF 1 0	Sets the keylock state
:COMMunicate	
:USB?	Returns COMM
:SERial	
:BAUD?	Returns the serial communication baud rate
:BAUD	Set the serial communication baud rate
:CONTRol?	Returns 0
:CONTRol	
:RTS?	Returns 0
:RTS <n>	Accepts 0. All other values generate a parameter error (only flow control none is supported).
:XONX?	Returns 0
:XONX	Accept 0. All other values generate a parameter error (no handshaking modes supported).
:TYPE	
:PARity?	Returns the serial communication parity bit setting (NONE, EVEN, ODD)
:PARity <CCC>	Set the communication parity setting to NONE, ODD, or EVEN
:GPIB	
: SELF	
:ADDRess?	Returns the GPIB address
:SET?	Returns VENT, 0.0
:SET	Only accepts Vent, 0. Not allowed to boot up a Mensor product in any mode except vent mode with a setpoint of 0 for safety reasons.
UNIT	
:[PRESsure] <c>	Sets the pressure units. Accepts the unit code number, or the string value representation, i.e. psi. See unit code table below.
:[PRESsure]?	Returns the pressure units string
:DEFine[N]?	Returns the user defined units name, multiplication factor. Index N is 1 or 2.

:DEFine[N] <"CCC", f>	Sets the user defined units for index N. If N is not sent, will default to user units 1. Requires the desired unit name in double quotes, multiplication factor from Pascal (base units is always Pascal). Index N is 1 or 2
-----------------------	--

7.8.2 Error Messages

All remote commands sent to the CPC4000 are shown in the Trouble Shooting App, under the "Remote" button. If there is a syntax error, an error message will appear below the errant command. Local errors and remote command errors will appear under the "Error" button. Maximum of 100 errors are stored and can be retrieved.

The error messages can also be seen remotely when "SYST:ERR?" is sent any error in the error queue is returned, otherwise the following is returned: 0,"No Error".

Error String Returned
0, "No error"
1,"Overflow" (occurs when remote interface buffer of commands has become full. Command will not be processed)
102, "Syntax error"
102,"Syntax error;Unbalanced string."
105,"Parameter not supported, parameter 1"
105,"Parameter not supported, parameter 2"
108,"Parameter not allowed"
109,"Missing parameter"
113,"Undefined header"
113,"Command Unknown"
114,"Parameter Out Of Range"
114,"Header suffix out of range"
131,"Invalid suffix;Unit suffix not defined."
200,"Execution error;Query or command violation"
200,"Execution error;Type mismatched, parameter 1"
200,"Execution error;Type mismatched, parameter 2"
203,"Access error; Incorrect password"
220,"Parameter error"
240,"Hardware error"
500,"<s>" (where <s> is the undefined error error string generated by the pneumatic module)
201,"Query only"
207,"Enumeric value not in union"
602,"Sensor not available"
999,"<s>" (where <s> is the undefined (unique) error string)

Industrial Pressure Controller CPC4000

7.9 USB Software Upgrade

The instrument software can be upgraded to the most recent release by copying the instrument software from the Mensor website onto a USB device. The instrument software is device specific and the software for any other instrument apart from the CPC4000 is not accepted by the instrument. The user can then plug the USB device to the USB port on the front panel of the instrument for an easy upgrade. The instrument recognizes this device by displaying a USB icon on the top bar of the screen (figure 7.10). The user can navigate to the Software upgrade menu by clicking on the USB icon. The software upgrade menu gives the user information on the current instrument software and the version of instrument software on the USB device (figure 7.10-A).

The user can load the instrument software from the USB to the instrument by clicking on the desired version and then clicking [] button. The status of the installation can be seen on right one fourth of the screen.

The user also has the option to copy and load program test sequences (figure 7.10-B) from the USB drive which can later be accessed through the Programs App menu. Figure 7.10-C shows how to safely remove the USB drive.



Figure 7.10 – Home App with USB Icon

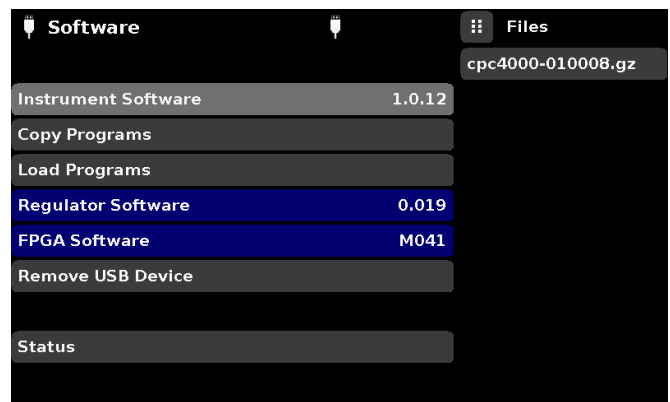

Figure 7.10-A – Software Upgrade Menu

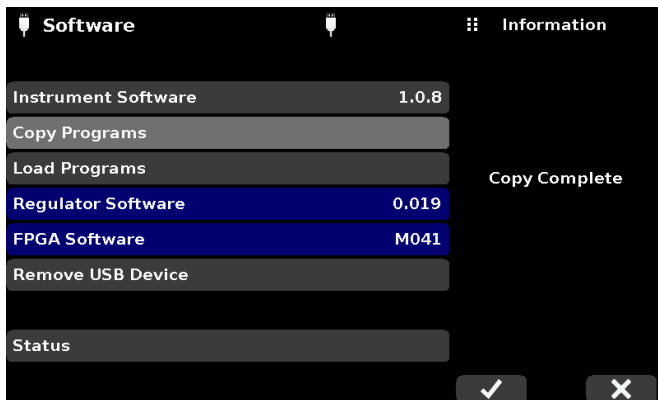

Figure 7.10-B – Copy Programs

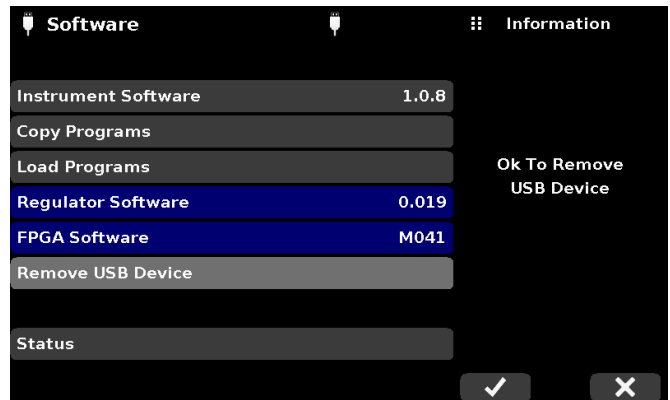

Figure 7.10-C – Remove USB Device

8 Options

- Barometric Reference Transducer (for gauge and absolute emulation)
- Additional Transducers (spare or alternate range)
- Rack Mount Kit
- Fittings
- Remote calibrations sleds (for transducers and/or barometric reference)
- Automatic Contamination Prevention System
- Contamination Prevention Accessories
- Pressure Booster

8.1 Barometric Reference (CPX-A-C4-6)

The CPC4000 can be ordered with a barometric reference transducer. It is a very stable, absolute pressure transducer used to accurately measure local atmospheric pressure. It is used to display the barometric pressure (reading appears on the bottom right side of the display) or as a barometric reference for gauge or absolute emulation.

This transducer is in a different housing compared to the regular transducers. It is removable by taking off the top cover of the chassis.

8.1.1 Gauge Pressure Emulation

In the Home Application (main screen) an absolute transducer channel will indicate “Absolute” in the Pressure Type button (this is the default mode). When the Pressure Type button is pressed the button label will toggle to “Gauge” and have a lighter background color. The lighter background color is an indication that the channel is in emulation mode.

In the gauge emulation mode the atmospheric pressure reading from the barometric reference transducer is subtracted from the absolute pressure reading to emulate a gauge pressure.

The barometric reference transducer has six significant digits. If a very low pressure gauge transducer is active and is used in absolute emulation, the combined output may appear quite noisy because of the resolution of the barometric reference.

8.1.2 Absolute Pressure Emulation

In the Home Application (main screen) a gauge transducer channel will indicate “Gauge” in the Pressure Type button (this is the default mode). When the Pressure Type button is pressed the button label will toggle to “Absolute” and have a lighter button background color. The lighter background color is an indication that the channel is in emulation mode.

In the absolute emulation mode the atmospheric pressure reading from the barometric reference transducer is added to the gauge pressure reading to emulate an absolute pressure.

8.1.3 Emulation Mode Accuracy

The accuracy in emulation mode is different for gauge and absolute emulation mode.

The barometric reference has six significant digits and has a guaranteed drift of 0.0000041 psi over a 24 hour period which has no significant effect on the emulated gauge pressure uncertainty.

The absolute uncertainty of the barometric reference must be considered in the emulated absolute pressure uncertainty.

8.1.4 Barometric Reference Calibration

The Barometric Reference Transducer can be calibrated in exactly the same manner as the other installed transducers as described in Section 10, Calibration.

8.1.5 Barometric Reference Specifications

Accuracy: 0.02% of reading. Uncertainties include all pressure effects and temperature effects over the calibrated range and calibration stability for 365 days after re-zeroing.

Pressure Range: The standard Barometric Reference Transducer is calibrated from 8 to 17 psia.

Resolution: 6 digits

8.2 Additional Transducers (CPR4000)

A secondary transducer of any standard range, can be purchased as an option. In all other regards, the add-on transducer will meet all of the specifications and operating parameters outlines throughout this manual.



Caution

CAUTION: Typically, the pressure regulator in each instrument has limits of 50, 150, 1500 or 3,045 psig. If a transducer is placed into an instrument where the transducer has a higher upper pressure range than the instrument's regulator, the maximum control limit will be limited to the maximum range of the instrument's regulator.

While any transducer will function in any instrument, the results may not always be optimum. For example, if a 1 psi transducer is placed in an instrument that has a 1500 psi upper limit, the controlled pressure stability may not be acceptable. Or if a 1500 psi transducer is placed in an instrument that has a 30 psi upper limit, it will control very well, but be limited in resolution.

8.2.1 Secondary Transducer Installation

If the add-on transducer is of a higher full scale range than the existing primary transducer, then this newer transducer becomes the Primary, and the existing transducer must be moved to the Secondary Transducer slot. For complete installation instructions see Section 9.3 , Transducer Removal.

8.3 Rack Mount Kit (CPX-A-C4-R)

A rack mount kit allows the customer to install a CPC4000 into a standard 19" instrument rack. It includes a tray and a cover panel for the front. The instrument will rest on the tray and be retained by the panel.

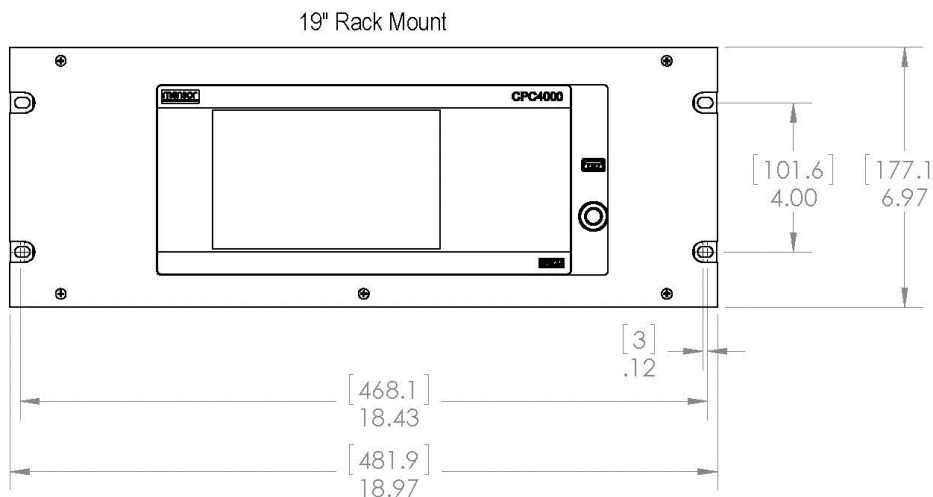

8.4 Fittings

A variety of fittings are available at the time of order on transducers with a max range of $\leq 3,060$ psi (211 bar), or the CPC4000 can be ordered without adaptor fittings. Available fittings are shown in Section 9.2 - Spare Parts. The barometric reference comes with a standard barb fitting.

8.5 Remote Calibration

A remote calibration sled, power supply, cable and software are available to calibrate the optional barometric reference and internal transducers outside of the CPC4000. In both cases a PC with an RS-232 connection is required. Both kits are supplied with an instruction manual. For instructions to remove the internal transducers and the barometric reference, see section 9.3 Transducer Removal.

8.5.1 Remote Calibration Kit for Internal Transducers (CPX-A-C4-4)

The cable / power supply used to calibrate the internal transducers remotely can be ordered as an option (pn # 0019095001). Calibration of each internal transducer can be performed remotely using the cable, a PC, and software provided.



Figure 8.5.1 – Remote Calibration Kit for Internal Transducer

8.5.2 Barometric Reference Calibration Sled (CPX-A-C4-5)

The CPC4000 Calibration Sled Kit is available to provide a way to calibrate the barometric reference remotely. Calibration of the Barometric Reference can be performed remotely using the Cal sled, a PC and the software provided.



Figure 8.5.2 – CPC4000 Barometric Reference Cal Sled Kit

8.5.3 External Calibration Procedures

To calibrate the internal transducers or the barometric reference remotely, use the same setup described in section 10 of this manual. The only difference is that the interface with the transducer is through the software provided and a PC, not directly through the instrument.

8.6 Automatic Contamination Prevention System

The Automatic Contamination Prevention System (Automatic CPS) is connected between the device under test and the Measure/ Control port of the instrument by the backplate located on the rear panel (Figure 8.6-B). The primary function of the Automatic CPS is to prevent liquid and particulate contaminants from entering into the instrument. The Automatic CPS (Figure 8.6-A) is designed to interface with the CPC4000 and is energized to purge the device under test of any contaminants by an automated purge sequence within the CPC4000 user interface.



Figure 8.6-A - Automatic Contamination Prevention System



Automatic CPS Backplate

Figure 8.6-B - Rear Panel with Automatic CPS Backplate



Notice

The system should only be operated by trained personnel who are familiar with this manual and the operation of the instrument.



Warning

Warning! The pressure connections must be installed according to the following instructions, observing the relevant regulations. The installation is to be performed by trained, authorized personnel, knowledgeable in the safety regulations for working on pneumatic/hydraulic systems



Wear safety goggles when using and/ or servicing the Automatic CPS to protect eyes from flying particles and liquid splashes



Warning

Warning! The Automatic CPS should only be used to decontaminate the system for liquid or particulate contaminants that are non reactive, non corrosive and non explosive.

8.6.1 Automatic CPS Installation

The Automatic CPS can be mounted either in a wall/ rack mount configuration by the keyholes (Figure 8.6.1-A) on either or both side of the accessory or placed on a steady surface as a desktop accessory.

The DUT can be mounted either on top of the accessory for convenient test stand setup or on the back of the accessory for connection with a pressure hose (Figure 8.6.1-B). The not connected port should be sealed by the plug provided to ensure no leakage.

The pressure connection to the Measure/ Control port of the CPC4000 is established by a pressure tube with 7/16" SAE adapters. The Automatic CPS is powered by the CPC4000 using a 3 meter long flexible cable which connects to the Automatic CPS Backplate on the instrument.

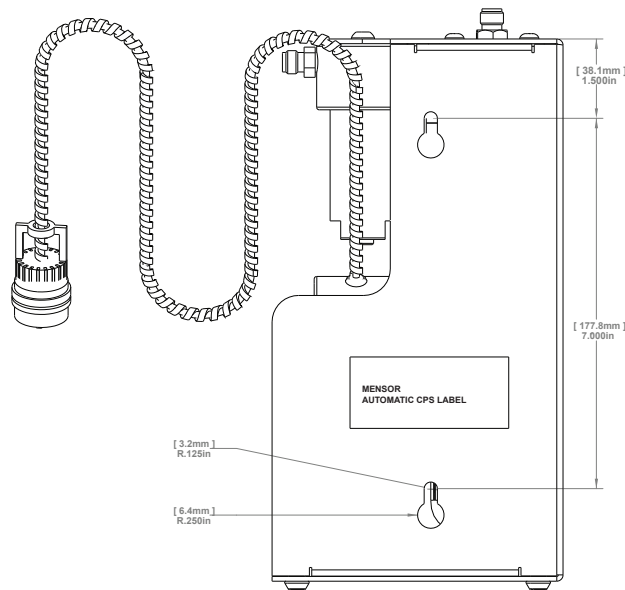

Figure 8.6.1-A - Side view of Automatic CPS with mounting keyholes

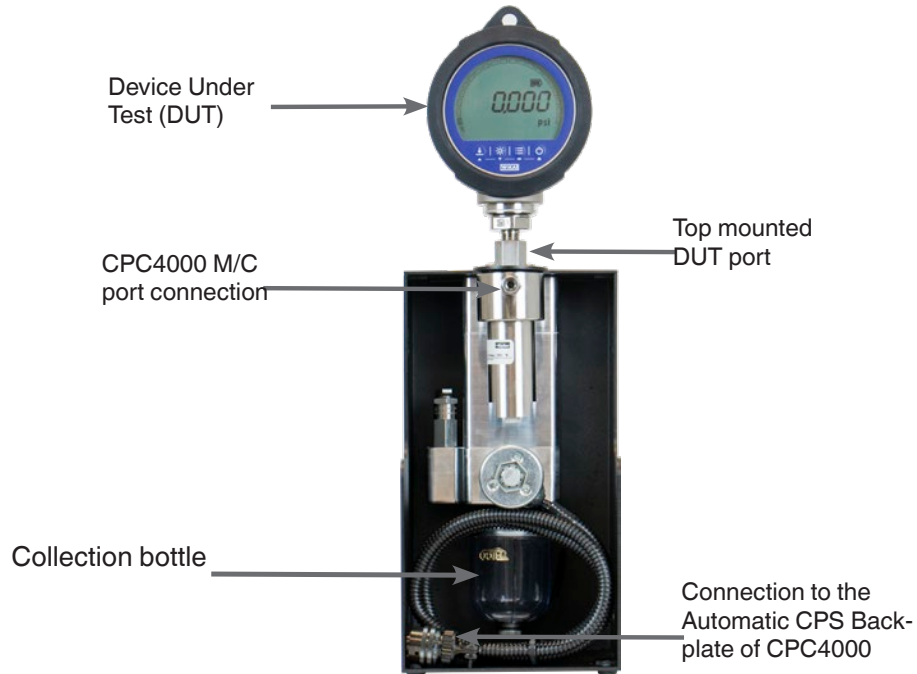

Figure 8.6.1-B - Top mounted DUT

8.6.2 Automatic CPS Specification

8.6.2.1 Technical Specification

Operating Conditions	
Maximum operating pressure	3,065 psig (211 bar gauge)
Maximum operating temperature	80 °C (176 F)
Voltage Supply	
Power supply	12 VDC
Power consumption	13 VA
Pressure Connection	
To the M/C port of CPC6050	1 port with 1/4" tube adapted to 7/16" - 20 F SAE
To the DUT	2 ports with Standard: 7/16" - 20 F SAE Option: 6 mm tube fitting, 1/4" tube fitting, 1/4" female NPT fittings, 1/8" female NPT fittings or 1/8" female BSP fittings
Dimensions & Weight	
Dimensions	5.5 in x 10.5 in x 5.5 in (W x H x D)
Weight	3.99 kg (8.8 lbs)

Industrial Pressure Controller CPC4000

8.6.2.2 Dimensions [mm]/in

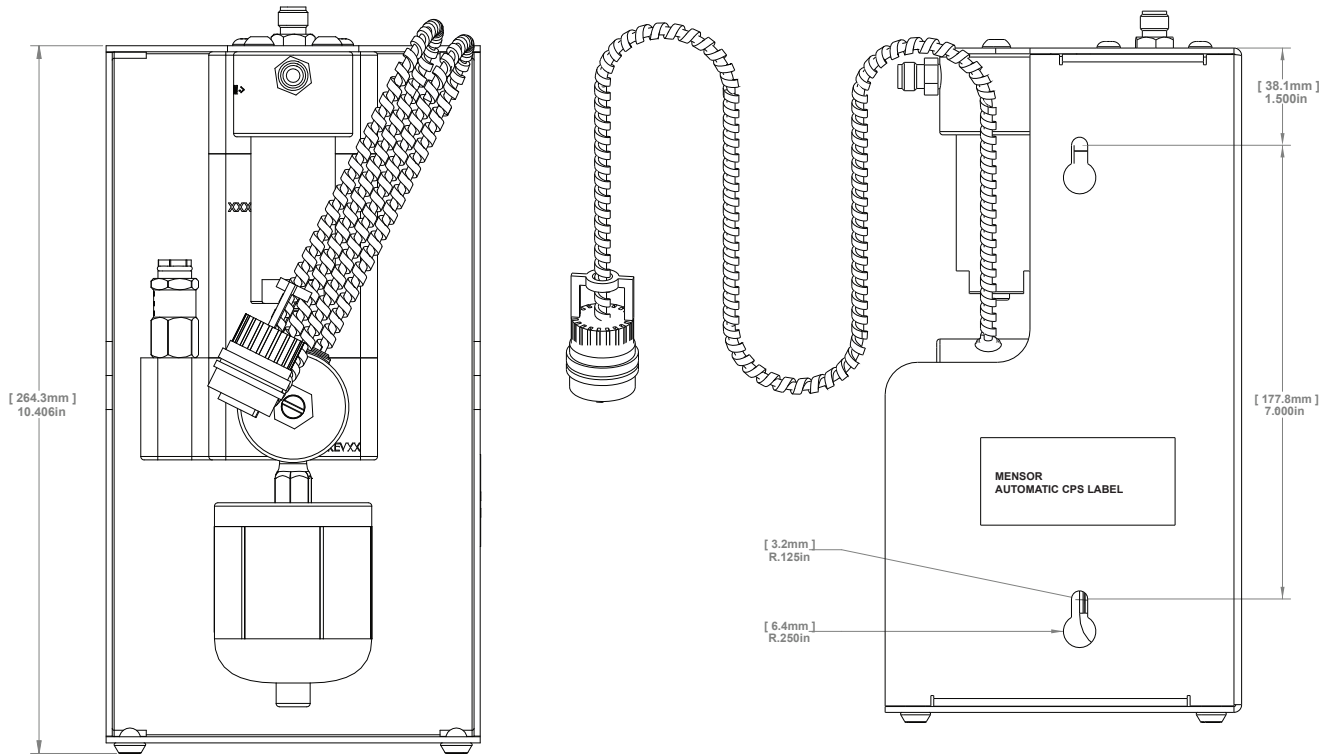

Figure 8.6.2.2-A - Front & side view

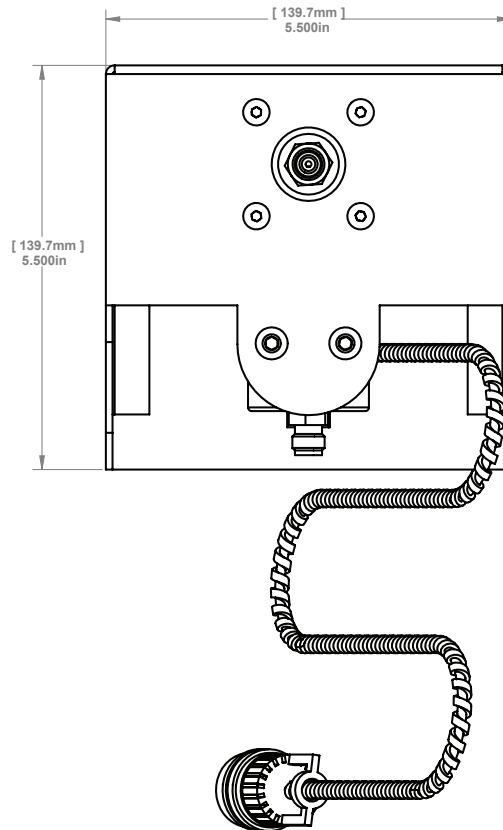

Figure 8.6.2.2-B - Top view

8.6.3 Automatic CPS Operation

The Automatic CPS is operated by the CPC4000 by a software purge sequence. The purge button for each channel is visible on the home screen (Figure 8.6.3-A) after the installation of the Automatic CPS.



Figure 8.6.3-A - Home screen with Purge button

The Automatic CPS can be set to OFF, MANUAL or AUTO by navigating to the Control Settings app and selecting the desired option for Contamination Prevention System (Figure 8.6.3-B).

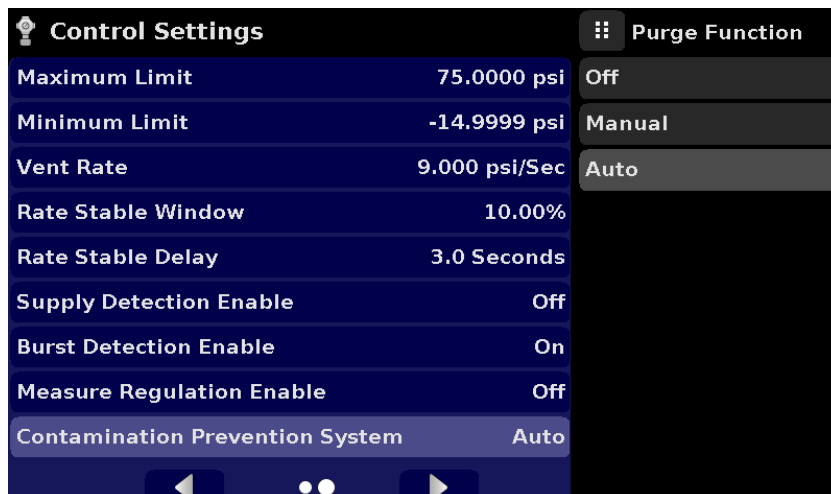

Figure 8.6.3-B - Contamination Prevention System

When in manual or auto mode, the purge valve will be opened whenever switching to vent mode while at a positive pressure (above atmosphere). In manual mode, the internal purge sequence can be run by the Purge button on the Home screen. When in auto mode, the purge sequence will be required to be run when switching to control mode after a vent has occurred.

The purge sequence will require a DUT pressure to be entered by clicking the Purge button [] and entering a value using the digital keyboard (Figure 8.6.3-C). This will initiate the process of controlling close to that pressure then isolating the instrument by closing the measure/control valve, then opening the purge valve. This process will occur 4 times to ensure all contaminants are cleared from the system.



Figure 8.6.3-C - DUT pressure for purge sequence



Warning

Caution! If the Automatic Contamination Prevention System is operated in Manual mode, there is a risk of the solenoid valves to heat if the system is kept on for more than a few seconds



Notice

The collection bottle should be periodically inspected for liquid contaminants and purged through the plug at the bottom



Warning

Warning! The Automatic CPS should be turned off and allowed to cool down for 15 minutes before any cleaning or maintenance procedure is performed

8.7 Contamination Prevention Accessories

The contamination prevention accessories allow the user to operate the CPC4000 in contamination prone areas. These accessories prevent contaminants like oil or dirt from entering into the instrument. These filters, when connected to the Measure/Control Port at the rear of the instrument, prevent any liquids to enter the controller when the direction of pressure flow is from device under test (DUT) to the controller or when the device under test is vented.

8.7.1 Coalescing Filter (CPX-A-C4-9)

The coalescing filter is connected between the device under test and the Measure/ Control port. It has a 99.7% coalescing grade efficiency and clears contaminants up to 0.01 microns.

8.7.2 Block and Bleed Valve (CPX-A-C4-8)

The block and bleed valve is used to purge the liquid from the device under test. It is a three-way valve which blocks the instrument from being contaminated while bleeding the liquid out of the device under test. An initial bleeding of the contaminants in the system can be done by the following procedure

- Before connecting the DUT to the system, remove as much liquid as possible from the DUT.
- With the controller power off and both the block and bleed valve closed, connect the system as shown below.
- Use the controller to apply a pressure close to the full scale pressure of the DUT.
- Open the block valve slowly to pressurize the DUT. (note: the gas will flow in the direction of the controller to the DUT: high pressure to low pressure).
- After the system is pressurized close the block valve.
- Open the bleed valve and purge the system to atmospheric pressure. Observe the sump to see if any liquid is purged.
- Close the bleed valve.
- Repeat steps 3 to 7 until no more liquid is observed coming out of the system.
- With the block and the bleed valves securely closed, vent the controller.

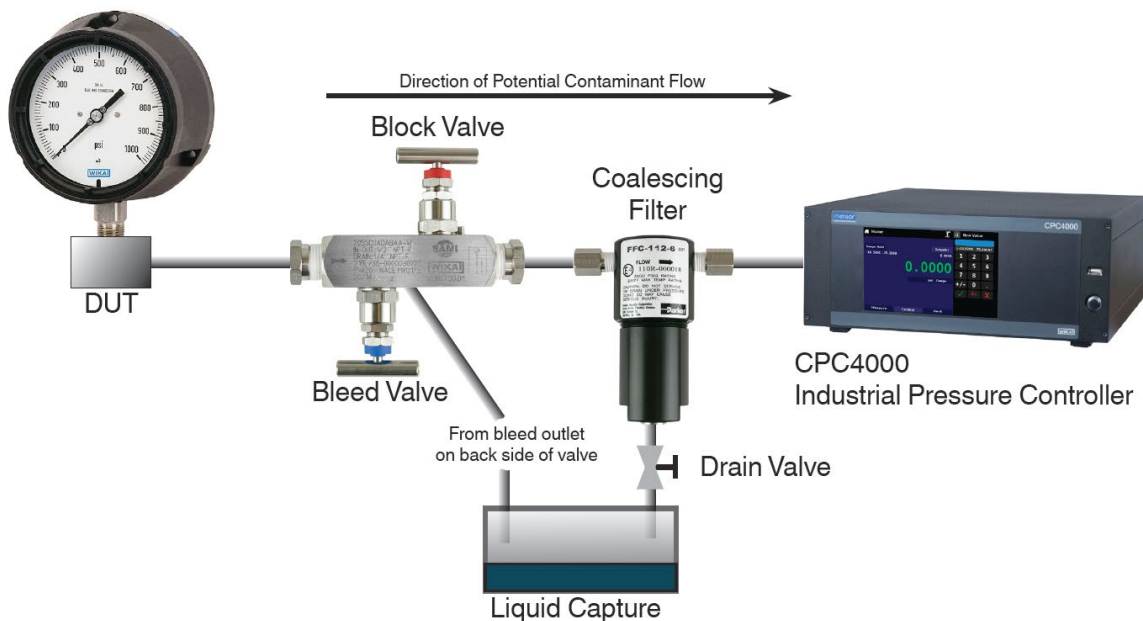

Figure 8.6.2 – Contamination prevention accessories

8.8 Pressure Booster

To control pressure, the CPC4000 requires a pressure supply of 10% above the full scale of the instrument. The Model 75 Pressure Booster System provides the ability to boost bottle pressure up to the supply pressure requirements of all possible CPC4000 range configurations while maximizing gas bottle/cylinder usage.

The Model 75 is a single piston air driven gas booster mounted in a heavy duty roll bar frame. The unit includes an operator control panel with gauges for supply pressure, output reference pressure and an output vent valve. The system requires shop air to drive the booster and a minimum of 300 psi to 3000 maximum inlet pressure (clean dry air or Nitrogen).

Table 8.7 – Specifications for Input Supply Pressure and Output Pressure

Input Supply Pressure	Minimum: 300 psi Maximum: 3000 psi Media: Clean Dry Inert Gas (Nitrogen preferred)
Output Pressure	6500 psi typical 7000 psi relief valve setting

Please refer to the Model 75 data sheet (CDS075) for additional information and specifications, available on our website at www.mensor.com.

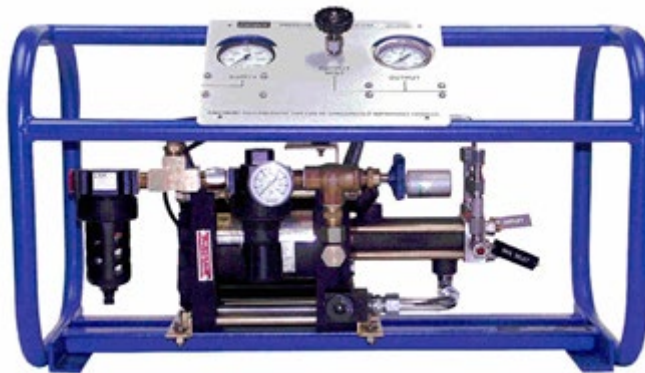

Figure 8.7 – Model 75 Pressure booster

9 Maintenance

The CPC4000 was designed for maintenance-free operation. User maintenance is not recommended, beyond replacement of parts listed in Table 9.2. If you have questions not covered by this manual, call 1-800-984-4200 (USA only), or 1-512-396-4200 for assistance, or send an email to tech.support@mentor.com.

9.1 Beyond the Warranty

Take advantage of Mentor’s expert product care. Mentor provides complete maintenance and calibration services, available for a nominal fee. Our service staff is knowledgeable in the innermost details of all of our instruments. We maintain units that are in operation in many different industries and in a variety of applications, and by users with a wide range of requirements. Many of these instruments have been in service for over twenty years, and continue to produce excellent results. Returning your instrument to Mentor for service benefits you in several ways:

- Our extensive knowledge of the instrument assures you that it will receive expert care.
- In many cases we can economically upgrade an older instrument to the latest improvements.
- Servicing our own instruments which are used in “real world” applications keeps us informed as to the most frequent services required. We use this knowledge in our continuing effort to design better and more robust instruments.

9.2 Spare Parts

Table 9.2 lists the spare parts for the CPC4000 that can be ordered from Mentor.

Table 9.2 – Spare Parts List

Part Description	Part Number
Adaptor Fittings	Pressure ≤ 3000 psi
6mm tube fittings (brass)	0018203043
1/4” tube fittings (brass)	0018203045
1/4” NPT female pipe thread (brass)	0018203005
1/8” NPT female pipe thread (brass)	0018203001
1/8 FBSPG female pipe thread (brass)	0018203018
Kits/Manual	Part Number
Kit - Rack Mount adapter	0019065001
Manual	0019008001

9.3 Transducer Removal

Follow the following instructions for transducer removal or replacement:

- VENT THE SYSTEM by placing the controller in vent mode. Then turn off the power.
- Loosen the five Phillips screws on the top cover of the instrument (Figure 9.3-A), and open the top cover to reveal the insides of the chassis (Figure 3.5).
- Unscrew the thumb screw holding in the transducer (Figure 9.3-B).
- Apply a light inward pressure against the bottom of the transducer case, just below the range label, while tilting the case upward to clear the clamp plate and screw head.
- Pull the transducer module outward, through the top opening.



Caution

CAUTION: There must be a transducer installed in the “Primary Transducer” slot for the system to function properly. If the system is operated with the primary slot empty the system will display an error.



Figure 9.3-A – Top view of CPC4000



Figure 9.3-B – Transducer module

To return the transducer module, or a replacement module to the system, slide it firmly back into position to engage the pneumatic passages with those in the manifold and tighten the thumb screw on the transducer module. Then tighten the five Phillips screws to put the top cover back in position.

In replacing the transducer modules the order of position must be maintained according to the pressure limit of each module, starting with the highest transducer on the left (Primary transducer) and the lower pressure transducer (Secondary transducer) on the right. If an optional Barometric Reference is present it is positioned to the left of the Primary transducer.



Caution

CAUTION: Further access to the interior of the instrument is **NOT** recommended. There are no user-serviceable plumbing or parts inside. In addition to the dangerous voltages present (line voltage), there are circuits sensitive to electrostatic discharge damage.



ESD PROTECTION REQUIRED! The proper use of grounded work surfaces and personal wrist straps are required when coming into contact with exposed circuits (printed circuit boards) to prevent static discharge damage to sensitive electronic components.



Warning

WARNING! If faults cannot be corrected locally, immediately take the system off line and protect it from unintentional restarts. Contact Mensor Customer Service for further instructions. Apparent problems are frequently resolved over the telephone by our staff.

Do not risk voiding the warranty. Higher level repairs must be carried out exclusively by Mensor authorized personnel, or under Mensor supervision.

Servicing of electrical, electronic or pneumatic equipment must be performed by qualified and authorized technical staff, observing all relevant safety regulations.

9.3.2.1 Barometric Reference Removal

To remove the optional Barometric reference, first turn off the CPC4000 and loosen the Phillips head screws to remove top cover of the chassis. The barometric reference can be removed by removing the attached ribbon cable, loosening the thumb screw, and lifting the barometric reference out of the chassis.

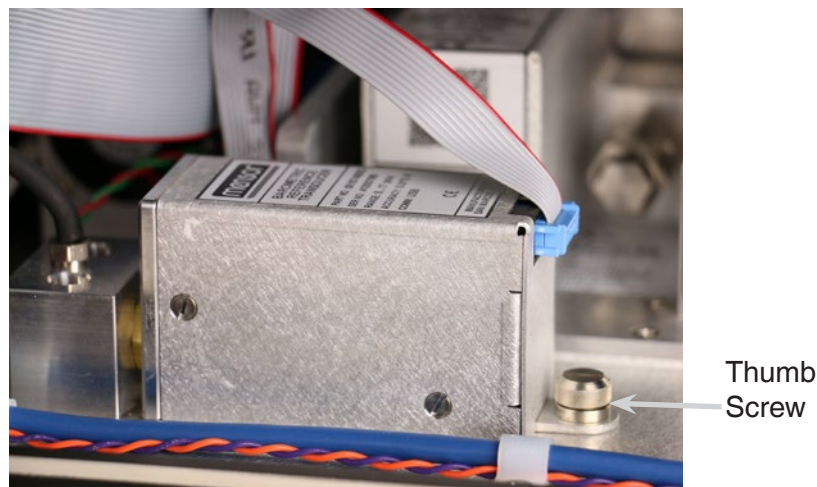



Figure 9.3.2.1 - Internal Barometric Reference

Table 9.3 – Troubleshooting

Type	Problem	Correction Action
1	The system has been switched on and no measurement(s) have appeared and the entire area of the screen is white (or dark).	Switch the system off. Wait 5 seconds and switch the system on.
2	The screen is dark and the corrective action for #1 above has no effect	Check that the power cable is connected properly and have authorized technical staff check that the supply voltage is correct.
3	The screen is dark and the action taken to solve the problem of #2 above has no effect.	Unplug the unit from the power source (wall socket), then remove the power cord from the instrument. The power cord input socket includes two internal fuses. Check both fuses for continuity.
		 <p>WARNING! When needed, use only 1.25 amp 250V SLO-BLO 5x20 Fuse</p> <p>Warning</p>
4	Malfunction during operation.	Switch the system off. Wait 5 seconds and switch the system on.
5	Unstable control.	Consult factory
6	The setpoint value is not reached.	Check whether the value of the supply pressure is the value required, and leak test the plumbing.

If you need help or assistance, contact Mensor at

Phone: 1-512-396-4200 or 1-800-984-4200 (USA only)

Fax: 512-396-1820

Website: www.mensor.com

Email: sales@mensor.com

tech.support@mensor.com

10 Calibration

The CPC4000 automatically adjusts the pressure reading for the effects of temperature and non-linearity within the calibrated temperature range of 15-45°C. The process is referred to as dynamic compensation because each reading is so adjusted before it is output to the display or to a communication bus. Thus, a calibrated CPC4000 operated within its temperature band, and with proper zero and span adjustments, will provide accurate pressure measurements.

The CPC4000 should have the calibration verified periodically to ensure stability. The recommended calibration interval for this instrument is given in the Specifications section under “Calibration Interval” in Section 4.1.

10.1 Calibration Services by Mensor or WIKA worldwide

Mensor and WIKA worldwide have extensive experience and knowledge of Mensor products. Calibration of the transducers in these products can be performed at the addresses below or by competent internal or external labs using the procedures in this section.

Service Center USA	Service Center Europe
Mensor website: www.mensor.com tel: 1-512-396-4200 1-800-984-4200 fax: 1-512-396-1820 email: tech.support@mensor.com	WIKA Alexander Wiegand SE & Co. KG website: www.wika.de / www.wika.com tel: (+49) 9372 132-0 fax: (+49) 9372 132-406 email: CTServiceTeam@wika.com
Service Center China	
WIKA China website: www.wika.cn contact: Baggio Li tel: (+86) 512 6878 8000 fax: (+86) 512 6809 2321 email: baggio.li@wika.com	

10.2 Environment

For maximum accuracy, allow the CPC4000 to warm up a minimum of 15 minutes in ambient temperature within the compensated range prior to a calibration. In addition, the instrument should be at rest on a stable platform that is free of excessive vibration and shock.

10.3 Pressure Standards

Mensor recommends the use of appropriately accurate primary pressure standards when calibrating this instrument. Such standards should be sufficient so that when the techniques of the ISO Guide to the Expression of Uncertainty in Measurement (GUM) are applied, the instrument meets its accuracy statements as required by ISO/IEC 17025:2005, or other applicable standards.

10.4 Media

The recommended calibration medium is dry nitrogen or clean dry instrument air. A height variation between the standard and the CPC4000 can cause significant errors. A calculation should be made to compensate for this difference. This compensation can be done in Section 10.10 - Head Pressure.

10.5 Setup

The following illustration for calibration setup shows a typical setup for either local or remote calibration for an absolute or gauge pressure instrument. The PC is required only for performing a remote calibration. The “Pressure Standard” is normally a deadweight test instrument, and the “Volume Controller” refers to a hand operated variable-volume pressure vernier device. A diaphragm type vacuum gauge is recommended over the gauge tube type of vacuum sensor for calibrating sub-atmospheric pressures. A vacuum pump with the capacity to generate 600 mTorr absolute is recommended.

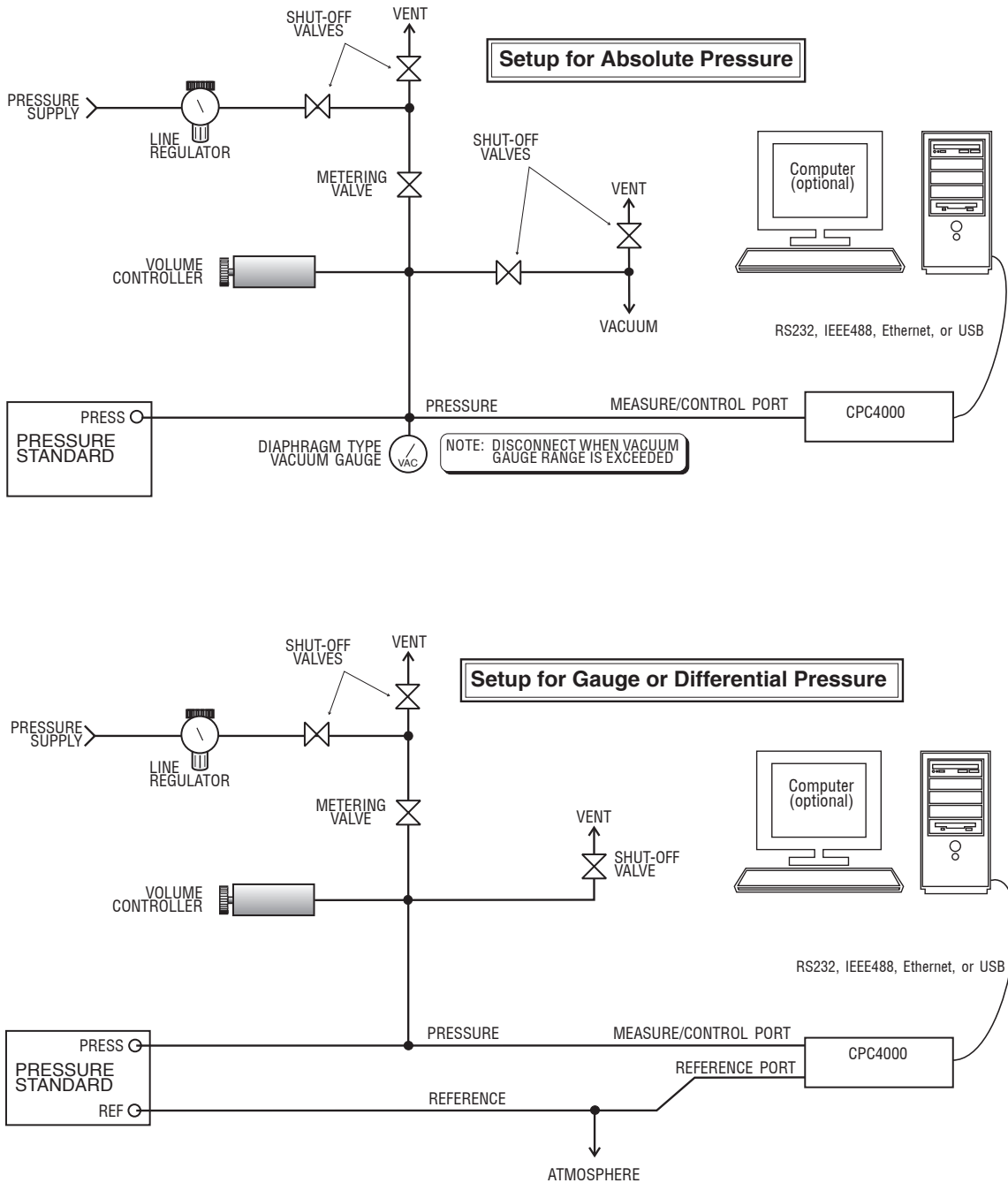



Figure 10.5 – Calibration Setup

10.6 Calibration Data

The Calibration Data Application is where the calibration data for each transducer is stored and amended. The Serial number (S/N), Zero offset (Zero) and Span offset (Span) can be seen in this screen. The date of calibration, the calibration interval and the certificate number can be entered by pressing the corresponding button, then saved by pressing the Check [] button. To revert back to the factory calibration, press the “Restore Factory Cal” button. To view the calibration data for each transducer press the “Channel” button at the top and choose a transducer from the resulting channel selection menu.

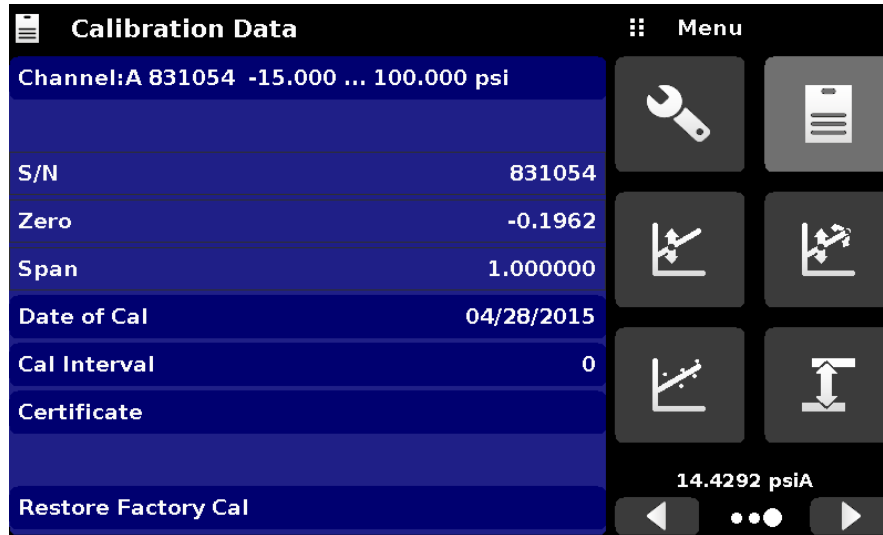
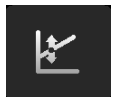
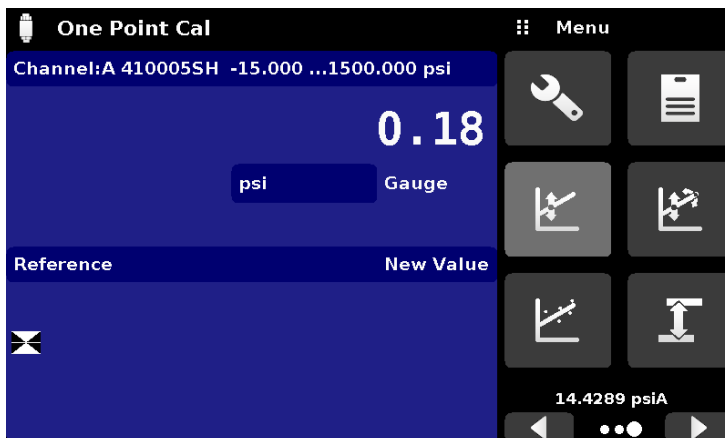

Figure 10.6 – Calibration Data

10.7 One Point Cal Application



A single point calibration (usually a zero point calibration) of each transducer installed can be accomplished in “One Point Cal” Application. The transducer channel is chosen by pressing the “Channel” button at the top of this screen, and then selecting from the list of installed transducer channels. For gauge pressure simply expose the reference and the Measure/Control port of the CPC4000 to atmospheric pressure and then press the “New Value” button and enter zero (0) using the keypad. For an absolute transducer apply a known reference pressure between 600 mTorr absolute and 20% of the active transducer’s span to the Measure/Control port of the CPC4000, press the “New Value” button and then enter the reference pressure (known true pressure) using the keypad. If you want to save the value in the transducer, press Save.



Notice the reference symbol [], this is a reference indication giving a constant reference point for the level of the internal transducer.

Figure 10.7 – One Point Cal Application

10.8 Two Point Cal Application



The Two Point Cal Application provides a place to adjust the Transducer Zero and Span (sometimes referred to as the offset and slope).

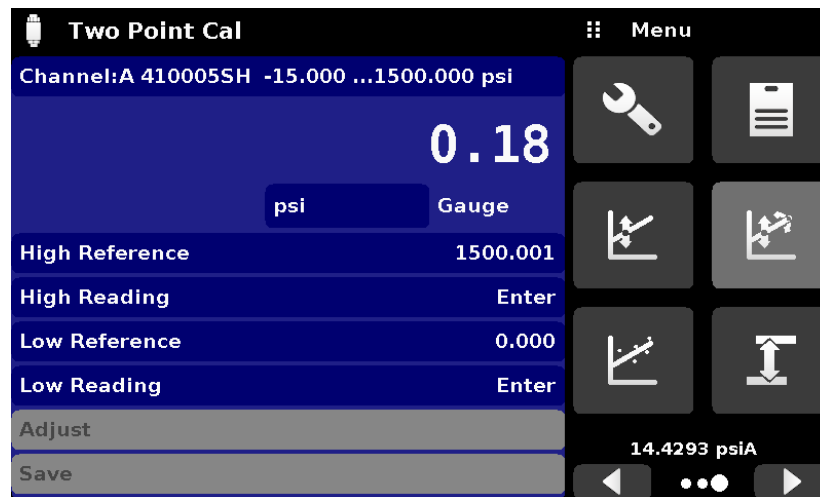

Figure 10.8 – Two Point Cal Application

Follow the steps below for a complete 2 Point Calibration:

Select a Transducer to calibrate by pressing the Channel button at the top of the screen.

To calibrate the “Low Point”:

1. The Measure/Control port of the CPC4000 being calibrated should be supplied with a suitable, “low point” pressure (see section 5.4 Rear Panel for the port location).
2. For a gauge transducer(s), this low point pressure can be achieved by opening the Measure/Control and reference ports to atmospheric pressure.
3. For an absolute transducer(s) a suitable source of vacuum should be applied to the Measure/Control port along with a high accuracy vacuum standard or a pressure calibration standard can be connected to the Measure/Control port that can generate and measure a stable pressure value between 600 mTorr absolute and 20% of the active transducer’s span.
4. When the pressure is stable, record the live reading shown on the Two Point Cal screen and enter this value as the “Low Reading” by pressing the Low Reading button and entering the number followed by the check mark []. Record the “true pressure” obtained from the reference standard and enter it as the “Low Reference” value in the same manner.

To calibrate the "High Point":

5. The "High Point" Calibration is done in a similar way as the "Low Point".
6. Supply a pressure to the Measure/Control Port of the CPC4000 being calibrated, using a pressure standard. This pressure should be as close as possible to the full scale value of the selected transducer or at least within 20% of the active transducer's span.
7. After the pressure stabilizes, record live reading shown on the Two Point Cal screen and enter this value as the "High Reading" by pressing the High Reading button and entering the number followed by the check mark []. Record the "true pressure" obtained from the reference standard and enter it as the "High Reference" value in the same manner.
8. After all four values (High Reference, High Reading, Low reference, & Low reading) have been entered, the Adjust button will become active. Press the Adjust button to check and accept the calibration data then press the Save button. The instrument will then prompt with the question "Save Cal Data?". Pressing the check mark [] in this screen will save the calibration to the memory of the transducer.

10.9 Linearization



The Linearize Application provides a place to record upscale and downscale calibration data and to linearize each transducer using that data. An "as found calibration" can be performed by connecting a suitable pressure standard to the Measure/Control port of the CPC4000 being calibrated, and supplying between 3 and 11 pressure points across the complete range. The pressure points may be entered using both upscale and downscale pressure points, or only one direction. The record of the pressures from the pressure standard and the corresponding reading from the instrument's transducer can be recorded and transcribed into the Linearization Matrix shown in Figure 10.9-A. Linearization of each transducer can be performed from this screen by selecting each transducer range from the setup screen.

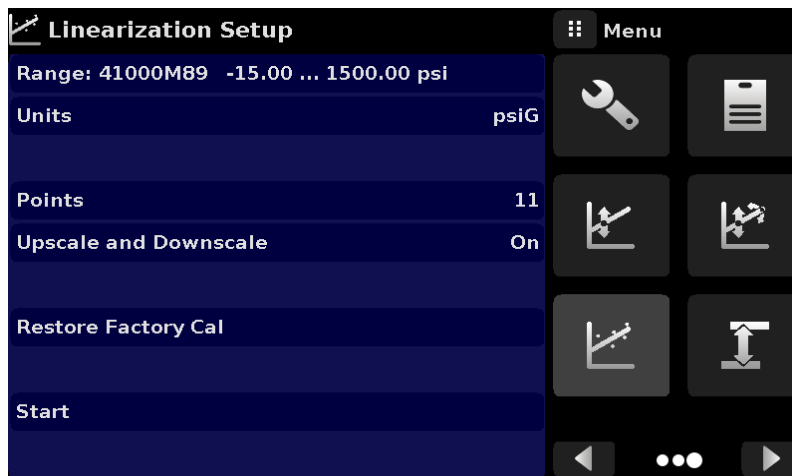

Figure 10.9-A – Linearization Application Data Matrix

The Linearization Application automatically populates the screen with equidistant increments from the low to high pressure corresponding to the range of the transducer selected. These values can be changed to reflect the values generated by the reference standard and the corresponding readings taken from the CPC6050. Each value from the reference standard can be entered under the reference column, corresponding Upscale and Downscale readings from the instrument can be entered in the "Actual" column or "Upscale" and "Downscale" columns. To enter a value simply press the number and a key pad will appear (see Figure 10.9-B) where the number can be entered. Press the check mark [] to accept each value. With upscale and downscale on, the "Average" column automatically averages the upscale

and downscale values.

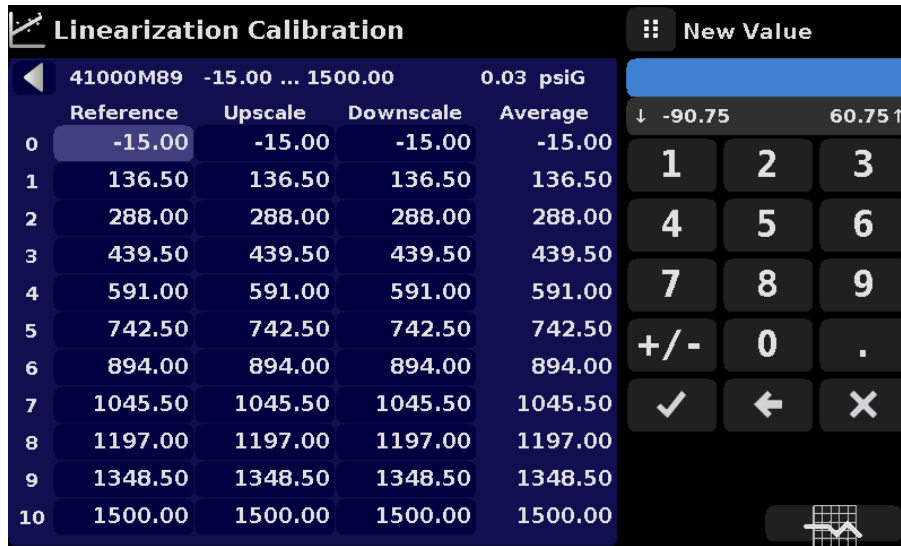



Figure 10.9-B – Linearization Values

Figure 10.9-B shows some typical values that might be seen in a linearization calibration. In the bottom right hand corner of this screen is the Graph Icon [] that, when pressed, reveals a Linearization Error Graph that gives a visual representation of the errors associated with the values entered in the Linearization screen.

This Linearization error graph shows a scaling that corresponds to the maximum error calculated from the data entered in the Linearization Matrix. It is a good indication of the overall error of the transducer, and will quickly reveal any gross data entry errors that have been made. To revert back to the Linearization Matrix press the Matrix Icon [].

When satisfied that all values have been entered correctly, press the adjust button and then the save button to save the new calibration data in the transducer memory.



Note: After calibration is complete, return to the Calibration Data Application (Section 10.6) to record the certificate number, calibration interval and the date of calibration. Restoration to factory calibration can also be completed in this application.

10.10 Head Pressure



The Head Pressure Application provides an automated way to calculate the head pressure offset between a device being tested and the CPC4000 transducer, based on:

- Height: the difference between the device under test and the sensing element in the transducers in the CPC4000
(Difference = DUT - CPC4000)
As an example, if the device under test (DUT) is 10 inches above the CPC4000, enter +10 in “Height” button.
- Gas Density: the media density of the pressure media
- Gas Temperature
- Local Gravity

The Head Pressure application is placed under the password protected area of the operator interface to safeguard against inadvertent activation. It is intended to be used to accurately measure the pressure at an external source that is at a different elevation from the CPC4000 transducer sensing that pressure.

The four parameters are used to calculate the pressure that is a result of the different elevations. It should not be used when calibrating CPC4000 transducers. The Head height should be set at zero before calibrating the transducers of the CPC4000.



Notice

The Head Pressure should not be active when calibrating CPC4000 transducers. The Head height should be set at zero before calibrating the transducers of the CPC4000. Difference in height between the laboratory standard and the CPC4000 during calibration should be factored into the uncertainty analysis.

Figure 10.10 shows the Head Pressure screen. The height, gas density (Nitrogen or dry air), gas temperature and local gravity can be entered here based on the specific setup of the system.

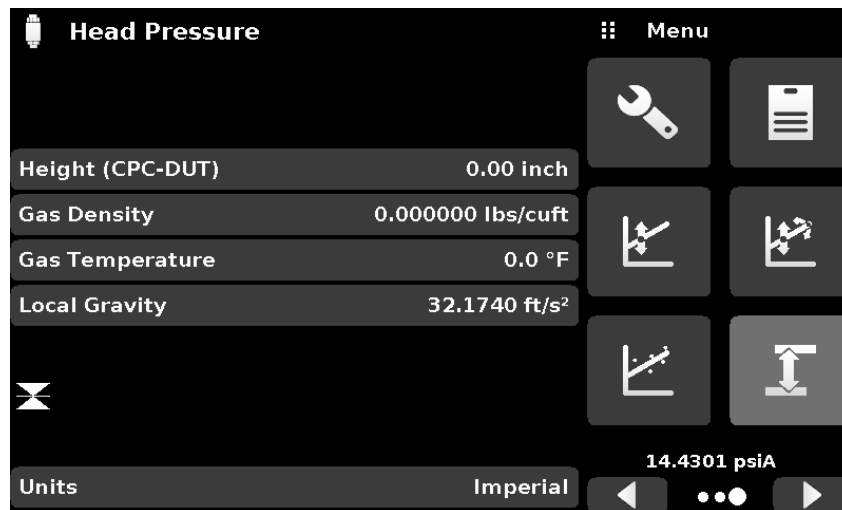



Figure 10.10 – Head Pressure, Pneumatic

11 Technical Assistance

The Technical Assistance menu provides access to additional menus that assist in troubleshooting of the CPC4000. The menu allows access to enable/ disable software options, perform real time pressure logging, touchscreen calibration and instrument usage information.

11.1 Options

 The Options Application lists some of the software options that can be enabled on the CPC4000: Some of the software options require a hardware upgrade to the instrument and would be not active if enabled without the hardware. Figure 11.1-A shows the Options screen.

Each option can be individually turned on/ off by clicking on the option line and selecting “ON/ OFF” from the drop down menu. The current state of each option can be seen on the right side of each option line.

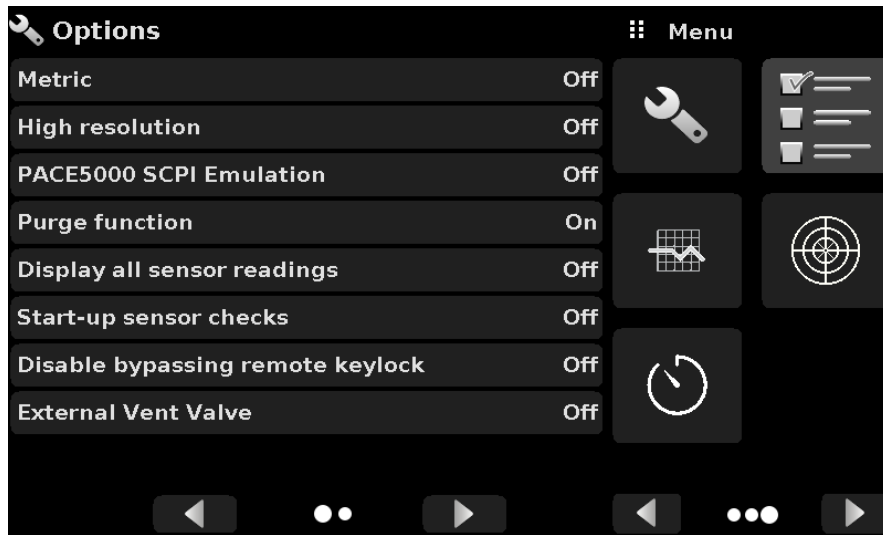

Figure 11.1-A Software Options

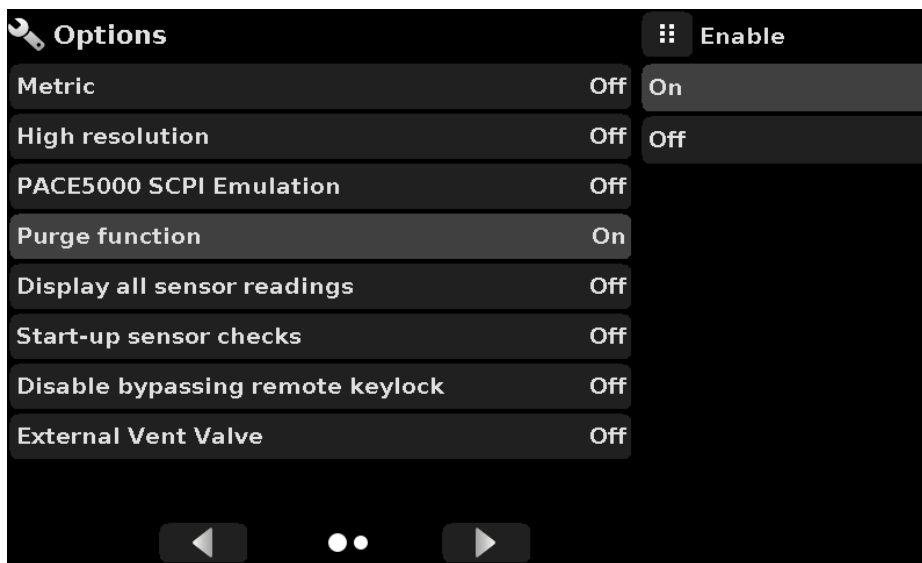

Figure 11.1-B Option On/Off

Following is the list of options and their descriptions:

- Metric: this option changes the barometric pressure reading to show the standard metric value
- High resolution: this option changes the displayed resolution of current pressure reading to 7 significant digits
- PACE5000 SCPI Emulation: this option allows the selection of SCPI GE command set in the Remote Communication App (Section 6.4.9)
- Purge function: this option enables/ disables the Purge function which drives the Automatic Contamination Prevention System.



WARNING! It is not recommended to activate other software options without consulting with WIKA/ Mensor Service Centers (Section 10.1)

11.2 Logging



The Logging Application enables real-time storage of current instrument output and state in a USB device plugged to the front panel of the CPC4000. The application also provides a means to log any remote communication (commands and responses) to the instrument. The primary objective of this application is to provide test data for troubleshooting purposes.



Note: The Logging Application is only visible when a compatible USB device is plugged to the front panel of the CPC4000. The Application is greyed out in the absence of a USB device.

Figure 11.2.-A shows the Logging App with and without a USB.

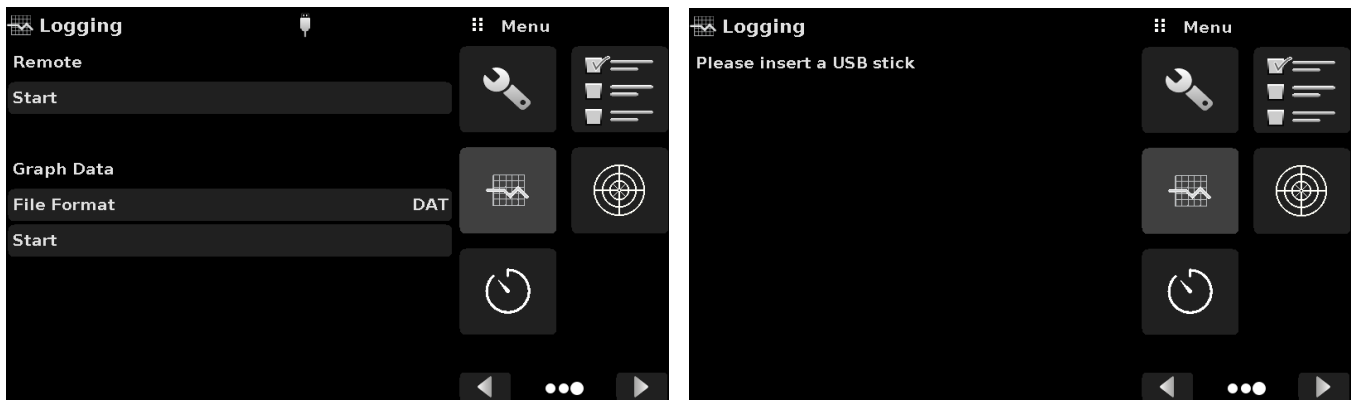



Figure 11.2-A Logging App with USB (left) and without USB (right)

11.2.1 Remote Logging

The queries and responses sent over the remote communication can be logged on to the USB device using the remote logging feature. This feature allows monitoring communication and any erroneous responses from the instrument. The logging can be started by pressing the “Start” line, this would bring a keypad on the screen (Figure 11.2.1) for entering the file name to store the logging data. The extension of this file

is set to “.txt” by default. Click [] to exit the keypad. This will automatically generate the file on the USB device and start logging the remote commands. The log function continues to run in the background while the instrument is operated locally or remotely. To stop logging, press the “Stop” line.

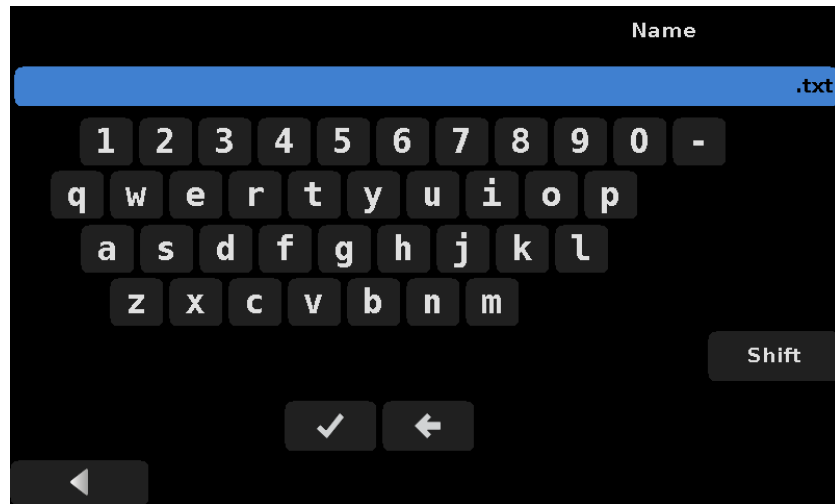



Figure 11.2.1 File Name Keypad

11.2.2 Pressure Logging

The Logging App allows the storage of the time interval, active pressure reading, stable window and stable flag status to a file. The “File format” button under Graph Data section gives the option of selecting “.DAT” or “.CSV” file type (Figure 11.2.2). The logging is started by pressing the “Start” line, entering a file name on the alpha numeric keypad and clicking []. The values are continuously written to the file until “Stop” line is pressed.

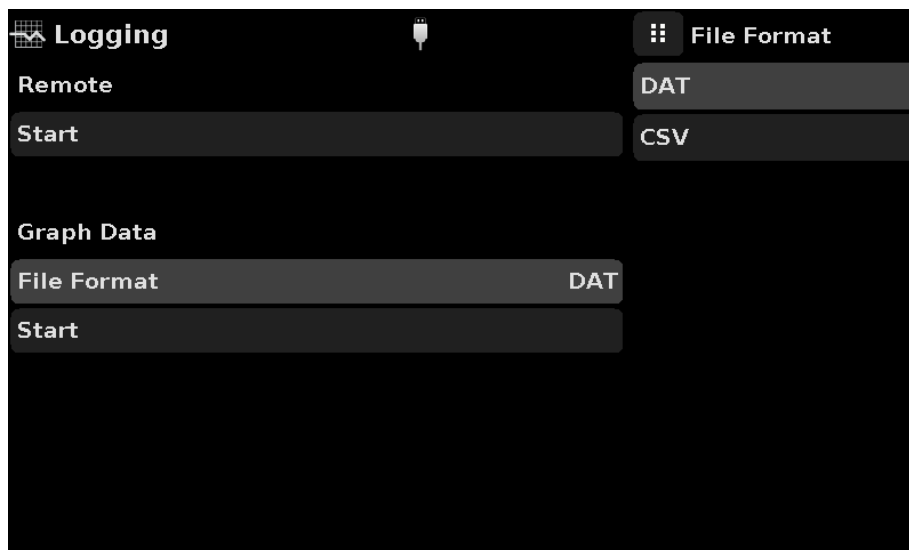

Figure 11.2.2 Data Log File Format

11.3 Touchscreen Calibration



The Touchscreen Calibration App is used to perform re-calibration and adjustment of the touchscreen by aligning it with the display behind the screen. This is done by guiding the user to up to three points on the screen. The touchscreen calibration can be started by pressing [] on the right side of the screen (Figure 11.3-A). During the calibration, the CPC4000 would prompt and guide the user to press different target points on the screen (Figure 11.3-B). After successfully completing the calibration, the user is directed back to the Technical Assistance menu.



Figure 11.3-A - Touchscreen Prompt

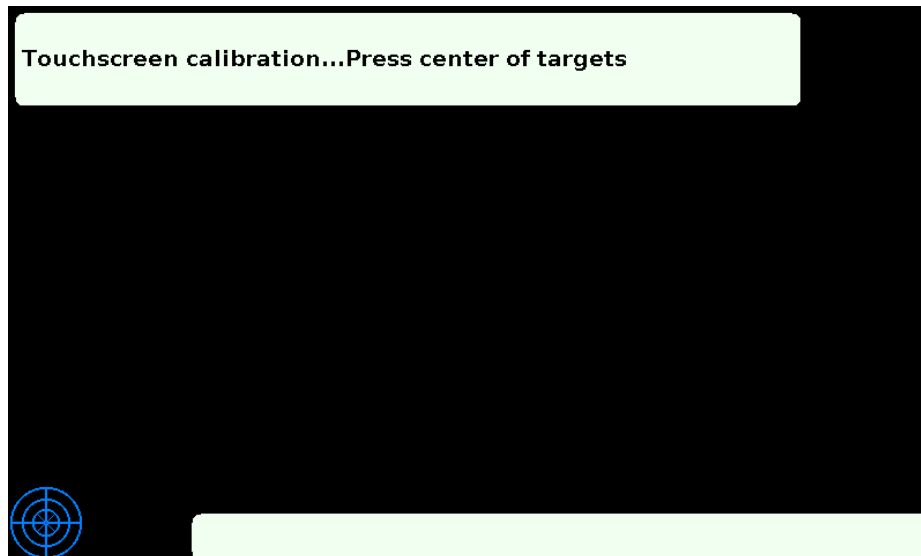

Figure 11.3-B Touchscreen calibration in progress

11.4 Usage



The Usage Application gives the information on the instrument's operation during its lifetime and the usage since last reset. The usage screen also shows usage for the internal regulator and the total control time. The "operating time since last reset" and "control time since reset" can be reverted to 0.00 hours by pressing the corresponding "Reset" button on the screen.

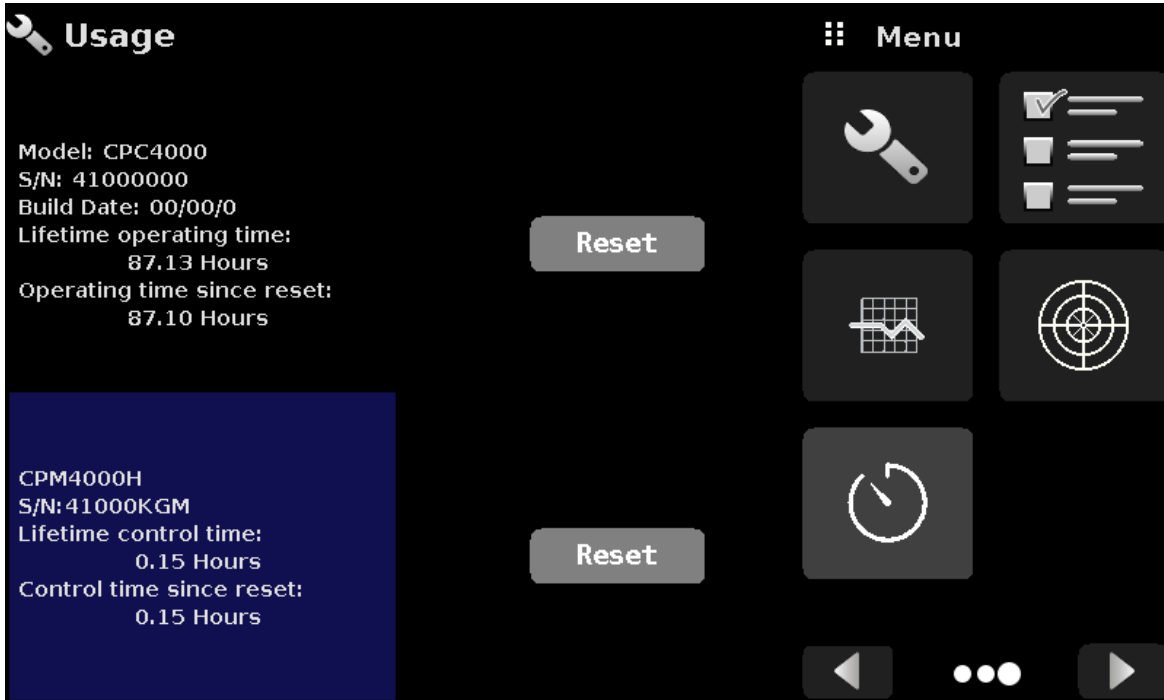

Figure 11.4 Instrument Usage

12 Appendix

12.1 Measurement Units

Table 12.1 – Measurement Units (unitno)

Code	Description	Output Format
1	pounds per square inch	psi
2	inches of mercury @ 0°C	in Hg 0°C
3	inches of mercury @ 60°F	in Hg 60°F
4	inches of water @ 4°C	in H2O 4°C
5	inches of water @ 20°C	in H2O 20°C
6	inches of water @ 60°F	in H2O 60°F
7	feet of water @ 4°C	ft H2O 4°C
8	feet of water @ 20°C	ft H2O 20°C
9	feet of water @ 60°F	ft H2O 60°F
10	millitorr	mTorr
11	inches of seawater @ 0°C 3.5% salinity	in SW
12	feet of seawater @ 0°C 3.5% salinity	ft SW
13	atmospheres	atm
14	bars	bar
15	millibars	mbar
16	millimeters of water @ 4°C	mm H2O 4°C
17	centimeters of water @ 4°C	cm H2O 4°C
18	meters of water @ 4°C	m H2O 4°C
19	millimeters of mercury @ 0°C	mm Hg 0°C
20	centimeters of mercury @ 0°C	cm Hg 0°C
21	torr	Torr
22	kilopascals	kPa
23	pascals	Pa
24	dyne per square centimeter	dyn/cm2
25	grams per square centimeter	g/cm2
26	kilograms per square centimeter	kg/cm2
27	meters of seawater @ 0°C 3.5% salinity	m SW
28	ounce per square inch	osi
29	pounds per square foot	pfs
30	tons per square foot	tsf
31	percent of full scale	% of Range
32	micron of mercury @ 0°C	mHg
33	ton per square inch	tsi
34	meters of mercury @ 0°C	MHg
35	hectopascals	hPa
36	megapascals	MPa
37	millimeters of water @ 20°C	mm H2O 20°C
38	centimeter of water @ 20°C	cm H2O 20°C
39	meters of water @ 20°C	m H2O 20°C
n/a	User Units 1	User defined
n/a	User Units 2	User defined

12.2 Conversion Factors, PSI

The values listed in the column “To convert from PSI” are the values imbedded in the instrument program. The values listed under “To convert to PSI” are internally calculated approximations based on the imbedded values.

Table 12.2 – Conversion Factors, PSI

Code	Pressure Unit	To convert from PSI	To convert to PSI
1	PSI	1	1
2	inHg 0°C	2.036020	0.4911544
3	inHg 60°F	2.041772	0.4897707
4	inH2O 4°C	27.68067	0.03612629
5	inH2O 20°C	27.72977	0.03606233
6	inH2O 60°F	27.70759	0.03609119
7	ftH2O 4°C	2.306726	0.4335149
8	ftH2O 20°C	2.310814	0.4327480
9	ftH2O 60°F	2.308966	0.4330943
10	mTorr	51715.08	0.00001933672
11	inSW 0°C 3.5% salinity	26.92334	0.03714250
12	ftSW 0°C 3.5% salinity	2.243611	0.445710
13	ATM	0.06804596	14.69595
14	Bar	0.06894757	14.50377
15	mBar	68.94757	0.01450377
16	mmH2O 4°C	703.0890	0.001422295
17	cmH2O 4°C	70.30890	0.01422295
18	MH2O 4°C	0.7030890	1.422295
19	mmHg 0°C	51.71508	0.01933672
20	cmHg 0°C	5.171508	0.1933672
21	Torr	51.71508	0.01933672
22	kPa	6.894757	0.1450377
23	PA	6894.757	0.0001450377
24	Dy/cm2	68947.57	0.00001450377
25	gm/cm2	70.30697	0.01422334
26	kg/cm2	0.07030697	14.22334
27	MSW 0°C 3.5% salinity	0.6838528	1.462303
28	OSI	16	0.0625
29	PSF	144	0.006944444
30	TSF	0.072	13.88889
32	μHg 0°C	51715.08	0.00001933672
33	TSI	0.0005	2000
34	mHg 0°C	0.05171508	19.33672
35	hPa	68.94757	0.01450377
36	MPa	0.006894757	145.0377
37	mmH2O 20°C	704.336	0.001419777
38	cmH2O 20°C	70.4336	0.01419777
39	MH2O 20°C	0.704336	1.419777

12.3 Conversion Factors, Millitorr

The following table lists factors which should be used as multipliers when converting other pressure units to or from millitorr.

Table 12.3 – Conversion Factors, millitorr

Code	Pressure Unit	To convert from millitorr	To convert to millitorr
1	PSI	0.0001933672	51715.08
2	inHg 0°C	0.0003936995	25400.08909
3	inHg 60°F	0.0003948117	25328.53093
4	inH2O 4°C	0.0005352534	1868.273977
5	inH2O 20°C	0.0005362028	1864.966281
6	inH2O 60°F	0.0005357739	1866.458778
7	ftH2O 4°C	0.0004460451	22419.25773
8	ftH2O 20°C	0.0004468356	22379.59744
9	ftH2O 60°F	0.0004464783	22397.50637
10	mTorr	1.0	1.000000000
11	inSW 0°C 3.5% salinity	0.0005206091	1920.827359
12	ftSW 0°C 3.5% salinity	0.0004338408	23049.92831
13	ATM	0.00001315786	760002.2299
14	Bar	0.00001333220	750063.6259
15	mBar	0.001333220	750.0636259
16	mmH2O 4°C	0.0135954	73.5540997
17	cmH2O 4°C	0.001359544	735.5409971
18	MH2O 4°C	0.00001359544	73554.09971
19	mmHg 0°C	0.001	1000.000000
20	cmHg 0°C	0.0001	10000.00000
21	Torr	0.001	1000.000000
22	kPa	0.0001333220	7500.636259
23	PA	0.1333220	7.500636259
24	Dy/cm2	1.333220	0.750063626
25	gm/cm2	0.001359506	735.561166
26	kg/cm2	0.000001359506	735561.166
27	MSW 0°C 3.5% salinity	0.00001322347	75623.11663
28	OSI	0.0003093875	3232.1992
29	PSF	0.002784488	359.132477
30	TSF	0.000001392244	718265.0575
32	µHg 0°C	1.0	1.000000000
33	TSI	0.00000000966836	103430160.00
34	mHg	0.000001	1000000.00
35	hPa	0.001333220	750.0636259
36	MPa	0.0000001333220	7500636.259
37	mmH2O 20°C	0.01361955	73.42388114
38	cmH2O 20°C	0.001361955	734.2388114
39	MH2O 20°C	0.00001361955	73423.88114

Industrial Pressure Controller CPC4000

12.4 Conversion Factors, Pascal

The following table lists factors which should be used as multipliers when converting other pressure units to or from Pascal.

12.4 – Conversion Factors, Pascal

Unit No.	Pressure Unit	To convert from Pascal	To convert to Pascal
1	PSI	1.450377E-04	6.894757E+03
2	inHg 0°C	2.952997E-04	3.386390E+03
3	inHg 60°F	2.961339E-04	3.376850E+03
4	inH2O 4°C	4.014741E-03	2.490820E+02
5	inH2O 20°C	4.021862E-03	2.486410E+02
6	inH2O 60°F	4.018645E-03	2.488400E+02
7	ftH2O 4°C	3.345622E-04	2.988980E+03
8	ftH2O 20°C	3.351551E-04	2.983692E+03
9	ftH2O 60°F	3.348871E-04	2.986080E+03
10	mTorr	7.500636E+00	1.333220E-01
11	inSW 0°C 3.5% sal	3.904899E-03	2.560885E+02
12	ftSW 0°C 3.5% sal	3.254082E-04	3.073062E+03
13	ATM	9.869230E-06	1.013250E+05
14	Bar	1.00000E-05	1.00000E+05
15	mBar	1.00000E-02	1.00000E+02
16	mmH2O 4°C	1.019744E-01	9.806378E+00
17	cmH2O 4°C	1.019744E-02	9.806378E+01
18	MH2O 4°C	1.019744E-04	9.806378E+03
19	mmHg 0°C	7.500636E-03	1.333220E+02
20	cmHg 0°C	7.500636E-04	1.333220E+03
21	Torr	7.500636E-03	1.333220E+02
22	kPa	1.00000E-03	1.00000E+03
23	PA	1.00000E+00	1.00000E+00
24	Dy/cm2	1.00000E+01	1.00000E-01
25	gm/cm2	1.019716E-02	9.806647E+01
26	kg/cm2	1.019716E-05	9.806647E+04
27	MSW 0°C 3.5% sal	9.918444E-05	1.008222E+04
28	OSI	2.320603E-03	4.309223E+02
29	PSF	2.088543E-02	4.788025E+01
30	TSF	1.044271E-05	9.576052E+04
32	µHg 0°C	7.500636E+00	1.333220E-01
33	TSI	7.251885E-08	1.378951E+07
34	mHg 0°C	7.500636E-06	1.333220E+05
35	hPa	1.00000E-02	1.00000E+02
36	MPa	1.00000E-06	1.00000E+06
37	mmH2O 20°C	1.021553E-01	9.789017E+00
38	cmH2O 20°C	1.021553E-02	9.789017E+01
39	MH2O 20°C	1.021553E-04	9.789017E+03



Mensor

201 Barnes Drive
San Marcos, Texas 78666
Tel: 512-396-4200
Website: www.mensor.com
Fax: 512-396-1820
Email: sales@mensor.com



WIKAI Alexander Wiegand SE & Co. KG
Alexander-Wiegand-Straße 30
D-63911 Klingenberg / Germany
Tel: (+49) 93 72/132-5015
Website: www.wika.de
Fax: (+49) 93 72/132-8767
Email: CTsales@wika.de