

Operating Instructions

CCS50D

Digital sensor with Memosens technology for determining chlorine dioxide

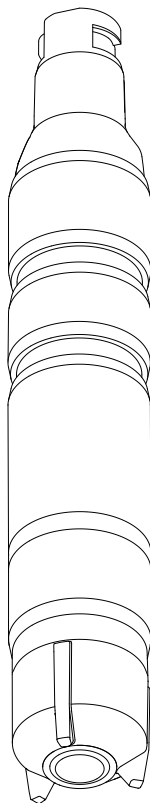





Table of contents







1	About this document	4	11	Accessories	40
1.1	Warnings	4	11.1	Maintenance kit CCV05	40
1.2	Symbols used	4	11.2	Device-specific accessories	40
2	Basic safety instructions	6	12	Technical data	41
2.1	Requirements for the personnel	6	12.1	Input	41
2.2	Designated use	6	12.2	Performance characteristics	43
2.3	Workplace safety	6	12.3	Environment	44
2.4	Operational safety	7	12.4	Process	44
2.5	Product safety	7	12.5	Mechanical construction	45
3	Product description	8	13	Installation and operation in hazardous environment Class I Div. 2	46
3.1	Product design	8	Index	48	
4	Incoming acceptance and product identification	13			
4.1	Incoming acceptance	13			
4.2	Product identification	13			
5	Installation	15			
5.1	Installation conditions	15			
5.2	Mounting the sensor	17			
5.3	Post-installation check	24			
6	Electrical connection	25			
6.1	Connecting the sensor	25			
6.2	Ensuring the degree of protection	25			
6.3	Post-connection check	26			
7	Commissioning	27			
7.1	Function check	27			
7.2	Sensor polarization	27			
7.3	Sensor calibration	27			
8	Diagnostics and troubleshooting	29			
9	Maintenance	31			
9.1	Maintenance schedule	31			
9.2	Maintenance tasks	32			
10	Repair	39			
10.1	Spare parts	39			
10.2	Return	39			
10.3	Disposal	39			

1 About this document

1.1 Warnings

Structure of information	Meaning
 <p>Causes (/consequences) If necessary, Consequences of non-compliance (if applicable) ▶ Corrective action</p>	<p>This symbol alerts you to a dangerous situation. Failure to avoid the dangerous situation will result in a fatal or serious injury.</p>
 <p>Causes (/consequences) If necessary, Consequences of non-compliance (if applicable) ▶ Corrective action</p>	<p>This symbol alerts you to a dangerous situation. Failure to avoid the dangerous situation can result in a fatal or serious injury.</p>
 <p>Causes (/consequences) If necessary, Consequences of non-compliance (if applicable) ▶ Corrective action</p>	<p>This symbol alerts you to a dangerous situation. Failure to avoid this situation can result in minor or more serious injuries.</p>
 <p>Cause/situation If necessary, Consequences of non-compliance (if applicable) ▶ Action/note</p>	<p>This symbol alerts you to situations which may result in damage to property.</p>

1.2 Symbols used

Symbol	Meaning
	Additional information, tips
	Permitted or recommended
	Not permitted or not recommended
	Reference to device documentation
	Reference to page
	Reference to graphic
	Result of a step

1.2.1 Symbols on the device

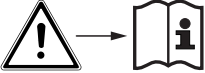
Symbol	Meaning
	Reference to device documentation

2 Basic safety instructions

2.1 Requirements for the personnel

Installation, commissioning, operation and maintenance of the measuring system may be carried out only by specially trained technical personnel.

- ▶ The technical personnel must be authorized by the plant operator to carry out the specified activities.
- ▶ The electrical connection may be performed only by an electrical technician.
- ▶ The technical personnel must have read and understood these Operating Instructions and must follow the instructions contained therein.
- ▶ Measuring point faults may be repaired only by authorized and specially trained personnel.



Repairs not described in the Operating Instructions provided must be carried out only directly at the manufacturer's site or by the service organization.

2.2 Designated use

Drinking water and industrial water must be disinfected through the addition of appropriate disinfectants such as chlorine gas or inorganic chlorine compounds. The dosing quantity must be adapted to continuously fluctuating operating conditions. If the concentrations in the water are too low, this could jeopardize the effectiveness of the disinfection. On the other hand, concentrations which are too high can lead to signs of corrosion and have an adverse effect on taste, as well as generating unnecessary costs.

The sensor was specifically developed for this application and is designed for continuous measurement of chlorine dioxide in water. In conjunction with measuring and control equipment, it allows optimal control of disinfection.

Use of the device for any purpose other than that described, poses a threat to the safety of people and of the entire measuring system and is therefore not permitted.

The manufacturer is not liable for damage caused by improper or non-designated use.

2.2.1 Hazardous environment in accordance with cCSAus NI Cl. I, Div. 2¹⁾

1. The device must be installed in a housing or cabinet that can be accessed only by means of a tool or key.
2. Pay attention to the control drawing and the specified application conditions in the appendix of these Operating Instructions, and follow the instructions.

2.3 Workplace safety

As the user, you are responsible for complying with the following safety conditions:

- Installation guidelines
- Local standards and regulations

1) Only if connected to CM44x(R)-CD*

Electromagnetic compatibility

- The product has been tested for electromagnetic compatibility in accordance with the applicable European standards for industrial applications.
- The electromagnetic compatibility indicated applies only to a product that has been connected in accordance with these Operating Instructions.

2.4 Operational safety

Before commissioning the entire measuring point:

1. Verify that all connections are correct.
2. Ensure that electrical cables and hose connections are undamaged.
3. Do not operate damaged products, and protect them against unintentional operation.
4. Label damaged products as defective.

During operation:

- ▶ If faults cannot be rectified:
products must be taken out of service and protected against unintentional operation.

2.4.1 Special instructions

- ▶ Do not operate the sensors under process conditions where it is expected that osmotic conditions will cause electrolyte components to pass through the membrane and into the process.

Use of the sensor for its intended purpose in liquids with a conductivity of at least 10 nS/cm can be classified as safe in terms of the application.

2.5 Product safety

The product is designed to meet state-of-the-art safety requirements, has been tested, and left the factory in a condition in which it is safe to operate. The relevant regulations and European standards have been observed.

3 Product description

3.1 Product design

The sensor consists of the following functional units:

- Membrane cap (measuring chamber with membrane)
 - Separates the inner amperometric system from the medium
 - With robust PVDF membrane and pressure relief valve
 - Guarantees a defined and consistent electrolyte film between cathode and membrane
 - With special support grid between cathode and membrane for a defined and consistent electrolyte film and therefore a relatively constant reading at varying pressures and flows
- Sensor shaft with
 - Large anode
 - Cathode embedded in plastic
 - Embedded temperature sensor

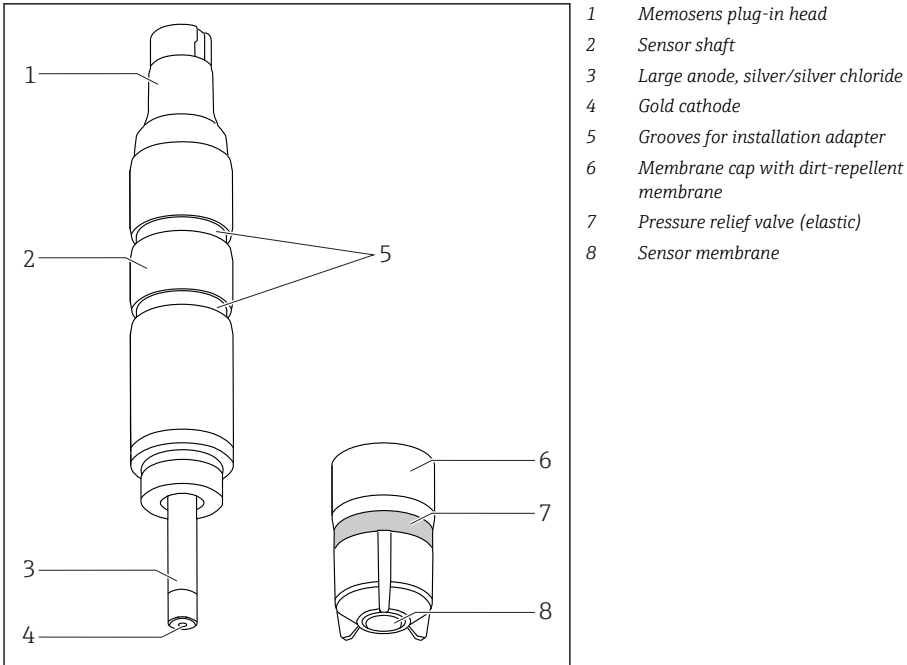

- 1 Memosens plug-in head
- 2 Sensor shaft
- 3 Large anode, silver/silver chloride
- 4 Gold cathode
- 5 Grooves for installation adapter
- 6 Membrane cap with dirt-repellent membrane
- 7 Pressure relief valve (elastic)
- 8 Sensor membrane

1 Sensor structure

3.1.1 Measuring principle

Chlorine dioxide levels are determined in accordance with the amperometric measuring principle.

The chlorine dioxide (ClO_2) in the medium diffuses through the sensor membrane and is reduced to chloride ions (Cl^-) at the gold cathode. At the silver anode, silver is oxidized to

silver chloride. Electron donation at the gold cathode and electron acceptance at the silver anode cause a current to flow which is proportional to the concentration of chlorine dioxide in the medium. This process does not depend on the pH value over a wide range.

The transmitter uses the current signal to calculate the measured variable for concentration in mg/l (ppm).

3.1.2 Effects on the measured signal

pH value

pH dependency

pH value	Result
< 3.5	Chlorine is produced if chloride (Cl ⁻) is present in the medium at the same time. The strong cross-sensitivity to chlorine dioxide causes an increase in the measured value.
3.5 to 9	The pH value does not affect measurement of the chlorine dioxide concentration in the medium.
> 9	Chlorine dioxide is unstable and decomposes.

Flow

The minimum flow velocity of the membrane-covered measuring cell is 15 cm/s (0.5 ft/s).

- When using the Flowfit CCA151 flow assembly, this corresponds to a flow rate of 5 l/h (1.3 gal/h).
- When using the CCA250 flow assembly, this corresponds to a flow rate of 30 l/h (7.9 gal/h) (upper edge of float at the height of the red bar mark).

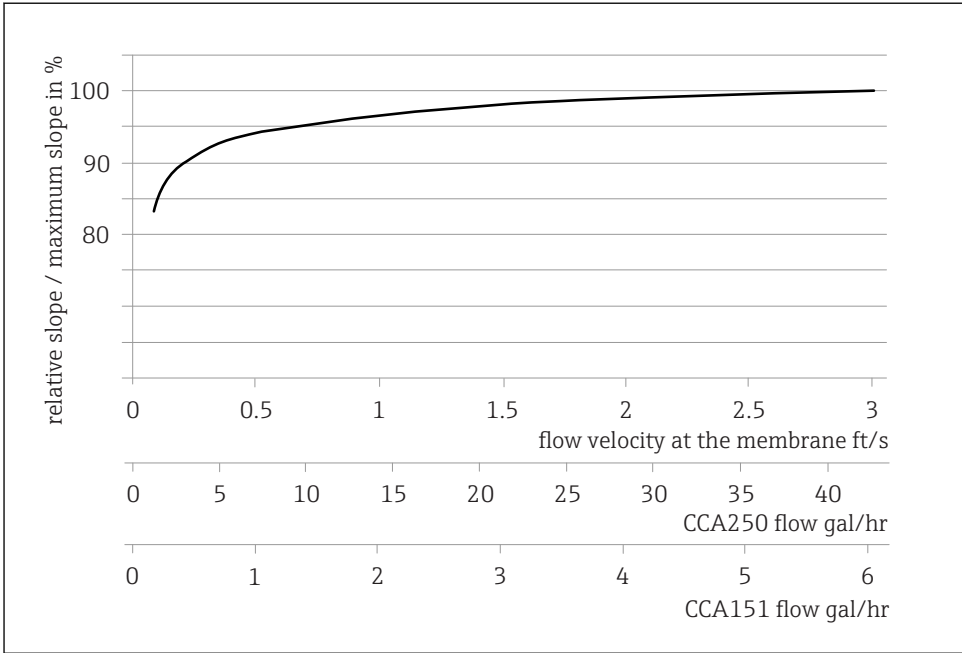

A0034487-EN

2 Correlation between slope of electrode and flow velocity at the membrane/flow rate in assembly

At higher flow rates, the measured signal is virtually flow-independent. However, if the flow rate falls below the specified value, the measured signal depends on the flow.

The installation of an INS proximity switch in the assembly enables reliable detection of this invalid operating status, thus triggering an alarm or causing the dosing process to be switched off if necessary.

Below the minimum flow rate, the sensor current is more sensitive to flow fluctuations. For abrasive media, it is recommended not to exceed the minimum flow. If suspended solids are present, which may form deposits, the maximum flow rate is recommended.

Temperature

Changes in the temperature of the medium affect the measured value:

- Increases in temperature result in a higher measured value (approx. 4 % per K)
- Decreases in temperature result in a lower measured value.

Use of the sensor in combination with the Liquiline enables automatic temperature compensation (ATC). Recalibration in the case of temperature changes is not necessary.

1. If automatic temperature compensation is disabled at the transmitter, the temperature must be maintained at a constant level following calibration.
2. Otherwise, recalibrate the sensor.

In the event of normal and slow changes in temperature (0.3 K / minute), the internal temperature sensor is sufficient. In the event of very rapid temperature fluctuations with high amplitude (2 K / minute), an external temperature sensor is necessary to ensure maximum accuracy.



For detailed information on the use of external temperature sensors, see the Operating Instructions for the transmitter.

Cross-sensitivities ²⁾

Free chlorine, ozone, free bromine

There were no cross-sensitivities for: H₂O₂, peracetic acid

2) The listed substances have been tested with different concentrations. An additive effect has not been investigated.

4 Incoming acceptance and product identification

4.1 Incoming acceptance

1. Verify that the packaging is undamaged.
 - ↳ Notify the supplier of any damage to the packaging.
Keep the damaged packaging until the issue has been resolved.
2. Verify that the contents are undamaged.
 - ↳ Notify the supplier of any damage to the delivery contents.
Keep the damaged goods until the issue has been resolved.
3. Check that the delivery is complete and nothing is missing.
 - ↳ Compare the shipping documents with your order.
4. Pack the product for storage and transportation in such a way that it is protected against impact and moisture.
 - ↳ The original packaging offers the best protection.
Make sure to comply with the permitted ambient conditions.

If you have any questions, please contact your supplier or your local Sales Center.

4.2 Product identification

4.2.1 Nameplate

The nameplate provides you with the following information on your device:

- Manufacturer identification
- Extended order code
- Serial number
- Safety information and warnings

- ▶ Compare the information on the nameplate with the order.

4.2.2 Product page

www.endress.com/ccs50d

4.2.3 Interpreting the order code

The order code and serial number of your product can be found in the following locations:

- On the nameplate
- In the delivery papers

Obtaining information on the product

1. Go to www.endress.com.
2. Call up the site search (magnifying glass).
3. Enter a valid serial number.
4. Search.
 - ↳ The product structure is displayed in a popup window.

5. Click on the product image in the popup window.
 - ↳ A new window (**Device Viewer**) opens. All of the information relating to your device is displayed in this window as well as the product documentation.

4.2.4 Manufacturer address

Endress+Hauser Conducta GmbH+Co. KG
Dieselstraße 24
D-70839 Gerlingen

4.2.5 Scope of delivery

The delivery comprises:

- Disinfection sensor (membrane-covered, Ø25 mm) with protection cap (ready for use)
- Bottle with electrolyte (50 ml (1.69 fl.oz))
- Replacement membrane cap in protection cap
- Operating Instructions
- Manufacturer inspection certificate

4.2.6 Certificates and approvals

CE mark

Declaration of conformity

The product meets the requirements of the harmonized European standards. As such, it complies with the legal specifications of the EU directives. The manufacturer confirms successful testing of the product by affixing to it the **CE** mark.

EAC

The product has been certified according to guidelines TP TC 004/2011 and TP TC 020/2011 which apply in the European Economic Area (EEA). The EAC conformity mark is affixed to the product.

Ex approvals ³⁾

cCSAus NI Cl. I, Div. 2

This product complies with the requirements defined in:

- UL 61010-1
- ANSI/ISA 12.12.01
- FM 3600
- FM 3611
- CSA C22.2 NO. 61010-1-12
- CSA C22.2 NO. 213-16
- Control drawing: 401204

3) Only if connected to CM44x(R)-CD*

5 Installation

5.1 Installation conditions

5.1.1 Installation position

Do not install upside-down!

- ▶ Install the sensor in an assembly, support or appropriate process connection at an angle of at least 15° to the horizontal.
- ▶ Other angles of inclination are not permitted.
- ▶ Follow the instructions for installing the sensor in the Operating Instructions of the assembly used.

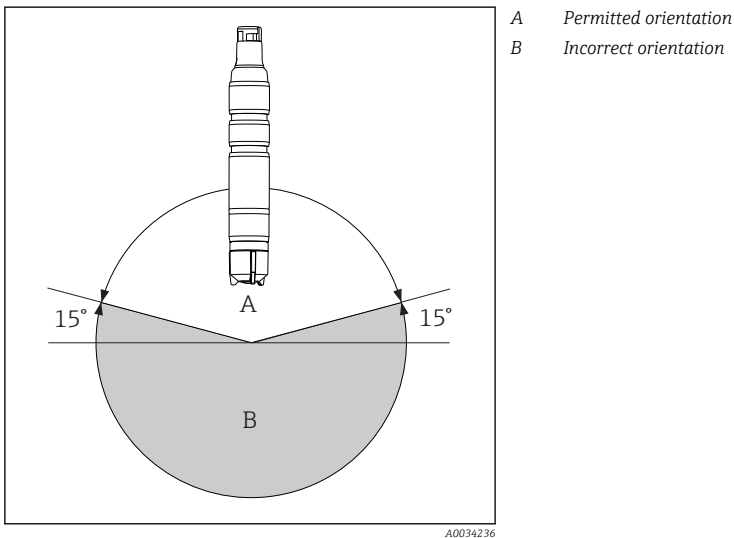

5.1.2 Immersion depth

50 mm (1.97 in)

5.1.3 Dimensions

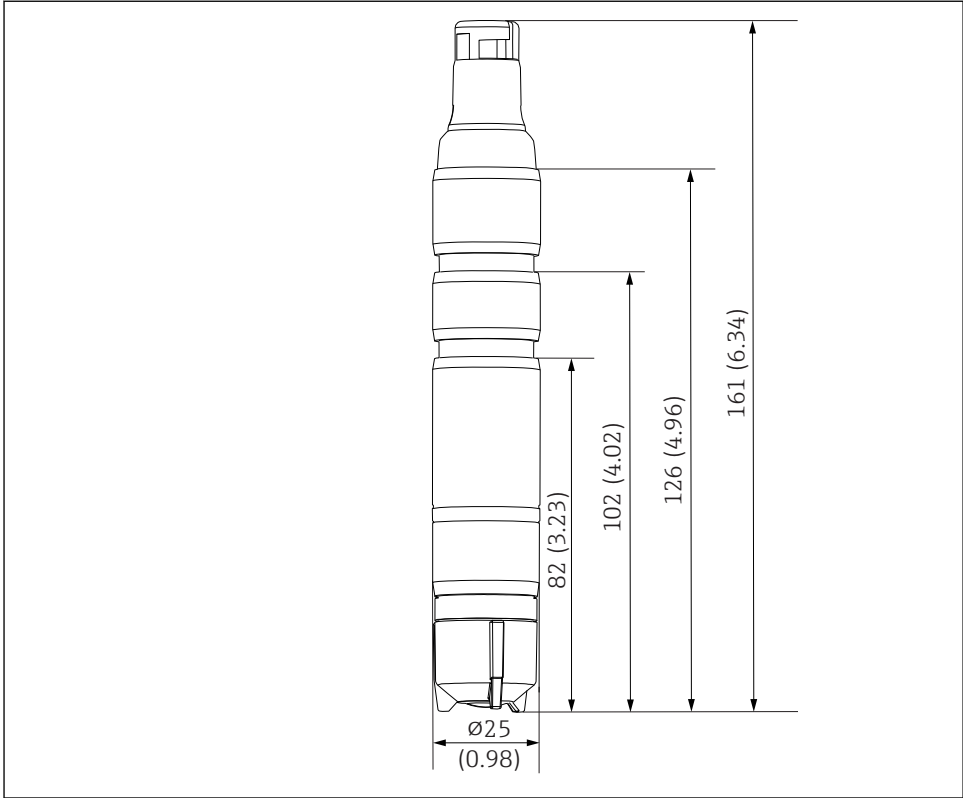

A0034238

3 Dimensions in mm (in)

5.2 Mounting the sensor

5.2.1 Measuring system

A complete measuring system comprises:

- Disinfection sensor CCS50D (membrane-covered, Ø25 mm) with corresponding installation adapter
- Flowfit CCA151 flow assembly
- Measuring cable CYK10, CYK20
- Transmitter , e.g. Liquiline CM44x or CM44xR
- Optional: extension cable CYK11
- Optional: proximity switch
- Optional: CPS31
- Optional: Flowfit CCA250 flow assembly (a pH/ORP sensor can additionally be installed here)
- Optional: immersion assembly Flexdip CYA112

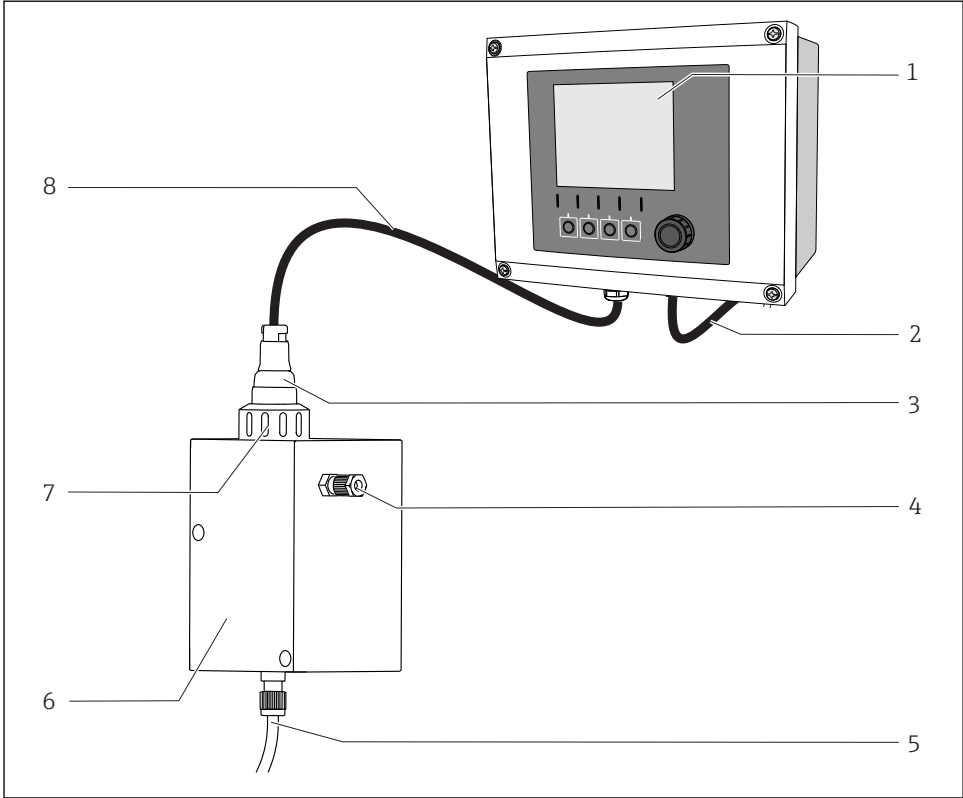

A0034241

4 Example of a measuring system

- 1 Liquiline CM44x transmitter
- 2 Power cable for transmitter
- 3 Disinfection sensor CCS50D (membrane-covered, Ø25 mm)
- 4 Outlet from Flowfit CCA151 flow assembly
- 5 Inlet to Flowfit CCA151 flow assembly
- 6 Flowfit CCA151 flow assembly
- 7 Union nut for installing a disinfection sensor in the Flowfit CCA151 flow assembly
- 8 Measuring cable CYK10

5.2.2 Preparing the sensor

Removing protection cap from sensor

NOTICE

Negative pressure causes damage to the sensor's membrane cap.

► If the protection cap is attached, carefully remove it from sensor.

1. When supplied to the customer and when in storage, the sensor is fitted with a protection cap: First release just the top part of the protection cap by turning it.

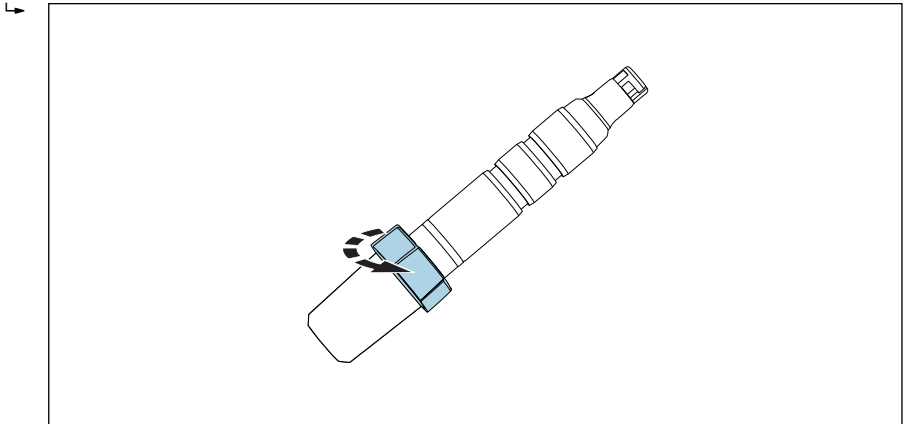

A0034263

 5 *Releasing top part of protection cap by turning*

2. Carefully remove protection cap from sensor.

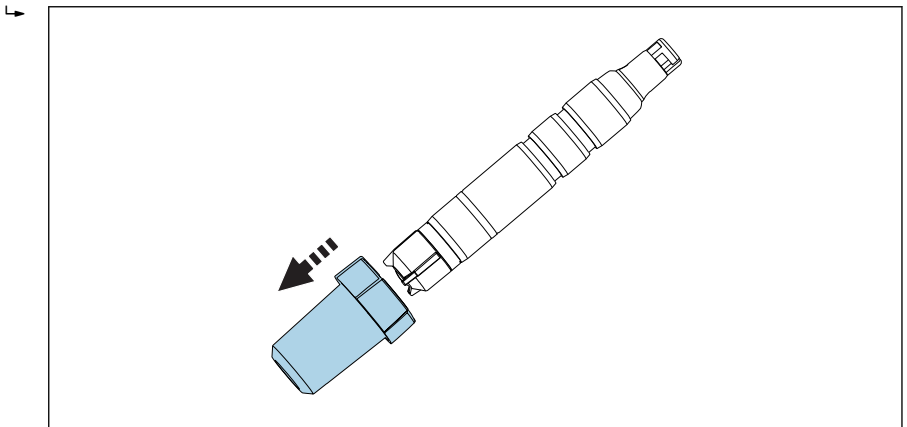

A0034350

 6 *Carefully remove protection cap*

5.2.3 Installing sensor in CCA151 assembly

The disinfection sensor (membrane-covered, $\varnothing 25$ mm) is designed for installation in the Flowfit CCA151 flow assembly.

Please note the following during installation:

- ▶ The flow rate must be at least 5 l/h (1.3 gal/h).
- ▶ If the medium is returned to an overflow basin, pipe or similar, the resulting counterpressure on the sensor must not exceed 1 bar (14.5 psi) and must remain constant.
- ▶ Avoid negative pressure at the sensor, e.g. due to medium being returned to the suction side of a pump.
- ▶ To avoid buildup, heavily contaminated water should also be filtered.

Preparing assembly

1. The assembly is supplied to the customer with a union nut screwed onto the assembly: unscrew union nut from assembly.

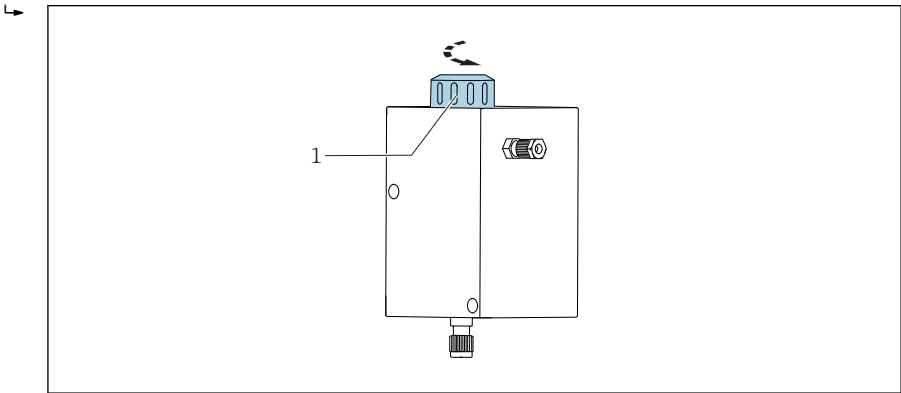

A0034262

 7 Flowfit CCA151 flow assembly

1 Union nut

2. The assembly is supplied to the customer with a dummy plug inserted in the assembly: remove dummy plug from assembly.

Equip sensor with adapter

The required adapter (clamping ring, thrust collar and O-ring) can be ordered as a mounted sensor accessory or as a separate accessory → 41.

1. First slide the clamping ring, then the thrust collar, and then the O-ring from the membrane cap towards the sensor head and into the lower groove.

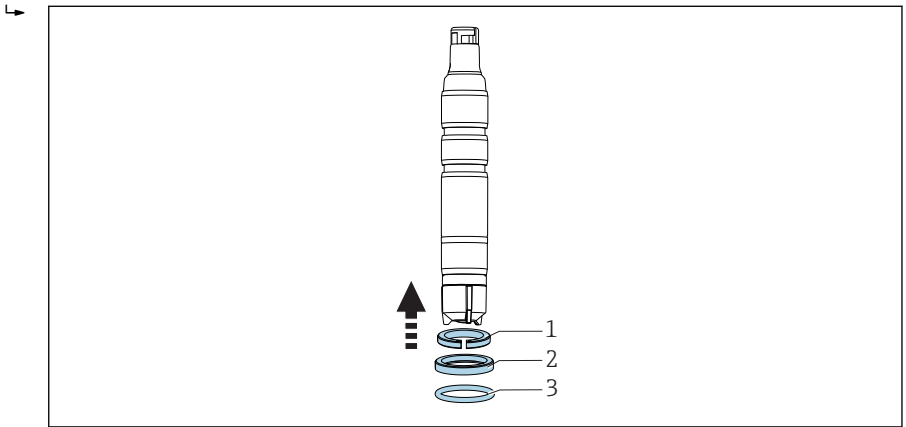

A0034247

- 8 Slide clamping ring (1), thrust collar (2) and O-ring (3) upwards from the membrane cap to the sensor shaft and into the lower groove.

Installing sensor in assembly

2. Slide sensor with adapter for Flowfit CCA151 into the opening in the assembly.

3. Screw union nut onto assembly on block.

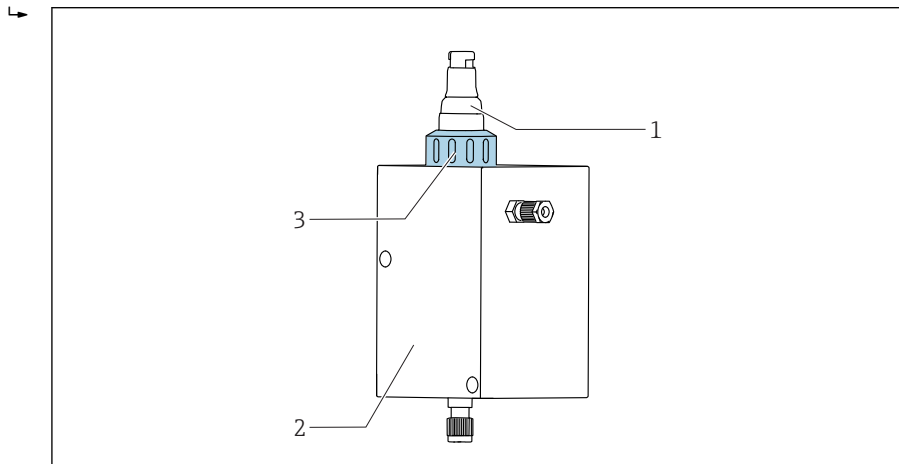

A0034261

9 Flowfit CCA151 flow assembly

- 1 Disinfection sensor
- 2 Flowfit CCA151 flow assembly
- 3 Union nut for securing a disinfection sensor

5.2.4 Installing sensor in CCA250 assembly

The sensor can be installed in the Flowfit CCA250 flow assembly. This allows a pH and an ORP sensor to also be installed, in addition to the chlorine or chlorine dioxide sensor. A needle valve controls the flow in the range of 30 to 120 l/h (7.9 to 31.7 gal/h).

Please note the following during installation:

- ▶ The flow rate must be at least 30 to 120 l/h (7.9 to 31.7 gal/h). If the flow drops below this value or stops completely, this can be detected by an inductive proximity switch and used to trigger an alarm with locking of the dosage pumps.
- ▶ If the medium is returned to an overflow basin, pipe or similar, the resulting counterpressure on the sensor must not exceed 1 bar (14.5 psi) and must remain constant.
- ▶ Negative pressure at the sensor, e.g. due to medium being returned to the suction side of a pump, must be avoided.

Equip sensor with adapter

The required adapter can be ordered as a mounted sensor accessory or as a separate accessory. →  41

1. Slide adapter for Flowfit CCA250 from the sensor head up to the stop on the sensor.

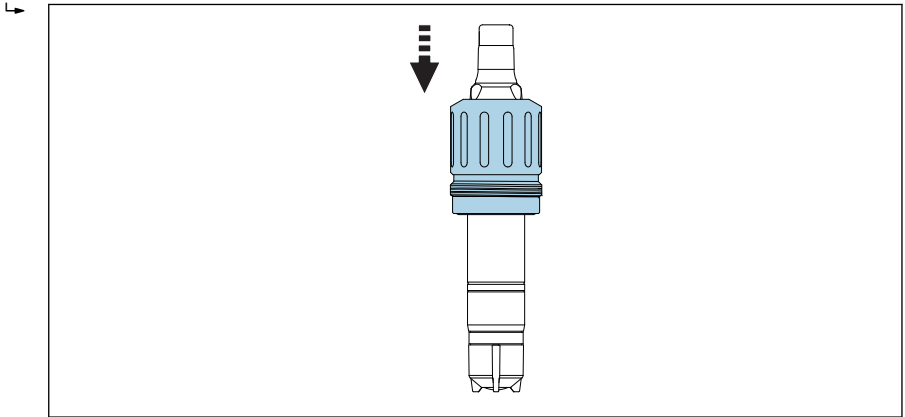

A0034245

 10 Slide on adapter for Flowfit CCA250.

2. Lock the adapter in place using the two studs provided.



For detailed information on "Installing sensor in Flowfit CCA250 assembly", see Operating Instructions for assembly

5.2.5 Installing sensor in other flow assemblies

When using other flow assemblies, please ensure the following:

- ▶ A flow velocity of at least 15 cm/s (0.49 ft/s) must always be ensured at the membrane.
- ▶ The flow direction is upwards. Transported air bubbles must be removed so that they do not collect in front of the membrane.
- ▶ The flow must be directed to the membrane.



Pay attention to the additional installation instructions in the Operating Instructions for the assembly.

5.2.6 Installing sensor in immersion assembly CYA112

Alternatively, the sensor can be installed in an immersion assembly with G1 threaded connection, e. g.

Equip sensor with adapter

The required adapter can be ordered as a mounted sensor accessory or as a separate accessory. →  41

1. Slide adapter for Flexdip CYA112 from the sensor head up to the stop on the sensor.

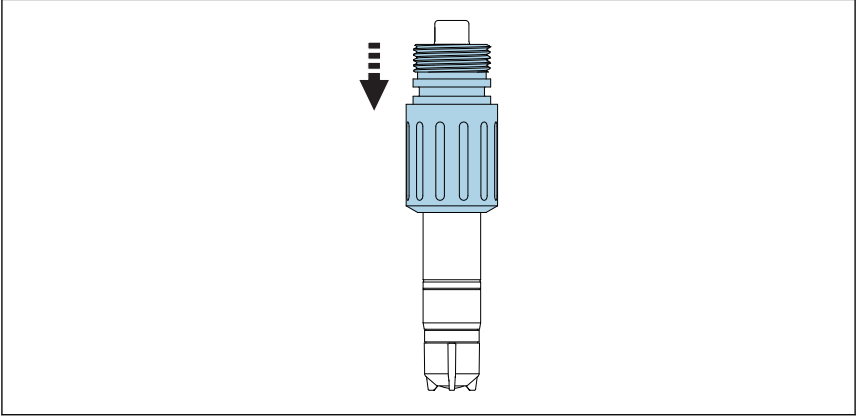

A0034246

 11 Slide on adapter for Flexdip CYA112.

2. Lock the adapter in place using the two studs provided.

 For detailed information on "Installing sensor in Flexdip CYA112 assembly", see Operating Instructions for assembly

5.3 Post-installation check

1. Is the adapter locked in place and unable to move freely?
2. Is the sensor installed in an assembly and not freely suspended from the cable?
 - ↳ Install the sensor in an assembly or directly via the process connection.
3. Is the membrane cap sealed?
 - ↳ Replace if necessary.
4. Is the membrane intact and lying flat: Is the membrane bulging slightly (not flat)?
5. Is there electrolyte in the membrane cap?
 - ↳ If necessary, refill the membrane cap with electrolyte.

6 Electrical connection

CAUTION

Device is live

Incorrect connection may result in injury!

- ▶ The electrical connection may be performed only by an electrical technician.
- ▶ The electrical technician must have read and understood these Operating Instructions and must follow the instructions contained therein.
- ▶ **Prior** to commencing connection work, ensure that no voltage is present on any cable.

6.1 Connecting the sensor

The electrical connection to the transmitter is established using measuring cable CYK10 or CYK20.

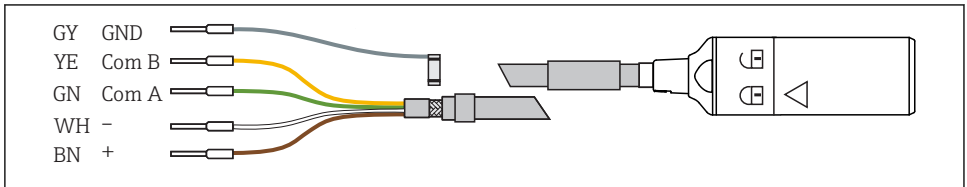

12 Measuring cable CYK10/CYK20

- ▶ To extend the cable, use measuring cable CYK11. The maximum cable length is 100 m (328 ft).

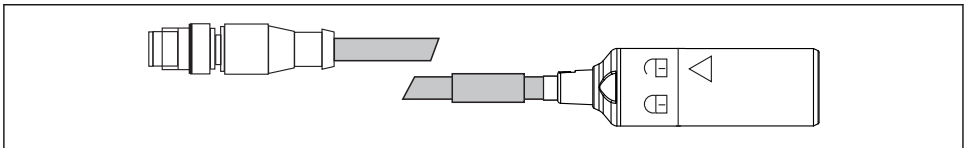

13 Electrical connection, M12 plug

6.2 Ensuring the degree of protection

Only the mechanical and electrical connections which are described in these instructions and which are necessary for the required, designated use, may be carried out on the device delivered.

- ▶ Exercise care when carrying out the work.

Otherwise, the individual types of protection (Ingress Protection (IP), electrical safety, EMC interference immunity) agreed for this product can no longer be guaranteed due, for example to covers being left off or cable (ends) that are loose or insufficiently secured.

6.3 Post-connection check

Device condition and specifications	Notes
Are the sensor, assembly, or cables free from damage on the outside?	Visual inspection
Electrical connection	Notes
Are the mounted cables strain-relieved and not twisted?	
Is a sufficient length of the cable cores stripped, and are the cores positioned in the terminal correctly?	Check the fit (by pulling gently)
Are all the screw terminals properly tightened?	Tighten
Are all the cable entries installed, tightened and sealed?	For lateral cable entries, make sure the cables loop downwards to allow water to drip off
Are all cable entries installed downwards or mounted laterally?	

7 Commissioning

7.1 Function check

Prior to initial commissioning, ensure that:

- The sensor is correctly installed.
- The electrical connection is correct.
- There is sufficient electrolyte in the membrane cap and the transmitter is not displaying a warning about electrolyte depletion.



Please note the information on the safety data sheet to ensure safe use of the electrolyte.



Always keep the sensor moist after commissioning.

WARNING

Escaping process medium

Risk of injury from high pressure, high temperatures or chemical hazards

- ▶ Before applying pressure to an assembly with cleaning system, ensure that the system has been connected correctly.
- ▶ Do not install the assembly in the process if you cannot reliably establish the correct connection.

7.2 Sensor polarization

The voltage applied by the transmitter between the cathode and anode polarizes the surface of the cathode. Therefore, after switching on the transmitter with the sensor connected, you must wait until the polarization period has elapsed before starting calibration.

To achieve a stable display value, the sensor requires the following polarization periods:

Initial commissioning	60 min.
Recommissioning	30 min.

7.3 Sensor calibration

Reference measurement according to the DPD method

To calibrate the measuring system, carry out a colorimetric comparison measurement in accordance with the DPD method for chlorine dioxide. Chlorine dioxide reacts with diethyl-p-phenyldiamine (DPD) to form a red dye, the intensity of the red color being proportional to the chlorine dioxide content.

Measure the intensity of the red color using a photometer, e.g. PF-3 (→ 41). The photometer indicates the chlorine dioxide content.

If the photometer used indicates the presence of chlorine, follow the manufacturer's instructions to convert the chlorine content into the chlorine dioxide content.

Requirements

The sensor reading is stable (no drifts or unsteady values for at least 5 minutes), and the medium is stable. This is normally guaranteed once the following preconditions have been met:

- The polarization period has elapsed.
- The flow is constant and within the correct range.
- The sensor and the medium are at the same temperature.
- The pH value is within the permitted range.
- Optional:
 - For zero point adjustment: electrolyte has been replaced (→  34)

Zero point adjustment

A zero point adjustment is not required due to the zero point stability of the membrane-covered sensor.

However, a zero point adjustment can be performed if desired.

1. To perform a zero point adjustment, operate the sensor for at least 15 minutes in chlorine-free water, using the assembly or protection cap as a vessel.
2. Alternatively, perform the zero point adjustment using the zero point gel COY8 →  40.

Slope calibration



Always perform a slope calibration in the following cases:

- After replacing the membrane cap
 - After replacing electrolyte
 - After the membrane cap has been screwed back on
1. Ensure that the temperature of the medium is constant.
 2. Take a representative sample for the DPD measurement. This must be done in close proximity to the sensor. Use the sampling tap if available.
 3. Determine the chlorine dioxide content using the DPD method.
 4. Enter the measured value into the transmitter (see Operating Instructions for transmitter).
 5. To ensure greater accuracy, check the calibration several hours or 24 hours later using the DPD method.

8 Diagnostics and troubleshooting

When troubleshooting, the entire measuring point must be taken into account. This comprises:

- Transmitter
- Electrical connections and lines
- Assembly
- Sensor

The possible causes of error in the following table refer primarily to the sensor. Before commencing troubleshooting, ensure that the following operating conditions have been met:

- Measurement in "temperature-compensated" mode (can be configured on transmitter CM44x) or constant temperature following calibration
- Medium flow of at least 5 l/h (1.3 gal/h) (when using Flowfit CCA151 flow assembly)
- No use of organic chlorination agents



If the value measured by the sensor differs significantly from that of the DPD method, first consider all possible malfunctions of the photometric DPD method (see Operating Instructions for photometer). If necessary, repeat the DPD measurement several times.

Error	Possible cause	Remedy
No display, no sensor current	No supply voltage at the transmitter	▶ Establish mains connection
	Connection cable between sensor and transmitter interrupted	▶ Establish cable connection
	There is no electrolyte in the membrane cap	▶ Fill membrane cap
	No input flow of medium	▶ Establish flow, clean filter
Display value too high	Polarization of the sensor not yet completed	▶ Wait for polarization to be completed
	Membrane defective	▶ Replace membrane cap
	Shunt resistance (e.g. moisture contact) in the sensor shaft	▶ Remove membrane cap, rub cathode until dry. ▶ If the transmitter display does not return to zero, there is a shunt present: replace sensor.
	Foreign oxidants interfering with sensor	▶ Examine medium, check chemicals

Error	Possible cause	Remedy
Display value too low	Membrane cap not screwed on fully	<ul style="list-style-type: none"> ▶ Fill membrane cap with fresh electrolyte → ☰ 34 ▶ Screw membrane cap on fully
	Membrane soiled	▶ Clean membrane → ☰ 32
	Air bubble in front of membrane	▶ Release air bubble
	Air bubble between cathode and membrane	<ul style="list-style-type: none"> ▶ Remove membrane cap, top up electrolyte ▶ Remove air bubble by tapping on the outside of the membrane cap ▶ Screw on membrane cap
	Input flow of medium too low	▶ Establish correct flow
	Foreign oxidants interfering with DPD reference measurement	▶ Examine medium, check chemicals
	Use of organic disinfectants	<ul style="list-style-type: none"> ▶ Use suitable agent (e.g. as per DIN 19643) (water may need to be replaced first) ▶ Use suitable reference system
Display fluctuates considerably	Hole in membrane	▶ Replace membrane cap

9 Maintenance



Please note the information on the safety data sheet to ensure safe use of the electrolyte.

Take all the necessary precautions in time to ensure the operational safety and reliability of the entire measuring system.

NOTICE

Effects on process and process control!

- ▶ When carrying out any work on the system, bear in mind any potential impact this could have on the process control system and the process itself.
- ▶ For your own safety, only use genuine accessories. With genuine parts, the function, accuracy and reliability are also ensured after maintenance work.

9.1 Maintenance schedule

Interval	Maintenance work
If deposits are visible on the membrane (biofilm, limescale)	Clean sensor membrane → 33
If dirt is visible on the surface of the electrode body	Clean electrode body of sensor → 33
<ul style="list-style-type: none"> ▪ Slope depending on application: <ul style="list-style-type: none"> – At least every 12 months under constant conditions in the permitted range of 0 to 55 °C (32 to 131 °F) – In the case of severe temperature fluctuations, e.g. from 10 °C (50 °F) to 25 °C (77 °F) and back 100 times ▪ Zero point calibration: <ul style="list-style-type: none"> – If operated in concentration range below 0.5 mg/l (ppm) – If negative measured value is displayed with factory calibration. 	Sensor calibration
<ul style="list-style-type: none"> ▪ If electrolyte counter warning is active ▪ If cap is replaced ▪ For determining the zero point ▪ If the slope is too low or too high relative to the nominal slope and the membrane cap is not visibly damaged or dirty 	Fill membrane cap with fresh electrolyte → 34
<ul style="list-style-type: none"> ▪ If there are grease/oil deposits (dark or transparent spots on the membrane) ▪ If slope is too high or too low or sensor current is very noisy ▪ If it is obvious that the sensor current is significantly dependent on the temperature (temperature compensation not working). 	Replace membrane cap → 34
If changes are visible on the cathode or anode (brown coating no longer present)	Regenerate sensor → 37

9.2 Maintenance tasks

9.2.1 Cleaning the sensor

Removing sensor from assembly

Remove sensor from assembly CCA151

1. Unscrew union nut from assembly.

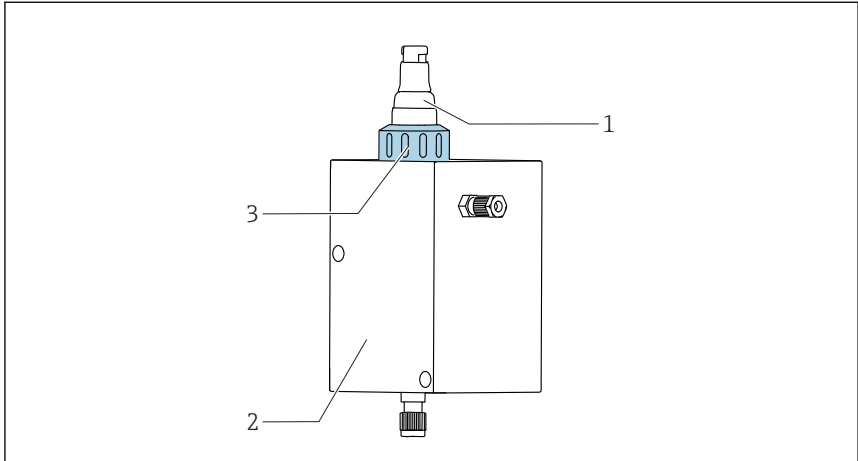

A0034261

- 1 Disinfection sensor CCS50D
- 2 Flowfit CCA151 flow assembly
- 3 Union nut for securing a disinfection sensor CCS50D

2. Pull sensor out through opening in assembly.

Remove sensor from assembly CCA250

1. Remove adapter studs used to secure the adapter to the sensor.
2. Carefully remove adapter in the direction of the sensor head.
3. For detailed information on "Removing sensor from assembly CCA250", see Operating Instructions for assembly.

Remove sensor from assembly CYA112

1. Remove adapter studs used to secure the adapter to the sensor.
2. Carefully remove adapter in the direction of the sensor head.
3. For detailed information on "Removing sensor from assembly CYA112", see Operating Instructions for assembly.

Cleaning sensor membrane

CAUTION

Diluted hydrochloric acid

Hydrochloric acid causes irritation if it comes into contact with the skin or eyes.

- ▶ When using diluted hydrochloric acid, wear protective clothing such as gloves and goggles.
- ▶ Avoid splashes.



NOTICE

Chemicals that reduce surface tension (e.g. surfactants in cleaning agents or organic solvents such as alcohol that can be mixed with water)

Due to chemicals that reduce surface tension, the sensor membrane loses its water-repellent characteristics and becomes permeable to water. The sensor membrane loses its protective effect, resulting in measured errors.

- ▶ Do not use any chemicals that reduce surface tension.

If the membrane is visibly dirty, e.g. biofilm, proceed as follows:

1. Remove sensor from flow assembly →  32.
2. Remove membrane cap →  34.
3. Clean the membrane cap mechanically only using a gentle water jet. Alternatively, clean for several minutes in diluted acids or in specified cleaning agents without any further chemical additives.
4. Then rinse thoroughly with water.
5. Screw membrane cap back onto sensor →  34.

Cleaning electrode body

CAUTION

Diluted hydrochloric acid

Hydrochloric acid causes irritation if it comes into contact with the skin or eyes.



- ▶ When using diluted hydrochloric acid, wear protective clothing such as gloves and goggles.
- ▶ Avoid splashes.

NOTICE

Chemicals that reduce surface tension (e.g. surfactants in cleaning agents or organic solvents such as alcohol that can be mixed with water)

Due to chemicals that reduce surface tension, the sensor membrane loses its water-repellent characteristics and becomes permeable to water. The sensor membrane loses its protective effect, resulting in measured errors.

- ▶ Do not use any chemicals that reduce surface tension.

1. Remove sensor from flow assembly →  32.
2. Remove membrane cap →  34.
3. Wipe gold electrode carefully using a soft sponge.
4. Rinse electrode body with demineralized water, alcohol or acid.

5. Screw membrane cap back onto sensor →  34.

9.2.2 Filling membrane cap with fresh electrolyte

 Please note the information on the safety data sheet to ensure safe use of the electrolyte.

NOTICE

Damage to membrane and electrodes, air bubbles



Possibility of measured errors to complete failure of the measuring point

- ▶ Avoid damage to membrane and electrodes.
- ▶ The electrolyte is chemically neutral and is not hazardous to health. Nonetheless, do not swallow it and avoid contact with eyes.
- ▶ Keep the electrolyte bottle closed after use. Do not transfer electrolyte to other vessels.
- ▶ Do not store electrolyte for longer than 2 years. The electrolyte must not be yellow in color. Observe the use-by date on the label.
- ▶ Avoid air bubbles when pouring electrolyte into membrane cap.

Fill membrane cap with electrolyte

1. Remove membrane cap →  35.
2. Pour approx. 7 ml (0.24 fl.oz) Fill the membrane cap with electrolyte until it is level with the start of the internal thread.
3. Slowly screw on membrane cap up to the stop . This will cause excess electrolyte to be displaced at the valve and thread.
4. If necessary, pat the sensor and membrane cap dry using a cloth.
5. Reset operating hours counter for electrolyte on transmitter. For detailed information, see Operating Instructions for transmitter.

9.2.3 Replacing membrane cap

1. Remove sensor from flow assembly →  32.
2. Remove membrane cap →  35.
3. Pour fresh electrolyte into the new membrane cap until it is level with the start of the internal thread.
4. Check if the sealing ring is mounted in the membrane cap.
5. Screw new membrane cap onto sensor shaft →  36.
6. Screw on membrane cap until the membrane at the working electrode is slightly overstretched (1 mm (0.04 in)).
7. Reset operating hours counter for membrane cap on transmitter. For detailed information, see Operating Instructions for transmitter.

Remove membrane cap

- ▶ Carefully rotate membrane cap and remove.

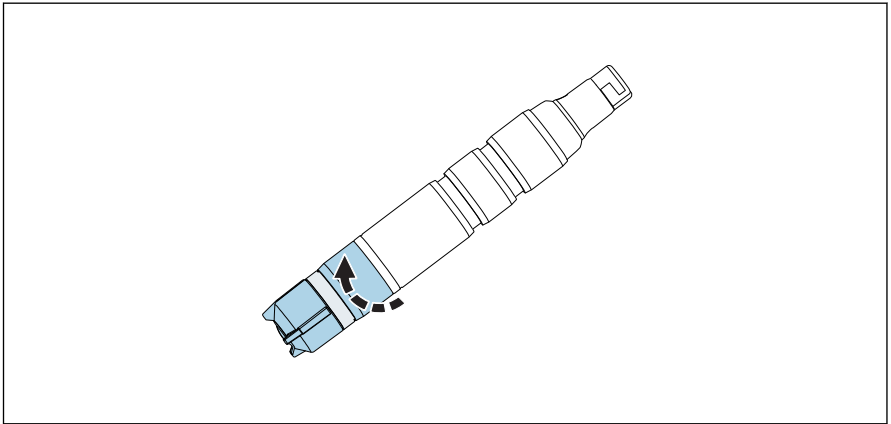

A0034406

- ▣ 14 Carefully rotate membrane cap.

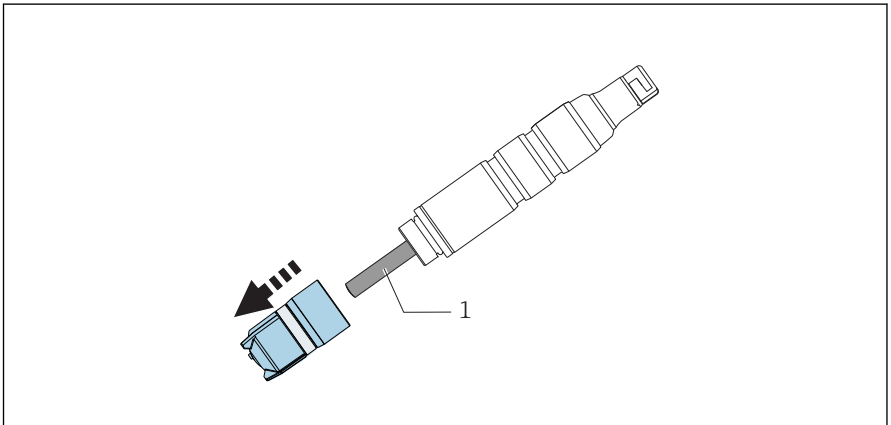

A0034406

- ▣ 15 Carefully remove membrane cap.

1 Electrode body

Screw membrane cap onto sensor

- ▶ Screw membrane cap onto sensor shaft: hold sensor by the shaft. Keep valve clear.

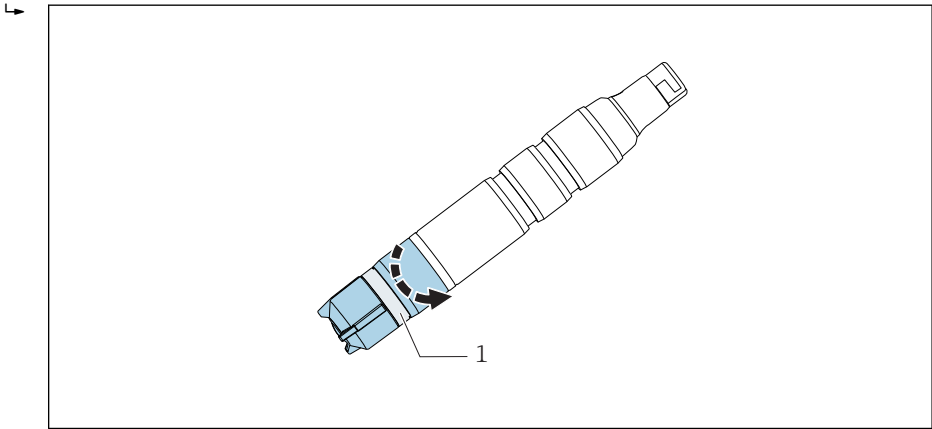

A0034480

 16 Screw on membrane cap: keep pressure relief valve clear.



1 Pressure relief valve

9.2.4 Storing the sensor

If measurement is suspended for a short period of time and it can be guaranteed that the sensor will be kept moist while in storage:

1. If the assembly is guaranteed not to empty out, you may leave the sensor in the flow assembly.
2. If there is a possibility that the assembly may empty out, remove sensor from assembly.
3. To keep the membrane moist after the sensor has been removed, refill the protection cap with electrolyte or clean water.
4. Fit protection cap on sensor →  37.

During longterm interruptions to measurement, particularly if dehydration is possible:

1. Remove sensor from assembly.
2. Clean sensor shaft and membrane cap with cold water and leave to dry.
3. Loosely screw on membrane cap up to the stop. This ensures that the membrane remains slack.
4. Pour electrolyte or clean water into protection cap and attach →  36.
5. For recommissioning, follow the same procedure as for commissioning →  27.

 Ensure that no biofouling occurs during longer interruptions to measurement. Remove continuous organic deposits such as films of bacteria.

Fitting the protection cap on the sensor

1. To keep the membrane moist after the sensor has been removed, fill the protection cap with some electrolyte or clean water.

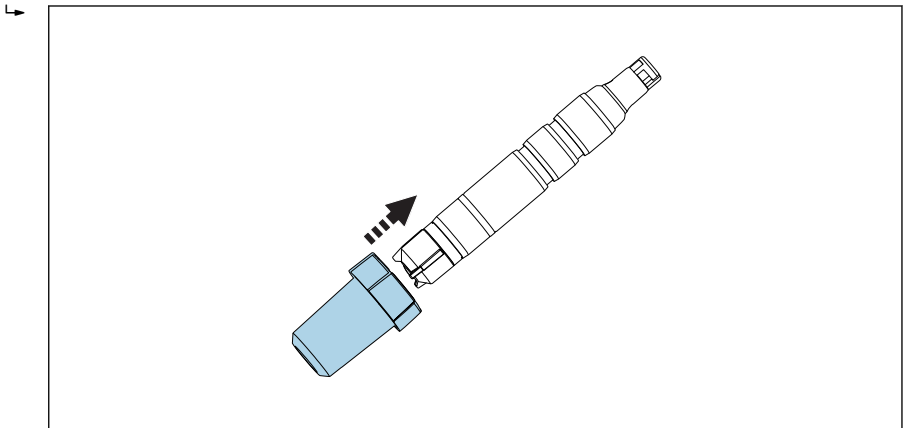

A0034264

 17 Carefully slide protection cap onto the membrane cap.

2. Top part of protection cap is in the open position. Carefully slide protection cap onto the membrane cap.
3. Secure protection cap by rotating the top part of the protection cap.

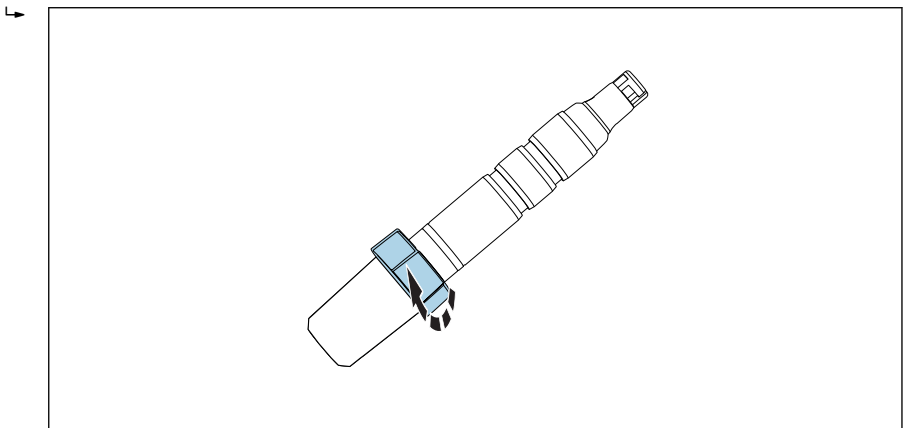

A0034494

 18 Securing protection cap by rotating the top part

9.2.5 Regenerating the sensor

During measurement, the electrolyte in the sensor is gradually exhausted due to chemical reactions. The gray-brown silver chloride layer that is applied to the anode at the factory continues to grow during sensor operation. However, this has no effect on the reaction taking place at the cathode.

A change in the color of the silver chloride layer indicates an effect of the reaction that is taking place. Carry out a visual inspection to ensure that the gray-brown color of the anode has not changed. If the color of the anode has changed, e.g. if it is spotted, white or silvery, the sensor must be regenerated.

- ▶ Send the sensor to the manufacturer for regeneration.

10 Repair

10.1 Spare parts

For more detailed information on spare parts kits, please refer to the "Spare Part Finding Tool" on the Internet:

www.endress.com/spareparts_consumables

10.2 Return

The product must be returned if repairs or a factory calibration are required, or if the wrong product was ordered or delivered. As an ISO-certified company and also due to legal regulations, Endress+Hauser is obliged to follow certain procedures when handling any returned products that have been in contact with medium.

To ensure the swift, safe and professional return of the device:

- ▶ Refer to the website www.endress.com/support/return-material for information on the procedure and conditions for returning devices.

10.3 Disposal

The device contains electronic components. The product must be disposed of as electronic waste.

- ▶ Observe the local regulations.

11 Accessories

The following are the most important accessories available at the time this documentation was issued.

- ▶ For accessories not listed here, please contact your Service or Sales Center.

11.1 Maintenance kit CCV05

Order according to product structure

- 2 x membrane caps and 1 x electrolyte 50 ml (1.69 fl.oz)
- 1 x electrolyte 50 ml (1.69 fl.oz)
- 2 x sealing set

11.2 Device-specific accessories

Memosens data cable CYK10

- For digital sensors with Memosens technology
- Product Configurator on the product page: www.endress.com/cyk10



Technical Information TI00118C

Memosens data cable CYK11

- Extension cable for digital sensors with Memosens protocol
- Product Configurator on the product page: www.endress.com/cyk11



Technical Information TI00118C

Memosens laboratory cable CYK20

- For digital sensors with Memosens technology
- Product Configurator on the product page: www.endress.com/cyk20

Flowfit CCA151

- Flow assembly for chlorine dioxide sensors
- Product Configurator on the product page: www.endress.com/cca151



Technical Information TI01357C

Flowfit CCA250

- Flow assembly for chlorine and pH/ORP sensors
- Product Configurator on the product page: www.endress.com/cca250



Technical Information TI00062C

Flexdip CYA112

- Immersion assembly for water and wastewater
- Modular assembly system for sensors in open basins, channels and tanks
- Material: PVC or stainless steel
- Product Configurator on the product page: www.endress.com/cya112



Technical Information TI00432C

Photometer PF-3

- Compact hand-held photometer for determining free available chlorine
- Color-coded reagent bottles with clear dosing instructions
- Order No.: 71257946

Kit adapter CCS5xD for CCA151

- Clamping ring
- Thrust collar
- O-ring
- Order No. 71372027

Adapter kit CCS5x(D) for CCA250

- Adapter incl. O-rings
- 2 studs for locking in place
- Order No. 71372025

Adapter kit CCS5x(D) for CYA112

- Adapter incl. O-rings
- 2 studs for locking in place
- Order No. 71372026

COY8

Zero-point gel for oxygen and chlorine sensors

- Oxygen-free and chlorine-free gel for the verification, zero point calibration and adjustment of oxygen and chlorine measuring points
- Product Configurator on the product page: www.endress.com/coy8



Technical Information TI01244C

12 Technical data

12.1 Input

12.1.1 Measured values

Chlorine dioxide (ClO ₂)	[mg/l, µg/l, ppm, ppb]
Temperature	[°C, °F]

12.1.2 Measuring ranges

CCS50D-**11AD	0 to 5 mg/l (ppm) ClO ₂
CCS50D-**11BF	0 to 20 mg/l (ppm) ClO ₂
CCS50D-**11CJ	0 to 200 mg/l (ppm) ClO ₂

12.1.3 Signal current

CCS50D-**11AD	135 to 250 nA per 1 mg/l (ppm) ClO ₂
CCS50D-**11BF	35 to 65 nA per 1 mg/l (ppm) ClO ₂
CCS50D-**11CJ	4 to 8 nA per 1 mg/l (ppm) ClO ₂

12.2 Performance characteristics

12.2.1 Reference operating conditions

Temperature	20 °C (68 °F)
pH value	pH 6 to 7
Flow	40 to 60 cm/s
ClO ₂ -free base medium	Deionized water

12.2.2 Response time

T₉₀ < 15 s (after completing polarization)

12.2.3 Measured value resolution of sensor

CCS50D-**11AD	0.03 µg/l (ppb) ClO ₂
CCS50D-**11BF	0.13 µg/l (ppb) ClO ₂
CCS50D-**11CJ	1.1 µg/l (ppb) ClO ₂

12.2.4 Measured error⁴⁾

±2 % or ±5 µg/l (ppb) of value measured (depending on which value is higher)

	LOD (limit of detection)	LOQ (limit of quantification)
CCS50D-**11AD	0.0007 mg/l (ppm)	0.002 mg/l (ppm)
CCS50D-**11BF	0.0013 mg/l (ppm)	0.004 mg/l (ppm)
CCS50D-**11CJ	0.0083 mg/l (ppm)	0.025 mg/l (ppm)

12.2.5 Repeatability

CCS50D-**11AD	0.002 mg/l (ppm)
CCS50D-**11BF	0.007 mg/l (ppm)
CCS50D-**11CJ	0.025 mg/l (ppm)

12.2.6 Nominal slope

CCS50D-**11AD	195 nA per 1 mg/l (ppm) ClO ₂
CCS50D-**11BF	50 nA per 1 mg/l (ppm) ClO ₂
CCS50D-**11CJ	6 nA per 1 mg/l (ppm) ClO ₂

4) Based on ISO 15839. The measured error includes all the uncertainties of the sensor and transmitter (measuring chain). It does not contain all the uncertainties caused by the reference material and adjustments that may have been performed.

12.2.7 Long-term drift

< 1 % per month (mean value, determined while operating at varying concentrations and under reference conditions)

12.2.8 Polarization time

Initial commissioning 60 min
 Recommissioning 30 min

12.2.9 Operating time of the electrolyte

at maximum concentration and 55 °C 60 days
 at 50 % of measuring range and 20 °C 1 year
 at 10 % of measuring range and 20 °C 2 years

12.3 Environment

12.3.1 Ambient temperature range

-20 to 60 °C (-4 to 140 °F)

12.3.2 Storage temperature

	Longterm storage	Storage up to max 48 h
With electrolyte	0 to 35 °C (32 to 95 °F) (non-freezing)	35 to 50 °C (95 to 122 °F)
Without electrolyte	-20 to 60 °C (-4 to 140 °F)	

12.3.3 Degree of protection

IP68 (1.8 m (5.91 ft)) water column over 7 days at 20 °C (68 °F)

12.4 Process

12.4.1 Process temperature

0 to 55 °C (32 to 130 °F), non-freezing

12.4.2 Process pressure

The inlet pressure depends on the specific fitting and installation.

The measurement can take place with a free outlet.

The medium pressure directly upstream from the sensor membrane must not exceed 1 bar (14.5 psi) abs.

- In terms of sensor condition and performance, it is essential that the flow velocity limits specified in the following table be observed.

	Flow velocity [cm/s]	Volume flow [l/h]		
		Flowfit CCA250	Flowfit CCA151	FlexdipCYA112
Minimum	15	30	5	The sensor is suspended freely in the medium; pay attention to the minimum flow velocity of 15 cm/s during installation.
Maximum	80	145	20	

12.4.3 pH range

Stability range of chlorine dioxide (ClO₂) pH 2 to 10⁻¹)

Calibration pH 4 to 8

Measurement pH 4 to 9

From pH values > 9, ClO₂ is unstable and decomposes.

- 1) Up to pH 3.5 and in the presence of chloride ions (Cl⁻), free chlorine is produced and included in the measurement

12.4.4 Flow

At least 5 l/h (1.3 gal/h), in the Flowfit CCA151 flow assembly

At least 30 l/h (7.9 gal/h), in the Flowfit CCA250 flow assembly

12.4.5 Minimum flow

At least 15 cm/s (0.5 ft/s) , e.g. with Flexdip CYA112 immersion assembly

12.5 Mechanical construction

12.5.1 Dimensions

→  16

12.5.2 Weight

Sensor with membrane cap and electrolyte (without protection cap and without adapter)

Approx. 95 g (3.35 oz)

12.5.3 Materials

Sensor shaft	PVC
Membrane	PVDF
Membrane cap	PVDF
Protection cap	<ul style="list-style-type: none"> ■ Vessel: PC Makrolon (polycarbonate) ■ Seal: Kraiburg TPE TM5MED ■ Cover: PC Makrolon (polycarbonate)
Sealing ring	FKM

12.5.4 Cable specification

max. 100 m (330 ft), incl. Cable extension

13 Installation and operation in hazardous environment Class I Div. 2

Non-sparking device for use in specified hazardous environment in accordance with:

- cCSAus Class I Div. 2
- Gas group A, B, C, D
- Temperature class T6, $-5\text{ °C (23 °F)} < T_a < 55\text{ °C (131 °F)}$
- Control drawing: 401204

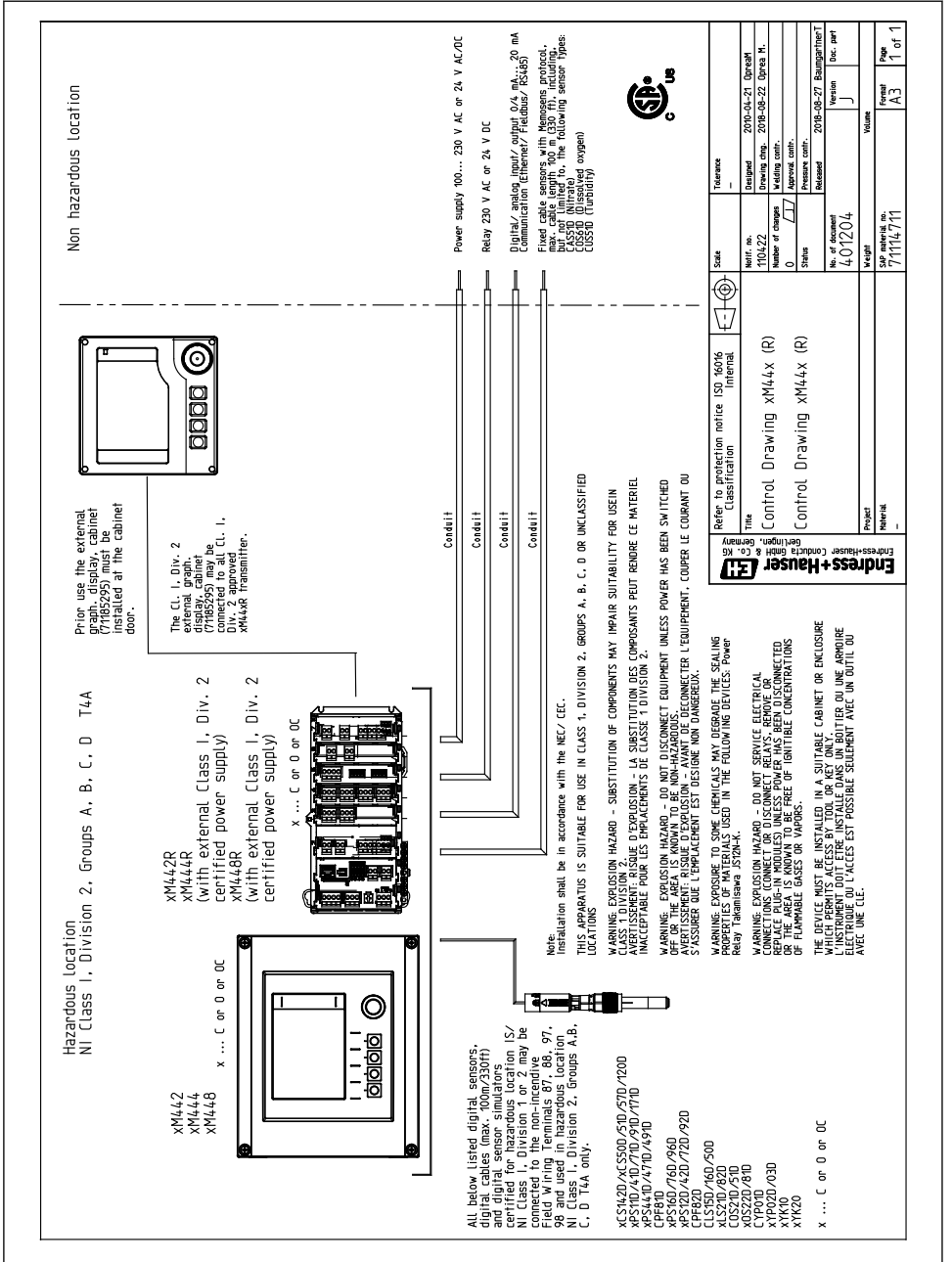

Index

A

- Accessories 40
- Ambient temperature range 44

C

- Cable specification 45
- Check
 - Connection 26
 - Function 27
 - Installation 24
- Cleaning 32
- Connection
 - Check 26
 - Ensuring the degree of protection 25

D

- Declaration of conformity 14
- Degree of protection
 - Ensuring 25
 - Technical data 44
- Designated use 6
- Device description 8
- Diagnostics 29
- Disposal 39

E

- Effect on the measured signal
 - Flow 9
 - pH value 9
 - Temperature 10
- Electrical connection 25
- Environment 44
- Ex approvals 14

F

- Flow 9, 45
- Flow assembly 22, 23
- Function check 27

I

- Immersion assembly 23
- Incoming acceptance 13
- Installation
 - Check 24
 - Flow assembly 22

- Immersion assembly 23
- Installation position 15
- Sensor 17
- Installation position 15

L

- Long-term drift 44

M

- Maintenance schedule 31
- Maintenance tasks 32
- Materials 45
- Maximum measured error 43
- Measured signal 9
- Measured value resolution 43
- Measured values 41
- Measuring principle 8
- Measuring ranges 41
- Measuring system 17
- Minimum flow 45
- Mounting instructions 15

N

- Nameplate 13
- Nominal slope 43

O

- Operating principle 8
- Operating time of the electrolyte 44

P

- Performance characteristics 43
- pH range 45
- pH value 9
- Polarization time 44
- Post-installation check 27
- Process 44
- Process pressure 44
- Process temperature 44

R

- Reference operating conditions 43
- Regeneration 37
- Repair 39
- Repeatability 43
- Response time 43

Return 39

S

Safety instructions 6

Scope of delivery 14

Sensor

Calibration 27

Cleaning 32

Connecting 25

Mounting 17

Polarization 27

Regenerating 37

Storage 36

Spare parts 39

Storage 36

Storage temperature 44

Symbols 4

T

Technical data

Environment 44

Input 41

Mechanical construction 45

Performance characteristics 43

Process 44

Temperature 10

Troubleshooting 29

U

Use 6

W

Warnings 4

Weight 45



71431040

www.addresses.endress.com
