



M-Series® M4000

Electromagnetic Flow Meter, Class 1, Division 1 Environments



MAG-UM-00159-EN-05 (June 2018)

User Manual



CONTENTS

Safety Precautions and Instructions	5
Unpacking and Inspection	5
Rigging, Lifting and Moving Large Units	5
System Description	9
Empty Pipe Detection	9
Amplifier Mounting Configuration Options	9
Meter/Amplifier Location, Orientation and Applications	10
Remote Amplifier Outdoor Location	10
Temperatures	10
Pipelines and Fluid Flow Conditions	10
Meter Orientation	11
Straight Pipe Requirements	11
Pipe Reducer Requirements	12
Chemical Injection Applications	12
Partially Filled Pipe Situations	12
Meter Gaskets and Grounding	13
Meter Installation Plans and Execution	15
Remote Mount Amplifier	15
Remote Mount Amplifier/Detector Wiring	16
Output Wiring	20
Output Wire Connections	20
Amplifier Output Wire Terminal Block Connections	21
Auxiliary Input Wiring Diagram	21
Analog Output Wiring Diagram	21
External Disconnect	22
AC/DC Power Wiring	22
Adjustable Display/Control Card	23
Programming the M4000	25
Display and Controls	25
M4000 Menu Structure	27
Programming Practice—Understanding the Main Screen	29
Programming Practice—Navigating the Menus	30
Programming the Required Parameters	33

Maintenance	44
Flow Tube and Electrode Cleaning	44
Fuse Replacement	44
Amplifier Printed Circuit Board (PCB) Stack Replacement	46
Specifications	48
Amplifier	49

SAFETY PRECAUTIONS AND INSTRUCTIONS

Safety considerations are emphasized by the placement of safety symbol icons on the product or next to important text, pictures or drawings throughout this manual. The symbols are:

Symbol	Explanation
	When and where this symbol is attached to the product, it indicates a potential hazard. It means that documentation must be consulted to determine the nature of the potential hazard and any actions that need to be taken.
	Warning indicates the potential for severe personal injury, death or substantial property damage. Comply with the instructions and proceed with care.
	Caution indicates the potential for minor personal injury or property damage. Comply with the instructions and proceed with care.

Unpacking and Inspection

Follow these guidelines when unpacking the M-Series equipment.

- If a shipping container shows any sign of damage, have the shipper present when you unpack the meter.
- Follow all unpacking, lifting and moving instructions associated with the shipping container.
- Open the container and remove all packing materials. Store the shipping container and packing materials in the event the unit needs to be shipped for service.
- Verify that the shipment matches the packing list and your order form.
- Inspect the meter for any signs of shipping damage, scratches, or loose or broken parts.

NOTE: If the unit was damaged in transit, it is your responsibility to request an inspection report from the carrier within 48 hours. You must then file a claim with the carrier and contact Badger Meter for appropriate repairs or replacement.

- All detectors with PTFE liners are shipped with a liner protector to maintain proper form of the PTFE material during shipping and storage.

NOTE: Do not remove the liner protectors until you are ready to install.

- Storage: If the meter is to be stored, place it in its original container in a dry, sheltered location. Storage temperature ranges are: -4...158° F (-20...70° C).

Rigging, Lifting and Moving Large Units

CAUTION

WHEN RIGGING, LIFTING OR MOVING LARGE UNITS, FOLLOW THESE GUIDELINES:

- DO NOT lift or move a meter by its amplifier, junction box or cables.
- Use a crane rigged with soft straps to lift and move meters with flow tubes that are between two inches and eight inches (50 mm and 200 mm). Place the straps around the detector body, between the flanges, on each side of the detector.
- Use the lifting lugs when lifting meter flow tubes that are 10 inches (250 mm) in diameter or larger.

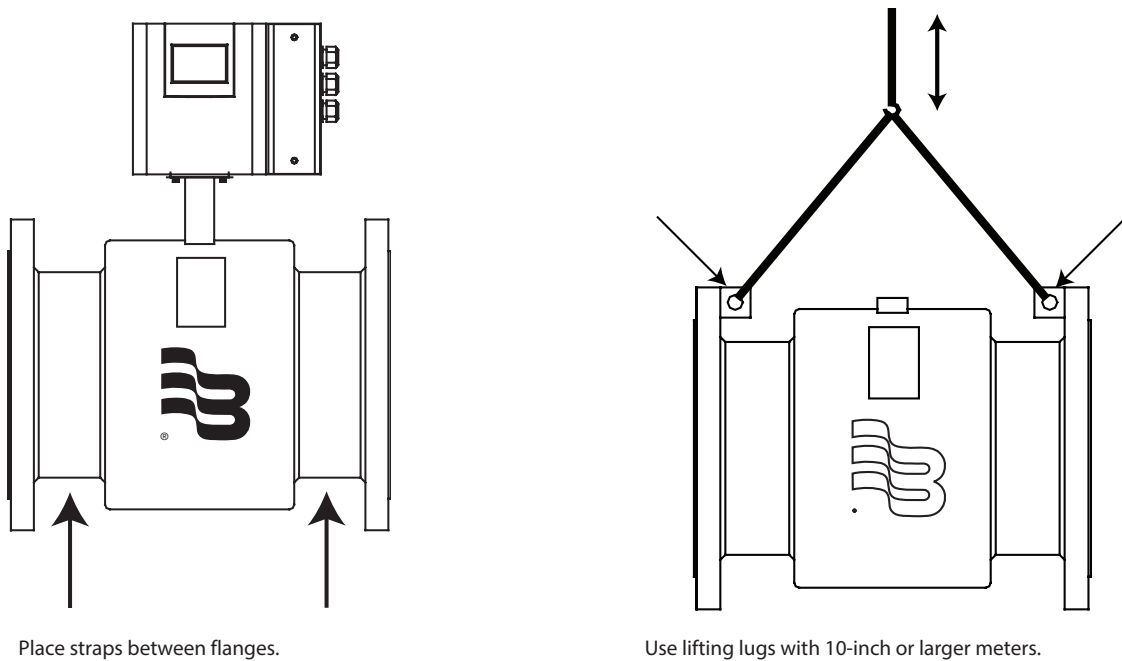

Figure 1: Rigging large units

- Use the sling-rigged method to lift large detectors into a vertical position while they are still crated. Use this method to position large detectors vertically into pipelines.

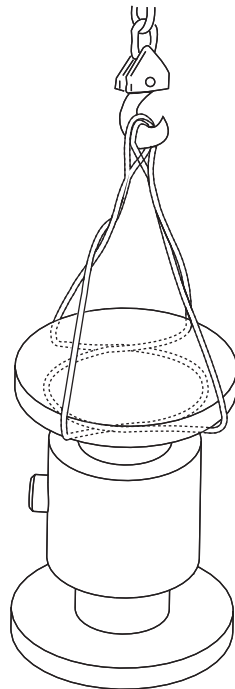
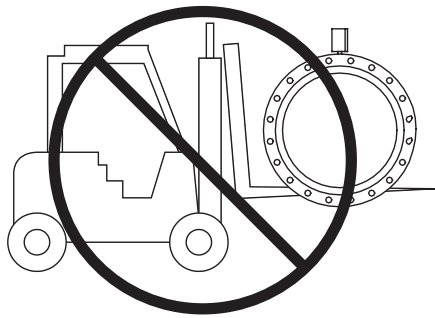
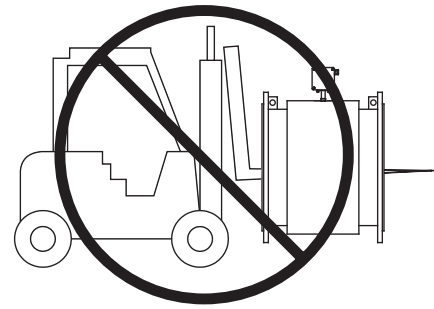

Figure 2: Sling-rigged lifting methods

- Do not lift a detector with a forklift by positioning the detector body on the forks, with the flanges extending beyond the lift. This could dent the housing or damage the internal coil assemblies.
- Never place forklift forks, rigging chains, straps, slings, hooks or other lifting devices inside or through the detector's flow tube to hoist the unit. This could damage the isolating liner.



Do not lift detector with forklift.



Do not lift or rig lifting devices through detector.

Figure 3: Lifting and rigging cautions

Instructions Specific to Hazardous Area Installations

These instructions apply to equipment covered by FM Certificate Number 3015930.

- The temperature range for fluids passing through the detector is $-4\dots248^{\circ}\text{F}$ ($-20\dots120^{\circ}\text{C}$).
- The ambient temperature range surrounding the amplifier is $-4\dots122^{\circ}\text{F}$ ($-20\dots50^{\circ}\text{C}$).
- The ambient temperature range surrounding the junction box must not exceed 122°F (50°C).
- During any installation or repair, perform all procedures in accordance with the applicable code of practice.
- Suitably trained personnel shall perform all installation or repair procedures.
- If the equipment is likely to come into contact with aggressive substances, it is the responsibility of the user to take suitable precautions that prevent it from being adversely affected, thus ensuring that the type of protection is not compromised.
 - ◊ **Aggressive Substances** such as acidic liquids or gases that may attack metals, or solvents that may affect polymeric materials.
 - ◊ **Suitable Precautions** are regular checks as part of routine inspections or establishing, from the material's data sheet, that it is resistant to specific chemicals.

Additional Information

Certification markings are noted on the product label. Markings include:

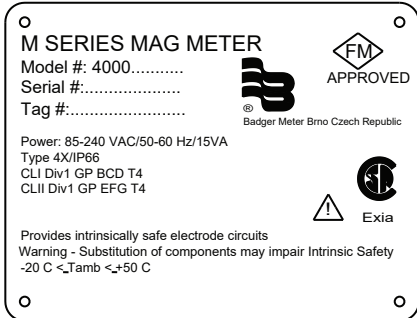

Figure 4: Mounted amplifier 85...240V AC

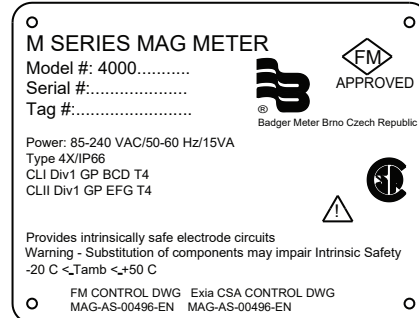

Figure 5: Remote mount 85...240V AC

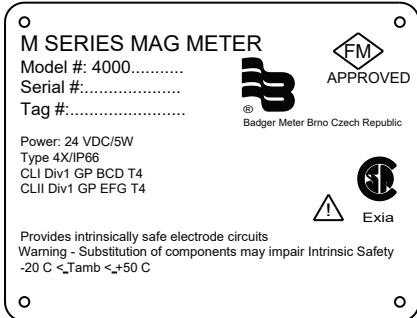

Figure 6: Mounted amplifier 24V DC

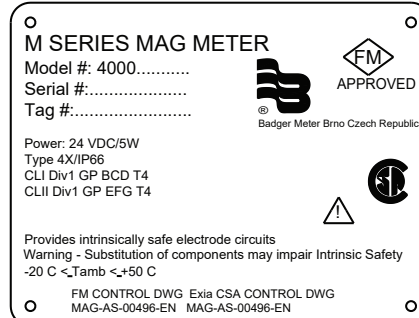

Figure 7: Remote mount 24V DC

NOTE: Table 1 below refers to the data plate codes per the configured meter order. The data plate code string follows the model number on the data plate.

A = Mounting Type	M	Meter mount
	R	Remote mount
B = Liner Material	R	Hard rubber
	T	PTFE
C = Electrodes	H	Alloy C
	S	316 stainless steel
	G	Gold/platinum
	T	Tantalum
	R	Platinum/rhodium
D = End Flange	D	DIN flange
	S	SAE flange
E = Entry	M	Metric
	N	NPT
F = Number of Electrodes	T	Three
	F	Four
G = Detector Size (DN Size MM)	6, 8, 10, 15 and so on	
H = Voltage	H	110/220V AC
	L	24V DC

Table 1: Data plate codes

Contact Badger Meter for information on the dimensions of the flameproof joints.

For additional information regarding importation, equipment installation, equipment repair, equipment return or renewal parts, contact:

Badger Meter, Inc.

P.O. Box 245036

Milwaukee, WI 53222

Telephone: (414) 355-0400 or (800) 876-3837

On the Web: www.badgermeter.com or contact your local Badger Meter representative.

SYSTEM DESCRIPTION

The Badger Meter M-Series® model M4000 electromagnetic flow meters are FM approved for Class I, Div 1 hazardous locations. To achieve hazardous location ratings electrodes in the flow tube are Intrinsically Safe, designed according to Factory Mutual (FM) standards. Those standards limit the amount of energy that can be sent to electrodes to prevent a spark from occurring.

Empty Pipe Detection

Badger Model M4000 meters are equipped with an Empty Pipe Detection feature. Empty Pipe Detection is accomplished by positioning a third electrode close to the 12 o'clock position. Any time this electrode is not covered by fluid, for a minimum of five seconds, the meter displays an Empty Pipe Detection condition, sends out an error message if desired, and stops measuring to maintain accuracy. When the electrode is again covered with fluid, the error message disappears and the meter continues measuring.

Amplifier Mounting Configuration Options

Two amplifier-mounting configuration options are available to meet a variety of meter placement and environmental conditions.

Meter Mount Configuration

The Meter Mount configuration has the amplifier mounted directly on the detector. This compact, self-contained configuration minimizes installation wiring.

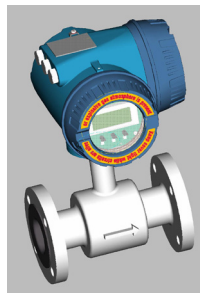

Figure 8: Meter mount

Remote Mount Configuration

- Remote Mount configuration places the amplifier and its functions at a location separate from the fluid flow and detector. This configuration is necessary in situations where process fluid temperature or environment exceeds amplifier ratings. A remote mounting bracket is supplied.
- The detector and amplifier are connected by wires, run through conduit, between junction boxes on the detector and remote mounted amplifier. The distance between the detector junction box and amplifier junction box can be up to 100 feet (30 m).
- This configuration can also provide a more convenient amplifier programming and display placement for monitoring meter readings.



Figure 9: Remote mount

METER/AMPLIFIER LOCATION, ORIENTATION AND APPLICATIONS

Remote Amplifier Outdoor Location

The amplifier can be installed and operated outdoors. However, it must be protected from the elements, as follows:

- The ambient environment/temperature rating for the unit is – 4...122° F (–20...50° C).
- If an indoor location is within 100 feet (30 meters) of the detector, consider increasing the cable length and mounting the amplifier indoors.
- At minimum, fabricate a roof or shield over and/or around the amplifier to protect the LCD display screen from direct sunlight.

Temperatures

To prevent meter damage in any environment, minimum and maximum temperature ranges must be observed.

- The ambient temperature range surrounding the amplifier is – 4...122° F (–20...50° C).
- The ambient temperature range surrounding a remote junction box mounted to the detector is – 4...248° F (–20...120° C).

Application	Fluid Temperature Range	Max. Ambient Temperature	Liner Materials
Remote amplifier	– 4...248° F (–20...120° C)	122° F (50° C)	PFA and PTFE
Remote amplifier	32...178° F (0...80° C)	122° F (50° C)	Hard rubber
Meter mounted amplifier	– 4...212° F (–20...100° C)	122° F (50° C)	PFA and PTFE
Meter mounted amplifier	32...178° F (0...80° C)	122° F (50° C)	Hard rubber

Pipelines and Fluid Flow Conditions

Pipeline and fluid flow conditions that should be avoided:

- Do not install the meter where extreme pipe vibrations exist. If vibrations are present, secure piping before and after the meter with appropriate pipe supports. If vibrations cannot be restrained, consider mounting the amplifier remotely.
- Avoid installing the detector close to pipeline valves, fittings or impediments that can cause flow disturbances.
- For detectors with PTFE liners, avoid installing the detector on suction sides of pumps.
- Avoid installing the detector on outlet sides of piston or diaphragm pumps. Pulsating flow can affect meter performance.
- Avoid locations near equipment producing electrical interference such as electric motors, transformers, variable frequency, and power cables.
- Verify both ends of the signal cables are securely fastened.
- Place power and signal cables in separate conduit.
- Place the meter where there is enough access for installation/maintenance purposes.

Meter Orientation

Mag meters can operate accurately in any pipeline orientation and can measure volumetric flow in forward and reverse directions.

NOTE: A Forward Flow direction arrow is printed on the detector label.

Vertical Placement

Mag meters attain optimal performance when placed vertically, with liquid flowing upward and meter electrodes in a closed, full pipe.

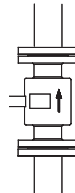

Figure 10: Vertical placement

Vertical placement allows the pipe to remain completely full, even in low flow, low pressure applications and it prevents any solids build-up or sediment deposit or accumulation on the liner and/or electrodes.

NOTE: Carefully observe the "Forward Flow" label on the meter body and install the meter accordingly.

Horizontal Placement

In a horizontal piping orientation, mount the detector to piping with the flow measuring electrode axis in a horizontal plane (3 and 9 o'clock).

This arrangement prevents solids build-up or sediment deposit or accumulation on the electrodes.

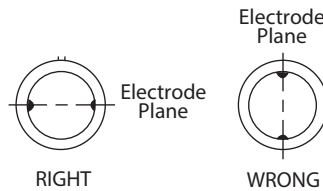

Figure 11: Horizontal placement

Straight Pipe Requirements

Sufficient straight pipe runs are required at the detector inlet and outlet for optimum meter accuracy and performance. An equivalent of three (3) diameters of straight pipe is required on the inlet (upstream) side. Two (2) diameters are required on the outlet (downstream) side.

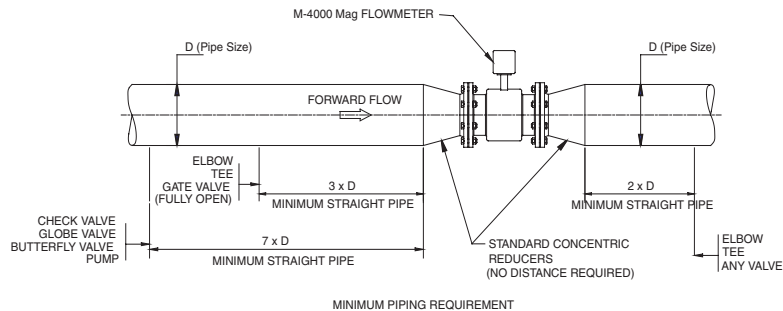

Figure 12: Minimum piping requirement

Pipe Reducer Requirements

With pipe reducers a smaller size meter can be mounted in larger pipelines. This arrangement may increase low flow accuracy. There are no special requirements for standard, concentric pipe reducers.

Custom fabricated pipe reducers must have an approximate slope angle of 15 degrees to minimize flow disturbances and excessive loss of head. If this angle is not possible, install the custom pipe reducers as if they were fittings and install the amount of straight pipe stated previously.

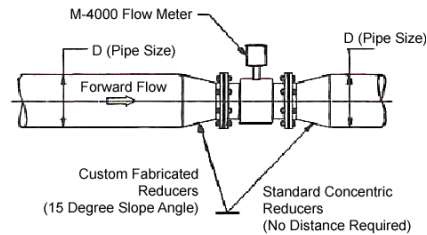

Figure 13: Pipe reducer requirements

Chemical Injection Applications

For water line applications with a chemical injection point, install the meter upstream of the injection point. This eliminates any meter performance issues.

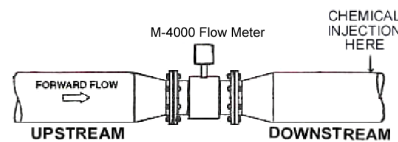

Figure 14: Meter installed upstream of chemical injection point

If a meter must be installed downstream of a chemical injection connection, the recommended distance between the meter and the injection point must be significant; 50...100 feet (15...30 meters). When the water/chemical solution reaches the meter it must be a complete, homogeneous mixture. If the injection point is too close, the meter senses two (2) different liquids (conductivity is different for each) and correct data output cannot be assured. The injection method: spaced bursts, continuous stream of drips, a liquid or gas can also affect downstream readings by the meter.

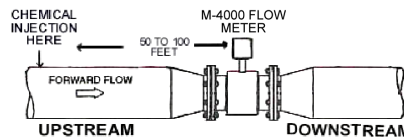

Figure 15: Meter installed downstream of chemical injection point

Sometimes it is difficult to specify the exact downstream placement distances because of the number of variables. Contact Badger Meter Technical Support, 877-243-1010, to review your application if necessary.

Partially Filled Pipe Situations

In some locations, the process pipe may be momentarily only partially filled. Examples include: lack of backpressure, insufficient line pressure and gravity flow applications.

To eliminate these situations, do not install the meter at the highest point of the pipeline.

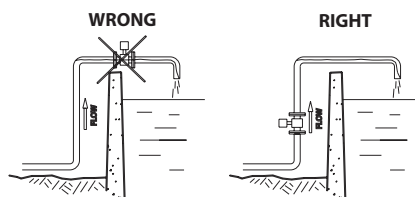

Figure 16: Meter placement in the pipeline

Do not install the meter in a vertical, downward flow section of pipe.
Always position the ON/OFF valves on the downstream side of the meter.

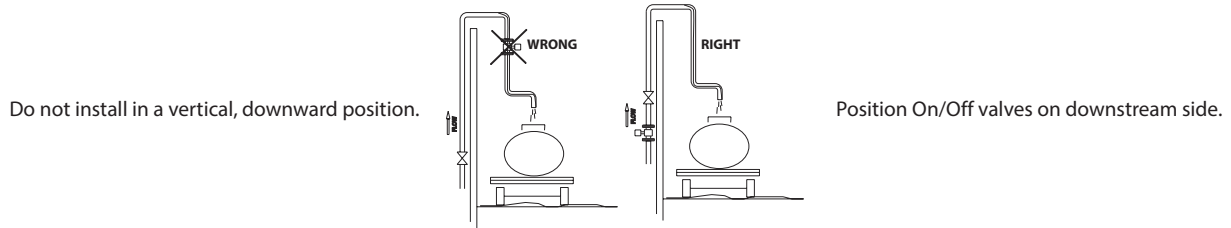

Figure 17: Position valves on downstream side

To minimize the possibility of partially-full pipe flows in horizontal, gravity or low pressure applications, create a pipe arrangement that ensures the detector remains full of liquid at all times.

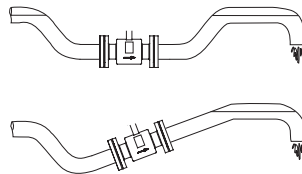

Figure 18: Pipe positioned to keep water in detector

Meter Gaskets and Grounding

Two other considerations to meter location, orientation and application are gasket and grounding requirements and placement.

Meter/Pipeline Connection Gaskets

Gaskets (not provided) must be installed between the detector isolating liner and the pipeline flange to ensure a proper and secure hydraulic seal. Use gaskets compatible with the fluid flow. Center each gasket on the flange to avoid flow restrictions or turbulence in the line.

Do not use graphite or any electrically conductive sealing compound to hold gaskets during installation. Measuring signal accuracy could be affected.

If a grounding ring is used in the detector/pipeline connection, place the ring between two gaskets. (See "Non-Conductive Pipe Grounding" on page 14.)

Meter Grounding

Process pipeline material can be either electrically conductive (metal) or not electrically conductive (made of or lined with PVC, fiberglass or concrete).

CAUTION

TO ENSURE PROPER UNIT OPERATION, THE MAG METER IMPACT GROUND (ZERO VOLTAGE REFERENCE) MUST BE CONNECTED TO THE LIQUID MEDIA AND TO A GOOD, SOLID EARTH GROUND. PERFORM GROUNDING PROCEDURES AFTER THE METER IS CONNECTED TO THE PIPELINE.

Conductive Pipe Grounding

A grounding bolt is located on each mag meter flange. Drill and tap the pipeline flanges on each side of the meter and install a grounding bolt to each.

To ground the unit, attach a ground strap (provided) of copper wire, at least 12 AWG size, between the grounding bolts on the meter flanges and the bolts on the pipeline flanges. Do this on the inlet and outlet sides of the meter.

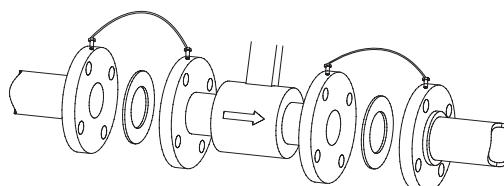

Figure 19: Conductive pipe grounding

Non-Conductive Pipe Grounding

If the process pipeline material is not electrically conductive and your meter was not ordered with an optional grounding electrode, place a grounding ring (available from Badger Meter) between two gaskets on both ends of the meter.

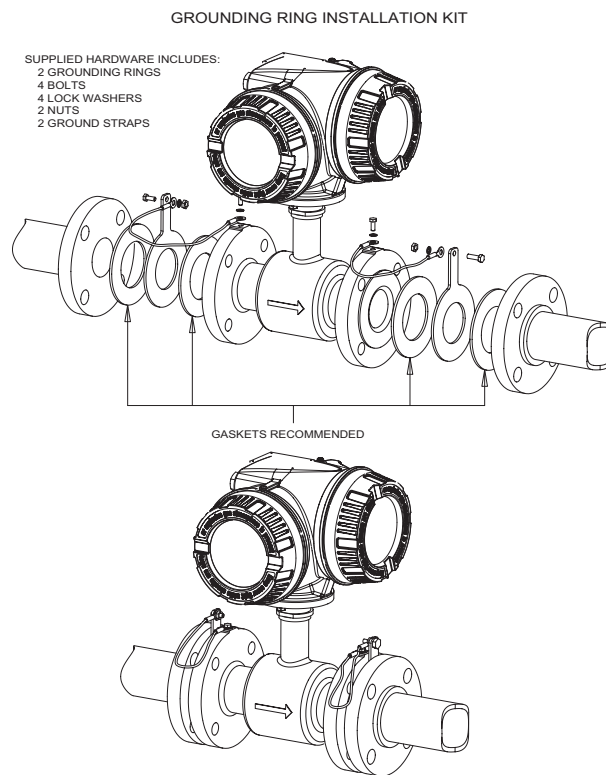

Figure 20: Non-conductive pipe grounding

After the grounding rings, gaskets and meter are assembled to the pipeline, attach ground straps (provided) of copper wire, at least 12 AWG size, to grounding bolts on meter flanges and to the grounding rings.

If your meter was ordered with an optional grounding electrode, the use of grounding rings is not necessary.

METER INSTALLATION PLANS AND EXECUTION

Plan meter layout, location and installation. During installation, remember these important points:

- Heed all safety notifications.
- Select a detector location with room for installation and maintenance procedures.
- Use proper lifting, rigging, moving and procedures for large units.
- Consider the meter environment; particularly ambient and process flow temperatures.
- Consider the process pipeline (vibrations) and its flow characteristics (valve and pump locations).
- Meter orientation to the pipeline (vertical or horizontal).
- Straight pipe requirements.
- Pipe reducer requirements.
- Special applications and/or situations.

For Remote Mount Units, consider:

- Amplifier location.
- Remote amplifier mounting bracket.
- Proper conduit and conduit fittings.
- Wiring and conduit locations.

Remote Mount Amplifier

NOTE: Screws are supplied to attach the remote mount bracket to the amplifier. Screws are not supplied to attach bracket at mounting location.

Remote Mount Amplifier Location Requirements

- A sturdy and safe mounting surface capable of holding the amplifier weight of 20 pounds (9 kg).
- Within the allowable temperature range: $-4 \dots 122^{\circ} \text{F}$ ($-20 \dots 50^{\circ} \text{C}$).
- Access to amplifier covers, ports, terminals, screen and adjustments.
- As close to the detector as possible.
- Determine length and route of cable and conduit runs.

Mount Bracket to Amplifier

1. Align bracket-mounting holes with amplifier mounting holes.
2. Attach bracket to amplifier with supplied screws. Torque the screws to 80 in.-lb.

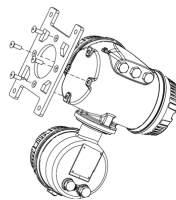

Figure 21: Mounting the bracket to the amplifier

Mount Amplifier with Bracket to Location

1. Position the amplifier with the bracket attached in the desired orientation.
2. Secure the bracket to the location.

Remote Mount Amplifier/Detector Wiring

Remote Mount Amplifier

The remote mount amplifier has three chambers and five wire ports. The junction box and connections chambers and wiring ports provide amplifier openings for wire, conduit, tool and hand access to amplifier terminal blocks. Detector to amplifier wires connect in the junction box chamber. Amplifier AC power and customer signal wires attach in the connections chamber. The Display/Programming Chamber provides access to fuses and circuit boards. See the Remote Mount Wiring Diagram.

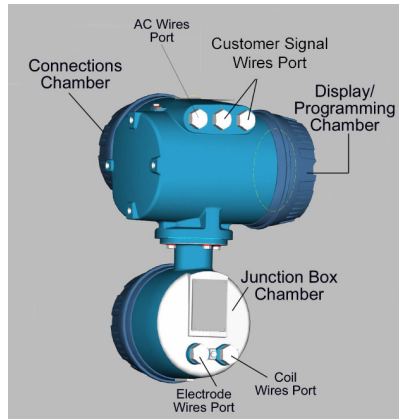

Figure 22: Remote mount amplifier

Detector Junction Box

The detector junction box has one chamber and two wire ports. The junction box, chamber and wiring ports provide openings for wire, conduit, tool and hand access to terminal blocks. Detector to remote mount amplifier electrode and coil wires connect to the detector through the chamber wire ports.

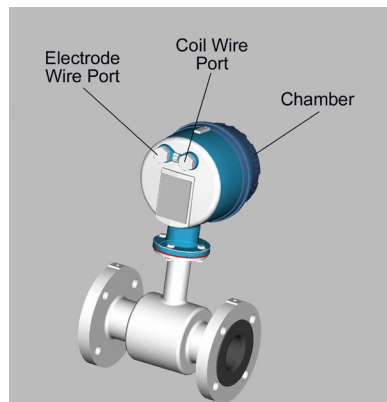

Figure 23: Detector junction box

⚠ WARNING

- **SUITABLY TRAINED PERSONNEL SHALL PERFORM ALL INSTALLATION OR REPAIR PROCEDURES.**
- **DISCONNECT POWER TO THE UNIT BEFORE ATTEMPTING ANY INSTALLATION OR MAINTENANCE.**
- **DO NOT BUNDLE OR ROUTE SIGNAL WIRES WITH POWER WIRES.**
- **USE PROPER CONDUIT, CONNECTIONS AND SUPPLIED CABLES IN ALL WIRING PROCEDURES.**
- **OBSERVE ALL LOCAL APPLICABLE ELECTRICAL CODES WHEN WIRING ANY EQUIPMENT.**

Electrode and Coil Wiring from Detector Junction Box to Remote Mount Amplifier Junction Box

A remote mount unit requires electrode and coil cables, from the detector junction box to the amplifier junction box, be enclosed in properly rated conduit. Use conduit fittings (not supplied) that are rated for Class I, Div 1 hazardous locations.

WARNING

FAILURE TO USE PROPER CONDUIT FITTINGS RATED FOR CLASS I, DIV 1 HAZARDOUS LOCATIONS, INVALIDATES THE FM RATING AND ANY WARRANTIES, EXPRESSED OR IMPLIED, FOR THIS EQUIPMENT.

1. Lay out the cable and conduit between the detector junction box and the amplifier junction box. Use Belden #9155 cable or equivalent for electrodes. Use Belden #8770 cable or equivalent for coils.
2. Run cables through the conduit, between detector junction box and amplifier junction box.
3. Place four NEMA 4X, 1/2" NPT fittings on conduit.
4. Remove the four junction box wire port screws, two on each junction box.

Electrode Wiring in Detector Junction Box

To connect electrode wires in the detector junction box:

1. Unscrew the detector chamber cover. If necessary, use a strap wrench.
2. Remove the protective plastic cover to access the terminal block screws.

NOTE: When wiring is complete, plastic cover must be reattached to maintain hazardous location rating.

3. Strip the cable jacket back 2" (50 mm).
4. Strip the 4 wires back 1/4" (6 mm).
5. Thread wires through the proper cable access.
6. Connect the wires to the compression-style screw terminals of the detector junction box.

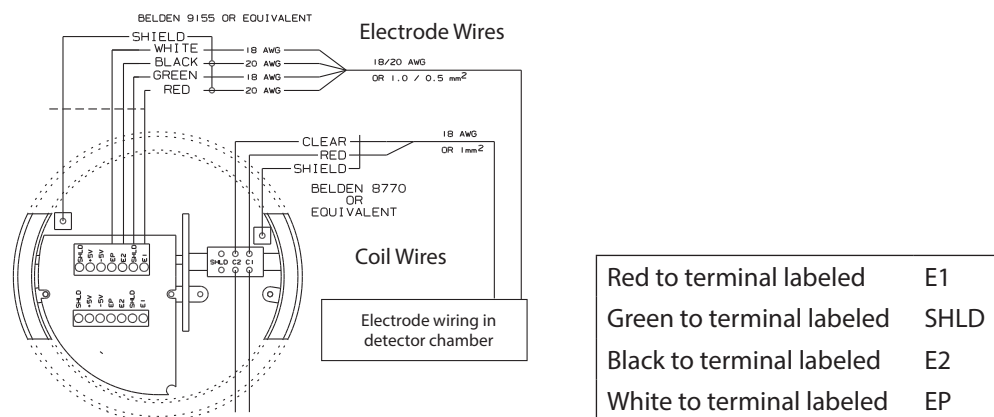

Figure 25: Electrode wiring in detector junction box

Cable length, between junction boxes may be up to 100 feet (30 m).

7. Run cable and conduit to amplifier junction box.

Electrode Wiring in Amplifier Junction Box

To connect the electrode wires in the amplifier junction box:

1. Unscrew the amplifier junction box chamber cover. If necessary, use a strap wrench.
2. Remove the protective plastic cover to access the terminal block screws.

NOTE: Plastic cover must be reattached when wiring is complete.

3. Strip the cable jacket back 2" (50 mm).
4. Strip the 4 wires back 1/4" (6 mm).
5. Thread the wires through the proper cable access. Connect the wires to the compression-style screw terminals of the amplifier junction box.

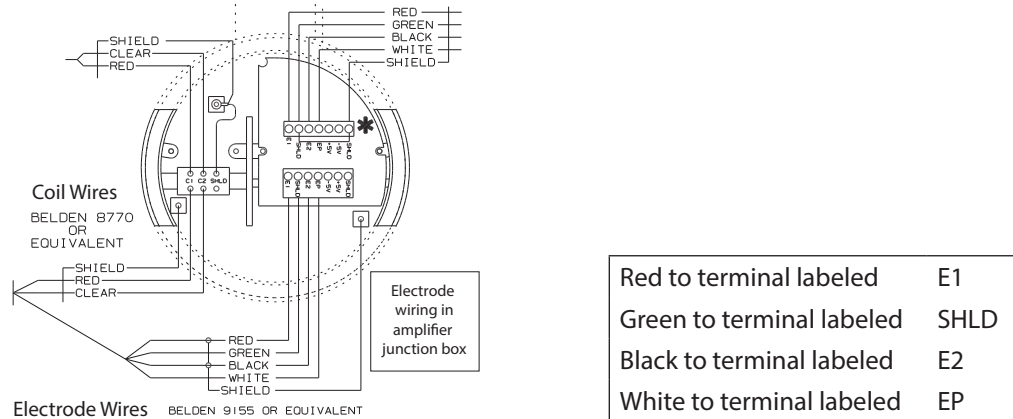

Figure 26: Electrode wiring in amplifier junction box

Coil Wiring in Detector Chamber

To connect coil wires in the Detector chamber:

1. Lay out the cable and conduit between the detector junction box and the amplifier junction box. Use Belden #8770 cable or equivalent for coils.

NOTE: When wiring is complete, plastic cover must be reattached to maintain hazardous location rating.

2. Strip the cable jacket back 2" (50 mm).
3. Strip the 2 wires back 1/4" (6 mm).
4. Thread the wires through the proper cable access. Connect the wires to the compression-style screw terminals of the detector chamber.

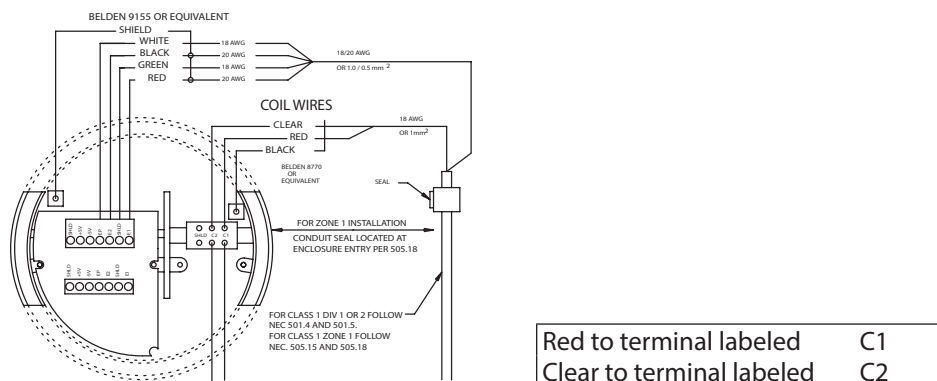

Figure 27: Coil wiring in detector chamber

5. Connect the conduit to the junction box. Use a NEMA 4X 1/2" NPT fitting.
6. Install a protective plastic cover over terminal blocks.
7. Attach the detector chamber cover.

Cable length between junction boxes may be up to 100 feet (30 m).

Coil Wiring in Amplifier Junction Box

To connect the coil wires in the amplifier junction box:

1. Strip the cable jacket back 2" (50 mm).
2. Strip the 2 wires back 1/4" (6 mm).
3. Connect the wires to the compression-style screw terminals of the amplifier junction box.

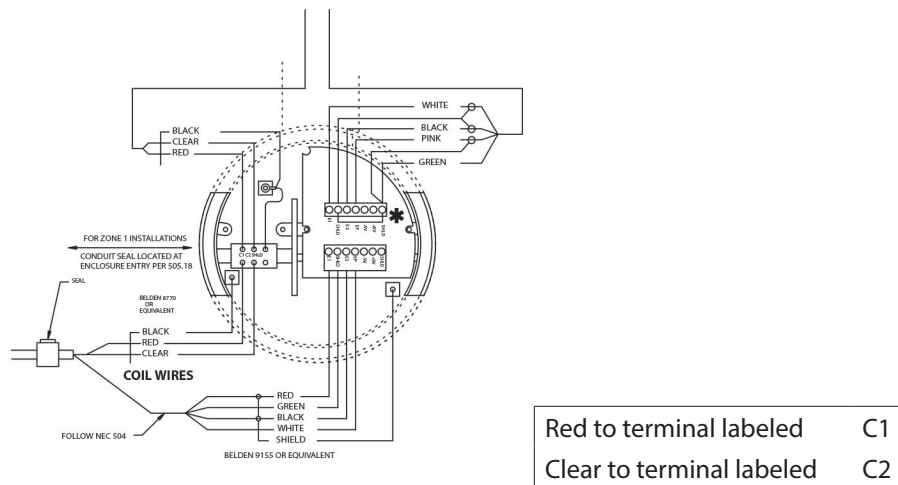

Figure 28: Coil wiring in amplifier junction box

4. Connect conduit to junction box. Use a NEMA 4X 1/2" NPT fitting.
5. Install protective plastic cover over terminal blocks.
6. Attach the amplifier junction box chamber cover.

Output Wiring

The M-Series M4000 meter converts liquid flow into electrical signals. With proper output wiring and amplifier programming, the signals are sent to, and used by, processing equipment used in operations or other procedures.

NOTE: Output wires and terminals are the same for meter mount or remote mount meters.

Output wiring requires 18 to 22 AWG maximum, shielded wire (not supplied). Signal wire insulation temperature class should exceed the maximum temperature where installed (typically, 185° F (85° C)).

Use conduit and conduit fittings (not supplied) rated for Class I, Div 1 hazardous locations.

Output Wire Connections

⚠ WARNING

- **PROPERLY TRAINED PERSONNEL MUST PERFORM ALL INSTALLATION AND/OR REPAIR PROCEDURES.**
- **DISCONNECT POWER TO THE UNIT BEFORE ATTEMPTING ANY INSTALLATION OR MAINTENANCE.**

To connect control signal wires:

1. Remove the connections chamber cover. If necessary, use a strap wrench.
2. Remove the two terminal block wire port access screws.
3. Connect output wires to processing equipment.
4. Group and place output wires in conduit. Position conduit at amplifier terminal block wire ports.
5. Connect conduit to control output signal wires ports.
6. Run output wires through wire ports, into amplifier terminal chamber.
7. Strip output wires back 1/4" (6 mm).
8. Connect output wires to terminals.

NOTE: Use twisted pair shielded wire for all output wiring—Belden #1266A or equivalent.

Amplifier Output Wire Terminal Block Connections

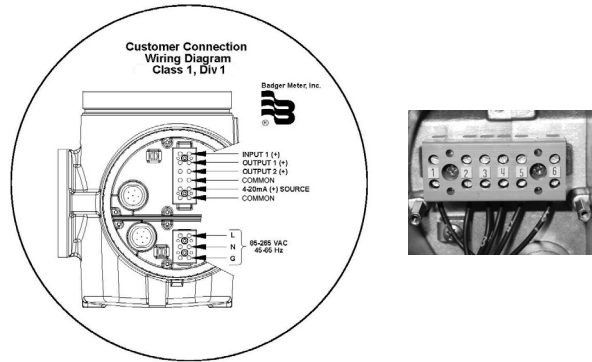

Figure 29: Amplifier output wire terminal block connections

Terminal	Identifier	Functions
1	Input 1 (+) Input	Reset, positive zero return
2	Output 1 (+)	Programmable passive output to Badger Meter external counter, forward pulse, frequency output, preset output, flow set point, error alarm, flow direction. Active output to external counter
3	Output 1 (+)	Programmable transistor output (open collector), passive output to Badger Meter external counter, forward pulse, AMR pulse, flow set point, error alarm, empty pipe, flow direction, active Output to external counter.
4	Common field ground	—
5	Analog output	—
6	Ground from external counter device connected to terminal 5	—

Auxiliary Input Wiring Diagram

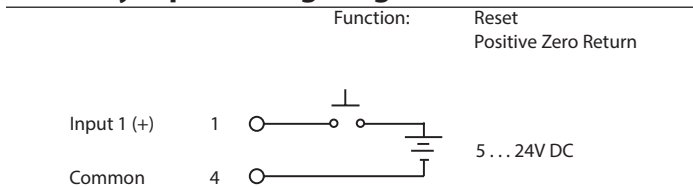

Figure 30: Auxiliary input wiring

Analog Output Wiring Diagram

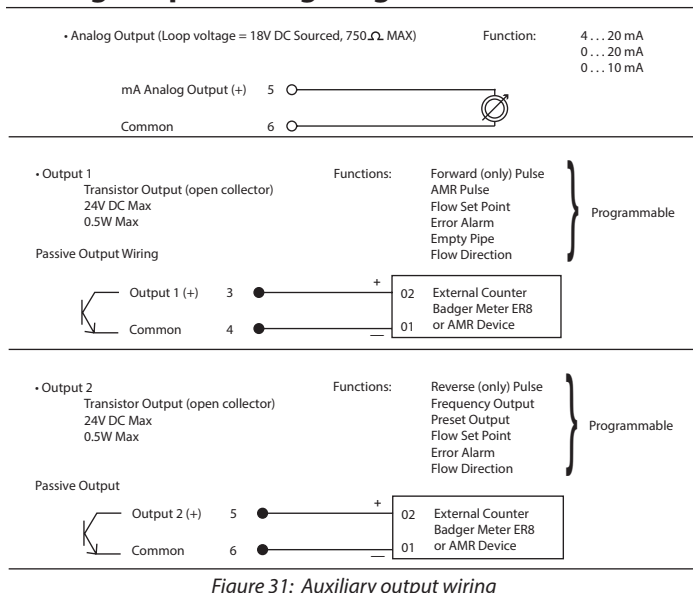

Figure 31: Auxiliary output wiring

External Disconnect

⚠ CAUTION

POSITION THIS DEVICE IN AN ACCESSIBLE LOCATION.

- Position and identify the disconnect device so as to provide safe and easy operation.
- Label the disconnect device as being for the Mag Meter.
- Install an external disconnect switch or circuit breaker that meets local standards.

AC/DC Power Wiring

- For AC power use three-wire, sheathed cable with cable diameter of 18 AWG (not supplied).
- AC wire insulation temperature class must not exceed the maximum ambient temperature of its location (typically, 185° F, 85° C).
- Use conduit and conduit fittings (not supplied) that are rated for Class I, Div 1 hazardous locations. To maintain a NEMA 4X rating, use watertight fittings that are rated NEMA 4X or better.

⚠ CAUTION

TO PREVENT ACCIDENTS, CONNECT MAIN POWER ONLY AFTER ALL OTHER WIRING HAS BEEN COMPLETED.

The amplifier is a microprocessor device. It is important that the power supply be as “clean” as possible. Avoid using power lines that feed heavy loads such as pumps and motors. If dedicated lines are not available, a filtering or isolation system may be required.

AC wiring is the same for meter mount and remote mount amplifiers.

1. Remove AC Wires Port screw from amplifier connections chamber.
2. Lay out AC cable and conduit to amplifier.
3. Place cable in conduit.
4. Strip AC cable back 2 inches (50 mm).
5. Strip AC wires back 1/4 inch (6 mm).
6. Attach AC wires to amplifier terminal.

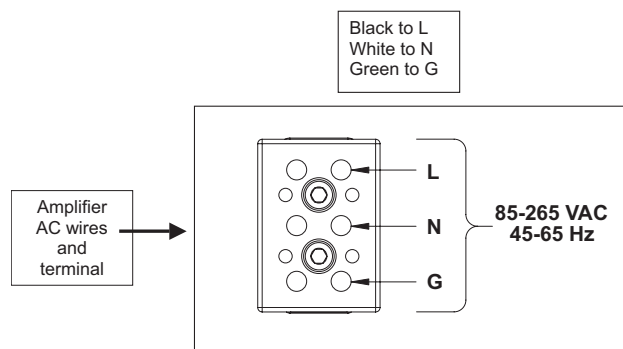

Figure 32: For AC wiring

7. Connect conduit to amplifier.
8. Attach chamber cover.

Adjustable Display/Control Card

Because meter positioning sometimes places the amplifier display/programming chamber in an awkward position, the display/control card is adjustable in 90-degree increments.

⚠ WARNING

DISCONNECT MAIN POWER TO THE UNIT BEFORE ATTEMPTING ANY DEVICE MAINTENANCE.



To re-position or rotate the display/control card in the amplifier:

1. Remove display chamber cover. Turn the cover counterclockwise to remove it from the amplifier. If necessary, use a strap wrench.



2. Remove the 2 card screws and washers.

NOTE: Use a split screwdriver to prevent dropping screw into enclosure.



3. Tilt card up and out approximately 45 degrees at the holding clips.



4. Gently pull card down and out from between the holding clips.



5. Rotate card to appropriate position.
6. Angle card and position card holes between the holding clips.



7. Push card in, between holding clips. Lower card back into position and attach card with screws and washers.



8. Attach the chamber cover.

PROGRAMMING THE M4000

The M4000 amplifier is pre-programmed from the factory, based on information available at the time the unit was ordered. In most instances, it will not require any changes.

The M4000 can be programmed to meter many flow situations and serve a variety of purposes during a production process. To meet diverse needs, there are a wide variety of programming options and parameters. Your metering requirements may not require the use of all program screens, options and parameters.

This section explains how to reprogram your meter to specific requirements.

NOTE: Flow measurement and totalizing continues during amplifier programming.

Display and Controls

The M4000 amplifier display/programming chamber contains a display/control card. This card and its display screen provide easy access to meter information and the ability to view, program, and adjust meter data parameters.

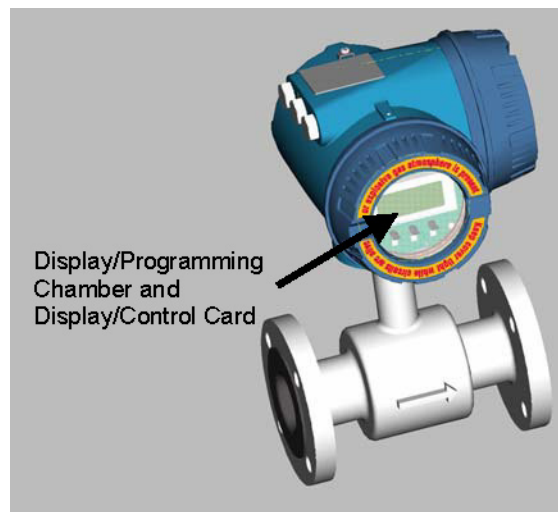

Figure 33: Display and controls location

Display

The M4000 uses a 2.5" x 1" (63 mm x 25 mm) four line, 16-character, backlit, LCD display.



Figure 34: Display

How to Use the Controls for Programming

All M4000 programming is accomplished using the three control *switches* or the three control *push buttons* located on the front of the amplifier in conjunction with an on-screen locator arrow. Use these controls to access menus, move from screen to screen, select parameters and settings, and enter values.

NOTE: If no contact is made with the control switches or buttons for 2 minutes, the display automatically returns to the *Main Screen*.

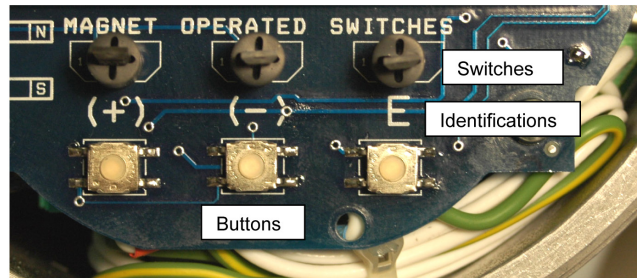
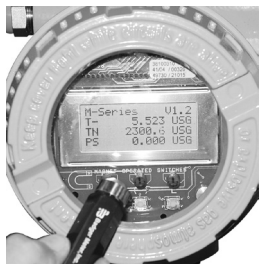

Figure 35: Controls

There are two ways to access the controls:



You can use a magnet wand to tap the + (plus), - (minus) and **E** switches. The amplifier display chamber cover stays on.



You can remove the display chamber cover and use your finger to tap the + (plus), - (minus) and **E** push buttons.

Figure 36: Accessing the controls

Tap + (plus) to:

- Move text up by one line, relative to the on-screen arrow, when selecting a parameter setting from a list.
- Increase a number by one digit when inputting parameter numeric settings.

Tap - (minus) to:

- Move text down by one line, relative to the on-screen arrow, when selecting a parameter setting from a list.
- Decrease a number by one digit when inputting parameter numeric settings.

Tap **E** to:

- Open a menu or sub-menu at which the arrow is pointing.
- Select between ON/OFF parameter settings.
- Move the parameter numeric setting underscore (_) one place to the right when inputting parameter numeric settings.
- Save a parameter numeric setting. After all numbers are input, tap **E** and the setting is saved, the screen closes and the previous screen with the arrow pointing at *Exit this Menu* shows again. Select **E** again. That screen closes and the previous screen opens with the arrow pointing at *Exit this Menu*. Continue selecting **E** to return to the Main Screen.

NOTE: If your amplifier *is not* password protected, tap **E** from the *Main Screen* to access the *Main Menu*. The *Main Menu* is a list that provides access to all amplifier menus and parameters.

NOTE: If your amplifier *is* password protected, tap **E** from the *Main Screen* to access the *Password* screen.

M4000 Menu Structure

The flowchart on these two pages shows each menu and its submenus:

- Each separate screen is inside a box.
- If a screen “branches”, each screen of the branch is in a box to the right.
- *Text in italic* further explains the parameter.

Mark on the chart what parameters need to be set. Note parameter settings on the chart. Program your amplifier accordingly. Keep the chart as a reference for other shifts and personnel and to monitor meter performance.

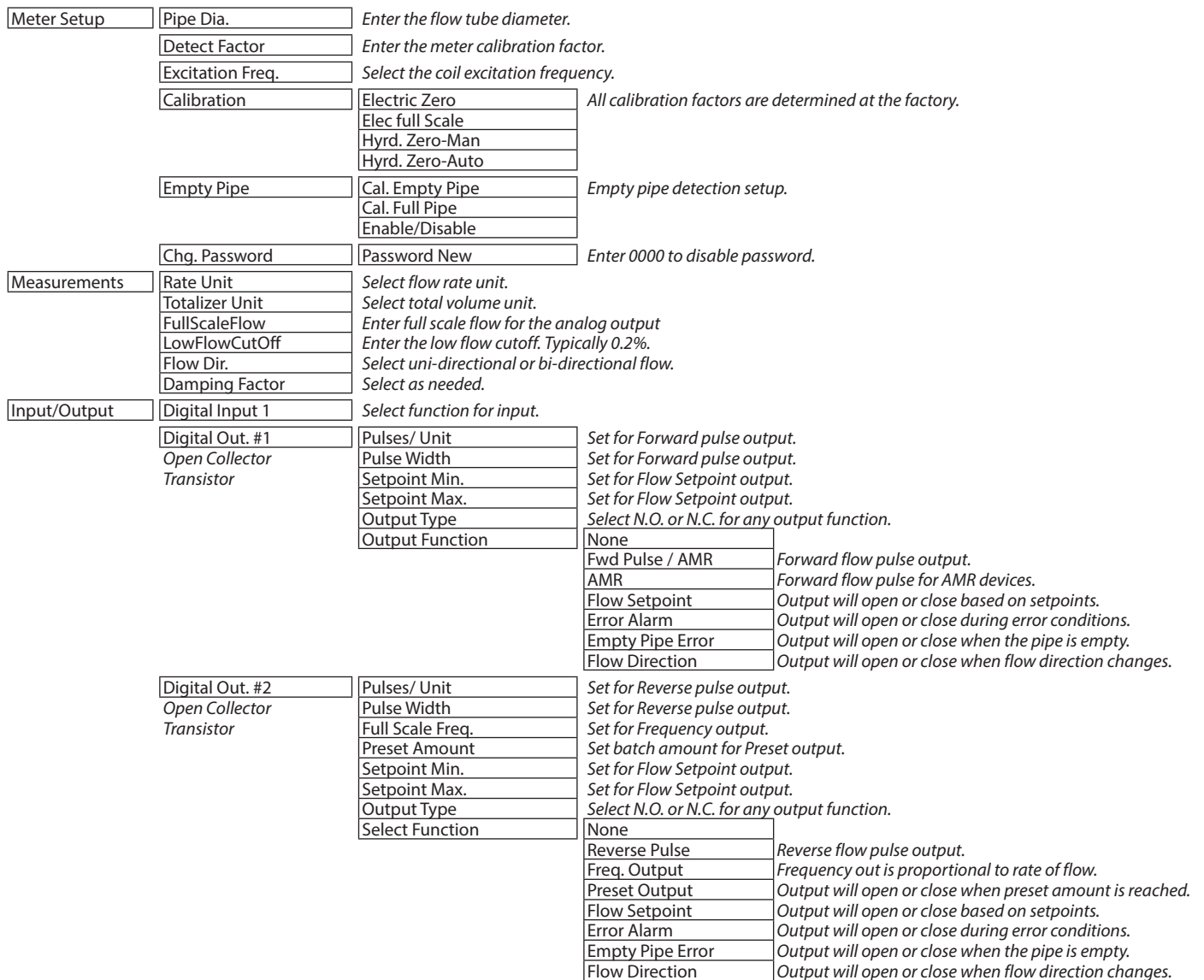

Figure 37: M4000 menu structure flowchart

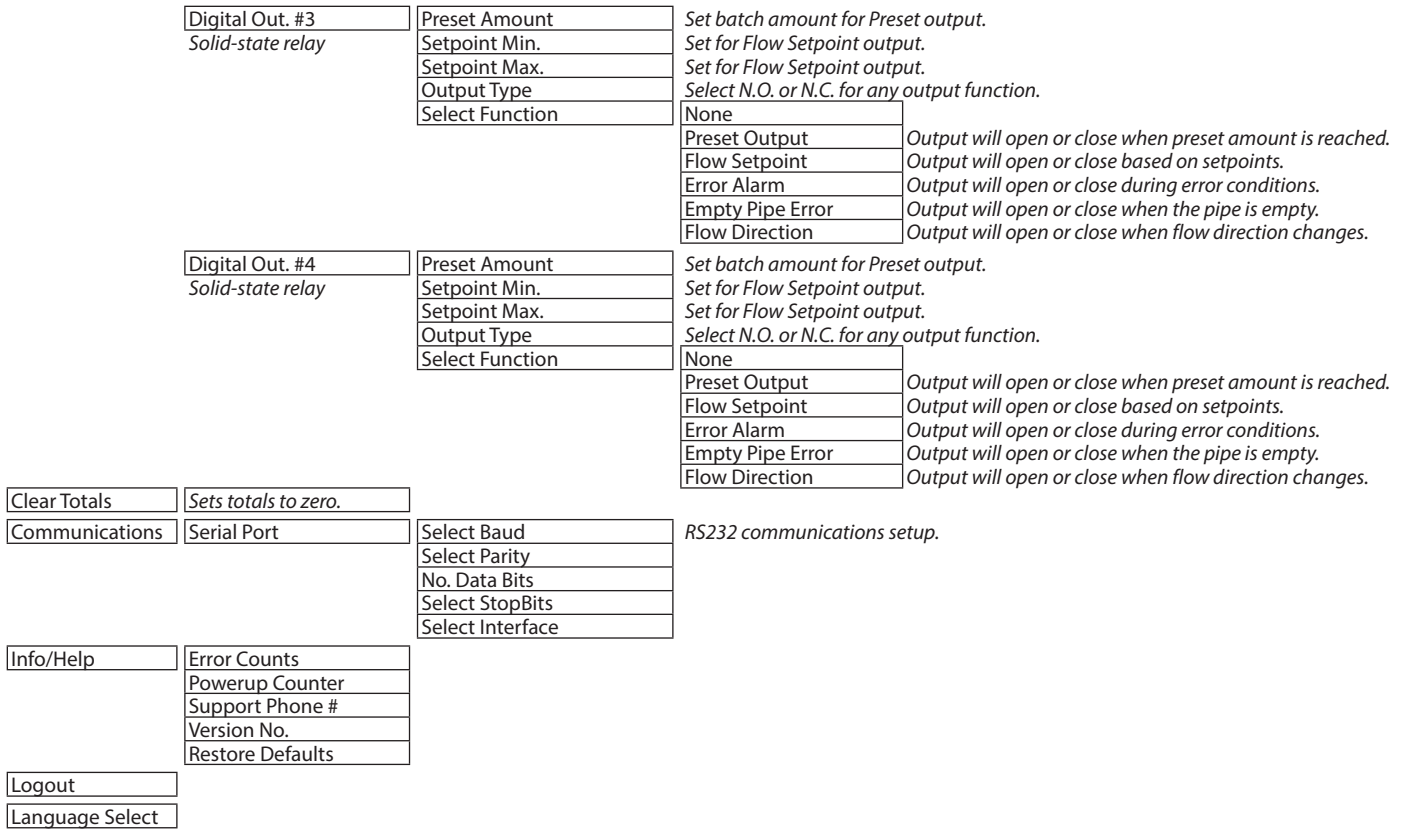

Figure 38: M4000 menu structure flowchart, continued

```

MAIN MENU      00
-----
>Exit this Menu
Meter Setup
Measurements
Inputs/Outputs
Clear Totals
Communications
Info/Help
Logout
Language select
    
```

Figure 39: Sample list screen

Amplifier screens, menus and program parameters are arranged in a branching format—each selection opens a new screen.

The *Main Menu* is a list of selections. Each selection opens one of three types of screens:

- *List* screens contain menu items.
- *Input* screens require numeric input.
- *ON* or *OFF* screens control the state of a parameter setting.

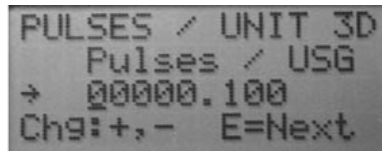

Figure 40: Sample input numbers screen

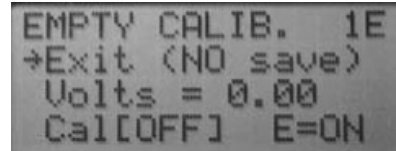

Figure 41: Sample select ON or OFF screen

Programming Practice—Understanding the Main Screen

The *Main* screen always displays when programming functions are not occurring.

NOTE: If no contact is made with the control switches or buttons for 2 minutes, the display automatically returns to the *Main* screen.

The *Main* screen has two setting options—Uni-Directional flow or Bi-Directional flow. Choose the setting that matches the fluid Flow Direction through your meter. Both settings display the *rate of flow (R=)* and *flow units*. See “Set Flow Rate Unit of Measure and Totalizer Unit of Measure” on page 34 to program flow units.

Main screen for Uni-Directional Flow Meters

Uni-directional flow totalizes pipe flow in only one direction—the flow direction arrow printed on the detector label. See “Set Flow Direction” on page 35 to program for uni-directional mode.

Uni-directional readings on the *Main* screen are R=, T1, T2 and PS.

```
M-Series    U1.0
R=         0.0000 GPM
T1         0.000 USG
T2        -54.366 USG
```

R = Flow Rate

T1 registers Forward Volume.

T2 registers Forward Volume and can be reset through Input 1.

```
M-Series    U1.0
T1         0.000 USG
T2        -54.405 USG
PS         0.000 USG
```

PS registers Preset Batch Amount.

With this information an operator can tell at a glance the volume going through the meter.

Main Screen For Bi-Directional Flow Meters

Bi-directional flow totalizes pipe flow in both directions. See “Set Flow Direction” on page 35 to program for Bi-Directional Mode.

Bi-directional readings on the *Main* screen are R=, T+, T- , TN and PS.

```
M-Series    U1.0
R=         0.0000 GPM
T+         0.000 USG
T-         56.154 USG
```

R = Flow Rate

T+ registers Forward Volume.

T- registers Forward Volume.

```
M-Series    U1.0
T-         61.210 USG
TN        -61.210 USG
PS         0.000 USG
```

TN Net Total = (T+) – (T-)

PS registers Preset Batch Amount.

With this information, an operator can tell at a glance the volume going through the meter.

Password Entry

```
PASSWORD??? 01
Please enter
→password: 0000
Chg: +, - E=Next
```

With the *Main* screen displayed, tap **E**.

If a password has been entered into your program, the *PASSWORD??? 01* screen opens. See “Enter a Password” on page 33 for programming a password.

An underscore () is positioned under the first zero.

1. Tap **+** (**plus**) to increase the number by one digit or tap **-** (**minus**) to decrease the number by one digit.
2. When the correct number is entered for that digit, tap **E** to move the underscore to the next 0.
3. Repeat the number selection process for the remaining zeros.

4. After the last number is entered, tap **E**.
5. The *MAIN MENU 00* opens.

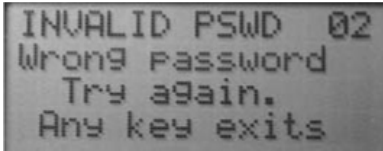

However, if the wrong password was entered, the *INVALID PSWD 02* screen opens.

1. Tap +, – or **E** to return to the Main screen.
2. Tap **E** again.

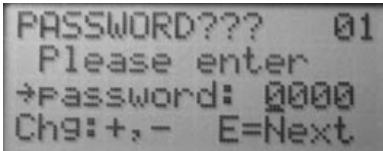

The *PASSWORD??? 01* screen returns.

Enter the correct password as described above.

All passwords are factory set to 0000 (no password is programmed or required). If 0000 is the password, tapping **E** from the *Main* screen opens the *MAIN MENU 00* screen.

Programming Practice—Navigating the Menus

The following pages introduce you to the screen formats, describe how to maneuver to and through them and provide some specifics about programming terminology and parameters.

If possible, have access to your amplifier display and controls and perform these screen manipulations.

All amplifier programming and parameters are accessed from the *MAIN MENU 00*.

Only four lines of text are visible on the display screen. Tap the + and – controls to move text up or down and into view. Tap **E** to select a menu item that is in line with the arrow.

Each screen has a name and number displayed at the top of the screen. Write down the screen names, numbers, and parameters that you access and change, in case other changes are needed later.

NOTE: Your metering requirements may not require the use of all screens, options, and parameters.

Meter Setup

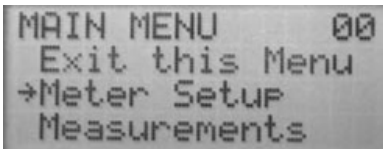

1. Move the arrow to **Meter Setup**.
2. Tap **E** to open the *METER SETUP 10* screen.

METER SETUP 10 is a List screen. It provides access to common meter parameters.

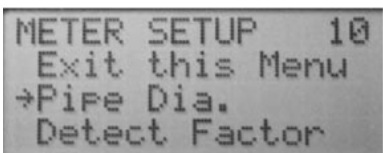

3. Move the arrow to **Pipe Dia**.
4. Tap **E** to open the *PIPE DIA. 11* screen.

Pipe Dia.

PIPE DIA.	11

Exit this Menu	
6mm	[1/4"]
8mm	[5/16"]
10mm	[3/8"]
15mm	[1/2"]
20mm	[3/4"]
25mm	[1"]
32mm	[1 1/4"]
40mm	[1 1/2"]
50mm	[2"]
65mm	[2 1/2"]
80mm	[3"]
100mm	[4"]
125mm	[5"]
150mm	[6"]
200mm	[8"]
250mm	[10"]
300mm	[12"]
350mm	[14"]
400mm	[16"]
>450mm	[18"]
500mm	[20"]
550mm	[22"]
600mm	[24"]

- On the *PIPE DIA. 11* screen, move the arrow to the appropriate pipe size.
- Tap **E**.

450mm [18"]
** SELECTED **

A status screen, with the statement [(xx mm [xx"])
SELECTED displays for about 2 seconds.

The status screen verifies that the selected pipe diameter size parameter was entered into the amplifier settings.

METER SETUP 10
→Exit this Menu
Pipe Dia.
Detect Factor

The screen automatically returns to *METER SETUP 10* screen with the arrow pointed at *Exit this Menu*.

Tap + or - to move the arrow to another selection or tap **E** to return to the *MAIN MENU 00*.

Inputs/Outputs

MAIN MENU 00
Measurements
→Inputs/Outputs
Clear Totals

- On the *MAIN MENU 00*, move the arrow to **Inputs/Outputs**.
- Tap **E** to open the *IN/OUTPUTS 30* screen.

Digital Out. #1

IN/OUTPUTS 30
Digital Input 1
→Digital Out. #1
Digital Out. #2

- Move the arrow to **Digital Out. #1**.
- Tap **E** to open the *DIG OUTPUT 1 33* screen.

DIG OUTPUT 1 33
Exit this Menu
→Pulses / unit
Pulse width

- Move the arrow to **Pulses / unit**.
- Tap **E** to open the *PULSES / UNIT 3D* screen.

PULSES / UNIT 3D
Pulses / USG
→ 00000.100
Ch9: +, - E=Next

- Tap + or - to increase or decrease the underscored number to the desired digit.
- Tap **E** to move the underscore to the next digit and repeat the number selection process. To skip a digit, tap **E**. The underscore moves to the next digit.
- When all digits are set, tap **E**. The *Pulses / unit* you entered is programmed into the system and the *DIG OUTPUT 1 33* screen returns.

Empty Pipe

Empty Pipe is a branch list screen from the *MAIN MENU 00* screen. From here, you can set Calibrate **ON** or **OFF**.

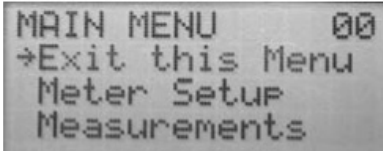

1. Tap **E** to return to the *MAIN MENU 00*.

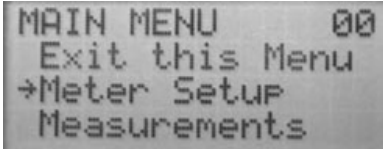

2. Move the arrow to **Meter Setup**.
3. Tap **E** to open the *METER SETUP 10* screen.

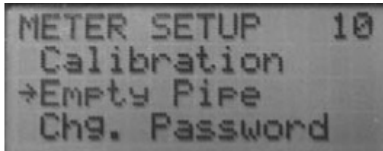

4. Move the arrow to **Empty Pipe**.
5. Tap **E** to open the *EMPTY PIPE 15* screen.

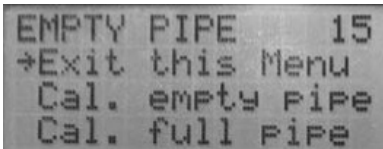

The *Empty Pipe* default status is **OFF**.

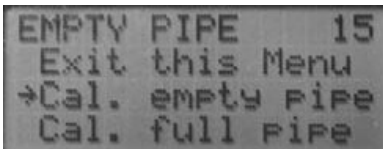

To turn *Empty Pipe* **ON**:
6. Move the arrow to **Cal. empty pipe**.
7. Tap **E** to open the *EMPTY CALIB. 15* screen.

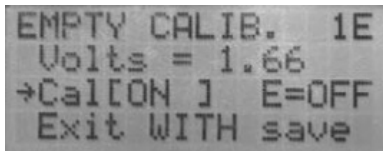

8. Move the arrow to **Cal [ON]**.
9. Tap **E** to turn Cal=[ON].
10. Move the arrow to **Exit WITH save**.
11. Tap **E** to program your selection.

Continue tapping **E** to back up through the screens to your next programming selection or to return to the *Main* screen.

You have now navigated selections to access the programming screens and maneuvered through some meter programming.

Programming the Required Parameters

As you program parameters, see the “M4000 Menu Structure” on page 27. All meters have required parameters that must be programmed. They include a *Password* (if desired), the Main screen for *Uni-Directional* or *Bi-Directional Flow*, *Empty Pipe*, *Pulse Output* and *Analog Output*, among others.

This section presents keystroke details describing how to program required parameters.

Enter a Password

```
M-Series    U1.0
R=         0.0000 GPM
T1        0.000 USG
T2       -54.366 USG
```

1. With the *Main* screen displayed, tap **E** to open the *MAIN MENU 00* screen.

```
MAIN MENU   00
Exit this Menu
→Meter Setup
Measurements
```

2. Move the arrow to **Meter Setup**.
3. Tap **E** to open the *METER SETUP 10* screen.

```
METER SETUP 10
Empty Pipe
→Chg. Password
-----
```

4. Move the arrow to **Chg. Password**.
5. Tap **E** to open the *CHG PASSWORD 16* screen.

```
CHG. PASSWORD 16
Enter new
→password: 0000
Chg:+,- E=Next
```

6. Enter your password number.

```
INVALID PSWD 02
Wrong Password
Try again.
Any key exits
```

However, if the wrong password was entered, the *INVALID PSWD 02* screen opens.

```
M-Series    U1.0
R=         0.0000 GPM
T1        0.000 USG
T2       -54.366 USG
```

1. Tap +, - or **E** to return to the *Main* screen.
2. Tap **E** again.

```
PASSWORD??? 01
Please enter
→password: 0000
Chg:+,- E=Next
```

The *PASSWORD??? 01* screen returns.

Enter the correct password as described above.

All passwords are factory set to 0000 (no password is programmed or required). If 0000 is the password, tapping **E** from the *Main* screen opens the *MAIN MENU 00* screen.

Set Flow Rate Unit of Measure and Totalizer Unit of Measure

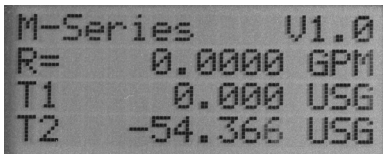

1. With the Main screen displayed, tap **E** to open the *MAIN MENU 00* screen.

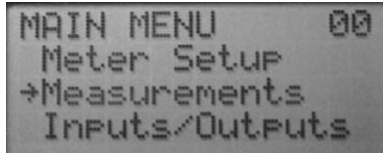

2. Move the arrow to **Measurements**.
3. Tap **E** to open the *MEASUREMENTS 20* screen.

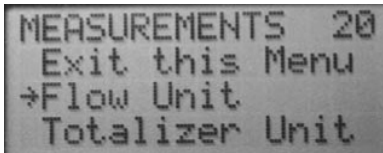

4. Move the arrow to **Flow Unit**.
5. Tap **E** to open the *FLOW UNITS 21* screen.

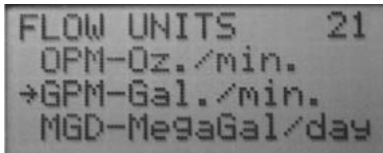

6. Move the arrow to a flow unit.
7. Tap **E** to save your selection.

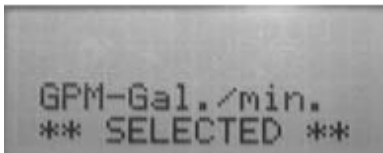

A status screen displays for two seconds, then the display goes back to the *MEASUREMENTS 20* screen.

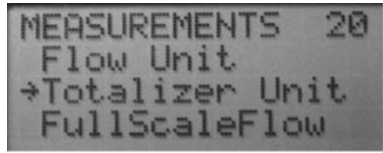

8. Move the arrow to **Totalizer Unit**.
9. Tap **E** to open the *TotalizerUnit 22* screen.

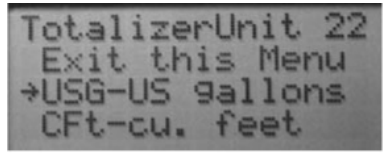

10. Move the arrow to a totalizer unit.
11. Tap **E** to save your selection.

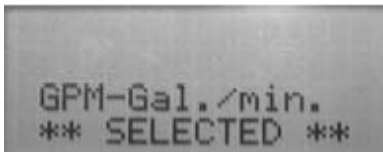

A status screen displays for two seconds, then the display goes back to the *MEASUREMENTS 20* screen.

Set Full Scale Flow Rate Value

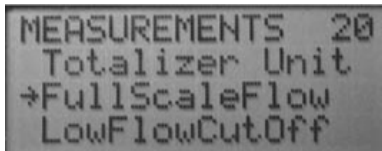

```
MEASUREMENTS 20
Totalizer Unit
→FullScaleFlow
LowFlowCutOff
```

1. On the *MEASUREMENTS 20* screen, move the arrow to **FullScaleFlow**.
2. Tap **E** to open the *FullScaleFlow 23* screen.

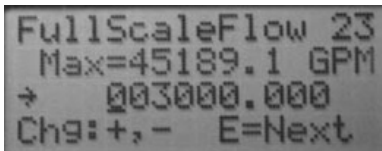

```
FullScaleFlow 23
Max=45189.1 GPM
→ 003000.000
Chg: +, - E=Next
```

3. Tap + or - to increase or decrease the underscored number to the desired digit.
4. Tap **E** to move the underscore to the next digit and repeat the number selection process. To skip a digit, tap **E**. The underscore moves to the next digit.
5. When all digits are set, tap **E**. The *FullScaleFlow rate value* you entered is programmed into the system and the *Measurements* screen returns.

Set Low Flow Cutoff

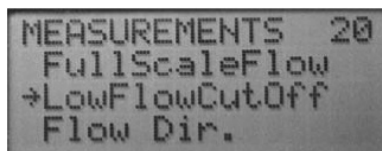

```
MEASUREMENTS 20
FullScaleFlow
→LowFlowCutOff
Flow Dir.
```

1. On the *MEASUREMENTS 20* screen, move the arrow to **LowFlowCutOff**.
2. Tap **E** to open the *LowFlowCutOff 24* screen.

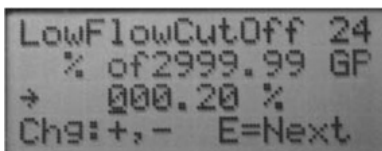

```
LowFlowCutOff 24
% of 2999.99 GP
→ 000.20 %
Chg: +, - E=Next
```

3. Tap + or - to increase or decrease the underscored number to the desired digit.
4. Tap **E** to move the underscore to the next digit and repeat the number selection process. To skip a digit, tap **E**. The underscore moves to the next digit.
5. When all digits are set, tap **E**. The *LowFlowCutOff percentage* you entered is programmed into the system and the *MEASUREMENTS 20* screen returns.

Set Flow Direction

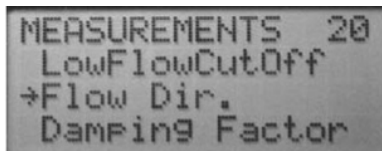

```
MEASUREMENTS 20
LowFlowCutOff
→Flow Dir.
Damping Factor
```

1. On the *MEASUREMENTS 20* screen, move the arrow to **Flow Dir.**
2. Tap **E** to open the *FLOW DIR 25* screen.

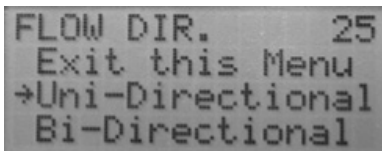

```
FLOW DIR. 25
Exit this Menu
→Uni-Directional
Bi-Directional
```

3. Move the arrow to either **Uni-Directional** or **Bi-Directional**.
4. Tap **E** to save your selection.

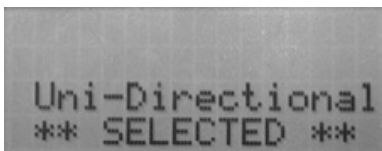

```
Uni-Directional
** SELECTED **
```

A status screen displays for two seconds, then the display goes back to the *MEASUREMENTS 20* screen.

Set Damping Factor



1. On the *MEASUREMENTS 20* screen, move the arrow to **Damping Factor**.
2. Tap **E** to open the *DampingFactor 26* screen.

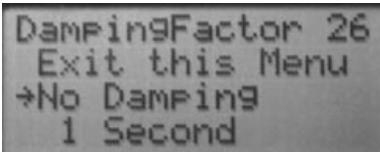

3. Move the arrow to **No Damping** or to one of the time frames.

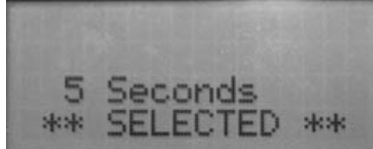
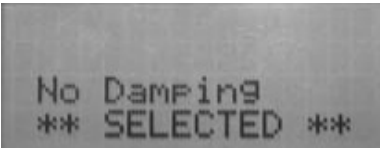

A status screen displays for two seconds, then the display goes back to the *MEASUREMENTS 20* screen.

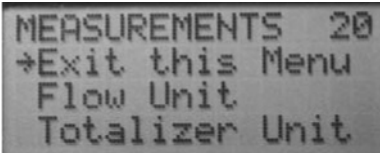

4. Tap **E** to exit the *MEASUREMENTS 20* screen and display the *MAIN MENU 00*.

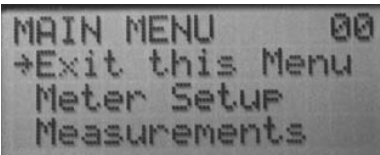

5. Tap **E** to exit the *MAIN MENU 00* screen and display the *Main* screen.

Empty Pipe Calibration

```
M-Series    U1.0
R=         0.0000 GPM
T1         0.000 USG
T2        -54.366 USG
```

1. On the *Main* screen, tap **E** to display the *MAIN MENU 00* screen.

```
MAIN MENU  00
Exit this Menu
→Meter Setup
Measurements
```

2. Move the arrow to **Meter Setup**.
3. Tap **E** to open the *METER SETUP 10* screen.

```
METER SETUP 10
Calibration
→Empty Pipe
Chg. Password
```

4. Move the arrow to **Empty Pipe**.
5. Tap **E** to open the *EMPTY PIPE 15* screen.

```
EMPTY PIPE  15
Exit this Menu
→Cal. empty pipe
Cal. full pipe
```

To turn *Empty Pipe* **ON**:

6. Move the arrow to **Cal. empty pipe**.
7. Tap **E** to open the *EMPTY CALIB 1E* screen.

```
EMPTY CALIB. 1E
Volts = 3.30
→Cal[ON ] E=OFF
Exit WITH save
```

8. Move the arrow to **Cal [ON]**.

NOTE: Make sure the Flow Detector Pipe is empty.

9. Tap **E** to turn Cal=[ON].

```
EMPTY CALIB. 1E
Cal[ON ] E=OFF
→Exit WITH save
-----
```

10. Move the arrow to **Exit WITH save**.

11. Tap **E** to program your selection and return to the *EMPTY PIPE 1E* screen.

NOTE: With the pipe empty, the usage reading should be between 3.00 and 3.30 V.

Full Pipe Calibration

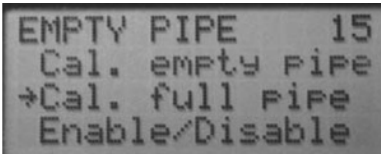

1. On the *EMPTY PIPE 1E* screen, move the arrow to **Cal. full pipe**.
2. Tap **E** to open the *FULL PIPE CAL 1F* screen.

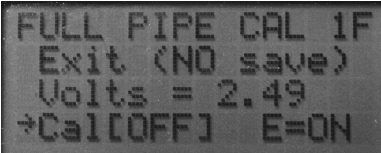

3. Move the arrow to **Cal[OFF] E=ON**.
4. Tap **E** to switch **OFF** to **ON**.

NOTE: Make sure the Flow Detector pipe is full of fluid. The full pipe voltage reading should be below 3.00 V.

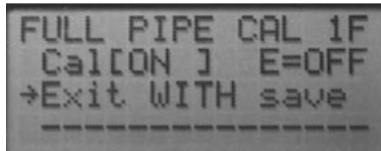

5. Move the arrow to **Exit WITH save**.
6. Tap **E** to program your selection and return to the *EMPTY PIPE 15* screen.

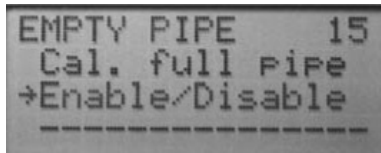

7. On the *EMPTY PIPE 15* screen, move the arrow to **Enable/Disable**.
8. Tap **E** to open the *EMPTY CONTROL 1G* screen.

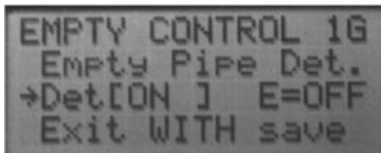

9. Move cursor to **Det[OFF] E=ON**.
10. Tap **E** to switch **OFF** to **ON**.

Pulse Output

```
M-Series    U1.0
R=         0.0000 GPM
T1         0.000 USG
T2        -54.366 USG
```

```
MAIN MENU   00
Measurements
→Inputs/Outputs
Clear Totals
```

```
IN/OUTPUTS  30
Digital Input 1
→Digital Out. #1
Digital Out. #2
```

```
DIG OUTPUT 1 33
Exit this Menu
→Pulses / unit
Pulse width
```

```
PULSES / UNIT 3D
Pulses / USG
→ 00000.100
Chg: +, - E=Next
```

1. With the *Main* screen displaying, press **E** once to open the *MAIN MENU 00*.

2. Move the cursor to **Inputs/Outputs**.

3. Tap **E** to open the *IN/OUTPUTS 30* screen.

4. Move the arrow to **Digital Out. #1**.

5. Tap **E** to open the *DIG OUTPUT 1 33* screen.

6. Move the arrow to **Pulses / unit**.

7. Tap **E** to open the *PULSES / UNIT 3D* screen.

NOTE: You only need to do this if the function of output one (1) is to be Fwd Pulse or AMR (50 ms pulse.) See "Digital Out. #1" on page 31.

8. Tap + or - to increase or decrease the underscored number to the desired digit.

9. Tap **E** to move the underscore to the next digit and repeat the number selection process. To skip a digit, tap **E**. The underscore moves to the next digit.

10. When all digits are set, tap **E**. The *Pulses / unit* you entered is programmed into the system and the *DIG OUTPUT 1 33* screen returns.

Pulse Width

```
DIG OUTPUT 1 33
Pulses / unit
→Pulse width
Set point min.
```

```
PULSE WIDTH 3E
Width in ms
→0000
Chg: +, - E=Next
```

NOTE: This is only for Fwd Pulse. See "Digital Out. #1" on page 31.

1. On the *DIG OUTPUT 1 33* screen, move the arrow to **Pulse width**.

2. Tap **E** to open the *PULSES WIDTH 3E* screen.

3. Tap + or - to increase or decrease the underscored number to the desired digit.

4. Tap **E** to move the underscore to the next digit and repeat the number selection process. To skip a digit, tap **E**. The underscore moves to the next digit.

5. When all digits are set, tap **E**. The *Pulse width* you entered is programmed into the system and the *DIG OUTPUT 1 33* screen returns.

Setpoint

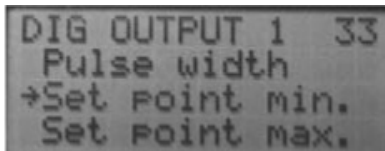

NOTE: This is only for Flow Setpoint. See "Digital Out. #1" on page 31.

1. On the *DIG OUTPUT 1 33* screen, move the arrow to **Set point min.**
2. Tap **E** to open the *SET PT MIN 3F* screen.

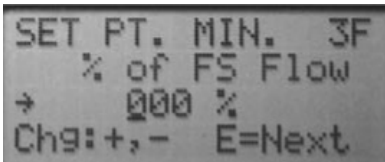

3. Tap + or - to increase or decrease the underscored number to the desired digit.
4. Tap **E** to move the underscore to the next digit and repeat the number selection process. To skip a digit, tap **E**. The underscore moves to the next digit.

NOTE: When the flow rate falls below the minimum set point value (entered as a percentage of full scale,) the output activates.

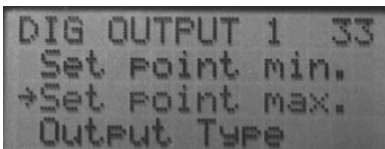

5. When all digits are set, tap **E**. The *Setpoint minimum* you entered is programmed into the system and the *DIG OUTPUT 1 33* screen returns.

6. On the *DIG OUTPUT 1* screen, move the arrow to **Set point max.**
7. Tap **E** to open the *SET PT MAX 3G* screen.

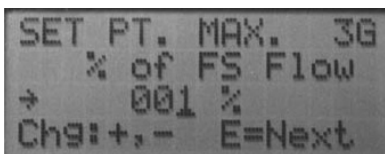

8. Tap + or - to increase or decrease the underscored number to the desired digit.
9. Tap **E** to move the underscore to the next digit and repeat the number selection process. To skip a digit, tap **E**. The underscore moves to the next digit.
10. When all digits are set, tap **E**. The *Setpoint maximum* you entered is programmed into the system and the *DIG OUTPUT 1 33* screen returns.

NOTE: When the flow rate falls below the maximum set point value (entered as a percentage of full scale,) the output activates.

Output Type

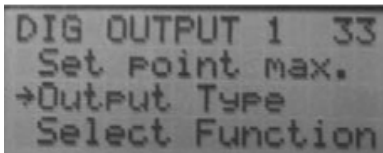

DIG OUTPUT 1 33
Set point max.
→Output Type
Select Function

1. On the *DIG OUTPUT 1 33* screen, move the arrow to **Output Type**.
2. Tap **E** to open the *OUTPUT TYPE 3H* screen.

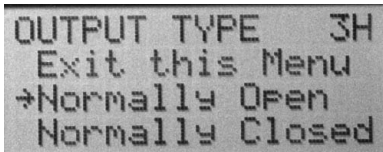

OUTPUT TYPE 3H
Exit this Menu
→Normally Open
Normally Closed

3. Move the arrow to **Normally Open** or **Normally Closed**.
4. Tap **E**.

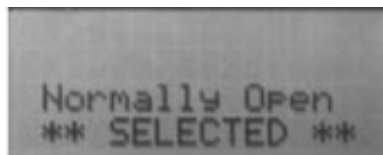

Normally Open
** SELECTED **

A status screen displays for two seconds, then the *DIG OUTPUT 1 33* screen returns.

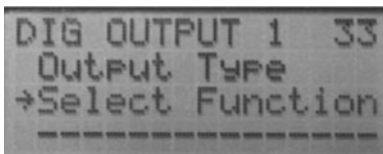

DIG OUTPUT 1 33
Output Type
→Select Function

5. Move the arrow to **Select Function** and tap **E**.

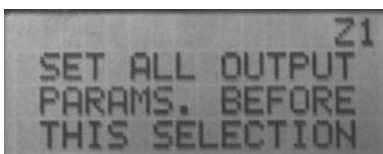

Z1
SET ALL OUTPUT
PARAMS. BEFORE
THIS SELECTION

The *Z1* screen displays for 2 seconds.

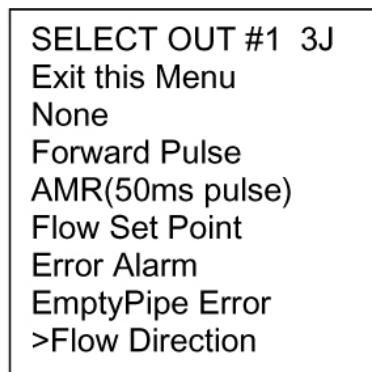

SELECT OUT #1 3J
Exit this Menu
None
Forward Pulse
AMR(50ms pulse)
Flow Set Point
Error Alarm
EmptyPipe Error
>Flow Direction

Then the *SELECT OUT #1 3J* screen opens.

6. Move the arrow to a selection and tap **E**.

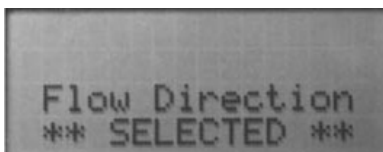

Flow Direction
** SELECTED **

A status screen displays for two seconds, then the *DIG OUTPUT 1 33* screen returns. Repeat steps 5 and 6 until all the required digital outputs are programmed.

Analog Output

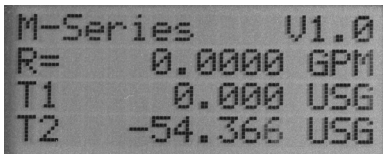

1. With the Main screen displaying, press **E** once to open the *MAIN MENU 00* screen.

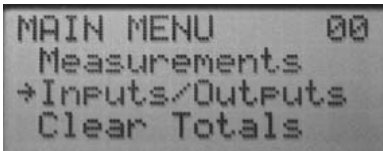

2. Move the cursor to **Inputs/Outputs**.

3. Tap **E** to the *IN/OUTPUTS 30* screen.

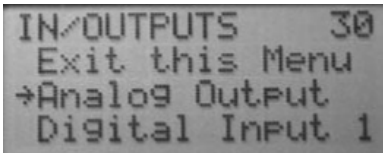

4. Move the arrow to **Analog Output**.

5. Tap **E** to open the *ANALOG OUTPUT 31* screen.

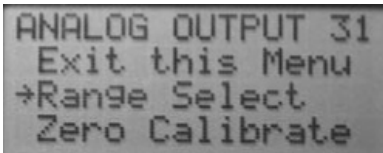

6. Move the arrow to **Range Select**.

7. Tap **E** to open the *RANGE SELECT 3A* screen.

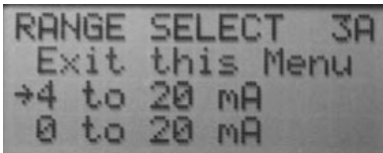

8. Move the arrow to a range and tap **E**.

The *ANALOG OUTPUT 31* screen returns.

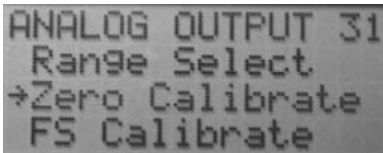

9. Move the arrow to **Zero Calibrate**.

10. Connect an amp meter to mA analog output pins 9 and 10.

11. Tap **E** to open the *ANALOG ZERO 3B* screen.

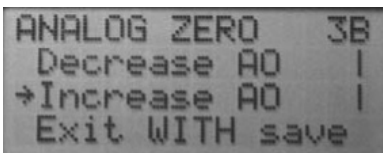

12. Based on the amp meter reading, move the arrow to **Decrease AO** or **Increase AO**.

13. Tap **E** until the amp meter reads the desired No Flow setpoint.

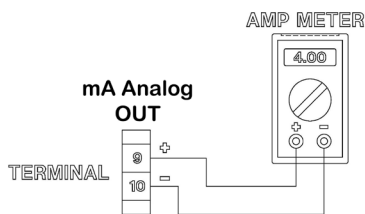

The line to the left of the selection rotates as you tap **E**, to show that there is activity.

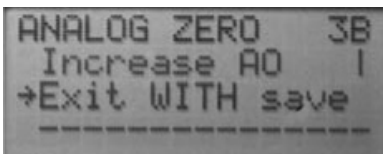

14. Move the arrow to **Exit WITH save**.

15. Tap **E** to save the setting and return to the *ANALOG OUTPUT 31* screen.

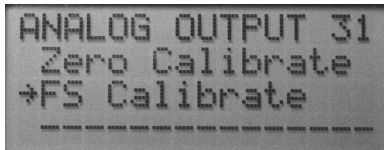

16. Move the arrow to **FS Calibrate**.
17. Tap **E** to open the *ANALOG FS CAL 3C* screen.

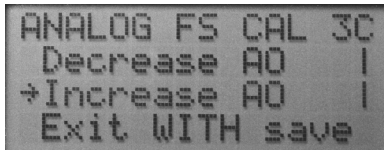

18. Based on the amp meter reading, move the arrow to **Decrease AO** or **Increase AO**.
19. Tap **E** until the amp meter reads the desired Full Scale setpoint.

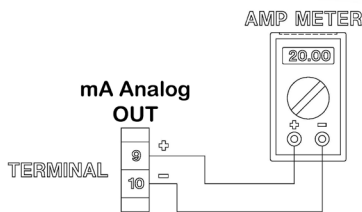

The line to the left of the selection rotates as you tap **E**, to show that there is activity.

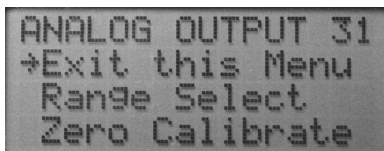

20. Move the arrow to **Exit WITH save**.
21. Tap **E** to save the setting and return to the *ANALOG OUTPUT 31* screen.
22. With the arrow at **Exit this Menu**, tap **E** to return to the *IN/OUTPUTS 30* screen.

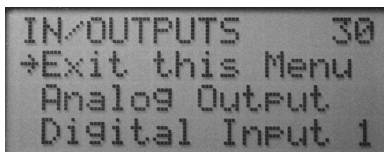

23. With the arrow at **Exit this Menu**, tap **E** to return to the *MAIN MENU 00* screen.

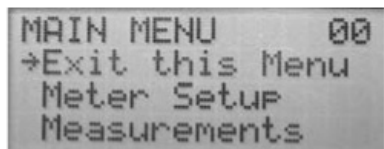

24. With the arrow at **Exit this Menu**, tap **E** to return to the *Main* screen.

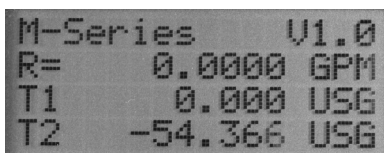

The above programming sequence guided you through various screens and programming. These are the basic features that need to be programmed initially. See “*M4000 Menu Structure*” on page 27 for all of the programming options.

MAINTENANCE

Mandatory, routine or scheduled maintenance should not be required for the Badger Meter M4000 Mag Meter electronics or flow tube, after proper installation.

However, some occurrences may require personnel to perform the following:

- Flow Tube and Electrode Cleaning
- Fuse Replacement
- Amplifier I&C Card Stack Replacement

These maintenance procedures are discussed in this section.

⚠ WARNING

- **DISCONNECT MAIN POWER TO THE UNIT BEFORE ATTEMPTING ANY DEVICE MAINTENANCE OR CLEANING.**
- **DO NOT CLEAN COMPONENTS INSIDE THE AMPLIFIER OR JUNCTION BOX.**

Flow Tube and Electrode Cleaning

At times flow tube, electrodes, amplifier/junction box housings and the amplifier window may need periodic cleaning, depending on process fluid properties, fluid flow rate and surrounding environment.



Clean the flow tube and electrodes by following the material handling and cleaning procedures documented in MSD Sheets for the products that were in contact with the flow tube and electrodes.

To clean the flow tube and/or electrode:

1. Disconnect detector from pipeline.
2. Clean electrodes with isopropyl alcohol or fresh, clean water depending on the chemical compatibility of the measured fluid.
3. Reconnect detector to pipeline

Fuse Replacement

⚠ WARNING

DISCONNECT MAIN POWER TO THE UNIT BEFORE ATTEMPTING ANY DEVICE MAINTENANCE.

⚠ CAUTION

RISK OF ELECTRICAL SHOCK. REPLACE FUSE ONLY WITH THE SAME TYPE AND RATING. AUTHORIZED PERSONNEL MUST PERFORM FUSE REPLACEMENTS.

- Replace fuses with fuses of the same ampere rating and type.
- The amplifier and coil electronics are protected by two individual fuses—an upper fuse and a lower fuse.
- Additionally, the fuse ratings and values are different based on the type of input power provided (24V DC or 85...265V AC).
- For the AC powered version, the upper fuse is a 630 mA, 250V AC, slow blow fuse, part number 65621-001. The lower fuse is a 500 mA, 250V AC, slow blow fuse, part number 65621-002.
- For the DC powered version, the upper fuse is a 315 mA, 250V AC, slow blow fuse, part number 65621-004. The lower fuse is a 630 mA, 250V AC, slow blow fuse, part number 65621-001.
- Fuse ratings are listed on the circuit board, next to the fuse holders. See the M-Series Model M4000 Parts List.

To access and replace fuses:



1. Remove the display chamber cover. Turn the cover counterclockwise to remove it from the amplifier. If necessary, use a strap wrench.



2. Remove the two display card screws and washers.



3. Tilt the card up and out approximately 45 degrees at the holding clips.

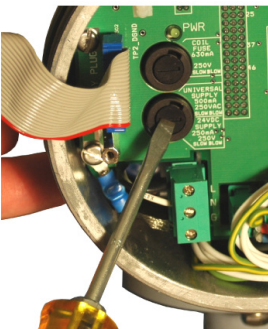

4. Fuses are in the round/black fuse holders. Use a flat screwdriver to turn the holder cap counterclockwise until the lock tab reaches the opening and the holder and fuse disengage.

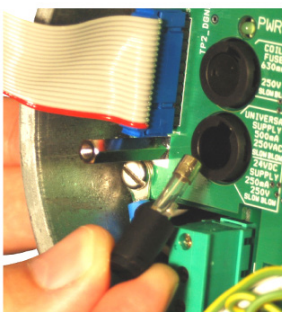

5. Replace the fuse.

NOTE: Reverse steps 1 to 3 to assemble the unit.

Amplifier Printed Circuit Board (PCB) Stack Replacement

All M4000 mag meters operate through printed circuit boards (PCBs) housed in the amplifier. The PCBs are grouped in a stack located behind the display/control card in the display/programming chamber.

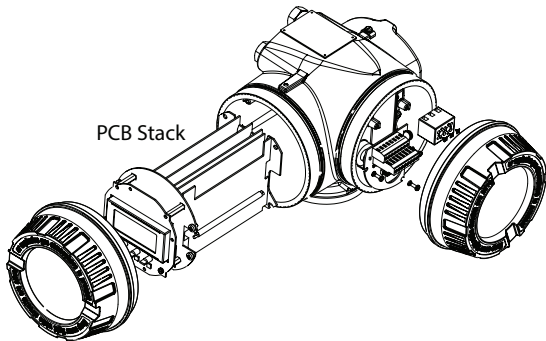

Figure 42: PCB stack in amplifier

Because PCBs are complex circuits, with all meter functions enabled through multiple links and layers, determining the exact board and circuit that is causing a system problem is difficult and usually requires test equipment.

Should a meter problem occur:

- Call Badger Meter at (877) 243-1010 and discuss the problem with a Technical Support Specialist.
- If the problem appears to originate in a PCB, it may be recommended that the entire PCB stack be removed and returned to Badger Meter.

Remove PCB Stack



⚠ WARNING

DISCONNECT MAIN POWER TO THE UNIT BEFORE ATTEMPTING ANY DEVICE MAINTENANCE.

1. Remove display/programming chamber cover. Turn the cover counterclockwise to remove it from the amplifier. If necessary, use a strap wrench.



2. Remove the two display card screws and washers.



3. Tilt the card up and out approximately 45 degrees at the holding clips.

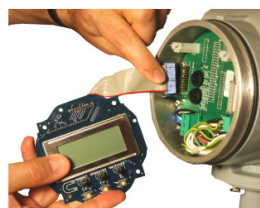

4. Gently pull card down and out from between holding clips.
5. Disconnect display card plug from left side of PCB display.

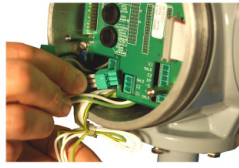
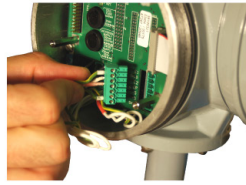
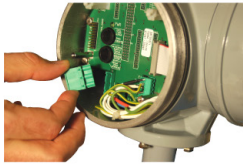

6. Disconnect the power, coil, electrode and I/O plugs and harnesses from the PCB interconnect card.

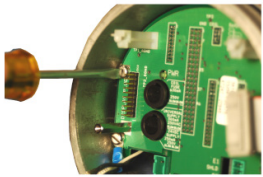

7. Remove the 4 screws holding the PCB stack in the amplifier housing. Place in storage for reuse.

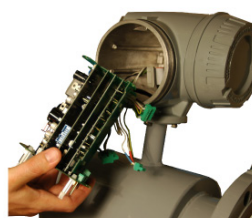

8. Gently remove the card stack from the amplifier housing. Do not tug or pull to remove the stack. Ease it out carefully.

9. Carefully wrap and package the PCB stack and display card. Send back to Badger Meter.

10. Reverse these steps to install a PCB stack.

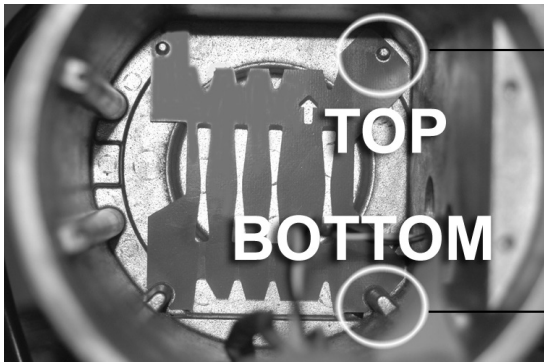

When replacing the PCB stack:

- Be sure to place the two lower feet of the circuit board support along the edges of the amplifier housing.
- Gently move the stack back into the housing until the two holes at the top mate with the housing. (The stack is not connected to the circuit board in this picture.)

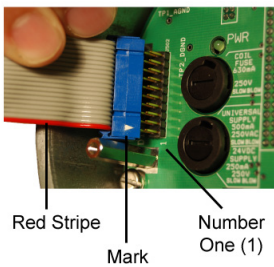

11. When placing the display card back into PCB Display, verify that the mark and the red stripe are aligned with Number 1.

SPECIFICATIONS

Sizes	1/4...12" (6...300 mm)	
Flow Range	0.1...39.4 ft/s (0.03...12 m/s)	
Accuracy	± 0.25% of rate for velocities greater than 1.64 ft/s (0.50 m/s) ± 0.004 ft/s (± 0.001) m/s for velocities less than 1.64 ft/s (0.50 m/s)	
Repeatability	0.1% of rate	
Power Supply	85...265V AC, 45...65 Hz	
Analog Outputs	0...10 mA, 0...20 mA, 4...20 mA (programmable and scalable), Voltage sourced (18V DC) – isolated, max. loop resistance = 750 Ω	
Digital Outputs	(2) Open collector, (programmable scaled pulse, flow alarm, status, or frequency output), max. 24V DC, 0.5 W (2) AC solid-state relay (programmable flow alarm or status), max. 24V DC @ 0.5 A	
Frequency Output	Open collector, max. full scale flow = 10 kHz	
Communication	Standard ANSI terminal compatible data stream	
Pulse Width	Open collector, 5 ms to 1 second (programmable) or automatic 50% duty cycle	
Min-Max Flow Alarm	Open collector or solid-state relay (programmable 0...100% of flow)	
Empty Pipe Detection	Field tunable for optimum performance based on specific application	
Excitation Frequency	Programmable 3.75 Hz, 7.5 Hz or 15 Hz	
Auxiliary Input	Max. 24V DC (programmable positive zero return, external totalizer reset or preset batch start)	
Power Consumption	20 W	
Noise Dampening	1...30 seconds (programmable)	
Low Flow Cutoff	0...100% of full scale (programmable)	
Zero-Point Stability	Automatic correction	
Galvanic Separation	500V	
Fluid Conductivity	Min. 5 micromhos/cm	
Fluid Temperature	With remote mounted amplifier	PFA & PTFE: – 4...248° F (–20...120° C) @ max. ambient temp. of 122° F (50° C) Hard rubber: 32...178° F (0...80° C) @ max. ambient temp. of 122° F (50° C)
	With meter mounted amplifier	PFA & PTFE: – 4...212° F (–20...100° C) @ max. ambient temp. of 122° F (50° C) Hard rubber: 32...178° F (0...80° C) @ max. ambient temp. of 122° F (50° C)
Ambient Temperature	– 4...122° F (–20...50° C)	
Altitude	Maximum 6500 ft (2000 m)	
Flow Direction	Uni-directional or Bi-directional	
Totalization	3 separate displayable totalizers, 10 digits (programmable forward, reverse and net)	
Units of Measure	U.S. gallons, imperial gallons, million gallons per day, cubic feet, cubic meters, liters, oil barrels, pounds, ounces, acre feet	
LCD Display	4 lines x 16 character alphanumeric, backlight; actively displays 3 totalizer values, flow rate, alarm status, output status, error / diagnostic messages	
Programming	Internal 3-button or external magnetic wand	
Field Wiring Entry Ports	(3) 1/2" NPT, internal thread	
Housing	Amplifier enclosure and remote junction enclosure: cast aluminum (powder-coated paint)	
Housing Rating	Amplifier enclosure and remote junction enclosure, NEMA 4X (IP66)	
Pipe Spool Material	316 stainless steel	
Spool Housing Material	Carbon steel, welded, NEMA 4 (IP66)	
Electrode Materials	Alloy C, 316 stainless steel, gold/platinum plated, tantalum, platinum/rhodium	
Liner Material	PFA from 1/4...3/8" (6...10 mm), PTFE from 1/2...12" (15...300 mm), Hard rubber from 1...12" (25...300 mm)	
Flange Material	Carbon steel or 316 stainless steel (ANSI B16.5 Class 150 RF)	
Coil Power	Pulsed DC	
Pressure Limits	Max. 150 psi (10 bar)	
Locations	Indoor and outdoor	
Mounting	Direct detector mount or remote wall mount, bracket included. For remote mount, max. cable distance = 100 ft (30 m)	
Junction Enclosure Material	(For remote mounted amplifier option) cast aluminum (powder coated paint), NEMA 4X (IP66)	
Grounding Electrode Material (optional)	Alloy C, 316 stainless steel, gold/platinum plated, tantalum, or platinum/rhodium	
Grounding Ring Material (optional, 2 required)	316 stainless steel or alloy C	
	Meter Size	Thickness (one ring)
	1/4...10" (6...250 mm)	0.135" (3.43 mm)
10...12" (250...600 mm)	0.187" (4.75 mm)	
Electrical Classification	FM approved for Class I, Div 1 Groups C-D, Class II, Div 1 Groups E, F & G – CSA Certified	
NSF Listed	Models with hard rubber liner, size 4" and larger; PTFE liner, all sizes	

Amplifier

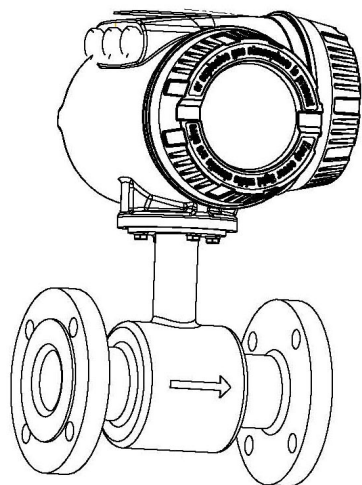

Figure 43: Detector mount amplifier

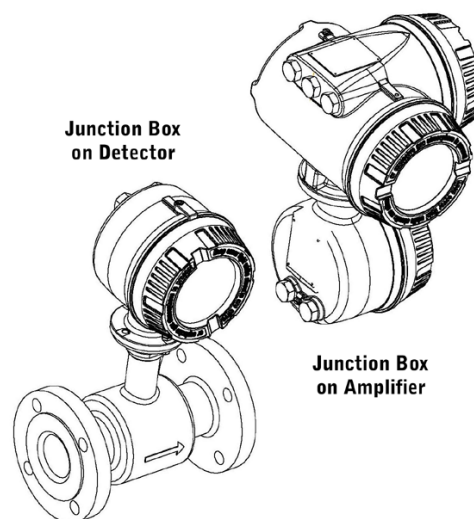

Figure 44: Remote mount amplifier

Power Supply	85...265V AC, 45...65 Hz
Power Consumption	20 W
Accuracy	± 0.25% of rate for velocities greater than 1.64 ft/s (0.50 m/s), ± 0.004 ft/s (± 0.001 m/s) for velocities less than 1.64 ft/s (0.50 m/s)
Repeatability	0.1% of rate
Flow Range	0.10...39.4 ft/s (0.03...12 m/s)
Fluid Conductivity	Min. 5.0 micromhos/cm
Flow Direction	Uni-directional or bi-directional (programmable)
Totalization	3 separate displayable totalizers, 10 digits (programmable forward, reverse and net)
Analog Outputs	0...10 mA, 0...20 mA, 4...20 mA (programmable and scalable), Voltage sourced (18V DC) – isolated, max. loop resistance = 750 Ω
Frequency Output	Open collector, max. full scale flow = 10 kHz
Digital Outputs	(2) Open collector, (programmable scaled pulse, flow alarm, status, or frequency output), max. 24V DC, 0.5 W (2) AC solid-state relay (programmable flow alarm or status), max. 24V DC @ 0.5 A
Pulse Width	Open collector, 5ms to 1 second (programmable) or automatic 50% duty cycle
Min-Max Flow Alarm	Open collector or solid-state relay (programmable 0...100% of flow)
Empty Pipe Detection	Field tunable for optimum performance based on specific application
Excitation Frequency	Programmable 3.75 Hz, 7.5 Hz or 15 Hz

Auxiliary Input	Max. 24V DC (programmable positive zero return, external totalizer reset or preset batch start)
Noise Dampening	1...30 seconds (programmable)
Units of Measure	U.S. gallons, imperial gallons, million gallons per day, cubic feet, cubic meters, liters, oil barrels, pounds, ounces, acre feet
Low Flow Cut-Off	0–100% of full scale (programmable)
Zero-Point Stability	Automatic correction
LC Display	4 lines x 16 character alphanumeric, backlight; actively displays 3 totalizer values, flow rate, alarm status, output status, error / diagnostic messages
Programming	Internal 3 button or external magnetic wand
Galvanic Separation	£ 500 volts
Electrical Classification	FM approved for Class I, Div 1, Groups B-D, Class II, Div 2, Groups E, F and G – CSA Certified
Housing	Amplifier enclosure and remote junction enclosure: cast aluminum (powder coated paint)
Housing Rating	Amplifier enclosure and remote junction enclosure – NEMA 4X (IP66)
Mounting	Direct detector mount or remote wall mount – bracket included. (for remote mount, max. cable distance = 100 ft (30 m))
Field Wiring Entry Ports	(3) 1/2" NPT, internal thread
Ambient Temperature	– 4...122° F (–20...50°C)
Communication	RS232C serial, standard ANSI terminal compatible data stream

INTENTIONAL BLANK PAGE

INTENTIONAL BLANK PAGE

Control. Manage. Optimize.

M-SERIES is registered trademark of Badger Meter, Inc. Other trademarks appearing in this document are the property of their respective entities. Due to continuous research, product improvements and enhancements, Badger Meter reserves the right to change product or system specifications without notice, except to the extent an outstanding contractual obligation exists. © 2018 Badger Meter, Inc. All rights reserved.

www.badgermeter.com

The Americas | Badger Meter | 4545 West Brown Deer Rd | PO Box 245036 | Milwaukee, WI 53224-9536 | 800-876-3837 | 414-355-0400
México | Badger Meter de las Americas, S.A. de C.V. | Pedro Luis Ogazón N°32 | Esq. Angelina N°24 | Colonia Guadalupe Inn | CP 01050 | México, DF | México | +52-55-5662-0882
Europe, Eastern Europe Branch Office (for Poland, Latvia, Lithuania, Estonia, Ukraine, Belarus) | Badger Meter Europe | ul. Korfantego 6 | 44-193 Knurów | Poland | +48-32-236-8787
Europe, Middle East and Africa | Badger Meter Europa GmbH | Nurtinger Str 76 | 72639 Neuffen | Germany | +49-7025-9208-0
Europe, Middle East Branch Office | Badger Meter Europe | PO Box 341442 | Dubai Silicon Oasis, Head Quarter Building, Wing C, Office #C209 | Dubai / UAE | +971-4-371 2503
Slovakia | Badger Meter Slovakia s.r.o. | Racianska 109/B | 831 02 Bratislava, Slovakia | +421-2-44 63 83 01
Asia Pacific | Badger Meter | 80 Marine Parade Rd | 21-06 Parkway Parade | Singapore 449269 | +65-63464836
China | Badger Meter | 7-1202 | 99 Hangzhong Road | Minhang District | Shanghai | China 201101 | +86-21-5763 5412
Switzerland | Badger Meter Swiss AG | Mittelholzerstrasse 8 | 3006 Bern | Switzerland | +41-31-932 01 11