

# Operating Instructions

## Cerabar PMP43

### 4-20mA analog

Process pressure measurement





- Make sure the document is stored in a safe place such that it is always available when working on or with the device
- Avoid danger to individuals or the facility: read the "Basic safety instructions" section carefully, as well as all other safety instructions in the document that are specific to working procedures

The manufacturer reserves the right to modify technical data without prior notice. The Endress+Hauser sales organization will supply you with current information and updates to these instructions.

## Table of contents

<b>1</b>	<b>About this document</b> .....	<b>4</b>	8.5	Commissioning via onsite display .....	20
1.1	Document function .....	4	8.6	Commissioning via additional operating tools (AMS, PDM, etc.) .....	21
1.2	Symbols .....	4	8.7	Configuring the operating language .....	21
1.3	List of abbreviations .....	5	8.8	Protecting settings from unauthorized access .....	22
1.4	Turn down calculation .....	6			
1.5	Documentation .....	7			
1.6	Registered trademarks .....	7			
<b>2</b>	<b>Basic safety instructions</b> .....	<b>7</b>	<b>9</b>	<b>Operation</b> .....	<b>22</b>
2.1	Requirements for the personnel .....	7	9.1	Reading off the device locking status .....	22
2.2	Intended use .....	7	9.2	Adapting the device to process conditions ....	23
2.3	Occupational safety .....	8	9.3	Sensor calibration .....	24
2.4	Operational safety .....	8			
2.5	Product security .....	8	<b>10</b>	<b>Diagnostics and troubleshooting</b> ...	<b>24</b>
2.6	IT security .....	9	10.1	General troubleshooting .....	24
2.7	Device-specific IT security .....	9	10.2	Diagnostic information on operating status LED .....	26
<b>3</b>	<b>Product description</b> .....	<b>10</b>	10.3	Diagnostic information on onsite display ....	27
3.1	Product design .....	10	10.4	Diagnostic event in the operating tool .....	28
<b>4</b>	<b>Incoming acceptance and product identification</b> .....	<b>10</b>	10.5	Adapting the diagnostic information .....	28
4.1	Incoming acceptance .....	10	10.6	Pending diagnostic messages .....	28
4.2	Product identification .....	11	10.7	Diagnostic list .....	28
4.3	Storage and transport .....	11	10.8	Event logbook .....	31
<b>5</b>	<b>Mounting procedure</b> .....	<b>12</b>	10.9	Device reset .....	32
5.1	Mounting requirements .....	12	10.10	Firmware history .....	32
5.2	Orientation .....	12	<b>11</b>	<b>Maintenance</b> .....	<b>33</b>
5.3	Post-mounting checks .....	12	11.1	Maintenance work .....	33
<b>6</b>	<b>Electrical connection</b> .....	<b>13</b>	<b>12</b>	<b>Repair</b> .....	<b>33</b>
6.1	Connecting the device .....	13	12.1	General notes .....	33
6.2	Ensuring the degree of protection .....	14	12.2	Return .....	33
6.3	Post-connection check .....	14	12.3	Disposal .....	34
<b>7</b>	<b>Operation options</b> .....	<b>15</b>	<b>13</b>	<b>Accessories</b> .....	<b>34</b>
7.1	Overview of operation options .....	15	13.1	Device-specific accessories .....	34
7.2	Access to operating menu via LED display ....	15	13.2	DeviceCare SFE100 .....	35
7.3	Access to operating menu via onsite display ..	17	13.3	FieldCare SFE500 .....	35
7.4	Onsite display, locking or unlocking procedure .....	18	13.4	Device Viewer .....	35
7.5	Operation via SmartBlue App .....	18	13.5	Field Xpert SMT70 .....	35
<b>8</b>	<b>Commissioning</b> .....	<b>19</b>	13.6	Field Xpert SMT77 .....	35
8.1	Preliminaries .....	19	13.7	SmartBlue app .....	35
8.2	Installation and function check .....	19	<b>14</b>	<b>Technical data</b> .....	<b>36</b>
8.3	Overview of commissioning options .....	20	14.1	Input .....	36
8.4	Commissioning via LED display operating key .....	20	14.2	Output .....	37
			14.3	Environment .....	38
			14.4	Process .....	41
			<b>Index</b> .....	<b>43</b>	

# 1 About this document

## 1.1 Document function

These Operating Instructions contain all the information required in the various life cycle phases of the device: from product identification, incoming acceptance and storage, to installation, connection, operation and commissioning, through to troubleshooting, maintenance and disposal.

## 1.2 Symbols

### 1.2.1 Safety symbols

** DANGER**

This symbol alerts you to a dangerous situation. Failure to avoid this situation will result in serious or fatal injury.

** WARNING**

This symbol alerts you to a potentially dangerous situation. Failure to avoid this situation can result in serious or fatal injury.

** CAUTION**

This symbol alerts you to a potentially dangerous situation. Failure to avoid this situation can result in minor or medium injury.

**NOTICE**

This symbol alerts you to a potentially harmful situation. Failure to avoid this situation can result in damage to the product or something in its vicinity.

### 1.2.2 Communication-specific symbols

**Bluetooth®: **

Wireless data transmission between devices over a short distance.

### 1.2.3 Symbols for certain types of Information

**Permitted: **

Procedures, processes or actions that are permitted.

**Forbidden: **

Procedures, processes or actions that are forbidden.

**Additional information:** 

**Reference to documentation:** 

**Reference to page:** 

**Series of steps:** [1](#), [2](#), [3](#)

**Result of an individual step:** 

## 1.2.4 Symbols in graphics

**Item numbers:** 1, 2, 3 ...

**Series of steps:** [1](#), [2](#), [3](#)

**Views:** A, B, C, ...

## 1.3 List of abbreviations

### **PN**

Nominal pressure

### **DTM**

Device Type Manager

### **PLC**

Programmable logic controller (PLC)

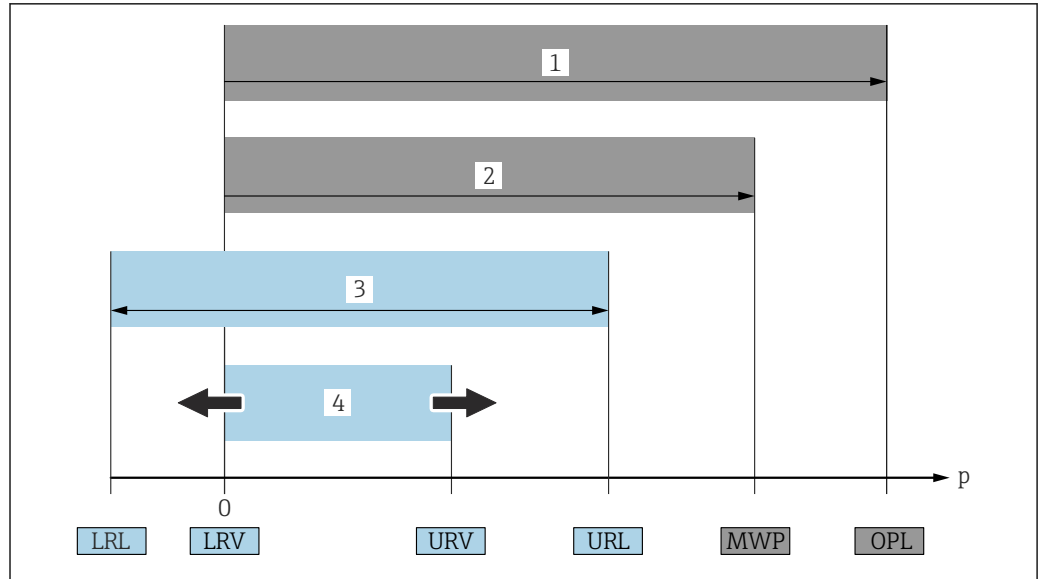

A0029505

- 1 OPL: The OPL (overpressure limit = measuring cell overload limit) for the device depends on the lowest-rated element, with regard to pressure, of the selected components, i.e. the process connection must be taken into consideration in addition to the measuring cell. Pay attention to the pressure-temperature dependency. The OPL may only be applied for a short period of time.
  - 2 MWP: The MWP (maximum working pressure) for the measuring cells depends on the lowest-rated element, with regard to pressure, of the selected components, i.e. the process connection also has to be taken into consideration besides the measuring cell. Pay attention to the pressure-temperature dependency. The maximum working pressure may be applied at the device for an unlimited period of time. The maximum working pressure can be found on the nameplate.
  - 3 The maximum measuring range corresponds to the span between the LRL and URL. This measuring range is equivalent to the maximum span that can be calibrated/adjusted.
  - 4 The calibrated/adjusted span corresponds to the span between the LRV and URV. Factory setting: 0 to URL. Other calibrated spans can be ordered as customized spans.
- p Pressure  
 LRL Lower range limit  
 URL Upper range limit  
 LRV Lower range value  
 URV Upper range value  
 TD Turn down Example - see the following section.

## 1.4 Turn down calculation

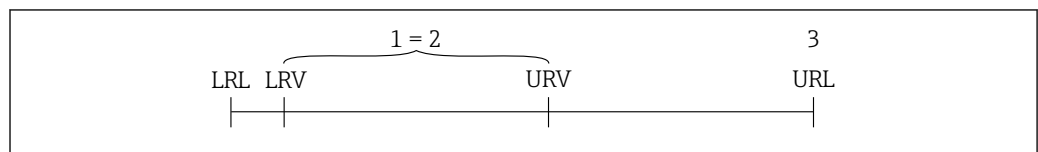

A0029545

- 1 Calibrated/adjusted span
- 2 Zero point-based span
- 3 Upper range limit

Example:

- Measuring cell: 10 bar (150 psi)
- Upper range limit (URL) = 10 bar (150 psi)
- Calibrated/adjusted span: 0 to 5 bar (0 to 75 psi)
- Lower range value (LRV) = 0 bar (0 psi)
- Upper range value (URV) = 5 bar (75 psi)

$$TD = \frac{URL}{|URV - LRV|}$$

In this example, the TD is therefore 2:1. This measuring span is based on the zero point.

## 1.5 Documentation

 For an overview of the scope of the associated Technical Documentation, refer to the following:

- *Device Viewer* ([www.endress.com/deviceviewer](http://www.endress.com/deviceviewer)): Enter the serial number from the nameplate
- *Endress+Hauser Operations app*: Enter serial number from nameplate or scan matrix code on nameplate.

## 1.6 Registered trademarks

### Apple®

Apple, the Apple logo, iPhone, and iPod touch are trademarks of Apple Inc., registered in the U.S. and other countries. App Store is a service mark of Apple Inc.

### Android®

Android, Google Play and the Google Play logo are trademarks of Google Inc.

### Bluetooth®

The *Bluetooth*® word mark and logos are registered trademarks owned by the Bluetooth SIG, Inc. and any use of such marks by Endress+Hauser is under license. Other trademarks and trade names are those of their respective owners.

# 2 Basic safety instructions

## 2.1 Requirements for the personnel

The personnel for installation, commissioning, diagnostics and maintenance must fulfill the following requirements:

- ▶ Trained, qualified specialists must have a relevant qualification for this specific function and task.
- ▶ Are authorized by the plant owner/operator.
- ▶ Are familiar with federal/national regulations.
- ▶ Before starting work, read and understand the instructions in the manual and supplementary documentation as well as the certificates (depending on the application).
- ▶ Follow instructions and comply with basic conditions.

The operating personnel must fulfill the following requirements:

- ▶ Are instructed and authorized according to the requirements of the task by the facility's owner-operator.
- ▶ Follow the instructions in this manual.

## 2.2 Intended use

The Cerabar is a pressure transmitter for measuring level and pressure.

### Incorrect use

The manufacturer is not liable for harm caused by improper or unintended use.

Avoid mechanical damage:

- ▶ Do not touch or clean device surfaces with pointed or hard objects.

Clarification for borderline cases:

- ▶ For special fluids and fluids for cleaning: Endress+Hauser is glad to provide assistance in verifying the corrosion resistance of fluid-wetted materials, but does not accept any warranty or liability.

### **Residual risks**

During operation, the housing can heat up to 80 °C (176 °F) due to heat transfer from the process and power loss in the electronics. When in operation, the sensor can reach a temperature close to the medium temperature.

Danger of burns from contact with surfaces!

- ▶ In the event of elevated fluid temperatures, ensure protection against contact to prevent burns.

## **2.3 Occupational safety**

When working on and with the device:

- ▶ Wear the required personal protective equipment as per national regulations.
- ▶ Switch off the supply voltage before connecting the device.

## **2.4 Operational safety**

Risk of injury!

- ▶ Operate the device only if it is in proper technical condition, free from errors and faults.
- ▶ The operator is responsible for trouble-free operation of the device.

### **Modifications to the device**

Unauthorized modifications to the device are not permitted and can lead to unforeseeable dangers:

- ▶ If modifications are nevertheless required, consult with the manufacturer.

### **Repair**

To ensure continued operational safety and reliability:

- ▶ Only use original accessories.

### **Hazardous area**

To eliminate the risk of danger to persons or the facility when the device is used in the approval-related area (e.g. explosion protection, pressure equipment safety):

- ▶ Check the nameplate to verify if the device ordered can be put to its intended use in the hazardous area.
- ▶ Comply with the instructions in the separate supplementary documentation, which is an integral part of this manual.

## **2.5 Product security**

This state-of-the-art device is designed and tested in accordance with good engineering practice to meet operational safety standards. It left the factory in a condition in which it is safe to operate.

The device fulfills general safety requirements and legal requirements. It also complies with the EU directives listed in the device-specific EU declaration of conformity.

Endress+Hauser confirms this fact by affixing the CE mark to the device.



## 2.6 IT security

Our warranty is valid only if the product is installed and used as described in the Operating Instructions. The product is equipped with security mechanisms to protect it against any inadvertent changes to the settings.

IT security measures, which provide additional protection for the product and associated data transfer, must be implemented by the operators themselves in line with their security standards.

## 2.7 Device-specific IT security

The device offers specific functions to support protective measures by the operator. These functions can be configured by the user and guarantee greater in-operation safety if used correctly. The user role can be changed with an access code (applies to operation via the onsite display, Bluetooth or FieldCare, DeviceCare, asset management tools e.g. AMS, PDM).

### 2.7.1 Access via Bluetooth® wireless technology

Secure signal transmission via Bluetooth® wireless technology uses an encryption method tested by the Fraunhofer Institute.

- Without the SmartBlue app, the device is not visible via Bluetooth® wireless technology.
- Only one point-to-point connection is established between the device and a smartphone or tablet.
- The Bluetooth® wireless technology interface can be disabled via local operation or via SmartBlue/FieldCare/DeviceCare.

## 3 Product description

### 3.1 Product design

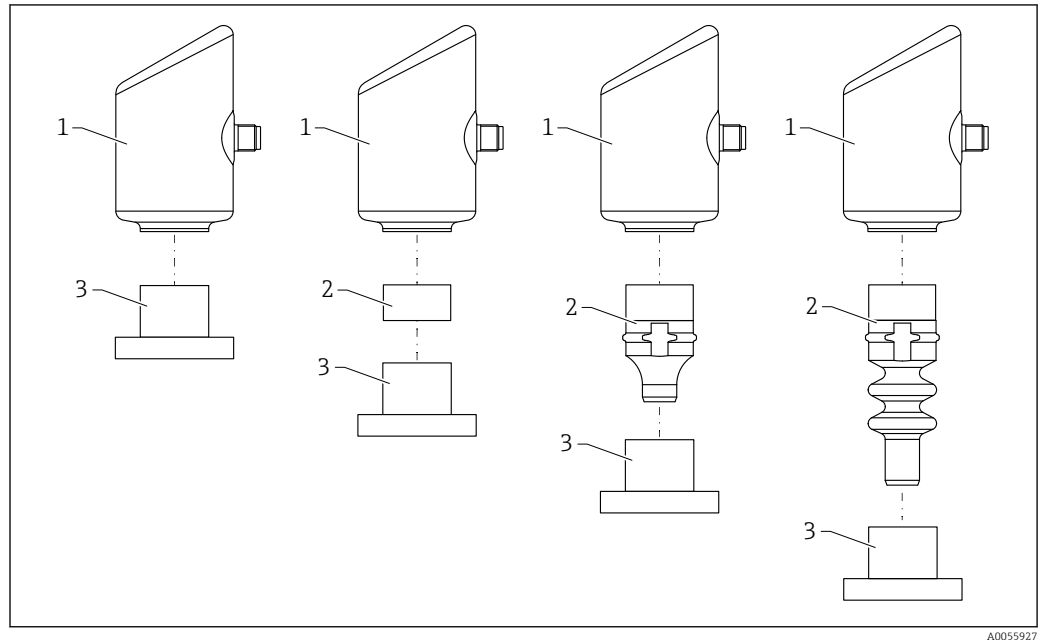

A0055927

- 1 Housing  
 2 Configuration-dependent mounted parts  
 3 Process connection

## 4 Incoming acceptance and product identification

### 4.1 Incoming acceptance

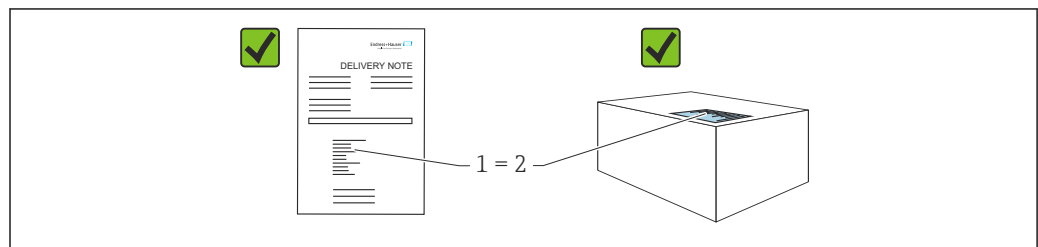

A0016870

Check the following during incoming acceptance:

- Is the order code on the delivery note (1) identical to the order code on the product sticker (2)?
- Are the goods undamaged?
- Do the data on the nameplate correspond to the order specifications and the delivery note?
- Is the documentation provided?
- If required (see nameplate), are the Safety Instructions (XA) provided?



If one of these conditions is not met, please contact the manufacturer's sales office.

## 4.2 Product identification

The following options are available for identification of the device:

- Nameplate specifications
- Order code with breakdown of the device features on the delivery note
- Enter the serial numbers from the nameplates in *Device Viewer* ([www.endress.com/deviceviewer](http://www.endress.com/deviceviewer)): all the information about the device is displayed.

### 4.2.1 Nameplate

The information that is required by law and is relevant to the device is shown on the nameplate, e.g.:

- Manufacturer identification
- Order number, extended order code, serial number
- Technical data, degree of protection
- Firmware version, hardware version
- Approval-specific information
- DataMatrix code (information about the device)

Compare the data on the nameplate with your order.

### 4.2.2 Manufacturer address

Endress+Hauser SE+Co. KG

Hauptstraße 1

79689 Maulburg, Germany

Place of manufacture: See nameplate.

## 4.3 Storage and transport

### 4.3.1 Storage conditions

- Use the original packaging
- Store the device in clean and dry conditions and protect from damage caused by shocks

#### Storage temperature

-40 to +85 °C (-40 to +185 °F)

### 4.3.2 Transporting the product to the measuring point

#### **WARNING**

#### **Incorrect transport!**

Housing and membrane may become damaged, and there is a risk of injury!

- ▶ Transport the device to the measuring point in the original packaging.

## 5 Mounting procedure

### 5.1 Mounting requirements

#### 5.1.1 Mounting instructions

**i** During installation, it is important to ensure that the sealing element used has a permanent operating temperature that corresponds to the maximum temperature of the process.

- Devices with CSA approval are intended for indoor use.  
Devices are suitable for use in wet environments in accordance with IEC/EN 61010-1.
- Orient the onsite display using the operating menu to ensure optimum readability.
- The onsite display can be adapted to the light conditions (for color scheme, see  operating menu).
- The devices are mounted according to the same guidelines as manometers.
- Protect housing against impact.

### 5.2 Orientation

#### NOTICE

If a heated device is cooled during a cleaning process (e.g. by cold water), a vacuum develops for a short time. Moisture can get into the measuring cell via the pressure compensation filter (1) as a result of the vacuum. Whether or not a filter element is installed depends on the device version.

Device could be destroyed!

- ▶ Mount the device as follows.

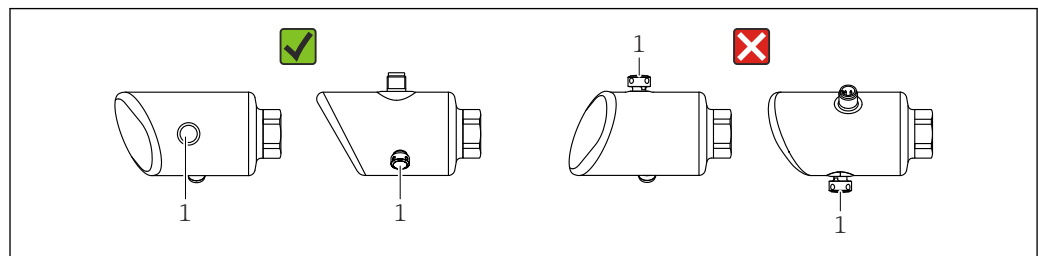

A0054016

- Keep the filter element (1) free from contamination.
- The orientation of the device depends on the measuring application.
- A position-dependent zero point shift (when the vessel is empty the measured value does not display zero) can be corrected

### 5.3 Post-mounting checks

- Is the device undamaged (visual inspection)?
- Are the measuring point identification and labeling correct (visual inspection)?
- Is the device properly secured?
- Is the filter element pointing downwards at an angle or to the side?
- Does the device comply with the measuring point specifications?

For example:

- Process temperature
- Pressure
- Ambient temperature

- Measuring range

## 6 Electrical connection

### 6.1 Connecting the device

#### 6.1.1 Potential equalization

If necessary, establish potential equalization using the process connection or the grounding clamp supplied by the customer.

#### 6.1.2 Supply voltage

12 to 30 V<sub>DC</sub> on a direct current power unit

 The power unit must be safety-approved (e.g. PELV, SELV, Class 2) and must comply with the relevant protocol specifications.

For 4 to 20 mA, the same requirements apply as for HART. A galvanically isolated active barrier must be used for devices approved for use in explosion hazardous areas.

Protective circuits against reverse polarity, HF influences and overvoltage peaks are installed.

#### 6.1.3 Power consumption

Non-hazardous area: To meet device safety specifications according to the IEC/EN 61010 standard, the installation must ensure that the maximum current is limited to 500 mA.

#### 6.1.4 Overvoltage protection

The device satisfies the IEC/DIN EN IEC 61326-1 product standard (Table 2 Industrial environment). Depending on the type of port (DC supply, input/output port) different test levels against transient overvoltages (IEC/DIN EN 61000-4-5 Surge) are applied according to IEC/DIN EN 61326-1: Test level on DC power ports and input/output ports is 1000 V line to earth.

#### Overvoltage protection category

According to IEC/DIN EN 61010-1, the device is intended for use in overvoltage protection category II networks.

### 6.1.5 Terminal assignment

#### **⚠ WARNING**

#### Supply voltage might be connected!

Risk of electric shock and/or explosion

- ▶ Ensure that no supply voltage is applied when connecting.
- ▶ The supply voltage must match the specifications on the nameplate.
- ▶ A suitable circuit breaker should be provided for the device in accordance with IEC/EN 61010.
- ▶ The cables must be adequately insulated, with due consideration given to the supply voltage and the overvoltage category.
- ▶ The connecting cables must offer adequate temperature stability, with due consideration given to the ambient temperature.
- ▶ Protective circuits against reverse polarity, HF influences and overvoltage peaks are installed.

#### **⚠ WARNING**

#### Electrical safety is compromised by an incorrect connection.

- ▶ Non-hazardous area: To meet device safety specifications according to the IEC/EN 61010 standard, the installation must ensure that the maximum current is limited to 500 mA.

Connect the device in the following order:

1. Check that the supply voltage corresponds to the supply voltage indicated on the nameplate.
2. Connect the device as indicated in the following diagram.
3. Switch on the supply voltage.

#### 2-wire

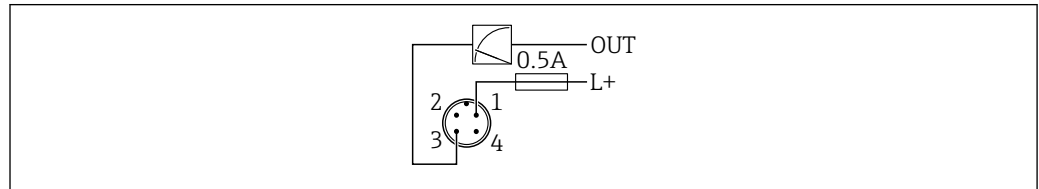

A0052662

- 1 Supply voltage L+, brown wire (BN)  
3 OUT (L-), blue wire (BU)

## 6.2 Ensuring the degree of protection

For mounted M12 connecting cable: IP66/68/69, NEMA type 4X/6P

#### **NOTICE**

#### Loss of IP protection class due to incorrect installation!

- ▶ The degree of protection only applies if the connecting cable used is plugged in and screwed tight.
- ▶ The degree of protection only applies if the connecting cable used is specified according to the intended protection class.

## 6.3 Post-connection check

- Is the device or cable undamaged (visual check)?
- Does the cable used comply with the requirements?
- Is the mounted cable strain-relieved?

- Is the screw connection properly mounted?
- Does the supply voltage match the specifications on the nameplate?
- No reverse polarity, terminal assignment correct?
- If supply voltage is present: is the device ready for operation and does an indication appear on the onsite display or is the green operating status LED lit?

## 7 Operation options

### 7.1 Overview of operation options

- Operation via LED display operating key
- Operation via onsite display
- Operation via Bluetooth®

### 7.2 Access to operating menu via LED display

#### 7.2.1 Overview

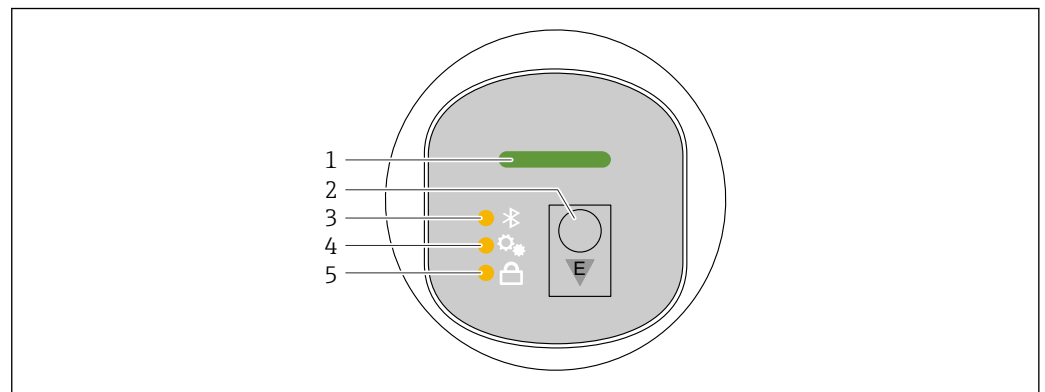

- 1 Operating status LED
- 2 Operating key "E"
- 3 Bluetooth LED
- 4 Position adjustment LED
- 5 Keypad lock LED

 Operation on the LED display is not possible when the Bluetooth connection is active.

#### Operating status LED (1)

See diagnostic events section.

#### Bluetooth LED (3)

- LED lit: Bluetooth enabled
- LED not lit: Bluetooth disabled or Bluetooth option not ordered
- LED flashing: Bluetooth connection established

#### Keypad lock LED (5)

- LED lit: Key locked
- LED not lit: Key released

## 7.2.2 Operation

The device is operated by pressing operating key "E" briefly (< 2 s) or pressing and holding it (> 2 s).

### Navigation

- The LED for the selected function flashes
- Press the "E" operating key briefly to switch between the functions
- Press and hold down the "E" operating key to select a particular function

*Flashing behavior of LEDs (active/inactive)*

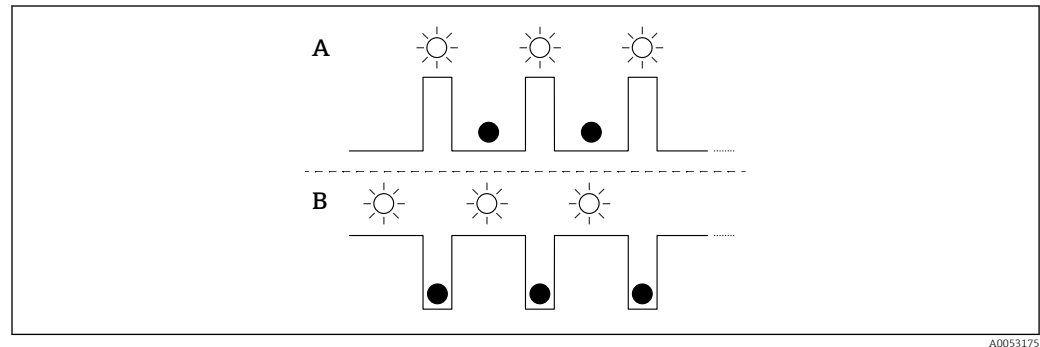

- A Function selected but not active  
 B Function selected and active

### Disabling the keypad lock

1. Press and hold down operating key "E".  
↳ Bluetooth LED flashes.
2. Briefly press operating key "E" repeatedly until the keypad lock LED flashes.
3. Press and hold down operating key "E".  
↳ Keypad lock is disabled.

### Enabling or disabling Bluetooth

1. If necessary, disable the keypad lock.
2. Repeatedly press the "E" key briefly until the Bluetooth LED flashes.
3. Press and hold down operating key "E".  
↳ Bluetooth is enabled (Bluetooth LED is lit) or Bluetooth is disabled (Bluetooth LED goes out).



## 7.3 Access to operating menu via onsite display

Functions:

- Display measured values, also fault and notice messages
- Display a symbol in the event of an error
- Electronically adjustable onsite display (automatic or manual adjustment of display in 90° increments)
  - The measured value display rotates automatically depending on the orientation when the device is started. <sup>1)</sup>
- Basic settings via the onsite display with touch control <sup>2)</sup>
  - Locking On/Off
  - Select the operating language
  - Bluetooth On/Off
  - Commissioning wizard for basic settings
  - Read the device information, such as the name, serial number and firmware version
  - Active diagnosis and status
  - Device reset
  - Invert colors for bright lighting conditions

The backlighting is automatically adjusted depending on the terminal voltage.

**i** The following figure is an example. The display depends on the settings of the onsite display.

Optional display by swiping from left to right (see A, B and C in the following graphic): The swiping motion only works if the display has been ordered with touch control and the display has been unlocked beforehand.

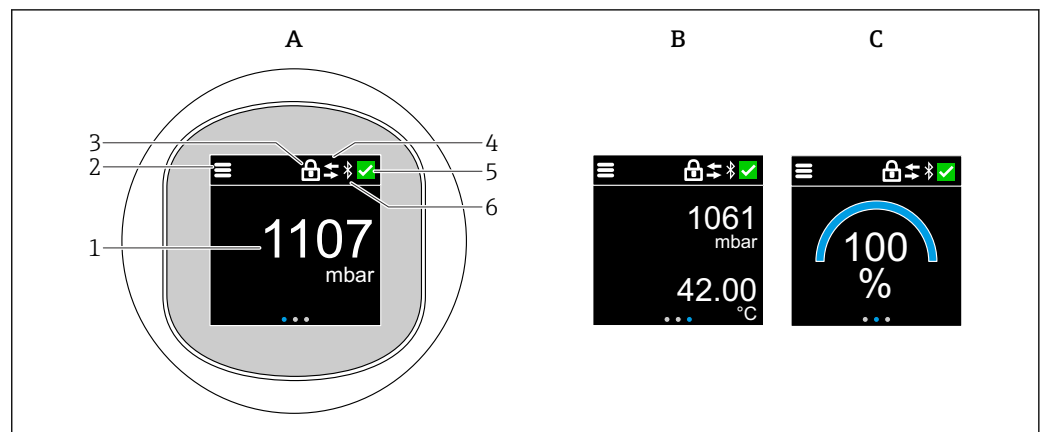

A0052427

- A Standard display: 1 measured value with unit (adjustable)
- B 2 measured values, each with unit (adjustable)
- C Graphic measured value display in %
- 1 Measured value
- 2 Menu or home symbol
- 3 Locking (locking only visible if locked via "Safety mode" wizard. "Safety mode" wizard is available if the WHG option has been selected.)
- 4 Communication (symbol appears if communication is enabled)
- 5 Diagnostic symbol
- 6 Bluetooth (symbol flashes when Bluetooth connection is enabled)

The standard display can be permanently set via the operating menu.

1) The measured value display only rotates automatically if automatic alignment is switched on.

2) For devices without touch control, settings can be made using operating tools (FieldCare, DeviceCare, SmartBlue).

### 7.3.1 Operation

#### Navigation

Navigation by swiping with finger.

**i** Operation via the LED indicator is not possible if the Bluetooth connection is enabled.

#### Selecting option and confirming

Select the required option and confirm using the checkmark at the top right (see screens below).

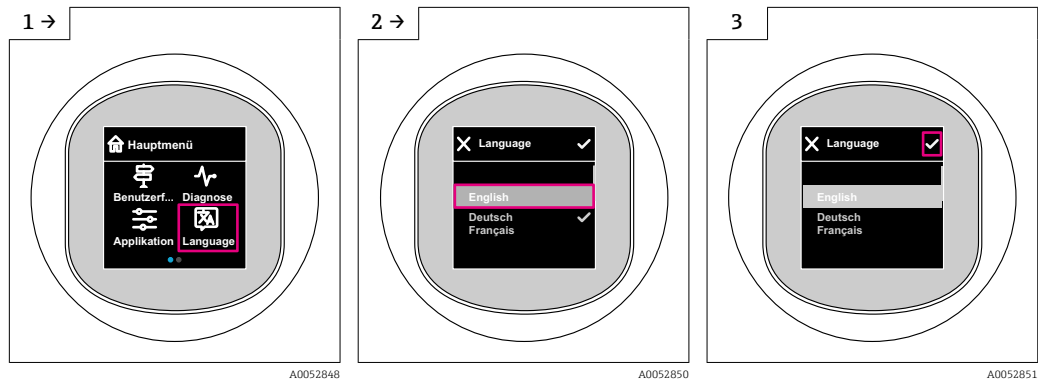

## 7.4 Onsite display, locking or unlocking procedure

### 7.4.1 Unlocking procedure

1. Tap the center of the display for the following view:

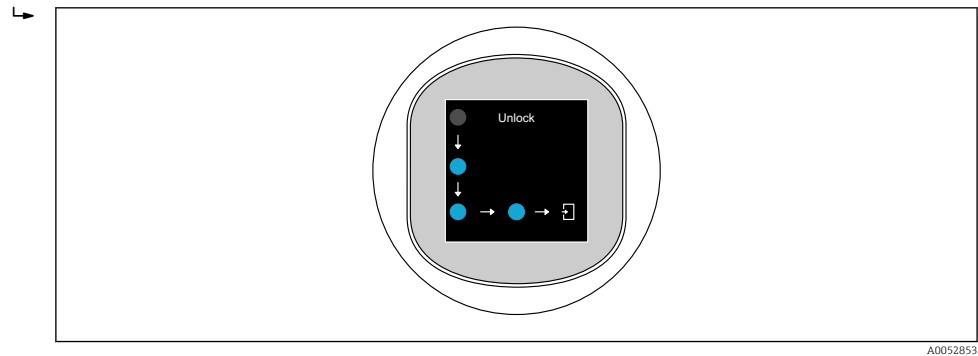

2. Use a finger to follow the arrows without interruption.  
 ↳ The display is unlocked.

### 7.4.2 Locking procedure

**i** Operation locks automatically (except in **Safety mode** wizard):

- after 1 min on the main page
- after 10 min within the operating menu

## 7.5 Operation via SmartBlue App

The device can be operated and configured with the SmartBlue App.

- The SmartBlue App must be downloaded onto a mobile device for this purpose.
- For information on the compatibility of the SmartBlue App with mobile devices, see **Apple App Store (iOS devices)** or **Google Play Store (Android devices)**.
- Incorrect operation by unauthorized persons is prevented by means of encrypted communication and password encryption.
- The Bluetooth® function can be deactivated after initial device setup.

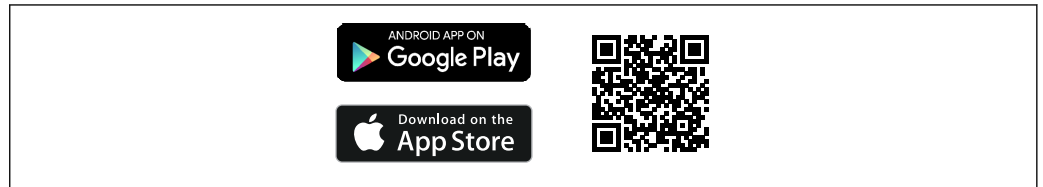



A0033202

 1 QR code for free Endress+Hauser SmartBlue App

Download and installation:

1. Scan the QR code or enter **SmartBlue** in the search field of the Apple App Store (iOS) or Google Play Store (Android).
2. Install and start the SmartBlue App.
3. For Android devices: enable location tracking (GPS) (not required for iOS devices).
4. Select a device that is ready to receive from the device list displayed.

Login:

1. Enter the user name: admin
  2. Enter the initial password: serial number of the device
-  Change the password after logging in for the first time.
  -  Forgotten your password? Contact Endress+Hauser Service.

## 8 Commissioning

### 8.1 Preliminaries

#### WARNING

Settings on the current output can result in a safety-related condition (e.g., product overflow)!

- ▶ Check current output settings.
- ▶ The setting of the current output depends on the setting in the **Assign PV** parameter.

### 8.2 Installation and function check

Before commissioning the measuring point, check that the post-installation and post-connection checks have been performed:

-  "Post-mounting check" section
-  "Post-connection check" section

### 8.3 Overview of commissioning options

- Commissioning via LED display operating key
- Commissioning via onsite display (optional)
- Commissioning with the SmartBlue app
- Commissioning via additional operating tools (AMS, PDM, etc.)

### 8.4 Commissioning via LED display operating key

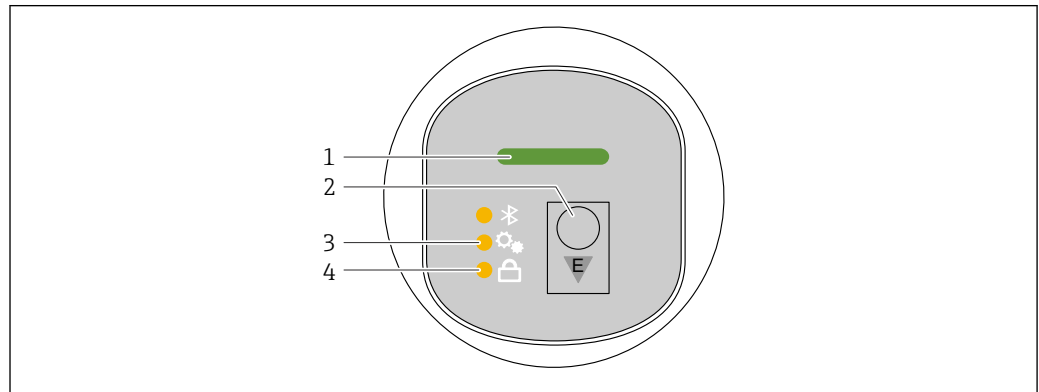

- 1 Operating status LED
- 2 Operating key "E"
- 3 Position adjustment LED
- 4 Keypad lock LED

1. If necessary, disable the keypad lock (see  section "Access to operating menu via LED display" > "Operation").
2. Repeatedly press the "E" key briefly until the position adjustment LED flashes.
3. Press the "E" key for longer than 4 seconds.
  - ↳ Position adjustment LED is activated.
 The position adjustment LED flashes during activation. The keypad lock LED and Bluetooth LED are off.

Once activated successfully, the position adjustment LED lights up continuously for 12 seconds. The keypad lock LED and Bluetooth LED are off.

If not successfully activated, the position adjustment LED, keypad lock LED and Bluetooth LED flash quickly for 12 seconds.

### 8.5 Commissioning via onsite display

1. If necessary, enable operation (see  section "Onsite display, locking or unlocking procedure" > "Unlocking").
2. Start **Commissioning** wizard (see graphic below).

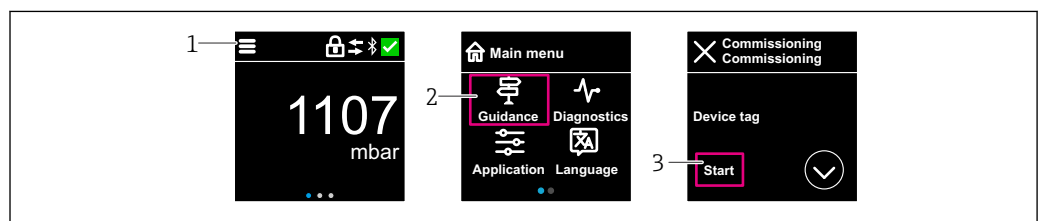

- 1 Press the menu icon.
- 2 Press "Guidance" menu.
- 3 Start "Commissioning" wizard.

### 8.5.1 Notes on "Commissioning" wizard

The **Commissioning** wizard enables simple, user-guided commissioning.

1. Once you have started the **Commissioning** wizard, enter the appropriate value in each parameter or select the appropriate option. These values are written directly to the device.
  2. Click > to go to the next page.
  3. Once all pages have been completed, click OK to close the **Commissioning** wizard.
- i** If the **Commissioning** wizard is canceled before all necessary parameters have been configured, the device may be in an undefined state. In such situations, it is advisable to reset the device to the factory default settings.

## 8.6 Commissioning via additional operating tools (AMS, PDM, etc.)

Download the device-specific drivers: <https://www.endress.com/en/downloads>

For more details, see the help for the relevant operating tool.

## 8.7 Configuring the operating language

### 8.7.1 Onsite display

**Configuring the operating language**

**i** Before you can set the operating language, you must first unlock the onsite display:

1. Open the operating menu.
2. Select the Language button.

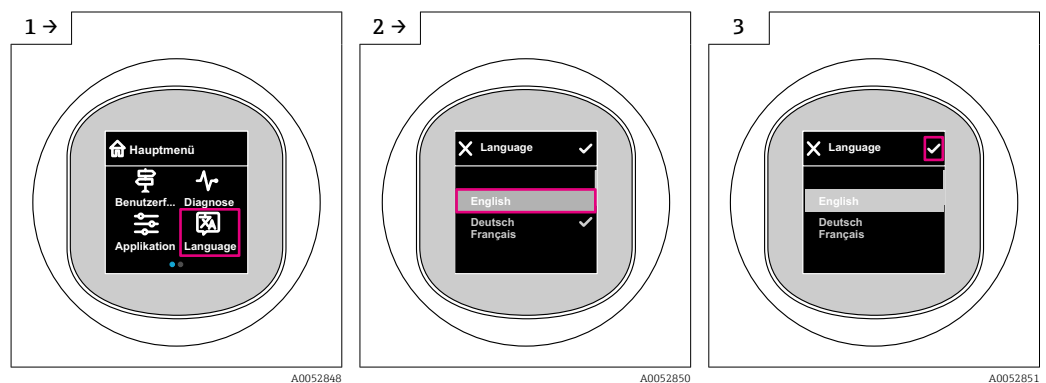

### 8.7.2 Operating tool

Set display language

System → Display → Language

## 8.8 Protecting settings from unauthorized access

### 8.8.1 Software locking or unlocking

#### Locking via password in SmartBlue app

Access to parameter configuration of the device can be locked by assigning a password. When the device is delivered from the factory, the user role is set to **Maintenance** option. The device can be configured completely with the **Maintenance** option user role. Afterwards, access to the configuration can be locked by assigning a password. The **Maintenance** option switches to the **Operator** option as a result of this locking. The configuration can be accessed by entering the password.

The password is defined under:

**System** menu **User management** submenu

The user role is changed from the **Maintenance** option to **Operator** option under:

System → User management

#### Canceling the locking procedure via onsite display/SmartBlue app

After entering the password, you can enable parameter configuration of the device as an **Operator** option with the password. The user role then changes to **Maintenance** option.

If necessary, the password can be deleted in User management: System → User management

## 9 Operation

### 9.1 Reading off the device locking status

#### 9.1.1 LED indicator

Keypad lock LED

-  LED lit: Device is locked
-  LED not lit: Device is unlocked

#### 9.1.2 Onsite display

Onsite display locked:

The main page does **not** display the menu symbol   

#### 9.1.3 Operating tool

 Operating tool (FieldCare/DeviceCare/FieldXpert/SmartBlue app)

Navigation: System → Device management → Locking status

## 9.2 Adapting the device to process conditions

The following menus are available for this purpose:

- Basic settings in the **Guidance** menu
- Advanced settings in:
  - **Diagnostics** menu
  - **Application** menu
  - **System** menu



For details, see the "Description of device parameters" documentation.

## 9.3 Sensor calibration <sup>3)</sup>

In the course of their life cycle, pressure measuring cells **can** deviate, or drift, <sup>4)</sup> from the original pressure characteristic curve. This deviation depends on the operating conditions and can be corrected in the **Sensor calibration** submenu.

Set the value of the zero point shift before the Sensor calibration to 0.00. Application  
→ Sensor → Sensor calibration → Zero adjustment offset

1. Apply the lower pressure value (value measured with pressure reference) to the device. Enter this pressure value in the **Lower sensor trim** parameter. Application  
→ Sensor → Sensor calibration → Lower sensor trim  
↳ The value entered causes a parallel shift of the pressure characteristic in relation to the current Sensor calibration.
2. Apply the upper pressure value (value measured with pressure reference) to the device. Enter this pressure value in the **Upper sensor trim** parameter. Application  
→ Sensor → Sensor calibration → Upper sensor trim  
↳ The value entered causes a change in the slope of the current Sensor calibration.

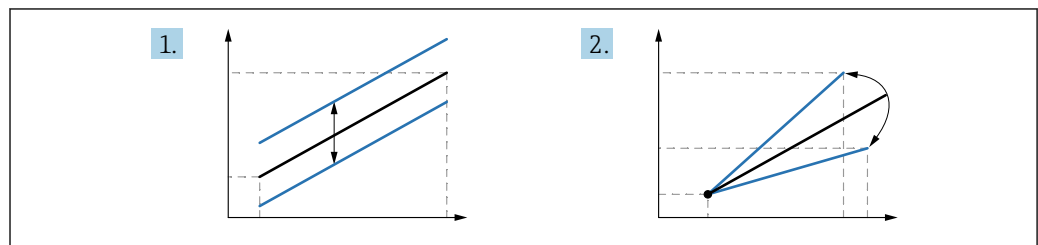

A0052045

**i** The accuracy of the pressure reference determines the accuracy of the device. The pressure reference must be more accurate than the device.

# 10 Diagnostics and troubleshooting

## 10.1 General troubleshooting

### 10.1.1 General errors

#### Device fails to start

- Possible cause: Supply voltage does not match the specification on the nameplate  
Remedial action: Apply the correct voltage
- Possible cause: The polarity of the supply voltage is wrong  
Remedial action: Correct the polarity
- Possible cause: Load resistance too high  
Remedial action: Increase the supply voltage to reach the minimum terminal voltage

**"Communication error" appears on the onsite display or LEDs flash when the device is started.**

Possible cause: Electromagnetic interference influence  
Remedial action: Check grounding of the device

<sup>3)</sup> Not possible with color display

<sup>4)</sup> Deviations caused by physical factors are also known as "Sensor drift".



### 10.1.2 Error - SmartBlue operation with Bluetooth®

Operation via SmartBlue is only possible on devices that have a display with Bluetooth (optionally available).

#### Device is not visible in the live list

- Possible cause: No Bluetooth connection available  
Remedial action: Enable Bluetooth in the field device via display or software tool and/or in the smartphone/tablet
- Possible cause: Bluetooth signal outside range  
Remedial action: Reduce distance between field device and smartphone/tablet  
The connection has a range of up to 25 m (82 ft)  
Operating radius with intervisibility 10 m (33 ft)
- Possible cause: Geopositioning is not enabled on Android devices or is not permitted for the SmartBlue app  
Remedial action: Enable/permit the geopositioning service on Android device for the SmartBlue app
- Display does not have Bluetooth

#### Device appears in the live list but a connection cannot be established

- Possible cause: The device is already connected with another smartphone/tablet via Bluetooth  
Only one point-to-point connection is permitted  
Remedial action: Disconnect the smartphone/tablet from the device
- Possible cause: Incorrect user name and password  
Remedial action: The standard user name is "admin" and the password is the device serial number indicated on the device nameplate (only if the password was not changed by the user beforehand)  
If the password has been forgotten, contact Endress+Hauser Service ([www.addresses.endress.com](http://www.addresses.endress.com))

#### Connection via SmartBlue not possible

- Possible cause: Incorrect password entered  
Remedial action: Enter the correct password, paying attention to lower/upper case
- Possible cause: Forgotten password  
If the password has been forgotten, contact Endress+Hauser Service ([www.addresses.endress.com](http://www.addresses.endress.com))

#### Login via SmartBlue not possible

- Possible cause: Device is being put into operation for the first time  
Remedial action: Enter the user name "admin" and the password (device serial number), paying attention to lower/upper case
- Possible cause: The electric current and voltage are not correct.  
Remedial action: Increase the supply voltage.

#### Device cannot be operated via SmartBlue

- Possible cause: Incorrect password entered  
Remedial action: Enter the correct password, paying attention to lower/upper case
- Possible cause: Forgotten password  
If the password has been forgotten, contact Endress+Hauser Service ([www.addresses.endress.com](http://www.addresses.endress.com))
- Possible cause: **Operator** option has no authorization  
Remedial action: Change to the **Maintenance** option

### 10.1.3 Measures

For information on measures in the case of an error message: See  "Pending diagnostic messages" section.

If the measures do not rectify the problem, contact your Endress+Hauser office.

### 10.1.4 Additional tests

If no clear cause of the error can be identified or the source of the problem can be both the device and the application, the following additional tests can be performed:

1. Check that the device concerned is functioning correctly. Replace the device if the digital value does not correspond to the expected value.
2. Switch on simulation and check the current output. Replace the device if the current output does not correspond to the simulated value.
3. Reset the device to the factory setting.

### 10.1.5 Behavior of the device in the event of a power outage

In the event of an unexpected power outage, the dynamic data are stored permanently (according to NAMUR NE 032).

### 10.1.6 Response of output to faults

#### Min. alarm

In the event of faults, the current output assumes the value  $\leq 3.6$  mA.

#### Max. alarm

Max. alarm can be ordered as an option (21.5 to 23 mA).

## 10.2 Diagnostic information on operating status LED

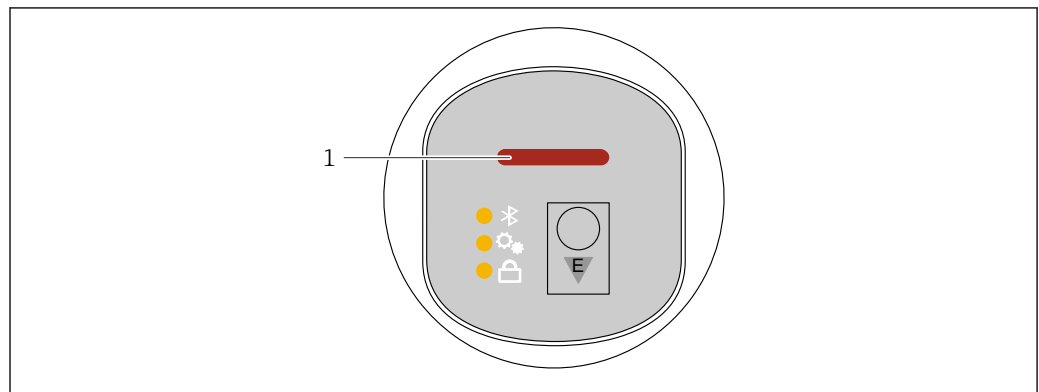

A0052452

1 Operating status LED

- Operating status LED is continuously lit in green: everything is OK
- Operating status LED is continuously lit in red: diagnosis type "Alarm" is active
- In the case of Bluetooth connection: operating status LED flashes while the function is executed  
LED flashes independently of the LED color

## 10.3 Diagnostic information on onsite display

### 10.3.1 Diagnostic message

#### Measured value display and diagnostic message in the event of a fault

Faults detected by the device's self-monitoring system are displayed as a diagnostic message in alternation with the unit.

#### Status signals

*F*

#### "Failure (F)" option

A device error has occurred. The measured value is no longer valid.

*C*

#### "Function check (C)" option

The device is in the service mode (e.g. during a simulation).

*S*

#### "Out of specification (S)" option

The device is operated:

- Outside of its technical specifications (e.g. during startup or a cleaning)
- Outside of the configuration performed by the user (e.g. level outside configured span)

*M*

#### "Maintenance required (M)" option

Maintenance required. The measured value remains valid.

#### Diagnostic event and event text

The fault can be identified by means of the diagnostic event.

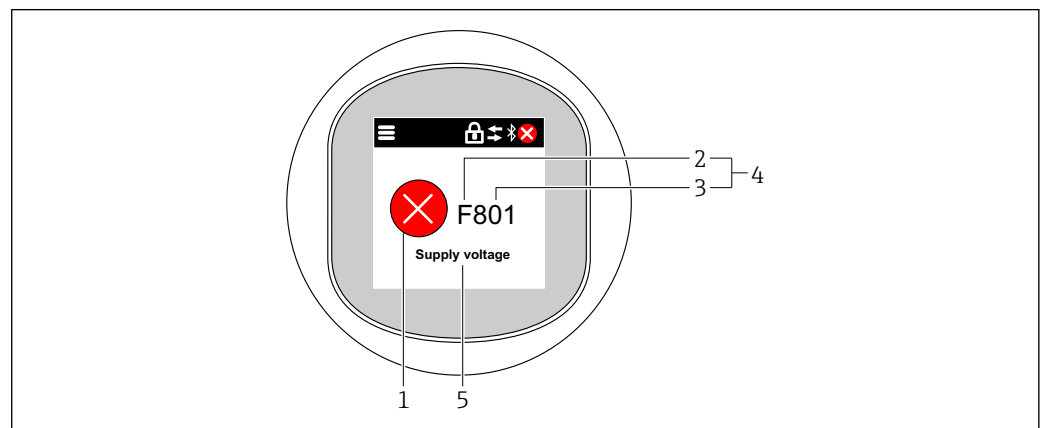

- 1 Status symbol
- 2 Status signal
- 3 Event number
- 4 Diagnostic event
- 5 Brief description of the diagnostic event

If several diagnostic events are pending at the same time, only the diagnostic message with the highest priority is displayed.

## 10.4 Diagnostic event in the operating tool

If a diagnostic event has occurred in the device, the status signal appears in the top left status area of the operating tool together with the corresponding symbol for the event level according to NAMUR NE 107:

- Failure (F)
- Function check (C)
- Out of specification (S)
- Maintenance required (M)

Click the status signal to see the detailed status signal.

The diagnostic events and remedial measures can be printed from the **Diagnostic list** submenu.

## 10.5 Adapting the diagnostic information

The event level can be configured:

Navigation: Diagnostics → Diagnostic settings → Configuration

## 10.6 Pending diagnostic messages

Pending diagnostic messages are displayed in alternating sequence with the measured value display in the onsite display.

Pending diagnostic messages can be displayed in the **Active diagnostics** parameter.

Navigation: Diagnostics → Active diagnostics

## 10.7 Diagnostic list

All of the diagnostic messages currently pending can be displayed in the **Diagnostic list** submenu.

Navigation: Diagnostics → Diagnostic list

### 10.7.1 List of diagnostic events

 Diagnosis 242 and 252 cannot occur with this device.

For diagnoses 270, 273, 803 and 805: The device must be replaced if the electronics are replaced.

Diagnostic number	Short text	Remedy instructions	Status signal [from the factory]	Diagnostic behavior [from the factory]
<b>Diagnostic of sensor</b>				
062	Sensor connection faulty	Check sensor connection	F	Alarm
081	Sensor initialization faulty	1. Restart device 2. Contact service	F	Alarm
100	Sensor error	1. Restart the device 2. Contact Endress+Hauser Service	F	Alarm
101	Sensor temperature	1. Check process temperature 2. Check ambient temperature	F	Alarm
102	Sensor incompatible error	1. Restart device 2. Contact service	F	Alarm

Diagnostic number	Short text	Remedy instructions	Status signal [from the factory]	Diagnostic behavior [from the factory]
<b>Diagnostic of electronic</b>				
203	HART Device Malfunction	Check device specific diagnosis.	S	Warning
204	HART Electronic Defect	Check device specific diagnosis.	F	Alarm
242	Firmware incompatible	1. Check software 2. Flash or change main electronic module	F	Alarm
252	Module incompatible	1. Check if correct electronic module is plugged 2. Replace electronic module	F	Alarm
263	Incompatibility detected	Check electronic module type	M	Warning
270	Main electronics defective	Replace main electronics or device.	F	Alarm
272	Main electronics faulty	1. Restart device 2. Contact service	F	Alarm
273	Main electronics defective	Replace main electronics or device.	F	Alarm
282	Data storage inconsistent	Restart device	F	Alarm
283	Memory content inconsistent	1. Restart device 2. Contact service	F	Alarm
287	Memory content inconsistent	1. Restart device 2. Contact service	M	Warning
388	Electronics and HistoROM defective	1. Restart device 2. Replace electronics and HistoROM 3. Contact service	F	Alarm
<b>Diagnostic of configuration</b>				
410	Data transfer failed	1. Retry data transfer 2. Check connection	F	Alarm
412	Processing download	Download active, please wait	C	Warning
420	HART Device Configuration Locked	Check device locking configuration.	S	Warning
421	HART Loop Current fixed	Check Multi-drop mode or current simulation.	S	Warning
431	Trim required	Carry out trim	C	Warning
435	Linearization faulty	Check data points and min span	F	Alarm
437	Configuration incompatible	1. Update firmware 2. Execute factory reset	F	Alarm
438	Dataset different	1. Check dataset file 2. Check device parameterization 3. Download new device parameterization	M	Warning
441	Current output 1 saturated	1. Check process 2. Check current output settings	S	Warning
484	Failure mode simulation active	Deactivate simulation	C	Alarm
485	Process variable simulation active	Deactivate simulation	C	Warning
491	Current output simulation active	Deactivate simulation	C	Warning

Diagnostic number	Short text	Remedy instructions	Status signal [from the factory]	Diagnostic behavior [from the factory]
495	Diagnostic event simulation active	Deactivate simulation	S	Warning
500	Process alert pressure	1. Check process pressure 2. Check configuration of process alert	S	Warning <sup>1)</sup>
501	Process alert scaled variable	1. Check process conditions 2. Check scaled variable configuration	S	Warning <sup>1)</sup>
502	Process alert temperature	1. Check process temperature 2. Check configuration of process alert	S	Warning <sup>1)</sup>
503	Zero adjustment	1. Check measuring range 2. Check position adjustment	M	Warning
<b>Diagnostic of process</b>				
801	Supply voltage too low	Increase supply voltage	F	Alarm
802	Supply voltage too high	Decrease supply voltage	S	Warning
805	Loop current faulty	1. Check wiring 2. Replace electronics or device	F	Alarm
806	Loop diagnostics	1. Check supply voltage 2. Check wiring and terminals	M	Warning <sup>1)</sup>
807	No Baseline due to insuf. volt. at 20 mA	Increase supply voltage	M	Warning
822	Sensor temperature out of range	1. Check process temperature 2. Check ambient temperature	S	Warning <sup>1)</sup>
825	Electronics temperature	1. Check ambient temperature 2. Check process temperature	S	Warning
841	Operating range	1. Check the process pressure 2. Check the sensor range	S	Warning <sup>1)</sup>
846	HART Non-Primary Variable Out of Limit	Check device specific diagnosis.	S	Warning
847	HART Primary Variable Out of Limit	Check device specific diagnosis.	S	Warning
848	HART Device Variable Alert	Check device specific diagnosis.	S	Warning
900	High signal noise detected	1. Check impulse line 2. Check valve position 3. Check process	M	Warning <sup>1)</sup>
901	Low signal noise detected	1. Check impulse line 2. Check valve position 3. Check process	M	Warning <sup>1)</sup>
902	Min signal noise detected	1. Check impulse line 2. Check valve position 3. Check process	M	Warning <sup>1)</sup>
906	Out of range signal detected	1. Process Information. No action 2. Rebuild baseline 3. Adapt signal range thresholds	S	Warning <sup>1)</sup>

1) Diagnostic behavior can be changed.

## 10.8 Event logbook

### 10.8.1 Event history

The "Event logbook" submenu <sup>5)</sup>.

Navigation: Diagnostics → Event logbook

A maximum of 100 event messages can be displayed in chronological order.

The event history includes entries for:

- Diagnostic events
- Information events

In addition to the operating time when the event occurred, each event is also assigned a symbol that indicates whether the event has occurred or is finished:

- Diagnostic event
  - ☹: Occurrence of the event
  - ☺: End of the event
- Information event
  - ☹: Occurrence of the event

### 10.8.2 Filtering the event logbook

Filters can be used to determine which category of event messages is displayed in the **Event logbook** submenu.

Navigation: Diagnostics → Event logbook

#### Filter categories

- All
- Failure (F)
- Function check (C)
- Out of specification (S)
- Maintenance required (M)
- Information

### 10.8.3 Overview of information events

Info number	Info name
I1000	----- (Device ok)
I1079	Sensor changed
I1089	Power on
I1090	Configuration reset
I1091	Configuration changed
I11074	Device verification active
I1110	Write protection switch changed
I11104	Loop diagnostics
I11284	DIP MIN setting to HW active
I11285	DIP SW setting active
I11341	SSD baseline created

5) provides a chronological overview of the event messages that have occurred. If the device is operated via FieldCare, the events list can be displayed via the FieldCare function "Event List".

Info number	Info name
I1151	History reset
I1154	Reset terminal voltage min/max
I1155	Reset electronics temperature
I1157	Memory error event list
I1256	Display: access status changed
I1264	Safety sequence aborted
I1335	Firmware changed
I1397	Fieldbus: access status changed
I1398	CDI: access status changed
I1440	Main electronic module changed
I1444	Device verification passed
I1445	Device verification failed
I1461	Sensor verification failed
I1512	Download started
I1513	Download finished
I1514	Upload started
I1515	Upload finished
I1551	Assignment error fixed
I1552	Failed: Main electronic verification
I1554	Safety sequence started
I1555	Safety sequence confirmed
I1556	Safety mode off
I1956	Reset

## 10.9 Device reset

### 10.9.1 Resetting the password via the operating tool

Enter a code to reset the current "Maintenance" password.  
The code is delivered by your local support.

Navigation: System → User management → Reset password → Reset password

 For details see the "Description of device parameters" documentation.

## 10.10 Firmware history

### 10.10.1 Version

**01.00.00**

Initial software



## 11 Maintenance

### 11.1 Maintenance work

#### 11.1.1 Filter element

Keep the filter element (1) free from contamination. The device version determines whether or not a filter element is installed.

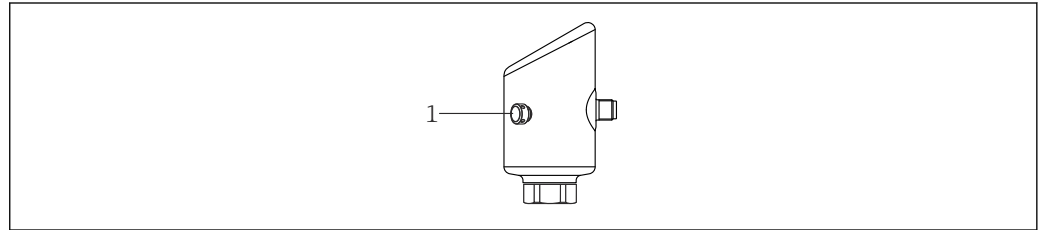

A0053239

#### 11.1.2 Exterior cleaning

The cleaning agents used should not corrode the surface and the seals.

The following cleaning agents can be used:

- Ecolab P3 topaktive 200
- Ecolab P3 topaktive 500
- Ecolab P3 topaktive OKTO
- Ecolab P3 topax 66
- Ecolab TOPAZ AC5

Avoid mechanical damage to the membrane (e.g. caused by pointed objects).

Observe the degree of protection of the device.

## 12 Repair

### 12.1 General notes

#### 12.1.1 Repair concept

The Endress+Hauser repair concept is devised in such a way that repairs can only be carried out through device replacement.

### 12.2 Return

The requirements for safe device return can vary depending on the device type and national legislation.

1. Refer to the web page for information:  
<https://www.endress.com/support/return-material>  
↳ Select the region.
2. If returning the device, pack the device in such a way that it is reliably protected against impact and external influences. The original packaging offers the best protection.

## 12.3 Disposal

-  If required by the Directive 2012/19/EU on waste electrical and electronic equipment (WEEE), the product is marked with the depicted symbol in order to minimize the disposal of WEEE as unsorted municipal waste. Do not dispose of products bearing this marking as unsorted municipal waste. Instead, return them to the manufacturer for disposal under the applicable conditions.

## 13 Accessories

Accessories currently available for the product can be selected via the Product Configurator at [www.endress.com](http://www.endress.com):

1. Select the product using the filters and search field.
2. Open the product page.
3. Select **Spare parts & Accessories**.

### 13.1 Device-specific accessories

#### 13.1.1 M12 socket

M12 socket, straight

- Material:
  - Body: PA; union nut: stainless steel; seal: EPDM
- Degree of protection (fully locked): IP69
- Order number: 71638191

M12 socket, elbowed

- Material:
  - Body: PA; union nut: stainless steel; seal: EPDM
- Degree of protection (fully locked): IP69
- Order number: 71638253

#### 13.1.2 Cables

Cable 4 x 0.34 mm<sup>2</sup> (20 AWG) with M12 socket, elbowed, screw plug, length 5 m (16 ft)

- Material: body: TPU; union nut: nickel-plated die-cast zinc; cable: PVC
- Degree of protection (fully locked): IP68/69
- Order number: 52010285
- Wire colors
  - 1 = BN = brown
  - 2 = WT = white
  - 3 = BU = blue
  - 4 = BK = black

#### 13.1.3 Welding neck, process adapter and flange

-  For details, refer to TI00426F/00/EN "Weld-in adapters, process adapters and flanges".

#### 13.1.4 Mechanical accessories

-  For technical data (e.g. materials, dimensions or order numbers), see the accessory document SDO1553P.

## 13.2 DeviceCare SFE100

Configuration tool for IO-Link, HART, PROFIBUS and FOUNDATION Fieldbusfield devices  
DeviceCare is available for download free of charge at [www.software-products.endress.com](http://www.software-products.endress.com). You need to register in the Endress+Hauser software portal to download the application.

 Technical Information TI01134S

## 13.3 FieldCare SFE500

FDT-based plant asset management tool

It can configure all intelligent field units in your system and helps you manage them. By using the status information, it is also a simple but effective way of checking their status and condition.

 Technical Information TI00028S

## 13.4 Device Viewer

All the spare parts for the device, along with the order code, are listed in the *Device Viewer* ([www.endress.com/deviceviewer](http://www.endress.com/deviceviewer)).

## 13.5 Field Xpert SMT70

Universal, high-performance tablet PC for device configuration in Ex Zone 2 and non-Ex areas

 For details, see "Technical Information" TI01342S

## 13.6 Field Xpert SMT77

Universal, high-performance tablet PC for device configuration in Ex Zone 1 areas

 For details, see "Technical Information" TI01418S

## 13.7 SmartBlue app

Mobile app for easy configuration of devices on site via Bluetooth wireless technology

## 14 Technical data

### 14.1 Input

#### 14.1.1 Measured variable

##### Measured process variables

- Absolute pressure
- Gauge pressure

##### Calculated process variables

Pressure

#### 14.1.2 Measuring range

Depending on the device configuration, the maximum working pressure (MWP) and the overpressure limit (OPL) can deviate from the values in the tables.

##### Absolute pressure

Measuring cell	Maximum measuring range		Smallest factory-calibratable span	
	lower (LRL)	upper (URL)	Standard	Platinum
	[bar (psi)]	[bar (psi)]	[bar (psi)]	
400 mbar (6 psi)	0	+0.4 (+6)	0.05 (0.75) <sup>1)</sup>	80 mbar (1.2 psi)
1 bar (15 psi)	0	+1 (+15)	0.05 (0.75) <sup>2)</sup>	200 mbar (3 psi)
2 bar (30 psi)	0	+2 (+30)	0.10 (1.50) <sup>2)</sup>	400 mbar (6 psi)
4 bar (60 psi)	0	+4 (+60)	0.20 (3.00) <sup>2)</sup>	800 mbar (12 psi)
10 bar (150 psi)	0	+10 (+150)	0.50 (7.50) <sup>2)</sup>	2 bar (30 psi)
40 bar (600 psi)	0	+40 (+600)	2.00 (30.0) <sup>2)</sup>	8 bar (120 psi)
100 bar (1 500 psi)	0	+100 (+1500)	5.00 (73) <sup>2)</sup>	20 bar (300 psi)

1) Largest factory-configurable turn down: 8:1

2) Largest factory-configurable turn down: 20:1

##### Absolute pressure

Measuring cell	MWP	OPL	Factory settings <sup>1)</sup>
	[bar (psi)]	[bar (psi)]	
400 mbar (6 psi)	1 (14.5)	1.6 (23)	0 to 400 mbar (0 to 6 psi)
1 bar (15 psi)	2.7 (39)	4 (58)	0 to 1 bar (0 to 15 psi)
2 bar (30 psi)	6.7 (97)	10 (145)	0 to 2 bar (0 to 30 psi)
4 bar (60 psi)	10.7 (155)	16 (232)	0 to 4 bar (0 to 60 psi)
10 bar (150 psi)	25 (362)	40 (580)	0 to 10 bar (0 to 150 psi)
40 bar (600 psi)	100 (1450)	160 (2320)	0 to 40 bar (0 to 600 psi)
100 bar (1 500 psi)	103.5 (1500)	160 (2320)	0 to 100 bar (0 to 1 500 psi)

1) Different measuring ranges (e.g. -1 to +5 bar (-15 to +75 psi)) can be ordered with customized settings. It is possible to invert the output signal (LRV = 20 mA; URV = 4 mA). Prerequisite: URV < LRV

*Gauge pressure*

Measuring cell	Maximum measuring range		Smallest factory-calibratable span <sup>1)</sup>	
	lower (LRL)	upper (URL)	Standard	Platinum
	[bar (psi)]	[bar (psi)]	[bar (psi)]	
400 mbar (6 psi)	-0.4 (-6)	+0.4 (+6)	0.05 (0.75) <sup>2)</sup>	80 mbar (1.2 psi)
1 bar (15 psi)	-1 (-15)	+1 (+15)	0.05 (0.75) <sup>3)</sup>	200 mbar (3 psi)
2 bar (30 psi)	-1 (-15)	+2 (+30)	0.10 (1.50) <sup>3)</sup>	400 mbar (6 psi)
4 bar (60 psi)	-1 (-15)	+4 (+60)	0.20 (3.00) <sup>3)</sup>	800 mbar (12 psi)
10 bar (150 psi)	-1 (-15)	+10 (+150)	0.50 (7.50) <sup>3)</sup>	2 bar (30 psi)
25 bar (375 psi)	-1 (-15)	+25 (+375)	1.25 (18.50) <sup>3)</sup>	5 bar (75 psi)
40 bar (600 psi)	-1 (-15)	+40 (+600)	2.00 (30.00) <sup>3)</sup>	8 bar (120 psi)
100 bar (1 500 psi)	-1 (-15)	+100 (+1500)	5.00 (73) <sup>3)</sup>	20 bar (300 psi)

- 1) Largest factory-configurable turn down: 5:1.
- 2) Largest factory-configurable turn down: 8:1
- 3) Largest factory-configurable turn down: 20:1

*Gauge pressure*

Measuring cell	MWP	OPL	Factory settings <sup>1)</sup>
	[bar (psi)]	[bar (psi)]	
400 mbar (6 psi)	1 (14.5)	1.6 (23)	0 to 400 mbar (0 to 6 psi)
1 bar (15 psi)	2.7 (39)	4 (58)	0 to 1 bar (0 to 15 psi)
2 bar (30 psi)	6.7 (97)	10 (145)	0 to 2 bar (0 to 30 psi)
4 bar (60 psi)	10.7 (155)	16 (232)	0 to 4 bar (0 to 60 psi)
10 bar (150 psi)	25 (363)	40 (580)	0 to 10 bar (0 to 150 psi)
25 bar (375 psi)	25.8 (375)	100 (1450)	0 to 25 bar (0 to 375 psi)
40 bar (600 psi)	100 (1450)	160 (2320)	0 to 40 bar (0 to 600 psi)
100 bar (1 500 psi)	103.5 (1500)	160 (2320)	0 to 100 bar (0 to 1 500 psi)

- 1) Different measuring ranges (e.g. -1 to +5 bar (-15 to +75 psi)) can be ordered with customized settings. It is possible to invert the output signal (LRV = 20 mA; URV = 4 mA). Prerequisite: URV < LRV

## 14.2 Output

### 14.2.1 Output signal

2-wire 4 to 20 mA

### 14.2.2 Signal on alarm for devices with current output

Signal on alarm in accordance with NAMUR recommendation NE 43.

### 14.2.3 Load

In order to guarantee sufficient terminal voltage, a maximum load resistance  $R_L$  (including line resistance) must not be exceeded, depending on the supply voltage  $U$  of the supply unit.

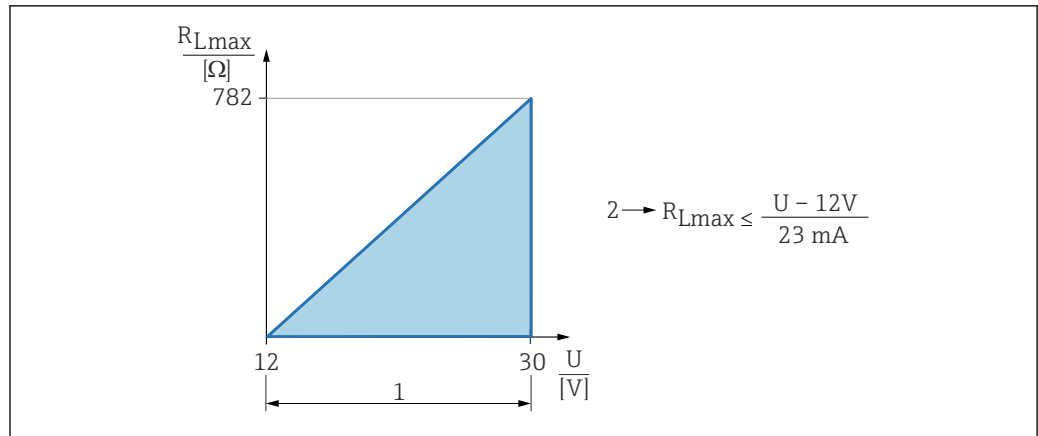

A0052602

- 1 Power supply 12 to 30 V
- 2  $R_{Lmax}$  maximum load resistance
- U Supply voltage

If load is too great:

- Failure current is indicated and error message is displayed (indication: MIN alarm current)
- Periodic checking to establish if it is possible to quit fault state

### 14.2.4 Damping

A damping affects all continuous outputs.

Factory setting: 1 s (can be configured from 0 to 999 s)

### 14.2.5 Ex connection data

 See the separate technical documentation (Safety Instructions (XA)) on [www.endress.com/download](http://www.endress.com/download).

## 14.3 Environment

### 14.3.1 Ambient temperature range

-40 to +85 °C (-40 to +185 °F)

The permitted ambient temperature is reduced at higher process temperatures.

 The following information only takes into account functional aspects. Additional restrictions may apply for certified device versions.

The permitted process temperature varies, depending on the process connection used. For an overview of the process connections, see Section "Process temperature range".

**Maximum process temperature +130 °C (+266 °F)**

(Product feature "Application"; order option "B")

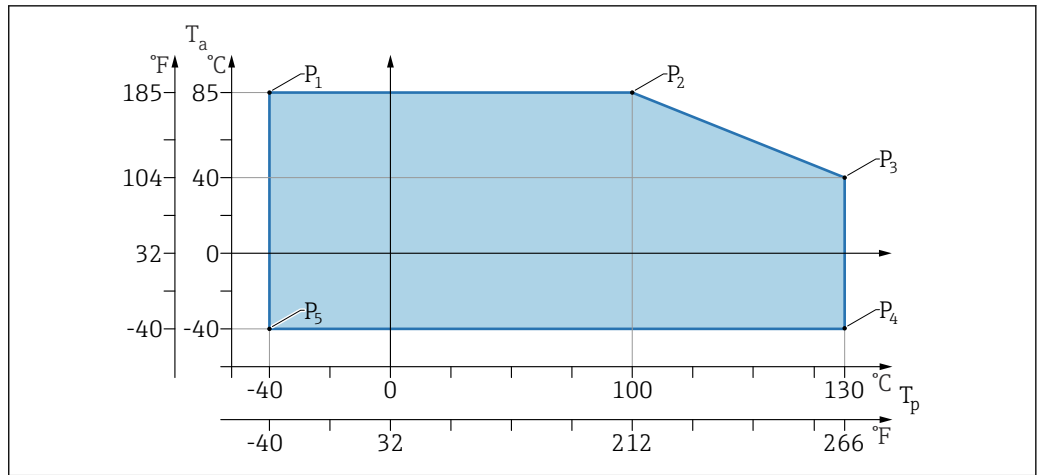

2 Ambient temperature  $T_a$  depending on the process temperature  $T_p$

A0055963

P	$T_p$	$T_a$
P1	-40 °C (-40 °F)	+85 °C (+185 °F)
P2	+100 °C (+212 °F)	+85 °C (+185 °F)
P3	+130 °C (+266 °F)	+40 °C (+77 °F)
P4	+130 °C (+266 °F)	-40 °C (-40 °F)
P5	-40 °C (-40 °F)	-40 °C (-40 °F)

**Maximum process temperature +150 °C (+302 °F)**

(Product feature "Application"; order option "C")

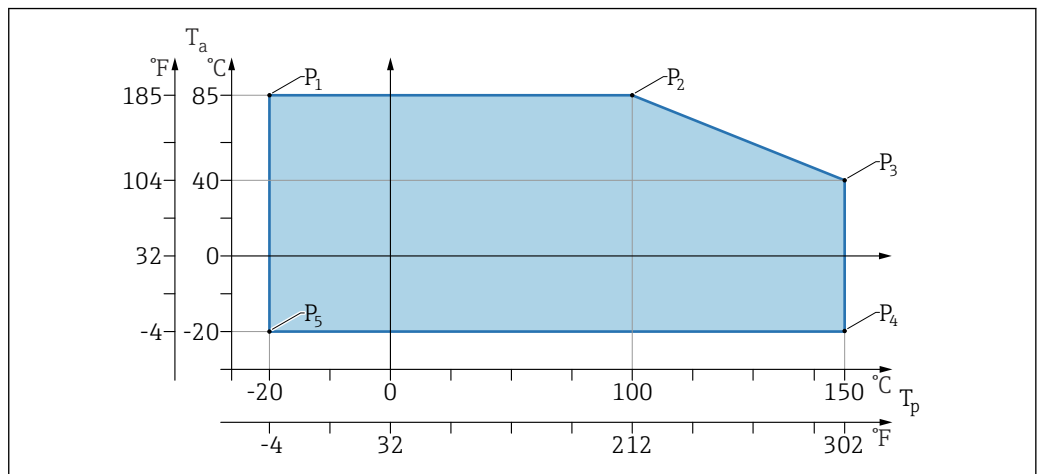

3 Ambient temperature  $T_a$  depending on the process temperature  $T_p$

A0055963

P	$T_p$	$T_a$
P1	-20 °C (-4 °F)	+85 °C (+185 °F)
P2	+100 °C (+212 °F)	+85 °C (+185 °F)
P3	+150 °C (+302 °F)	+40 °C (+77 °F)
P4	+150 °C (+302 °F)	-20 °C (-4 °F)
P5	-20 °C (-4 °F)	-20 °C (-4 °F)

**Maximum process temperature +200 °C (+392 °F)**

(Product feature "Application"; order option "D")

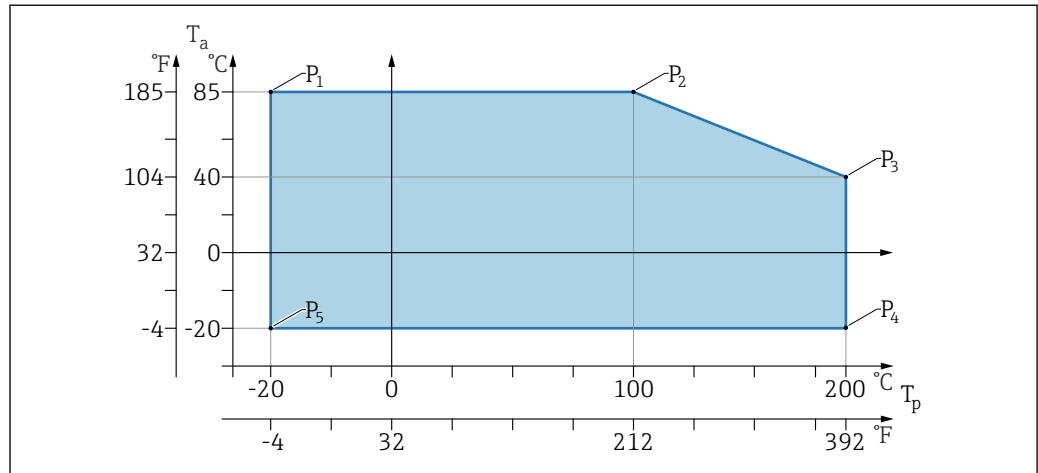

A0055469

4 Ambient temperature  $T_a$  depending on the process temperature  $T_p$

P	$T_p$	$T_a$
P1	-20 °C (-4 °F)	+85 °C (+185 °F)
P2	+100 °C (+212 °F)	+85 °C (+185 °F)
P3	+200 °C (+392 °F)	+40 °C (+77 °F)
P4	+200 °C (+392 °F)	-20 °C (-4 °F)
P5	-20 °C (-4 °F)	-20 °C (-4 °F)

**14.3.2 Storage temperature**

-40 to +85 °C (-40 to +185 °F)

**14.3.3 Operating height**

Up to 5 000 m (16 404 ft) above sea level

**14.3.4 Climate class**

According to IEC 60068-2-38 test Z/AD (relative humidity 4 to 100 %).

**14.3.5 Degree of protection**

Test as per IEC 60529 Edition 2.2 2013-08/ DIN EN 60529:2014-09 and NEMA 250-2014

For mounted M12 connecting cable: IP66/68/69, NEMA type 4X/6P

/IP68,: (1.83 mH<sub>2</sub>O for 24 h))

**14.3.6 Pollution degree**

Pollution degree 2 according to IEC/EN 61010-1.



### 14.3.7 Vibration resistance

- Stochastic noise (random sweep) according to IEC/DIN EN 60068-2-64 Case 2
- Guaranteed for 5 to 2 000 Hz:  $1.25 (m/s^2)^2/Hz$ , ~ 5 g
- Sinusoidal vibration according to IEC 62828-1:2017 with 10 to 60 Hz  $\pm 0.35$  mm; 60 to 1 000 Hz 5 g

### 14.3.8 Shock resistance

- Testing standard: IEC/DIN EN 60068-2-27 Case 2
- Shock resistance: 30 g (18 ms) in all 3 axes

### 14.3.9 Electromagnetic compatibility (EMC)

- Electromagnetic compatibility as per IEC/DIN EN 61326 series and NAMUR recommendation EMC (NE21)
- Maximum deviation under interference influence: < 0.5 %

For more details refer to the EU Declaration of Conformity.

## 14.4 Process

### 14.4.1 Process temperature

Maximum process temperature	Version <sup>1)</sup>
+100 °C (+212 °F)	A
+130 °C (+266 °F)(+150 °C (+302 °F) <sup>2)</sup> )	B
+150 °C (+302 °F)	C
+200 °C (+392 °F)	D

1) Product Configurator, "Application" feature

2) Temperature for maximum one hour (device in operation but not within measurement specification)

### Fill fluid

Fill fluid	Process temperature range	Version <sup>1)</sup>
Synthetic oil, FDA	-40 to +130 °C (-40 to +266 °F)(+150 °C (+302 °F) <sup>2)</sup> )	3
Vegetable oil, FDA	-20 to +200 °C (-4 to +392 °F)	4

1) Product Configurator, "Fill fluid" feature

2) Temperature for one hour maximum (device in operation but not within measurement specification)

## 14.4.2 Process pressure range

### Pressure specifications

**⚠ WARNING**

**The maximum pressure for the device depends on the lowest-rated component with regard to pressure (components are: process connection, optional mounted parts or accessories).**

- ▶ Only operate the device within the specified limits for the components!
- ▶ MWP (maximum working pressure): The maximum working pressure is specified on the nameplate. This value refers to a reference temperature of +20 °C (+68 °F) and may be applied to the device for an unlimited time. Note temperature dependence of maximum working pressure. For higher temperatures, refer to the following standards for the permitted pressure values for flanges: EN 1092-1 (materials 1.4435 and 1.4404 are identical with regard to their stability/temperature property and are grouped together in under 13E0 in EN 1092-1 Tab. 18; the chemical composition of the two materials can be identical), ASME B 16.5a (the latest version of the standard applies in each case).
- ▶ The overpressure limit is the maximum pressure that a device may be subjected to during a test. It exceeds the maximum working pressure by a certain factor. This value refers to a reference temperature of +20 °C (+68 °F).
- ▶ In the case of sensor range and process connection combinations where the overpressure limit (OPL) of the process connection is less than the nominal value of the measuring cell, the device is set at the factory, at the very maximum, to the OPL value of the process connection. If the entire measuring cell range must be used, select a process connection with a higher OPL value (1.5 x MWP; MWP = PN).
- ▶ The Pressure Equipment Directive (2014/68/EU) uses the abbreviation "PS". The abbreviation "PS" corresponds to the maximum working pressure of the device.
- ▶ For maximum working pressure data that deviate from this, see the "Mechanical construction" section.

## 14.4.3 Cleaned of oil and grease

Endress+Hauser also offers devices, cleaned of oil and grease, for special applications. No special restrictions regarding the process conditions apply to these devices.

## Index

### C

- CE mark . . . . . 8
- Cleaning . . . . . 33

### D

- Declaration of conformity . . . . . 8
- Device locking, status . . . . . 22
- Diagnosis
  - Symbols . . . . . 27
- Diagnostic event . . . . . 27
  - In the operating tool . . . . . 28
- Diagnostic events . . . . . 26, 27
- Diagnostic list . . . . . 28
- Diagnostic message . . . . . 27
- Display values
  - For locking status . . . . . 22
- Disposal . . . . . 34
- Document
  - Function . . . . . 4
- Document function . . . . . 4

### E

- Event history . . . . . 31
- Event text . . . . . 27
- Events list . . . . . 31
- Exterior cleaning . . . . . 33

### F

- Field of application
  - Residual risks . . . . . 8
- Filtering the event logbook . . . . . 31

### I

- Intended use . . . . . 7

### N

- Nameplate . . . . . 11

### O

- Occupational safety . . . . . 8
- Onsite display
  - see Diagnostic message
  - see In alarm condition
- Operational safety . . . . . 8

### P

- Post-connection check . . . . . 14
- Product security . . . . . 8

### R

- Repair concept . . . . . 33
- Requirements for personnel . . . . . 7
- Return . . . . . 33

### S

- Settings
  - Adapting the device to process conditions . . . . . 23

- Status signals . . . . . 27
- Submenu
  - Events list . . . . . 31

### T

- Troubleshooting . . . . . 24

### U

- Use of the measuring instruments
  - Borderline cases . . . . . 7
  - Incorrect use . . . . . 7
- Using the device
  - see Intended use



71668322

[www.addresses.endress.com](http://www.addresses.endress.com)

---