

Operating Instructions

Proline Prosonic Flow G 300

Modbus RS485

Ultrasonic time-of-flight flowmeter

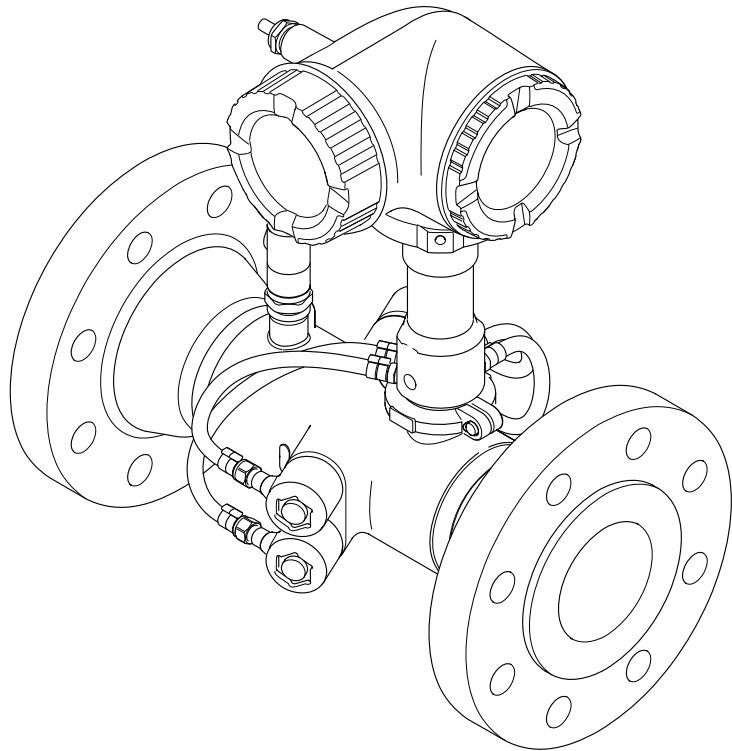

- Make sure the document is stored in a safe place such that it is always available when working on or with the device.
- To avoid danger to individuals or the facility, read the "Basic safety instructions" section carefully, as well as all other safety instructions in the document that are specific to working procedures.
- The manufacturer reserves the right to modify technical data without prior notice. Your Endress+Hauser Sales Center will supply you with current information and updates to these instructions.

Table of contents

1	About this document	6	6	Installation	22
1.1	Document function	6	6.1	Mounting conditions	22
1.2	Symbols	6	6.1.1	Mounting position	22
1.2.1	Safety symbols	6	6.1.2	Environment and process requirements	24
1.2.2	Electrical symbols	6	6.1.3	Special mounting instructions	26
1.2.3	Communication symbols	6	6.2	Mounting the measuring device	27
1.2.4	Tool symbols	7	6.2.1	Required tools	27
1.2.5	Symbols for certain types of information	7	6.2.2	Preparing the measuring device	27
1.2.6	Symbols in graphics	7	6.2.3	Mounting the measuring device	27
1.3	Documentation	8	6.2.4	Turning the transmitter housing	28
1.3.1	Standard documentation	8	6.2.5	Turning the display module	28
1.3.2	Supplementary device-dependent documentation	8	6.3	Post-mounting check	29
1.4	Registered trademarks	9	7	Electrical connection	30
2	Safety instructions	10	7.1	Connection conditions	30
2.1	Requirements for the personnel	10	7.1.1	Required tools	30
2.2	Designated use	10	7.1.2	Requirements for connecting cable	30
2.3	Workplace safety	11	7.1.3	Terminal assignment	33
2.4	Operational safety	11	7.1.4	Shielding and grounding	33
2.5	Product safety	11	7.1.5	Preparing the measuring device	33
2.6	IT security	12	7.2	Connecting the measuring device	34
2.7	Device-specific IT security	12	7.2.1	Connecting the transmitter	34
2.7.1	Protecting access via hardware write protection	12	7.2.2	Connecting the remote display and operating module DKX001	37
2.7.2	Protecting access via a password	12	7.3	Ensuring potential equalization	37
2.7.3	Access via Web server	13	7.3.1	Requirements	37
2.7.4	Access via service interface (CDI-RJ45)	14	7.4	Special connection instructions	38
3	Product description	15	7.4.1	Connection examples	38
3.1	Product design	15	7.5	Hardware settings	41
4	Incoming acceptance and product identification	16	7.5.1	Setting the device address	41
4.1	Incoming acceptance	16	7.5.2	Enabling the terminating resistor	42
4.2	Product identification	16	7.6	Ensuring the degree of protection	42
4.2.1	Transmitter nameplate	17	7.7	Post-connection check	42
4.2.2	Sensor nameplate	18	8	Operation options	44
4.2.3	Symbols on measuring device	19	8.1	Overview of operation options	44
5	Storage and transport	20	8.2	Structure and function of the operating menu	45
5.1	Storage conditions	20	8.2.1	Structure of the operating menu	45
5.2	Transporting the product	20	8.2.2	Operating philosophy	46
5.2.1	Measuring devices without lifting lugs	20	8.3	Access to the operating menu via the local display	47
5.2.2	Measuring devices with lifting lugs	21	8.3.1	Operational display	47
5.2.3	Transporting with a fork lift	21	8.3.2	Navigation view	49
5.3	Packaging disposal	21	8.3.3	Editing view	51
			8.3.4	Operating elements	53
			8.3.5	Opening the context menu	53
			8.3.6	Navigating and selecting from list	55
			8.3.7	Calling the parameter directly	55
			8.3.8	Calling up help text	56
			8.3.9	Changing the parameters	56
			8.3.10	User roles and related access authorization	57

8.3.11	Disabling write protection via access code	57	10.4.5	Carrying out additional display configurations	107
8.3.12	Enabling and disabling the keypad lock	58	10.4.6	WLAN configuration	110
8.4	Access to the operating menu via the Web browser	58	10.4.7	Configuration management	112
8.4.1	Function range	58	10.4.8	Using parameters for device administration	114
8.4.2	Prerequisites	59	10.5	Simulation	115
8.4.3	Establishing a connection	60	10.6	Protecting settings from unauthorized access	118
8.4.4	Logging on	62	10.6.1	Write protection via access code ...	118
8.4.5	User interface	63	10.6.2	Write protection via write protection switch	120
8.4.6	Disabling the Web server	64			
8.4.7	Logging out	64	11	Operation	121
8.5	Access to the operating menu via the operating tool	65	11.1	Reading the device locking status	121
8.5.1	Connecting the operating tool	65	11.2	Adjusting the operating language	121
8.5.2	FieldCare	67	11.3	Configuring the display	121
8.5.3	DeviceCare	68	11.4	Reading measured values	121
9	System integration	70	11.4.1	Process variables	122
9.1	Overview of device description files	70	11.4.2	System values	124
9.1.1	Current version data for the device ...	70	11.4.3	"Input values" submenu	125
9.1.2	Operating tools	70	11.4.4	Output values	126
9.2	Compatibility with earlier model	70	11.4.5	"Totalizer" submenu	128
9.3	Modbus RS485 information	71	11.5	Adapting the measuring device to the process conditions	129
9.3.1	Function codes	71	11.6	Performing a totalizer reset	129
9.3.2	Register information	72	11.6.1	Function scope of the "Control Totalizer" parameter	130
9.3.3	Response time	72	11.6.2	Function scope of the "Reset all totalizers" parameter	130
9.3.4	Data types	72	11.7	Showing data logging	130
9.3.5	Byte transmission sequence	73	12	Diagnostics and troubleshooting ..	134
9.3.6	Modbus data map	73	12.1	General troubleshooting	134
10	Commissioning	76	12.2	Diagnostic information via light emitting diodes	136
10.1	Function check	76	12.2.1	Transmitter	136
10.2	Setting the operating language	76	12.3	Diagnostic information on local display	138
10.3	Configuring the measuring device	76	12.3.1	Diagnostic message	138
10.3.1	Defining the tag name	78	12.3.2	Calling up remedial measures	140
10.3.2	Setting the system units	78	12.4	Diagnostic information in the Web browser ..	140
10.3.3	Configuring the communication interface	80	12.4.1	Diagnostic options	140
10.3.4	Displaying the I/O configuration	81	12.4.2	Calling up remedy information	141
10.3.5	Configuring the current input	82	12.5	Diagnostic information in FieldCare or DeviceCare	141
10.3.6	Configuring the status input	83	12.5.1	Diagnostic options	141
10.3.7	Configuring the current output	84	12.5.2	Calling up remedy information	142
10.3.8	Configuring the pulse/frequency/switch output	87	12.6	Diagnostic information via communication interface	143
10.3.9	Configuring the relay output	93	12.6.1	Reading out diagnostic information	143
10.3.10	Configuring the double pulse output ..	95	12.6.2	Configuring error response mode ...	143
10.3.11	Configuring the local display	96	12.7	Adapting the diagnostic information	143
10.3.12	Configuring the low flow cut off	98	12.7.1	Adapting the diagnostic behavior ...	143
10.3.13	Gas analysis configuration	99	12.8	Overview of diagnostic information	144
10.4	Advanced settings	101	12.9	Pending diagnostic events	148
10.4.1	Using the parameter to enter the access code	102	12.10	Diagnostic list	149
10.4.2	Carrying out a sensor adjustment ...	102	12.11	Event logbook	150
10.4.3	Performing the sensor setup	102	12.11.1	Reading out the event logbook	150
10.4.4	Configuring the totalizer	106			

12.11.2	Filtering the event logbook	151
12.11.3	Overview of information events	151
12.12	Resetting the measuring device	152
12.12.1	Function scope of the "Device reset" parameter	152
12.13	Device information	153
12.14	Firmware history	154
13	Maintenance	155
13.1	Maintenance tasks	155
13.1.1	Exterior cleaning	155
13.2	Measuring and test equipment	155
13.3	Endress+Hauser services	155
14	Repair	156
14.1	General notes	156
14.1.1	Repair and conversion concept	156
14.1.2	Notes for repair and conversion	156
14.2	Spare parts	156
14.3	Endress+Hauser services	156
14.4	Return	156
14.5	Disposal	156
14.5.1	Removing the measuring device	156
14.5.2	Disposing of the measuring device	157
15	Accessories	158
15.1	Device-specific accessories	158
15.1.1	For the transmitter	158
15.2	Communication-specific accessories	159
15.3	Service-specific accessories	159
15.4	System components	159
16	Technical data	160
16.1	Application	160
16.2	Function and system design	160
16.3	Input	161
16.4	Output	164
16.5	Power supply	170
16.6	Performance characteristics	171
16.7	Installation	172
16.8	Environment	172
16.9	Process	173
16.10	Mechanical construction	175
16.11	Operability	179
16.12	Certificates and approvals	183
16.13	Application packages	185
16.14	Accessories	186
16.15	Supplementary documentation	186
Index		188

1 About this document

1.1 Document function

These Operating Instructions contain all the information that is required in various phases of the life cycle of the device: from product identification, incoming acceptance and storage, to mounting, connection, operation and commissioning through to troubleshooting, maintenance and disposal.

1.2 Symbols

1.2.1 Safety symbols

DANGER

This symbol alerts you to a dangerous situation. Failure to avoid this situation will result in serious or fatal injury.

WARNING

This symbol alerts you to a dangerous situation. Failure to avoid this situation can result in serious or fatal injury.





CAUTION

This symbol alerts you to a dangerous situation. Failure to avoid this situation can result in minor or medium injury.



NOTICE



This symbol contains information on procedures and other facts which do not result in personal injury.

1.2.2 Electrical symbols



Symbol	Meaning
	Direct current
	Alternating current
	Direct current and alternating current
	Ground connection A grounded terminal which, as far as the operator is concerned, is grounded via a grounding system.
	Protective Earth (PE) A terminal which must be connected to ground prior to establishing any other connections. The ground terminals are situated inside and outside the device: <ul style="list-style-type: none"> ▪ Inner ground terminal: Connects the protective earth to the mains supply. ▪ Outer ground terminal: Connects the device to the plant grounding system.

1.2.3 Communication symbols













Symbol	Meaning
	Wireless Local Area Network (WLAN) Communication via a wireless, local network.
	LED Light emitting diode is off.

Symbol	Meaning
	LED Light emitting diode is on.
	LED Light emitting diode is flashing.



1.2.4 Tool symbols



Symbol	Meaning
	Flat blade screwdriver
	Allen key
	Open-ended wrench

1.2.5 Symbols for certain types of information

Symbol	Meaning
	Permitted Procedures, processes or actions that are permitted.
	Preferred Procedures, processes or actions that are preferred.
	Forbidden Procedures, processes or actions that are forbidden.
	Tip Indicates additional information.
	Reference to documentation.
	Reference to page.
	Reference to graphic.
	Notice or individual step to be observed.
	Series of steps.
	Result of a step.
	Help in the event of a problem.
	Visual inspection.

1.2.6 Symbols in graphics



Symbol	Meaning
1, 2, 3, ...	Item numbers
	Series of steps
A, B, C, ...	Views
A-A, B-B, C-C, ...	Sections
	Hazardous area

Symbol	Meaning
	Safe area (non-hazardous area)
	Flow direction

1.3 Documentation

 For an overview of the scope of the associated Technical Documentation, refer to the following:

- *W@M Device Viewer* (www.endress.com/deviceviewer): Enter the serial number from nameplate
- *Endress+Hauser Operations App*: Enter the serial number from the nameplate or scan the 2D matrix code (QR code) on the nameplate

 Detailed list of the individual documents along with the documentation code
→  186

1.3.1 Standard documentation

Document type	Purpose and content of the document
Technical Information	Planning aid for your device The document contains all the technical data on the device and provides an overview of the accessories and other products that can be ordered for the device.
Sensor Brief Operating Instructions	Guides you quickly to the 1st measured value - Part 1 The Sensor Brief Operating Instructions are aimed at specialists with responsibility for installing the measuring device. <ul style="list-style-type: none"> ▪ Incoming acceptance and product identification ▪ Storage and transport ▪ Installation
Transmitter Brief Operating Instructions	Guides you quickly to the 1st measured value - Part 2 The Transmitter Brief Operating Instructions are aimed at specialists with responsibility for commissioning, configuring and parameterizing the measuring device (until the first measured value). <ul style="list-style-type: none"> ▪ Product description ▪ Installation ▪ Electrical connection ▪ Operation options ▪ System integration ▪ Commissioning ▪ Diagnostic information
Description of Device Parameters	Reference for your parameters The document provides a detailed explanation of each individual parameter in the Expert operating menu. The description is aimed at those who work with the device over the entire life cycle and perform specific configurations. The document provides Modbus-specific information for each individual parameter in the Expert operating menu.

1.3.2 Supplementary device-dependent documentation

Additional documents are supplied depending on the device version ordered: Always comply strictly with the instructions in the supplementary documentation. The supplementary documentation is an integral part of the device documentation.

1.4 Registered trademarks

Modbus®

Registered trademark of SCHNEIDER AUTOMATION, INC.

2 Safety instructions

2.1 Requirements for the personnel

The personnel for installation, commissioning, diagnostics and maintenance must fulfill the following requirements:

- ▶ Trained, qualified specialists must have a relevant qualification for this specific function and task.
- ▶ Are authorized by the plant owner/operator.
- ▶ Are familiar with federal/national regulations.
- ▶ Before starting work, read and understand the instructions in the manual and supplementary documentation as well as the certificates (depending on the application).
- ▶ Follow instructions and comply with basic conditions.

The operating personnel must fulfill the following requirements:

- ▶ Are instructed and authorized according to the requirements of the task by the facility's owner-operator.
- ▶ Follow the instructions in this manual.

2.2 Designated use

Application and media

The measuring device described in these Operating Instructions is intended only for flow measurement of gases.

Depending on the version ordered, the measuring device can also measure potentially explosive, flammable, poisonous and oxidizing media.

Measuring devices for use in hazardous areas, in hygienic applications or where there is an increased risk due to process pressure, are labeled accordingly on the nameplate.

To ensure that the measuring device remains in proper condition for the operation time:

- ▶ Keep within the specified pressure and temperature range.
- ▶ Only use the measuring device in full compliance with the data on the nameplate and the general conditions listed in the Operating Instructions and supplementary documentation.
- ▶ Based on the nameplate, check whether the ordered device is permitted for the intended use in the hazardous area (e.g. explosion protection, pressure vessel safety).
- ▶ Use the measuring device only for media to which the process-wetted materials are sufficiently resistant.
- ▶ If the ambient temperature of the measuring device is outside the atmospheric temperature, it is absolutely essential to comply with the relevant basic conditions as specified in the device documentation. →  8
- ▶ Protect the measuring device permanently against corrosion from environmental influences.

Incorrect use

Non-designated use can compromise safety. The manufacturer is not liable for damage caused by improper or non-designated use.

WARNING

Danger of breakage due to corrosive or abrasive fluids and ambient conditions!

- ▶ Verify the compatibility of the process fluid with the sensor material.
- ▶ Ensure the resistance of all fluid-wetted materials in the process.
- ▶ Keep within the specified pressure and temperature range.

NOTICE**Verification for borderline cases:**

- ▶ For special fluids and fluids for cleaning, Endress+Hauser is glad to provide assistance in verifying the corrosion resistance of fluid-wetted materials, but does not accept any warranty or liability as minute changes in the temperature, concentration or level of contamination in the process can alter the corrosion resistance properties.

Residual risks**⚠ WARNING**

The electronics and the medium may cause the surfaces to heat up. This presents a burn hazard!

- ▶ For elevated fluid temperatures, ensure protection against contact to prevent burns.

⚠ WARNING**Danger from medium escaping!**

For device versions with a rupture disk: medium escaping under pressure can cause injury or material damage.

- ▶ Take precautions to prevent injury and material damage if the rupture disk is actuated.

2.3 Workplace safety

For work on and with the device:

- ▶ Wear the required personal protective equipment according to federal/national regulations.

For welding work on the piping:

- ▶ Do not ground the welding unit via the measuring device.

If working on and with the device with wet hands:

- ▶ Due to the increased risk of electric shock, gloves must be worn.

2.4 Operational safety

Risk of injury.

- ▶ Operate the device in proper technical condition and fail-safe condition only.
- ▶ The operator is responsible for interference-free operation of the device.

Conversions to the device

Unauthorized modifications to the device are not permitted and can lead to unforeseeable dangers.

- ▶ If, despite this, modifications are required, consult with Endress+Hauser.

Repair

To ensure continued operational safety and reliability,

- ▶ Carry out repairs on the device only if they are expressly permitted.
- ▶ Observe federal/national regulations pertaining to repair of an electrical device.
- ▶ Use original spare parts and accessories from Endress+Hauser only.

2.5 Product safety

This measuring device is designed in accordance with good engineering practice to meet state-of-the-art safety requirements, has been tested, and left the factory in a condition in which it is safe to operate.

It meets general safety standards and legal requirements. It also complies with the EU directives listed in the device-specific EU Declaration of Conformity. Endress+Hauser confirms this by affixing the CE mark to the device.





2.6 IT security

Our warranty is valid only if the device is installed and used as described in the Operating Instructions. The device is equipped with security mechanisms to protect it against any inadvertent changes to the settings.

IT security measures, which provide additional protection for the device and associated data transfer, must be implemented by the operators themselves in line with their security standards.

2.7 Device-specific IT security

The device offers a range of specific functions to support protective measures on the operator's side. These functions can be configured by the user and guarantee greater in-operation safety if used correctly. An overview of the most important functions is provided in the following section.

Function/interface	Factory setting	Recommendation
Write protection via hardware write protection switch →  12	Not enabled.	On an individual basis following risk assessment.
Access code (also applies for Web server login or FieldCare connection) →  13	Not enabled (0000).	Assign a customized access code during commissioning.
WLAN (order option in display module)	Enabled.	On an individual basis following risk assessment.
WLAN security mode	Enabled (WPA2-PSK)	Do not change.
WLAN passphrase (password) →  13	Serial number	Assign an individual WLAN passphrase during commissioning.
WLAN mode	Access Point	On an individual basis following risk assessment.
Web server →  13	Enabled.	On an individual basis following risk assessment.
CDI-RJ45 service interface →  14	–	On an individual basis following risk assessment.

2.7.1 Protecting access via hardware write protection

Write access to the device parameters via the local display, Web browser or operating tool (e.g. FieldCare, DeviceCare) can be disabled via a write protection switch (DIP switch on the motherboard). When hardware write protection is enabled, only read access to the parameters is possible.

Hardware write protection is disabled when the device is delivered →  120.

2.7.2 Protecting access via a password

Different passwords are available to protect write access to the device parameters or access to the device via the WLAN interface.

- **User-specific access code**
Protect write access to the device parameters via the local display, Web browser or operating tool (e.g. FieldCare, DeviceCare). Access authorization is clearly regulated through the use of a user-specific access code.
- **WLAN passphrase**
The network key protects a connection between an operating unit (e.g. notebook or tablet) and the device via the WLAN interface which can be ordered as an option.
- **Infrastructure mode**
When the device is operated in infrastructure mode, the WLAN passphrase corresponds to the WLAN passphrase configured on the operator side.

User-specific access code

Write access to the device parameters via the local display, Web browser or operating tool (e.g. FieldCare, DeviceCare) can be protected by the modifiable, user-specific access code (→  118).

When the device is delivered, the device does not have an access code and is equivalent to 0000 (open).

WLAN passphrase: Operation as WLAN access point

A connection between an operating unit (e.g. notebook or tablet) and the device via the WLAN interface (→  66), which can be ordered as an optional extra, is protected by the network key. The WLAN authentication of the network key complies with the IEEE 802.11 standard.

When the device is delivered, the network key is pre-defined depending on the device. It can be changed via the **WLAN settings** submenu in the **WLAN passphrase** parameter (→  112).

Infrastructure mode

A connection between the device and WLAN access point is protected by means of an SSID and passphrase on the system side. Please contact the relevant system administrator for access.

General notes on the use of passwords

- The access code and network key supplied with the device should be changed during commissioning.
- Follow the general rules for generating a secure password when defining and managing the access code or network key.
- The user is responsible for the management and careful handling of the access code and network key.
- For information on configuring the access code or on what to do if you lose the password, see the "Write protection via access code" section →  118

2.7.3 Access via Web server

The device can be operated and configured via a Web browser with the integrated Web server (→  58). The connection is via the service interface (CDI-RJ45) or the WLAN interface.

The Web server is enabled when the device is delivered. The Web server can be disabled if necessary (e.g. after commissioning) via the **Web server functionality** parameter.

The device and status information can be hidden on the login page. This prevents unauthorized access to the information.



For detailed information on device parameters, see:
The "Description of Device Parameters" document .

2.7.4 Access via service interface (CDI-RJ45)

The device can be connected to a network via the service interface (CDI-RJ45). Device-specific functions guarantee the secure operation of the device in a network.

The use of relevant industrial standards and guidelines that have been defined by national and international safety committees, such as IEC/ISA62443 or the IEEE, is recommended. This includes organizational security measures such as the assignment of access authorization as well as technical measures such as network segmentation.

3 Product description

The device consists of a transmitter and a sensor.

The device is available as a compact version:

The transmitter and sensor form a mechanical unit.

3.1 Product design

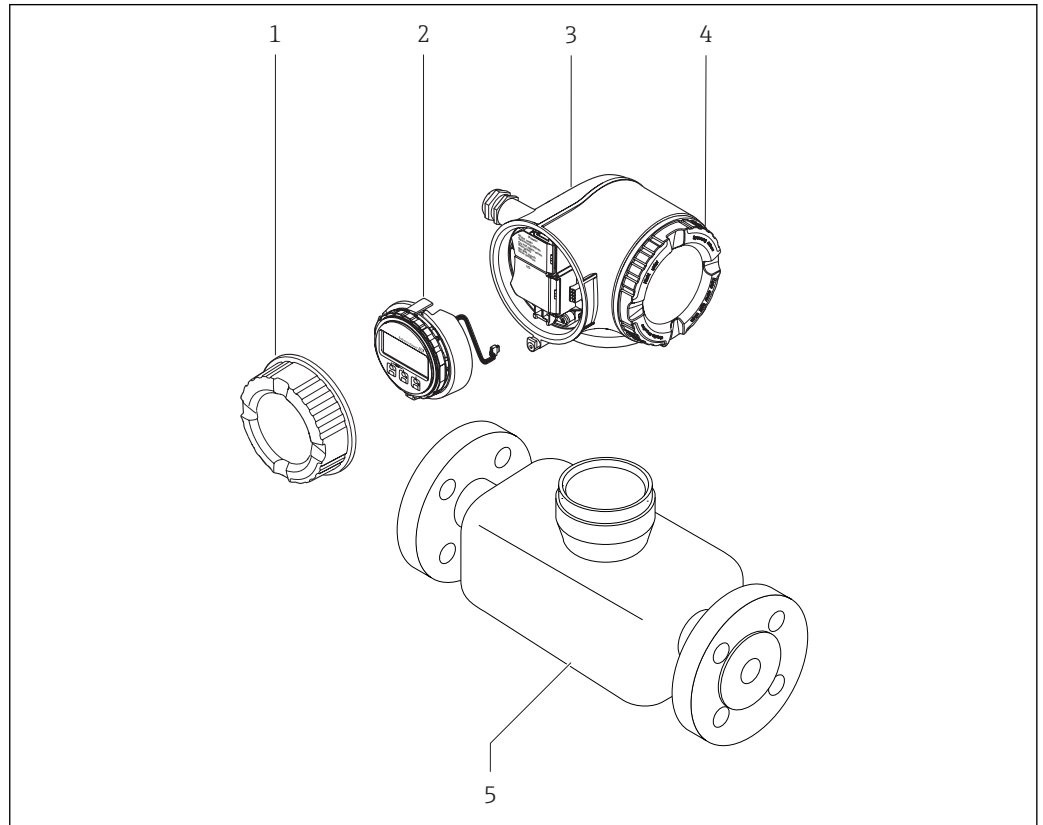



1 Important components of a measuring device

- 1 Connection compartment cover
- 2 Display module
- 3 Transmitter housing
- 4 Electronics compartment cover
- 5 Sensor

A0029586



4 Incoming acceptance and product identification

4.1 Incoming acceptance

  

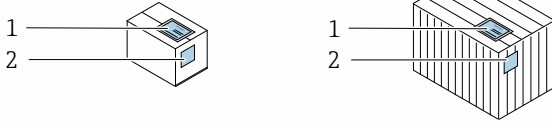

Are the order codes on the delivery note (1) and the product sticker (2) identical?



  



Are the goods undamaged?



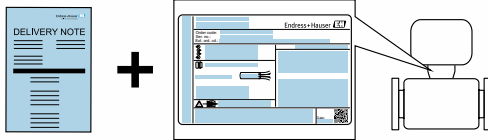

Do the nameplate data match the ordering information on the delivery note?



Is the document folder present with accompanying documents?
Is the optional CD-ROM with the Technical Documentation present?



- i**
- If one of the conditions is not satisfied, contact your Endress+Hauser Sales Center.
 - Depending on the device version, the CD-ROM might not be part of the delivery!
The Technical Documentation is available via the Internet or via the *Endress+Hauser Operations App*, see the "Product identification" section →  17.

4.2 Product identification

The following options are available for identification of the device:

- Nameplate specifications
- Order code with breakdown of the device features on the delivery note
- Enter serial numbers from nameplates in the *W@M Device Viewer* (www.endress.com/deviceviewer): All information about the device is displayed.
- Enter the serial number from nameplates in the *Endress+Hauser Operations App* or scan the 2-D matrix code (QR code) on the nameplate using the *Endress+Hauser Operations App*: All information about the device is displayed.

For an overview of the scope of the associated Technical Documentation, refer to the following:

- The "Additional standard documentation on the device" → 8 and "Supplementary device-dependent documentation" → 8 sections
- The *W@M Device Viewer*: enter the serial number from the nameplate (www.endress.com/deviceviewer)
- The *Endress+Hauser Operations App*: Enter the serial number from the nameplate or scan the 2-D matrix code (QR code) on the nameplate.

4.2.1 Transmitter nameplate

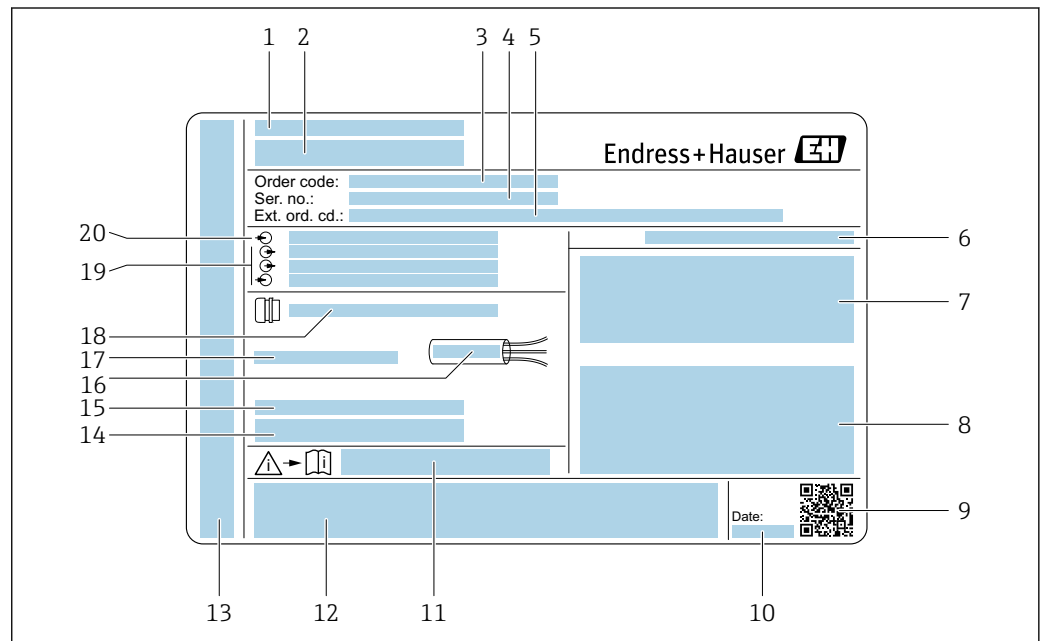

2 Example of a transmitter nameplate

- 1 Manufacturing location
- 2 Name of the transmitter
- 3 Order code
- 4 Serial number (ser. no.)
- 5 Extended order code (Ext. ord. cd.)
- 6 Degree of protection
- 7 Space for approvals: use in hazardous areas
- 8 Electrical connection data: available inputs and outputs
- 9 2-D matrix code
- 10 Manufacturing date: year-month
- 11 Document number of safety-related supplementary documentation
- 12 Space for approvals and certificates: e.g. CE mark, C-Tick
- 13 Space for degree of protection of connection and electronics compartment when used in hazardous areas
- 14 Firmware version (FW) and device revision (Dev.Rev.) from the factory
- 15 Space for additional information in the case of special products
- 16 Permitted temperature range for cable
- 17 Permitted ambient temperature (T_a)
- 18 Information on cable gland
- 19 Available inputs and outputs, supply voltage
- 20 Electrical connection data: supply voltage

4.2.2 Sensor nameplate

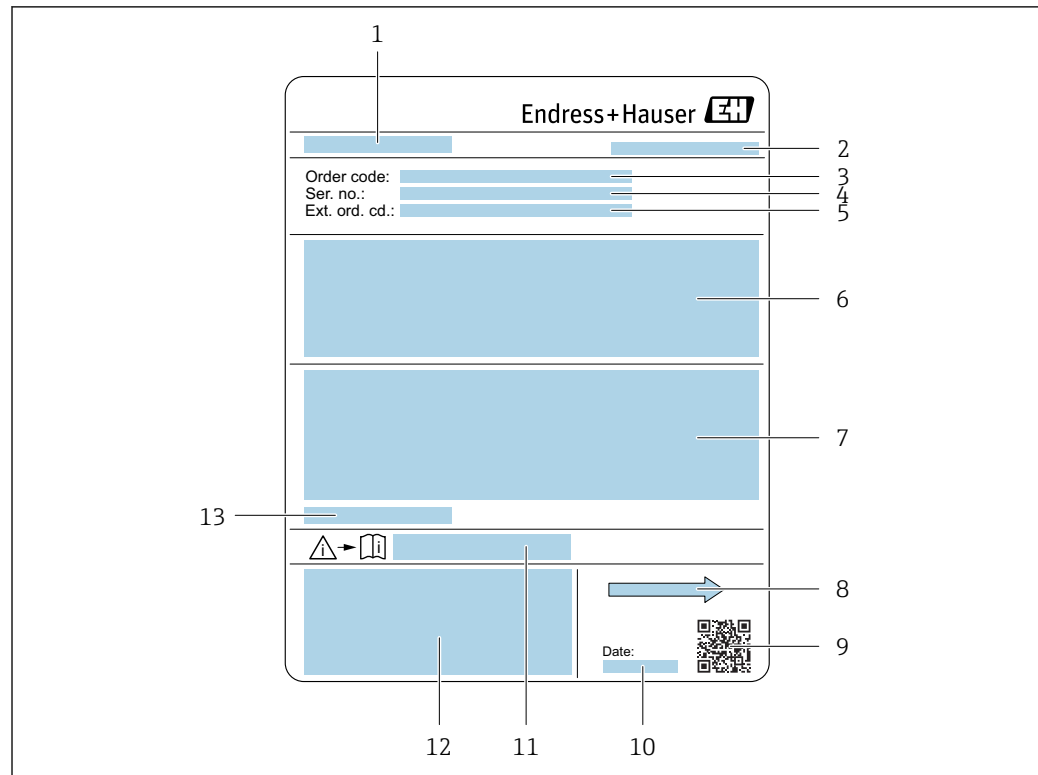

A0029204

3 Example of sensor nameplate

- 1 Name of the sensor
- 2 Manufacturing location
- 3 Order code
- 4 Serial number (Ser. no.)
- 5 Extended order code (Ext. ord. cd.)
- 6 Nominal diameter of the sensor; flange nominal diameter/nominal pressure; sensor test pressure; medium temperature range; material of measuring tube and flanges; sensor-specific data
- 7 Approval information for explosion protection, Pressure Equipment Directive and degree of protection
- 8 Flow direction
- 9 2-D matrix code
- 10 Manufacturing date: year-month
- 11 Document number of safety-related supplementary documentation → 186
- 12 CE mark, C-Tick
- 13 Allowable ambient temperature (T_a)



Order code

The measuring device is reordered using the order code.

Extended order code

- The device type (product root) and basic specifications (mandatory features) are always listed.
- Of the optional specifications (optional features), only the safety and approval-related specifications are listed (e.g. LA). If other optional specifications are also ordered, these are indicated collectively using the # placeholder symbol (e.g. #LA#).
- If the ordered optional specifications do not include any safety and approval-related specifications, they are indicated by the + placeholder symbol (e.g. XXXXXX-ABCDE+).

4.2.3 Symbols on measuring device

Symbol	Meaning
	WARNING! This symbol alerts you to a dangerous situation. Failure to avoid this situation can result in serious or fatal injury.
	Reference to documentation Refers to the corresponding device documentation.
	Protective ground connection A terminal which must be connected to ground prior to establishing any other connections.

5 Storage and transport

5.1 Storage conditions

Observe the following notes for storage:

- ▶ Store in the original packaging to ensure protection from shock.
- ▶ Do not remove protective covers or protective caps installed on process connections. They prevent mechanical damage to the sealing surfaces and contamination in the measuring tube.
- ▶ Protect from direct sunlight to avoid unacceptably high surface temperatures.
- ▶ Store in a dry and dust-free place.
- ▶ Do not store outdoors.

Storage temperature →  173

5.2 Transporting the product

Transport the measuring device to the measuring point in the original packaging.

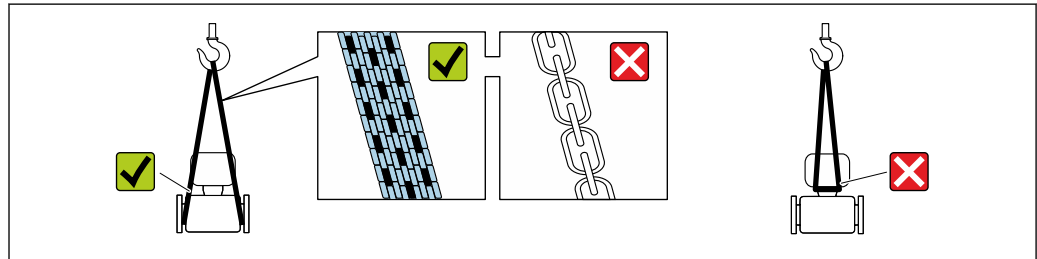

A0029252

-  Do not remove protective covers or caps installed on process connections. They prevent mechanical damage to the sealing surfaces and contamination in the measuring tube.

5.2.1 Measuring devices without lifting lugs

WARNING

Center of gravity of the measuring device is higher than the suspension points of the webbing slings.

Risk of injury if the measuring device slips.

- ▶ Secure the measuring device against slipping or turning.
- ▶ Observe the weight specified on the packaging (stick-on label).

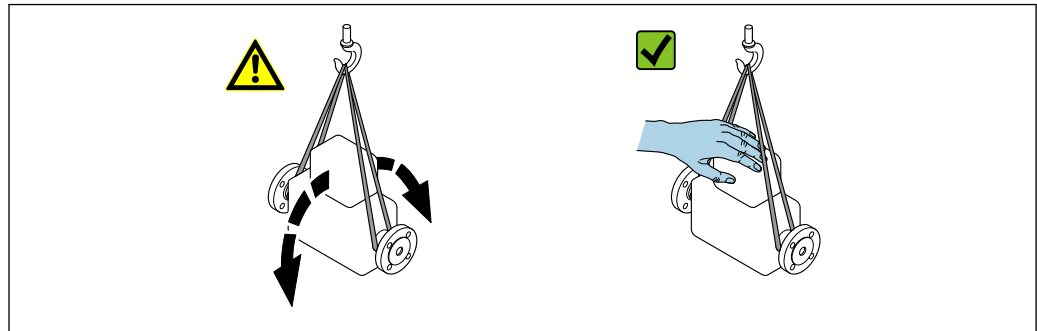

A0029214

5.2.2 Measuring devices with lifting lugs

⚠ CAUTION

Special transportation instructions for devices with lifting lugs

- ▶ Only use the lifting lugs fitted on the device or flanges to transport the device.
- ▶ The device must always be secured at two lifting lugs at least.

5.2.3 Transporting with a fork lift

If transporting in wood crates, the floor structure enables the crates to be lifted lengthwise or at both sides using a forklift.

5.3 Packaging disposal

All packaging materials are environmentally friendly and 100 % recyclable:

- Outer packaging of device
 - Polymer stretch wrap that complies with EU Directive 2002/95/EC (RoHS)
- Packaging
 - Wooden crate treated in accordance with ISPM 15 standard, confirmed by IPPC logo
 - Cardboard box in accordance with European packaging guideline 94/62EC, recyclability confirmed by Resy symbol
- Carrying and securing materials
 - Disposable plastic pallet
 - Plastic straps
 - Plastic adhesive strips
- Filler material
 - Paper pads

6 Installation

6.1 Mounting conditions

No special measures such as supports etc. are necessary. External forces are absorbed by the construction of the device.

6.1.1 Mounting position

Mounting location

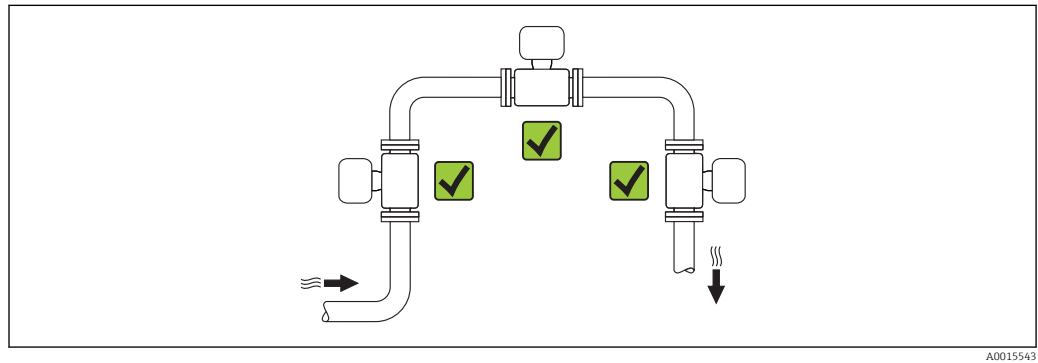

A0015543





Orientation

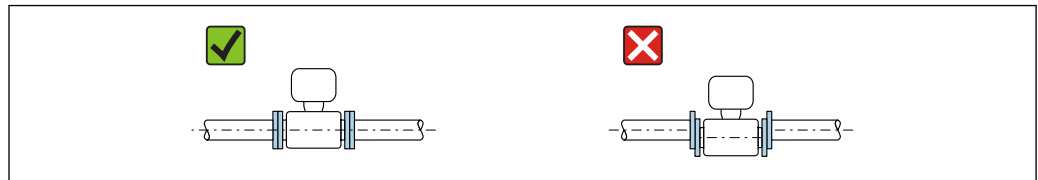

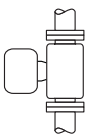

The direction of the arrow on the sensor helps you to install the sensor according to the flow direction (direction of medium flow through the piping).

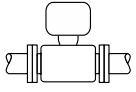
- i** ■ Install the measuring device in a parallel plane free of external mechanical stress.
- The internal diameter of the pipe must match the internal diameter of the sensor: see the "Technical Information" device document, "Design and dimensions" section.

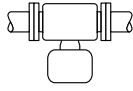

A0015895

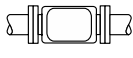
Orientation		Compact version
A	Vertical orientation	 <small>A0015545</small> 
B	Horizontal orientation, transmitter head up ¹⁾	 <small>A0015589</small> 

Orientation		Compact version	
C	Horizontal orientation, transmitter head down ¹⁾	 <small>A0015590</small>	
D	Horizontal orientation, transmitter head at side	 <small>A0015592</small>	

1) The horizontal alignment of the transducers may only deviate by a maximum of $\pm 5^\circ$, particularly if a liquid is present in the medium (wet gas).

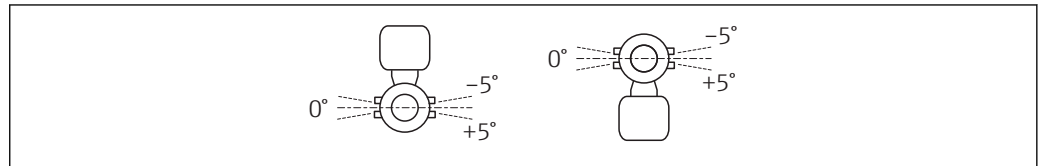

A0037650

Inlet and outlet runs

If possible, the sensor should be installed upstream from valves, T-pieces, elbows etc. To attain the specified level of accuracy of the measuring device, the below mentioned inlet and outlet runs must be maintained at minimum. If there are several flow disturbances present, the longest specified inlet run must be maintained.

Single-path version: DN 25 (1")

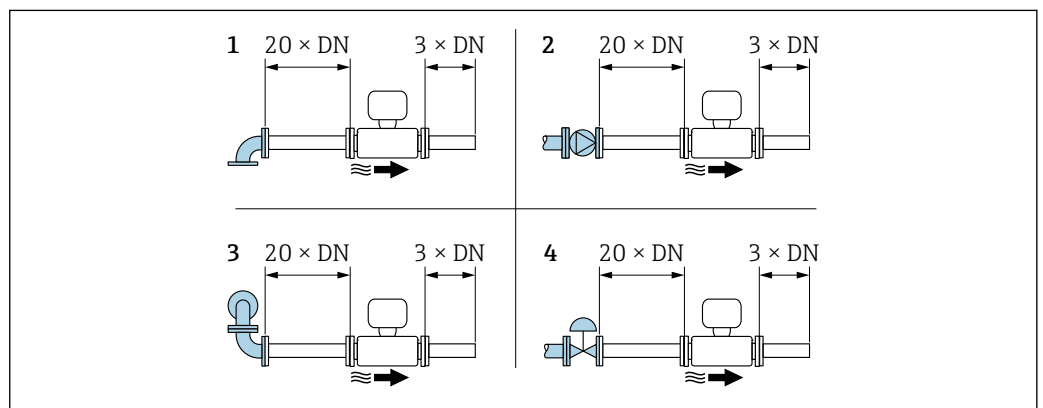

A0015453

4 Single-path version: minimum inlet and outlet runs with various flow obstructions

- 1 90° elbow or T-section
- 2 Pump
- 3 2 × 90° elbow, 3-dimensional
- 4 Control valve

Two-path version: DN 50 to 300 (2 to 12")

i With order code for "Calibration flow", option C "0.50%" and option D "0.50%, traceable to ISO/IEC17025":
 Inlet run = 20 × DN

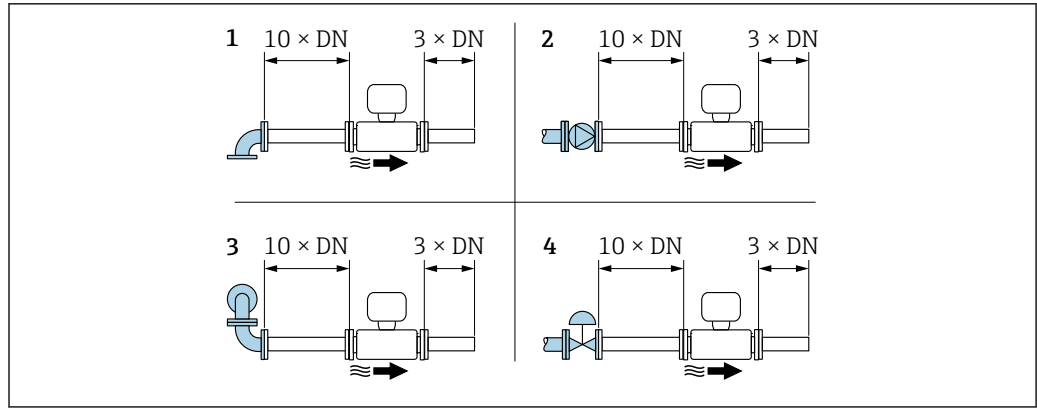

5 Two-path version: minimum inlet and outlet runs with various flow obstructions

- 1 90° elbow or T-section
- 2 Pump
- 3 2 x 90° elbow, 3-dimensional
- 4 Control valve

Outlet runs when installing external devices

If installing an external device, observe the specified distance.

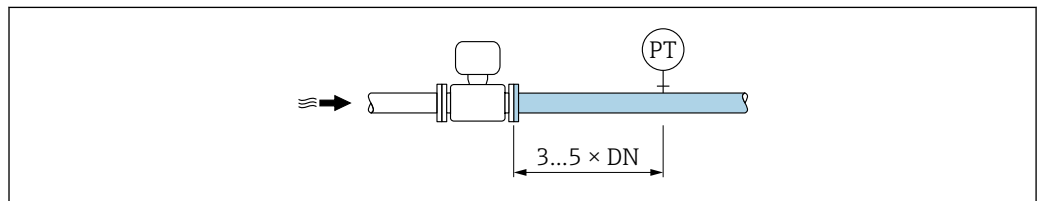

PT External device, e.g. temperature sensor, pressure measuring cell

Installation dimensions

For the dimensions and installation lengths of the device, see the "Technical Information" document, "Mechanical construction" section.

6.1.2 Environment and process requirements

Ambient temperature range

Measuring device	<ul style="list-style-type: none"> ■ Standard: -40 to +60 °C (-40 to +140 °F) ■ Optional order code for "Test, certificate", option JP: -50 to +60 °C (-58 to +140 °F)
Readability of the local display	-20 to +60 °C (-4 to +140 °F) The readability of the display may be impaired at temperatures outside the temperature range.

- If operating outdoors:
Avoid direct sunlight, particularly in warm climatic regions.

Medium pressure range

Min. medium pressure: 0.7 bar (10.2 psi) absolute

The maximum permitted medium pressure is defined by the pressure/temperature curves (see the "Technical Information" document) and the pressure specifications of the integrated pressure measuring cell (optional; order code for "Measuring tube; transducer;

sensor version", option AC "316L; Titanium Gr. 2; pressure + temperature measurement integrated").

⚠ WARNING

The maximum pressure for the measuring device depends on the lowest-rated element with regard to pressure.

- ▶ Note specifications regarding the pressure range of the pressure measuring cell.
- ▶ The Pressure Equipment Directive (2014/68/EU) uses the abbreviation "PS". The abbreviation "PS" corresponds to the MWP (maximum working pressure) of the pressure measuring cell.
- ▶ The MWP for the pressure measuring cell depends on the lowest-rated element, with regard to pressure, of the selected components, i.e. the process connection must be taken into consideration in addition to the pressure measuring cell. Also take the pressure/temperature dependency into consideration.
- ▶ The MWP may be applied at the device for an unlimited period. The MWP is indicated on the nameplate. This value refers to a reference temperature of +20 °C (+68 °F) and may be applied to the pressure measuring cell for an unlimited time.
- ▶ The OPL (over pressure limit = sensor overload limit) for the measuring device depends on the lowest-rated element, with regard to pressure, of the selected components, i.e. the process connection has to be taken into consideration in addition to the pressure measuring cell. Also take the pressure/temperature dependency into consideration.
- ▶ The test pressure corresponds to the over pressure limit of the pressure measuring cell and may be applied only temporarily to ensure that the measurement is within the specifications and no permanent damage occurs.

Pressure measuring cell	Maximum sensor measuring range		MWP	OPL
	Lower (LRL)	Upper (URL)		
	[bar (psi)]	[bar (psi)]	[bar (psi)]	[bar (psi)]
2 bar (30 psi)	0 (0)	+2 (+30)	6.7 (100.5)	10 (150)
4 bar (60 psi)	0 (0)	+4 (+60)	10.7 (160.5)	16 (240)
10 bar (150 psi)	0 (0)	+10 (+150)	25 (375)	40 (600)
40 bar (600 psi)	0 (0)	+40 (+600)	100 (1 500)	160 (2 400)
100 bar (1 500 psi)	0 (0)	+100 (+1 500)	100 (1 500)	160 (2 400)

Thermal insulation

For optimum measurement performance, make sure that no heat transfer (heat loss or heat supply) can take place at the sensor. This can be ensured by installing thermal insulation. The formation of condensation in the measuring device can also be limited in this way.

Thermal insulation is particularly recommended in situations in which the difference between the process temperature and ambient temperature is large. This difference leads to an error during temperature measurement that is caused by heat conduction (known as the "heat conduction error").

⚠ WARNING

Electronics overheating on account of thermal insulation!

- ▶ Recommended orientation: horizontal orientation, transmitter housing pointing downwards.
- ▶ Do not insulate the transmitter housing .
- ▶ Maximum permissible temperature at the lower end of the transmitter housing: 80 °C (176 °F)
- ▶ Thermal insulation with extended neck free: We recommend that you do not insulate the extended neck in order to ensure optimum dissipation of heat.

The thermal insulation should never cover the transmitter housing and the pressure measuring cell.

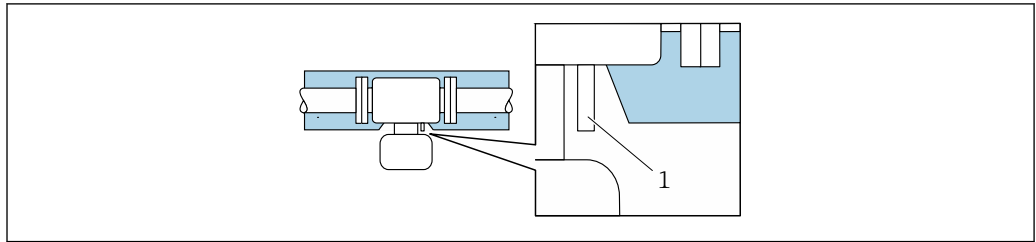

A0037676

6 Thermal insulation with free extended neck and pressure measuring cell

1 Pressure measuring cell

6.1.3 Special mounting instructions

Rupture disk

Information that is relevant to the process: → 174.

The position of the rupture disk is indicated on a sticker applied over it. If the rupture disk is triggered, the sticker is destroyed. The disk can therefore be visually monitored.

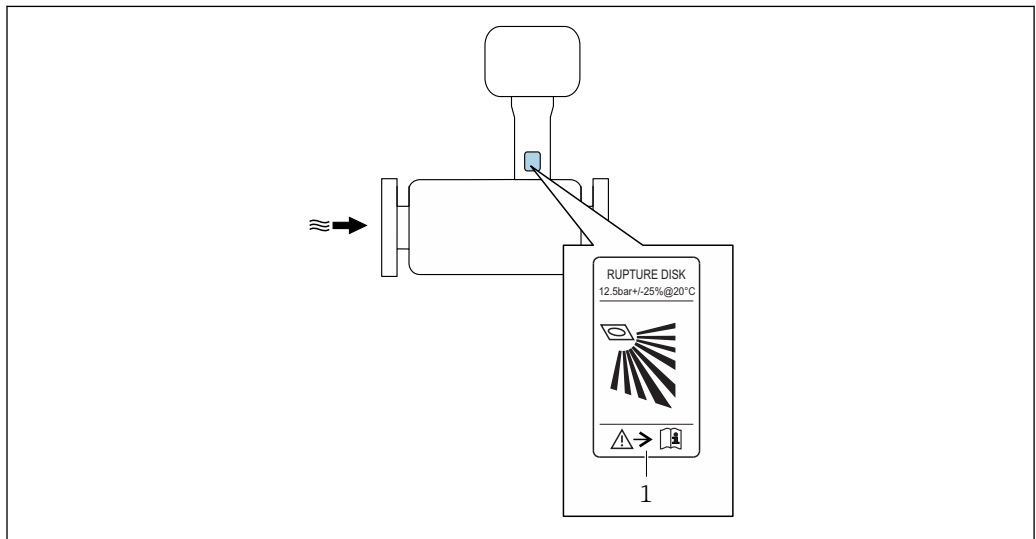

A0037501

1 Rupture disk label

Protective cover

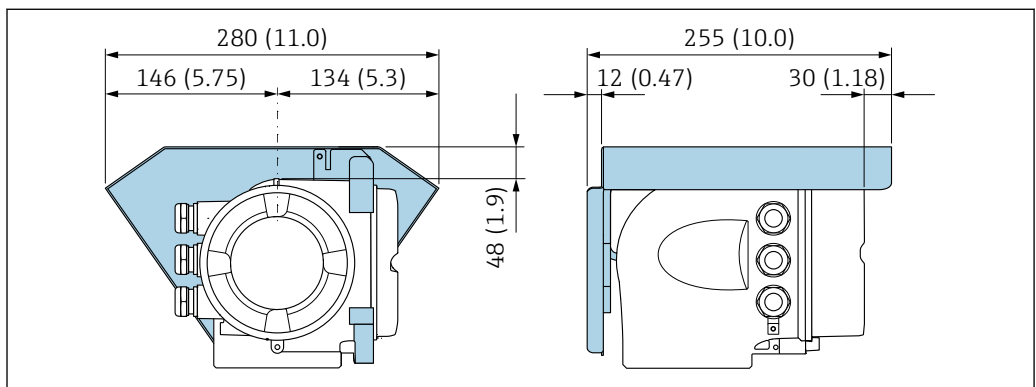

A0029553

Cover locking

NOTICE

Order code for "Housing", option L "Cast, stainless": The covers of the transmitter housing are provided with a borehole to lock the cover.

The cover can be locked using screws and a chain or cable provided by the customer.

- ▶ It is recommended to use stainless steel cables or chains.
- ▶ If a protective coating is applied, it is recommended to use a heat shrink tube to protect the housing paint.

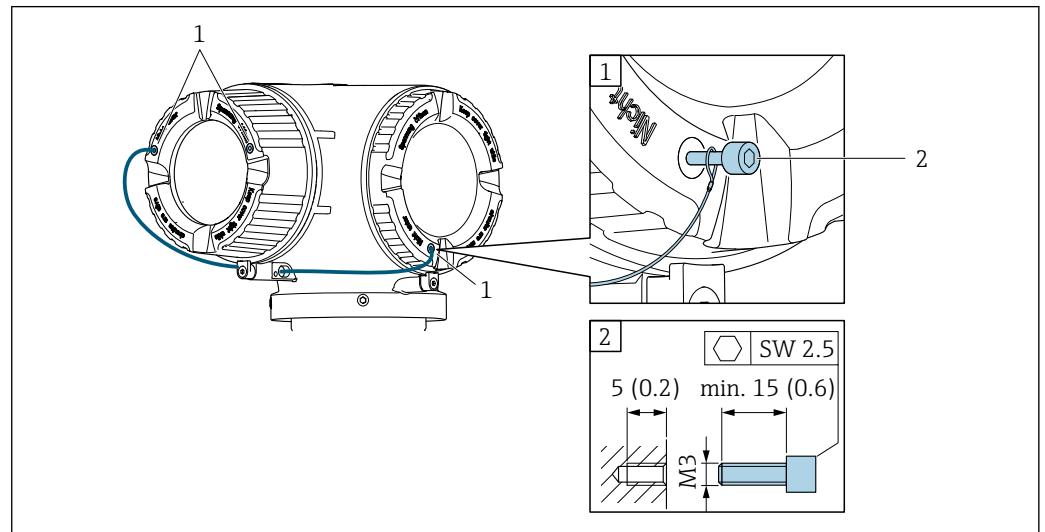

1 Cover borehole for the securing screw

2 Securing screw to lock the cover

6.2 Mounting the measuring device

6.2.1 Required tools

For sensor

For flanges and other process connections: Corresponding mounting tools

6.2.2 Preparing the measuring device

1. Remove all remaining transport packaging.
2. Remove any protective covers or protective caps present from the sensor.
3. Remove stick-on label on the electronics compartment cover.

6.2.3 Mounting the measuring device

⚠ WARNING

Danger due to improper process sealing!

- ▶ Ensure that the inside diameters of the gaskets are greater than or equal to that of the process connections and piping.
- ▶ Ensure that the gaskets are clean and undamaged.
- ▶ Install the gaskets correctly.

1. Ensure that the direction of the arrow on the sensor matches the flow direction of the medium.

2. Install the measuring device or turn the transmitter housing so that the cable entries do not point upwards.

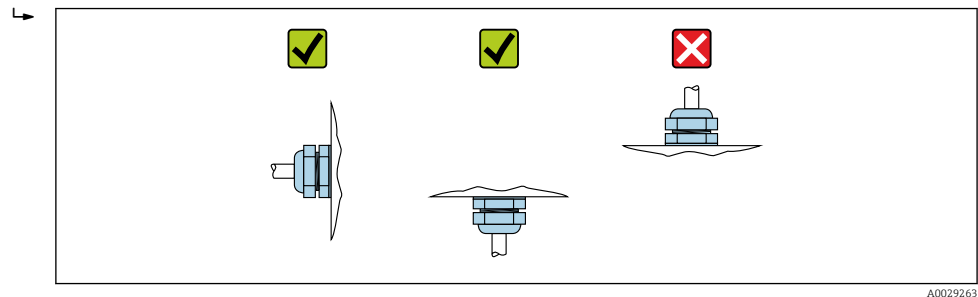

A0029263

6.2.4 Turning the transmitter housing

To provide easier access to the connection compartment or display module, the transmitter housing can be turned.

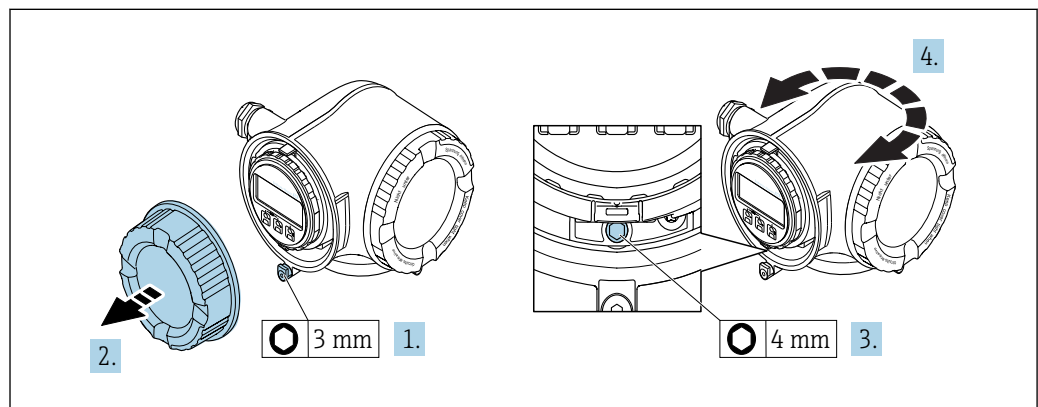

A0029993

1. Depending on the device version: Loosen the securing clamp of the connection compartment cover.
2. Unscrew the connection compartment cover.
3. Release the fixing screw.
4. Turn the housing to the desired position.
5. Firmly tighten the securing screw.
6. Screw on the connection compartment cover
7. Depending on the device version: Attach the securing clamp of the connection compartment cover.

6.2.5 Turning the display module

The display module can be turned to optimize display readability and operability.

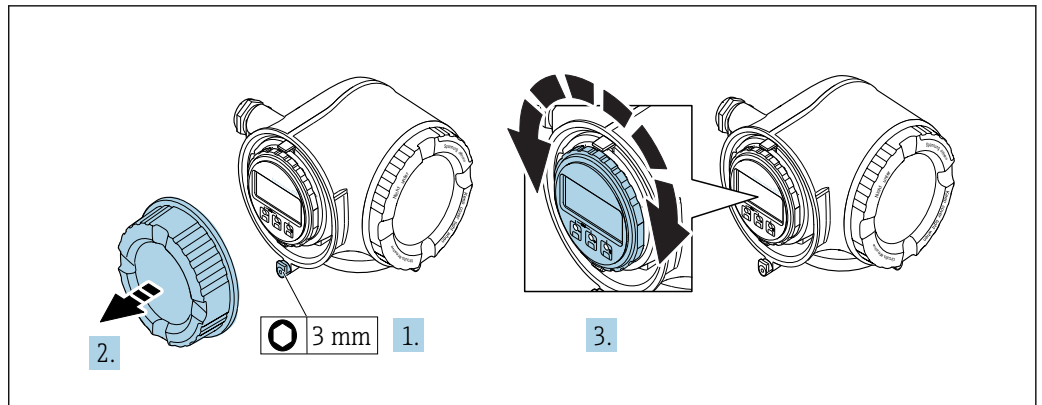

A0030035

1. Depending on the device version: Loosen the securing clamp of the connection compartment cover.
2. Unscrew the connection compartment cover.
3. Turn the display module to the desired position: max. 8 × 45° in each direction.
4. Screw on the connection compartment cover.
5. Depending on the device version: Attach the securing clamp of the connection compartment cover.

6.3 Post-mounting check

Is the device undamaged (visual inspection)?	<input type="checkbox"/>
Does the measuring device conform to the measuring point specifications? For example: <ul style="list-style-type: none"> ▪ Process temperature ▪ Process pressure (refer to the section on "Pressure-temperature ratings" in the "Technical Information" document) ▪ Ambient temperature range ▪ Measuring range 	<input type="checkbox"/>
Has the correct orientation for the sensor been selected → 22? <ul style="list-style-type: none"> ▪ According to sensor type ▪ According to medium temperature ▪ According to medium properties (outgassing, with entrained solids) 	<input type="checkbox"/>
Does the arrow on the sensor match the direction of flow of the medium through the piping → 22?	<input type="checkbox"/>
Are the measuring point identification and labeling correct (visual inspection)?	<input type="checkbox"/>
Is the device adequately protected from precipitation and direct sunlight?	<input type="checkbox"/>
Are the securing screw and securing clamp tightened securely?	<input type="checkbox"/>

7 Electrical connection

NOTICE

The measuring device does not have an internal circuit breaker.

- ▶ For this reason, assign the measuring device a switch or power-circuit breaker so that the power supply line can be easily disconnected from the mains.
- ▶ Although the measuring device is equipped with a fuse, additional overcurrent protection (maximum 10 A) should be integrated into the system installation.

7.1 Connection conditions

7.1.1 Required tools

- For cable entries: Use corresponding tools
- For securing clamp: Allen key 3 mm
- Wire stripper
- When using stranded cables: Crimper for wire end ferrule
- For removing cables from terminal: Flat blade screwdriver ≤ 3 mm (0.12 in)

7.1.2 Requirements for connecting cable

The connecting cables provided by the customer must fulfill the following requirements.

Electrical safety

In accordance with applicable federal/national regulations.

Protective ground cable

Cable ≥ 2.08 mm² (14 AWG)

The grounding impedance must be less than 1 Ω .

Permitted temperature range

- The installation guidelines that apply in the country of installation must be observed.
- The cables must be suitable for the minimum and maximum temperatures to be expected.

Power supply cable

Standard installation cable is sufficient.

Signal cable

Modbus RS485

The EIA/TIA-485 standard specifies two types of cable (A and B) for the bus line which can be used for every transmission rate. Cable type A is recommended.

Cable type	A
Characteristic impedance	135 to 165 Ω at a measuring frequency of 3 to 20 MHz
Cable capacitance	< 30 pF/m
Wire cross-section	> 0.34 mm ² (22 AWG)
Cable type	Twisted pairs
Loop resistance	≤ 110 Ω /km

Signal damping	Max. 9 dB over the entire length of the cable cross-section
Shield	Copper braided shielding or braided shielding with foil shield. When grounding the cable shield, observe the grounding concept of the plant.

Current output 0/4 to 20 mA

Standard installation cable is sufficient.

Pulse/frequency/switch output

Standard installation cable is sufficient.

Double pulse output

Standard installation cable is sufficient.

Relay output

Standard installation cable is sufficient.

Current input 0/4 to 20 mA

Standard installation cable is sufficient.

Status input

Standard installation cable is sufficient.

Cable diameter

- Cable glands supplied:
M20 × 1.5 with cable Ø 6 to 12 mm (0.24 to 0.47 in)
- Spring-loaded terminals: Suitable for strands and strands with ferrules.
Conductor cross-section 0.2 to 2.5 mm² (24 to 12 AWG).

Requirements for the connecting cable – Remote display and operating module DKX001*Optionally available connecting cable*

A cable is supplied depending on the order option

- Order code for measuring device: order code **030** for "Display; operation", option **O** or
- Order code for measuring device: order code **030** for "Display; operation", option **M** and
- Order code for DKX001: order code **040** for "Cable", option **A, B, D, E**

Standard cable	2 × 2 × 0.34 mm ² (22 AWG) PVC cable with common shield (2 pairs, pair-stranded)
Flame resistance	According to DIN EN 60332-1-2
Oil-resistance	According to DIN EN 60811-2-1
Shielding	Tin-plated copper-braid, optical cover ≥ 85 %
Capacitance: core/shield	≤200 pF/m
L/R	≤24 μH/Ω
Available cable length	5 m (15 ft)/10 m (35 ft)/20 m (65 ft)/30 m (100 ft)
Operating temperature	When mounted in a fixed position: -50 to +105 °C (-58 to +221 °F); when cable can move freely: -25 to +105 °C (-13 to +221 °F)

Standard cable - customer-specific cable

No cable is supplied, and it must be provided by the customer (up to max.

300 m (1 000 ft)) for the following order option:

Order code for DKX001: Order code **040** for "Cable", option **1** "None, provided by customer, max 300 m"

A standard cable can be used as the connecting cable.

Standard cable	4 cores (2 pairs); pair-stranded with common shield
Shielding	Tin-plated copper-braid, optical cover $\geq 85\%$
Capacitance: core/shield	Maximum 1 000 nF for Zone 1, Class I, Division 1
L/R	Maximum 24 $\mu\text{H}/\Omega$ for Zone 1, Class I, Division 1
Cable length	Maximum 300 m (1 000 ft), see the following table



Cross-section	Max. cable length for use in Non-hazardous area, Ex Zone 2, Class I, Division 2 Ex Zone 1, Class I, Division 1
0.34 mm ² (22 AWG)	80 m (270 ft)
0.50 mm ² (20 AWG)	120 m (400 ft)
0.75 mm ² (18 AWG)	180 m (600 ft)
1.00 mm ² (17 AWG)	240 m (800 ft)
1.50 mm ² (15 AWG)	300 m (1 000 ft)

7.1.3 Terminal assignment

Transmitter: supply voltage, input/outputs

The terminal assignment of the inputs and outputs depends on the individual order version of the device. The device-specific terminal assignment is documented on an adhesive label in the terminal cover.

Supply voltage		Input/output 1		Input/output 2		Input/output 3	
1 (+)	2 (-)	26 (B)	27 (A)	24 (+)	25 (-)	22 (+)	23 (-)
Device-specific terminal assignment: adhesive label in terminal cover.							

 Terminal assignment of the remote display and operating module →  37.

7.1.4 Shielding and grounding

Shielding and grounding concept

1. Maintain electromagnetic compatibility (EMC).
2. Take explosion protection into consideration.
3. Pay attention to the protection of persons.
4. Comply with national installation regulations and guidelines.
5. Observe cable specifications .
6. Keep the stripped and twisted lengths of cable shield to the ground terminal as short as possible.
7. Shield cables fully.

Grounding of the cable shield

NOTICE

In systems without potential matching, the multiple grounding of the cable shield causes mains frequency equalizing currents!

Damage to the bus cable shield.

- ▶ Only ground the bus cable shield to either the local ground or the protective ground at one end.
- ▶ Insulate the shield that is not connected.

To comply with EMC requirements:

1. Ensure the cable shield is grounded to the potential matching line at multiple points.
2. Connect every local ground terminal to the potential matching line.

7.1.5 Preparing the measuring device

NOTICE

Insufficient sealing of the housing!

Operational reliability of the measuring device could be compromised.

- ▶ Use suitable cable glands corresponding to the degree of protection.

1. Remove dummy plug if present.
2. If the measuring device is supplied without cable glands:
Provide suitable cable gland for corresponding connecting cable.
3. If the measuring device is supplied with cable glands:
Observe requirements for connecting cables →  30.

7.2 Connecting the measuring device

NOTICE

Limitation of electrical safety due to incorrect connection!

- ▶ Have electrical connection work carried out by appropriately trained specialists only.
- ▶ Observe applicable federal/national installation codes and regulations.
- ▶ Comply with local workplace safety regulations.
- ▶ Always connect the protective ground cable \ominus before connecting additional cables.
- ▶ For use in potentially explosive atmospheres, observe the information in the device-specific Ex documentation.

7.2.1 Connecting the transmitter

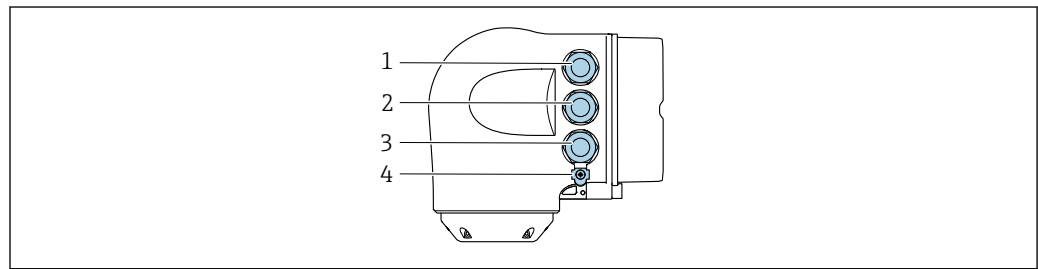

A0026781

- 1 Terminal connection for supply voltage
- 2 Terminal connection for signal transmission, input/output
- 3 Terminal connection for signal transmission, input/output or terminal connection for network connection via service interface (CDI-RJ45); optional: connection for external WLAN antenna or remote display and operating module DKX001
- 4 Protective earth (PE)

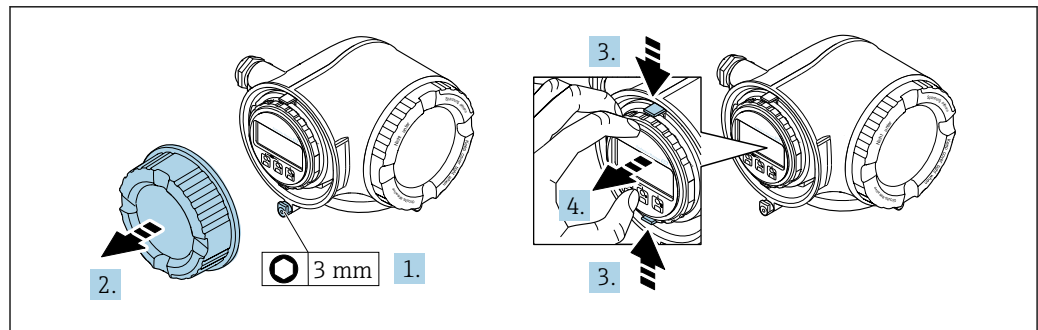

A0029813

1. Loosen the securing clamp of the connection compartment cover.
2. Unscrew the connection compartment cover.
3. Squeeze the tabs of the display module holder together.
4. Remove the display module holder.

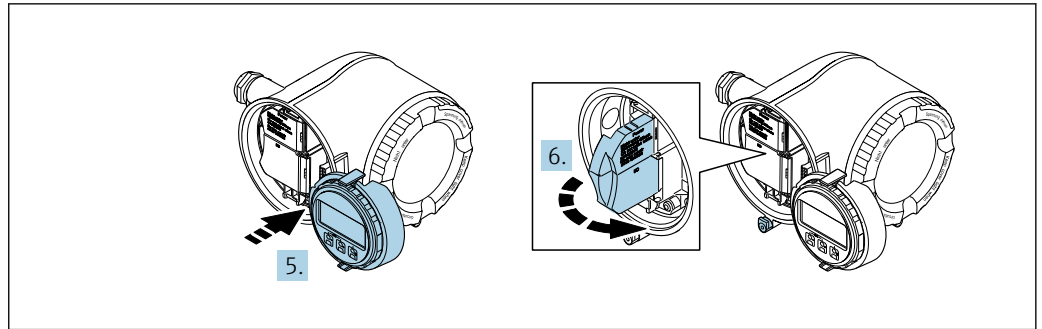

A0029814

5. Attach the holder to the edge of the electronics compartment.
6. Open the terminal cover.

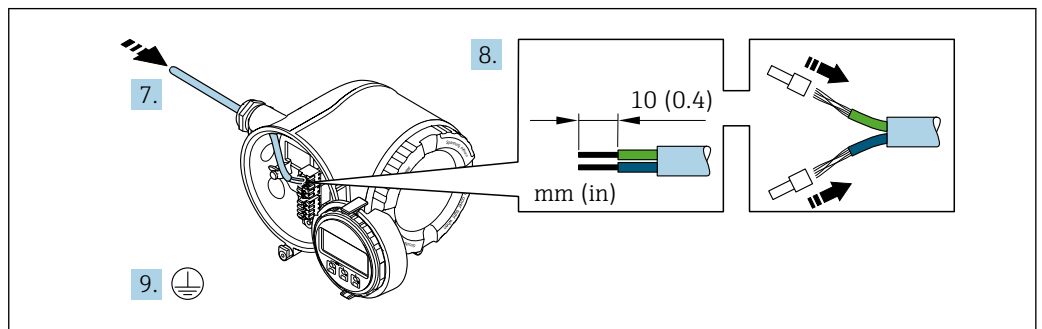

A0029815

7. Push the cable through the cable entry . To ensure tight sealing, do not remove the sealing ring from the cable entry.
8. Strip the cable and cable ends. In the case of stranded cables, also fit ferrules.
9. Connect the protective ground.

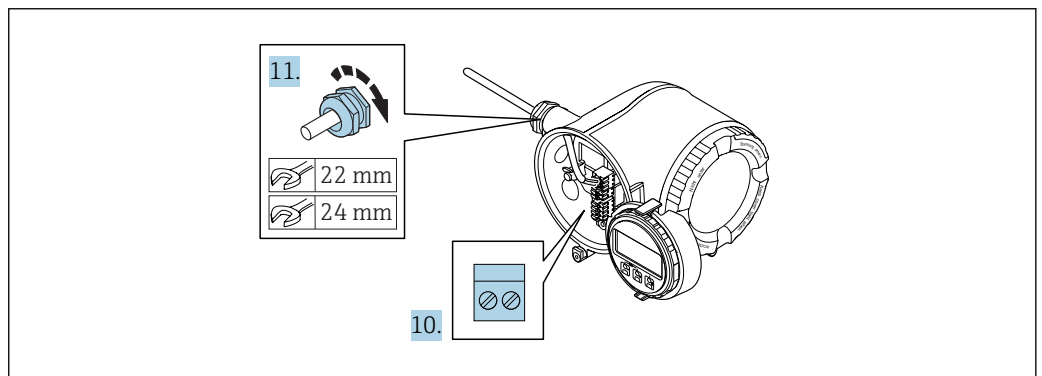

A0029816

10. Connect the cable in accordance with the terminal assignment .
 - ↳ **Signal cable terminal assignment:** The device-specific terminal assignment is documented on an adhesive label in the terminal cover.
 - Supply voltage terminal assignment:** Adhesive label in the terminal cover or → 33.
11. Firmly tighten the cable glands.
 - ↳ This concludes the cable connection process.
12. Close the terminal cover.
13. Fit the display module holder in the electronics compartment.
14. Screw on the connection compartment cover.
15. Secure the securing clamp of the connection compartment cover.

Removing a cable

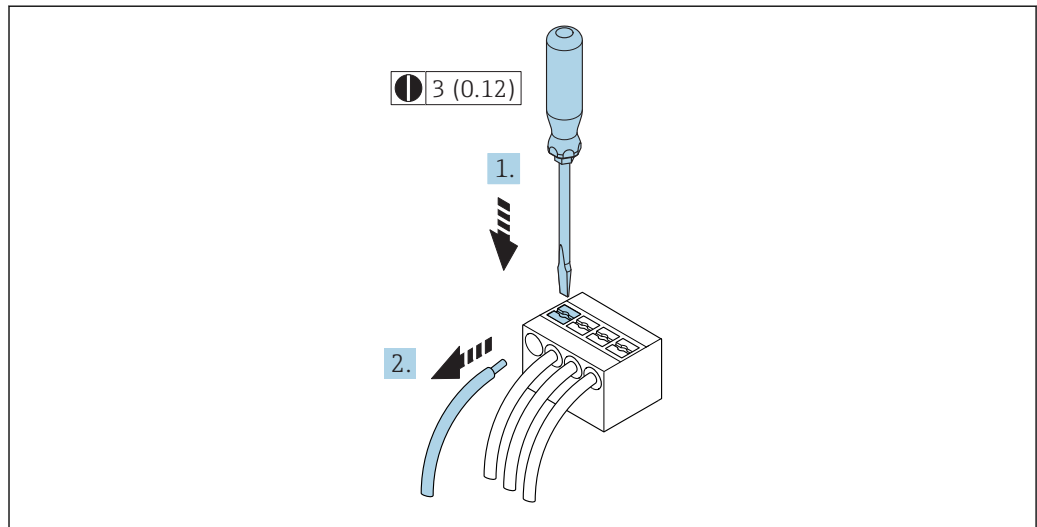

7 Engineering unit mm (in)

A0029598

1. To remove a cable from the terminal, use a flat-blade screwdriver to push the slot between the two terminal holes
2. while simultaneously pulling the cable end out of the terminal.

7.2.2 Connecting the remote display and operating module DKX001

i The remote display and operating module DKX001 is available as an optional extra → 158.

- The measuring device is always supplied with a dummy cover when the remote display and operating module DKX001 is ordered directly with the measuring device. Display or operation at the transmitter is not possible in this case.
- If ordered subsequently, the remote display and operating module DKX001 may not be connected at the same time as the existing measuring device display module. Only one display or operation unit may be connected to the transmitter at any one time.

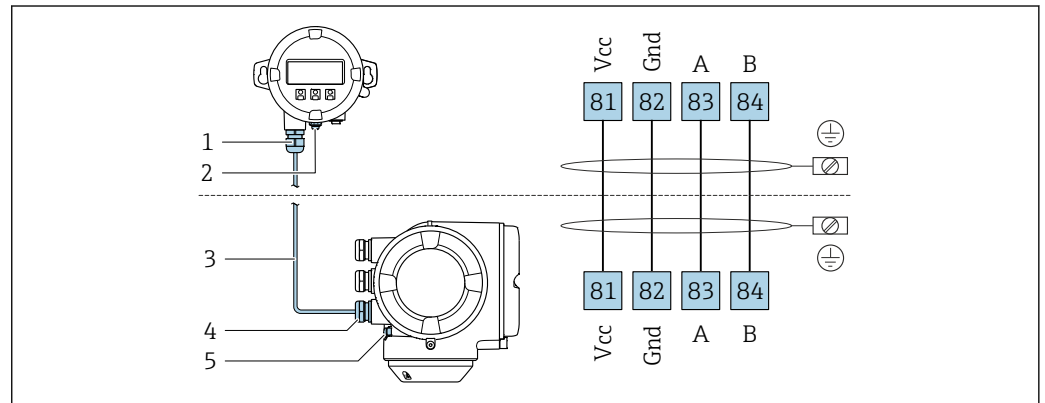

A0027518

- 1 Remote display and operating module DKX001
- 2 Protective earth (PE)
- 3 Connecting cable
- 4 Measuring device
- 5 Protective earth (PE)

7.3 Ensuring potential equalization

7.3.1 Requirements

Please consider the following to ensure correct measurement:

- Same electrical potential for the fluid and sensor
- Company-internal grounding concepts

7.4 Special connection instructions

7.4.1 Connection examples

Modbus RS485

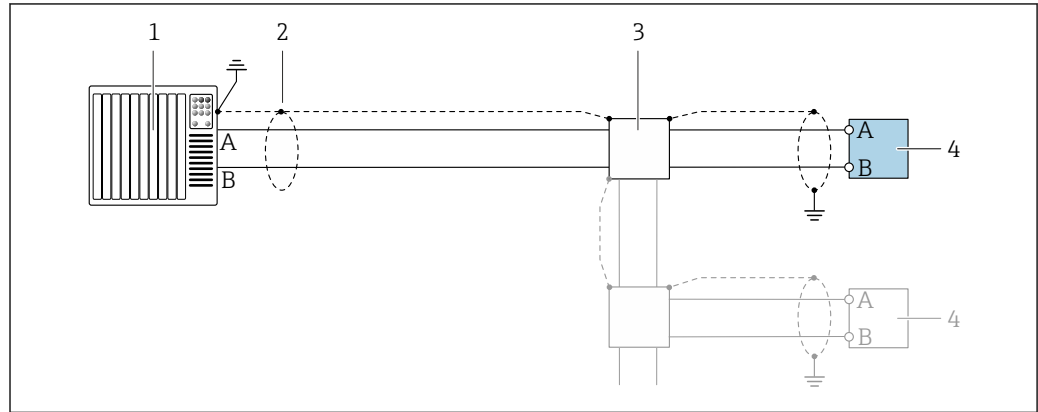

A0028765

8 Connection example for Modbus RS485, non-hazardous area and Zone 2; Class I, Division 2

- 1 Control system (e.g. PLC)
- 2 Cable shield provided at one end. The cable shield must be grounded at both ends to comply with EMC requirements; observe cable specifications
- 3 Distribution box
- 4 Transmitter

Current output 4-20 mA

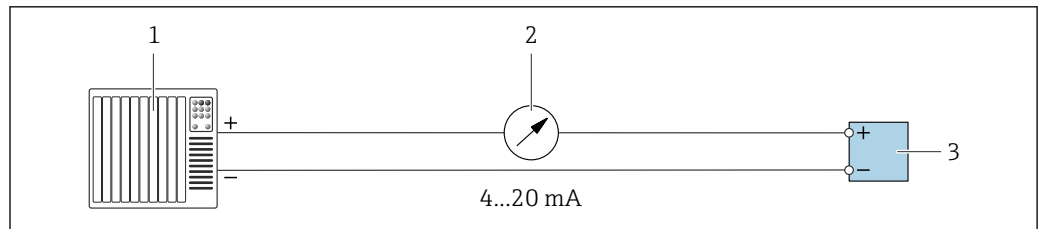

A0028758

9 Connection example for 4-20 mA current output (active)

- 1 Automation system with current input (e.g. PLC)
- 2 Analog display unit: observe maximum load
- 3 Transmitter

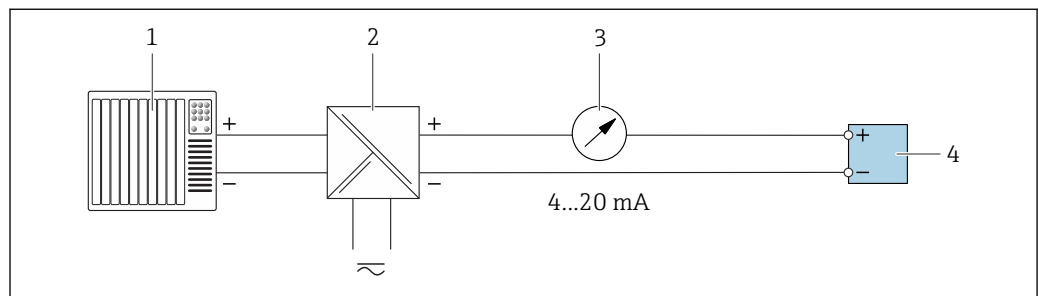

A0028759

10 Connection example for 4-20 mA current output (passive)

- 1 Automation system with current input (e.g. PLC)
- 2 Active barrier for power supply (e.g. RN221N)
- 3 Analog display unit: observe maximum load
- 4 Transmitter

Pulse/frequency output

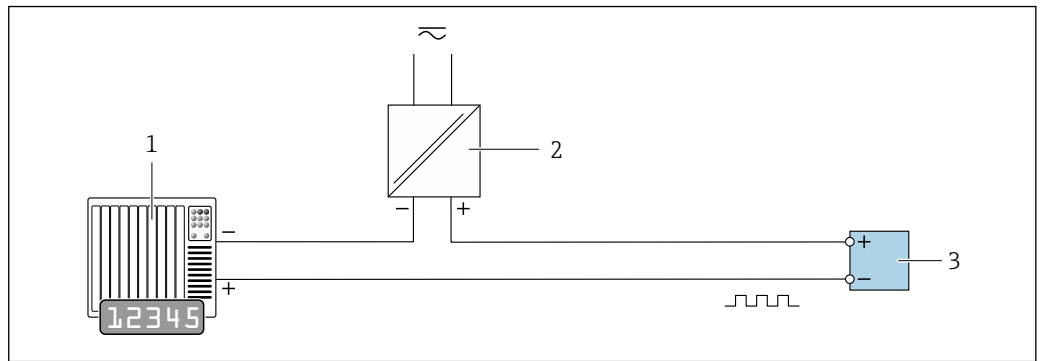

A0028761

- 11 Connection example for pulse/frequency output (passive)
- 1 Automation system with pulse/frequency input (e.g. PLC)
 - 2 Power supply
 - 3 Transmitter: Observe input values → 165

Switch output

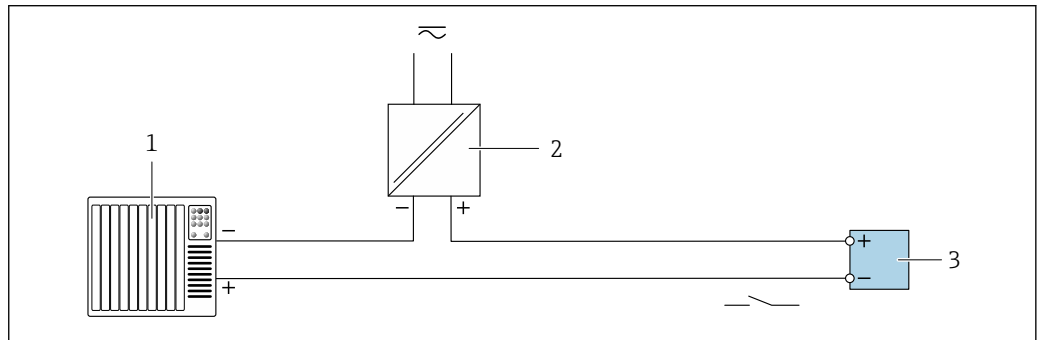

A0028760

- 12 Connection example for switch output (passive)
- 1 Automation system with switch input (e.g. PLC)
 - 2 Power supply
 - 3 Transmitter: Observe input values → 165

Double pulse output

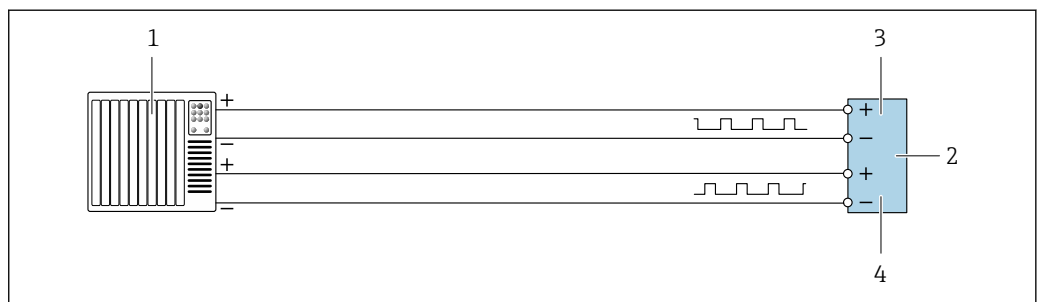

A0029280

- 13 Connection example for double pulse output (active)
- 1 Automation system with double pulse input (e.g. PLC)
 - 2 Transmitter: Observe input values → 166
 - 3 Double pulse output
 - 4 Double pulse output (slave), phase-shifted

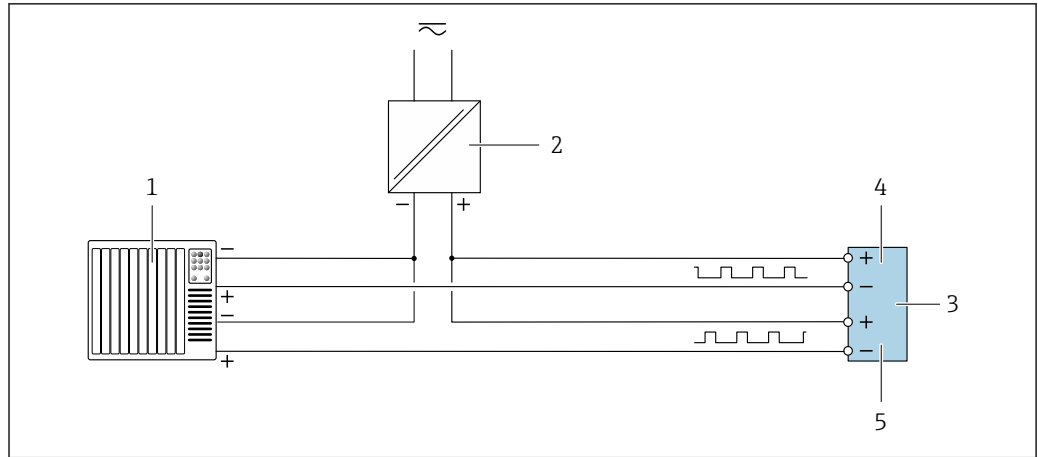

A0029279

14 Connection example for double pulse output (passive)

- 1 Automation system with double pulse input (e.g. PLC)
- 2 Power supply
- 3 Transmitter: Observe input values → 166
- 4 Double pulse output
- 5 Double pulse output (slave), phase-shifted

Relay output

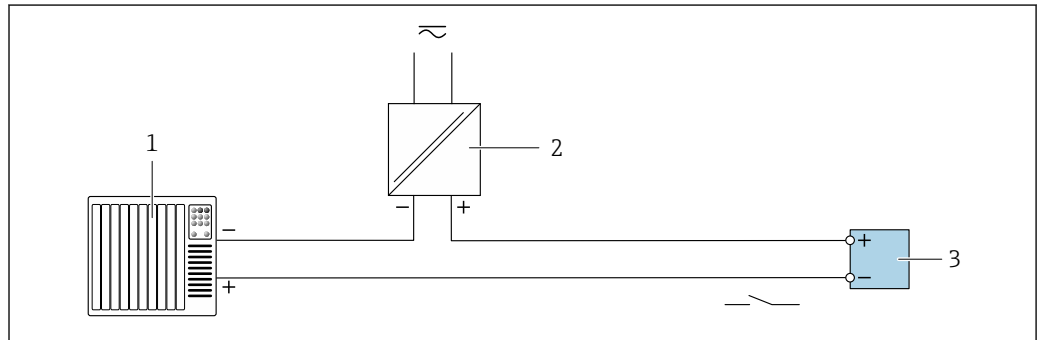

A0028760

15 Connection example for relay output (passive)

- 1 Automation system with relay input (e.g. PLC)
- 2 Power supply
- 3 Transmitter: Observe input values → 167

Current input

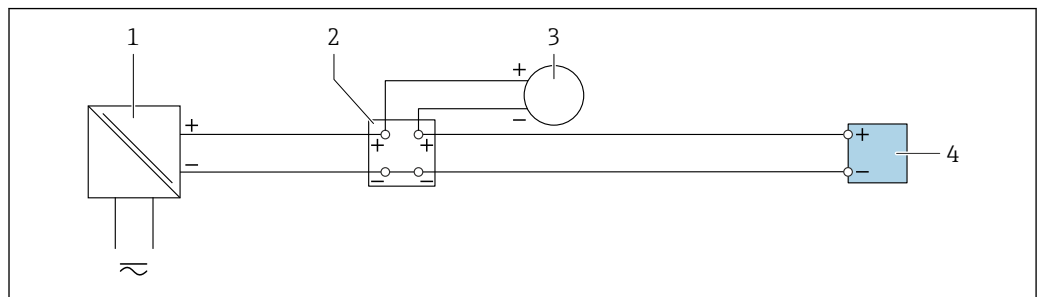

A0028915

16 Connection example for 4 to 20 mA current input

- 1 Power supply
- 2 Terminal box
- 3 External measuring device (for reading in pressure or temperature, for instance)
- 4 Transmitter

Status input

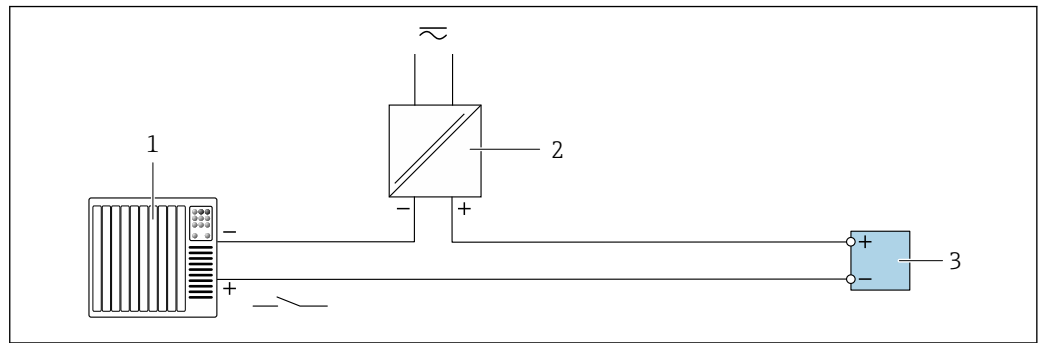

A0028764

17 Connection example for status input

- 1 Automation system with status output (e.g. PLC)
- 2 Power supply
- 3 Transmitter

7.5 Hardware settings

7.5.1 Setting the device address

The device address must always be configured for a Modbus slave. The valid device addresses are in the range from 1 to 247. Each address may only be assigned once in a Modbus RS485 network. If an address is not configured correctly, the measuring device is not recognized by the Modbus master. All measuring devices are delivered from the factory with the device address 247 and with the "software addressing" address mode.

Hardware addressing

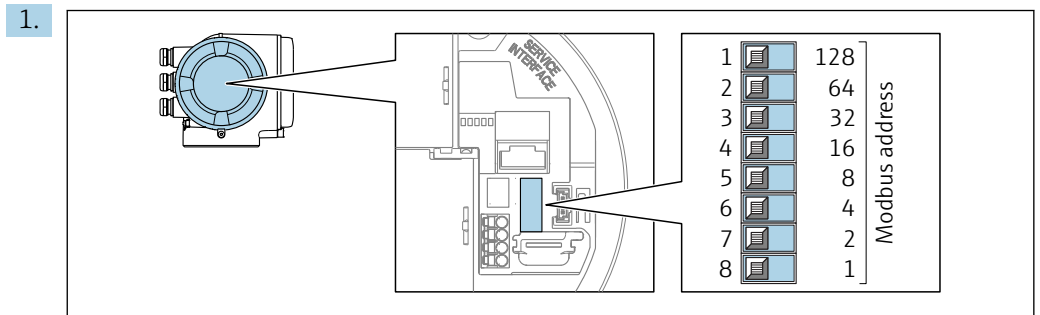

A0029634

Set the desired device address using the DIP switches in the connection compartment.

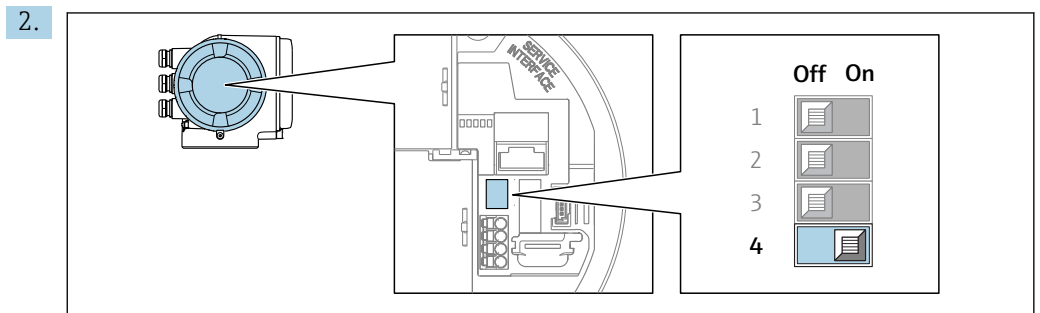

A0029633

To switch addressing from software addressing to hardware addressing: set the DIP switch to **On**.

↳ The change of device address takes effect after 10 seconds.

Software addressing

- ▶ To switch addressing from hardware addressing to software addressing: set the DIP switch to **Off**.
 - ↳ The device address configured in the **Device address** parameter takes effect after 10 seconds.

7.5.2 Enabling the terminating resistor

To avoid incorrect communication transmission caused by impedance mismatch, terminate the Modbus RS485 cable correctly at the start and end of the bus segment.

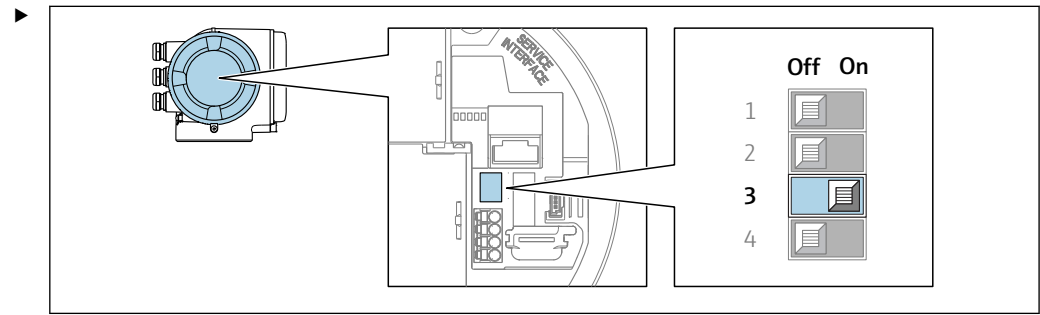

Switch DIP switch No. 3 to **On**.

7.6 Ensuring the degree of protection

The measuring device fulfills all the requirements for the IP66/67 degree of protection, Type 4X enclosure.

To guarantee IP66/67 degree of protection, Type 4X enclosure, carry out the following steps after the electrical connection:

1. Check that the housing seals are clean and fitted correctly.
2. Dry, clean or replace the seals if necessary.
3. Tighten all housing screws and screw covers.
4. Firmly tighten the cable glands.
5. To ensure that moisture does not enter the cable entry: Route the cable so that it loops down before the cable entry ("water trap").

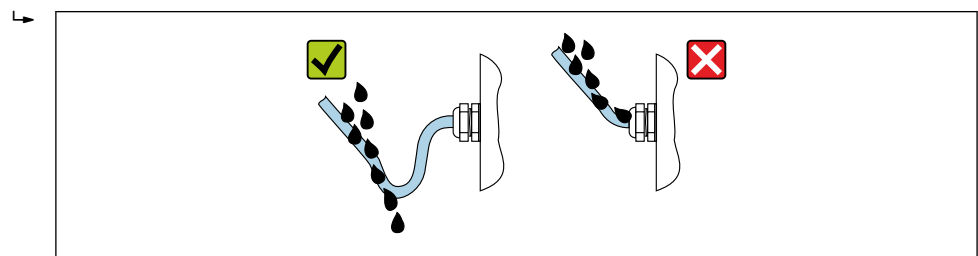

6. Insert dummy plugs into unused cable entries.

7.7 Post-connection check

Are cables or the device undamaged (visual inspection)?	<input type="checkbox"/>
Do the cables used meet the requirements?	<input type="checkbox"/>
Do the cables have adequate strain relief?	<input type="checkbox"/>

Are all the cable glands installed, firmly tightened and leak-tight? Cable run with "water trap" → 42?	<input type="checkbox"/>
If supply voltage is present, do values appear on the display module?	<input type="checkbox"/>

8 Operation options

8.1 Overview of operation options

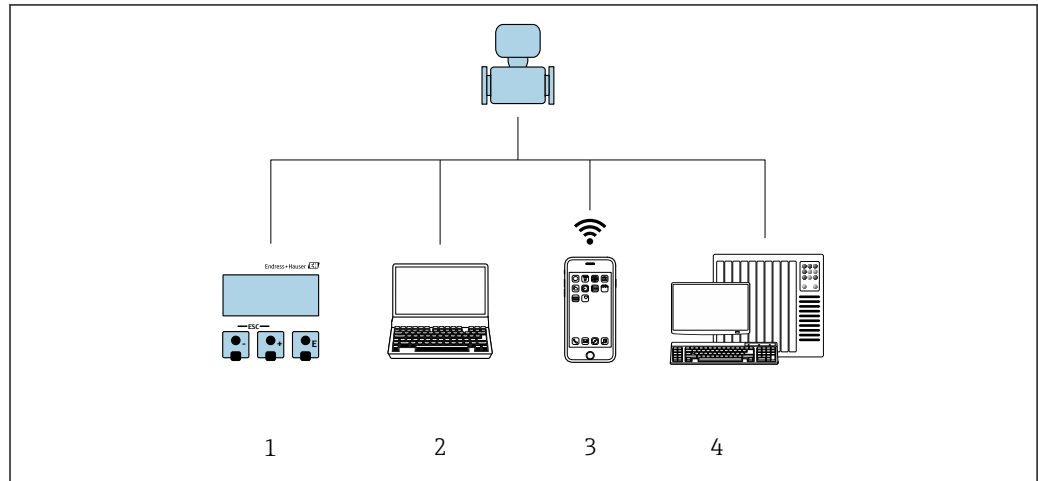

A0030213

- 1 Local operation via display module
- 2 Computer with Web browser (e.g. Internet Explorer) or with operating tool (e.g. FieldCare, DeviceCare, AMS Device Manager, SIMATIC PDM)
- 3 Mobile handheld terminal with SmartBlue App
- 4 Control system (e.g. PLC)

8.2 Structure and function of the operating menu

8.2.1 Structure of the operating menu

 For an overview of the operating menu for experts: "Description of Device Parameters" document supplied with the device

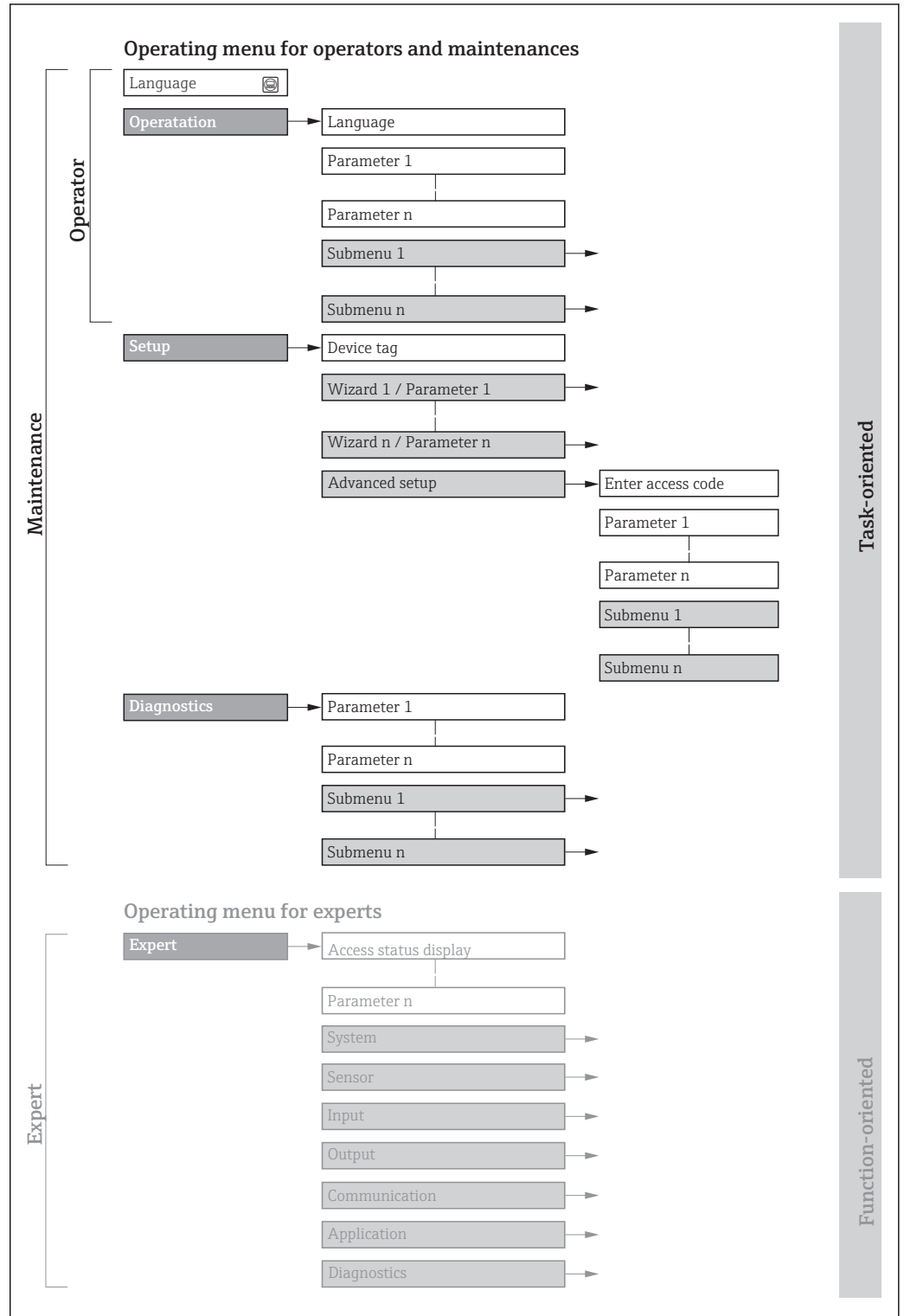

 18 Schematic structure of the operating menu

A0018237-EN

8.2.2 Operating philosophy

The individual parts of the operating menu are assigned to certain user roles (operator, maintenance etc.). Each user role contains typical tasks within the device lifecycle.

Menu/parameter		User role and tasks	Content/meaning
Language	task-oriented	Role "Operator", "Maintenance" Tasks during operation: <ul style="list-style-type: none"> ▪ Configuring the operational display ▪ Reading measured values 	<ul style="list-style-type: none"> ▪ Defining the operating language ▪ Defining the Web server operating language ▪ Resetting and controlling totalizers
Operation			<ul style="list-style-type: none"> ▪ Configuring the operational display (e.g. display format, display contrast) ▪ Resetting and controlling totalizers
Setup		"Maintenance" role Commissioning: <ul style="list-style-type: none"> ▪ Configuration of the measurement ▪ Configuration of the inputs and outputs ▪ Configuration of the communication interface 	Wizards for fast commissioning: <ul style="list-style-type: none"> ▪ Setting the system units ▪ Displaying the I/O/configuration ▪ Configuring the measuring point ▪ Configuring the inputs ▪ Configuring the outputs ▪ Configuration of the operational display ▪ Setting the low flow cut off ▪ Configuration of gas analysis Advanced setup <ul style="list-style-type: none"> ▪ For more customized configuration of the measurement (adaptation to special measuring conditions) ▪ Configuration of totalizers ▪ Configuring the WLAN settings ▪ Administration (define access code, reset measuring device)
Diagnostics		"Maintenance" role Fault elimination: <ul style="list-style-type: none"> ▪ Diagnostics and elimination of process and device errors ▪ Measured value simulation 	Contains all parameters for error detection and analyzing process and device errors: <ul style="list-style-type: none"> ▪ Diagnostic list Contains up to 5 currently pending diagnostic messages. ▪ Event logbook Contains event messages that have occurred. ▪ Device information Contains information for identifying the device. ▪ Measured values Contains all current measured values. ▪ Data logging submenu with "Extended HistorOM" order option Storage and visualization of measured values ▪ Heartbeat The functionality of the device is checked on demand and the verification results are documented. ▪ Simulation Is used to simulate measured values or output values.
Expert	function-oriented	Tasks that require detailed knowledge of the function of the device: <ul style="list-style-type: none"> ▪ Commissioning measurements under difficult conditions ▪ Optimal adaptation of the measurement to difficult conditions ▪ Detailed configuration of the communication interface ▪ Error diagnostics in difficult cases 	Contains all the parameters of the device and makes it possible to access these parameters directly using an access code. The structure of this menu is based on the function blocks of the device: <ul style="list-style-type: none"> ▪ System Contains all higher-order device parameters which do not concern the measurement or the communication interface. ▪ Sensor Configuration of the measurement. ▪ Input Configuration of the status input. ▪ Output Configuration of the analog current outputs as well as the pulse/frequency and switch output. ▪ Communication Configuration of the digital communication interface and the Web server. ▪ Application Configuration of the functions that go beyond the actual measurement (e.g. totalizer). ▪ Diagnostics Error detection and analysis of process and device errors and for device simulation and Heartbeat Technology.

8.3 Access to the operating menu via the local display

8.3.1 Operational display

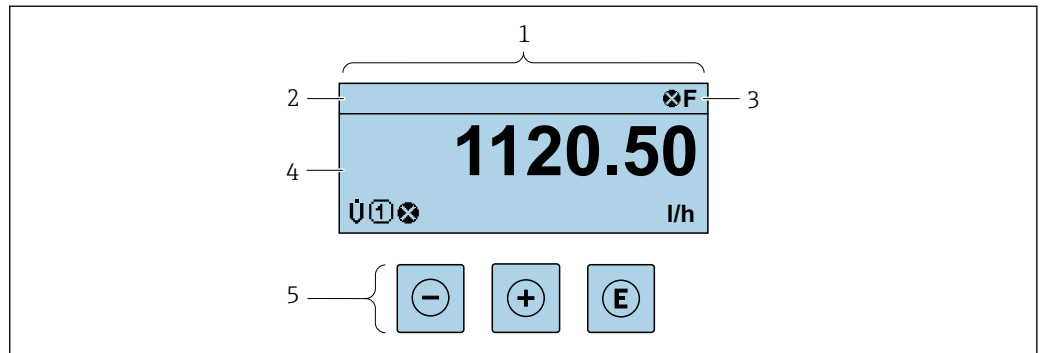

A0029346

- 1 Operational display
- 2 Device tag → 78
- 3 Status area
- 4 Display area for measured values (4-line)
- 5 Operating elements → 53

Status area

The following symbols appear in the status area of the operational display at the top right:

- Status signals → 138
 - **F**: Failure
 - **C**: Function check
 - **S**: Out of specification
 - **M**: Maintenance required
- Diagnostic behavior → 139
 - : Alarm
 - : Warning
- : Locking (the device is locked via the hardware)
- : Communication (communication via remote operation is active)

Display area

In the display area, each measured value is prefaced by certain symbol types for further description:

	Measured variable	Measurement channel number	Diagnostic behavior
	↓	↓	↓
Example			

Appears only if a diagnostics event is present for this measured variable.

Measured values

Symbol	Meaning
	<ul style="list-style-type: none"> ▪ Volume flow ▪ Corrected volume flow
	Mass flow

C	Sound velocity
P	Pressure
P	Energy flow
	Flow velocity
	Temperature
W	Wobbe index
U	Methane fraction
M	Molar mass
	<ul style="list-style-type: none"> ▪ Density ▪ Reference density
η	Dynamic viscosity
H	Calorific value
SNR	Signal to noise ratio
	Acceptance rate
A	Asymmetry
T	Turbulence
	Signal strength
Σ	Totalizer The measurement channel number indicates which of the three totalizers is displayed.
	Output The measurement channel number indicates which of the outputs is displayed.
	Status input

Measurement channel numbers

Symbol	Meaning
	Measurement channel 1 to 4
The measurement channel number is displayed only if more than one channel is present for the same measured variable type (e.g. Totalizer 1 to 3).	

Diagnostic behavior

The diagnostic behavior pertains to a diagnostic event that is relevant to the displayed measured variable.
 For information on the symbols → 139

The number and display format of the measured values can be configured via the **Format display** parameter (→ 97).

8.3.2 Navigation view

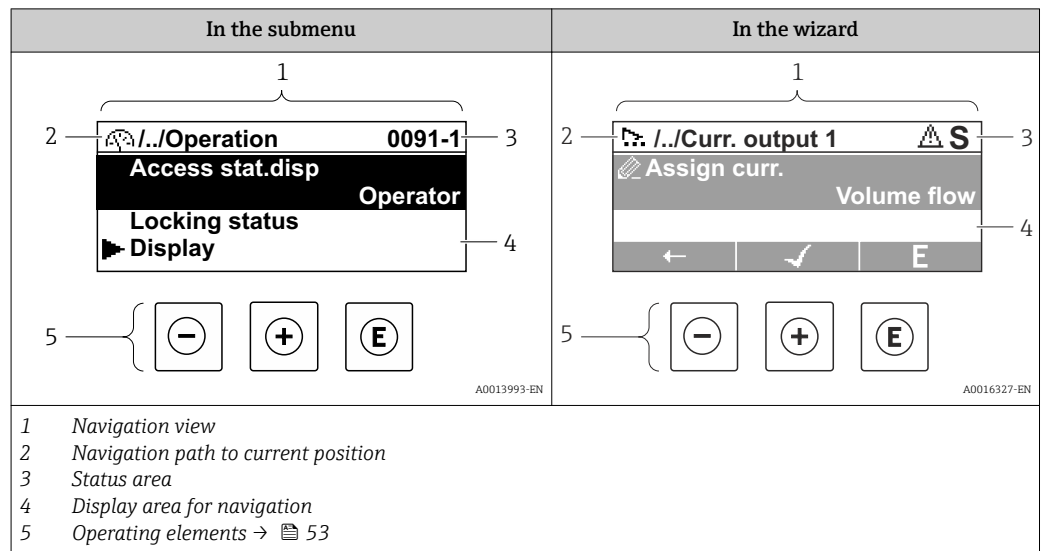

Navigation path

The navigation path - displayed at the top left in the navigation view - consists of the following elements:

	<ul style="list-style-type: none"> In the submenu: Display symbol for menu In the wizard: Display symbol for wizard 	Omission symbol for operating menu levels in between	Name of current <ul style="list-style-type: none"> Submenu Wizard Parameters
	↓	↓	↓
Examples		/ .. /	Display
		/ .. /	Display

For more information about the icons in the menu, refer to the "Display area" section → 50

Status area





The following appears in the status area of the navigation view in the top right corner:

- In the submenu
 - The direct access code for the parameter you are navigating to (e.g. 0022-1)
 - If a diagnostic event is present, the diagnostic behavior and status signal
- In the wizard
 - If a diagnostic event is present, the diagnostic behavior and status signal





- For information on the diagnostic behavior and status signal → 138
- For information on the function and entry of the direct access code → 55

Display area

Menus

Symbol	Meaning
	Operation Appears: <ul style="list-style-type: none"> In the menu next to the "Operation" selection At the left in the navigation path in the Operation menu
	Setup Appears: <ul style="list-style-type: none"> In the menu next to the "Setup" selection At the left in the navigation path in the Setup menu
	Diagnostics Appears: <ul style="list-style-type: none"> In the menu next to the "Diagnostics" selection At the left in the navigation path in the Diagnostics menu
	Expert Appears: <ul style="list-style-type: none"> In the menu next to the "Expert" selection At the left in the navigation path in the Expert menu



Submenus, wizards, parameters

Symbol	Meaning
	Submenu
	Wizard
	Parameters within a wizard
	No display symbol exists for parameters in submenus.

Locking

Symbol	Meaning
	Parameter locked When displayed in front of a parameter name, indicates that the parameter is locked. <ul style="list-style-type: none"> By a user-specific access code By the hardware write protection switch

Wizard operation

Symbol	Meaning
	Switches to the previous parameter.
	Confirms the parameter value and switches to the next parameter.
	Opens the editing view of the parameter.

8.3.3 Editing view

Numeric editor

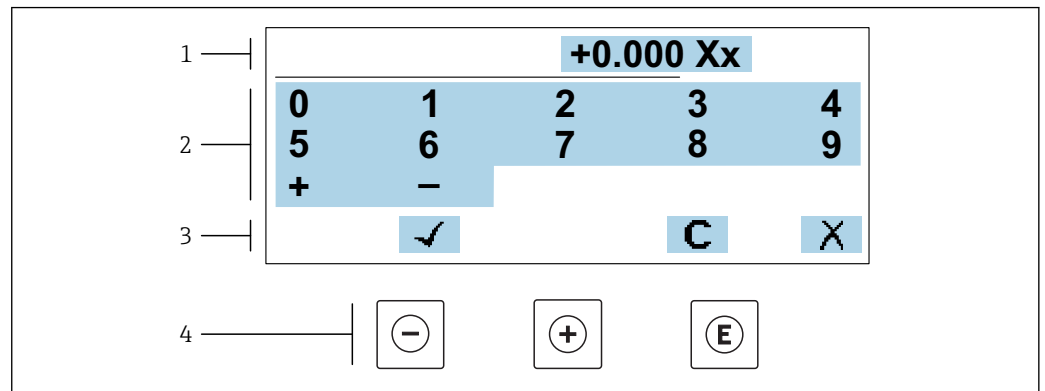

A0034250

19 For entering values in parameters (e.g. limit values)

- 1 Entry display area
- 2 Input screen
- 3 Confirm, delete or reject entry
- 4 Operating elements

Text editor

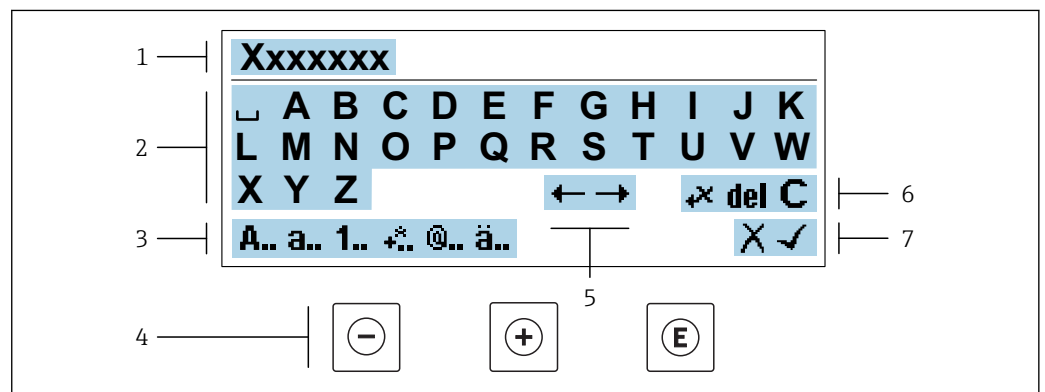



A0034114

20 For entering text in parameters (e.g. tag name)



- 1 Entry display area
- 2 Current input screen
- 3 Change input screen
- 4 Operating elements
- 5 Move entry position
- 6 Delete entry
- 7 Reject or confirm entry

Using the operating elements in the editing view





Operating key(s)	Meaning
	Minus key Move the entry position to the left.
	Plus key Move the entry position to the right.

Operating key(s)	Meaning
	Enter key <ul style="list-style-type: none"> Press the key briefly: confirm your selection. Press the key for 2 s: confirm the entry.
	Escape key combination (press keys simultaneously) Close the editing view without accepting the changes.





Input screens

Symbol	Meaning
A..	Upper case
a..	Lower case
1..	Numbers
	Punctuation marks and special characters: = + - * / ² ³ ¹ / ₄ ¹ / ₂ ³ / ₄ () [] < > { }
	Punctuation marks and special characters: " ^ . , ; : ? ! % μ ° € \$ £ ¥ \$ @ # / \ ~ & _
ä..	Umlauts and accents

Controlling data entries

Symbol	Meaning
	Move entry position
	Reject entry
	Confirm entry
	Delete character immediately to the left of the entry position
del	Delete character immediately to the right of the entry position
C	Clear all the characters entered

8.3.4 Operating elements

Operating key(s)	Meaning
	<p>Minus key</p> <p><i>In a menu, submenu</i> Moves the selection bar upwards in a picklist.</p> <p><i>With a Wizard</i> Confirms the parameter value and goes to the previous parameter.</p> <p><i>With a text and numeric editor</i> Move the entry position to the left.</p>
	<p>Plus key</p> <p><i>In a menu, submenu</i> Moves the selection bar downwards in a picklist.</p> <p><i>With a Wizard</i> Confirms the parameter value and goes to the next parameter.</p> <p><i>With a text and numeric editor</i> Move the entry position to the right.</p>
	<p>Enter key</p> <p><i>For operational display</i> Pressing the key briefly opens the operating menu.</p> <p><i>In a menu, submenu</i></p> <ul style="list-style-type: none"> ▪ Pressing the key briefly: <ul style="list-style-type: none"> ▪ Opens the selected menu, submenu or parameter. ▪ Starts the wizard. ▪ If help text is open, closes the help text of the parameter. ▪ Pressing the key for 2 s for parameter: <ul style="list-style-type: none"> ▪ If present, opens the help text for the function of the parameter. <p><i>With a Wizard</i> Opens the editing view of the parameter.</p> <p><i>With a text and numeric editor</i></p> <ul style="list-style-type: none"> ▪ Press the key briefly: confirm your selection. ▪ Press the key for 2 s: confirm the entry.
	<p>Escape key combination (press keys simultaneously)</p> <p><i>In a menu, submenu</i></p> <ul style="list-style-type: none"> ▪ Pressing the key briefly: <ul style="list-style-type: none"> ▪ Exits the current menu level and takes you to the next higher level. ▪ If help text is open, closes the help text of the parameter. ▪ Pressing the key for 2 s returns you to the operational display ("home position"). <p><i>With a Wizard</i> Exits the wizard and takes you to the next higher level.</p> <p><i>With a text and numeric editor</i> Close the editing view without accepting the changes.</p>
	<p>Minus/Enter key combination (press the keys simultaneously)</p> <ul style="list-style-type: none"> ▪ If the keypad lock is active: Press the key for 3 s: deactivate the keypad lock. ▪ If the keypad lock is not active: Press the key for 3 s: the context menu opens along with the option for activating the keypad lock.



8.3.5 Opening the context menu

Using the context menu, the user can call up the following menus quickly and directly from the operational display:



- Setup
- Data backup
- Simulation

Calling up and closing the context menu

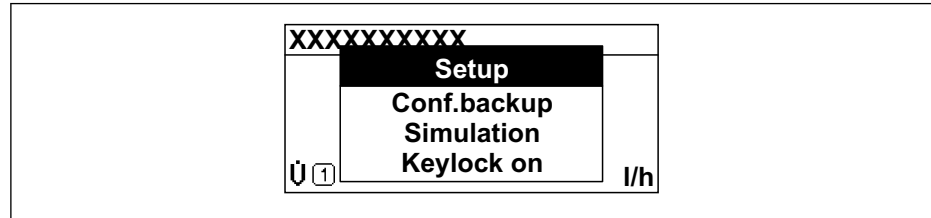

The user is in the operational display.

1. Press the  and  keys for longer than 3 seconds.
↳ The context menu opens.



2. Press  +  simultaneously.
↳ The context menu is closed and the operational display appears.

Calling up the menu via the context menu

1. Open the context menu.
2. Press  to navigate to the desired menu.
3. Press  to confirm the selection.
↳ The selected menu opens.

8.3.6 Navigating and selecting from list

Different operating elements are used to navigate through the operating menu. The navigation path is displayed on the left in the header. Icons are displayed in front of the individual menus. These icons are also shown in the header during navigation.

i For an explanation of the navigation view with symbols and operating elements → 49

Example: Setting the number of displayed measured values to "2 values"

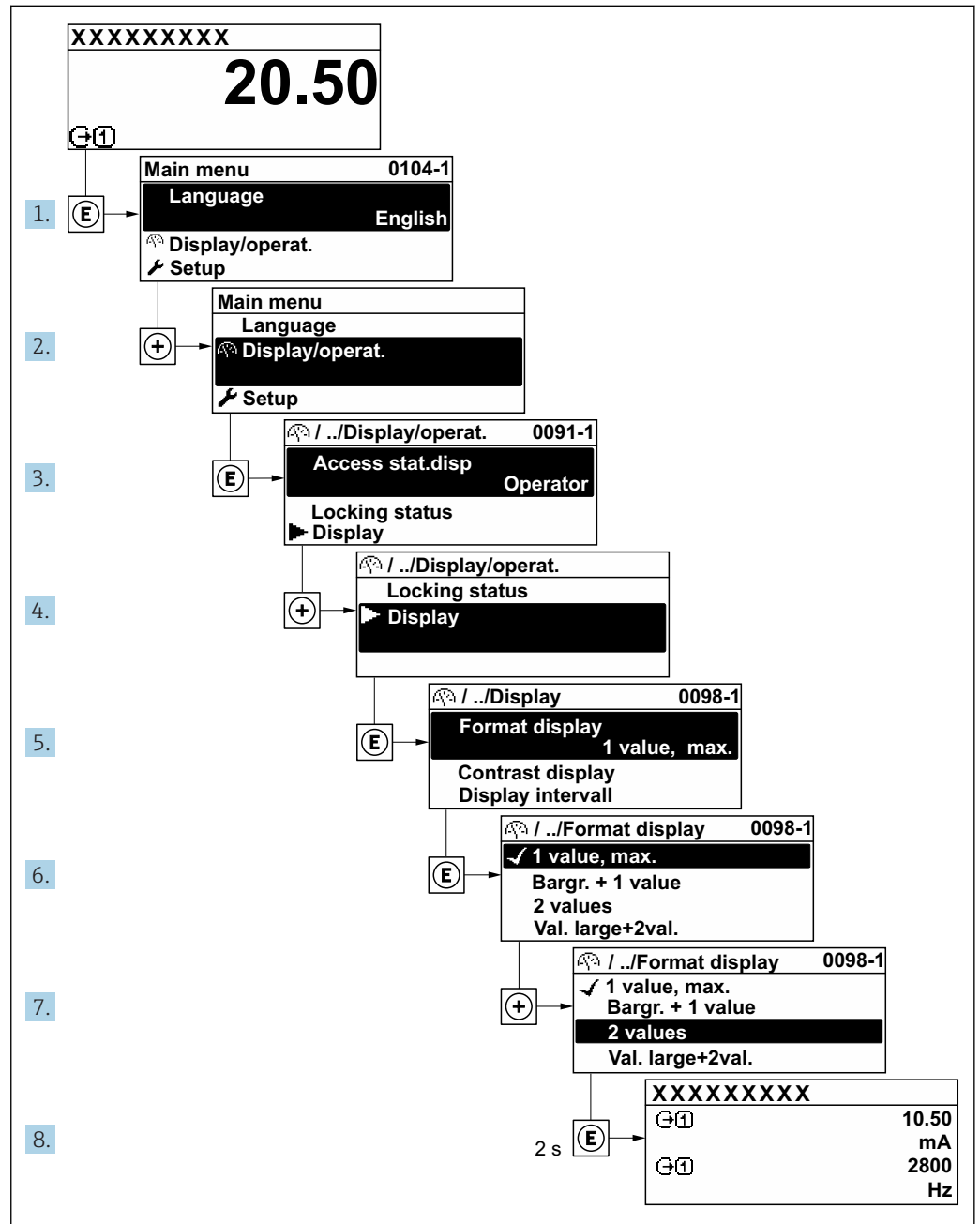

A0029562-EN

8.3.7 Calling the parameter directly

A parameter number is assigned to every parameter to be able to access a parameter directly via the onsite display. Entering this access code in the **Direct access** parameter calls up the desired parameter directly.

Navigation path

Expert → Direct access

The direct access code consists of a 5-digit number (at maximum) and the channel number, which identifies the channel of a process variable: e.g. 00914-2. In the navigation view, this appears on the right-hand side in the header of the selected parameter.

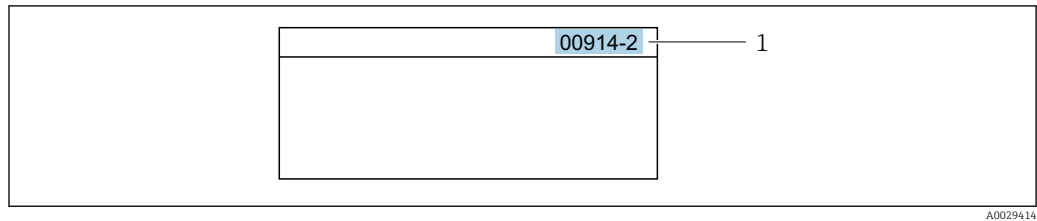

1 Direct access code

Note the following when entering the direct access code:

- The leading zeros in the direct access code do not have to be entered.
Example: Enter "914" instead of "00914"
- If no channel number is entered, channel 1 is accessed automatically.
Example: Enter 00914 → **Assign process variable** parameter
- If a different channel is accessed: Enter the direct access code with the corresponding channel number.
Example: Enter 00914-2 → **Assign process variable** parameter



For the direct access codes of the individual parameters, see the "Description of Device Parameters" document for the device

8.3.8 Calling up help text

Help text is available for some parameters and can be called up from the navigation view. The help text provides a brief explanation of the parameter function and thereby supports swift and safe commissioning.

Calling up and closing the help text

The user is in the navigation view and the selection bar is on a parameter.

1. Press **Enter** for 2 s.
↳ The help text for the selected parameter opens.

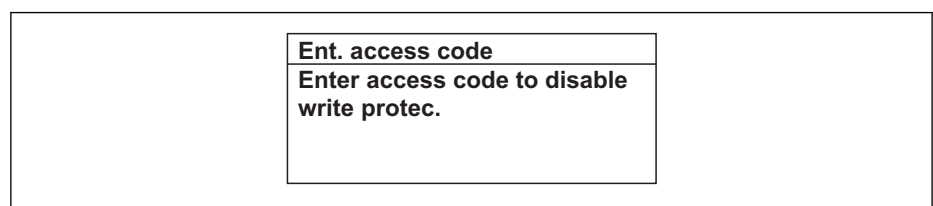

21 Example: Help text for parameter "Enter access code"

2. Press **Enter** + **Esc** simultaneously.
↳ The help text is closed.

8.3.9 Changing the parameters

Parameters can be changed via the numeric editor or text editor.

- Numeric editor: Change values in a parameter, e.g. specifications for limit values.
- Text editor: Enter text in a parameter, e.g. tag name.

A message is displayed if the value entered is outside the permitted value range.

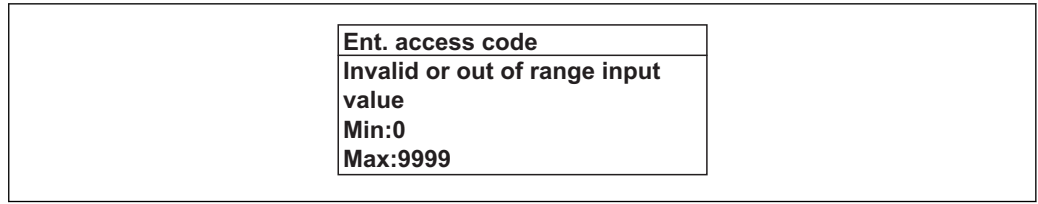

A0014049-EN

For a description of the editing view - consisting of the text editor and numeric editor - with symbols → 51, for a description of the operating elements → 53

8.3.10 User roles and related access authorization

The two user roles "Operator" and "Maintenance" have different write access to the parameters if the customer defines a user-specific access code. This protects the device configuration via the local display from unauthorized access → 118.

Defining access authorization for user roles

An access code is not yet defined when the device is delivered from the factory. Access authorization (read and write access) to the device is not restricted and corresponds to the "Maintenance" user role.

- ▶ Define the access code.
 - ↳ The "Operator" user role is redefined in addition to the "Maintenance" user role. Access authorization differs for the two user roles.

Access authorization to parameters: "Maintenance" user role

Access code status	Read access	Write access
An access code has not yet been defined (factory setting).	✓	✓
After an access code has been defined.	✓	✓ ¹⁾

1) The user only has write access after entering the access code.

Access authorization to parameters: "Operator" user role

Access code status	Read access	Write access
After an access code has been defined.	✓	-- ¹⁾

1) Despite the defined access code, certain parameters can always be modified and thus are exempted from the write protection, as they do not affect the measurement. Refer to the "Write protection via access code" section

The user role with which the user is currently logged on is indicated by the **Access status** parameter. Navigation path: Operation → Access status

8.3.11 Disabling write protection via access code

If the -symbol appears on the local display in front of a parameter, the parameter is write-protected by a user-specific access code and its value cannot be changed at the moment using local operation → 118.

Parameter write protection via local operation can be disabled by entering the user-specific access code in the **Enter access code** parameter (→ 102) via the respective access option.

1. After you press , the input prompt for the access code appears.

2. Enter the access code.
 - ↳ The -symbol in front of the parameters disappears; all previously write-protected parameters are now re-enabled.

8.3.12 Enabling and disabling the keypad lock



The keypad lock makes it possible to block access to the entire operating menu via local operation. As a result, it is no longer possible to navigate through the operating menu or change the values of individual parameters. Users can only read the measured values on the operational display.

The keypad lock is switched on and off via the context menu.

Switching on the keypad lock



-  The keypad lock is switched on automatically:
- If the device has not been operated via the display for > 1 minute.
 - Each time the device is restarted.

To activate the keylock manually:

1. The device is in the measured value display.
Press the  and  keys for 3 seconds.
 - ↳ A context menu appears.
2. In the context menu select the **Keylock on** option.
 - ↳ The keypad lock is switched on.

-  If the user attempts to access the operating menu while the keypad lock is active, the **Keylock on** message appears.

Switching off the keypad lock

- ▶ The keypad lock is switched on.
Press the  and  keys for 3 seconds.
 - ↳ The keypad lock is switched off.

8.4 Access to the operating menu via the Web browser

8.4.1 Function range

Thanks to the integrated Web server, the device can be operated and configured via a Web browser and via a service interface (CDI-RJ45) or via a WLAN interface. The structure of the operating menu is the same as for the local display. In addition to the measured values, status information on the device is also displayed and allows the user to monitor the status of the device. Furthermore the device data can be managed and the network parameters can be configured.

A device that has a WLAN interface (can be ordered as an option) is required for the WLAN connection: order code for "Display; operation", option G "4-line, illuminated; touch control + WLAN". The device acts as an Access Point and enables communication by computer or a mobile handheld terminal.

-  For additional information on the Web server, refer to the Special Documentation for the device

8.4.2 Prerequisites



Computer hardware

Hardware	Interface	
	CDI-RJ45	WLAN
Interface	The computer must have an RJ45 interface.	The operating unit must have a WLAN interface.
Connection	Standard Ethernet cable with RJ45 connector.	Connection via Wireless LAN.
Screen	Recommended size: ≥ 12" (depends on the screen resolution)	

Computer software



Software	Interface	
	CDI-RJ45	WLAN
Recommended operating systems	<ul style="list-style-type: none"> ▪ Microsoft Windows 7 or higher. ▪ Mobile operating systems: <ul style="list-style-type: none"> ▪ iOS ▪ Android <p> Microsoft Windows XP is supported.</p>	
Web browsers supported	<ul style="list-style-type: none"> ▪ Microsoft Internet Explorer 8 or higher ▪ Microsoft Edge ▪ Mozilla Firefox ▪ Google Chrome ▪ Safari 	

Computer settings



Settings	Interface	
	CDI-RJ45	WLAN
User rights	Appropriate user rights (e.g. administrator rights) for TCP/IP and proxy server settings are necessary (for adjusting the IP address, subnet mask etc.).	
Proxy server settings of the Web browser	The Web browser setting <i>Use a Proxy Server for Your LAN</i> must be deselected .	
JavaScript	JavaScript must be enabled. <p> If JavaScript cannot be enabled: enter <code>http://192.168.1.212/basic.html</code> in the address line of the Web browser. A fully functional but simplified version of the operating menu structure starts in the Web browser.</p> <p> When installing a new firmware version: To enable correct data display, clear the temporary memory (cache) of the Web browser under Internet options.</p>	
Network connections	Only the active network connections to the measuring device should be used.	
	Switch off all other network connections such as WLAN.	Switch off all other network connections.

 In the event of connection problems: →  135

Measuring device: Via CDI-RJ45 service interface

Device	CDI-RJ45 service interface
Measuring device	The measuring device has an RJ45 interface.
Web server	Web server must be enabled; factory setting: ON  For information on enabling the Web server →  64

Measuring device: via WLAN interface

Device	WLAN interface
Measuring device	The measuring device has a WLAN antenna: <ul style="list-style-type: none"> ▪ Transmitter with integrated WLAN antenna ▪ Transmitter with external WLAN antenna
Web server	Web server and WLAN must be enabled; factory setting: ON  For information on enabling the Web server →  64

8.4.3 Establishing a connection

Via service interface (CDI-RJ45)

Preparing the measuring device

1. Depending on the housing version:
Release the securing clamp or securing screw of the housing cover.
2. Depending on the housing version:
Unscrew or open the housing cover.
3. The location of the connection socket depends on the measuring device and the communication protocol:
Connect the computer to the RJ45 connector via the standard Ethernet connecting cable .

Configuring the Internet protocol of the computer

The following information refers to the default Ethernet settings of the device.

IP address of the device: 192.168.1.212 (factory setting)

1. Switch on the measuring device.
2. Connect to the computer using a cable →  65.
3. If a 2nd network card is not used, close all the applications on the notebook.
 - ↳ Applications requiring Internet or a network, such as e-mail, SAP applications, Internet or Windows Explorer.
4. Close any open Internet browsers.
5. Configure the properties of the Internet protocol (TCP/IP) as defined in the table:

IP address	192.168.1.XXX; for XXX all numerical sequences except: 0, 212 and 255 → e.g. 192.168.1.213
Subnet mask	255.255.255.0
Default gateway	192.168.1.212 or leave cells empty

Via WLAN interface

Configuring the Internet protocol of the mobile terminal

NOTICE

If the WLAN connection is lost during the configuration, settings made may be lost.

- ▶ Make sure that the WLAN connection is not disconnected while configuring the device.

NOTICE

In principle, avoid simultaneous access to the measuring device via the service interface (CDI-RJ45) and the WLAN interface from the same mobile terminal. This could cause a network conflict.

- ▶ Only activate one service interface (CDI-RJ45 service interface or WLAN interface).
- ▶ If simultaneous communication is necessary: configure different IP address ranges, e.g. 192.168.0.1 (WLAN interface) and 192.168.1.212 (CDI-RJ45 service interface).

Preparing the mobile terminal

- ▶ Enable WLAN reception on the mobile terminal.

Establishing a connection from the mobile terminal to the measuring device

1. In the WLAN settings of the mobile terminal:
Select the measuring device using the SSID (e.g. EH_Prosonic Flow_300_A802000).
2. If necessary, select the WPA2 encryption method.
3. Enter the password: serial number of the measuring device ex-works (e.g. L100A802000).
 - ↳ LED on display module flashes: it is now possible to operate the measuring device with the Web browser, FieldCare or DeviceCare.

 The serial number can be found on the nameplate.

 To ensure the safe and swift assignment of the WLAN network to the measuring point, it is advisable to change the SSID name. It should be possible to clearly assign the new SSID name to the measuring point (e.g. tag name) because it is displayed as the WLAN network.

Disconnecting

- ▶ After configuring the device:
Terminate the WLAN connection between the operating unit and measuring device.

Starting the Web browser

1. Start the Web browser on the computer.

2. Enter the IP address of the Web server in the address line of the Web browser:
192.168.1.212
↳ The login page appears.

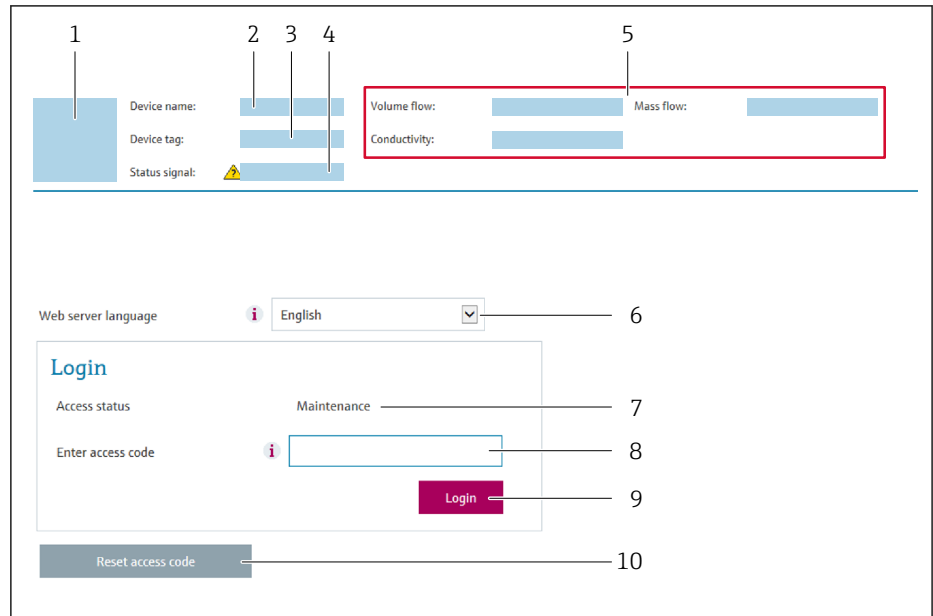

A0029417

- 1 Picture of device
- 2 Device name
- 3 Device tag
- 4 Status signal
- 5 Current measured values
- 6 Operating language
- 7 User role
- 8 Access code
- 9 Login
- 10 Reset access code (→ 115)

i If a login page does not appear, or if the page is incomplete → 135

8.4.4 Logging on

1. Select the preferred operating language for the Web browser.
2. Enter the user-specific access code.
3. Press **OK** to confirm your entry.

Access code	0000 (factory setting); can be changed by customer
-------------	--

i If no action is performed for 10 minutes, the Web browser automatically returns to the login page.

8.4.5 User interface

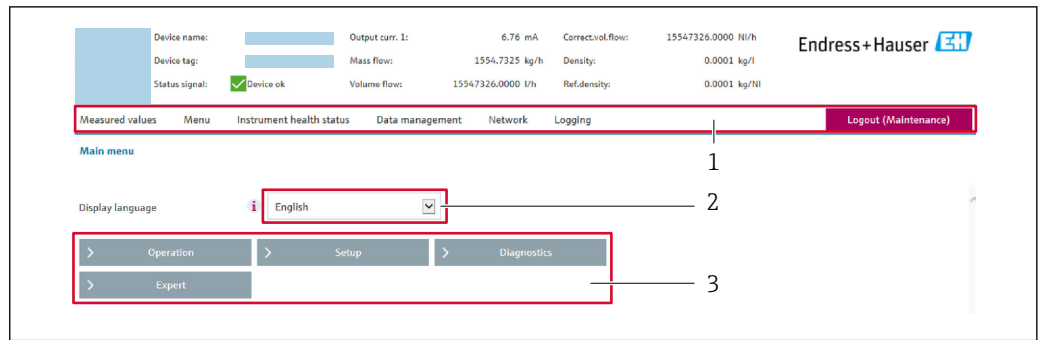

A0029418

- 1 Function row
- 2 Local display language
- 3 Navigation area

Header

The following information appears in the header:

- Device name
- Device tag
- Device status with status signal → 📄 141
- Current measured values

Function row

Functions	Meaning
Measured values	Displays the measured values of the measuring device
Menu	<ul style="list-style-type: none"> ■ Access to the operating menu from the measuring device ■ The structure of the operating menu is the same as for the local display  For detailed information on the structure of the operating menu, see the Operating Instructions for the measuring device
Device status	Displays the diagnostic messages currently pending, listed in order of priority
Data management	Data exchange between PC and measuring device: <ul style="list-style-type: none"> ■ Device configuration: <ul style="list-style-type: none"> ■ Load settings from the device (XML format, save configuration) ■ Save settings to the device (XML format, restore configuration) ■ Logbook - Export Event logbook (.csv file) ■ Documents - Export documents: <ul style="list-style-type: none"> ■ Export backup data record (.csv file, create documentation of the measuring point configuration) ■ Verification report (PDF file, only available with the "Heartbeat Verification" application package) ■ Firmware update - Flashing a firmware version
Network configuration	Configuration and checking of all the parameters required for establishing the connection to the measuring device: <ul style="list-style-type: none"> ■ Network settings (e.g. IP address, MAC address) ■ Device information (e.g. serial number, firmware version)
Logout	End the operation and call up the login page

Navigation area

If a function is selected in the function bar, the submenus of the function open in the navigation area. The user can now navigate through the menu structure.

Working area

Depending on the selected function and the related submenus, various actions can be performed in this area:

- Configuring parameters
- Reading measured values
- Calling up help text
- Starting an upload/download

8.4.6 Disabling the Web server

The Web server of the measuring device can be switched on and off as required using the **Web server functionality** parameter.

Navigation

"Expert" menu → Communication → Web server

Parameter overview with brief description

Parameter	Description	Selection	Factory setting
Web server functionality	Switch the Web server on and off.	<ul style="list-style-type: none"> ▪ Off ▪ HTML Off ▪ On 	On

Function scope of the "Web server functionality" parameter

Option	Description
Off	<ul style="list-style-type: none"> ▪ The web server is completely disabled. ▪ Port 80 is locked.
On	<ul style="list-style-type: none"> ▪ The complete functionality of the web server is available. ▪ JavaScript is used. ▪ The password is transferred in an encrypted state. ▪ Any change to the password is also transferred in an encrypted state.

Enabling the Web server

If the Web server is disabled it can only be re-enabled with the **Web server functionality** parameter via the following operating options:

- Via local display
- Via Bedientool "FieldCare"
- Via "DeviceCare" operating tool

8.4.7 Logging out

 Before logging out, perform a data backup via the **Data management** function (upload configuration from device) if necessary.

1. Select the **Logout** entry in the function row.
↳ The home page with the Login box appears.
2. Close the Web browser.
3. If no longer needed:
Reset modified properties of the Internet protocol (TCP/IP) →  60.

8.5 Access to the operating menu via the operating tool

The structure of the operating menu in the operating tools is the same as for operation via the local display.

8.5.1 Connecting the operating tool

Via Modbus RS485 protocol

This communication interface is available in device versions with a Modbus-RS485 output.

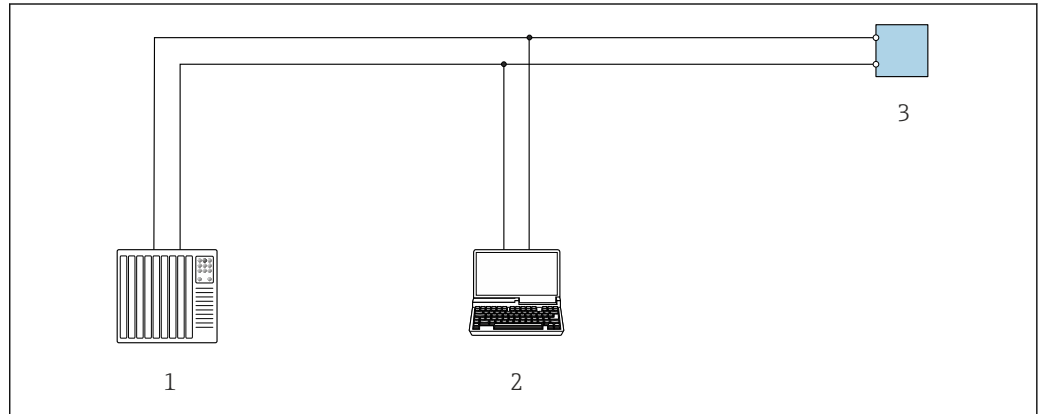

22 Options for remote operation via Modbus-RS485 protocol (active)

- 1 Control system (e.g. PLC)
- 2 Computer with Web browser (e.g. Internet Explorer) for accessing the integrated device Web server or with operating tool (e.g. FieldCare, DeviceCare) with COM DTM "CDI Communication TCP/IP" or Modbus DTM
- 3 Transmitter

Service interface

Via service interface (CDI-RJ45)

A point-to-point connection can be established to configure the device onsite. With the housing open, the connection is established directly via the service interface (CDI-RJ45) of the device.

i An adapter for RJ45 and the M12 connector is optionally available:
Order code for "Accessories", option **NB**: "Adapter RJ45 M12 (service interface)"

The adapter connects the service interface (CDI-RJ45) to an M12 connector mounted in the cable entry. Therefore the connection to the service interface can be established via an M12 connector without opening the device.

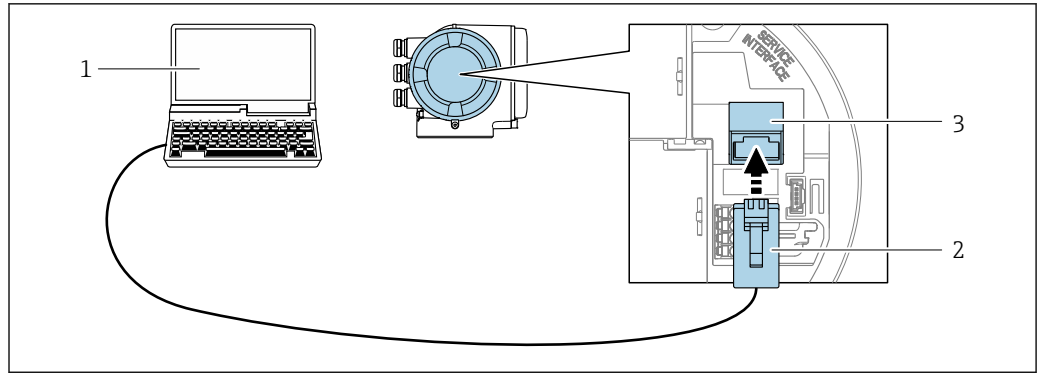

A0027563

23 Connection via service interface (CDI-RJ45)

- 1 Computer with Web browser (e.g. Microsoft Internet Explorer, Microsoft Edge) for accessing the integrated device Web server or with "FieldCare", "DeviceCare" operating tool with COM DTM "CDI Communication TCP/IP" or Modbus DTM
- 2 Standard Ethernet connecting cable with RJ45 connector
- 3 Service interface (CDI-RJ45) of the measuring device with access to the integrated Web server

Via WLAN interface

The optional WLAN interface is available on the following device version:

Order code for "Display; operation", option G "4-line, illuminated; touch control + WLAN"

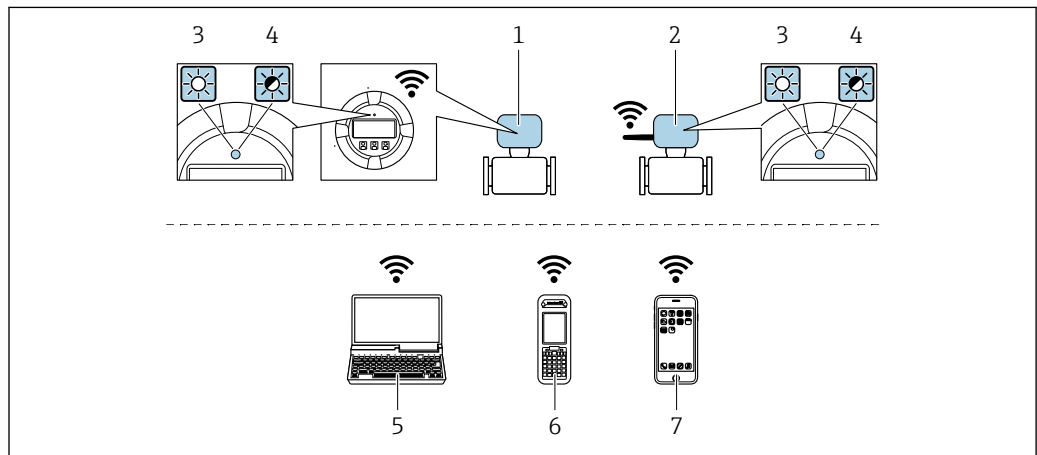

A0034570

- 1 Transmitter with integrated WLAN antenna
- 2 Transmitter with external WLAN antenna
- 3 LED lit constantly: WLAN reception is enabled on measuring device
- 4 LED flashing: WLAN connection established between operating unit and measuring device
- 5 Computer with WLAN interface and Web browser (e.g. Microsoft Internet Explorer, Microsoft Edge) for accessing the integrated device Web server or with operating tool (e.g. FieldCare, DeviceCare)
- 6 Mobile handheld terminal with WLAN interface and Web browser (e.g. Microsoft Internet Explorer, Microsoft Edge) for accessing the integrated device Web server or operating tool (e.g. FieldCare, DeviceCare)
- 7 Smart phone or tablet (e.g. Field Xpert SMT70)

Function	WLAN: IEEE 802.11 b/g (2.4 GHz)
Encryption	WPA2-PSK AES-128 (in accordance with IEEE 802.11i)
Configurable WLAN channels	1 to 11
Degree of protection	IP67
Available antennas	<ul style="list-style-type: none"> ▪ Internal antenna ▪ External antenna (optional) In the event of poor transmission/reception conditions at the place of installation. ⓘ Only one antenna active in each case!

Range	<ul style="list-style-type: none"> ▪ Internal antenna: typically 10 m (32 ft) ▪ External antenna: typically 50 m (164 ft)
Materials (external antenna)	<ul style="list-style-type: none"> ▪ Antenna: ASA plastic (acrylic ester-styrene-acrylonitrile) and nickel-plated brass ▪ Adapter: Stainless steel and nickel-plated brass ▪ Cable: Polyethylene ▪ Connector: Nickel-plated brass ▪ Angle bracket: Stainless steel

Configuring the Internet protocol of the mobile terminal

NOTICE

If the WLAN connection is lost during the configuration, settings made may be lost.

- ▶ Make sure that the WLAN connection is not disconnected while configuring the device.

NOTICE

In principle, avoid simultaneous access to the measuring device via the service interface (CDI-RJ45) and the WLAN interface from the same mobile terminal. This could cause a network conflict.

- ▶ Only activate one service interface (CDI-RJ45 service interface or WLAN interface).
- ▶ If simultaneous communication is necessary: configure different IP address ranges, e.g. 192.168.0.1 (WLAN interface) and 192.168.1.212 (CDI-RJ45 service interface).

Preparing the mobile terminal

- ▶ Enable WLAN reception on the mobile terminal.

Establishing a connection from the mobile terminal to the measuring device

1. In the WLAN settings of the mobile terminal:
Select the measuring device using the SSID (e.g. EH_Prosonic Flow_300_A802000).
2. If necessary, select the WPA2 encryption method.
3. Enter the password: serial number of the measuring device ex-works (e.g. L100A802000).
↳ LED on display module flashes: it is now possible to operate the measuring device with the Web browser, FieldCare or DeviceCare.

 The serial number can be found on the nameplate.

 To ensure the safe and swift assignment of the WLAN network to the measuring point, it is advisable to change the SSID name. It should be possible to clearly assign the new SSID name to the measuring point (e.g. tag name) because it is displayed as the WLAN network.

Disconnecting



- ▶ After configuring the device:
Terminate the WLAN connection between the operating unit and measuring device.

8.5.2 FieldCare

Function scope

FDT-based plant asset management tool from Endress+Hauser. It can configure all smart field devices in a system and helps you manage them. By using the status information, it is also a simple but effective way of checking their status and condition.

Access is via:

- CDI-RJ45 service interface →  65
- WLAN interface →  66

Typical functions:

- Configuring parameters of transmitters
- Loading and saving device data (upload/download)
- Documentation of the measuring point
- Visualization of the measured value memory (line recorder) and event logbook

 For additional information about FieldCare, see Operating Instructions BA00027S and BA00059S

Source for device description files

See information →  70

Establishing a connection

 For additional information, see Operating Instructions BA00027S and BA00059S

User interface

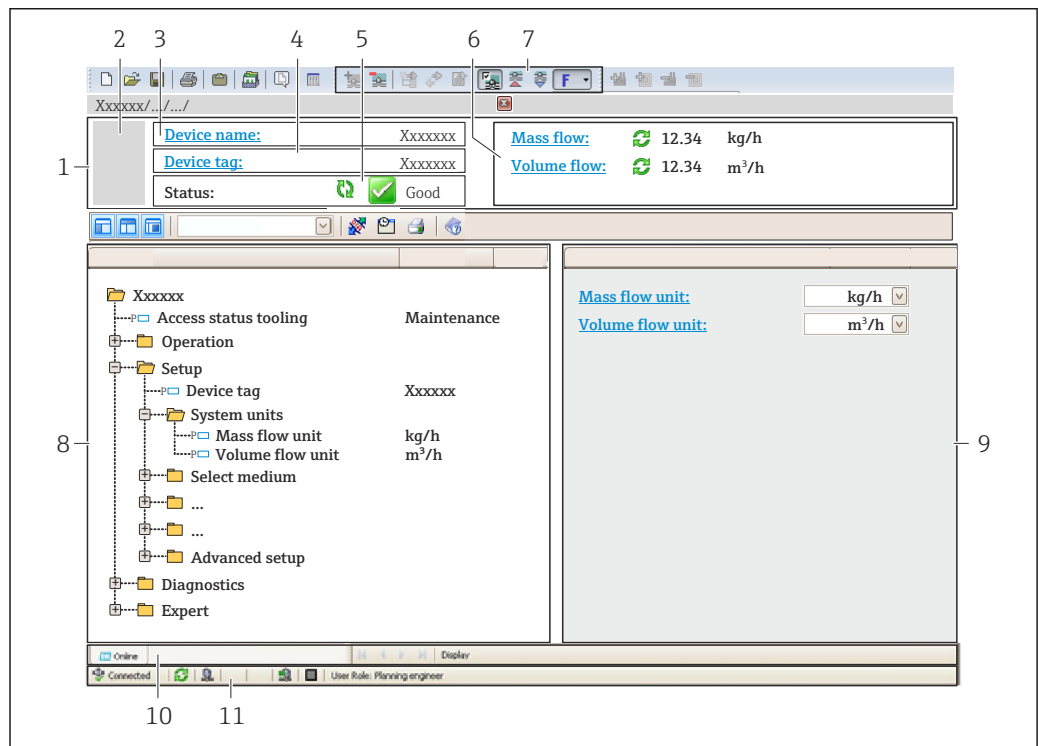

A0021051-EN

- 1 Header
- 2 Picture of device
- 3 Device name
- 4 Device tag
- 5 Status area with status signal →  141
- 6 Display area for current measured values
- 7 Edit toolbar with additional functions such as save/restore, event list and create documentation
- 8 Navigation area with operating menu structure
- 9 Working area
- 10 Range of action
- 11 Status area

8.5.3 DeviceCare

Function scope

Tool to connect and configure Endress+Hauser field devices.

The fastest way to configure Endress+Hauser field devices is with the dedicated "DeviceCare" tool. Together with the device type managers (DTMs) it presents a convenient, comprehensive solution.



For details, see Innovation Brochure IN01047S

Source for device description files



See information →  70

9 System integration

9.1 Overview of device description files

9.1.1 Current version data for the device

Firmware version	01.00.zz	<ul style="list-style-type: none"> ▪ On the title page of the Operating Instructions ▪ On the transmitter nameplate ▪ Firmware version Diagnostics → Device information → Firmware version
Release date of firmware version	08.2019	---

 For an overview of the different firmware versions for the device →  154

9.1.2 Operating tools

The suitable device description file for the individual operating tools is listed in the table below, along with information on where the file can be acquired.

Operating tool via service interface (CDI) or Modbus interface	Sources for obtaining device descriptions
FieldCare	<ul style="list-style-type: none"> ▪ www.endress.com → Download Area ▪ CD-ROM (contact Endress+Hauser) ▪ DVD (contact Endress+Hauser)
DeviceCare	<ul style="list-style-type: none"> ▪ www.endress.com → Download Area ▪ CD-ROM (contact Endress+Hauser) ▪ DVD (contact Endress+Hauser)

9.2 Compatibility with earlier model



If the device is replaced, the measuring device Prosonic Flow 300 supports the compatibility of the Modbus registers for the process variables and the diagnostic information with the previous model Prosonic Flow 93. It is not necessary to change the engineering parameters in the automation system.

Compatible Modbus registers: process variables

Process variable	Compatible Modbus registers
Mass flow	2007
Volume flow	2009
Totalizer 1	2610
Totalizer 2	2810
Totalizer 3	3010

Compatible Modbus registers: diagnostic information



Diagnostic information	Compatible Modbus registers
Diagnostic code (data type: String), e.g. F270	6821
Diagnostic number (data type: Integer), e.g. 270	6859



 The Modbus registers are compatible but the diagnostic numbers are not. Overview of the new diagnostic numbers →  144.

9.3 Modbus RS485 information

9.3.1 Function codes

Function codes are used to define which read or write action is carried out via the Modbus protocol. The measuring device supports the following function codes:

Code	Name	Description	Application
03	Read holding register	<p>Master reads one or more Modbus registers from the device. A maximum of 125 consecutive registers can be read with 1 telegram: 1 register = 2 bytes</p> <p> The measuring device does not make a distinction between function codes 03 and 04; these codes therefore yield the same result.</p>	<p>Read device parameters with read and write access</p> <p>Example: Read volume flow</p>
04	Read input register	<p>Master reads one or more Modbus registers from the device. A maximum of 125 consecutive registers can be read with 1 telegram: 1 register = 2 bytes</p> <p> The measuring device does not make a distinction between function codes 03 and 04; these codes therefore yield the same result.</p>	<p>Read device parameters with read access</p> <p>Example: Read totalizer value</p>
06	Write single registers	<p>Master writes a new value to one Modbus register of the measuring device.</p> <p> Use function code 16 to write multiple registers with just 1 telegram.</p>	<p>Write only 1 device parameter</p> <p>Example: reset totalizer</p>
08	Diagnostics	<p>Master checks the communication connection to the measuring device. The following "Diagnostics codes" are supported:</p> <ul style="list-style-type: none"> ▪ Sub-function 00 = Return query data (loopback test) ▪ Sub-function 02 = Return diagnostics register 	

Code	Name	Description	Application
16	Write multiple registers	<p>Master writes a new value to multiple Modbus registers of the device. A maximum of 120 consecutive registers can be written with 1 telegram.</p> <p> If the required device parameters are not available as a group, yet must nevertheless be addressed with a single telegram, use Modbus data map →  73</p>	Write multiple device parameters
23	Read/Write multiple registers	<p>Master reads and writes a maximum of 118 Modbus registers of the measuring device simultaneously with 1 telegram. Write access is executed before read access.</p>	<p>Write and read multiple device parameters</p> <p>Example:</p> <ul style="list-style-type: none"> ▪ Read mass flow ▪ Reset totalizer

 Broadcast messages are only allowed with function codes 06, 16 and 23.

9.3.2 Register information

 For an overview of device parameters with their respective Modbus register information, please refer to the "Modbus RS485 register information" section in the "Description of device parameters" documentation .

9.3.3 Response time

Response time of the measuring device to the request telegram of the Modbus master: typically 3 to 5 ms

9.3.4 Data types

The measuring device supports the following data types:

FLOAT (floating point number IEEE 754) Data length = 4 bytes (2 registers)			
Byte 3	Byte 2	Byte 1	Byte 0
SEEEEEEE	EMMMMMMM	MMMMMMMM	MMMMMMMM
S = sign, E = exponent, M = mantissa			

INTEGER Data length = 2 bytes (1 register)	
Byte 1	Byte 0
Most significant byte (MSB)	Least significant byte (LSB)

STRING Data length = depends on the device parameter, e.g. presentation of a device parameter with a data length = 18 bytes (9 registers)				
Byte 17	Byte 16	...	Byte 1	Byte 0
Most significant byte (MSB)		...		Least significant byte (LSB)

9.3.5 Byte transmission sequence

Byte addressing, i.e. the transmission sequence of the bytes, is not specified in the Modbus specification. For this reason, it is important to coordinate or match the addressing method between the master and slave during commissioning. This can be configured in the measuring device using the **Byte order** parameter.

The bytes are transmitted depending on the selection in the **Byte order** parameter:

FLOAT				
	Sequence			
Options	1.	2.	3.	4.
1 - 0 - 3 - 2 *	Byte 1 (MMMMMMMM)	Byte 0 (MMMMMMMM)	Byte 3 (SEEEEEEE)	Byte 2 (EMMMMMMM)
0 - 1 - 2 - 3	Byte 0 (MMMMMMMM)	Byte 1 (MMMMMMMM)	Byte 2 (EMMMMMMM)	Byte 3 (SEEEEEEE)
2 - 3 - 0 - 1	Byte 2 (EMMMMMMM)	Byte 3 (SEEEEEEE)	Byte 0 (MMMMMMMM)	Byte 1 (MMMMMMMM)
3 - 2 - 1 - 0	Byte 3 (SEEEEEEE)	Byte 2 (EMMMMMMM)	Byte 1 (MMMMMMMM)	Byte 0 (MMMMMMMM)

* = factory setting, S = sign, E = exponent, M = mantissa

INTEGER		
	Sequence	
Options	1.	2.
1 - 0 - 3 - 2 * 3 - 2 - 1 - 0	Byte 1 (MSB)	Byte 0 (LSB)
0 - 1 - 2 - 3 2 - 3 - 0 - 1	Byte 0 (LSB)	Byte 1 (MSB)

* = factory setting, MSB = most significant byte, LSB = least significant byte

STRING					
Presentation taking the example of a device parameter with a data length of 18 bytes.					
	Sequence				
Options	1.	2.	...	17.	18.
1 - 0 - 3 - 2 * 3 - 2 - 1 - 0	Byte 17 (MSB)	Byte 16	...	Byte 1	Byte 0 (LSB)
0 - 1 - 2 - 3 2 - 3 - 0 - 1	Byte 16	Byte 17 (MSB)	...	Byte 0 (LSB)	Byte 1

* = factory setting, MSB = most significant byte, LSB = least significant byte

9.3.6 Modbus data map

Function of the Modbus data map

The device offers a special memory area, the Modbus data map (for a maximum of 16 device parameters), to allow users to call up multiple device parameters via Modbus RS485 and not only individual device parameters or a group of consecutive device parameters.

Grouping of device parameters is flexible and the Modbus master can read or write to the entire data block simultaneously with a single request telegram.

Structure of the Modbus data map

The Modbus data map consists of two data sets:

- **Scan list: Configuration area**
The device parameters to be grouped are defined in a list in that their Modbus RS485 register addresses are entered in the list.
- **Data area**
The measuring device reads out the register addresses entered in the scan list cyclically and writes the associated device data (values) to the data area.



For an overview of device parameters with their respective Modbus register information, please refer to the "Modbus RS485 register information" section in the "Description of device parameters" documentation .

Scan list configuration

For configuration, the Modbus RS485 register addresses of the device parameters to be grouped must be entered in the scan list. Please note the following basic requirements of the scan list:

Max. entries	16 device parameters
Supported device parameters	Only parameters with the following characteristics are supported: <ul style="list-style-type: none"> ■ Access type: read or write access ■ Data type: float or integer

Configuring the scan list via FieldCare or DeviceCare

Carried out using the operating menu of the measuring device:

Expert → Communication → Modbus data map → Scan list register 0 to 15

Scan list	
No.	Configuration register
0	Scan list register 0
...	...
15	Scan list register 15

Configuring the scan list via Modbus RS485

Carried out using register addresses 5001 - 5016

Scan list			
No.	Modbus RS485 register	Data type	Configuration register
0	5001	Integer	Scan list register 0
...	...	Integer	...
15	5016	Integer	Scan list register 15

Reading out data via Modbus RS485

The Modbus master accesses the data area of the Modbus data map to read out the current values of the device parameters defined in the scan list.

Master access to data area	Via register addresses 5051-5081
-----------------------------------	----------------------------------

Data area				
Device parameter value	Modbus RS485 register		Data type*	Access**
	Start register	End register (Float only)		
Value of scan list register 0	5051	5052	Integer/float	Read/write
Value of scan list register 1	5053	5054	Integer/float	Read/write
Value of scan list register
Value of scan list register 15	5081	5082	Integer/float	Read/write

* Data type depends on the device parameters entered in the scan list.
** Data access depends on the device parameters entered in the scan list. If the device parameter entered supports read and write access, the parameter can also be accessed via the data area.

10 Commissioning

10.1 Function check

Before commissioning the measuring device:

- ▶ Make sure that the post-installation and post-connection checks have been performed.
 - "Post-installation check" checklist → 29
 - "Post-connection check" checklist → 42

10.2 Setting the operating language

Factory setting: English or ordered local language

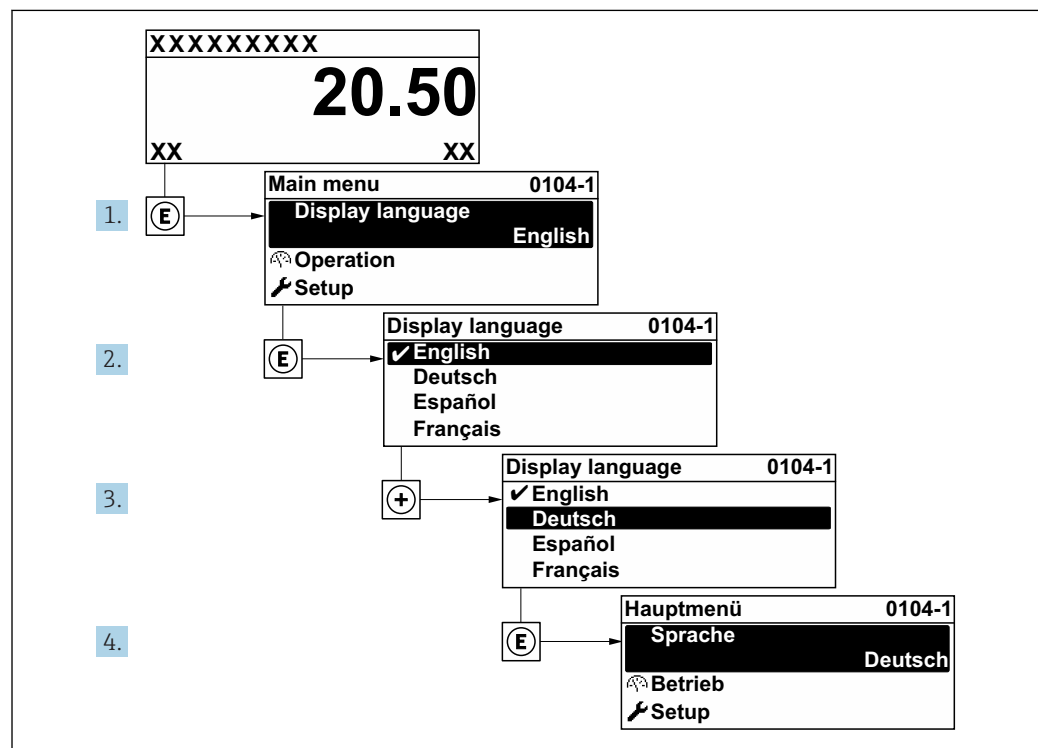

24 Taking the example of the local display

A0029420

10.3 Configuring the measuring device

- The **Setup** menu with its guided wizards contains all the parameters needed for standard operation.
- Navigation to the **Setup** menu

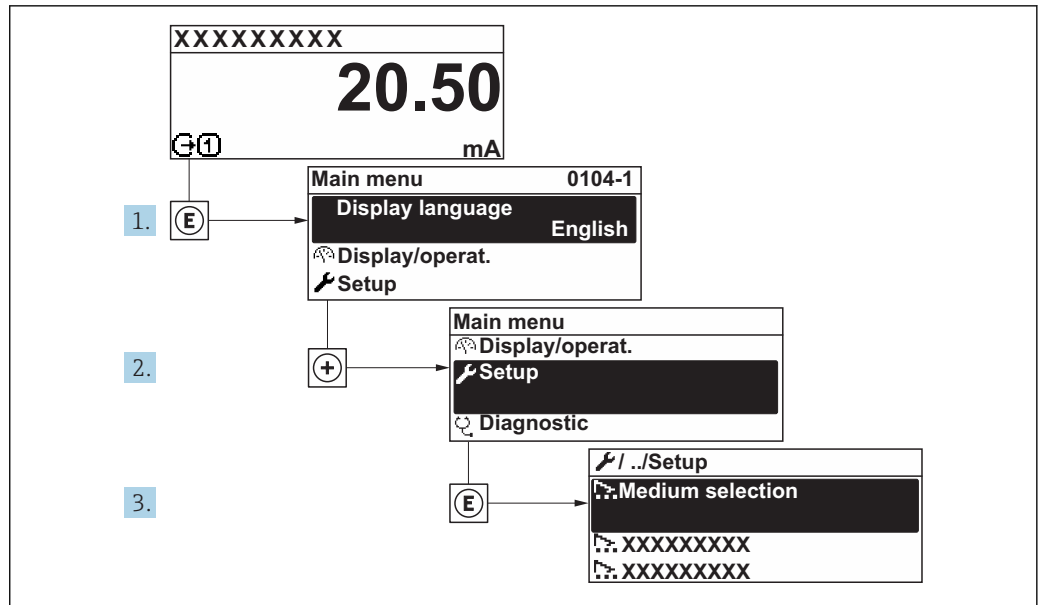

A003222-EN

25 Taking the example of the local display

i The number of submenus and parameters can vary depending on the device version. Certain submenus and parameters in these submenus are not described in the Operation Instructions. Instead a description is provided in the Special Documentation for the device (→ "Supplementary documentation" section).

Navigation
"Setup" menu

🔧 Setup	
Device tag	
▶ System units	→ 78
▶ Communication	→ 80
▶ I/O configuration	→ 81
▶ Current input 1 to n	→ 82
▶ Status input 1 to n	→ 83
▶ Current output 1 to n	→ 84
▶ Pulse/frequency/switch output 1 to n	→ 87
▶ Relay output 1 to n	→ 93
▶ Double pulse output	→ 95

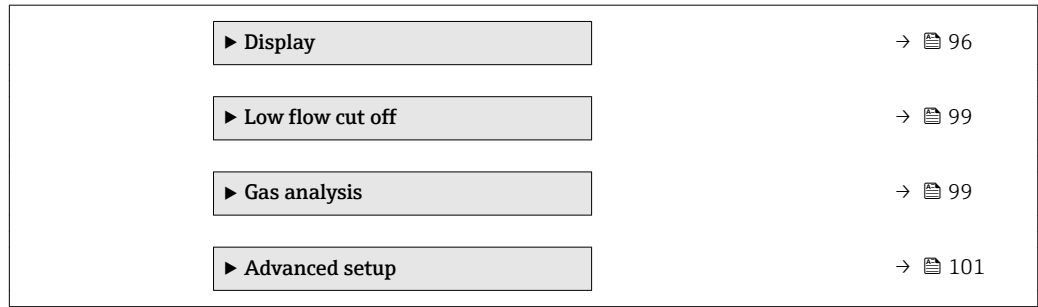

10.3.1 Defining the tag name

To enable fast identification of the measuring point within the system, you can enter a unique designation using the **Device tag** parameter and thus change the factory setting.

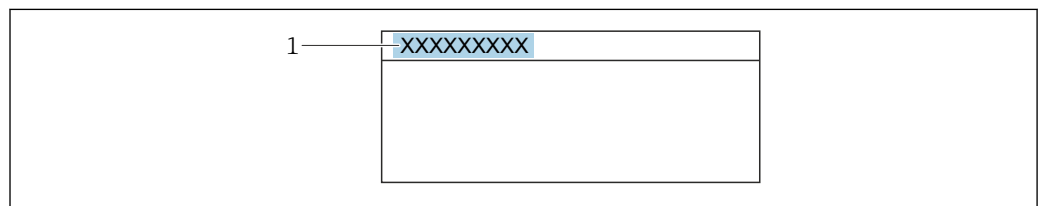

A0029422

26 Header of the operational display with tag name

1 Tag name

i Enter the tag name in the "FieldCare" operating tool → 68

Navigation

"Setup" menu → Device tag

Parameter overview with brief description

Parameter	Description	User entry	Factory setting
Device tag	Enter the name for the measuring point.	Max. 32 characters, such as letters, numbers or special characters (e.g. @, %, /).	Promag









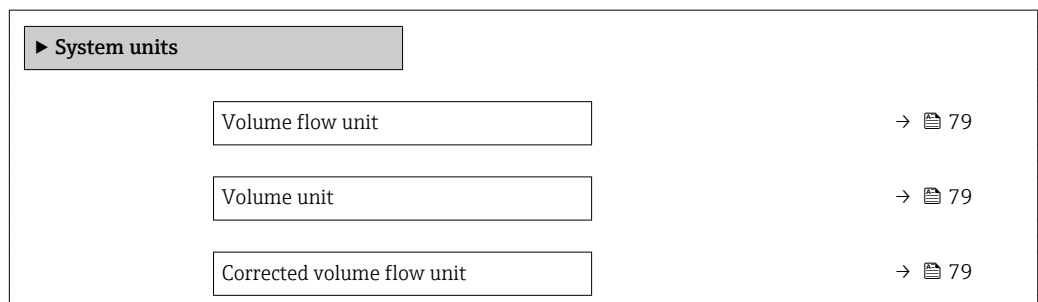

10.3.2 Setting the system units

In the **System units** submenu the units of all the measured values can be set.

Navigation

"Setup" menu → System units



Corrected volume unit	→  79
Mass flow unit	→  79
Mass unit	→  79
Energy flow unit	→  80
Energy unit	→  80
Temperature unit	→  80
Pressure unit	→  80
Density unit	→  80
Length unit	→  80
Velocity unit	→  80
Calorific value unit	→  80

Parameter overview with brief description

Parameter	Description	Selection	Factory setting
Volume flow unit	Select volume flow unit. <i>Result</i> The selected unit applies for: <ul style="list-style-type: none"> ■ Output ■ Low flow cut off ■ Simulation process variable 	Unit choose list	Country-specific: <ul style="list-style-type: none"> ■ m³/h ■ ft³/h
Volume unit	Select volume unit.	Unit choose list	Country-specific: <ul style="list-style-type: none"> ■ m³ ■ ft³
Corrected volume flow unit	Select corrected volume flow unit. <i>Result</i> The selected unit applies for: Corrected volume flow	Unit choose list	Country-specific: <ul style="list-style-type: none"> ■ Nm³/h ■ Sft³/h
Corrected volume unit	Select corrected volume unit.	Unit choose list	Country-specific: <ul style="list-style-type: none"> ■ Nm³ ■ Sft³
Mass flow unit	Select mass flow unit. <i>Result</i> The selected unit applies for: <ul style="list-style-type: none"> ■ Output ■ Low flow cut off ■ Simulation process variable 	Unit choose list	Country-specific: <ul style="list-style-type: none"> ■ kg/h ■ lb/h
Mass unit	Select mass unit.	Unit choose list	Country-specific: <ul style="list-style-type: none"> ■ kg ■ lb

Parameter	Description	Selection	Factory setting
Energy flow unit	Select energy flow unit.	Unit choose list	Country-specific: <ul style="list-style-type: none"> ▪ kW ▪ Btu/h
Energy unit	Select energy unit.	Unit choose list	Country-specific: <ul style="list-style-type: none"> ▪ kWh ▪ Btu
Temperature unit	Select temperature unit. <i>Result</i> The selected unit applies for: <ul style="list-style-type: none"> ▪ Temperature ▪ Maximum value ▪ Minimum value 	Unit choose list	Country-specific: <ul style="list-style-type: none"> ▪ °C ▪ °F
Pressure unit	Select process pressure unit. <i>Result</i> The selected unit applies for: Process pressure parameter (5640)	Unit choose list	Country-specific: <ul style="list-style-type: none"> ▪ bar a ▪ psi a
Density unit	Select density unit. <i>Result</i> The selected unit applies for: <ul style="list-style-type: none"> ▪ Output ▪ Simulation process variable 	Unit choose list	Country-specific: <ul style="list-style-type: none"> ▪ kg/m³ ▪ lb/ft³
Length unit	Select length unit for nominal diameter.	Unit choose list	Country-specific: <ul style="list-style-type: none"> ▪ mm ▪ in
Velocity unit	Select velocity unit. <i>Result</i> The selected unit applies for: <ul style="list-style-type: none"> ▪ Flow velocity ▪ Sound velocity ▪ Maximum value ▪ Minimum value 	Unit choose list	Country-specific: <ul style="list-style-type: none"> ▪ m/s ▪ ft/s
Calorific value unit	Select calorific value unit. <i>Result</i> The selected unit applies for: <ul style="list-style-type: none"> ▪ Calorific value ▪ Wobbe index 	Unit choose list	Country-specific: <ul style="list-style-type: none"> ▪ kWh/Nm³ ▪ Btu/Sft³

10.3.3 Configuring the communication interface

The **Communication** submenu guides you systematically through all the parameters that have to be configured for selecting and setting the communication interface.

Navigation

"Setup" menu → Communication

▶ **Communication**

Bus address	→ ⓘ 81
Baudrate	→ ⓘ 81
Data transfer mode	→ ⓘ 81

Parity	→ 81
Byte order	→ 81
Failure mode	→ 81

Parameter overview with brief description

Parameter	Description	User entry / Selection	Factory setting
Bus address	Enter device address.	1 to 247	247
Baudrate	Define data transfer speed.	<ul style="list-style-type: none"> ■ 1200 BAUD ■ 2400 BAUD ■ 4800 BAUD ■ 9600 BAUD ■ 19200 BAUD ■ 38400 BAUD ■ 57600 BAUD ■ 115200 BAUD 	19200 BAUD
Data transfer mode	Select data transfer mode.	<ul style="list-style-type: none"> ■ ASCII ■ RTU 	RTU
Parity	Select parity bits.	Picklist ASCII option: <ul style="list-style-type: none"> ■ 0 = Even option ■ 1 = Odd option Picklist RTU option: <ul style="list-style-type: none"> ■ 0 = Even option ■ 1 = Odd option ■ 2 = None / 1 stop bit option ■ 3 = None / 2 stop bits option 	Even
Byte order	Select byte transmission sequence.	<ul style="list-style-type: none"> ■ 0-1-2-3 ■ 3-2-1-0 ■ 1-0-3-2 ■ 2-3-0-1 	1-0-3-2
Failure mode	Select measured value output behavior when a diagnostic message occurs via Modbus communication. NaN ¹⁾	<ul style="list-style-type: none"> ■ NaN value ■ Last valid value 	NaN value

1) Not a Number

10.3.4 Displaying the I/O configuration

The **I/O configuration** submenu guides the user systematically through all the parameters in which the configuration of the I/O modules is displayed.

Navigation

"Setup" menu → I/O configuration

► I/O configuration	
I/O module 1 to n terminal numbers	→ 82
I/O module 1 to n information	→ 82

I/O module 1 to n type	→ 82
Apply I/O configuration	→ 82
I/O alteration code	→ 82

Parameter overview with brief description

Parameter	Description	User interface / Selection / User entry	Factory setting
I/O module 1 to n terminal numbers	Shows the terminal numbers used by the I/O module.	<ul style="list-style-type: none"> ▪ Not used ▪ 26-27 (I/O 1) ▪ 24-25 (I/O 2) ▪ 22-23 (I/O 3) 	-
I/O module 1 to n information	Shows information of the plugged I/O module.	<ul style="list-style-type: none"> ▪ Not plugged ▪ Invalid ▪ Not configurable ▪ Configurable ▪ MODBUS 	-
I/O module 1 to n type	Shows the I/O module type.	<ul style="list-style-type: none"> ▪ Off ▪ Current output * ▪ Current input * ▪ Status input * ▪ Pulse/frequency/switch output * ▪ Double pulse output * ▪ Relay output * 	Off
Apply I/O configuration	Apply parameterization of the freely configurable I/O module.	<ul style="list-style-type: none"> ▪ No ▪ Yes 	No
I/O alteration code	Enter the code in order to change the I/O configuration.	Positive integer	0

* Visibility depends on order options or device settings

10.3.5 Configuring the current input

The "Current input" wizard guides the user systematically through all the parameters that have to be set for configuring the current input.

Navigation

"Setup" menu → Current input

▶ Current input 1 to n	
Terminal number	→ 83
Signal mode	→ 83
0/4 mA value	→ 83
20 mA value	→ 83
Current span	→ 83

Failure mode	→ 83
Failure value	→ 83

Parameter overview with brief description

Parameter	Prerequisite	Description	User interface / Selection / User entry	Factory setting
Terminal number	-	Shows the terminal numbers used by the current input module.	<ul style="list-style-type: none"> ▪ Not used ▪ 24-25 (I/O 2) ▪ 22-23 (I/O 3) 	-
Signal mode	The measuring device is not approved for use in the hazardous area with type of protection Ex-i.	Select the signal mode for the current input.	<ul style="list-style-type: none"> ▪ Passive ▪ Active 	Active
0/4 mA value	-	Enter 4 mA value.	Signed floating-point number	0
20 mA value	-	Enter 20 mA value.	Signed floating-point number	Depends on country and nominal diameter
Current span	-	Select current range for process value output and upper/lower level for alarm signal.	<ul style="list-style-type: none"> ▪ 4...20 mA (4...20.5 mA) ▪ 4...20 mA NAMUR (3.8...20.5 mA) ▪ 4...20 mA US (3.9...20.8 mA) ▪ 0...20 mA (0...20.5 mA) 	Country-specific: <ul style="list-style-type: none"> ▪ 4...20 mA NAMUR (3.8...20.5 mA) ▪ 4...20 mA US (3.9...20.8 mA)
Failure mode	-	Define input behavior in alarm condition.	<ul style="list-style-type: none"> ▪ Alarm ▪ Last valid value ▪ Defined value 	Alarm
Failure value	In the Failure mode parameter, the Defined value option is selected.	Enter value to be used by the device if input value from external device is missing.	Signed floating-point number	0

10.3.6 Configuring the status input

The **Status input** submenu guides the user systematically through all the parameters that have to be set for configuring the status input.

Navigation

"Setup" menu → Status input

▶ Status input 1 to n	
Assign status input	→ 84
Terminal number	→ 84
Active level	→ 84
Terminal number	→ 84

Response time status input	→ 84
Terminal number	→ 84

Parameter overview with brief description

Parameter	Description	User interface / Selection / User entry	Factory setting
Terminal number	Shows the terminal numbers used by the status input module.	<ul style="list-style-type: none"> ▪ Not used ▪ 24-25 (I/O 2) ▪ 22-23 (I/O 3) 	–
Assign status input	Select function for the status input.	<ul style="list-style-type: none"> ▪ Off ▪ Reset totalizer 1 ▪ Reset totalizer 2 ▪ Reset totalizer 3 ▪ Reset all totalizers ▪ Flow override 	Off
Active level	Define input signal level at which the assigned function is triggered.	<ul style="list-style-type: none"> ▪ High ▪ Low 	High
Response time status input	Define the minimum amount of time the input signal level must be present before the selected function is triggered.	5 to 200 ms	50 ms



10.3.7 Configuring the current output

The **Current output** wizard guides you systematically through all the parameters that have to be set for configuring the current output.

Navigation

"Setup" menu → Current output

▶ Current output 1 to n	
Terminal number	→ 85
Signal mode	→ 85
Assign current output 1 to n	→ 85
Current span	→ 85
0/4 mA value	→ 85
20 mA value	→ 86
Fixed current	→ 86
Damping output 1 to n	→ 86

Failure mode	→  86
Failure current	→  86

Parameter overview with brief description

Parameter	Prerequisite	Description	User interface / Selection / User entry	Factory setting
Terminal number	–	Shows the terminal numbers used by the current output module.	<ul style="list-style-type: none"> ■ Not used ■ 24-25 (I/O 2) ■ 22-23 (I/O 3) 	–
Signal mode	–	Select the signal mode for the current output.	<ul style="list-style-type: none"> ■ Passive ■ Active 	Active
Assign current output 1 to n	–	Select process variable for current output.	<ul style="list-style-type: none"> ■ Off* ■ Volume flow ■ Corrected volume flow* ■ Mass flow ■ Flow velocity ■ Sound velocity ■ Temperature* ■ Pressure* ■ Methane fraction* ■ Molar mass* ■ Density* ■ Dynamic viscosity* ■ Calorific value* ■ Wobbe index* ■ Energy flow* ■ Signal strength* ■ Signal to noise ratio* ■ Acceptance rate* ■ Turbulence* ■ Flow asymmetry* ■ Electronic temperature 	Volume flow
Current span	–	Select current range for process value output and upper/lower level for alarm signal.	<ul style="list-style-type: none"> ■ 4...20 mA NAMUR (3.8...20.5 mA) ■ 4...20 mA US (3.9...20.8 mA) ■ 4...20 mA (4... 20.5 mA) ■ 0...20 mA (0... 20.5 mA) ■ Fixed current 	Country-specific: <ul style="list-style-type: none"> ■ 4...20 mA NAMUR (3.8...20.5 mA) ■ 4...20 mA US (3.9...20.8 mA)
0/4 mA value	In the Current span parameter (→  85), one of the following options is selected: <ul style="list-style-type: none"> ■ 4...20 mA NAMUR (3.8...20.5 mA) ■ 4...20 mA US (3.9...20.8 mA) ■ 4...20 mA (4... 20.5 mA) ■ 0...20 mA (0... 20.5 mA) 	Enter 4 mA value.	Signed floating-point number	Country-specific: <ul style="list-style-type: none"> ■ m³/h ■ ft³/h

Parameter	Prerequisite	Description	User interface / Selection / User entry	Factory setting
20 mA value	One of the following options is selected in the Current span parameter (→ 85): <ul style="list-style-type: none"> ■ 4...20 mA NAMUR (3.8...20.5 mA) ■ 4...20 mA US (3.9...20.8 mA) ■ 4...20 mA (4... 20.5 mA) ■ 0...20 mA (0... 20.5 mA) 	Enter 20 mA value.	Signed floating-point number	Depends on country and nominal diameter
Fixed current	The Fixed current option is selected in the Current span parameter (→ 85).	Defines the fixed output current.	0 to 22.5 mA	22.5 mA
Damping output 1 to n	A process variable is selected in the Assign current output parameter (→ 85) and one of the following options is selected in the Current span parameter (→ 85): <ul style="list-style-type: none"> ■ 4...20 mA NAMUR (3.8...20.5 mA) ■ 4...20 mA US (3.9...20.8 mA) ■ 4...20 mA (4... 20.5 mA) ■ 0...20 mA (0... 20.5 mA) 	Set reaction time for output signal to fluctuations in the measured value.	0.0 to 999.9 s	1.0 s
Failure mode	A process variable is selected in the Assign current output parameter (→ 85) and one of the following options is selected in the Current span parameter (→ 85): <ul style="list-style-type: none"> ■ 4...20 mA NAMUR (3.8...20.5 mA) ■ 4...20 mA US (3.9...20.8 mA) ■ 4...20 mA (4... 20.5 mA) ■ 0...20 mA (0... 20.5 mA) 	Define output behavior in alarm condition.	<ul style="list-style-type: none"> ■ Min. ■ Max. ■ Last valid value ■ Actual value ■ Defined value 	Max.
Failure current	The Defined value option is selected in the Failure mode parameter.	Enter current output value in alarm condition.	0 to 22.5 mA	22.5 mA

* Visibility depends on order options or device settings

10.3.8 Configuring the pulse/frequency/switch output

The **Pulse/frequency/switch output** wizard guides you systematically through all the parameters that can be set for configuring the selected output type.

Navigation

"Setup" menu → Advanced setup → Pulse/frequency/switch output

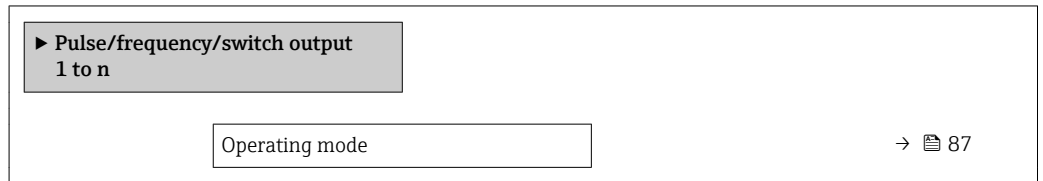

Parameter overview with brief description

Parameter	Description	Selection	Factory setting
Operating mode	Define the output as a pulse, frequency or switch output.	<ul style="list-style-type: none"> ■ Pulse ■ Frequency ■ Switch 	Pulse

Configuring the pulse output

Navigation

"Setup" menu → Pulse/frequency/switch output

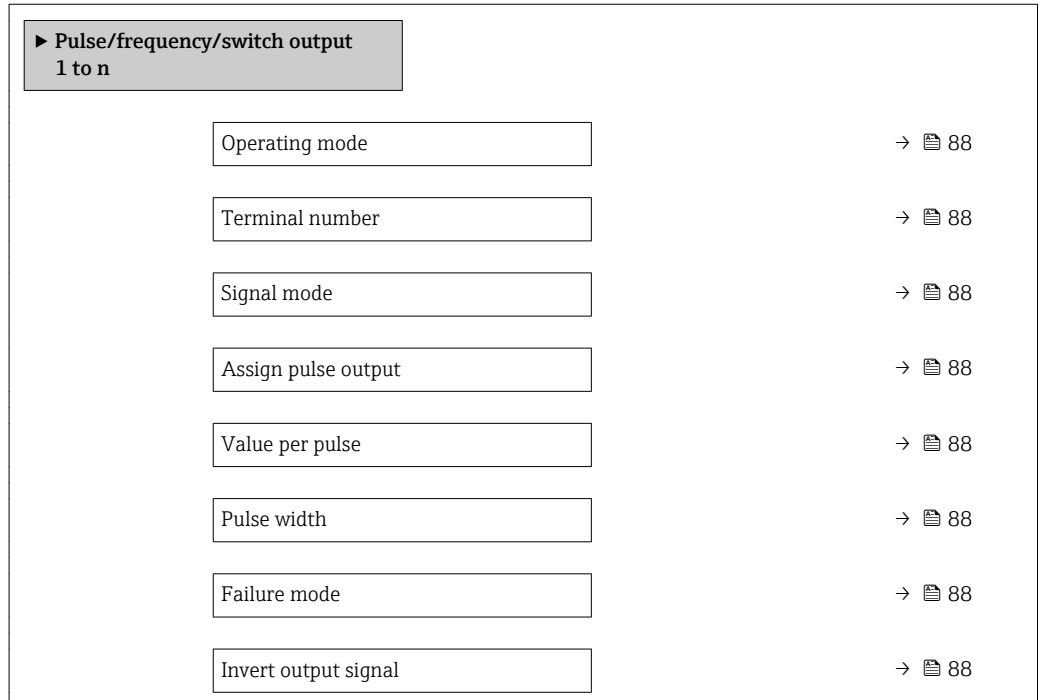

Parameter overview with brief description

Parameter	Prerequisite	Description	Selection / User interface / User entry	Factory setting
Operating mode	–	Define the output as a pulse, frequency or switch output.	<ul style="list-style-type: none"> ▪ Pulse ▪ Frequency ▪ Switch 	Pulse
Terminal number	–	Shows the terminal numbers used by the PFS output module.	<ul style="list-style-type: none"> ▪ Not used ▪ 24-25 (I/O 2) ▪ 22-23 (I/O 3) 	–
Signal mode	–	Select the signal mode for the PFS output.	<ul style="list-style-type: none"> ▪ Passive ▪ Active ▪ Passive NAMUR 	Passive
Assign pulse output 1 to n	The Pulse option is selected in the Operating mode parameter.	Select process variable for pulse output.	<ul style="list-style-type: none"> ▪ Off ▪ Volume flow ▪ Corrected volume flow * ▪ Mass flow ▪ Energy flow * 	Off
Pulse scaling	The Pulse option is selected in the Operating mode parameter (→ 87) and a process variable is selected in the Assign pulse output parameter (→ 88).	Enter quantity for measured value at which a pulse is output.	Positive floating point number	Depends on country and nominal diameter
Pulse width	The Pulse option is selected in the Operating mode parameter (→ 87) and a process variable is selected in the Assign pulse output parameter (→ 88).	Define time width of the output pulse.	0.05 to 2 000 ms	100 ms
Failure mode	The Pulse option is selected in the Operating mode parameter (→ 87) and a process variable is selected in the Assign pulse output parameter (→ 88).	Define output behavior in alarm condition.	<ul style="list-style-type: none"> ▪ Actual value ▪ No pulses 	No pulses
Invert output signal	–	Invert the output signal.	<ul style="list-style-type: none"> ▪ No ▪ Yes 	No

* Visibility depends on order options or device settings

Configuring the frequency output

Navigation

"Setup" menu → Pulse/frequency/switch output

▶ Pulse/frequency/switch output
1 to n

Operating mode









→ 89

Terminal number

→ 89

Signal mode

→ 89

Assign frequency output	→  89
Minimum frequency value	→  90
Maximum frequency value	→  90
Measuring value at minimum frequency	→  90
Measuring value at maximum frequency	→  90
Failure mode	→  90
Failure frequency	→  90
Invert output signal	→  90

Parameter overview with brief description

Parameter	Prerequisite	Description	Selection / User interface / User entry	Factory setting
Operating mode	–	Define the output as a pulse, frequency or switch output.	<ul style="list-style-type: none"> ▪ Pulse ▪ Frequency ▪ Switch 	Pulse
Terminal number	–	Shows the terminal numbers used by the PFS output module.	<ul style="list-style-type: none"> ▪ Not used ▪ 24-25 (I/O 2) ▪ 22-23 (I/O 3) 	–
Signal mode	–	Select the signal mode for the PFS output.	<ul style="list-style-type: none"> ▪ Passive ▪ Active ▪ Passive NAMUR 	Passive
Assign frequency output	The Frequency option is selected in the Operating mode parameter (→  87).	Select process variable for frequency output.	<ul style="list-style-type: none"> ▪ Off ▪ Volume flow ▪ Corrected volume flow * ▪ Mass flow ▪ Flow velocity ▪ Sound velocity ▪ Temperature * ▪ Pressure * ▪ Methane fraction * ▪ Molar mass * ▪ Density * ▪ Dynamic viscosity * ▪ Calorific value * ▪ Wobbe index * ▪ Energy flow * ▪ Signal strength * ▪ Signal to noise ratio * ▪ Acceptance rate * ▪ Turbulence * ▪ Flow asymmetry * ▪ Electronic temperature 	Off

Parameter	Prerequisite	Description	Selection / User interface / User entry	Factory setting
Minimum frequency value	The Frequency option is selected in the Operating mode parameter (→ 87) and a process variable is selected in the Assign frequency output parameter (→ 89).	Enter minimum frequency.	0.0 to 10 000.0 Hz	0.0 Hz
Maximum frequency value	The Frequency option is selected in the Operating mode parameter (→ 87) and a process variable is selected in the Assign frequency output parameter (→ 89).	Enter maximum frequency.	0.0 to 10 000.0 Hz	10 000.0 Hz
Measuring value at minimum frequency	The Frequency option is selected in the Operating mode parameter (→ 87) and a process variable is selected in the Assign frequency output parameter (→ 89).	Enter measured value for minimum frequency.	Signed floating-point number	Depends on country and nominal diameter
Measuring value at maximum frequency	The Frequency option is selected in the Operating mode parameter (→ 87) and a process variable is selected in the Assign frequency output parameter (→ 89).	Enter measured value for maximum frequency.	Signed floating-point number	Depends on country and nominal diameter
Failure mode	The Frequency option is selected in the Operating mode parameter (→ 87) and a process variable is selected in the Assign frequency output parameter (→ 89).	Define output behavior in alarm condition.	<ul style="list-style-type: none"> ▪ Actual value ▪ Defined value ▪ 0 Hz 	0 Hz
Failure frequency	The Frequency option is selected in the Operating mode parameter (→ 87) and a process variable is selected in the Assign frequency output parameter (→ 89).	Enter frequency output value in alarm condition.	0.0 to 12 500.0 Hz	0.0 Hz
Invert output signal	–	Invert the output signal.	<ul style="list-style-type: none"> ▪ No ▪ Yes 	No

* Visibility depends on order options or device settings

Configuring the switch output

Navigation

"Setup" menu → Pulse/frequency/switch output

► Pulse/frequency/switch output 1 to n	
Operating mode	→ 91
Terminal number	→ 91
Signal mode	→ 91
Switch output function	→ 92
Assign diagnostic behavior	→ 92
Assign limit	→ 92
Assign flow direction check	→ 92
Assign status	→ 92
Switch-on value	→ 92
Switch-off value	→ 93
Switch-on delay	→ 93
Switch-off delay	→ 93
Failure mode	→ 93
Invert output signal	→ 93

Parameter overview with brief description

Parameter	Prerequisite	Description	Selection / User interface / User entry	Factory setting
Operating mode	–	Define the output as a pulse, frequency or switch output.	<ul style="list-style-type: none"> ■ Pulse ■ Frequency ■ Switch 	Pulse
Terminal number	–	Shows the terminal numbers used by the PFS output module.	<ul style="list-style-type: none"> ■ Not used ■ 24-25 (I/O 2) ■ 22-23 (I/O 3) 	–
Signal mode	–	Select the signal mode for the PFS output.	<ul style="list-style-type: none"> ■ Passive ■ Active ■ Passive NAMUR 	Passive

Parameter	Prerequisite	Description	Selection / User interface / User entry	Factory setting
Switch output function	The Switch option is selected in the Operating mode parameter.	Select function for switch output.	<ul style="list-style-type: none"> ▪ Off ▪ On ▪ Diagnostic behavior ▪ Limit ▪ Flow direction check ▪ Status 	Off
Assign diagnostic behavior	<ul style="list-style-type: none"> ▪ In the Operating mode parameter, the Switch option is selected. ▪ In the Switch output function parameter, the Diagnostic behavior option is selected. 	Select diagnostic behavior for switch output.	<ul style="list-style-type: none"> ▪ Alarm ▪ Alarm or warning ▪ Warning 	Alarm
Assign limit	<ul style="list-style-type: none"> ▪ The Switch option is selected in the Operating mode parameter. ▪ The Limit option is selected in the Switch output function parameter. 	Select process variable for limit function.	<ul style="list-style-type: none"> ▪ Off ▪ Volume flow ▪ Corrected volume flow[*] ▪ Mass flow ▪ Flow velocity ▪ Sound velocity ▪ Temperature[*] ▪ Pressure[*] ▪ Methane fraction[*] ▪ Molar mass[*] ▪ Density[*] ▪ Dynamic viscosity[*] ▪ Calorific value[*] ▪ Wobbe index[*] ▪ Energy flow[*] ▪ Signal strength[*] ▪ Signal to noise ratio[*] ▪ Acceptance rate[*] ▪ Turbulence[*] ▪ Flow asymmetry[*] ▪ Electronic temperature ▪ Totalizer 1 ▪ Totalizer 2 ▪ Totalizer 3 	Volume flow
Assign flow direction check	<ul style="list-style-type: none"> ▪ The Switch option is selected in the Operating mode parameter. ▪ The Flow direction check option is selected in the Switch output function parameter. 	Select process variable for flow direction monitoring.	<ul style="list-style-type: none"> ▪ Off ▪ Volume flow ▪ Corrected volume flow[*] ▪ Mass flow ▪ Flow velocity ▪ Energy flow[*] 	Volume flow
Assign status	<ul style="list-style-type: none"> ▪ The Switch option is selected in the Operating mode parameter. ▪ The Status option is selected in the Switch output function parameter. 	Select device status for switch output.	<ul style="list-style-type: none"> ▪ Off ▪ Low flow cut off 	Low flow cut off
Switch-on value	<ul style="list-style-type: none"> ▪ The Switch option is selected in the Operating mode parameter. ▪ The Limit option is selected in the Switch output function parameter. 	Enter measured value for the switch-on point.	Signed floating-point number	Country-dependent

Parameter	Prerequisite	Description	Selection / User interface / User entry	Factory setting
Switch-off value	<ul style="list-style-type: none"> The Switch option is selected in the Operating mode parameter. The Limit option is selected in the Switch output function parameter. 	Enter measured value for the switch-off point.	Signed floating-point number	Country-dependent
Switch-on delay	<ul style="list-style-type: none"> The Switch option is selected in the Operating mode parameter. The Limit option is selected in the Switch output function parameter. 	Define delay for the switch-on of status output.	0.0 to 100.0 s	0.0 s
Switch-off delay	<ul style="list-style-type: none"> The Switch option is selected in the Operating mode parameter. The Limit option is selected in the Switch output function parameter. 	Define delay for the switch-off of status output.	0.0 to 100.0 s	0.0 s
Failure mode	–	Define output behavior in alarm condition.	<ul style="list-style-type: none"> Actual status Open Closed 	Open
Invert output signal	–	Invert the output signal.	<ul style="list-style-type: none"> No Yes 	No

* Visibility depends on order options or device settings

10.3.9 Configuring the relay output

The **Relay output** wizard guides the user systematically through all the parameters that have to be set for configuring the relay output.

Navigation

"Setup" menu → Relay output 1 to n

► RelaisOutput 1 to n

- Switch output function

→ 94
- Assign flow direction check

→ 94
- Assign limit

→ 94
- Assign diagnostic behavior

→ 94
- Assign status

→ 94
- Switch-off value

→ 94
- Switch-on value

→ 95
- Failure mode

→ 95

Parameter overview with brief description

Parameter	Prerequisite	Description	Selection / User interface / User entry	Factory setting
Relay output function	–	Select the function for the relay output.	<ul style="list-style-type: none"> ▪ Closed ▪ Open ▪ Diagnostic behavior ▪ Limit ▪ Flow direction check ▪ Digital Output 	Closed
Terminal number	–	Shows the terminal numbers used by the relay output module.	<ul style="list-style-type: none"> ▪ Not used ▪ 24-25 (I/O 2) ▪ 22-23 (I/O 3) 	–
Assign flow direction check	In the Relay output function parameter, the Flow direction check option is selected.	Select process variable for flow direction monitoring.	<ul style="list-style-type: none"> ▪ Off ▪ Volume flow ▪ Corrected volume flow[*] ▪ Mass flow ▪ Flow velocity[*] ▪ Energy flow[*] 	Volume flow
Assign limit	The Limit option is selected in the Relay output function parameter.	Select process variable for limit function.	<ul style="list-style-type: none"> ▪ Off ▪ Volume flow ▪ Corrected volume flow[*] ▪ Mass flow ▪ Flow velocity ▪ Sound velocity[*] ▪ Temperature[*] ▪ Pressure[*] ▪ Methane fraction[*] ▪ Molar mass[*] ▪ Density[*] ▪ Dynamic viscosity[*] ▪ Calorific value[*] ▪ Wobbe index[*] ▪ Energy flow[*] ▪ Signal strength[*] ▪ Signal to noise ratio[*] ▪ Acceptance rate[*] ▪ Turbulence[*] ▪ Flow asymmetry[*] ▪ Electronic temperature ▪ Totalizer 1 ▪ Totalizer 2 ▪ Totalizer 3 	Volume flow
Assign diagnostic behavior	In the Relay output function parameter, the Diagnostic behavior option is selected.	Select diagnostic behavior for switch output.	<ul style="list-style-type: none"> ▪ Alarm ▪ Alarm or warning ▪ Warning 	Alarm
Assign status	In the Relay output function parameter, the Digital Output option is selected.	Select device status for switch output.	<ul style="list-style-type: none"> ▪ Off ▪ Low flow cut off 	Off
Switch-off value	In the Relay output function parameter, the Limit option is selected.	Enter measured value for the switch-off point.	Signed floating-point number	0 m ³ /h
Switch-off delay	In the Relay output function parameter, the Limit option is selected.	Define delay for the switch-off of status output.	0.0 to 100.0 s	0.0 s

Parameter	Prerequisite	Description	Selection / User interface / User entry	Factory setting
Switch-on value	The Limit option is selected in the Relay output function parameter.	Enter measured value for the switch-on point.	Signed floating-point number	0 m ³ /h
Switch-on delay	In the Relay output function parameter, the Limit option is selected.	Define delay for the switch-on of status output.	0.0 to 100.0 s	0.0 s
Failure mode	–	Define output behavior in alarm condition.	<ul style="list-style-type: none"> ■ Actual status ■ Open ■ Closed 	Open

* Visibility depends on order options or device settings

10.3.10 Configuring the double pulse output

The **Double pulse output** submenu guides the user systematically through all the parameters that have to be set for configuring the double pulse output.

Navigation

"Setup" menu → Double pulse output

► Double pulse output

Master terminal number	→ ⓘ 95
Slave terminal number	→ ⓘ 96
Signal mode	→ ⓘ 95
Assign pulse output 1	→ ⓘ 96
Measuring mode	→ ⓘ 96
Value per pulse	→ ⓘ 96
Pulse width	→ ⓘ 96
Failure mode	→ ⓘ 96
Invert output signal	→ ⓘ 96

Parameter overview with brief description

Parameter	Description	Selection / User interface / User entry	Factory setting
Signal mode	Select the signal mode for the double pulse output.	<ul style="list-style-type: none"> ■ Passive ■ Active ■ Passive NAMUR 	Passive
Master terminal number	Shows the terminal numbers used by the master of the double pulse output module.	<ul style="list-style-type: none"> ■ Not used ■ 24-25 (I/O 2) ■ 22-23 (I/O 3) 	–

Parameter	Description	Selection / User interface / User entry	Factory setting
Slave terminal number	Shows the terminal numbers used by the slave of the double pulse output module.	<ul style="list-style-type: none"> ■ Not used ■ 24-25 (I/O 2) ■ 22-23 (I/O 3) 	–
Assign pulse output 1	Select process variable for pulse output.	<ul style="list-style-type: none"> ■ Off ■ Volume flow ■ Corrected volume flow * ■ Mass flow ■ Energy flow * 	Off
Measuring mode	Select measuring mode for pulse output.	<ul style="list-style-type: none"> ■ Forward flow ■ Forward/Reverse flow ■ Reverse flow ■ Reverse flow compensation 	Forward flow
Value per pulse	Enter measured value at which a pulse is output.	Signed floating-point number	Depends on country and nominal diameter
Pulse width	Define time width of the output pulse.	0.5 to 2 000 ms	0.5 ms
Failure mode	Define output behavior in alarm condition.	<ul style="list-style-type: none"> ■ Actual value ■ No pulses 	No pulses
Invert output signal	Invert the output signal.	<ul style="list-style-type: none"> ■ No ■ Yes 	No

* Visibility depends on order options or device settings

10.3.11 Configuring the local display

The **Display** wizard guides you systematically through all the parameters that can be configured for configuring the local display.



Navigation

"Setup" menu → Display

► Display	
Format display	→ ⓘ 97
Value 1 display	→ ⓘ 97
0% bargraph value 1	→ ⓘ 97
100% bargraph value 1	→ ⓘ 97
Value 2 display	→ ⓘ 98
Value 3 display	→ ⓘ 98
0% bargraph value 3	→ ⓘ 98
100% bargraph value 3	→ ⓘ 98
Value 4 display	→ ⓘ 98

Parameter overview with brief description

Parameter	Prerequisite	Description	Selection / User entry	Factory setting
Format display	A local display is provided.	Select how measured values are shown on the display.	<ul style="list-style-type: none"> ■ 1 value, max. size ■ 1 bargraph + 1 value ■ 2 values ■ 1 value large + 2 values ■ 4 values 	1 value, max. size
Value 1 display	A local display is provided.	Select the measured value that is shown on the local display.	<ul style="list-style-type: none"> ■ Volume flow ■ Corrected volume flow[*] ■ Mass flow ■ Flow velocity ■ Sound velocity ■ Temperature[*] ■ Pressure[*] ■ Methane fraction[*] ■ Molar mass[*] ■ Density[*] ■ Dynamic viscosity[*] ■ Calorific value[*] ■ Wobbe index[*] ■ Energy flow[*] ■ Signal strength[*] ■ Signal to noise ratio[*] ■ Acceptance rate[*] ■ Turbulence[*] ■ Flow asymmetry[*] ■ Electronic temperature ■ Totalizer 1 ■ Totalizer 2 ■ Totalizer 3 ■ Current output 1[*] ■ Current output 2[*] ■ Current output 3[*] ■ Current output 4[*] 	Volume flow
0% bargraph value 1	A local display is provided.	Enter 0% value for bar graph display.	Signed floating-point number	Country-dependent
100% bargraph value 1	A local display is provided.	Enter 100% value for bar graph display.	Signed floating-point number	Depends on country and nominal diameter

Parameter	Prerequisite	Description	Selection / User entry	Factory setting
Value 2 display	A local display is provided.	Select the measured value that is shown on the local display.	<ul style="list-style-type: none"> ▪ None ▪ Volume flow ▪ Corrected volume flow[*] ▪ Mass flow ▪ Flow velocity ▪ Sound velocity ▪ Temperature[*] ▪ Pressure[*] ▪ Methane fraction[*] ▪ Molar mass[*] ▪ Density[*] ▪ Dynamic viscosity[*] ▪ Calorific value[*] ▪ Wobbe index[*] ▪ Energy flow[*] ▪ Signal strength[*] ▪ Signal to noise ratio[*] ▪ Acceptance rate[*] ▪ Turbulence[*] ▪ Flow asymmetry[*] ▪ Electronic temperature ▪ Totalizer 1 ▪ Totalizer 2 ▪ Totalizer 3 ▪ Current output 1[*] ▪ Current output 2[*] ▪ Current output 3[*] ▪ Current output 4[*] 	None
Value 3 display	A local display is provided.	Select the measured value that is shown on the local display.	For the picklist, see the Value 2 display parameter (→  98)	None
0% bargraph value 3	A selection was made in the Value 3 display parameter.	Enter 0% value for bar graph display.	Signed floating-point number	Country-dependent
100% bargraph value 3	A selection was made in the Value 3 display parameter.	Enter 100% value for bar graph display.	Signed floating-point number	0
Value 4 display	A local display is provided.	Select the measured value that is shown on the local display.	For the picklist, see the Value 2 display parameter (→  98)	None

* Visibility depends on order options or device settings

10.3.12 Configuring the low flow cut off

The **Low flow cut off** wizard systematically guides the user through all the parameters that must be set to configure low flow cut off.

Structure of the wizard

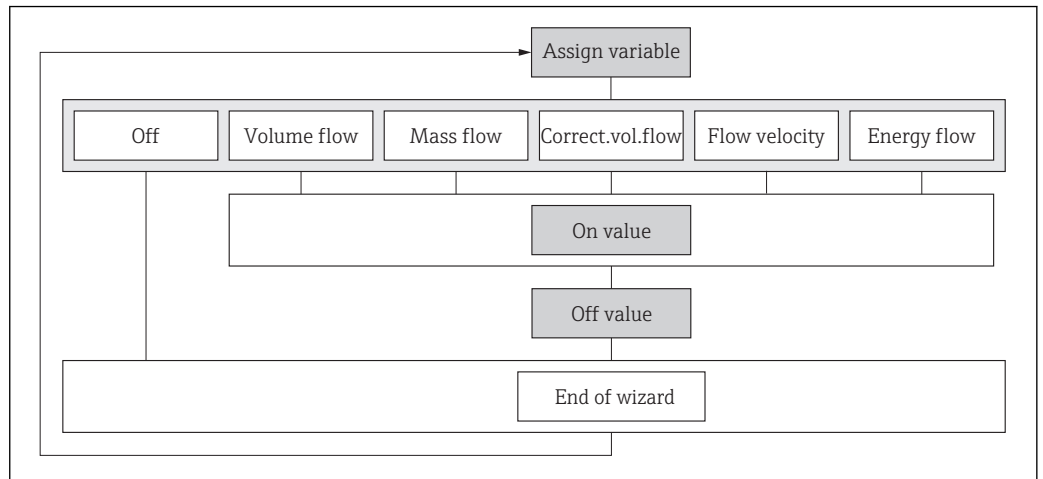

A0038131-EN

Fig. 27 "Low flow cutoff" wizard in the "Setup" menu

Navigation

"Setup" menu → Low flow cut off

▶ **Low flow cut off**

Assign process variable → ⓘ 99

On value low flow cutoff → ⓘ 99

Off value low flow cutoff → ⓘ 99

Parameter overview with brief description

Parameter	Prerequisite	Description	Selection / User entry	Factory setting
Assign process variable	–	Select process variable for low flow cut off.	<ul style="list-style-type: none"> ■ Off ■ Volume flow ■ Corrected volume flow* ■ Mass flow ■ Flow velocity* ■ Energy flow* 	Volume flow
On value low flow cutoff	A process variable is selected in the Assign process variable parameter (→ ⓘ 99).	Enter on value for low flow cut off.	Positive floating-point number	Depends on country and nominal diameter
Off value low flow cutoff	A process variable is selected in the Assign process variable parameter (→ ⓘ 99).	Enter off value for low flow cut off.	0 to 100.0 %	50 %

* Visibility depends on order options or device settings

10.3.13 Gas analysis configuration

The "Gas analysis" wizard guides the user systematically through all the parameters that have to be set for configuring the gas analysis.

Navigation

"Setup" menu → Gas analysis

► Gas analysis	
Select gas type	→ 100
Pressure mode	→ 100
Pressure	→ 100
Temperature mode	→ 100
Medium temperature	→ 100
Relative density	→ 100
Calorific value	→ 100

Parameter overview with brief description

Parameter	Description	Selection / User entry	Factory setting
Select gas type	Select measured gas type.	<ul style="list-style-type: none"> ▪ Single gas * ▪ Gas mixture * ▪ Coal gas/bio gas * ▪ Natural gas - standardized calculation * ▪ Natural gas - using sound velocity * ▪ User-specific gas 	User-specific gas
Pressure compensation	Select pressure compensation type.	<ul style="list-style-type: none"> ▪ Fixed value ▪ Internal measured value * ▪ External value * ▪ Current input 1 * ▪ Current input 2 * ▪ Current input 3 * 	Fixed value
Pressure	Enter fixed value for the process pressure.	0 to 250 bar	5 bar
Temperature compensation	Select temperature mode for temperature compensation.	<ul style="list-style-type: none"> ▪ Fixed value ▪ Internal measured value * ▪ External value * ▪ Current input 1 * ▪ Current input 2 * ▪ Current input 3 * 	Fixed value
Medium temperature	Enter a fixed value for process temperature.	-50 to 150 °C	20 °C
Relative density	Enter the relative density of the gas.	0.5 to 1.0	0.58
Calorific value	Enter gross calorific value to calculate the energy flow.	0 to 1000 MJ/Nm ³	40 MJ/Nm ³

* Visibility depends on order options or device settings

10.4 Advanced settings

The **Advanced setup** submenu together with its submenus contains parameters for specific settings.

Navigation to the "Advanced setup" submenu

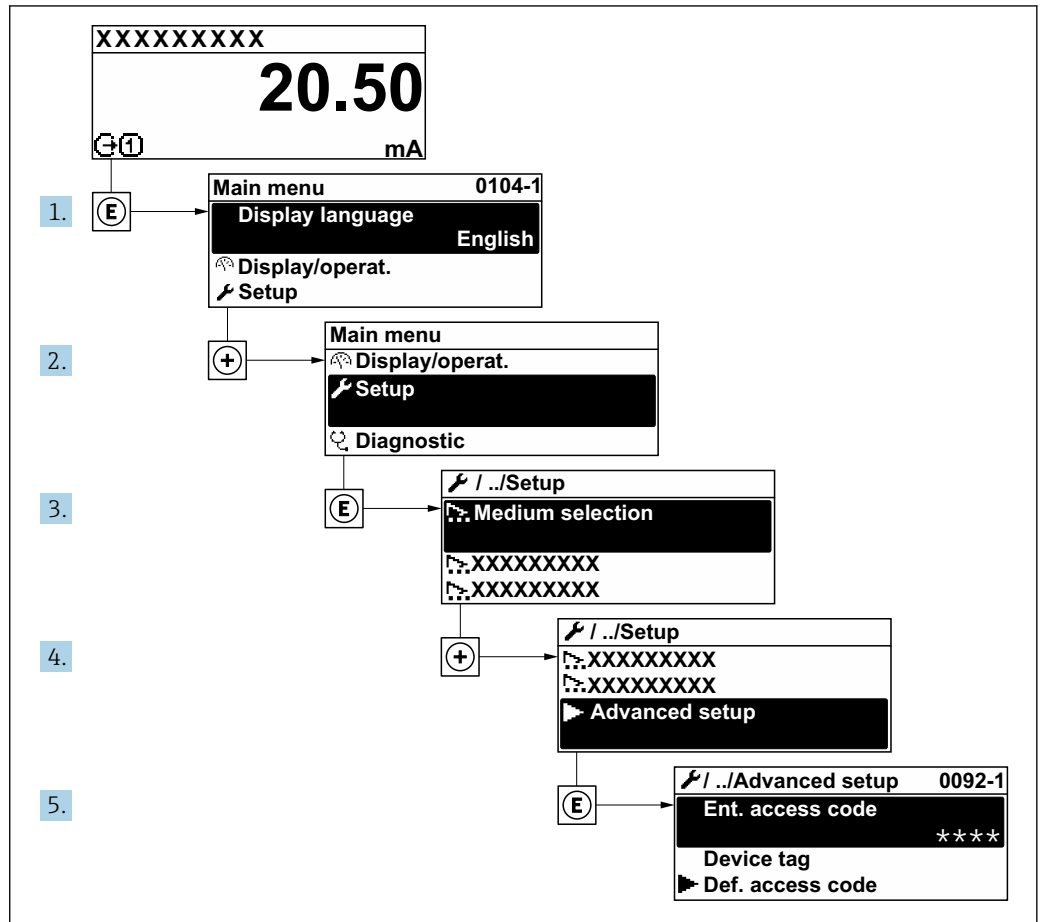

A003223-EN

i The number of submenus and parameters can vary depending on the device version. Certain submenus and parameters in these submenus are not described in the Operation Instructions. Instead a description is provided in the Special Documentation for the device (→ "Supplementary documentation" section).

Navigation

"Setup" menu → Advanced setup

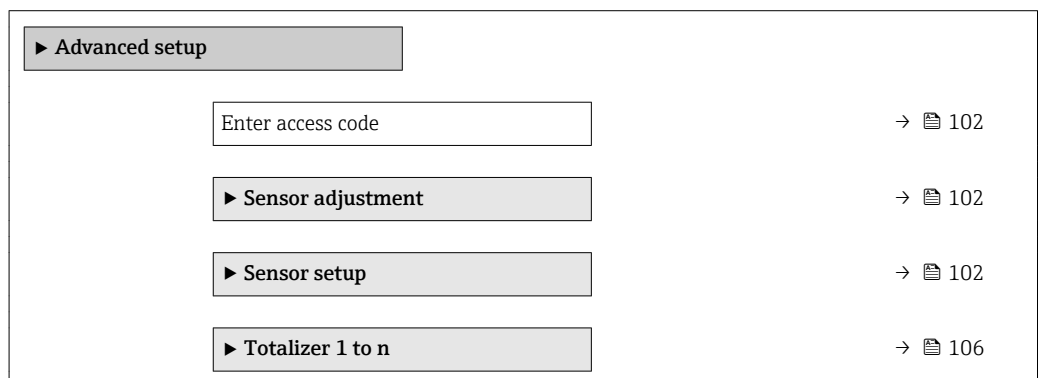

▶ SIL confirmation	
▶ Deactivate SIL	
▶ Display	→ ⓘ 107
▶ Heartbeat setup	
▶ Configuration backup	→ ⓘ 112
▶ Administration	→ ⓘ 114
▶ WLAN settings	→ ⓘ 110

10.4.1 Using the parameter to enter the access code

Navigation

"Setup" menu → Advanced setup

Parameter overview with brief description

Parameter	Description	User entry
Enter access code	Enter access code to disable write protection of parameters.	Max. 16-digit character string comprising numbers, letters and special characters

10.4.2 Carrying out a sensor adjustment

The **Sensor adjustment** submenu contains parameters that pertain to the functionality of the sensor.

Navigation

"Setup" menu → Advanced setup → Sensor adjustment

▶ Sensor adjustment	
Installation direction	→ ⓘ 102

Parameter overview with brief description

Parameter	Description	Selection	Factory setting
Installation direction	Set sign of flow direction to match the direction of the arrow on the sensor.	<ul style="list-style-type: none"> ▪ Flow in arrow direction ▪ Flow against arrow direction 	Flow in arrow direction





10.4.3 Performing the sensor setup

The **Sensor setup** submenu contains parameters that concern the sensor setup.

Navigation

"Setup" menu → Advanced setup → Sensor setup

► Sensor setup	
Medium temperature	→ 104
Process fluid	→ 104
Sound velocity	→ 104
Viscosity	→ 104
Minimum sound velocity	→ 104
Maximum sound velocity	→ 104
Pipe material	→ 104
Pipe sound velocity	→ 104
Pipe dimensions	→ 105
Pipe circumference	→ 105
Pipe outer diameter	→ 105
Pipe wall thickness	→ 105
Liner material	→ 105
Liner sound velocity	→ 105
Liner thickness	→ 105
Sensor type	→ 105
Mounting type	→ 105
Cable length	→ 105
Wire length	→ 105
Sensor distance	→ 105
Signal path length	→ 105
Arc length	→ 105

Sensor distance deviation	→  105
Arc length deviation	→  105
Sensor setup result 1	→  106
Sensor setup result 2	→  106

Parameter overview with brief description

Parameter	Description	User entry / Selection / User interface	Factory setting
Medium temperature	Enter a fixed value for process temperature.	-200 to 450 °C	20 °C
Process fluid	Select process fluid.	<ul style="list-style-type: none"> ▪ Water ▪ Sea water ▪ Distilled water ▪ Alcohol ▪ Benzene ▪ Bromine ▪ Ethanol ▪ Glycol ▪ Kerosene ▪ Milk ▪ Methanol ▪ Toluene ▪ Lube oil ▪ Fuel oil ▪ Petrol ▪ User-specific liquid ▪ LPG ▪ Air* 	Air
Sound velocity	Enter sound velocity of fluid.	Positive floating-point number	1482.4 m/s
Viscosity	Enter medium viscosity at installation temperature.	Signed floating-point number	1E-6 m ² /s
Minimum sound velocity	Enter the minimum deviation of sound velocity.	0.0 to 1000.0 m/s	195 m/s
Maximum sound velocity	Enter the maximum deviation of sound velocity.	0.0 to 1000.0 m/s	355 m/s
Pipe material	Select pipe material.	<ul style="list-style-type: none"> ▪ Carbon steel ▪ Ductile cast iron ▪ Stainless steel ▪ 1.4301 (UNS S30400) ▪ 1.4401 (UNS S31600) ▪ 1.4550 (UNS S34700) ▪ Hastelloy C ▪ PVC ▪ PE ▪ LDPE ▪ HDPE ▪ GRP ▪ PVDF ▪ PA ▪ PP ▪ PTFE ▪ Pyrex glass ▪ Asbestos cement ▪ Copper ▪ Unknown pipe material 	Stainless steel
Pipe sound velocity	Enter sound velocity of pipe material.	800.0 to 3800.0 m/s	3120.0 m/s

Parameter	Description	User entry / Selection / User interface	Factory setting
Pipe dimensions	Select if pipe dimensions are defined by diameter or circumference.	<ul style="list-style-type: none"> ■ Diameter ■ Pipe circumference 	Diameter
Pipe circumference	Define the pipe circumference.	30 to 15 710 mm	314.159 mm
Pipe outer diameter	Define the outer diameter of the pipe.	Positive floating-point number	0.100 mm
Pipe wall thickness	Define the pipe wall thickness.	Signed floating-point number	0.003 mm
Liner material	Select liner material.	<ul style="list-style-type: none"> ■ None ■ Cement ■ Rubber ■ Epoxy resin ■ Unknown liner material 	None
Liner sound velocity	Define the sound velocity of liner material.	800.0 to 3 800.0 m/s	2 400.0 m/s
Liner thickness	Define the thickness of liner.	0.0 to 0.1 mm	0 mm
Sensor type	Select sensor type.	<ul style="list-style-type: none"> ■ E-200-A* ■ C-030-A* ■ C-050-A* ■ C-100-A* ■ C-100-B* ■ C-100-C* ■ C-200-A* ■ C-200-B* ■ C-200-C* ■ C-200-C* ■ C-500-A* ■ C-500-B* ■ CH-050-A* ■ CH-100-A* ■ CH-200-A* ■ I-100-A* ■ I-100-B* ■ G-010-A* ■ G-020-A* ■ SV-100-A* ■ SV-100-B* ■ WT-400-A* ■ WT-400-B* ■ S-DAT ■ Unknown 	S-DAT
Mounting type	Select how the sensors are arranged to each other.	<ul style="list-style-type: none"> ■ (1) direct ■ (2) V-mounting ■ (3) Z-Mounting ■ (4) W-mounting ■ Automatic 	(2) V-mounting
Cable length	Enter length of sensor cables.	0 to 200 000 mm	5 000 mm
Wire length	Shows wire length of installation kit.	Signed floating-point number	0 mm
Sensor distance	Shows the distance between the sensors.	Signed floating-point number	80 mm
Signal path length	Shows signal path length.	Signed floating-point number	0 mm
Arc length	Shows the given radial distance for the mounting position of the sensor.	Signed floating-point number	0 mm
Sensor distance deviation	Enter deviation between nominal signal path length and welded position.	Signed floating-point number	0 mm
Arc length deviation	Enter the radial deviation between given radial distance and the real mounting position of the sensor.	Signed floating-point number	0 mm

Parameter	Description	User entry / Selection / User interface	Factory setting
Sensor setup result 1	Summarizes how the sensors should be installed at the measuring point.		-
Sensor setup result 2	Summarizes how the sensors should be installed at the measuring point.		-

* Visibility depends on order options or device settings

10.4.4 Configuring the totalizer

In the "Totalizer 1 to n" submenu the individual totalizer can be configured.

Navigation

"Setup" menu → Advanced setup → Totalizer 1 to n

► Totalizer 1 to n	
Assign process variable	→ ⓘ 106
Unit totalizer 1 to n	→ ⓘ 106
Totalizer operation mode	→ ⓘ 106
Failure mode	→ ⓘ 106

Parameter overview with brief description

Parameter	Prerequisite	Description	Selection	Factory setting
Assign process variable	-	Select process variable for totalizer.	<ul style="list-style-type: none"> ▪ Off ▪ Volume flow ▪ Corrected volume flow * ▪ Mass flow ▪ Energy flow * 	Volume flow
Unit totalizer 1 to n	A process variable is selected in the Assign process variable parameter (→ ⓘ 106) of the Totalizer 1 to n submenu.	Select process variable totalizer unit.	Unit choose list	Country-specific: <ul style="list-style-type: none"> ▪ m³ ▪ ft³
Totalizer operation mode	A process variable is selected in the Assign process variable parameter (→ ⓘ 106) of the Totalizer 1 to n submenu.	Select totalizer calculation mode.	<ul style="list-style-type: none"> ▪ Net flow total ▪ Forward flow total ▪ Reverse flow total 	Net flow total
Failure mode	A process variable is selected in the Assign process variable parameter (→ ⓘ 106) of the Totalizer 1 to n submenu.	Define totalizer behavior in alarm condition.	<ul style="list-style-type: none"> ▪ Stop ▪ Actual value ▪ Last valid value 	Stop

* Visibility depends on order options or device settings

10.4.5 Carrying out additional display configurations

In the **Display** submenu you can set all the parameters associated with the configuration of the local display.



Navigation

"Setup" menu → Advanced setup → Display

► Display	
Format display	→ 108
Value 1 display	→ 108
0% bargraph value 1	→ 108
100% bargraph value 1	→ 108
Decimal places 1	→ 108
Value 2 display	→ 109
Decimal places 2	→ 109
Value 3 display	→ 109
0% bargraph value 3	→ 109
100% bargraph value 3	→ 109
Decimal places 3	→ 109
Value 4 display	→ 109
Decimal places 4	→ 109
Display language	→ 110
Display interval	→ 110
Display damping	→ 110
Header	→ 110
Header text	→ 110
Separator	→ 110
Backlight	→ 110

Parameter overview with brief description

Parameter	Prerequisite	Description	Selection / User entry	Factory setting
Format display	A local display is provided.	Select how measured values are shown on the display.	<ul style="list-style-type: none"> ▪ 1 value, max. size ▪ 1 bargraph + 1 value ▪ 2 values ▪ 1 value large + 2 values ▪ 4 values 	1 value, max. size
Value 1 display	A local display is provided.	Select the measured value that is shown on the local display.	<ul style="list-style-type: none"> ▪ Volume flow ▪ Corrected volume flow[*] ▪ Mass flow ▪ Flow velocity ▪ Sound velocity ▪ Temperature[*] ▪ Pressure[*] ▪ Methane fraction[*] ▪ Molar mass[*] ▪ Density[*] ▪ Dynamic viscosity[*] ▪ Calorific value[*] ▪ Wobbe index[*] ▪ Energy flow[*] ▪ Signal strength[*] ▪ Signal to noise ratio[*] ▪ Acceptance rate[*] ▪ Turbulence[*] ▪ Flow asymmetry[*] ▪ Electronic temperature ▪ Totalizer 1 ▪ Totalizer 2 ▪ Totalizer 3 ▪ Current output 1[*] ▪ Current output 2[*] ▪ Current output 3[*] ▪ Current output 4[*] 	Volume flow
0% bargraph value 1	A local display is provided.	Enter 0% value for bar graph display.	Signed floating-point number	Country-dependent
100% bargraph value 1	A local display is provided.	Enter 100% value for bar graph display.	Signed floating-point number	Depends on country and nominal diameter
Decimal places 1	A measured value is specified in the Value 1 display parameter.	Select the number of decimal places for the display value.	<ul style="list-style-type: none"> ▪ x ▪ x.x ▪ x.xx ▪ x.xxx ▪ x.xxxx 	x.xx

Parameter	Prerequisite	Description	Selection / User entry	Factory setting
Value 2 display	A local display is provided.	Select the measured value that is shown on the local display.	<ul style="list-style-type: none"> ■ None ■ Volume flow ■ Corrected volume flow[*] ■ Mass flow ■ Flow velocity ■ Sound velocity[*] ■ Temperature[*] ■ Pressure[*] ■ Methane fraction[*] ■ Molar mass[*] ■ Density[*] ■ Dynamic viscosity[*] ■ Calorific value[*] ■ Wobbe index[*] ■ Energy flow[*] ■ Signal strength[*] ■ Signal to noise ratio[*] ■ Acceptance rate[*] ■ Turbulence[*] ■ Flow asymmetry[*] ■ Electronic temperature ■ Totalizer 1 ■ Totalizer 2 ■ Totalizer 3 ■ Current output 1[*] ■ Current output 2[*] ■ Current output 3[*] ■ Current output 4[*] 	None
Decimal places 2	A measured value is specified in the Value 2 display parameter.	Select the number of decimal places for the display value.	<ul style="list-style-type: none"> ■ x ■ x.x ■ x.xx ■ x.xxx ■ x.xxxx 	x.xx
Value 3 display	A local display is provided.	Select the measured value that is shown on the local display.	For the picklist, see the Value 2 display parameter (→  98)	None
0% bargraph value 3	A selection was made in the Value 3 display parameter.	Enter 0% value for bar graph display.	Signed floating-point number	Country-dependent
100% bargraph value 3	A selection was made in the Value 3 display parameter.	Enter 100% value for bar graph display.	Signed floating-point number	0
Decimal places 3	A measured value is specified in the Value 3 display parameter.	Select the number of decimal places for the display value.	<ul style="list-style-type: none"> ■ x ■ x.x ■ x.xx ■ x.xxx ■ x.xxxx 	x.xx
Value 4 display	A local display is provided.	Select the measured value that is shown on the local display.	For the picklist, see the Value 2 display parameter (→  98)	None
Decimal places 4	A measured value is specified in the Value 4 display parameter.	Select the number of decimal places for the display value.	<ul style="list-style-type: none"> ■ x ■ x.x ■ x.xx ■ x.xxx ■ x.xxxx 	x.xx

Parameter	Prerequisite	Description	Selection / User entry	Factory setting
Display language	A local display is provided.	Set display language.	<ul style="list-style-type: none"> ▪ English ▪ Deutsch ▪ Français ▪ Español ▪ Italiano ▪ Nederlands ▪ Portuguesa ▪ Polski ▪ русский язык (Russian) ▪ Svenska ▪ Türkçe ▪ 中文 (Chinese) ▪ 日本語 (Japanese) ▪ 한국어 (Korean) ▪ العربية (Arabic) ▪ Bahasa Indonesia ▪ ภาษาไทย (Thai) ▪ tiếng Việt (Vietnamese) ▪ čeština (Czech) 	English (alternatively, the ordered language is preset in the device)
Display interval	A local display is provided.	Set time measured values are shown on display if display alternates between values.	1 to 10 s	5 s
Display damping	A local display is provided.	Set display reaction time to fluctuations in the measured value.	0.0 to 999.9 s	0.0 s
Header	A local display is provided.	Select header contents on local display.	<ul style="list-style-type: none"> ▪ Device tag ▪ Free text 	Device tag
Header text	In the Header parameter, the Free text option is selected.	Enter display header text.	Max. 12 characters such as letters, numbers or special characters (e.g. @, %, /)	-----
Separator	A local display is provided.	Select decimal separator for displaying numerical values.	<ul style="list-style-type: none"> ▪ . (point) ▪ , (comma) 	. (point)
Backlight	One of the following conditions is met: <ul style="list-style-type: none"> ▪ Order code for "Display; operation", option F "4-line, illum.; touch control" ▪ Order code for "Display; operation", option G "4-line, illum.; touch control +WLAN" ▪ Order code for "Display; operation", option O "Separate 4-line display, illum.; 10m/30ft cable; touch control" 	Switch the local display backlight on and off.	<ul style="list-style-type: none"> ▪ Disable ▪ Enable 	Enable

* Visibility depends on order options or device settings

10.4.6 WLAN configuration

The **WLAN Settings** submenu guides the user systematically through all the parameters that have to be set for the WLAN configuration.



Navigation

"Setup" menu → Advanced setup → WLAN settings

▶ WLAN settings	
WLAN	→ ⓘ 111
WLAN mode	→ ⓘ 111
SSID name	→ ⓘ 111
Network security	→ ⓘ 112
Security identification	→ ⓘ 112
User name	→ ⓘ 112
WLAN password	→ ⓘ 112
WLAN IP address	→ ⓘ 112
WLAN MAC address	→ ⓘ 112
WLAN passphrase	→ ⓘ 112
Assign SSID name	→ ⓘ 112
SSID name	→ ⓘ 112
Connection state	→ ⓘ 112
Received signal strength	→ ⓘ 112

Parameter overview with brief description

Parameter	Prerequisite	Description	Selection / User entry / User interface	Factory setting
WLAN	–	Switch WLAN on and off.	<ul style="list-style-type: none"> ■ Disable ■ Enable 	Enable
WLAN mode	–	Select WLAN mode.	<ul style="list-style-type: none"> ■ WLAN access point ■ WLAN Client 	WLAN access point
SSID name	The client is activated.	Enter the user-defined SSID name (max. 32 characters).	–	–

Parameter	Prerequisite	Description	Selection / User entry / User interface	Factory setting
Network security	–	Select the security type of the WLAN network.	<ul style="list-style-type: none"> ■ Unsecured ■ WPA2-PSK ■ EAP-PEAP with MSCHAPv2 * ■ EAP-PEAP MSCHAPv2 no server authentic. * ■ EAP-TLS * 	WPA2-PSK
Security identification	–	Select security settings and download these settings via menu Data management > Security > WLAN.	<ul style="list-style-type: none"> ■ Trusted issuer certificate ■ Device certificate ■ Device private key 	–
User name	–	Enter user name.	–	–
WLAN password	–	Enter WLAN password.	–	–
WLAN IP address	–	Enter IP address of the WLAN interface of the device.	4 octet: 0 to 255 (in the particular octet)	192.168.1.212
WLAN MAC address	–	Enter MAC address of the WLAN interface of the device.	Unique 12-digit character string comprising letters and numbers	Each measuring device is given an individual address.
WLAN passphrase	The WPA2-PSK option is selected in the Security type parameter.	Enter the network key (8 to 32 characters).  The network key supplied with the device should be changed during commissioning for security reasons.	8 to 32-digit character string comprising numbers, letters and special characters (without spaces)	Serial number of the measuring device (e.g. L100A802000)
Assign SSID name	–	Select which name will be used for SSID: device tag or user-defined name.	<ul style="list-style-type: none"> ■ Device tag ■ User-defined 	User-defined
SSID name	<ul style="list-style-type: none"> ■ The User-defined option is selected in the Assign SSID name parameter. ■ The WLAN access point option is selected in the WLAN mode parameter. 	Enter the user-defined SSID name (max. 32 characters).  The user-defined SSID name may only be assigned once. If the SSID name is assigned more than once, the devices can interfere with one another.	Max. 32-digit character string comprising numbers, letters and special characters	EH_device designation_last 7 digits of the serial number (e.g. EH_Prosonic_Flow_300_A802000)
Connection state	–	Displays the connection status.	<ul style="list-style-type: none"> ■ Connected ■ Not connected 	Not connected
Received signal strength	–	Shows the received signal strength.	<ul style="list-style-type: none"> ■ Low ■ Medium ■ High 	High

* Visibility depends on order options or device settings

10.4.7 Configuration management

After commissioning, you can save the current device configuration or restore the previous device configuration.

You can do so using the **Configuration management** parameter and the related options found in the **Configuration backup** submenu.

Navigation

"Setup" menu → Advanced setup → Configuration backup

► Configuration backup	
Operating time	→ ⓘ 113
Last backup	→ ⓘ 113
Configuration management	→ ⓘ 113
Backup state	→ ⓘ 113
Comparison result	→ ⓘ 113

Parameter overview with brief description

Parameter	Description	User interface / Selection	Factory setting
Operating time	Indicates how long the device has been in operation.	Days (d), hours (h), minutes (m) and seconds (s)	–
Last backup	Shows when the last data backup was saved to HistoROM backup.	Days (d), hours (h), minutes (m) and seconds (s)	–
Configuration management	Select action for managing the device data in the HistoROM backup.	<ul style="list-style-type: none"> ■ Cancel ■ Execute backup ■ Restore * ■ Compare * ■ Clear backup data 	Cancel
Backup state	Shows the current status of data saving or restoring.	<ul style="list-style-type: none"> ■ None ■ Backup in progress ■ Restoring in progress ■ Delete in progress ■ Compare in progress ■ Restoring failed ■ Backup failed 	None
Comparison result	Comparison of current device data with HistoROM backup.	<ul style="list-style-type: none"> ■ Settings identical ■ Settings not identical ■ No backup available ■ Backup settings corrupt ■ Check not done ■ Dataset incompatible 	Check not done

* Visibility depends on order options or device settings

Function scope of the "Configuration management" parameter

Options	Description
Cancel	No action is executed and the user exits the parameter.
Execute backup	A backup copy of the current device configuration is saved from the HistoROM backup to the memory of the device. The backup copy includes the transmitter data of the device.
Restore	The last backup copy of the device configuration is restored from the device memory to the device's HistoROM backup. The backup copy includes the transmitter data of the device.

Options	Description
Compare	The device configuration saved in the device memory is compared with the current device configuration of the HistoROM backup.
Clear backup data	The backup copy of the device configuration is deleted from the memory of the device.

 **HistoROM backup**
 A HistoROM is a "non-volatile" device memory in the form of an EEPROM.

 While this action is in progress, the configuration cannot be edited via the local display and a message on the processing status appears on the display.

10.4.8 Using parameters for device administration

The **Administration** submenu systematically guides the user through all the parameters that can be used for device administration purposes.

Navigation

"Setup" menu → Advanced setup → Administration

▶ Administration	
▶ Define access code	→ ⓘ 114
▶ Reset access code	→ ⓘ 115
Device reset	→ ⓘ 115

Using the parameter to define the access code

Navigation

"Setup" menu → Advanced setup → Administration → Define access code

▶ Define access code	
Define access code	→ ⓘ 114
Confirm access code	→ ⓘ 114

Parameter overview with brief description

Parameter	Description	User entry
Define access code	Restrict write-access to parameters to protect the configuration of the device against unintentional changes.	Max. 16-digit character string comprising numbers, letters and special characters
Confirm access code	Confirm the entered access code.	Max. 16-digit character string comprising numbers, letters and special characters

Using the parameter to reset the access code

Navigation

"Setup" menu → Advanced setup → Administration → Reset access code

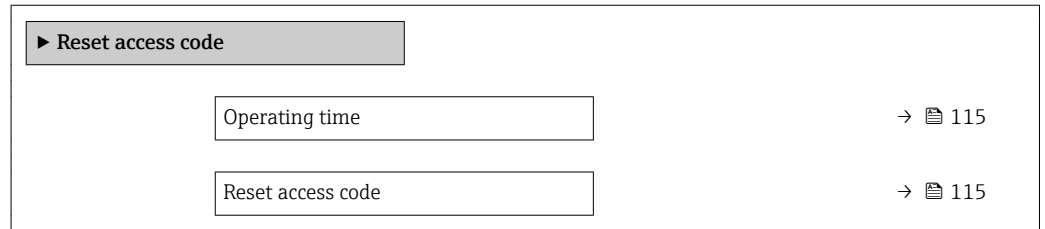

Parameter overview with brief description

Parameter	Description	User interface / User entry	Factory setting
Operating time	Indicates how long the device has been in operation.	Days (d), hours (h), minutes (m) and seconds (s)	-
Reset access code	Reset access code to factory settings.  For a reset code, contact your Endress+Hauser service organization. The reset code can only be entered via: <ul style="list-style-type: none"> ▪ Web browser ▪ DeviceCare, FieldCare (via service interface CDI-RJ45) ▪ Fieldbus 	Character string comprising numbers, letters and special characters	0x00

Using the parameter to reset the device

Navigation

"Setup" menu → Advanced setup → Administration

Parameter overview with brief description

Parameter	Description	Selection	Factory setting
Device reset	Reset the device configuration - either entirely or in part - to a defined state.	<ul style="list-style-type: none"> ▪ Cancel ▪ To delivery settings ▪ Restart device ▪ Restore S-DAT backup * 	Cancel

* Visibility depends on order options or device settings

10.5 Simulation



The **Simulation** submenu enables you to simulate, without a real flow situation, various process variables in the process and the device alarm mode and to verify downstream signal chains (switching valves or closed-control loops).

Navigation

"Diagnostics" menu → Simulation

► Simulation	
Assign simulation process variable	→ 117
Process variable value	→ 117
Status input simulation 1 to n	→ 117
Input signal level 1 to n	→ 117
Current input 1 to n simulation	→ 117
Value current input 1 to n	→ 117
Current output 1 to n simulation	→ 117
Value current output 1 to n	→ 117
Frequency output simulation 1 to n	→ 117
Frequency value 1 to n	→ 117
Pulse output simulation 1 to n	→ 117
Pulse value 1 to n	→ 117
Switch output simulation 1 to n	→ 117
Switch status 1 to n	→ 118
Relay output 1 to n simulation	→ 118
Switch status 1 to n	→ 118
Pulse output simulation	→ 118
Pulse value	→ 118
Device alarm simulation	→ 118
Diagnostic event category	→ 118
Diagnostic event simulation	→ 118

Parameter overview with brief description



Parameter	Prerequisite	Description	Selection / User entry / User interface	Factory setting
Assign simulation process variable	–	Select a process variable for the simulation process that is activated.	<ul style="list-style-type: none"> ■ Off ■ Volume flow ■ Corrected volume flow[*] ■ Mass flow ■ Flow velocity ■ Sound velocity ■ Temperature[*] ■ Pressure[*] ■ Methane fraction[*] ■ Molar mass[*] ■ Density[*] ■ Dynamic viscosity[*] ■ Calorific value[*] ■ Wobbe index[*] ■ Energy flow[*] 	Off
Process variable value	A process variable is selected in the Assign simulation process variable parameter (→  117).	Enter the simulation value for the selected process variable.	Depends on the process variable selected	0
Status input simulation 1 to n	–	Switch simulation of the status input on and off.	<ul style="list-style-type: none"> ■ Off ■ On 	Off
Input signal level 1 to n	In the Status input simulation parameter, the On option is selected.	Select the signal level for the simulation of the status input.	<ul style="list-style-type: none"> ■ High ■ Low 	High
Current input 1 to n simulation	–	Switch simulation of the current input on and off.	<ul style="list-style-type: none"> ■ Off ■ On 	Off
Value current input 1 to n	In the Current input 1 to n simulation parameter, the On option is selected.	Enter the current value for simulation.	0 to 22.5 mA	0 mA
Current output 1 to n simulation	–	Switch the simulation of the current output on and off.	<ul style="list-style-type: none"> ■ Off ■ On 	Off
Value current output 1 to n	In the Current output 1 to n simulation parameter, the On option is selected.	Enter the current value for simulation.	3.59 to 22.5 mA	3.59 mA
Frequency output simulation 1 to n	In the Operating mode parameter, the Frequency option is selected.	Switch the simulation of the frequency output on and off.	<ul style="list-style-type: none"> ■ Off ■ On 	Off
Frequency value 1 to n	In the Frequency output simulation 1 to n parameter, the On option is selected.	Enter the frequency value for the simulation.	0.0 to 12 500.0 Hz	0.0 Hz
Pulse output simulation 1 to n	In the Operating mode parameter, the Pulse option is selected.	Set and switch off the pulse output simulation.  For Fixed value option: Pulse width parameter (→  88) defines the pulse width of the pulses output.	<ul style="list-style-type: none"> ■ Off ■ Fixed value ■ Down-counting value 	Off
Pulse value 1 to n	In the Pulse output simulation 1 to n parameter, the Down-counting value option is selected.	Enter the number of pulses for simulation.	0 to 65 535	0
Switch output simulation 1 to n	In the Operating mode parameter, the Switch option is selected.	Switch the simulation of the switch output on and off.	<ul style="list-style-type: none"> ■ Off ■ On 	Off

Parameter	Prerequisite	Description	Selection / User entry / User interface	Factory setting
Switch status 1 to n	–	Select the status of the status output for the simulation.	<ul style="list-style-type: none"> ▪ Open ▪ Closed 	Open
Relay output 1 to n simulation	–	Switch simulation of the relay output on and off.	<ul style="list-style-type: none"> ▪ Off ▪ On 	Off
Switch status 1 to n	The On option is selected in the Switch output simulation 1 to n parameter parameter.	Select status of the relay output for the simulation.	<ul style="list-style-type: none"> ▪ Open ▪ Closed 	Open
Pulse output simulation	–	Set and switch off the pulse output simulation.  For Fixed value option: Pulse width parameter defines the pulse width of the pulses output.	<ul style="list-style-type: none"> ▪ Off ▪ Fixed value ▪ Down-counting value 	Off
Pulse value	In the Pulse output simulation parameter, the Down-counting value option is selected.	Set and switch off the pulse output simulation.	0 to 65 535	0
Device alarm simulation	–	Switch the device alarm on and off.	<ul style="list-style-type: none"> ▪ Off ▪ On 	Off
Diagnostic event category	–	Select a diagnostic event category.	<ul style="list-style-type: none"> ▪ Sensor ▪ Electronics ▪ Configuration ▪ Process 	Process
Diagnostic event simulation	–	Select a diagnostic event to simulate this event.	<ul style="list-style-type: none"> ▪ Off ▪ Diagnostic event picklist (depends on the category selected) 	Off
Logging interval	–	Define the logging interval tlog for data logging. This value defines the time interval between the individual data points in the memory.	1.0 to 3 600.0 s	–

* Visibility depends on order options or device settings

10.6 Protecting settings from unauthorized access

The following write protection options exist in order to protect the configuration of the measuring device from unintentional modification:



- Protect access to parameters via access code →  118
- Protect access to local operation via key locking →  58
- Protect access to measuring device via write protection switch →  120

10.6.1 Write protection via access code



The effects of the user-specific access code are as follows:

- Via local operation, the parameters for the measuring device configuration are write-protected and their values can no longer be changed.
- Device access is protected via the Web browser, as are the parameters for the measuring device configuration.
- Device access is protected via FieldCare or DeviceCare (via CDI-RJ45 service interface), as are the parameters for the measuring device configuration.

Defining the access code via local display

1. Navigate to the **Define access code** parameter (→  114).
2. Define a max. 16-digit character string comprising numbers, letters and special characters as the access code.
3. Enter the access code again in the **Confirm access code** parameter (→  114) to confirm the code.
 - ↳ The -symbol appears in front of all write-protected parameters.

The device automatically locks the write-protected parameters again if a key is not pressed for 10 minutes in the navigation and editing view. The device locks the write-protected parameters automatically after 60 s if the user skips back to the operational display mode from the navigation and editing view.



-  If parameter write protection is activated via an access code, it can also only be deactivated via this access code →  57.
- The user role with which the user is currently logged on via the local display →  57 is indicated by the **Access status** parameter. Navigation path: Operation → Access status

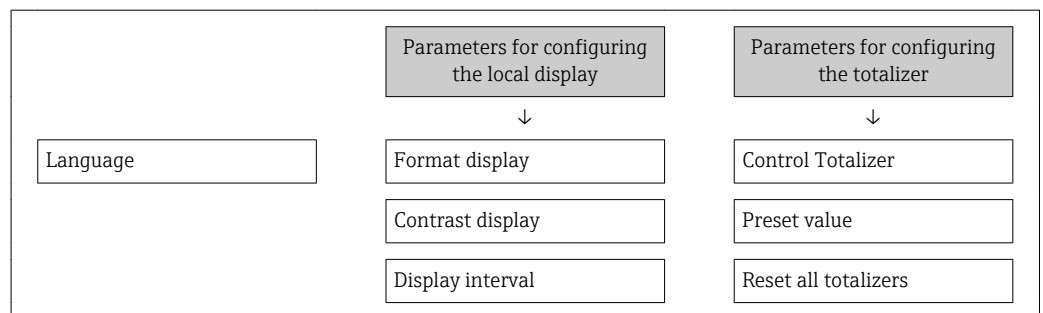

Parameters which can always be modified via the local display

Certain parameters that do not affect the measurement are excepted from parameter write protection via the local display. Despite the user-specific access code, they can always be modified, even if the other parameters are locked.



Defining the access code via the Web browser

1. Navigate to the **Define access code** parameter (→  114).
2. Define a max. 16-digit numeric code as an access code.
3. Enter the access code again in the **Confirm access code** parameter (→  114) to confirm the code.
 - ↳ The Web browser switches to the login page.



-  If no action is performed for 10 minutes, the Web browser automatically returns to the login page.
-  If parameter write protection is activated via an access code, it can also only be deactivated via this access code →  57.
- The user role with which the user is currently logged on via Web browser is indicated by the **Access status** parameter. Navigation path: Operation → Access status

Resetting the access code

If you misplace the user-specific access code, it is possible to reset the code to the factory setting. A reset code must be entered for this purpose. The user-specific access code can then be defined again afterwards.

Via Web browser, FieldCare, DeviceCare (via CDI-RJ45 service interface), fieldbus

i For a reset code, contact your Endress+Hauser service organization.

1. Navigate to the **Reset access code** parameter (→  115).
2. Enter the reset code.
 - ↳ The access code has been reset to the factory setting **0000**. It can be redefined →  119.

10.6.2 Write protection via write protection switch



Unlike parameter write protection via a user-specific access code, this allows write access to the entire operating menu - except for the **"Contrast display" parameter** - to be locked.

The parameter values are now read only and cannot be edited any more (exception **"Contrast display" parameter**):

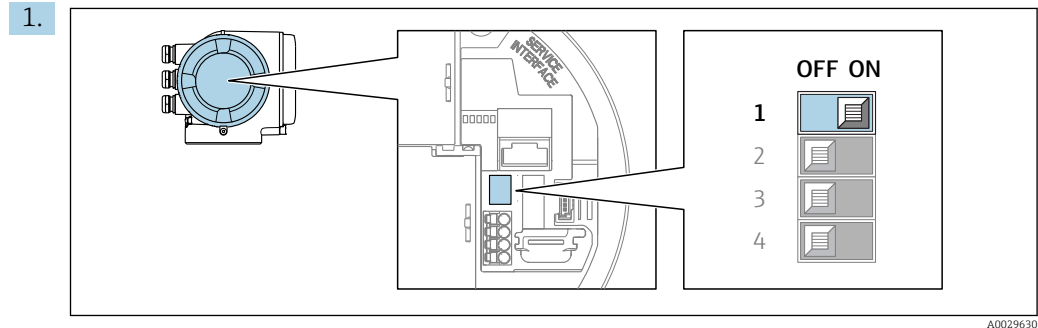

- Via local display
- Via MODBUS RS485 protocol

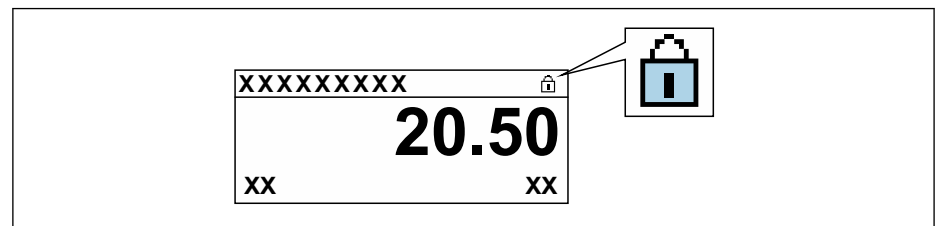

Setting the write protection (WP) switch on the main electronics module to the **ON** position enables hardware write protection.

- ↳ In the **Locking status** parameter the **Hardware locked** option is displayed →  121. In addition, on the local display the -symbol appears in front of the parameters in the header of the operational display and in the navigation view.



2. Setting the write protection (WP) switch on the main electronics module to the **OFF** position (factory setting) disables hardware write protection.
 - ↳ No option is displayed in the **Locking status** parameter →  121. On the local display, the -symbol disappears from in front of the parameters in the header of the operational display and in the navigation view.

11 Operation

11.1 Reading the device locking status

Device active write protection: **Locking status** parameter

Operation → Locking status

Function scope of the "Locking status" parameter

Options	Description
None	The access status displayed in the Access status parameter applies → 57. Only appears on local display.
Hardware locked	The DIP switch for hardware locking is activated on the PCB board. This locks write access to the parameters (e.g. via local display or operating tool) → 120.
Temporarily locked	Write access to the parameters is temporarily locked on account of internal processes running in the device (e.g. data upload/download, reset etc.). Once the internal processing has been completed, the parameters can be changed once again.

11.2 Adjusting the operating language

 Detailed information:

- To configure the operating language → 76
- For information on the operating languages supported by the measuring device → 179

11.3 Configuring the display

Detailed information:

- On the basic settings for the local display → 96
- On the advanced settings for the local display → 107

11.4 Reading measured values

With the **Measured values** submenu, it is possible to read all the measured values.

Navigation

"Diagnostics" menu → Measured values

▶ Measured values	
▶ Process variables	→ 122
▶ System values	→ 124
▶ Input values	→ 125
▶ Output values	→ 126
▶ Totalizer	→ 128

11.4.1 Process variables

The **Process variables** submenu contains all the parameters needed to display the current measured values for each process variable.







Navigation





"Diagnostics" menu → Measured values → Process variables

► Process variables	
Volume flow	→ ⓘ 122
Corrected volume flow	→ ⓘ 122
Mass flow	→ ⓘ 123
Sound velocity	→ ⓘ 123
Pressure	→ ⓘ 123
Energy flow	→ ⓘ 123
Flow velocity	→ ⓘ 123
Temperature	→ ⓘ 123
Wobbe index	→ ⓘ 123
Dry methane in %	→ ⓘ 123
Molar mass	→ ⓘ 124
Density	→ ⓘ 124
Dynamic viscosity	→ ⓘ 124
Calorific value	→ ⓘ 124

Parameter overview with brief description

Parameter	Prerequisite	Description	User interface
Volume flow	–	Displays the volume flow that is currently measured. <i>Dependency</i> The unit is taken from the Volume flow unit parameter (→ ⓘ 79).	Signed floating-point number
Corrected volume flow	–	Displays the corrected volume flow that is currently measured. <i>Dependency</i> The unit is taken from the Corrected volume flow unit parameter.	Signed floating-point number

Parameter	Prerequisite	Description	User interface
Mass flow	–	Displays the mass flow currently calculated. <i>Dependency</i> The unit is taken from the Mass flow unit parameter (→  79).	Signed floating-point number
Sound velocity	–	Displays the sound velocity that is currently measured. <i>Dependency</i> The unit is taken from the Velocity unit parameter.	Signed floating-point number
Pressure	For the following order code: "Measuring tube; Transducer; Sensor version", option AC "316L; Titanium Gr. 2; pressure + temperature measurement integrated"  The software options currently enabled are displayed in the Software option overview parameter.	Displays the pressure that is currently measured. <i>Dependency</i> The unit is taken from the Pressure unit parameter.	Signed floating-point number
Energy flow	–	Displays the energy flow that is currently calculated. <i>Dependency</i> The unit is taken from the Energy flow unit parameter (→  80).	Signed floating-point number
Flow velocity	–	Displays the flow velocity that is currently measured. <i>Dependency</i> The unit is taken from the Velocity unit parameter.	Signed floating-point number
Temperature	For the following order codes: ▪ "Measuring tube; Transducer; Sensor version", option AB "316L; Titanium Gr. 2; temperature measurement integrated" ▪ "Measuring tube; Transducer; Sensor version", option AC "316L; Titanium Gr. 2; pressure + temperature measurement integrated"  The software options currently enabled are displayed in the Software option overview parameter.	Displays the temperature that is currently measured. <i>Dependency</i> The unit is taken from the Temperature unit parameter.	Signed floating-point number
Wobbe index	For the following order code: "Application package", option EF "Advanced gas analysis"  The software options currently enabled are displayed in the Software option overview parameter.	Displays the Wobbe index that is currently calculated. <i>Dependency</i> The unit is taken from the Calorific value unit parameter (→  80).	Signed floating-point number
Dry methane in %	For the following order code: "Application package", option EF "Advanced gas analysis"  The software options currently enabled are displayed in the Software option overview parameter.	Displays the methane content in Mol% that is currently calculated.	Signed floating-point number

Parameter	Prerequisite	Description	User interface
Molar mass	For the following order code: "Application package", option EF "Advanced gas analysis"  The software options currently enabled are displayed in the Software option overview parameter.	Displays the molar mass in g/mol that is currently calculated.	Signed floating-point number
Density	For the following order code: "Application package", option EF "Advanced gas analysis"  The software options currently enabled are displayed in the Software option overview parameter.	Displays the density that is currently calculated. <i>Dependency</i> The unit is taken from the Density unit parameter.	Signed floating-point number
Dynamic viscosity	For the following order code: "Application package", option EF "Advanced gas analysis"  The software options currently enabled are displayed in the Software option overview parameter.	Displays the dynamic viscosity that is currently calculated. <i>Dependency</i> The unit is taken from the Dynamic viscosity unit parameter.	Signed floating-point number
Calorific value	For the following order code: "Application package", option EF "Advanced gas analysis"  The software options currently enabled are displayed in the Software option overview parameter.	Displays the calorific value that is currently calculated. <i>Dependency</i> The unit is taken from the Calorific value unit parameter.	Signed floating-point number





11.4.2 System values

The **System values** submenu contains all the parameters needed to display the current measured values for every system value.

Diagnostics → Measured values → System values

Navigation

"Diagnostics" menu → Measured values → System values

► System values	
Signal strength	→  125
Flow asymmetry	→  125
Signal to noise ratio	→  125
Turbulence	→  125

Parameter overview with brief description



Parameter	Prerequisite	Description	User interface
Signal strength	–	Displays the current signal strength.	Signed floating-point number
Flow asymmetry	 Only available from nominal diameter DN 50 (2").	Displays the asymmetry of the flow velocity between signal path 1 and signal path 2.	Signed floating-point number
Signal to noise ratio	–	Displays the current signal-to-noise ratio.	Signed floating-point number
Turbulence	–	Displays the current turbulence.	Signed floating-point number

11.4.3 "Input values" submenu

The **Input values** submenu guides you systematically to the individual input values.

Navigation

"Diagnostics" menu → Measured values → Input values



▶ Input values	
▶ Current input 1 to n	→  125
▶ Status input 1 to n	→  126

Input values of current input

The **Current input 1 to n** submenu contains all the parameters needed to display the current measured values for every current input.

Navigation

"Diagnostics" menu → Measured values → Input values → Current input 1 to n

▶ Current input 1 to n	
Measured values 1 to n	→  125
Measured current 1 to n	→  125

Parameter overview with brief description

Parameter	Description	User interface
Measured values 1 to n	Displays the current input value. <i>Dependency</i>  The unit is taken from the Pressure unit parameter	Signed floating-point number
Measured current 1 to n	Displays the current value of the current input.	0 to 22.5 mA

Input values of status input

The **Status input 1 to n** submenu contains all the parameters needed to display the current measured values for every status input.

Navigation

"Diagnostics" menu → Measured values → Input values → Status input 1 to n

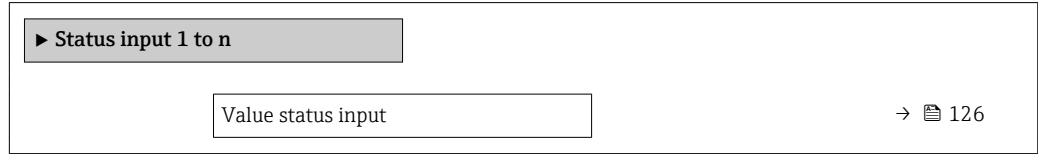

Parameter overview with brief description

Parameter	Description	User interface
Value status input	Shows the current input signal level.	<ul style="list-style-type: none"> ▪ High ▪ Low

11.4.4 Output values

The **Output values** submenu contains all the parameters needed to display the current measured values for every output.

Navigation

"Diagnostics" menu → Measured values → Output values

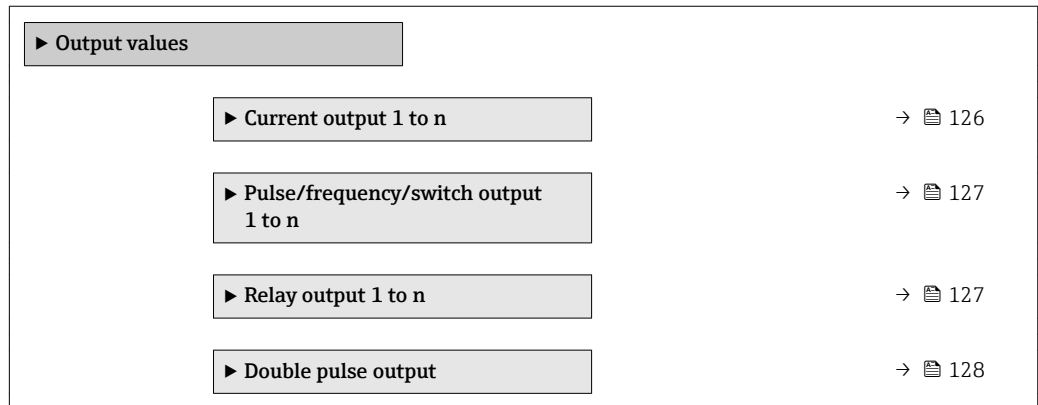

Output values of current output

The **Value current output** submenu contains all the parameters needed to display the current measured values for every current output.

Navigation

"Diagnostics" menu → Measured values → Output values → Value current output 1 to n

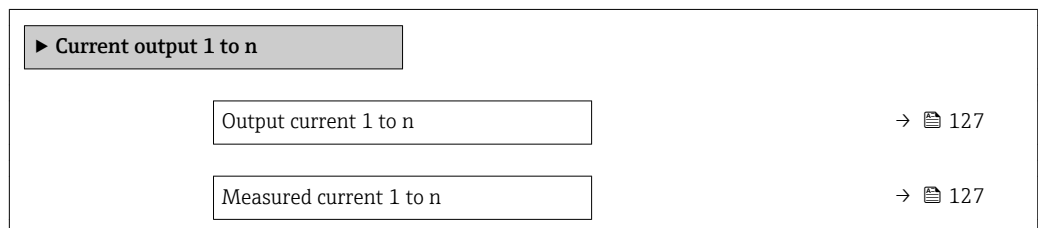

Parameter overview with brief description

Parameter	Description	User interface
Output current 1	Displays the current value currently calculated for the current output.	3.59 to 22.5 mA
Measured current	Displays the current value currently measured for the current output.	0 to 30 mA

Output values for pulse/frequency/switch output

The **Pulse/frequency/switch output 1 to n** submenu contains all the parameters needed to display the current measured values for every pulse/frequency/switch output.

Navigation

"Diagnostics" menu → Measured values → Output values → Pulse/frequency/switch output 1 to n

▶ **Pulse/frequency/switch output 1 to n**

Output frequency 1 to n	→ ⓘ 127
Pulse output 1 to n	→ ⓘ 127
Switch status 1 to n	→ ⓘ 127

Parameter overview with brief description

Parameter	Prerequisite	Description	User interface
Output frequency 1 to n	In the Operating mode parameter, the Frequency option is selected.	Displays the value currently measured for the frequency output.	0.0 to 12 500.0 Hz
Pulse output 1 to n	The Pulse option is selected in the Operating mode parameter parameter.	Displays the pulse frequency currently output.	Positive floating-point number
Switch status 1 to n	The Switch option is selected in the Operating mode parameter.	Displays the current switch output status.	<ul style="list-style-type: none"> ▪ Open ▪ Closed

Output values for relay output

The **Relay output 1 to n** submenu contains all the parameters needed to display the current measured values for every relay output.

Navigation

"Diagnostics" menu → Measured values → Output values → Relay output 1 to n

▶ **Relay output 1 to n**

Switch status	→ ⓘ 128
Switch cycles	→ ⓘ 128
Max. switch cycles number	→ ⓘ 128

Parameter overview with brief description

Parameter	Description	User interface
Switch status	Shows the current relay switch status.	<ul style="list-style-type: none"> ■ Open ■ Closed
Switch cycles	Shows number of all performed switch cycles.	Positive integer
Max. switch cycles number	Shows the maximal number of guaranteed switch cycles.	Positive integer

Output values for double pulse output

The **Double pulse output** submenu contains all the parameters needed to display the current measured values for every double pulse output.

Navigation

"Diagnostics" menu → Measured values → Output values → Double pulse output

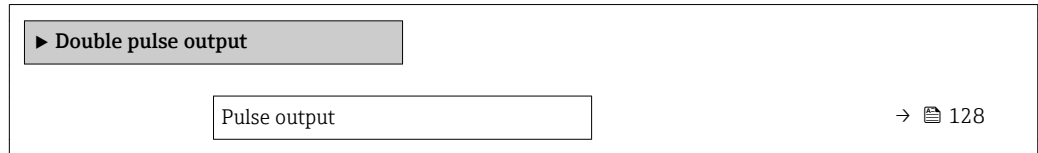

Parameter overview with brief description

Parameter	Description	User interface
Pulse output	Shows the currently output pulse frequency.	Positive floating-point number

11.4.5 "Totalizer" submenu

The **Totalizer** submenu contains all the parameters needed to display the current measured values for every totalizer.

Navigation

"Diagnostics" menu → Measured values → Totalizer

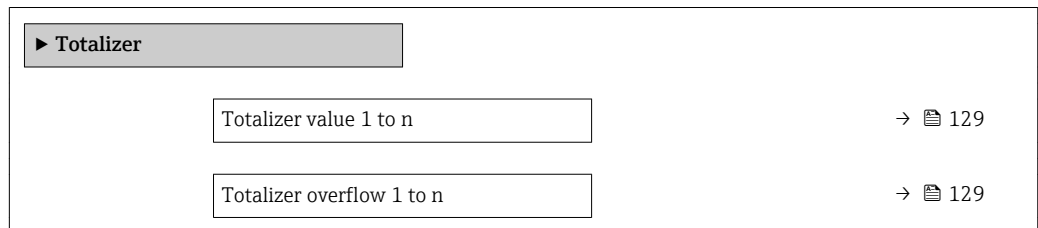

Parameter overview with brief description

Parameter	Prerequisite	Description	User interface
Totalizer value 1 to n	One of the following options is selected in the Assign process variable parameter (→ 106) of the Totalizer 1 to n submenu: <ul style="list-style-type: none"> ▪ Volume flow ▪ Corrected volume flow ▪ Mass flow ▪ Energy flow 	Displays the current totalizer counter value.	Signed floating-point number
Totalizer overflow 1 to n	One of the following options is selected in the Assign process variable parameter (→ 106) of the Totalizer 1 to n submenu: <ul style="list-style-type: none"> ▪ Volume flow ▪ Corrected volume flow ▪ Mass flow ▪ Energy flow 	Displays the current totalizer overflow.	Integer with sign

11.5 Adapting the measuring device to the process conditions

The following are available for this purpose:

- Basic settings using the **Setup** menu (→ 76)
- Advanced settings using the **Advanced setup** submenu (→ 101)

11.6 Performing a totalizer reset

The totalizers are reset in the **Operation** submenu:

- Control Totalizer
- Reset all totalizers

Navigation

"Operation" menu → Totalizer handling

▶ **Totalizer handling**

Control Totalizer 1 to n	→ 130
Preset value 1 to n	→ 130
Reset all totalizers	→ 130

Parameter overview with brief description

Parameter	Prerequisite	Description	Selection / User entry	Factory setting
Control Totalizer 1 to n	A process variable is selected in the Assign process variable parameter (→ 106) of the Totalizer 1 to n submenu.	Control totalizer value.	<ul style="list-style-type: none"> ■ Totalize ■ Reset + hold ■ Preset + hold ■ Reset + totalize ■ Preset + totalize ■ Hold 	Totalize
Preset value 1 to n	A process variable is selected in the Assign process variable parameter (→ 106) of the Totalizer 1 to n submenu.	Specify start value for totalizer. <i>Dependency</i>  The unit of the selected process variable is specified for the totalizer in the Unit totalizer parameter (→ 106).	Signed floating-point number	Country-specific: <ul style="list-style-type: none"> ■ 0 m³ ■ 0 ft³
Reset all totalizers	–	Reset all totalizers to 0 and start.	<ul style="list-style-type: none"> ■ Cancel ■ Reset + totalize 	Cancel

11.6.1 Function scope of the "Control Totalizer" parameter

Options	Description
Totalize	The totalizer is started or continues running.
Reset + hold	The totaling process is stopped and the totalizer is reset to 0.
Preset + hold	The totaling process is stopped and the totalizer is set to its defined start value from the Preset value parameter.
Reset + totalize	The totalizer is reset to 0 and the totaling process is restarted.
Preset + totalize	The totalizer is set to the defined start value from the Preset value parameter and the totaling process is restarted.
Hold	Totalizing is stopped.

11.6.2 Function scope of the "Reset all totalizers" parameter

Options	Description
Cancel	No action is executed and the user exits the parameter.
Reset + totalize	Resets all totalizers to 0 and restarts the totaling process. This deletes all the flow values previously totalized.

11.7 Showing data logging

The **Extended HistoROM** application package must be enabled in the device (order option) for the **Data logging** submenu to appear. This contains all the parameters for the measured value history.

-  Data logging is also available via:
- Plant Asset Management Tool FieldCare → 67.
 - Web browser

Function range

- A total of 1000 measured values can be stored
- 4 logging channels
- Adjustable logging interval for data logging
- Displays the measured value trend for each logging channel in the form of a chart

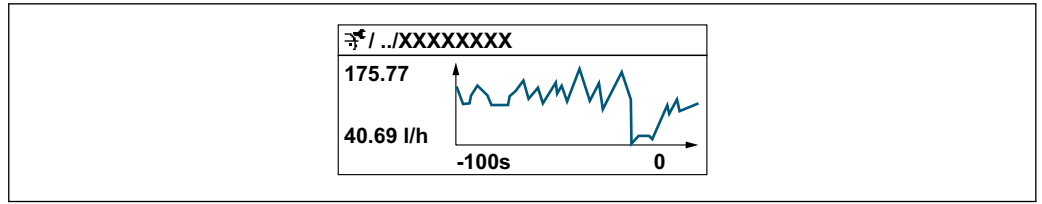

A0094352

- x-axis: depending on the number of channels selected displays 250 to 1000 measured values of a process variable.
- y-axis: displays the approximate measured value span and constantly adapts this to the ongoing measurement.

i If the length of the logging interval or the assignment of the process variables to the channels is changed, the content of the data logging is deleted.







Navigation

"Diagnostics" menu → Data logging

▶ Data logging

Assign channel 1	→ 132
Assign channel 2	→ 132
Assign channel 3	→ 132
Assign channel 4	→ 132
Logging interval	→ 132
Clear logging data	→ 132
Data logging	→ 133
Logging delay	→ 133
Data logging control	→ 133
Data logging status	→ 133
Entire logging duration	→ 133
▶ Display channel 1	
▶ Display channel 2	
▶ Display channel 3	
▶ Display channel 4	

Parameter overview with brief description

Parameter	Prerequisite	Description	Selection / User entry / User interface	Factory setting
Assign channel 1	The Extended HistoROM application package is available.	Assign process variable to logging channel.	<ul style="list-style-type: none"> ▪ Off ▪ Volume flow ▪ Corrected volume flow ▪ Mass flow ▪ Flow velocity ▪ Sound velocity ▪ Temperature * ▪ Pressure * ▪ Methane fraction * ▪ Molar mass * ▪ Density * ▪ Dynamic viscosity * ▪ Calorific value * ▪ Wobbe index * ▪ Energy flow ▪ Signal strength * ▪ Signal to noise ratio * ▪ Acceptance rate * ▪ Turbulence * ▪ Flow asymmetry * ▪ Electronic temperature ▪ Current output 2 * ▪ Current output 3 * ▪ Current output 4 * ▪ Current output 1 	Off
Assign channel 2	The Extended HistoROM application package is available.  The software options currently enabled are displayed in the Software option overview parameter.	Assign process variable to logging channel.	Picklist, see Assign channel 1 parameter (→  132)	Off
Assign channel 3	The Extended HistoROM application package is available.  The software options currently enabled are displayed in the Software option overview parameter.	Assign process variable to logging channel.	Picklist, see Assign channel 1 parameter (→  132)	Off
Assign channel 4	The Extended HistoROM application package is available.  The software options currently enabled are displayed in the Software option overview parameter.	Assign process variable to logging channel.	Picklist, see Assign channel 1 parameter (→  132)	Off
Logging interval	The Extended HistoROM application package is available.	Define the logging interval for data logging. This value defines the time interval between the individual data points in the memory.	0.1 to 3 600.0 s	1.0 s
Clear logging data	The Extended HistoROM application package is available.	Clear the entire logging data.	<ul style="list-style-type: none"> ▪ Cancel ▪ Clear data 	Cancel

Parameter	Prerequisite	Description	Selection / User entry / User interface	Factory setting
Data logging	–	Select the data logging method.	<ul style="list-style-type: none"> ■ Overwriting ■ Not overwriting 	Overwriting
Logging delay	In the Data logging parameter, the Not overwriting option is selected.	Enter the time delay for measured value logging.	0 to 999 h	0 h
Data logging control	In the Data logging parameter, the Not overwriting option is selected.	Start and stop measured value logging.	<ul style="list-style-type: none"> ■ None ■ Delete + start ■ Stop 	None
Data logging status	In the Data logging parameter, the Not overwriting option is selected.	Displays the measured value logging status.	<ul style="list-style-type: none"> ■ Done ■ Delay active ■ Active ■ Stopped 	Done
Entire logging duration	In the Data logging parameter, the Not overwriting option is selected.	Displays the total logging duration.	Positive floating-point number	0 s

* Visibility depends on order options or device settings

12 Diagnostics and troubleshooting

12.1 General troubleshooting

For local display

Error	Possible causes	Solution
Local display dark and no output signals	Supply voltage does not match the value indicated on the nameplate.	Apply the correct supply voltage → 34.
Local display dark and no output signals	The polarity of the supply voltage is wrong.	Correct the polarity.
Local display dark and no output signals	No contact between connecting cables and terminals.	Check the connection of the cables and correct if necessary.
Local display dark and no output signals	Terminals are not plugged into the I/O electronics module correctly. Terminals are not plugged into the main electronics module correctly.	Check terminals.
Local display dark and no output signals	I/O electronics module is defective. Main electronics module is defective.	Order spare part → 156.
Local display is dark, but signal output is within the valid range	Display is set too bright or too dark.	<ul style="list-style-type: none"> ▪ Set the display brighter by simultaneously pressing $\square + \square$. ▪ Set the display darker by simultaneously pressing $\square + \square$.
Local display is dark, but signal output is within the valid range	The cable of the display module is not plugged in correctly.	Insert the plug correctly into the main electronics module and display module.
Local display is dark, but signal output is within the valid range	Display module is defective.	Order spare part → 156.
Backlighting of local display is red	Diagnostic event with "Alarm" diagnostic behavior has occurred.	Take remedial measures → 144
Text on local display appears in a foreign language and cannot be understood.	Incorrect operating language is configured.	<ol style="list-style-type: none"> 1. Press $\square + \square$ for 2 s ("home position"). 2. Press \square. 3. Set the desired language in the Display language parameter (→ 110).
Message on local display: "Communication Error" "Check Electronics"	Communication between the display module and the electronics is interrupted.	<ul style="list-style-type: none"> ▪ Check the cable and the connector between the main electronics module and display module. ▪ Order spare part → 156.

For output signals

Error	Possible causes	Solution
Signal output outside the valid range	Main electronics module is defective.	Order spare part → 156.
Device shows correct value on local display, but signal output is incorrect, though in the valid range.	Configuration error	Check and correct the parameter configuration.
Device measures incorrectly.	Configuration error or device is operated outside the application.	<ol style="list-style-type: none"> 1. Check and correct parameter configuration. 2. Observe limit values specified in the "Technical Data".

For access

Error	Possible causes	Solution
No write access to parameters	Hardware write protection enabled	Set the write protection switch on main electronics module to the OFF position → 120.
No write access to parameters	Current user role has limited access authorization	1. Check user role → 57. 2. Enter correct customer-specific access code → 57.
No connection via Modbus RS485	Modbus RS485 bus cable connected incorrectly	Check terminal assignment → 33.
No connection via Modbus RS485	Modbus RS485 cable incorrectly terminated	Check terminating resistor → 42.
No connection via Modbus RS485	Incorrect settings for the communication interface	Check the Modbus RS485 configuration → 80.
Not connecting to Web server	Web server disabled	Using the "FieldCare" or "DeviceCare" operating tool, check whether the Web server of the measuring device is enabled, and enable it if necessary → 64.
	Incorrect setting for the Ethernet interface of the computer	1. Check the properties of the Internet protocol (TCP/IP) → 60 → 60. 2. Check the network settings with the IT manager.
Not connecting to Web server	Incorrect IP address	Check the IP address: 192.168.1.212 → 60 → 60
Not connecting to Web server	Incorrect WLAN access data	<ul style="list-style-type: none"> ▪ Check WLAN network status. ▪ Log on to the device again using WLAN access data. ▪ Verify that WLAN is enabled on the measuring device and operating device → 60.
	WLAN communication disabled	–
Not connecting to Web server, FieldCare or DeviceCare	No WLAN network available	<ul style="list-style-type: none"> ▪ Check if WLAN reception is present: LED on display module is lit blue ▪ Check if WLAN connection is enabled: LED on display module flashes blue ▪ Switch on instrument function.
Network connection not present or unstable	WLAN network is weak.	<ul style="list-style-type: none"> ▪ Operating device is outside of reception range: Check network status on operating device. ▪ To improve network performance, use an external WLAN antenna.
	Parallel WLAN and Ethernet communication	<ul style="list-style-type: none"> ▪ Check network settings. ▪ Temporarily enable only the WLAN as an interface.
Web browser frozen and operation no longer possible	Data transfer active	Wait until data transfer or current action is finished.
	Connection lost	1. Check cable connection and power supply. 2. Refresh the Web browser and restart if necessary.
Content of Web browser incomplete or difficult to read	Not using optimum version of Web server.	1. Use the correct Web browser version → 59. 2. Clear the Web browser cache and restart the Web browser.

Error	Possible causes	Solution
	Unsuitable view settings.	Change the font size/display ratio of the Web browser.
No or incomplete display of contents in the Web browser	<ul style="list-style-type: none"> ▪ JavaScript not enabled ▪ JavaScript cannot be enabled 	<ol style="list-style-type: none"> 1. Enable JavaScript. 2. Enter http://XXX.XXX.X.XXX/basic.html as the IP address.
Operation with FieldCare or DeviceCare via CDI-RJ45 service interface (port 8000)	Firewall of computer or network is preventing communication	Depending on the settings of the firewall used on the computer or in the network, the firewall must be adapted or disabled to allow FieldCare/DeviceCare access.
Flashing of firmware with FieldCare or DeviceCare via CDI-RJ45 service interface (via port 8000 or TFTP ports)	Firewall of computer or network is preventing communication	Depending on the settings of the firewall used on the computer or in the network, the firewall must be adapted or disabled to allow FieldCare/DeviceCare access.

12.2 Diagnostic information via light emitting diodes

12.2.1 Transmitter

Different LEDs in the transmitter provide information on the device status.

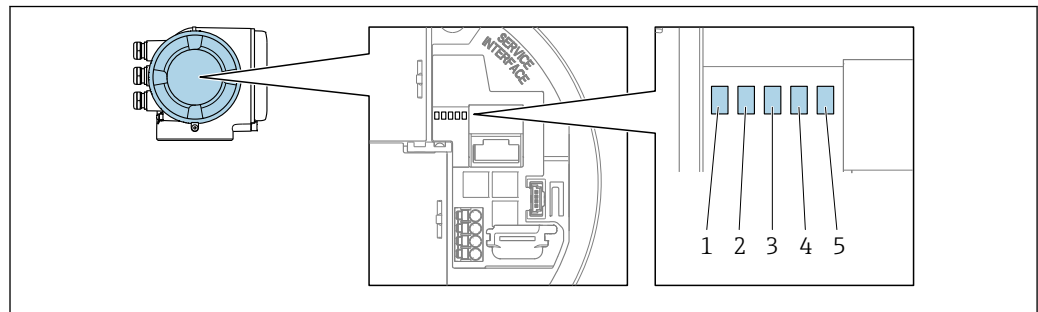

A0029629

- 1 Supply voltage
- 2 Device status
- 3 Not used
- 4 Communication
- 5 Service interface (CDI) active

LED	Color	Meaning
1 Supply voltage	Off	Supply voltage is off or too low.
	Green	Supply voltage is ok.
2 Device status	Off	Firmware error
	Green	Device status is ok.
	Flashing green	Device is not configured.
	Red	A diagnostic event with "Alarm" diagnostic behavior has occurred.
	Flashing red	A diagnostic event with "Warning" diagnostic behavior has occurred.
	Flashing red/green	The device restarts.
3 Not used	–	–
4 Communication	Off	Communication not active.
	White	Communication active.

LED	Color	Meaning
5 Service interface (CDI)	Off	Not connected or no connection established.
	Yellow	Connected and connection established.
	Flashing yellow	Service interface active.

12.3 Diagnostic information on local display

12.3.1 Diagnostic message

Faults detected by the self-monitoring system of the measuring device are displayed as a diagnostic message in alternation with the operational display.

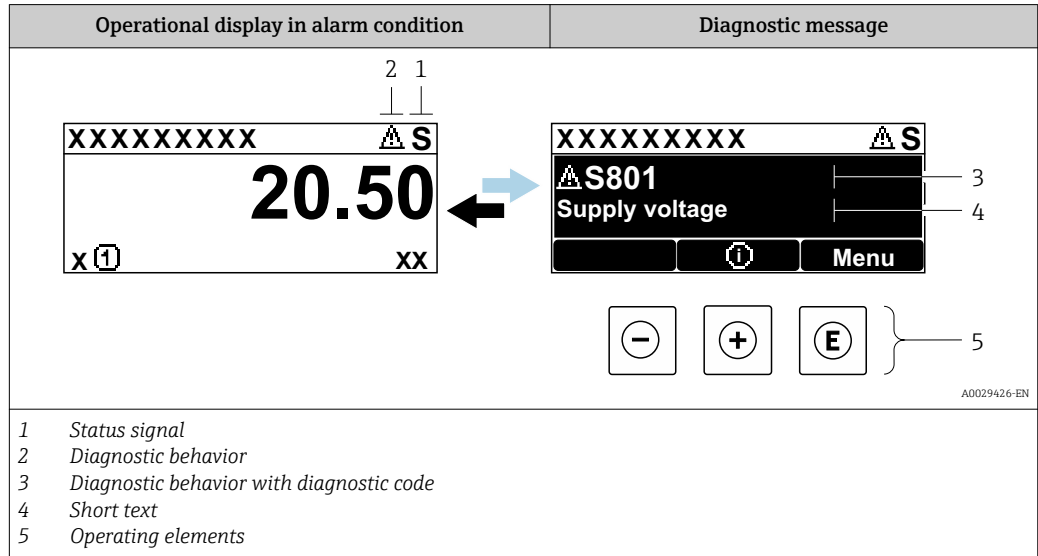

If two or more diagnostic events are pending simultaneously, only the message of the diagnostic event with the highest priority is shown.

- i** Other diagnostic events that have occurred can be displayed in the **Diagnostics** menu:
 - Via parameter → 148
 - Via submenus → 149



Status signals

The status signals provide information on the state and reliability of the device by categorizing the cause of the diagnostic information (diagnostic event).

- i** The status signals are categorized according to VDI/VDE 2650 and NAMUR Recommendation NE 107: F = Failure, C = Function Check, S = Out of Specification, M = Maintenance Required

Symbol	Meaning
F	Failure A device error has occurred. The measured value is no longer valid.
C	Function check The device is in service mode (e.g. during a simulation).
S	Out of specification The device is operated: Outside its technical specification limits (e.g. outside the process temperature range)
M	Maintenance required Maintenance is required. The measured value remains valid.

Diagnostic behavior



Symbol	Meaning
	Alarm <ul style="list-style-type: none"> Measurement is interrupted. Signal outputs and totalizers assume the defined alarm condition. A diagnostic message is generated.
	Warning Measurement is resumed. The signal outputs and totalizers are not affected. A diagnostic message is generated.

Diagnostic information

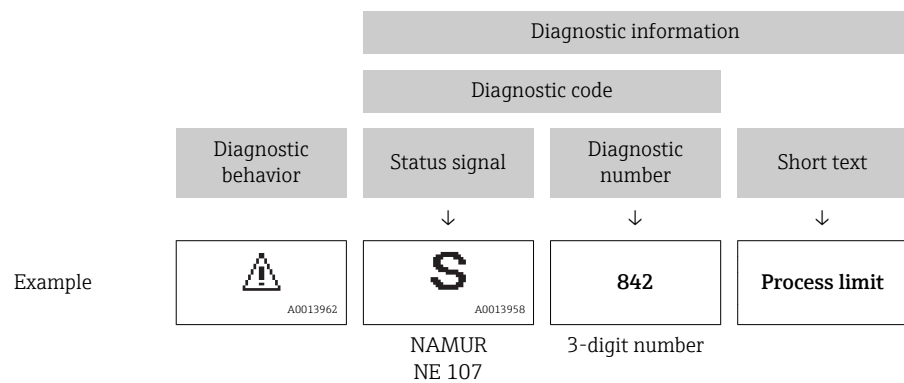
The fault can be identified using the diagnostic information. The short text helps you by providing information about the fault. In addition, the corresponding symbol for the diagnostic behavior is displayed in front of the diagnostic information on the local display.



Operating elements

Key	Meaning
	Plus key <i>In a menu, submenu</i> Opens the message about remedy information.
	Enter key <i>In a menu, submenu</i> Opens the operating menu.

12.3.2 Calling up remedial measures

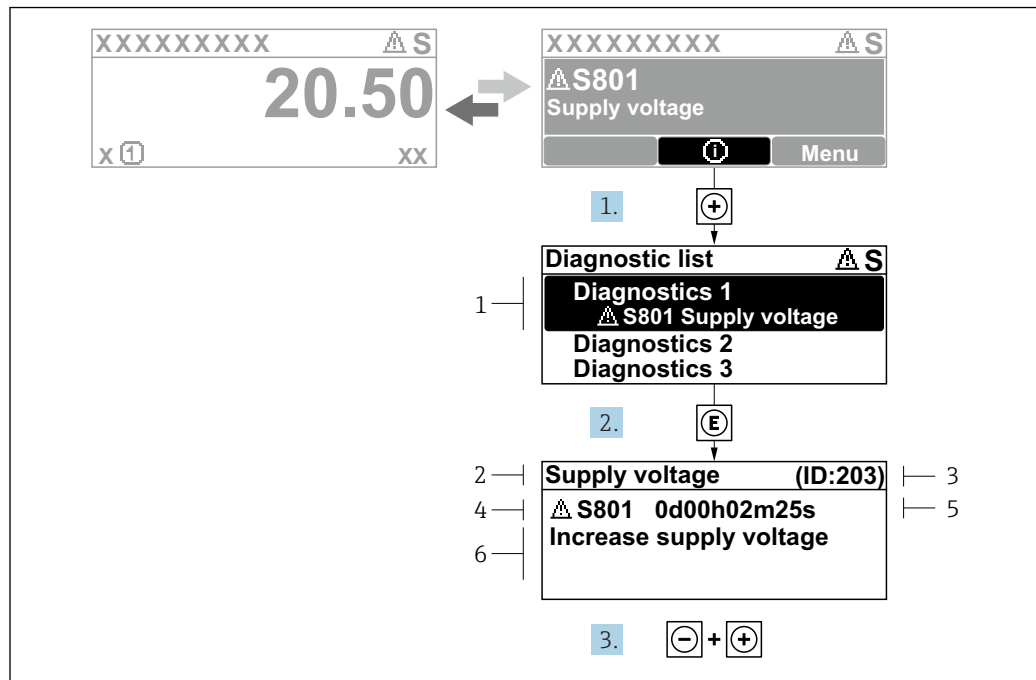

28 Message about remedial measures

- 1 Diagnostic information
- 2 Short text
- 3 Service ID
- 4 Diagnostic behavior with diagnostic code
- 5 Operation time of occurrence
- 6 Remedial measures

1. The user is in the diagnostic message.
Press **+** (ⓘ symbol).
↳ The **Diagnostic list** submenu opens.
2. Select the desired diagnostic event with **+** or **-** and press **E**.
↳ The message about the remedial measures opens.
3. Press **-** + **+** simultaneously.
↳ The message about the remedial measures closes.

The user is in the **Diagnostics** menu at an entry for a diagnostics event, e.g. in the **Diagnostic list** submenu or **Previous diagnostics** parameter.

1. Press **E**.
↳ The message for the remedial measures for the selected diagnostic event opens.
2. Press **-** + **+** simultaneously.
↳ The message for the remedial measures closes.

12.4 Diagnostic information in the Web browser

12.4.1 Diagnostic options

Any faults detected by the measuring device are displayed in the Web browser on the home page once the user has logged on.

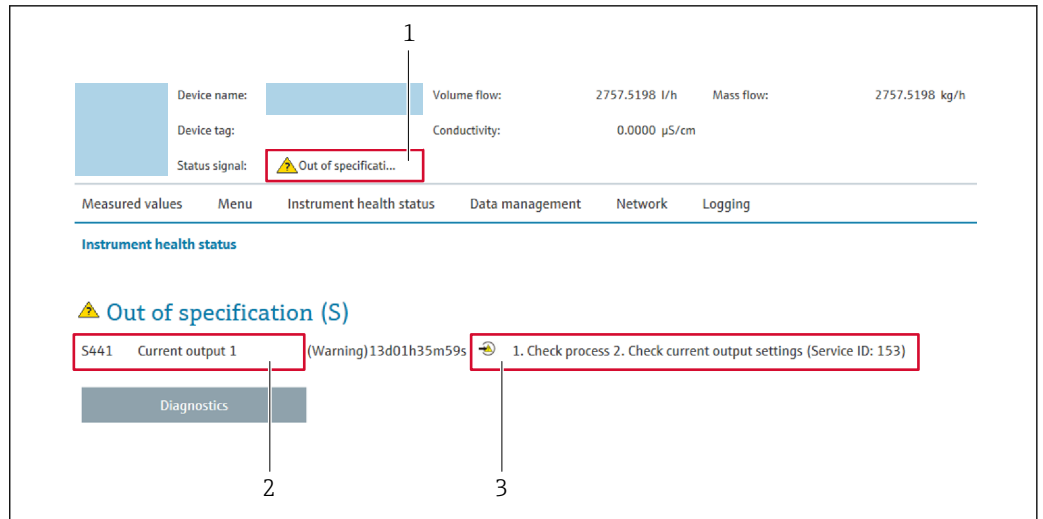

- 1 Status area with status signal
- 2 Diagnostic information → 139
- 3 Remedy information with Service ID

i In addition, diagnostic events which have occurred can be shown in the **Diagnostics** menu:

- Via parameter → 148
- Via submenu → 149

Status signals

The status signals provide information on the state and reliability of the device by categorizing the cause of the diagnostic information (diagnostic event).

Symbol	Meaning
	Failure A device error has occurred. The measured value is no longer valid.
	Function check The device is in service mode (e.g. during a simulation).
	Out of specification The device is operated: Outside its technical specification limits (e.g. outside the process temperature range)
	Maintenance required Maintenance is required. The measured value is still valid.

i The status signals are categorized in accordance with VDI/VDE 2650 and NAMUR Recommendation NE 107.

12.4.2 Calling up remedy information

Remedy information is provided for every diagnostic event to ensure that problems can be rectified quickly. These measures are displayed in red along with the diagnostic event and the related diagnostic information.

12.5 Diagnostic information in FieldCare or DeviceCare

12.5.1 Diagnostic options

Any faults detected by the measuring device are displayed on the home page of the operating tool once the connection has been established.

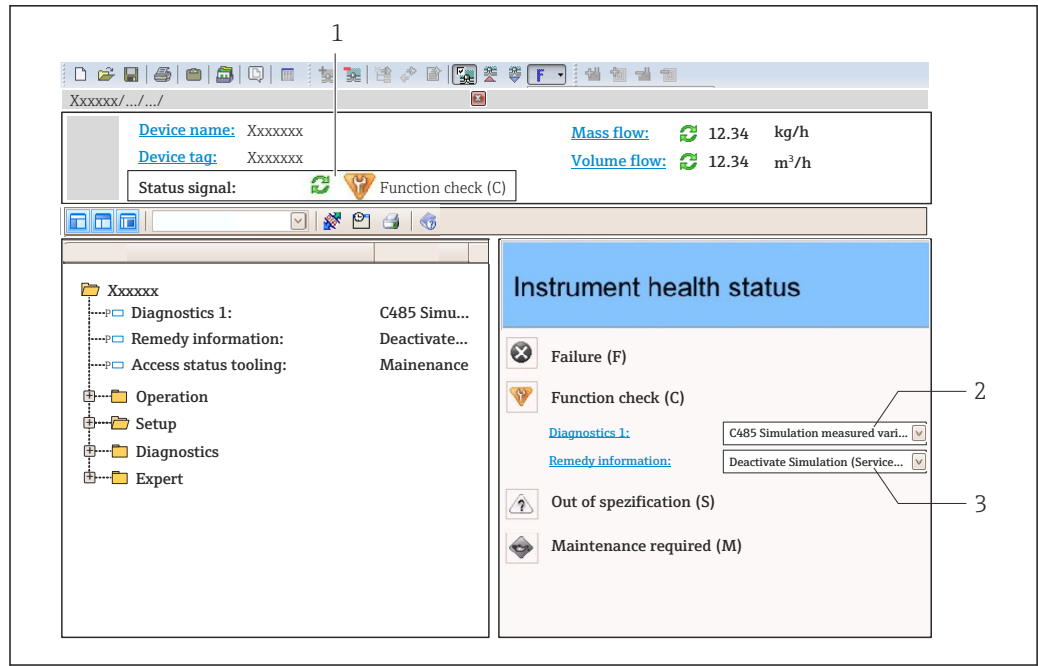

- 1 Status area with status signal → 138
- 2 Diagnostic information → 139
- 3 Remedy information with Service ID

i In addition, diagnostic events which have occurred can be shown in the **Diagnostics** menu:

- Via parameter → 148
- Via submenu → 149

Diagnostic information

The fault can be identified using the diagnostic information. The short text helps you by providing information about the fault. In addition, the corresponding symbol for the diagnostic behavior is displayed in front of the diagnostic information on the local display.

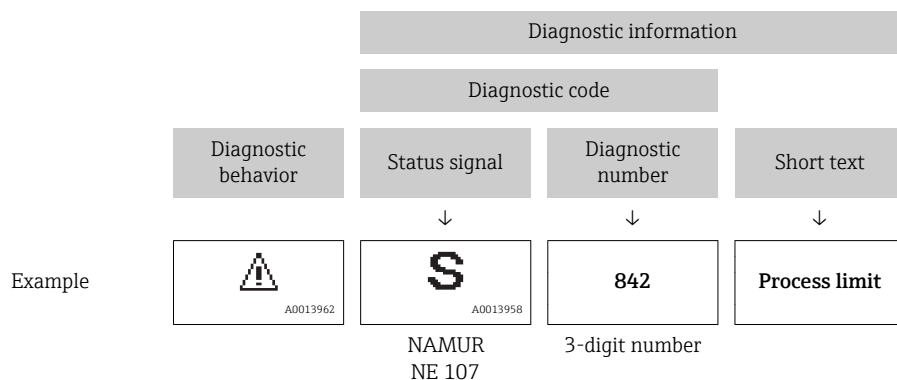

12.5.2 Calling up remedy information

Remedy information is provided for every diagnostic event to ensure that problems can be rectified quickly:

- On the home page
Remedy information is displayed in a separate field below the diagnostics information.
- In the **Diagnostics** menu
Remedy information can be called up in the working area of the user interface.

The user is in the **Diagnostics** menu.

1. Call up the desired parameter.
2. On the right in the working area, mouse over the parameter.
 - ↳ A tool tip with remedy information for the diagnostic event appears.

12.6 Diagnostic information via communication interface

12.6.1 Reading out diagnostic information

Diagnostic information can be read out via Modbus RS485 register addresses.

- Via register address **6821** (data type = string): diagnosis code, e.g. F270
- Via register address **6859** (data type = integer): diagnosis number, e.g. 270

 For an overview of diagnostic events with diagnosis number and diagnosis code
 →  144



12.6.2 Configuring error response mode

The error response mode for Modbus RS485 communication can be configured in the **Communication** submenu using 2 parameters.

Navigation path

Setup → Communication

Parameter overview with brief description

Parameters	Description	Selection	Factory setting
Failure mode	Select measured value output behavior when a diagnostic message occurs via Modbus communication.  This effect of this parameter depends on the option selected in the Assign diagnostic behavior parameter.	<ul style="list-style-type: none"> ▪ NaN value ▪ Last valid value  NaN ≙ not a number	NaN value

12.7 Adapting the diagnostic information

12.7.1 Adapting the diagnostic behavior

Each item of diagnostic information is assigned a specific diagnostic behavior at the factory. The user can change this assignment for specific diagnostic information in the **Diagnostic behavior** submenu.

Expert → System → Diagnostic handling → Diagnostic behavior



You can assign the following options to the diagnostic number as the diagnostic behavior:

Options	Description
Alarm	The device stops measurement. The measured value output via Modbus RS485 and the totalizers assume the defined alarm condition. A diagnostic message is generated. The background lighting changes to red.
Warning	The device continues to measure. The measured value output via Modbus RS485 and the totalizers are not affected. A diagnostic message is generated.

Options	Description
Logbook entry only	The device continues to measure. The diagnostic message is displayed only in the Event logbook submenu (Event list submenu) and is not displayed in alternation with the operational display.
Off	The diagnostic event is ignored, and no diagnostic message is generated or entered.

12.8 Overview of diagnostic information

 The amount of diagnostic information and the number of measured variables affected increase if the measuring device has one or more application packages.

 In the case of some items of diagnostic information, the diagnostic behavior can be changed. Change the diagnostic information →  143

Diagnostic number	Short text	Remedy instructions	Status signal [from the factory]	Diagnostic behavior [from the factory]
Diagnostic of sensor				
022	Temperature sensor defective	Check connection to the temperature sensor	F	Alarm
082	Data storage	1. Check module connections 2. Contact service	F	Alarm
083	Memory content	1. Restart device 2. Restore HistoROM S-DAT backup ('Device reset' parameter) 3. Replace HistoROM S-DAT	F	Alarm
104	Sensor signal path 1 to n	1. Check process conditions 2. Clean or replace transducers 3. Replace sensor electronic module (ISEM)	F	Alarm
105	Downstream transducer path 1 to n defective	1. Check connection to the downstream transducer 2. Replace downstream transducer	F	Alarm
106	Upstream transducer path 1 to n defective	1. Check connection to the upstream transducer 2. Replace upstream transducer	F	Alarm
124	Relative signal strength	1. Check process conditions 2. Clean or replace transducers 3. Replace sensor electronic module (ISEM)	M	Warning
125	Relative sound velocity	1. Check process conditions 2. Clean or replace transducers 3. Replace sensor electronic module (ISEM)	M	Warning
160	Signal path switched off	Contact service	M	Warning ¹⁾
170	Pressure cell connection defective	1. Check connection to pressure cell 2. Replace pressure cell	F	Alarm
171	Ambient temperature too low	Increase ambient temperature	S	Warning
172	Ambient temperature too high	Reduce ambient temperature	S	Warning
173	Pressure cell range exceeded	1. Check process conditions 2. Adapt process pressure	S	Warning
174	Pressure cell electronics defective	Replace pressure cell	F	Alarm
175	Pressure cell deactivated	Enable pressure cell	M	Warning

Diagnostic number	Short text	Remedy instructions	Status signal [from the factory]	Diagnostic behavior [from the factory]
Diagnostic of electronic				
201	Device failure	1. Restart device 2. Contact service	F	Alarm
242	Software incompatible	1. Check software 2. Flash or change main electronics module	F	Alarm
252	Modules incompatible	1. Check electronic modules 2. Check if correct modules are available (e.g. NEx, Ex) 3. Replace electronic modules	F	Alarm
252	Modules incompatible	1. Check if correct electronic modul is plugged 2. Replace electronic module	F	Alarm
262	Sensor electronic connection faulty	1. Check or replace connection cable between sensor electronic module (ISEM) and main electronics 2. Check or replace ISEM or main electronics	F	Alarm
270	Main electronic failure	Change main electronic module	F	Alarm
271	Main electronic failure	1. Restart device 2. Change main electronic module	F	Alarm
272	Main electronic failure	1. Restart device 2. Contact service	F	Alarm
273	Main electronic failure	Change electronic	F	Alarm
275	I/O module 1 to n defective	Change I/O module	F	Alarm
276	I/O module 1 to n faulty	1. Restart device 2. Change I/O module	F	Alarm
281	Electronic initialization	Firmware update active, please wait!	F	Alarm
283	Memory content	1. Reset device 2. Contact service	F	Alarm
302	Device verification active	Device verification active, please wait.	C	Warning
303	I/O 1 to n configuration changed	1. Apply I/O module configuration (parameter 'Apply I/O configuration') 2. Afterwards reload device description and check wiring	M	Warning
311	Electronic failure	1. Do not reset device 2. Contact service	M	Warning
332	Writing in HistoROM backup failed	Replace user interface board Ex d/XP: replace transmitter	F	Alarm
361	I/O module 1 to n faulty	1. Restart device 2. Check electronic modules 3. Change I/O Modul or main electronics	F	Alarm
372	Sensor electronic (ISEM) faulty	1. Restart device 2. Check if failure recurs 3. Replace sensor electronic module (ISEM)	F	Alarm
373	Sensor electronic (ISEM) faulty	1. Transfer data or reset device 2. Contact service	F	Alarm

Diagnostic number	Short text	Remedy instructions	Status signal [from the factory]	Diagnostic behavior [from the factory]
375	I/O- 1 to n communication failed	1. Restart device 2. Check if failure recurs 3. Replace module rack inclusive electronic modules	F	Alarm
378	Supply voltage ISEM faulty	Check supply voltage to the ISEM	F	Alarm
382	Data storage	1. Insert T-DAT 2. Replace T-DAT	F	Alarm
383	Memory content	1. Restart device 2. Delete T-DAT via 'Reset device' parameter 3. Replace T-DAT	F	Alarm
384	Transmitter circuit	1. Restart device 2. Check if failure recurs 3. Replace sensor electronic module (ISEM)	F	Alarm
385	Amplifier circuit	1. Restart device 2. Check if failure recurs 3. Replace sensor electronic module (ISEM)	F	Alarm
386	Time of flight	1. Restart device 2. Check if failure recurs 3. Replace sensor electronic module (ISEM)	F	Alarm
387	HistoROM data faulty	Contact service organization	F	Alarm
Diagnostic of configuration				
330	Flash file invalid	1. Update firmware of device 2. Restart device	M	Warning
331	Firmware update failed	1. Update firmware of device 2. Restart device	F	Warning
410	Data transfer	1. Check connection 2. Retry data transfer	F	Alarm
412	Processing download	Download active, please wait	C	Warning
431	Trim 1 to n	Carry out trim	C	Warning
437	Configuration incompatible	1. Restart device 2. Contact service	F	Alarm
438	Dataset	1. Check data set file 2. Check device configuration 3. Up- and download new configuration	M	Warning
441	Current output 1 to n	1. Check process 2. Check current output settings	S	Warning ¹⁾
442	Frequency output 1 to n	1. Check process	S	Warning ¹⁾
442	Frequency output 1 to n	2. Check frequency output settings	S	Warning
443	Pulse output 1 to n	1. Check process 2. Check pulse output settings	S	Warning ¹⁾
444	Current input 1 to n	1. Check process 2. Check current input settings	S	Warning ¹⁾
452	Calculation error	1. Check device configuration 2. Check process conditions	S	Warning ¹⁾
453	Flow override	Deactivate flow override	C	Warning

Diagnostic number	Short text	Remedy instructions	Status signal [from the factory]	Diagnostic behavior [from the factory]
484	Failure mode simulation	Deactivate simulation	C	Alarm
485	Measured variable simulation	Deactivate simulation	C	Warning
486	Current input 1 to n simulation	Deactivate simulation	C	Warning
491	Current output 1 to n simulation	Deactivate simulation	C	Warning
492	Simulation frequency output 1 to n	Deactivate simulation frequency output	C	Warning
493	Simulation pulse output 1 to n	Deactivate simulation pulse output	C	Warning
494	Switch output simulation 1 to n	Deactivate simulation switch output	C	Warning
495	Diagnostic event simulation	Deactivate simulation	C	Warning
496	Status input simulation	Deactivate simulation status input	C	Warning
502	CT activation/deactivation failed	Follow the sequence of the custody transfer activation/deactivation: First authorized user login, then set the DIP switch on the main electronic module	C	Warning
520	I/O 1 to n hardware configuration invalid	1. Check I/O hardware configuration 2. Replace wrong I/O module 3. Plug the module of double pulse output on correct slot	F	Alarm
537	Configuration	1. Check IP addresses in network 2. Change IP address	F	Warning
538	Flow computer configuration incorrect	Check input value (pressure, temperature)	S	Warning
539	Flow computer configuration incorrect	1. Check input value (pressure, temperature) 2. Check allowed values of the medium properties	S	Alarm
540	Custody transfer mode failed	1. Power off device and toggle DIP switch 2. Deactivate custody transfer mode 3. Reactivate custody transfer mode 4. Check electronic components	F	Alarm
541	Flow computer configuration incorrect	Check entered reference value using the document Operating Instructions	S	Warning
543	Double pulse output	1. Check process 2. Check pulse output settings	S	Warning
593	Double pulse output simulation	Deactivate simulation pulse output	C	Warning
594	Relay output simulation	Deactivate simulation switch output	C	Warning
599	Custody transfer logbook full	1. Deactivate custody transfer mode 2. Clear custody transfer logbook (all 30 entries) 3. Activate custody transfer mode	F	Warning
Diagnostic of process				
803	Current loop	1. Check wiring 2. Change I/O module	F	Alarm

Diagnostic number	Short text	Remedy instructions	Status signal [from the factory]	Diagnostic behavior [from the factory]
832	Electronic temperature too high	Reduce ambient temperature	S	Warning ¹⁾
833	Electronic temperature too low	Increase ambient temperature	S	Warning ¹⁾
834	Process temperature too high	Reduce process temperature	S	Warning ¹⁾
835	Process temperature too low	Increase process temperature	S	Warning ¹⁾
836	Process pressure	Reduce process pressure	S	Alarm
837	Process pressure	Increase process pressure	S	Warning ¹⁾
840	Sensor range	Check flow velocity	S	Warning ¹⁾
842	Process limit	Low flow cut off active! 1. Check low flow cut off configuration	S	Warning ¹⁾
870	Measuring inaccuracy increased	1. Check process conditions 2. Increase flow velocity	S	Warning ¹⁾
881	Sensor signal path 1 to n	1. Check process conditions 2. Clean or replace transducers 3. Replace sensor electronic module (ISEM)	M	Warning
882	Input signal	1. Check input configuration 2. Check external device 3. Check process conditions	F	Alarm
930	Sound velocity too high	1. Check process conditions 2. Clean or replace transducers 3. Replace sensor electronic module (ISEM)	S	Alarm
931	Sound velocity too low	1. Check process conditions 2. Clean or replace transducers 3. Replace sensor electronic module (ISEM)	S	Alarm
953	Asymmetry noise signal too high path 1 to n	1. Check process conditions 2. Clean or replace transducers 3. Replace sensor electronic module (ISEM)	M	Warning ¹⁾
954	Sound velocity deviation too high	1. Check medium configuration 2. Check process conditions 3. Clean or replace transducers	S	Warning ¹⁾

1) Diagnostic behavior can be changed.

12.9 Pending diagnostic events

The **Diagnostics** menu allows the user to view the current diagnostic event and the previous diagnostic event separately.



To call up the measures to rectify a diagnostic event:

- Via local display → 140
- Via Web browser → 141
- Via "FieldCare" operating tool → 142
- Via "DeviceCare" operating tool → 142



Other pending diagnostic events can be displayed in the **Diagnostic list** submenu → 149

Navigation
 "Diagnostics" menu

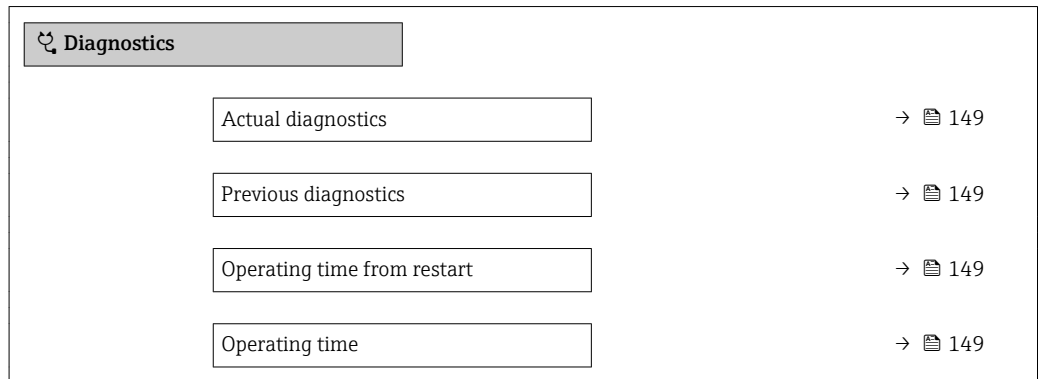

Parameter overview with brief description

Parameter	Prerequisite	Description	User interface
Actual diagnostics	A diagnostic event has occurred.	Shows the current occurred diagnostic event along with its diagnostic information.  If two or more messages occur simultaneously, the message with the highest priority is shown on the display.	Symbol for diagnostic behavior, diagnostic code and short message.
Previous diagnostics	Two diagnostic events have already occurred.	Shows the diagnostic event that occurred prior to the current diagnostic event along with its diagnostic information.	Symbol for diagnostic behavior, diagnostic code and short message.
Operating time from restart	–	Shows the time the device has been in operation since the last device restart.	Days (d), hours (h), minutes (m) and seconds (s)
Operating time	–	Indicates how long the device has been in operation.	Days (d), hours (h), minutes (m) and seconds (s)

12.10 Diagnostic list

Up to 5 currently pending diagnostic events can be displayed in the **Diagnostic list** submenu along with the associated diagnostic information. If more than 5 diagnostic events are pending, the events with the highest priority are shown on the display.

Navigation path

Diagnostics → Diagnostic list

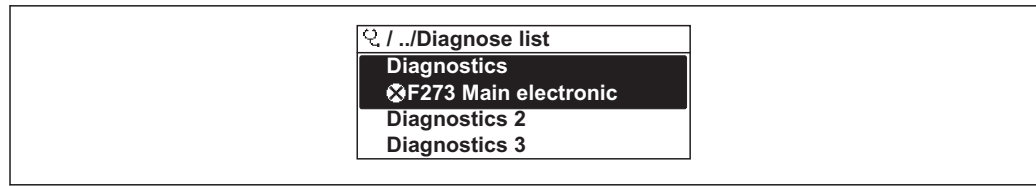

A0014006-EN

29 Taking the example of the local display

i To call up the measures to rectify a diagnostic event:

- Via local display → 140
- Via Web browser → 141
- Via "FieldCare" operating tool → 142
- Via "DeviceCare" operating tool → 142

12.11 Event logbook

12.11.1 Reading out the event logbook

A chronological overview of the event messages that have occurred is provided in the **Events list** submenu.

Navigation path

Diagnostics menu → **Event logbook** submenu → Event list

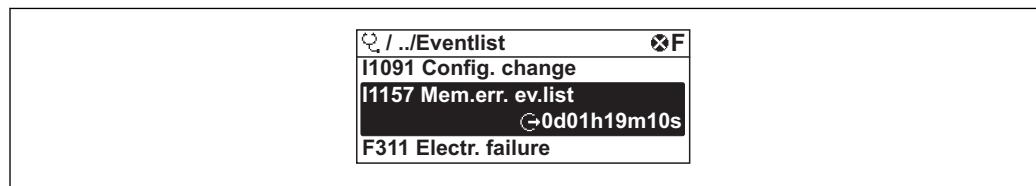

A0014006-EN

30 Taking the example of the local display

- A maximum of 20 event messages can be displayed in chronological order.
- If the **Extended HistoROM** application package (order option) is enabled in the device, the event list can contain up to 100 entries.

The event history includes entries for:

- Diagnostic events → 144
- Information events → 151

In addition to the operation time of its occurrence, each event is also assigned a symbol that indicates whether the event has occurred or is ended:

- Diagnostic event
 - ☹: Occurrence of the event
 - ☺: End of the event
- Information event
 - ☹: Occurrence of the event

i To call up the measures to rectify a diagnostic event:

- Via local display → 140
- Via Web browser → 141
- Via "FieldCare" operating tool → 142
- Via "DeviceCare" operating tool → 142

i For filtering the displayed event messages → 151

12.11.2 Filtering the event logbook

Using the **Filter options** parameter you can define which category of event message is displayed in the **Events list** submenu.

Navigation path

Diagnostics → Event logbook → Filter options

Filter categories

- All
- Failure (F)
- Function check (C)
- Out of specification (S)
- Maintenance required (M)
- Information (I)

12.11.3 Overview of information events

Unlike a diagnostic event, an information event is displayed in the event logbook only and not in the diagnostic list.

Info number	Info name
I1000	----- (Device ok)
I1079	Sensor changed
I1089	Power on
I1090	Configuration reset
I1091	Configuration changed
I1092	HistoROM backup deleted
I1137	Electronic changed
I1151	History reset
I1155	Reset electronic temperature
I1156	Memory error trend
I1157	Memory error event list
I1256	Display: access status changed
I1264	Safety sequence aborted
I1278	I/O module restarted
I1327	Zero point adjust failed signal path
I1335	Firmware changed
I1361	Web server: login failed
I1397	Fieldbus: access status changed
I1398	CDI: access status changed
I1444	Device verification passed
I1445	Device verification failed
I1457	Measurement error verification failed
I1459	I/O module verification failed
I1461	Sensor verification failed
I1462	Sensor electronic module verific. failed
I1512	Download started
I1513	Download finished
I1514	Upload started

Info number	Info name
I1515	Upload finished
I1517	Custody transfer active
I1518	Custody transfer inactive
I1554	Safety sequence started
I1555	Safety sequence confirmed
I1556	Safety mode off
I1618	I/O module 2 replaced
I1619	I/O module 3 replaced
I1621	I/O module 4 replaced
I1622	Calibration changed
I1624	Reset all totalizers
I1625	Write protection activated
I1626	Write protection deactivated
I1627	Web server: login successful
I1628	Display: login successful
I1629	CDI: login successful
I1631	Web server access changed
I1632	Display: login failed
I1633	CDI: login failed
I1634	Reset to factory settings
I1635	Reset to delivery settings
I1639	Max. switch cycles number reached
I1643	Custody transfer logbook cleared
I1649	Hardware write protection activated
I1650	Hardware write protection deactivated
I1651	Custody transfer parameter changed
I1712	New flash file received
I1725	Sensor electronic module (ISEM) changed
I1726	Configuration backup failed

12.12 Resetting the measuring device

Using the **Device reset** parameter (→  115) it is possible to reset the entire device configuration or some of the configuration to a defined state.

12.12.1 Function scope of the "Device reset" parameter

Options	Description
Cancel	No action is executed and the user exits the parameter.
To delivery settings	Every parameter for which a customer-specific default setting was ordered is reset to this customer-specific value. All other parameters are reset to the factory setting.

Options	Description
Restart device	The restart resets every parameter whose data are in the volatile memory (RAM) to the factory setting (e.g. measured value data). The device configuration remains unchanged.
Restore S-DAT backup	Restore the data that are saved on the S-DAT. The data record is restored from the electronics memory to the S-DAT.  This option is displayed only in an alarm condition.

12.13 Device information

The **Device information** submenu contains all parameters that display different information for device identification.





Navigation

"Diagnostics" menu → Device information

► Device information	
Device tag	→ ⓘ 153
Serial number	→ ⓘ 153
Firmware version	→ ⓘ 153
Device name	→ ⓘ 153
Order code	→ ⓘ 154
Extended order code 1	→ ⓘ 154
Extended order code 2	→ ⓘ 154
Extended order code 3	→ ⓘ 154
ENP version	→ ⓘ 154

Parameter overview with brief description

Parameter	Description	User interface	Factory setting
Device tag	Shows name of measuring point.	Max. 32 characters, such as letters, numbers or special characters (e.g. @, %, /).	Prosonic Flow
Serial number	Shows the serial number of the measuring device.	Max. 11-digit character string comprising letters and numbers.	–
Firmware version	Shows the device firmware version installed.	Character string in the format xx.yy.zz	–
Device name	Shows the name of the transmitter.  The name can be found on the nameplate of the transmitter.	Prosonic Flow 300	–

Parameter	Description	User interface	Factory setting
Order code	Shows the device order code.  The order code can be found on the nameplate of the sensor and transmitter in the "Order code" field.	Character string composed of letters, numbers and certain punctuation marks (e.g. /).	–
Extended order code 1	Shows the 1st part of the extended order code.  The extended order code can also be found on the nameplate of the sensor and transmitter in the "Ext. ord. cd." field.	Character string	–
Extended order code 2	Shows the 2nd part of the extended order code.  The extended order code can also be found on the nameplate of the sensor and transmitter in the "Ext. ord. cd." field.	Character string	–
Extended order code 3	Shows the 3rd part of the extended order code.  The extended order code can also be found on the nameplate of the sensor and transmitter in the "Ext. ord. cd." field.	Character string	–
ENP version	Shows the version of the electronic nameplate (ENP).	Character string	2.02.00

12.14 Firmware history

Release date	Firmware version	Order code for "Firmware version"	Firmware changes	Documentation type	Documentation
08.2019	01.00.zz	Option 76	Original firmware	Operating Instructions	BA01835D/06/EN/01.19

 It is possible to flash the firmware to the current version or the previous version using the service interface.

 For the compatibility of the firmware version with the previous version, the installed device description files and operating tools, observe the information about the device in the "Manufacturer's information" document.

 The manufacturer's information is available:

- In the Download Area of the Endress+Hauser web site: www.endress.com → Downloads
- Specify the following details:
 - Text search: Manufacturer's information
 - Media type: Documentation – Technical Documentation

13 Maintenance

13.1 Maintenance tasks

No special maintenance work is required.

13.1.1 Exterior cleaning

When cleaning the exterior of measuring devices, always use cleaning agents that do not attack the surface of the housing or the seals.

13.2 Measuring and test equipment

Endress+Hauser offers a wide variety of measuring and test equipment, such as W@M or device tests.

 Your Endress+Hauser Sales Center can provide detailed information on the services.

List of some of the measuring and testing equipment: →  158

13.3 Endress+Hauser services

Endress+Hauser offers a wide variety of services for maintenance such as recalibration, maintenance service or device tests.

 Your Endress+Hauser Sales Center can provide detailed information on the services.

14 Repair

14.1 General notes

14.1.1 Repair and conversion concept

The Endress+Hauser repair and conversion concept provides for the following:



- The measuring devices have a modular design.
- Spare parts are grouped into logical kits with the associated Installation Instructions.
- Repairs are carried out by Endress+Hauser Service or by appropriately trained customers.
- Certified devices can only be converted to other certified devices by Endress+Hauser Service or at the factory.

14.1.2 Notes for repair and conversion

For repair and modification of a measuring device, observe the following notes:

- ▶ Use only original Endress+Hauser spare parts.
- ▶ Carry out the repair according to the Installation Instructions.
- ▶ Observe the applicable standards, federal/national regulations, Ex documentation (XA) and certificates.
- ▶ Document every repair and each conversion and enter them into the *W@M* life cycle management database.

14.2 Spare parts

 Measuring device serial number:
Can be read out via the **Serial number** parameter (→  153) in the **Device information** submenu.

14.3 Endress+Hauser services

Endress+Hauser offers a wide range of services.

 Your Endress+Hauser Sales Center can provide detailed information on the services.

14.4 Return

The requirements for safe device return can vary depending on the device type and national legislation.

1. Refer to the website for more information:
<http://www.endress.com/support/return-material>
2. Return the device if repairs or a factory calibration are required, or if the wrong device was ordered or delivered.

14.5 Disposal

14.5.1 Removing the measuring device

1. Switch off the device.

⚠ WARNING**Danger to persons from process conditions.**

- ▶ Beware of hazardous process conditions such as pressure in the measuring device, high temperatures or aggressive fluids.
2. Carry out the mounting and connection steps from the "Mounting the measuring device" and "Connecting the measuring device" sections in reverse order. Observe the safety instructions.

14.5.2 Disposing of the measuring device

⚠ WARNING**Danger to personnel and environment from fluids that are hazardous to health.**

- ▶ Ensure that the measuring device and all cavities are free of fluid residues that are hazardous to health or the environment, e.g. substances that have permeated into crevices or diffused through plastic.

Observe the following notes during disposal:











- ▶ Observe valid federal/national regulations.
- ▶ Ensure proper separation and reuse of the device components.

15 Accessories



Various accessories, which can be ordered with the device or subsequently from Endress+Hauser, are available for the device. Detailed information on the order code in question is available from your local Endress+Hauser sales center or on the product page of the Endress+Hauser website: www.endress.com.

15.1 Device-specific accessories









15.1.1 For the transmitter

Accessories	Description
Proline 300 transmitter	<p>Transmitter for replacement or storage. Use the order code to define the following specifications:</p> <ul style="list-style-type: none"> ▪ Approvals ▪ Output ▪ Input ▪ Display/operation ▪ Housing ▪ Software <p> Order code: 9X3BXX</p> <p> Installation Instructions EA01263D</p>
Remote display and operating module DKX001	<ul style="list-style-type: none"> ▪ If ordered directly with the measuring device: Order code for "Display; operation", option O "Remote display 4-line illum.; 10 m (30 ft) Cable; touch control" ▪ If ordered separately: <ul style="list-style-type: none"> ▪ Measuring device: order code for "Display; operation", option M "W/o, prepared for remote display" ▪ DKX001: Via the separate product structure DKX001 ▪ If ordered subsequently: DKX001: Via the separate product structure DKX001 <p>Mounting bracket for DKX001</p> <ul style="list-style-type: none"> ▪ If ordered directly: order code for "Accessory enclosed", option RA "Mounting bracket, pipe 1"/2" ▪ If ordered subsequently: order number: 71340960 <p>Connecting cable (replacement cable) Via the separate product structure: DKX002</p> <p> Further information on display and operating module DKX001 →  180.</p> <p> Special Documentation SD01763D</p>
External WLAN antenna	<p>External WLAN antenna with 1.5 m (59.1 in) connecting cable and two angle brackets. Order code for "Accessory enclosed", option P8 "Wireless antenna wide area".</p> <p> <ul style="list-style-type: none"> ▪ The external WLAN antenna is not suitable for use in hygienic applications. ▪ Further information on the WLAN interface →  66. </p> <p> Order number: 71351317</p> <p> Installation Instructions EA01238D</p>
Protective cover	<p>Is used to protect the measuring device from the effects of the weather: e.g. rainwater, excess heating from direct sunlight.</p> <p> Order number: 71343505</p> <p> Installation Instructions EA01160D</p>



15.2 Communication-specific accessories

Accessories	Description
Field Xpert SMT70	<p>The Field Xpert SMT70 tablet PC for device configuration enables mobile plant asset management in hazardous and non-hazardous areas. It is suitable for commissioning and maintenance staff to manage field instruments with a digital communication interface and to record progress.</p> <p>This tablet PC is designed as an all-in-one solution with a preinstalled driver library and is an easy-to-use, touch-sensitive tool which can be used to manage field instruments throughout their entire life cycle.</p> <ul style="list-style-type: none">  Technical Information TI01342S  Operating Instructions BA01709S  Product page: www.endress.com/smt70

15.3 Service-specific accessories

Accessories	Description
Applicator	<p>Software for selecting and sizing Endress+Hauser measuring devices:</p> <ul style="list-style-type: none">  Choice of measuring devices for industrial requirements  Calculation of all the necessary data for identifying the optimum flowmeter: e.g. nominal diameter, pressure loss, flow velocity and accuracy.  Graphic illustration of the calculation results  Determination of the partial order code, administration, documentation and access to all project-related data and parameters over the entire life cycle of a project. <p>Applicator is available:</p> <ul style="list-style-type: none">  Via the Internet: https://portal.endress.com/webapp/applicator  As a downloadable DVD for local PC installation.
W@M	<p>W@M Life Cycle Management</p> <p>Improved productivity with information at your fingertips. Data relevant to a plant and its components is generated from the first stages of planning and during the asset's complete life cycle.</p> <p>W@M Life Cycle Management is an open and flexible information platform with online and on-site tools. Instant access for your staff to current, in-depth data shortens your plant's engineering time, speeds up procurement processes and increases plant uptime.</p> <p>Combined with the right services, W@M Life Cycle Management boosts productivity in every phase. For more information, visit www.endress.com/lifecyclemanagement</p>
FieldCare	<p>FDT-based plant asset management tool from Endress+Hauser.</p> <p>It can configure all smart field units in your system and helps you manage them. By using the status information, it is also a simple but effective way of checking their status and condition.</p> <ul style="list-style-type: none">  Operating Instructions BA00027S and BA00059S
DeviceCare	<p>Tool to connect and configure Endress+Hauser field devices.</p> <ul style="list-style-type: none">  Innovation brochure IN01047S

15.4 System components

Accessories	Description
Memograph M graphic data manager	<p>The Memograph M graphic data manager provides information on all the relevant measured variables. Measured values are recorded correctly, limit values are monitored and measuring points analyzed. The data are stored in the 256 MB internal memory and also on a SD card or USB stick.</p> <ul style="list-style-type: none">  Technical Information TI00133R  Operating Instructions BA00247R

16 Technical data

16.1 Application

Depending on the version ordered, the measuring device can also measure potentially explosive, flammable, poisonous and oxidizing media.

To ensure that the device remains in proper operating condition for its service life, use the measuring device only for media against which the process-wetted materials are sufficiently resistant.

16.2 Function and system design

Measuring principle	Proline Prosonic Flow uses a measurement method based on the transit time difference.
Measuring system	<p>The device consists of a transmitter and a sensor.</p> <p>The device is available as a compact version: The transmitter and sensor form a mechanical unit.</p> <p>For information on the structure of the device →  15</p>

16.3 Input

Measured variable

Direct measured variables

- Flow velocity
- Sound velocity
- Process temperature (optional): based on the measured resistance of a platinum measuring resistor
- Process temperature (optional): based on the measured output voltage of a Wheatstone bridge, which is sensitive to strain

Calculated measured variables

- Volume flow (operation)
- Corrected volume flow (corrected/standard volume flow)
- Mass flow

Optional measured variables (can be ordered)

Order code for "Application package", option EF "Advanced gas analysis"

- Single gas
- Gas mixture
- Coal gas/biogas
- Natural gas – standardized calculation
- Natural gas – using sound velocity

 The measured variables (gas properties) that are available for order depend on the gas type.

Measuring range

$v = 0.3$ to 40 m/s (0.98 to 131.2 ft/s) with the specified accuracy

Flow characteristic values in SI units



Nominal diameter		Recommended flow	Factory settings		
			Full scale value current output	Pulse Value	Low flow cut off (v ~ 0.1 m/s)
[mm]	[in]	[m ³ /h]	[m ³ /h]	[m ³ /pulse]	[m ³ /h]
25	1	0.50 to 67	50	0.007	0.17
50	2	2.05 to 274	210	0.03	0.68
80	3	4.60 to 614	460	0.06	1.5
100	4	8 to 1064	800	0.1	2.7
150	6	18.1 to 2414	1800	0.3	6.0
200	8	32 to 4235	3200	0.4	11
250	10	50 to 6662	5000	0.7	17
300	12	71 to 9426	7100	1.0	24

Flow characteristic values in US units

Nominal diameter		Recommended flow	Factory settings		
			Full scale value current output	Pulse Value	Low flow cut off (v ~ 0.1 m/s)
[in]	[mm]	[ft ³ /hr]	[ft ³ /hr]	[ft ³ /pulse]	[ft ³ /hr]
1	25	17.7 to 2358	1800	0.2	5.9
2	50	73 to 9668	7300	1	24

Nominal diameter		Recommended flow	Factory settings		
			Full scale value current output	Pulse Value	Low flow cut off (v ~ 0.1 m/s)
[in]	[mm]	[ft ³ /hr]	[ft ³ /hr]	[ft ³ /pulse]	[ft ³ /hr]
3	80	163 to 21 694	16 000	2	54
4	100	282 to 37 579	28 000	4	94
6	150	639 to 85 253	64 000	9	213
8	200	1 122 to 149 544	110 000	16	374
10	250	1 764 to 235 259	180 000	25	588
12	300	2 497 to 332 890	250 000	35	832

Recommended measuring range

 Flow limit →  174

Operable flow range 133 : 1

Input signal

External measured values

To increase the accuracy of certain measured variables or to calculate the corrected volume flow for gases, the use of the integrated pressure and temperature measurement function is recommended:

- Temperature measurement to increase accuracy (order code for "Measuring tube; transducer; sensor version", option AB "316L; titanium gr. 2; integrated temperature measurement")
- Temperature and pressure measurement to increase accuracy (order code for "Measuring tube; transducer; sensor version", option AC "316L; titanium gr. 2; integrated pressure + temperature measurement")

The measuring device provides optional interfaces that enable the transmission of externally measured variables (temperature, pressure, gas composition ¹⁾) into the measuring device:

- Analog inputs 4-20 mA
- Digital inputs (via HART input or Modbus)

Pressure values can be transmitted as absolute or gauge pressure. For gauge pressure, the atmospheric pressure must be known or specified by the customer.

 Various pressure transmitters and temperature measuring devices can be ordered from Endress+Hauser: see "Accessories" section →  159

Current input

The measured values are written from the automation system to the measuring device via the current input →  163.

Digital communication

The measured values are written from the automation system to the measuring device via Modbus RS485.

1) The gas composition can be transmitted only using Modbus.

Current input 0/4 to 20 mA

Current input	0/4 to 20 mA (active/passive)
Current span	<ul style="list-style-type: none"> ▪ 4 to 20 mA (active) ▪ 0/4 to 20 mA (passive)
Resolution	1 μ A
Voltage drop	Typically: 0.6 to 2 V for 3.6 to 22 mA (passive)
Maximum input voltage	\leq 30 V (passive)
Open-circuit voltage	\leq 28.8 V (active)
Possible input variables	<ul style="list-style-type: none"> ▪ Pressure ▪ Temperature

Status input

Maximum input values	<ul style="list-style-type: none"> ▪ DC -3 to 30 V ▪ If status input is active (ON): $R_i > 3 \text{ k}\Omega$
Response time	Adjustable: 5 to 200 ms
Input signal level	<ul style="list-style-type: none"> ▪ Low signal: DC -3 to +5 V ▪ High signal: DC 12 to 30 V
Assignable functions	<ul style="list-style-type: none"> ▪ Off ▪ Reset the individual totalizers separately ▪ Reset all totalizers ▪ Flow override

16.4 Output

Output signal

Modbus RS485



Physical interface	RS485 in accordance with EIA/TIA-485 standard
Terminating resistor	Integrated, can be activated via DIP switches

Current output 4 to 20 mA

Signal mode	Can be set to: <ul style="list-style-type: none"> ■ Active ■ Passive
Current range	Can be set to: <ul style="list-style-type: none"> ■ 4 to 20 mA NAMUR ■ 4 to 20 mA US ■ 4 to 20 mA ■ 0 to 20 mA (only with signal mode active) ■ Fixed current value
Maximum output values	22.5 mA
Open-circuit voltage	DC 28.8 V (active)
Maximum input voltage	DC 30 V (passive)
Load	0 to 700 Ω
Resolution	0.38 μA
Damping	Configurable: 0 to 999 s
Assignable measured variables	<ul style="list-style-type: none"> ■ Volume flow ■ Corrected volume flow ■ Mass flow ■ Energy flow ■ Sound velocity ■ Flow velocity ■ Electronics temperature ■ Methane fraction ¹⁾ ■ Molar mass ■ Density ■ Dynamic viscosity ■ Calorific value ■ Wobbe index ■ Pressure ²⁾ ■ Temperature ³⁾ <p> The range of options increases if the measuring device has one or more application packages.</p>

- 1) Only for the order code for "Application package", option EF "Advanced gas analysis" and with the appropriate configuration
- 2) Only for the order code for "Measuring tube; Transducer; Sensor version", option AC "316L; titanium gr. 2; pressure + temperature measurement integrated"
- 3) Only for the order code for "Measuring tube; Transducer; Sensor version", option AB "316L; titanium gr. 2; temperature measurement integrated" or AC "316L; titanium gr. 2; pressure + temperature measurement integrated"

Pulse/frequency/switch output

Function	Can be set to pulse, frequency or switch output
Version	Open collector Can be set to: <ul style="list-style-type: none"> ▪ Active ▪ Passive  Ex-i, passive
Maximum input values	DC 30 V, 250 mA (passive)
Open-circuit voltage	DC 28.8 V (active)
Voltage drop	For 22.5 mA: ≤ DC 2 V
Pulse output	
Maximum input values	DC 30 V, 250 mA (passive)
Maximum output current	22.5 mA (active)
Open-circuit voltage	DC 28.8 V (active)
Pulse width	Configurable: 0.05 to 2 000 ms
Maximum pulse rate	10 000 Impulse/s
Pulse value	Adjustable
Assignable measured variables	<ul style="list-style-type: none"> ▪ Volume flow ▪ Corrected volume flow ▪ Mass flow ▪ Energy flow
Frequency output	
Maximum input values	DC 30 V, 250 mA (passive)
Maximum output current	22.5 mA (active)
Open-circuit voltage	DC 28.8 V (active)
Output frequency	Adjustable: end value frequency 2 to 10 000 Hz ($f_{\max} = 12\,500$ Hz)
Damping	Configurable: 0 to 999 s
Pulse/pause ratio	1:1
Assignable measured variables	<ul style="list-style-type: none"> ▪ Volume flow ▪ Corrected volume flow ▪ Mass flow ▪ Energy flow ▪ Sound velocity ▪ Flow velocity ▪ Electronics temperature ▪ Methane fraction ¹⁾ ▪ Molar mass ▪ Density ▪ Dynamic viscosity ▪ Calorific value ▪ Wobbe index ▪ Pressure ²⁾ ▪ Temperature ³⁾  The range of options increases if the measuring device has one or more application packages.
Switch output	
Maximum input values	DC 30 V, 250 mA (passive)
Open-circuit voltage	DC 28.8 V (active)
Switching behavior	Binary, conductive or non-conductive
Switching delay	Configurable: 0 to 100 s

Number of switching cycles	Unlimited
Assignable functions	<ul style="list-style-type: none"> ■ Off ■ On ■ Diagnostic behavior ■ Limit value <ul style="list-style-type: none"> ■ Volume flow ■ Corrected volume flow ■ Mass flow ■ Energy flow ■ Flow velocity ■ Electronics temperature ■ Sound velocity ■ Methane fraction ■ Molar mass ■ Density ■ Dynamic viscosity ■ Calorific value ■ Wobbe index ■ Pressure ■ Temperature ■ Totalizer 1-3 ■ Flow direction monitoring ■ Status <ul style="list-style-type: none"> Low flow cut off <p> The range of options increases if the measuring device has one or more application packages.</p>

- 1) Only for the order code for "Application package", option EF "Advanced gas analysis" and with the appropriate configuration
- 2) Only for the order code for "Measuring tube; Transducer; Sensor version", option AC "316L; titanium gr. 2; pressure + temperature measurement integrated"
- 3) Only for the order code for "Measuring tube; Transducer; Sensor version", option AB "316L; titanium gr. 2; temperature measurement integrated" or AC "316L; titanium gr. 2; pressure + temperature measurement integrated"

Double pulse output

Function	Double pulse
Version	Open collector Can be set to: <ul style="list-style-type: none"> ■ Active ■ Passive ■ Passive NAMUR
Maximum input values	DC 30 V, 250 mA (passive)
Open-circuit voltage	DC 28.8 V (active)
Voltage drop	For 22.5 mA: ≤ DC 2 V
Output frequency	Configurable: 0 to 1000 Hz
Damping	Configurable: 0 to 999 s
Pulse/pause ratio	1:1
Assignable measured variables	<ul style="list-style-type: none"> ■ Volume flow ■ Corrected volume flow ■ Mass flow ■ Energy flow <p> The range of options increases if the measuring device has one or more application packages.</p>

Relay output

Function	Switch output
Version	Relay output, galvanically isolated
Switching behavior	Can be set to: <ul style="list-style-type: none"> ▪ NO (normally open), factory setting ▪ NC (normally closed)
Maximum switching capacity (passive)	<ul style="list-style-type: none"> ▪ DC 30 V, 0.1 A ▪ AC 30 V, 0.5 A
Assignable functions	<ul style="list-style-type: none"> ▪ Off ▪ On ▪ Diagnostic behavior ▪ Limit value <ul style="list-style-type: none"> ▪ Volume flow ▪ Corrected volume flow ▪ Mass flow ▪ Energy flow ▪ Flow velocity ▪ Electronic temperature ▪ Sound velocity ▪ Methane fraction ¹⁾ ▪ Molar mass ¹⁾ ▪ Density ¹⁾ ▪ Dynamic viscosity ¹⁾ ▪ Calorific value ¹⁾ ▪ Wobbe index ¹⁾ ▪ Pressure ²⁾ ▪ Temperature ³⁾ ▪ Totalizer 1-3 ▪ Flow direction monitoring ▪ Status <ul style="list-style-type: none"> Low flow cut off <p> The range of options increases if the measuring device has one or more application packages.</p>

- 1) Only for the order code for "Application package", option EF "Advanced gas analysis" and with the appropriate configuration
- 2) Only for the order code for "Measuring tube; Transducer; Sensor version", option AC "316L; titanium gr. 2; pressure + temperature measurement integrated"
- 3) Only for the order code for "Measuring tube; Transducer; Sensor version", option AB "316L; titanium gr. 2; temperature measurement integrated" or AC "316L; titanium gr. 2; pressure + temperature measurement integrated"

User-configurable input/output

One specific input or output is assigned to a user-configurable input/output (configurable I/O) during device commissioning.

The following inputs and outputs are available for assignment:

- Choice of current output: 4 to 20 mA (active), 0/4 to 20 mA (passive)
- Pulse/frequency/switch output
- Choice of current input: 4 to 20 mA (active), 0/4 to 20 mA (passive)
- Status input

Signal on alarm

Depending on the interface, failure information is displayed as follows:

Modbus RS485

Failure mode	Choose from: <ul style="list-style-type: none"> ▪ NaN value instead of current value ▪ Last valid value
---------------------	---

Current output 0/4 to 20 mA

4 to 20 mA

Failure mode	Choose from: <ul style="list-style-type: none"> ■ 4 to 20 mA in accordance with NAMUR recommendation NE 43 ■ 4 to 20 mA in accordance with US ■ Min. value: 3.59 mA ■ Max. value: 22.5 mA ■ Freely definable value between: 3.59 to 22.5 mA ■ Actual value ■ Last valid value
---------------------	--

0 to 20 mA

Failure mode	Choose from: <ul style="list-style-type: none"> ■ Maximum alarm: 22 mA ■ Freely definable value between: 0 to 20.5 mA
---------------------	---

Pulse/frequency/switch output

Pulse output	
Failure mode	Choose from: <ul style="list-style-type: none"> ■ Actual value ■ No pulses
Frequency output	
Failure mode	Choose from: <ul style="list-style-type: none"> ■ Actual value ■ 0 Hz ■ Defined value ($f_{max} \geq 2$ to 12 500 Hz)
Switch output	
Failure mode	Choose from: <ul style="list-style-type: none"> ■ Current status ■ Open ■ Closed

Relay output

Failure mode	Choose from: <ul style="list-style-type: none"> ■ Current status ■ Open ■ Closed
---------------------	---

Local display

Plain text display	With information on cause and remedial measures
Backlight	Red backlighting indicates a device error.

 Status signal as per NAMUR recommendation NE 107

Interface/protocol



- Via digital communication:
Modbus RS485
- Via service interface
 - CDI-RJ45 service interface
 - WLAN interface

Plain text display	With information on cause and remedial measures
---------------------------	---

Web browser

Plain text display	With information on cause and remedial measures
---------------------------	---



Light emitting diodes (LED)

Status information	Status indicated by various light emitting diodes The following information is displayed depending on the device version: <ul style="list-style-type: none"> ■ Supply voltage active ■ Data transmission active ■ Device alarm/error has occurred  Diagnostic information via light emitting diodes →  136
---------------------------	--

Low flow cut off The switch points for low flow cut off are user-selectable.

Galvanic isolation The outputs are galvanically isolated from one another and from earth (PE).

Protocol-specific data	<table border="1"> <tr> <td>Protocol</td> <td>Modbus Applications Protocol Specification V1.1</td> </tr> <tr> <td>Response times</td> <td> <ul style="list-style-type: none"> ■ Direct data access: typically 25 to 50 ms ■ Auto-scan buffer (data range): typically 3 to 5 ms </td> </tr> <tr> <td>Device type</td> <td>Slave</td> </tr> <tr> <td>Slave address range</td> <td>1 to 247</td> </tr> <tr> <td>Broadcast address range</td> <td>0</td> </tr> <tr> <td>Function codes</td> <td> <ul style="list-style-type: none"> ■ 03: Read holding register ■ 04: Read input register ■ 06: Write single registers ■ 08: Diagnostics ■ 16: Write multiple registers ■ 23: Read/write multiple registers </td> </tr> <tr> <td>Broadcast messages</td> <td> Supported by the following function codes: <ul style="list-style-type: none"> ■ 06: Write single registers ■ 16: Write multiple registers ■ 23: Read/write multiple registers </td> </tr> <tr> <td>Supported baud rate</td> <td> <ul style="list-style-type: none"> ■ 1 200 BAUD ■ 2 400 BAUD ■ 4 800 BAUD ■ 9 600 BAUD ■ 19 200 BAUD ■ 38 400 BAUD ■ 57 600 BAUD ■ 115 200 BAUD </td> </tr> <tr> <td>Data transfer mode</td> <td> <ul style="list-style-type: none"> ■ ASCII ■ RTU </td> </tr> </table>	Protocol	Modbus Applications Protocol Specification V1.1	Response times	<ul style="list-style-type: none"> ■ Direct data access: typically 25 to 50 ms ■ Auto-scan buffer (data range): typically 3 to 5 ms 	Device type	Slave	Slave address range	1 to 247	Broadcast address range	0	Function codes	<ul style="list-style-type: none"> ■ 03: Read holding register ■ 04: Read input register ■ 06: Write single registers ■ 08: Diagnostics ■ 16: Write multiple registers ■ 23: Read/write multiple registers 	Broadcast messages	Supported by the following function codes: <ul style="list-style-type: none"> ■ 06: Write single registers ■ 16: Write multiple registers ■ 23: Read/write multiple registers 	Supported baud rate	<ul style="list-style-type: none"> ■ 1 200 BAUD ■ 2 400 BAUD ■ 4 800 BAUD ■ 9 600 BAUD ■ 19 200 BAUD ■ 38 400 BAUD ■ 57 600 BAUD ■ 115 200 BAUD 	Data transfer mode	<ul style="list-style-type: none"> ■ ASCII ■ RTU
Protocol	Modbus Applications Protocol Specification V1.1																		
Response times	<ul style="list-style-type: none"> ■ Direct data access: typically 25 to 50 ms ■ Auto-scan buffer (data range): typically 3 to 5 ms 																		
Device type	Slave																		
Slave address range	1 to 247																		
Broadcast address range	0																		
Function codes	<ul style="list-style-type: none"> ■ 03: Read holding register ■ 04: Read input register ■ 06: Write single registers ■ 08: Diagnostics ■ 16: Write multiple registers ■ 23: Read/write multiple registers 																		
Broadcast messages	Supported by the following function codes: <ul style="list-style-type: none"> ■ 06: Write single registers ■ 16: Write multiple registers ■ 23: Read/write multiple registers 																		
Supported baud rate	<ul style="list-style-type: none"> ■ 1 200 BAUD ■ 2 400 BAUD ■ 4 800 BAUD ■ 9 600 BAUD ■ 19 200 BAUD ■ 38 400 BAUD ■ 57 600 BAUD ■ 115 200 BAUD 																		
Data transfer mode	<ul style="list-style-type: none"> ■ ASCII ■ RTU 																		

Data access	Each device parameter can be accessed via Modbus RS485.  For Modbus register information
System integration	Information on system integration →  71. <ul style="list-style-type: none"> ▪ Modbus RS485 information ▪ Function codes ▪ Register information ▪ Response time ▪ Modbus data map

16.5 Power supply

Terminal assignment →  33

Supply voltage	Order code for "Power supply"		Terminal voltage	Frequency range
	Option I	DC24 V	±20%	–
	AC100 to 240 V	–15...+10%	50/60 Hz	

Power consumption **Transmitter**
Max. 10 W (active power)

switch-on current	Max. 36 A (<5 ms) as per NAMUR Recommendation NE 21
--------------------------	---

Current consumption **Transmitter**

- Max. 400 mA (24 V)
- Max. 200 mA (110 V, 50/60 Hz; 230 V, 50/60 Hz)

Power supply failure

- Totalizers stop at the last value measured.
- Depending on the device version, the configuration is retained in the device memory or in the pluggable data memory (HistoROM DAT).
- Error messages (incl. total operated hours) are stored.

Electrical connection →  34

Potential equalization →  37

terminals Spring-loaded terminals: Suitable for strands and strands with ferrules.
Conductor cross-section 0.2 to 2.5 mm² (24 to 12 AWG).

Cable entries

- Cable gland: M20 × 1.5 with cable ∅ 6 to 12 mm (0.24 to 0.47 in)
- Thread for cable entry:
 - NPT ½"
 - G ½"
 - M20

Cable specification →  30

16.6 Performance characteristics

Reference operating conditions

- Error limits following ISO/DIS 11631
- Calibration gas: dry air
- Accuracy information is based on accredited calibration rigs that are traced to ISO 17025.

Maximum measured error o.r. = of reading; o.f.s. = of full scale value; abs. = absolute; T = medium temperature



Volume flow

Standard Order code for "Flow calibration", option A "1%"	<ul style="list-style-type: none"> ■ $\pm 1.0\%$ o.r. for 3 to 40 m/s (9.84 to 131.2 ft/s) ■ $\pm 2.0\%$ o.r. for 0.3 to 3 m/s (0.98 to 9.84 ft/s)
Optional Order code for "Flow calibration", option C "0.50%"	<ul style="list-style-type: none"> ■ $\pm 0.5\%$ o.r. for 3 to 40 m/s (9.84 to 131.2 ft/s) ■ $\pm 1.0\%$ o.r. for 0.3 to 3 m/s (0.98 to 9.84 ft/s)

 The specification applies for Reynolds numbers $Re \geq 10\,000$. For Reynolds numbers $Re < 10\,000$ larger measured errors may occur.

Temperature

Optional (order code for "Measuring tube; Transducer; Sensor version", option AB "316L; Titanium Gr. 2; temperature measurement integrated" or AC "316L; Titanium Gr. 2; pressure + temperature measurement integrated")
 $\pm 0.35\text{ }^{\circ}\text{C} \pm 0.002 \cdot T\text{ }^{\circ}\text{C}$ ($\pm 0.63\text{ }^{\circ}\text{F} \pm 0.0011 \cdot (T - 32)\text{ }^{\circ}\text{F}$)

 The additional measured error caused by heat conduction is not taken into consideration here. The error caused by heat conduction can be reduced by using thermal insulation →  25.

Pressure

Optional (order code for "Measuring tube; Transducer; Sensor version", option AC "316L; Titanium Gr. 2; pressure + temperature measurement integrated")

Order code for "Pressure component"	Nominal value absolute [bar (psi)]	Pressure ranges and measured errors ¹⁾	
		Pressure range, absolute [bar (psi)]	Measured error, absolute
Option B "Pressure measuring cell 2bar/29psi abs"	2 bar (30 psi)	0.01 (0.1) $\leq p \leq$ 0.4 (5.8) 0.4 (5.8) $\leq p \leq$ 2 (29)	$\pm 0.5\%$ of 0.4 bar (5.8 psi) $\pm 0.5\%$ o.r.
Option C "Pressure measuring cell 4bar/58psi abs"	4 bar (60 psi)	0.01 (0.1) $\leq p \leq$ 0.8 (11.6) 0.8 (11.6) $\leq p \leq$ 4 (58)	$\pm 0.5\%$ of 0.8 bar (11.6 psi) $\pm 0.5\%$ o.r.
Option D "Pressure measuring cell 10bar/145psi abs"	10 bar (150 psi)	0.01 (0.1) $\leq p \leq$ 2 (29) 2 (29) $\leq p \leq$ 10 (145)	$\pm 0.5\%$ of 2 bar (29 psi) $\pm 0.5\%$ o.r.
Option E "Pressure measuring cell 40bar/580psi abs"	40 bar (600 psi)	0.01 (0.1) $\leq p \leq$ 8 (116) 8 (116) $\leq p \leq$ 40 (580)	$\pm 0.5\%$ of 8 bar (116 psi) $\pm 0.5\%$ o.r.
Option F "Pressure measuring cell 100bar/1450psi abs"	100 bar (1500 psi)	0.01 (0.1) $\leq p \leq$ 20 (290) 20 (290) $\leq p \leq$ 100 (1450)	$\pm 0.5\%$ of 20 bar (290 psi) $\pm 0.5\%$ o.r.

1) The specific measured errors refer to the position of the measurement in the measuring tube and do not correspond to the pressure in the pipe connection line upstream or downstream from the measuring device.

Sound velocity

$\pm 0.2\%$ o.r.

Example for max. measured error (volume flow)

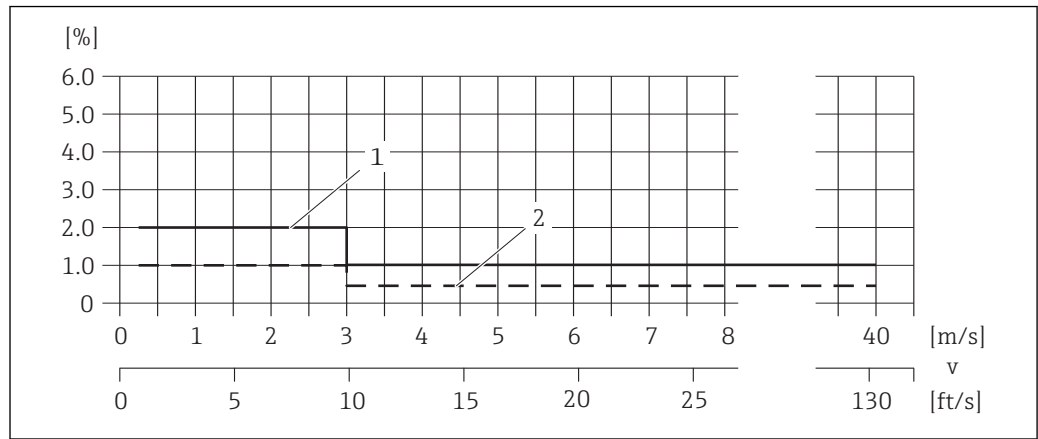

31 Example for max. measured error (volume flow) in % o.r.

- 1 Standard (order code for "Flow calibration", option A "1%")
- 2 Optional (order code for "Flow calibration", option C "0.50%")

Repeatability

o.r. = of reading

Volume flow

- ±0.2 % o.r. for 3 to 40 m/s (9.84 to 131.2 ft/s)
- ±0.4 % o.r. for 0.3 to 3 m/s (0.98 to 9.84 ft/s)

Influence of ambient temperature

Current output

Temperature coefficient	Max. 1 µA/°C
-------------------------	--------------

Pulse/frequency output

Temperature coefficient	No additional effect. Included in accuracy.
-------------------------	---

16.7 Installation

"Mounting requirements" → 22

16.8 Environment

Ambient temperature range

Measuring device	<ul style="list-style-type: none"> ■ Standard: -40 to +60 °C (-40 to +140 °F) ■ Optional order code for "Test, certificate", option JP: -50 to +60 °C (-58 to +140 °F)
Readability of the local display	-20 to +60 °C (-4 to +140 °F) The readability of the display may be impaired at temperatures outside the temperature range.

- ▶ If operating outdoors:
Avoid direct sunlight, particularly in warm climatic regions.

Storage temperature All components apart from display modules:
-40 to +80 °C (-40 to +176 °F), preferably at +20 °C (+68 °F)

Display modules

-40 to +80 °C (-40 to +176 °F)

Degree of protection

Measuring device

- As standard: IP66/67, type 4X enclosure
- When housing is open: IP20, type 1 enclosure
- Display module: IP20, type 1 enclosure

External WLAN antenna

IP67

Vibration- and shock-resistance

Vibration sinusoidal, according to IEC 60068-2-6

- 2 to 8.4 Hz, 3.5 mm peak
- 8.4 to 2 000 Hz, 1 g peak

Vibration broad-band random, according to IEC 60068-2-64

- 10 to 200 Hz, 0.003 g²/Hz
- 200 to 2 000 Hz, 0.001 g²/Hz
- Total: 1.54 g rms

Shock half-sine, according to IEC 60068-2-27

6 ms 30 g

Rough handling shocks according to IEC 60068-2-31

Electromagnetic compatibility (EMC)

As per IEC/EN 61326 and NAMUR Recommendation 21 (NE 21)



Details are provided in the Declaration of Conformity.

16.9 Process

Medium temperature range

Sensor

- Without integrated pressure measuring cell: -50 to +150 °C (-58 to +302 °F)
- With integrated pressure measuring cell: -50 to +100 °C (-58 to +212 °F)

Medium pressure range

Min. medium pressure: 0.7 bar (10.2 psi) absolute

The maximum permitted medium pressure is defined by the pressure/temperature curves (see the "Technical Information" document) and the pressure specifications of the integrated pressure measuring cell (optional; order code for "Measuring tube; transducer; sensor version", option AC "316L; Titanium Gr. 2; pressure + temperature measurement integrated").

⚠ WARNING

The maximum pressure for the measuring device depends on the lowest-rated element with regard to pressure.

- ▶ Note specifications regarding the pressure range of the pressure measuring cell.
- ▶ The Pressure Equipment Directive (2014/68/EU) uses the abbreviation "PS". The abbreviation "PS" corresponds to the MWP (maximum working pressure) of the pressure measuring cell.
- ▶ The MWP for the pressure measuring cell depends on the lowest-rated element, with regard to pressure, of the selected components, i.e. the process connection must be taken into consideration in addition to the pressure measuring cell. Also take the pressure/temperature dependency into consideration.
- ▶ The MWP may be applied at the device for an unlimited period. The MWP is indicated on the nameplate. This value refers to a reference temperature of +20 °C (+68 °F) and may be applied to the pressure measuring cell for an unlimited time.
- ▶ The OPL (over pressure limit = sensor overload limit) for the measuring device depends on the lowest-rated element, with regard to pressure, of the selected components, i.e. the process connection has to be taken into consideration in addition to the pressure measuring cell. Also take the pressure/temperature dependency into consideration.
- ▶ The test pressure corresponds to the over pressure limit of the pressure measuring cell and may be applied only temporarily to ensure that the measurement is within the specifications and no permanent damage occurs.

Pressure measuring cell	Maximum sensor measuring range		MWP	OPL
	Lower (LRL)	Upper (URL)		
	[bar (psi)]	[bar (psi)]	[bar (psi)]	[bar (psi)]
2 bar (30 psi)	0 (0)	+2 (+30)	6.7 (100.5)	10 (150)
4 bar (60 psi)	0 (0)	+4 (+60)	10.7 (160.5)	16 (240)
10 bar (150 psi)	0 (0)	+10 (+150)	25 (375)	40 (600)
40 bar (600 psi)	0 (0)	+40 (+600)	100 (1 500)	160 (2 400)
100 bar (1 500 psi)	0 (0)	+100 (+1 500)	100 (1 500)	160 (2 400)

Pressure-temperature ratings

 An overview of the pressure-temperature ratings for the process connections is provided in the "Technical Information" document

Rupture disk

The neck of the measuring device is always fitted with a rupture disk with a triggering pressure of 10 to 15 bar (145 to 217.5 psi). The rupture disk is used for leak detection and for the controlled release of pressure in the neck of the measuring device. The measuring device with an installed rupture disk meets the dual seal requirements of ANSI/ISA-12.27.01.

Flow limit

The diameter of the pipe and the flow rate determine the nominal diameter of the sensor.

 For an overview of the full scale values for the measuring range, see the "Measuring range" section →  161

- The minimum recommended full scale value is approx. 1/20 of the maximum full scale value.
- In most applications, 10 to 50 % of the maximum full scale value can be considered ideal.

Pressure loss

No pressure loss occurs if the sensor is installed in a pipe with the same nominal diameter.

Thermal insulation

For optimum measurement performance, make sure that no heat transfer (heat loss or heat supply) can take place at the sensor. This can be ensured by installing thermal insulation. The formation of condensation in the measuring device can also be limited in this way.

Thermal insulation is particularly recommended in situations in which the difference between the process temperature and ambient temperature is large. This difference leads to an error during temperature measurement that is caused by heat conduction (known as the "heat conduction error").

⚠ WARNING

Electronics overheating on account of thermal insulation!

- ▶ Recommended orientation: horizontal orientation, transmitter housing pointing downwards.
- ▶ Do not insulate the transmitter housing .
- ▶ Maximum permissible temperature at the lower end of the transmitter housing: 80 °C (176 °F)
- ▶ Thermal insulation with extended neck free: We recommend that you do not insulate the extended neck in order to ensure optimum dissipation of heat.

The thermal insulation should never cover the transmitter housing and the pressure measuring cell.

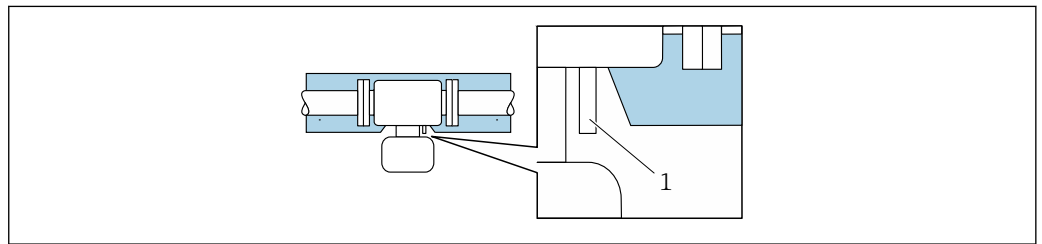

A0037676

32 Thermal insulation with free extended neck and pressure measuring cell

1 Pressure measuring cell

16.10 Mechanical construction

Design, dimensions



For the dimensions and installation lengths of the device, see the "Technical Information" document, "Mechanical construction" section.

Weight

Weight information (without packing material) including transmitter as per order code for "Housing", option A "aluminum, coated".

Different values due to different transmitter versions:

- Transmitter version for the hazardous area (Order code for "Housing", option A "Aluminum, coated"; Ex d): +2 kg (+4.4 lbs)
- Cast transmitter version, stainless (Order code for "Housing", option L "Cast, stainless"): +6 kg (+13 lbs)

Weight in SI units

Nominal diameter		EN (DIN) [kg]			
[mm]	[in]	Pressure rating			
		PN 16	PN 40	PN 63	PN 100
25	1	12	12	15	15
50	2	18	18	21	24

Nominal diameter		EN (DIN) [kg]			
[mm]	[in]	Pressure rating			
		PN 16	PN 40	PN 63	PN 100
80	3	24	24	28	32
100	4	26	29	35	42
150	6	38	45	65	79
200	8	54	74	101	131
250	10	79	117	145	208
300	12	110	164	204	300

Nominal diameter		ASME [kg]			
[mm]	[in]	Pressure rating			
		Class 150 RF Sch.40	Class 300 RF Sch.40	Class 300 RF Sch.80	Class 600 RF Sch.80
25	1	12	13	13	14
50	2	17	19	19	21
80	3	24	27	27	31
100	4	29	37	38	52
150	6	42	58	58	91
200	8	69	94	96	139
250	10	96	136	139	225
300	12	145	196	201	281

Weight in US units

Nominal diameter		ASME [lbs]			
[mm]	[in]	Pressure rating			
		Class 150 RF Sch.40	Class 300 RF Sch.40	Class 300 RF Sch.80	Class 600 RF Sch.80
25	1	26	29	29	31
50	2	37	42	42	46
80	3	53	60	60	68
100	4	64	82	84	115
150	6	93	128	128	201
200	8	152	207	212	306
250	10	212	300	306	496
300	12	320	432	443	620

Materials

 All the metal materials used meet the standards NACE MR0175 and NACE MR0103. The seal material is tested according to NACE TM0297, NACE TM0187, NORSOK M710-B, ISO 10423 (API 6A) and ISO 23936.

 **DANGER**

The ultrasonic transducer may not be leak-tight!

Toxic and/or explosive gases may escape!

- ▶ The material of the seal is not suitable for applications in pure steam.
- ▶ The material of the seal may not be exposed to a pressure increase at low process temperatures below -40 °C (-40 °F).

Transmitter housing

Order code for "Housing":

- Option **A** "Aluminum, coated": aluminum, AlSi10Mg, coated
- Option **L** "Cast, stainless": cast, stainless steel, 1.4409 (CF3M)

Window material

Order code for "Housing":

- Option **A** "Aluminum, coated": glass
- Option **L** "Cast, stainless": glass

Cable entries/cable glands

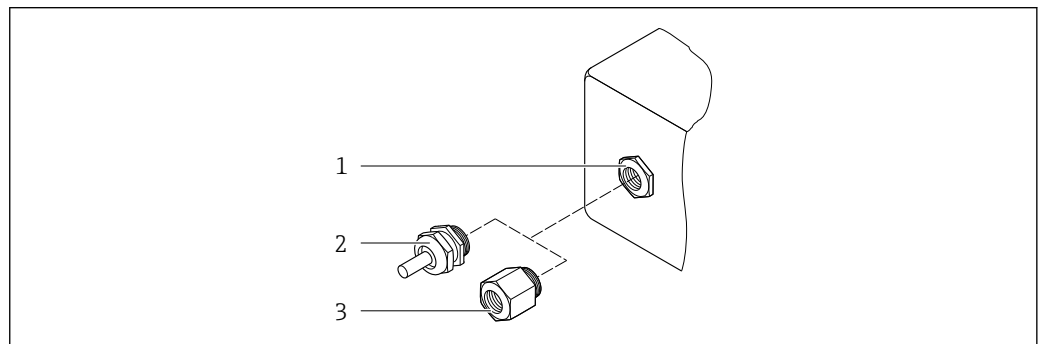

33 Possible cable entries/cable glands

- 1 Female thread M20 × 1.5
- 2 Cable gland M20 × 1.5
- 3 Adapter for cable entry with internal thread G ½" or NPT ½"

Order code for "Housing", option A "Aluminum, coated"

The various cable entries are suitable for hazardous and non-hazardous areas.

Cable entry/cable gland	Material
Coupling M20 × 1.5	Non-Ex: plastic
	Z2, D2, Ex d/de: brass with plastic
Adapter for cable entry with internal thread G ½"	Nickel-plated brass
Adapter for cable entry with internal thread NPT ½"	

Order code for "Housing", option L "Cast, stainless"

The various cable entries are suitable for hazardous and non-hazardous areas.



Cable entry/cable gland	Material
Cable gland M20 × 1.5	Stainless steel, 1.4404 (316L)
Adapter for cable entry with internal thread G ½"	
Adapter for cable entry with internal thread NPT ½"	

Measuring tube

Stainless steel: 1.4408/1.4409 (CF3M)

Process connections

Stainless steel: 1.4404 (316, 316L)

 Available process connections →  178

Cable for transmitter neck/ultrasonic transducer

Incl. connections for transmitter neck and ultrasonic transducer

Stainless steel: 1.4404 (316, 316L)

Ultrasonic transducer

Grade 2 titanium

Sensor holder: stainless steel: 1.4404 (316, 316L)

Seal for ultrasonic transducer

FKM material group

Temperature sensor

Stainless steel: 1.4404 (316, 316L)

Seal for temperature sensor

Seal-free (self-sealing NPT thread with sealant)

Pressure measuring cell

Stainless steel: 1.4404 (316, 316L)

Seal for pressure measuring cell

Seal-free (self-sealing NPT thread with sealant)

Accessories*Protective cover*

Stainless steel, 1.4404 (316L)

External WLAN antenna

- Antenna: ASA plastic (acrylic ester-styrene-acrylonitrile) and nickel-plated brass
- Adapter: Stainless steel and nickel-plated brass
- Cable: Polyethylene
- Plug: Nickel-plated brass
- Angle bracket: Stainless steel

Process connections

Flanges:

- EN 1092-1-B1
- ASME B16.5

 For information on the different materials used in the process connections →  178

16.11 Operability

Languages

Can be operated in the following languages:



- Via local operation
English, German, French, Spanish, Italian, Dutch, Portuguese, Polish, Russian, Turkish, Chinese, Japanese, Korean, Bahasa (Indonesian), Vietnamese, Czech, Swedish
- Via Web browser
English, German, French, Spanish, Italian, Dutch, Portuguese, Polish, Russian, Turkish, Chinese, Japanese, Korean, Bahasa (Indonesian), Vietnamese, Czech, Swedish
- Via "FieldCare", "DeviceCare" operating tool: English, German, French, Spanish, Italian, Chinese, Japanese

Local operation

Via display module

Equipment:

- Order code for "Display; operation", option F "4-line, illuminated, graphic display; touch control"
- Order code for "Display; operation", option G "4-line, illuminated, graphic display; touch control + WLAN"

 Information about WLAN interface →  66

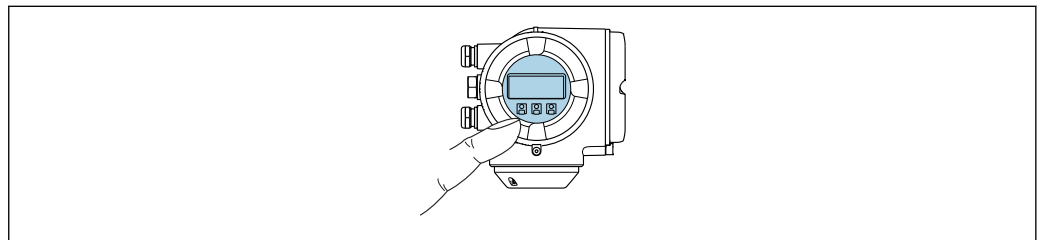



A0026785

 34 Operation with touch control

Display elements

- 4-line, illuminated, graphic display
- White background lighting; switches to red in event of device errors
- Format for displaying measured variables and status variables can be individually configured
- Permitted ambient temperature for the display: -20 to $+60$ °C (-4 to $+140$ °F)
The readability of the display may be impaired at temperatures outside the temperature range.

Operating elements

- External operation via touch control (3 optical keys) without opening the housing: , , 
- Operating elements also accessible in the various zones of the hazardous area

Via remote display and operating module DKX001

i The remote display and operating module DKX001 is available as an optional extra → 158.

- The measuring device is always supplied with a dummy cover when the remote display and operating module DKX001 is ordered directly with the measuring device. Display or operation at the transmitter is not possible in this case.
- If ordered subsequently, the remote display and operating module DKX001 may not be connected at the same time as the existing measuring device display module. Only one display or operation unit may be connected to the transmitter at any one time.

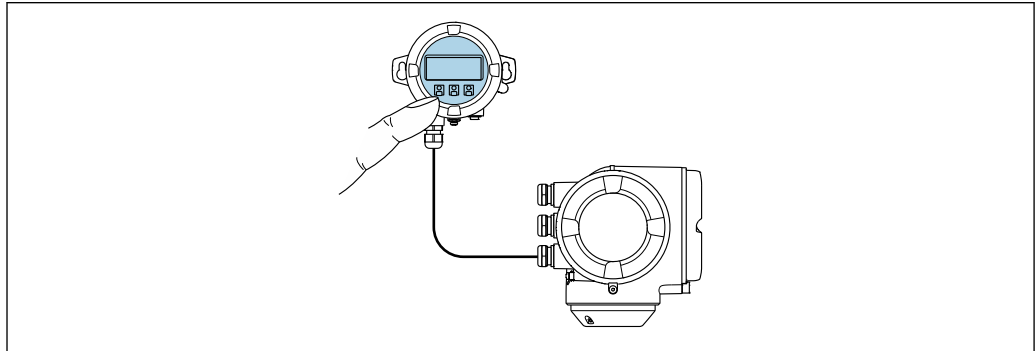

A0026786

35 Operation via remote display and operating module DKX001

Display and operating elements

The display and operating elements correspond to those of the display module → 179.

Material

The housing material of the display and operating module DKX001 depends on the choice of transmitter housing material.

Transmitter housing		Remote display and operating module	
Order code for "Housing"	Material	Order code for "Housing"	Material
Option A "Aluminum, coated"	AlSi10Mg, coated	Option C "Single-chamber, aluminum, coated"	AlSi10Mg, coated
Option L "Cast, stainless"	Cast stainless steel, 1.4409 (CF3M) similar to 316L	Option A "Single-chamber; cast, stainless"	1.4409 (CF3M)

Cable entry

Corresponds to the choice of transmitter housing, order code for "Electrical connection".

Connecting cable

→ 31



Dimensions

Information on the dimensions:
"Mechanical construction" section of the "Technical Information" document.

Remote operation → 65

Service interface → 65

Supported operating tools Different operating tools can be used for local or remote access to the measuring device. Depending on the operating tool used, access is possible with different operating units and via a variety of interfaces.

Supported operating tools	Operating unit	Interface	Additional information
Web browser	Notebook, PC or tablet with Web browser	<ul style="list-style-type: none"> ▪ CDI-RJ45 service interface ▪ WLAN interface 	Special Documentation for device
DeviceCare SFE100	Notebook, PC or tablet with Microsoft Windows system	<ul style="list-style-type: none"> ▪ CDI-RJ45 service interface ▪ WLAN interface ▪ Fieldbus protocol 	→  159
FieldCare SFE500	Notebook, PC or tablet with Microsoft Windows system	<ul style="list-style-type: none"> ▪ CDI-RJ45 service interface ▪ WLAN interface ▪ Fieldbus protocol 	→  159

 Other operating tools based on FDT technology with a device driver such as DTM/iDTM or DD/EDD can be used for device operation. These operating tools are available from the individual manufacturers. Integration into the following operating tools, among others, is supported:

- Field Device Manager (FDM) by Honeywell → www.honeywellprocess.com
- FieldMate by Yokogawa → www.yokogawa.com
- PACTWare → www.pactware.com

The associated device description files are available at: www.endress.com → Downloads

Web server



Thanks to the integrated Web server, the device can be operated and configured via a Web browser and via a service interface (CDI-RJ45) or via a WLAN interface. The structure of the operating menu is the same as for the local display. In addition to the measured values, status information on the device is also displayed and allows the user to monitor the status of the device. Furthermore the device data can be managed and the network parameters can be configured.

A device that has a WLAN interface (can be ordered as an option) is required for the WLAN connection: order code for "Display; operation", option G "4-line, illuminated; touch control + WLAN". The device acts as an Access Point and enables communication by computer or a mobile handheld terminal.

Supported functions

Data exchange between the operating unit (such as a notebook for example) and the measuring device:

- Upload the configuration from the measuring device (XML format, configuration backup)
- Save the configuration to the measuring device (XML format, restore configuration)
- Export event list (.csv file)
- Export parameter settings (.csv file or PDF file, document the measuring point configuration)
- Export the Heartbeat verification log (PDF file, only available with the "Heartbeat Verification" application package)
- Flash firmware version for device firmware upgrade, for instance
- Download driver for system integration
- Visualize up to 1000 saved measured values (only available with the **Extended HistoROM** application package →  185)

 Web server special documentation →  187

HistoROM data management

The measuring device features HistoROM data management. HistoROM data management comprises both the storage and import/export of key device and process data, making operation and servicing far more reliable, secure and efficient.

 When the device is delivered, the factory settings of the configuration data are stored as a backup in the device memory. This memory can be overwritten with an updated data record, for example after commissioning.

Additional information on the data storage concept

There are different types of data storage units in which device data are stored and used by the device:

	Device memory	T-DAT	S-DAT
Available data	<ul style="list-style-type: none"> ▪ Event logbook such as diagnostic events for example ▪ Parameter data record backup ▪ Device firmware package 	<ul style="list-style-type: none"> ▪ Measured value logging ("Extended HistoROM" order option) ▪ Current parameter data record (used by firmware at run time) ▪ Peakhold indicator (min/max values) ▪ Totalizer values 	<ul style="list-style-type: none"> ▪ Sensor data: nominal diameter etc. ▪ Serial number ▪ Calibration data ▪ Device configuration (e.g. SW options, fixed I/O or multi I/O)
Storage location	Fixed on the user interface board in the connection compartment	Attachable to the user interface board in the connection compartment	In the sensor plug in the transmitter neck part

Data backup

Automatic

- The most important device data (sensor and transmitter) are automatically saved in the DAT modules
- If the transmitter or measuring device is replaced: once the T-DAT containing the previous device data has been exchanged, the new measuring device is ready for operation again immediately without any errors
- If the sensor is replaced: once the sensor has been replaced, new sensor data are transferred from the S-DAT in the measuring device and the measuring device is ready for operation again immediately without any errors
- If exchanging the electronics module (e.g. I/O electronics module): Once the electronics module has been replaced, the software of the module is compared against the current device firmware. The module software is upgraded or downgraded where necessary. The electronics module is available for use immediately afterwards and no compatibility problems occur.

Manual

Additional parameter data record (complete parameter settings) in the integrated device memory HistoROM backup for:

- Data backup function
Backup and subsequent restoration of a device configuration in the device memory HistoROM backup
- Data comparison function
Comparison of the current device configuration with the device configuration saved in the device memory HistoROM backup

Data transfer

Manual

Transfer of a device configuration to another device using the export function of the specific operating tool, e.g. with FieldCare, DeviceCare or Web server: to duplicate the configuration or to store in an archive (e.g. for backup purposes)

Event list**Automatic**

- Chronological display of up to 20 event messages in the events list
- If the **Extended HistoROM** application package (order option) is enabled: up to 100 event messages are displayed in the events list along with a time stamp, plain text description and remedial measures
- The events list can be exported and displayed via a variety of interfaces and operating tools e.g. DeviceCare, FieldCare or Web server



Data logging**Manual**

If the **Extended HistoROM** application package (order option) is enabled:

- Record up to 1 000 measured values via 1 to 4 channels
- User configurable recording interval
- Record up to 250 measured values via each of the 4 memory channels
- Export the measured value log via a variety of interfaces and operating tools e.g. FieldCare, DeviceCare or web server

16.12 Certificates and approvals

 Currently available certificates and approvals can be called up via the product configurator.

CE mark	<p>The device meets the legal requirements of the applicable EU Directives. These are listed in the corresponding EU Declaration of Conformity along with the standards applied.</p> <p>Endress+Hauser confirms successful testing of the device by affixing to it the CE mark.</p>
RCM-tick symbol	<p>The measuring system meets the EMC requirements of the "Australian Communications and Media Authority (ACMA)".</p>
Ex approval	<p>The devices are certified for use in hazardous areas and the relevant safety instructions are provided in the separate "Safety Instructions" (XA) document. Reference is made to this document on the nameplate.</p>
Pressure Equipment Directive	<ul style="list-style-type: none"> ■ With the identification PED/G1/x (x = category) on the sensor nameplate, Endress+Hauser confirms conformity with the "Essential Safety Requirements" specified in Appendix I of the Pressure Equipment Directive 2014/68/EU. ■ Devices not bearing this marking (PED) are designed and manufactured according to good engineering practice. They meet the requirements of Article 4 paragraph 3 of the Pressure Equipment Directive 2014/68/EU. The range of application is indicated in tables 6 to 9 in Annex II of the Pressure Equipment Directive 2014/68/EU.
Radio approval	<p>The measuring device has radio approval.</p> <p> For detailed information regarding radio approval, see Special Documentation →  186</p>
Additional certification	<p>CRN approval</p> <p>Some device versions have CRN approval. A CRN-approved process connection with a CSA approval must be ordered for a CRN-approved device.</p>

Tests and certificates

- EN10204-3.1 material certificate, parts and sensor housing in contact with medium (order code for "Test, certificate", option JA)
- Pressure testing, internal procedure, test report (order code for "Test, certificate", option JB)
- Ambient temperature -50 °C (-58 °F) (order code for "Test, certificate", option JP)
- Helium leak testing, internal procedure, test report (order code for "Test, certificate", option KC)
- EN10204-2.1 confirmation of compliance with the order and EN10204-2.2 test report

Testing of welds

Order code for "Test, certificate", option	Radiographic testing standard		Process connection
	ISO 10675-1 ZG1	ASME B31.3 NFS	
KE	x		RT
KI		x	RT
K5	x		DR
K6		x	DR
RT = Radiographic testing, DR = Digital radiography All options with test report			

Other standards and guidelines

- EN 60529
Degrees of protection provided by enclosures (IP code)
- EN 61010-1
Safety requirements for electrical equipment for measurement, control and laboratory use - general requirements
- IEC/EN 61326
Emission in accordance with Class A requirements. Electromagnetic compatibility (EMC requirements).
- NAMUR NE 21
Electromagnetic compatibility (EMC) of industrial process and laboratory control equipment
- NAMUR NE 32
Data retention in the event of a power failure in field and control instruments with microprocessors
- NAMUR NE 43
Standardization of the signal level for the breakdown information of digital transmitters with analog output signal.
- NAMUR NE 53
Software of field devices and signal-processing devices with digital electronics
- NAMUR NE 105
Specifications for integrating fieldbus devices in engineering tools for field devices
- NAMUR NE 107
Self-monitoring and diagnosis of field devices
- NAMUR NE 131
Requirements for field devices for standard applications
- ETSI EN 300 328
Guidelines for 2.4 GHz radio components.
- EN 301489
Electromagnetic compatibility and radio spectrum matters (ERM).
- AGA Report No. 9
Measurement of gas by multipath ultrasonic meters.
- ISO 17089
Measurement of fluid flow in closed conduits – Ultrasonic meters for gas.

16.13 Application packages

Many different application packages are available to enhance the functionality of the device. Such packages might be needed to address safety aspects or specific application requirements.

The application packages can be ordered with the device or subsequently from Endress+Hauser. Detailed information on the order code in question is available from your local Endress+Hauser sales center or on the product page of the Endress+Hauser website: www.endress.com.





Detailed information on the application packages:
Special Documentation for the device → 187

Diagnostics functions	Package	Description
	Extended HistoROM	<p>Comprises extended functions concerning the event log and the activation of the measured value memory.</p> <p>Event log: Memory volume is extended from 20 message entries (standard version) to up to 100 entries.</p> <p>Data logging (line recorder):</p> <ul style="list-style-type: none"> ▪ Memory capacity for up to 1000 measured values is activated. ▪ 250 measured values can be output via each of the 4 memory channels. The recording interval can be defined and configured by the user. ▪ Measured value logs can be accessed via the local display or operating tool e.g. FieldCare, DeviceCare or Web server.

Heartbeat Technology	Package	Description
	Heartbeat Verification +Monitoring	<p>Heartbeat Verification Meets the requirement for traceable verification to DIN ISO 9001:2008 Chapter 7.6 a) "Control of monitoring and measuring equipment".</p> <ul style="list-style-type: none"> ▪ Functional testing in the installed state without interrupting the process. ▪ Traceable verification results on request, including a report. ▪ Simple testing process via local operation or other operating interfaces. ▪ Clear measuring point assessment (pass/fail) with high test coverage within the framework of manufacturer specifications. ▪ Extension of calibration intervals according to operator's risk assessment. <p>Heartbeat Monitoring Continuously supplies data, which are characteristic of the measuring principle, to an external condition monitoring system for the purpose of preventive maintenance or process analysis. These data enable the operator to:</p> <ul style="list-style-type: none"> ▪ Draw conclusions - using these data and other information - about the impact the measuring application has on the measuring performance over time. ▪ Schedule servicing in time. ▪ Monitor the process or product quality, e.g. gas pockets.

Advanced gas analysis	Package	Description
	Advanced gas analysis	<p>The most important gas properties (molar mass, calorific value, Wobbe index etc.) can be calculated and displayed with the application package.</p> <p>The following gas types are available:</p> <ul style="list-style-type: none"> ▪ Single gas (known gas) ▪ Gas mixture (known composition) ▪ Coal gas/biogas (measurement of methane content) ▪ Natural gas – standardized calculation (with internationally recognized gas models: AGA NX-19, ISO 12213-2, ISO 12213-3, AGA 5, ISO 6976) ▪ Natural gas – using sound velocity (measurement of molar mass) ▪ User-specific gas (generic gas or gas mixture without knowledge of the composition of the gas) <p> The application package can only be ordered in combination with the order code for "Measuring tube; Transducer; Sensor version", option AC "316L; Titanium Gr. 2; pressure + temperature measurement integrated".</p>

16.14 Accessories

 Overview of accessories available for order →  158

16.15 Supplementary documentation

 For an overview of the scope of the associated Technical Documentation, refer to the following:

- *W@M Device Viewer* (www.endress.com/deviceviewer): Enter the serial number from nameplate
- *Endress+Hauser Operations App*: Enter the serial number from the nameplate or scan the 2D matrix code (QR code) on the nameplate

Standard documentation **Brief Operating Instructions**

Brief Operating Instructions for the sensor

Measuring device	Documentation code
Proline Prosonic Flow G	KA01374D

Brief Operating Instructions for transmitter

Measuring device	Documentation code
Proline 300	KA01376D

Technical Information

Measuring device	Documentation code
Prosonic Flow G 300	TI01385D

Description of Device Parameters

Measuring device	Documentation code
Prosonic Flow 300	GP01131D

Device-dependent additional documentation

Safety instructions

Safety instructions for electrical equipment for hazardous areas.

Content	Documentation code
ATEX/IECEX Ex d / Ex de	XA01844D
ATEX/IECEX Ex ec	XA01845D
cCSAus Ex d / Ex de	XA01846D
cCSAus Ex nA	XA01847D
cCSAus XP	XA01848D

Remote display and operating module DKX001

Contents	Documentation code
ATEX/IECEX Ex i	XA01494D
ATEX/IECEX Ex ec	XA01498D
cCSAus IS	XA01499D
cCSAus Ex nA	XA01513D
INMETRO Ex i	XA01500D
INMETRO Ex ec	XA01501D
NEPSI Ex i	XA01502D
NEPSI Ex nA	XA01503D

Special documentation

Content	Documentation code
Information on the Pressure Equipment Directive	SD01614D
Remote display and operating module DKX001	SD01763D
Radio approvals for WLAN interface for A309/A310 display module	SD01793D
Advanced gas analysis	SD02350D
Heartbeat Technology	SD02303D
Web server	SD02310D

Installation Instructions

Content	Comment
Installation instructions for spare part sets and accessories	<ul style="list-style-type: none"> ▪ Access the overview of all the available spare part sets via <i>W@M Device Viewer</i> → 📖 156 ▪ Accessories available for order with Installation Instructions → 📖 158

Index

A

- Access authorization to parameters
 - Read access 57
 - Write access 57
- Access code 57
 - Incorrect input 57
- Adapting the diagnostic behavior 143
- Additional certification 183
- Ambient temperature
 - Influence 172
- Ambient temperature range 24, 172
- Application 160
- Application packages 185
- Applicator 161
- Approvals 183
- Auto scan buffer
 - see Modbus RS485 Modbus data map

C

- Cable entries
 - Technical data 170
- Cable entry
 - Degree of protection 42
- CE mark 11, 183
- Certificates 183
- Check
 - Post-mounting 29
- Checklist
 - Post-connection check 42
 - Post-mounting check 29
- Cleaning
 - Exterior cleaning 155
- Commissioning 76
 - Advanced settings 101
 - Configuring the measuring device 76
- Configuring error response mode, Modbus RS485 143
- Connecting cable 30, 31
- Connecting the measuring device 34
- Connecting the signal cables 34
- Connecting the supply voltage cables 34
- Connection
 - see Electrical connection
- Connection preparations 33
- Connection tools 30
- Context menu
 - Calling up 53
 - Closing 53
 - Explanation 53
- Current consumption 170

D

- Declaration of Conformity 11
- Define access code 119
- Degree of protection 42, 173
- Designated use 10
- Device components 15

- Device description files 70
 - Device documentation
 - Supplementary documentation 8
 - Device locking, status 121
 - Device name
 - Sensor 18
 - Transmitter 17
 - Device repair 156
 - Device revision 70
 - Device type ID 70
 - DeviceCare 68
 - Device description file 70
 - Diagnostic behavior
 - Explanation 139
 - Symbols 139
 - Diagnostic information
 - Communication interface 143
 - Design, description 139, 142
 - DeviceCare 141
 - FieldCare 141
 - Light emitting diodes 136
 - Local display 138
 - Overview 144
 - Remedial measures 144
 - Web browser 140
 - Diagnostic list 149
 - Diagnostic message 138
 - Diagnostics
 - Symbols 138
 - DIP switches
 - see Write protection switch
 - Direct access 55
 - Direct access code 49
 - Disabling write protection 118
 - Display
 - see Onsite display
 - Display and operating module DKX001 180
 - Display area
 - For operational display 47
 - In the navigation view 50
 - Display values
 - For locking status 121
 - Disposal 156
 - Document
 - Function 6
 - Symbols 6
 - Document function 6
- ## E
- Editing view 51
 - Input screen 52
 - Using operating elements 51, 52
 - Electrical connection
 - Computer with Web browser (e.g. Internet Explorer) 65
 - Degree of protection 42

Measuring device 30
 Operating tool (e.g. FieldCare, DeviceCare, AMS
 Device Manager, SIMATIC PDM) 65
 Operating tools
 Via Modbus RS485 protocol 65
 Via service interface (CDI-RJ45) 65
 Via WLAN interface 66
 Web server 65
 WLAN interface 66
 Electromagnetic compatibility 173
 Electronics module 15
 Enabling write protection 118
 Enabling/disabling the keypad lock 58
 Endress+Hauser services
 Maintenance 155
 Repair 156
 Environment
 Storage temperature 173
 Vibration- and shock-resistance 173
 Error messages
 see Diagnostic messages
 Event list 150
 Event logbook 150
 Ex approval 183
 Extended order code
 Sensor 18
 Transmitter 17
 Exterior cleaning 155

F
 Field of application
 Residual risks 11
 FieldCare 67
 Device description file 70
 Establishing a connection 68
 Function 67
 User interface 68
 Filtering the event logbook 151
 Firmware
 Release date 70
 Version 70
 Firmware history 154
 Flow direction 22, 27
 Flow limit 174
 Function check 76
 Function codes 71
 Functions
 see Parameters

G
 Galvanic isolation 169

H
 Hardware write protection 120
 Help text
 Calling up 56
 Closing 56
 Explanation 56
 HistoROM 112

I
 Identifying the measuring device 16
 Incoming acceptance 16
 Influence
 Ambient temperature 172
 Information on the document 6
 Inlet runs 23
 Input 161
 Inspection
 Received goods 16
 Inspection check
 Connection 42
 Installation 22
 Installation conditions
 Installation dimensions 24
 Mounting location 22
 Rupture disk 26
 Installation dimensions 24

L
 Languages, operation options 179
 Line recorder 130
 Local display 179
 Navigation view 49
 see Diagnostic message
 see In alarm condition
 see Operational display
 Low flow cut off 169

M
 Main electronics module 15
 Maintenance 155
 Maintenance tasks 155
 Managing the device configuration 112
 Manufacturer ID 70
 Manufacturing date 17, 18
 Materials 176
 Maximum measured error 171
 Measured values
 Calculated 161
 Direct 161
 Optional 161
 see Process variables
 Measuring and test equipment 155
 Measuring device
 Configuration 76
 Conversion 156
 Disposal 157
 Mounting the sensor 27
 Preparing for electrical connection 33
 Preparing for mounting 27
 Removing 156
 Repairs 156
 Structure 15
 Measuring principle 160
 Measuring range 161
 Measuring range, recommended 174
 Measuring system 160

- Menu
 - Diagnostics 148
 - Setup 76, 78
- Menus
 - For measuring device configuration 76
 - For specific settings 101
- Modbus RS485
 - Configuring error response mode 143
 - Diagnostic information 143
 - Function codes 71
 - Modbus data map 73
 - Read access 71
 - Reading out data 74
 - Register addresses 72
 - Register information 72
 - Response time 72
 - Scan list 74
 - Write access 71
- Mounting conditions
 - Inlet and outlet runs 23
 - Orientation 22
 - Thermal insulation 25, 175
- Mounting dimensions
 - see Installation dimensions
- Mounting location 22
- Mounting preparations 27
- Mounting tools 27
- N**
- Nameplate
 - Sensor 18
 - Transmitter 17
- Navigation path (navigation view) 49
- Navigation view
 - In the submenu 49
 - In the wizard 49
- Numeric editor 51
- O**
- Onsite display
 - Numeric editor 51
 - Text editor 51
- Operable flow range 162
- Operating elements 53, 139
- Operating keys
 - see Operating elements
- Operating menu
 - Menus, submenus 45
 - Structure 45
 - Submenus and user roles 46
- Operating philosophy 46
- Operation 121
- Operation options 44
- Operational display 47
- Operational safety 11
- Order code 17, 18
- Orientation (vertical, horizontal) 22
- Outlet runs 23
- Output 164
- Output signal 164
- P**
- Packaging disposal 21
- Parameter
 - Changing 56
 - Entering values or text 56
- Parameter settings
 - Administration (Submenu) 115
 - Advanced setup (Submenu) 102
 - Communication (Submenu) 80
 - Configuration backup (Submenu) 112
 - Current input 82
 - Current input (Wizard) 82
 - Current input 1 to n (Submenu) 125
 - Current output 84
 - Current output (Wizard) 84
 - Data logging (Submenu) 130
 - Define access code (Wizard) 114
 - Device information (Submenu) 153
 - Diagnostics (Menu) 148
 - Display (Submenu) 107
 - Display (Wizard) 96
 - Double pulse output 95
 - Double pulse output (Submenu) 95, 128
 - Gas analysis (Wizard) 99
 - I/O configuration 81
 - I/O configuration (Submenu) 81
 - Low flow cut off (Submenu) 99
 - Process variables (Submenu) 122
 - Pulse/frequency/switch output 87
 - Pulse/frequency/switch output (Wizard) 87, 88, 91
 - Pulse/frequency/switch output 1 to n (Submenu) 127
 - Relay output 93
 - Relay output 1 to n (Submenu) 127
 - Relay output 1 to n (Wizard) 93
 - Reset access code (Submenu) 115
 - Sensor adjustment (Submenu) 102
 - Sensor setup (Submenu) 102
 - Setup (Menu) 78
 - Simulation (Submenu) 115
 - Status input 83
 - Status input (Submenu) 83
 - Status input 1 to n (Submenu) 126
 - System units (Submenu) 78
 - System values (Submenu) 124
 - Totalizer (Submenu) 128
 - Totalizer 1 to n (Submenu) 106
 - Totalizer handling (Submenu) 129
 - Value current output 1 to n (Submenu) 126
 - Web server (Submenu) 64
 - WLAN settings (Wizard) 110
- Performance characteristics 171
- Post-connection check (checklist) 42
- Post-installation check 76
- Post-mounting check (checklist) 29
- Potential equalization 37
- Power consumption 170
- Power supply failure 170

- Pressure Equipment Directive 183
- Pressure loss 174
- Pressure-temperature ratings 174
- Process connections 178
- Product safety 11
- Protecting parameter settings 118
- R**
- Radio approval 183
- RCM-tick symbol 183
- Read access 57
- Reading measured values 121
- Reading out diagnostic information, Modbus RS485 143
- Recalibration 155
- Reference operating conditions 171
- Registered trademarks 9
- Remedial measures
 - Calling up 140
 - Closing 140
- Remote operation 180
- Repair 156
- Repair of a device 156
- Repairs
 - Notes 156
- Repeatability 172
- Replacement
 - Device components 156
- Requirements for personnel 10
- Return 156
- Rupture disk
 - Safety instructions 26
 - Triggering pressure 174
- S**
- Safety 10
- Sensor
 - Medium temperature range 173
 - Mounting 27
- Serial number 17, 18
- Setting the operating language 76
- Settings
 - Adapting the measuring device to the process conditions 129
 - Administration 114
 - Advanced display configurations 107
 - Communication interface 80
 - Current input 82
 - Current output 84
 - Device reset 152
 - Double pulse output 95
 - Gas analysis 99
 - I/O configuration 81
 - Local display 96
 - Low flow cut off 98
 - Managing the device configuration 112
 - Operating language 76
 - Pulse output 87
 - Pulse/frequency/switch output 87, 88
 - Relay output 93
 - Resetting the totalizer 129
 - Sensor adjustment 102
 - Sensor setup 102
 - Simulation 115
 - Status input 83
 - Switch output 91
 - System units 78
 - Tag name 78
 - Totalizer 106
 - Totalizer reset 129
 - WLAN 110
- Showing data logging 130
- Signal on alarm 167
- Software release 70
- Spare part 156
- Spare parts 156
- Special connection instructions 38
- Standards and guidelines 184
- Status area
 - For operational display 47
 - In the navigation view 49
- Status signals 138, 141
- Storage concept 182
- Storage conditions 20
- Storage temperature 20
- Storage temperature range 173
- Structure
 - Measuring device 15
 - Operating menu 45
- Submenu
 - Administration 114, 115
 - Advanced setup 101, 102
 - Communication 80
 - Configuration backup 112
 - Current input 1 to n 125
 - Data logging 130
 - Device information 153
 - Display 107
 - Double pulse output 95, 128
 - Event list 150
 - I/O configuration 81
 - Input values 125
 - Low flow cut off 99
 - Measured values 121
 - Output values 126
 - Overview 46
 - Process variables 122
 - Pulse/frequency/switch output 1 to n 127
 - Relay output 1 to n 127
 - Reset access code 115
 - Sensor adjustment 102
 - Sensor setup 102
 - Simulation 115
 - Status input 83
 - Status input 1 to n 126
 - System units 78
 - System values 124
 - Totalizer 128
 - Totalizer 1 to n 106

- Totalizer handling 129
- Value current output 1 to n 126
- Web server 64
- Supply voltage 170
- Switch output 167
- Symbols
 - Controlling data entries 52
 - For communication 47
 - For diagnostic behavior 47
 - For locking 47
 - For measured variable 47
 - For measurement channel number 47
 - For menus 50
 - For parameters 50
 - For status signal 47
 - For submenu 50
 - For wizard 50
 - In the status area of the local display 47
 - Input screen 52
 - Operating elements 51
- System design
 - Measuring system 160
 - see Measuring device design
- System integration 70
- T**
- Technical data, overview 160
- Temperature range
 - Ambient temperature range 24, 172
 - Ambient temperature range for display 179
 - Fluid temperature 173
 - Storage temperature 20
- Terminal assignment 33
- terminals 170
- Tests and certificates 184
- Text editor 51
- Thermal insulation 25, 175
- Tool tip
 - see Help text
- Tools
 - Electrical connection 30
 - For mounting 27
 - Transport 20
- Totalizer
 - Configuration 106
- Transmitter
 - Turning the display module 28
 - Turning the housing 28
- Transporting the measuring device 20
- Troubleshooting
 - General 134
- Turning the display module 28
- Turning the electronics housing
 - see Turning the transmitter housing
- Turning the transmitter housing 28
- U**
- Use of the measuring device
 - Borderline cases 10
 - Incorrect use 10
 - see Designated use
- User interface
 - Current diagnostic event 148
 - Previous diagnostic event 148
- User roles 46
- V**
- Version data for the device 70
- Vibration- and shock-resistance 173
- W**
- W@M 155, 156
- W@M Device Viewer 16, 156
- Weight
 - Transport (notes) 20
- Wizard
 - Current input 82
 - Current output 84
 - Define access code 114
 - Display 96
 - Gas analysis 99
 - Low flow cut off 99
 - Pulse/frequency/switch output 87, 88, 91
 - Relay output 1 to n 93
 - WLAN settings 110
- WLAN settings 110
- Workplace safety 11
- Write access 57
- Write protection
 - Via access code 118
 - Via write protection switch 120
- Write protection switch 120

www.addresses.endress.com
