

# Operating Instructions

## Soliwave FQR56/FDR56

Microwave barrier

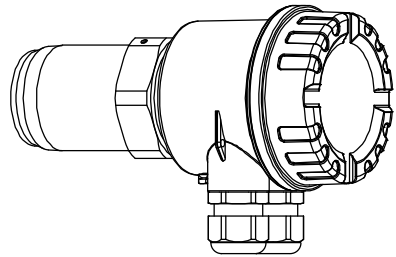

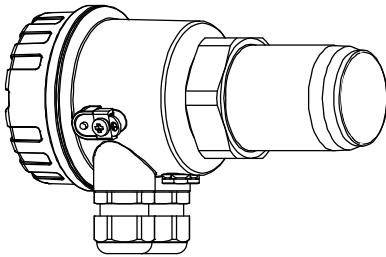
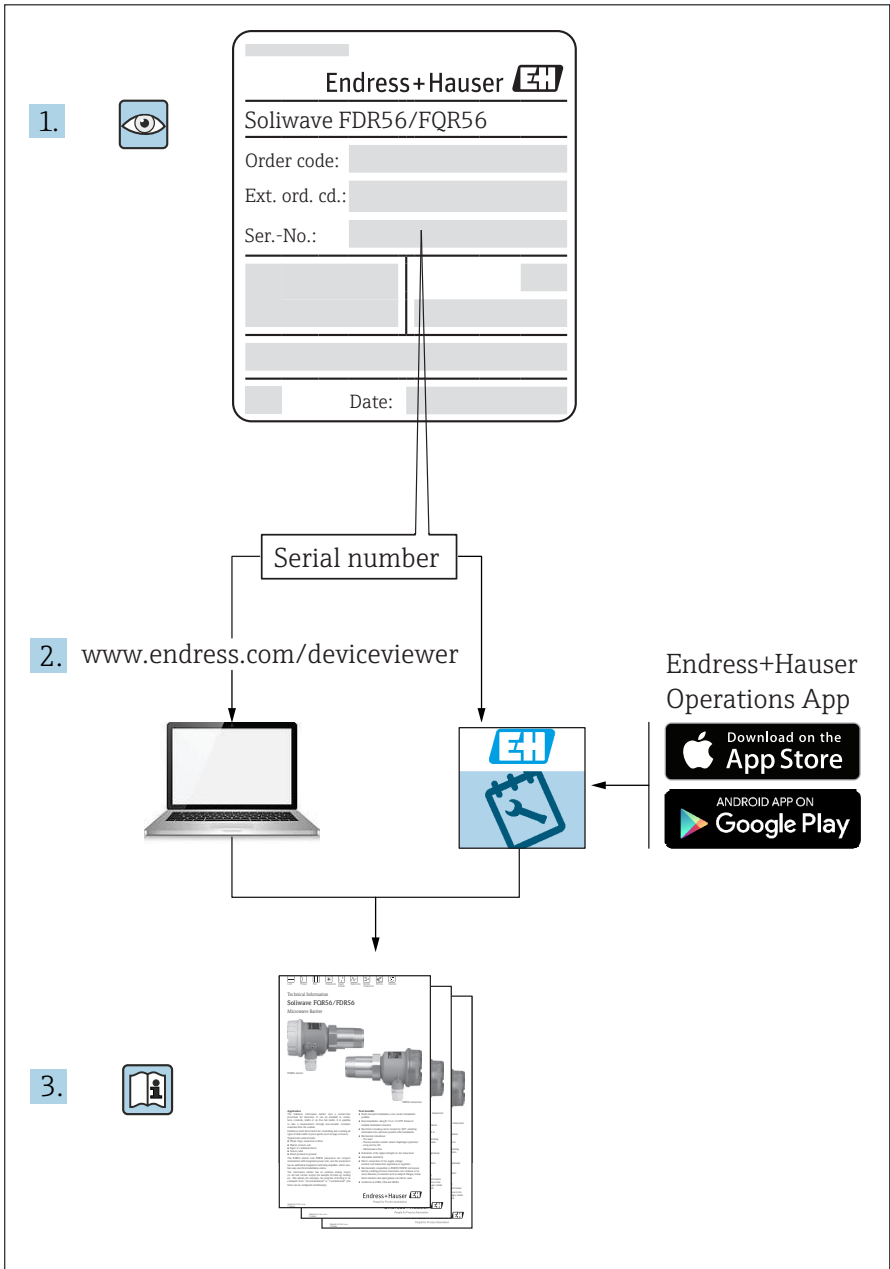

# Table of contents

<b>1</b>	<b>Information on the document .....</b>	<b>5</b>
1.1	Purpose of the document .....	5
1.2	Symbols used .....	5
1.3	Documentation .....	7
<b>2</b>	<b>Basic safety instructions .....</b>	<b>8</b>
2.1	Requirements for personnel .....	8
2.2	Designated use .....	8
2.3	Health and safety in the workplace .....	8
2.4	Operational safety and reliability .....	9
2.5	Product safety .....	9
<b>3</b>	<b>Product description .....</b>	<b>10</b>
<b>4</b>	<b>Incoming acceptance and product identification .....</b>	<b>11</b>
4.1	Incoming acceptance .....	11
4.2	Product identification .....	11
4.3	Nameplate .....	12
4.4	Storage and transportation .....	12
4.5	Disposal of packaging .....	12
<b>5</b>	<b>Installation .....</b>	<b>13</b>
5.1	Installation requirements .....	13
5.2	Installing the device .....	19
5.3	Post-installation check .....	21
<b>6</b>	<b>Electrical connection .....</b>	<b>22</b>
6.1	Connection requirements .....	22
6.2	Potential equalization .....	23
6.3	Connecting the device .....	23
6.4	Post-connection check .....	29
<b>7</b>	<b>Operating options .....</b>	<b>30</b>
7.1	Overview .....	30
7.2	Structure and function of the operating menu .....	32
<b>8</b>	<b>Commissioning .....</b>	<b>34</b>
8.1	Installation and function check .....	34
8.2	Switching on the device .....	34
8.3	Configuring the device .....	34
8.4	Advanced settings .....	37
8.5	Resetting to factory defaults (function F) .....	42
8.6	Simulation .....	43
<b>9</b>	<b>Diagnostics and troubleshooting .....</b>	<b>44</b>
9.1	General troubleshooting .....	44
9.2	Overview of diagnostic information .....	44
9.3	Resetting the device .....	44
<b>10</b>	<b>Maintenance .....</b>	<b>45</b>
10.1	Maintenance recommendation .....	45
10.2	Endress+Hauser services .....	45

---

<b>11</b>	<b>Repair</b> .....	<b>46</b>
11.1	General notes .....	46
11.2	Spare parts .....	47
11.3	Return .....	50
11.4	Disposal .....	50
<b>12</b>	<b>Accessories</b> .....	<b>51</b>
<b>13</b>	<b>Technical specifications</b> .....	<b>53</b>
<b>14</b>	<b>Appendix</b> .....	<b>54</b>
14.1	Settings of the Soliwave FDR56 .....	54
14.2	Overview of the device functions .....	55
	<b>Index</b> .....	<b>56</b>



# 1 Information on the document

## 1.1 Purpose of the document





These operating instructions contain all the information that is required in the various phases of the life cycle of the device: From product identification, incoming acceptance and storage, to installation, connection, operation and commissioning through to troubleshooting, maintenance and disposal.

## 1.2 Symbols used





### 1.2.1 Safety symbols

Symbol	Meaning
	<b>WARNING!</b> This warning alerts you to a dangerous situation. Failure to avoid this situation can result in serious or fatal injury.
	<b>NOTICE!</b> This note contains information on procedures and other facts that do not entail a risk of personal injury.





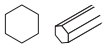

### 1.2.2 Electrical symbols

Symbol	Meaning
	Direct current
	Alternating current
	Direct and alternating current
	<b>Protective earth connection</b> A terminal which has to be grounded before other connections can be established.









### 1.2.3 Tool symbols

Symbol	Meaning
	Flat-blade screwdriver
	Phillips head screwdriver
	Allen key
	Open-ended wrench



### 1.2.4 Symbols for different types of information

Symbol	Meaning
	<b>Permitted</b> Indicates procedures, processes or actions that are permitted.
	<b>Tip</b> Indicates additional information.
	<b>Reference to documentation</b> Refers to the corresponding device documentation.
	<b>Reference to page</b> Refers to the corresponding page number.
	<b>Reference to figure</b> Refers to the corresponding figure number and page number.
	Visual inspection

### 1.2.5 Device-specific symbols

Symbol	Meaning
	<b>LED on</b> Indicates an illuminated LED
	<b>LED off</b> Indicates a non-illuminated LED
	<b>Configuration mode</b> Indicates the function number or value
	<b>Normal operation</b> Indicates only the signal strength of the limit detection
	<b>Key (+)</b> Indicates the key for increasing a function value
	<b>Key (-)</b> Indicates the key for reducing a function value
	<b>Free path</b> Indicates a free path of the level limit detection
	<b>Covered path</b> Indicates a covered path of the level limit detection

### 1.2.6 Symbols in graphics

Symbol	Meaning
<b>1, 2, 3, etc.</b>	Item numbers
<b>1., 2., 3., etc.</b>	Series of steps
	Hazardous area
	Safe area (non-hazardous area)

## 1.3 Documentation



The document types listed are available:

In the Download area of the Endress+Hauser website: [www.endress.com](http://www.endress.com) → Downloads

### 1.3.1 Standard documentation

Document	Purpose and content of the document
Technical information TI00443F/97/EN	<b>Planning aid for your device</b> This document contains all the technical specifications for the device and provides an overview of all the items that can be ordered for use in conjunction with or as part of the device.

### 1.3.2 Supplementary device-dependent documentation

Depending on the approval, safety instructions (XA) are supplied with the device when it is delivered. These safety instructions are an integral part of the operating instructions.

Feature 010	Approval	Safety instructions
BA	ATEX II 1/2D Ex ta/tb IIIC T102°C Da/Db IP66 ATEX II 2D Ex tb IIIC T102°C Db IP66	XA00509F/97/A3
CB	CSA C/US Class II, Div. 1, Group E-G	XA01244F/97/EN
IA	IECEx Ex ta/tb IIIC T102°C Da/Db IP66 IECEx Ex tb IIIC T102°C Db IP66	XA00543F/97/EN

## 2 Basic safety instructions

### 2.1 Requirements for personnel

The personnel for installation, commissioning, diagnostics and maintenance must meet the following requirements:

- Trained, qualified specialists: Must be qualified for this specific role and task
- Authorized by the plant operator
- Familiar with national regulations
- Before starting work: Read and make sure you have understood the instructions in the manual and supplementary documentation as well as the certificates (depending on the application)
- ▶ Follow the instructions and comply with the general requirements

Operating personnel must meet the following requirements:

- Must be instructed and authorized according to the requirements of the task by the plant operator
- Follow the instructions in this manual

### 2.2 Designated use

The device described in this manual is only meant for limit detection of bulk solids and liquids. Depending on the version ordered, the device may detect explosive substances as well.

- The manufacturer is not liable for damage caused by improper or non-designated use. Conversion work or changes must not be carried out on the device.
- The device is designed for use in industrial environments and may only be operated when installed.
- The device can and may only be repaired by the manufacturer.

The Soliwave microwave barrier is approved for use in hazardous areas.

#### **WARNING**

Proceed in accordance with the safety instructions.

→  7

### 2.3 Health and safety in the workplace

When working on and with the device:

- Wear the required personal protective equipment in accordance with national regulations.



## 2.4 Operational safety and reliability

Risk of injury!

- The device may only be operated if it is in perfect working order and is free from faults.
- The operator is responsible for ensuring that the device operates without incident.

Hazardous area

To eliminate danger to persons or the plant when the device is used in the hazardous area (e.g. explosion protection):

- Check the nameplate to verify whether the ordered device can be used as intended in the hazardous area.
- Observe the specifications in the separate supplementary documentation, which is an integral part of these operating instructions.

## 2.5 Product safety

This state-of-the-art device has been tested to make sure that it is designed and manufactured in accordance with good engineering practice and operates safely and reliably. It left the factory in perfect working order.

It meets the general safety standards and legal requirements. It also complies with the EU directives listed in the device-specific EU Declaration of Conformity. Endress+Hauser confirms this by displaying the CE mark on the device.

### 3 Product description

The Soliwave microwave barrier consists of the FQR56 transmitter and the FDR56 transceiver and is used for the non-contact level limit detection of powdery to lumpy bulk solids and liquids, for the purpose of monitoring and counting piece goods as well as for the detection of build-up.

The devices of the Soliwave microwave barrier are available in different versions; the choice of devices that are used depends on the specific application, as well as factors such as the types of area for which they are approved and the electrical connection.

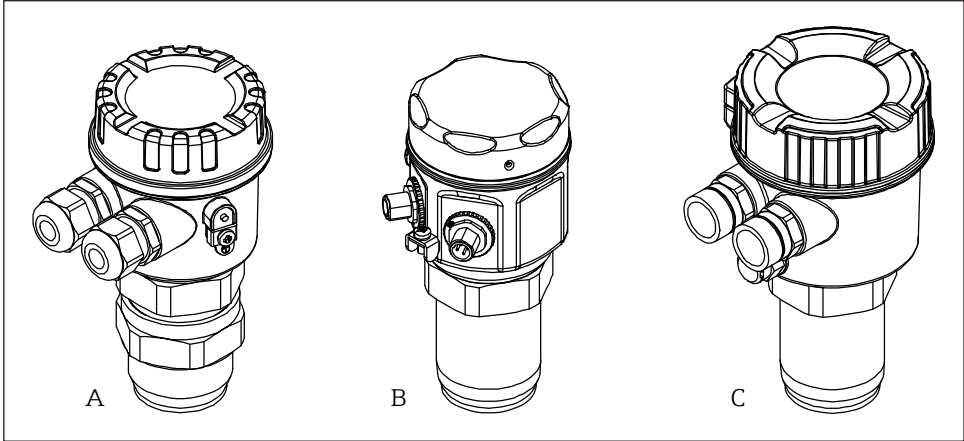

 1 Device variants

Versions	Examples		
	A	B	C
<b>Housing</b>	F16 Polyester	F15 Stainless steel	F34 Aluminum
<b>Electrical connection</b>	M20 gland	Harting connector	M12 connector
<b>Process connection</b>	G 1½ thread	R 1½ thread	1½ NPT thread

 Details about the available device variants can be viewed in the product configurator on the Endress+Hauser homepage [www.endress.com](http://www.endress.com).

## 4 Incoming acceptance and product identification

### 4.1 Incoming acceptance

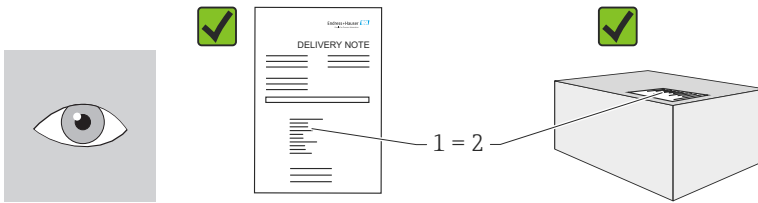

Is the order code on the delivery note (1) identical to the order code on the product sticker (2)?

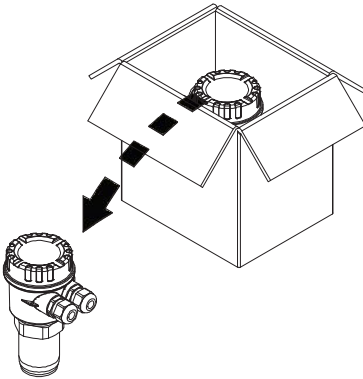

Are the goods undamaged?

Do the specifications on the nameplate correspond to the order information and the delivery note?



If one of the conditions is not satisfied:  
Contact your Endress+Hauser sales center.

### 4.2 Product identification

You can identify your device in the following ways:

- Using the nameplate specifications
- Using the order code with a breakdown of the device features on the delivery note
- Entering the serial numbers from the nameplates in *W@M Device Viewer* ([www.endress.com/deviceviewer](http://www.endress.com/deviceviewer)): All information about the device will be displayed.

For an overview of the scope of the technical documentation provided, refer to the following:

- The "Additional documentation" section
- The *W@M Device Viewer*: Enter the serial number from the nameplate ([www.endress.com/deviceviewer](http://www.endress.com/deviceviewer))

### 4.3 Nameplate

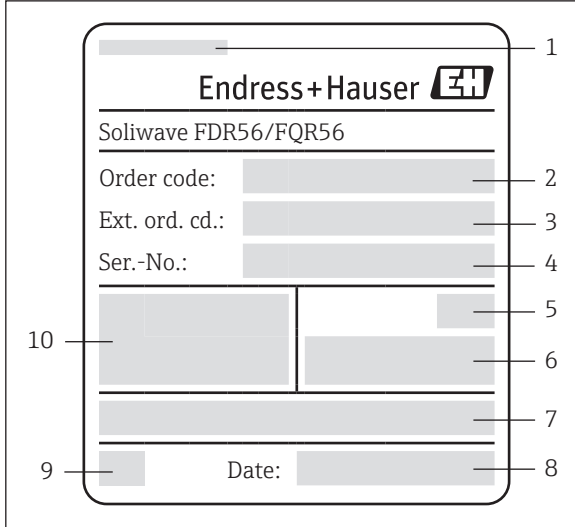

 2 Example of a nameplate

- 1 Place of manufacture
- 2 Order code
- 3 Extended order code
- 4 Serial number
- 5 Degree of protection (IP rating)
- 6 Ambient temperature range, optional text for approval
- 7 Operating instructions and safety instructions for the device
- 8 Date of manufacture: Year-Month
- 9 CE mark
- 10 Input and output parameters

### 4.4 Storage and transportation

Please note the following points:

- Store in the original packaging to ensure protection from shock.
- The permitted storage temperature is -40 to +80 °C (-40 to +176 °F); storage at the temperature limits is only permitted for a limited time (maximum 48 hours).

### 4.5 Disposal of packaging

The carton is environmentally compatible and 100 % recyclable in accordance with European Directive 2004/12/EC on packaging (recyclability is confirmed by means of the RESY symbol on the carton).

## 5 Installation

### 5.1 Installation requirements

#### 5.1.1 Installation location

The FQR56 transmitter and FDR56 transceiver can be installed in any position, for example on a container or a conveyor belt.

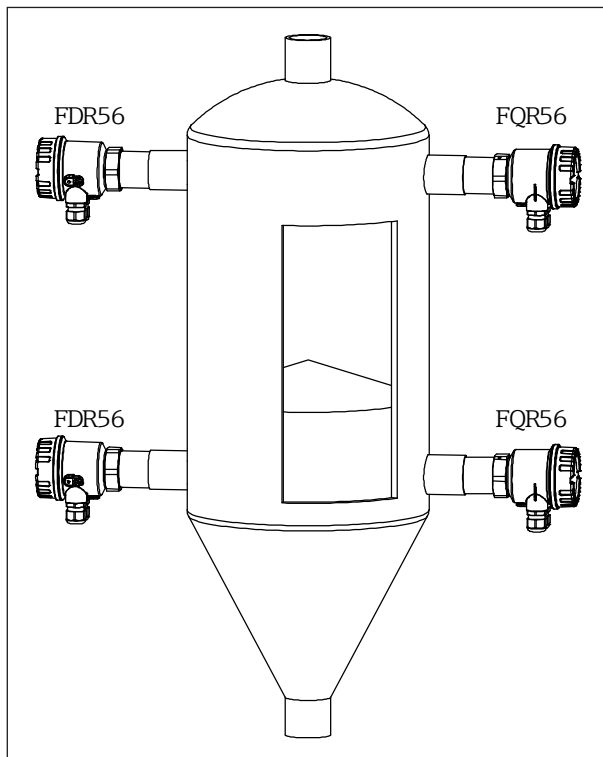

3 Level limit detection example (reporting when a container is full or empty)

#### NOTICE

- Choose a location to install the device where application-specific influences will be minimal.
- With vibrating mounting locations it is recommended to use devices with encapsulated electronics (see ordering structure "Accessory mounted").
- Avoid interference from reflections of metal parts.

 For devices intended for use in hazardous areas, please read the information and comply with the instructions in the Ex documentation (XA).

## 5.1.2 Notes on orientation

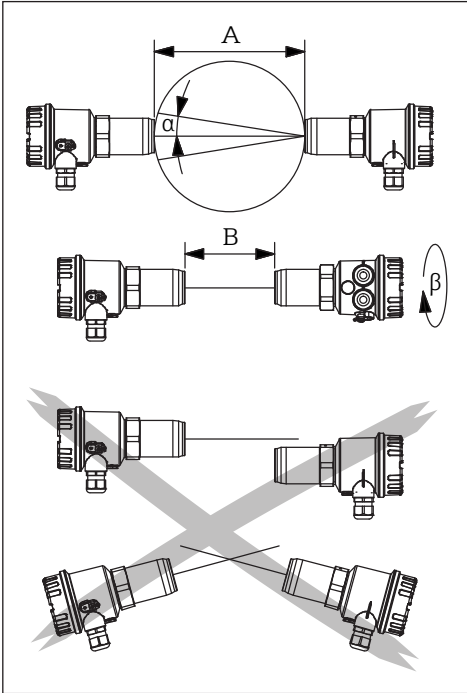

4 Orientation

- A Detection range 0.3 ... 100 m  
 B Detection range 0.03 ... 0.3 m  
 α Angle of radiation approx. 9°  
 β 90°

### NOTICE

- Since the microwaves are polarised, the FQR56 and FDR56 must not be out of alignment with one another along their longitudinal axis (exception: They may be installed at an angle of 180° relative to one another or 90° if the detection range is under 300 mm, see below).
- A minimum distance of 30 mm should be maintained between the FQR56 and the FDR56.
- If the detection range is under 300 mm, the FQR56 and FDR56 should be installed at an angle of 90° relative to one another to avoid possible overrangings.

When installed in front of microwave permeable windows, the signal quality can be improved by moving the FQR56 and FDR56 along their longitudinal axis.

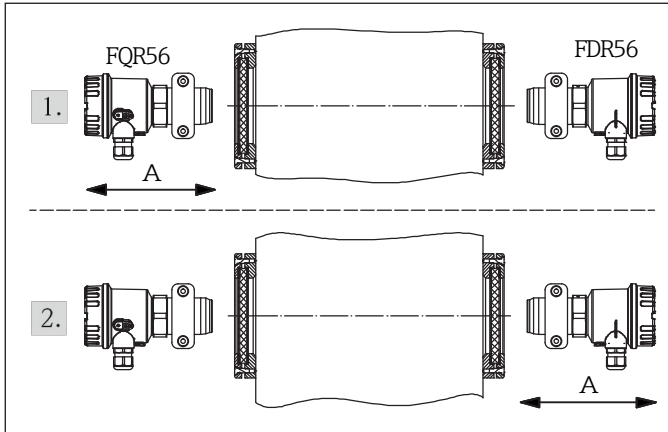

5 Improvement of signal quality

A Movement of  $\pm 10$  mm

Installation procedure to improve the signal quality on free or minimum covered path after an executed setup:

1. Move device 1 (example FDR56) to increase the maximum possible signal strength displayed on the FDR56.

(Example:  → )

2. Then move device 2 (example FQR56) to increase the maximum possible signal strength on the FDR56 again.

(Example:  → )

## NOTICE

Following any repositioning of the devices (horizontal in this case), a new setup should be performed (→ 34).

### 5.1.3 Using reflectors

If structural design factors do not allow the FQR56 and FDR56 to be installed directly opposite one another, the microwave beam can be redirected by means of flat metal mirrors (reflectors).

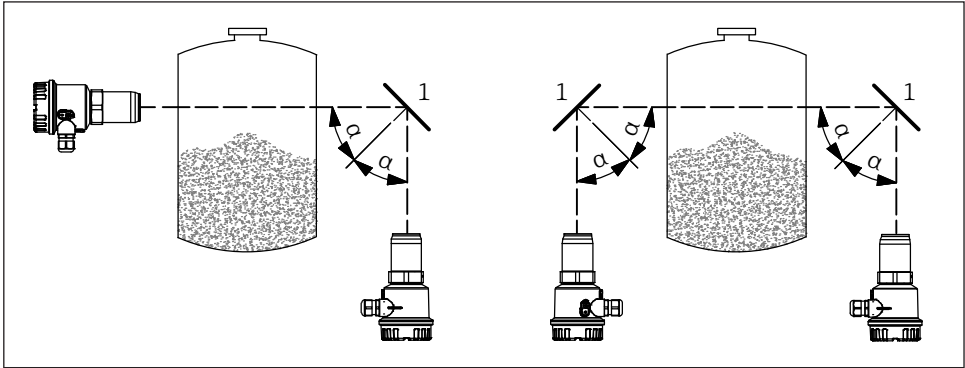

6 Using reflectors

1 Reflector

#### NOTICE

- Please note that the FQR56 and FDR56 must be positioned symmetrically with respect to the reflector (angle of entrance = angle of emission), as otherwise the FDR56 will not receive a signal that it can evaluate.
- Using reflectors reduces the range of the microwave barrier by approximately 10 % per reflector.

### 5.1.4 Installation with accessories

A choice of different process adapters is available from the range of accessories, depending on where you want to install the device and on the process conditions.

#### NOTICE

- For more information on the range of available accessories  
→ 51
- For more information on the various installation options  
→ TI00443F/97/EN

### 5.1.5 Parallel use

In practice, it can happen that several microwave barriers are operated in parallel at one location (e.g. for detecting multiple level limits in a pipe). To prevent mutual interference, five different channels (operating frequencies) can be selected on the FQR56 transmitter. In addition, it is recommended to mount every second microwave barrier rotated by 90 °.



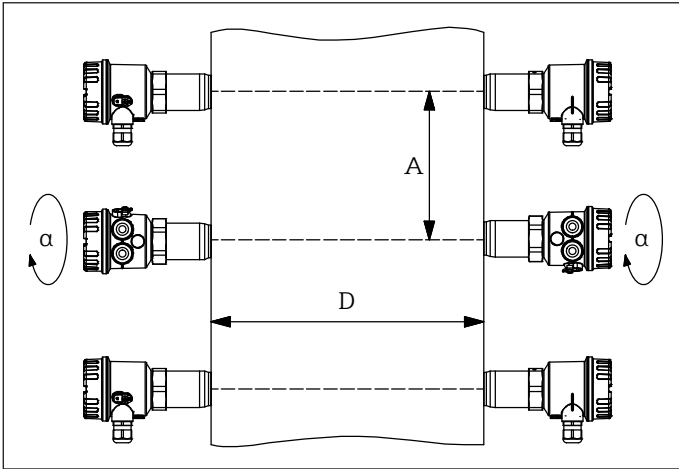

7 Parallel operation

$A$  Distance between microwave barriers

$D$  Detection distance

$\alpha$   $90^\circ$

When using different modulation frequencies and operation as shown in the example for parallel operation, the following dependency of the detection distance  $D$  to the distance of the individual microwave barriers  $A$  applies.

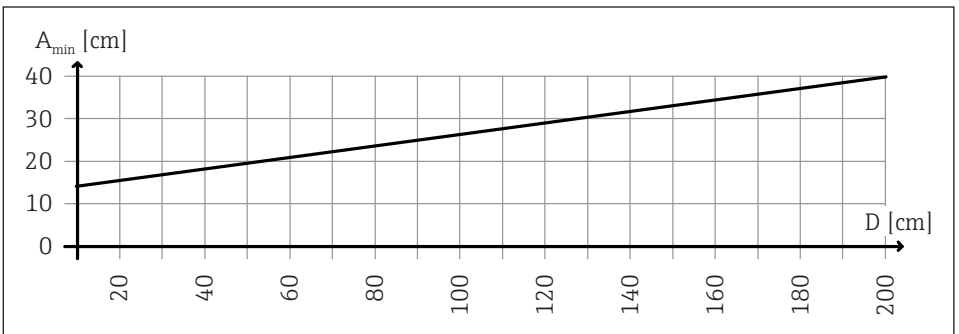

8 Dependency of detection distance to the distance of the microwave barriers

### NOTICE

- Use the channels in sequential order, i.e. 1, 2, etc. to 5, then back to 1, etc.
- No settings are necessary on the FDR56 transceiver.
- Details on the settings  
→ 33

### 5.1.6 Installation dimensions

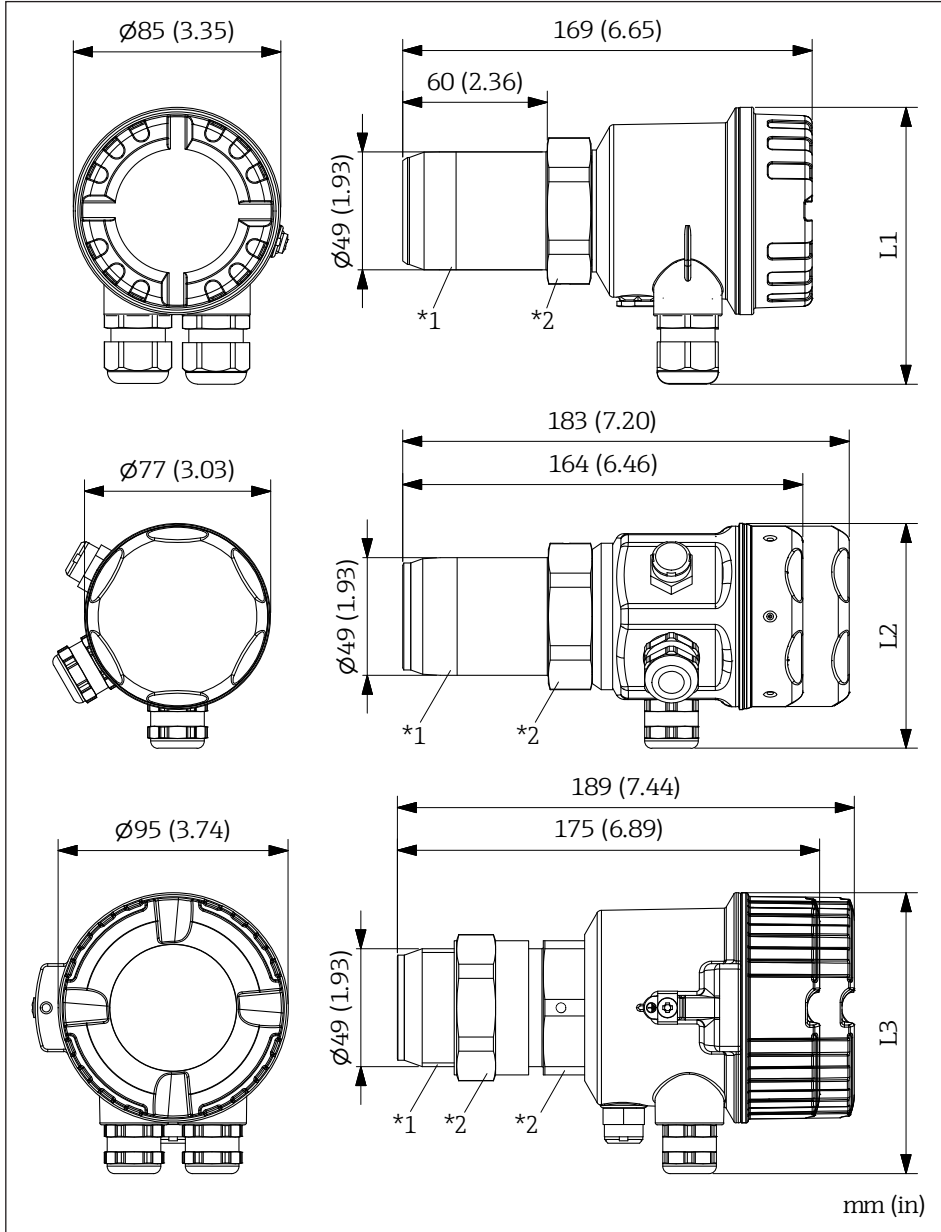

9 Installation dimensions

- 1 Connection thread R 1½, 1½ NPT or G 1½
- 2 Hexagon SW55

Dimensions L1 to L3, depending on the housing and electrical connection:

Housing	Electrical connection			
	M20 gland	½ NPT thread	Connector Binder M12	Connector Harting HAN8D
<b>F16, dimension L1</b>	114 (4.49)	111 (4.37)	101 (3.98)	133 (5.24)
<b>F15, dimension L2</b>	93 (3.66)	94 (3.70)	88 (3.46)	120 (4.72)
<b>F34, dimension L3</b>	116 (4.57)	117 (4.60)	111 (4.37)	143 (5.63)

## 5.2 Installing the device

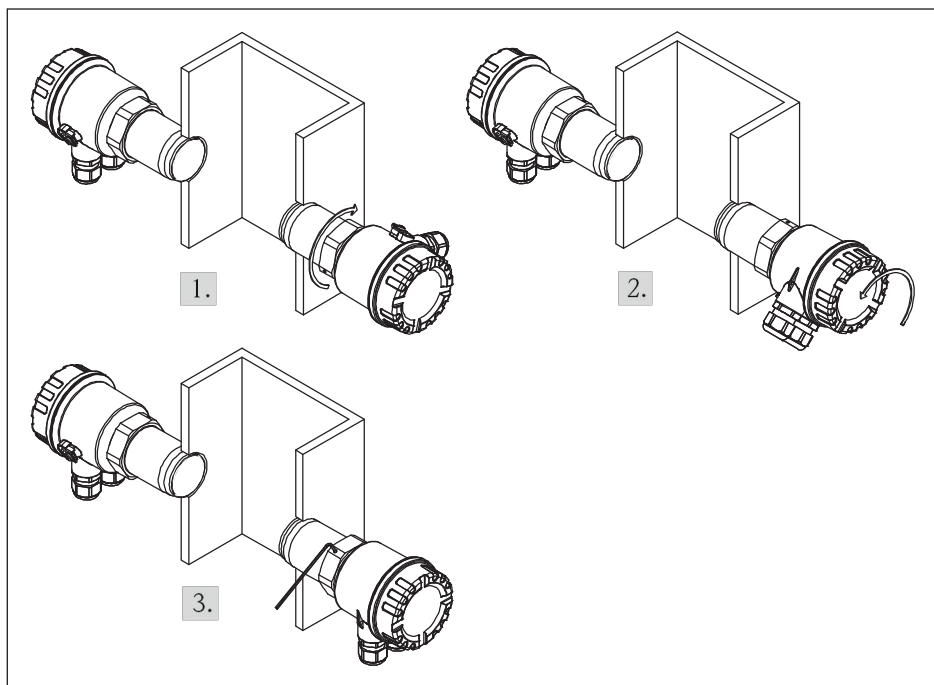

Both the FQR56 and the FDR56 have a standard thread (R 1½ in accordance with EN 10226, 1½ NPT in accordance with ANSI/ASME B1.20.1 or G 1½ in accordance with ISO 228-1) as the process connection, making them easy to install in existing container sleeves or nozzles.

### 5.2.1 Installation with a self-sealing connecting thread (R 1½ and 1½ NPT)





10 Installation with a self-sealing connecting thread

Installation procedure:

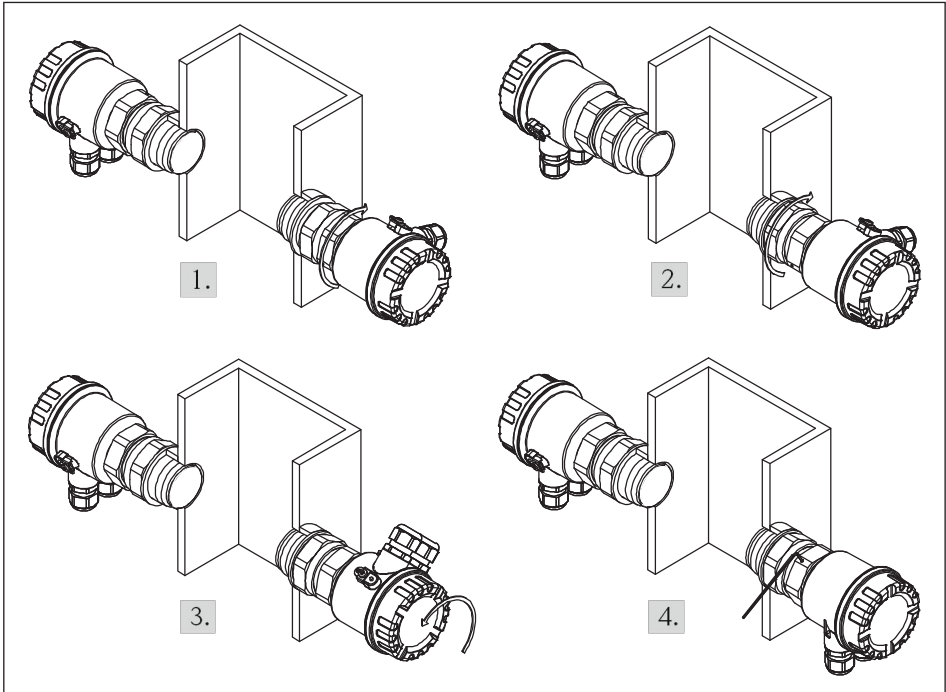

1. Screw the R 1½ or 1½ NPT self-sealing connecting thread into existing screw-in thread.  
 55 mm (AF)
2. Align the FQR56 and FDR56 with one another (the two devices must be positioned with their front faces facing one another on the same axis).
3. Fix the housing in place.  
 2 mm

### 5.2.2 Installation with a non-self-sealing connecting thread (G 1½)



 11 Installation with a non-self-sealing connecting thread

Installation procedure:

1. Slide the enclosed process seal over the process connection and screw the non-self-sealing connection thread G 1½ into the existing screw-in thread.  
 55 mm (AF)
2. Tighten the lock nut on the connection thread.  
 55 mm (AF)
3. Align the FQR56 and FDR56 with one another (the two devices must be positioned with their front faces facing one another on the same axis).

#### 4. Fix the housing in place.



#### NOTICE

- If the process connection is not screwed far enough into the process wall, there is a risk that material will accumulate in front of the FQR56/FDR56, thereby damping the microwave signal.
- If, on the other hand, the process connection is screwed too far into the process, there is a risk of damage occurring as a result of large product items falling.

### 5.3 Post-installation check

<input type="checkbox"/>	Is the device undamaged (visual inspection)?
<input type="checkbox"/>	Does the device conform to the measuring point specifications?  For example: <ul style="list-style-type: none"> <li>■ Process temperature</li> <li>■ Process pressure</li> <li>■ Ambient temperature</li> </ul>
<input type="checkbox"/>	Are the measuring point identification and labeling correct (visual inspection)?
<input type="checkbox"/>	Is the device adequately protected from moisture and direct sunlight?
<input type="checkbox"/>	Is the device properly secured?

## 6 Electrical connection

### 6.1 Connection requirements

#### NOTICE

Please note the following points before connecting up the device:

- The voltage supply must match the voltage specified on the nameplate.
- Switch off the supply voltage before connecting the device.
- Connect a potential matching line to the terminal to be used on the device before connecting to the power supply.
- When connecting to the public power supply, a power switch for the device must be installed within easy reach of the device. The switch is to be identified as a disconnecting device for the device (EN/IEC 61010).
- The cable glands and connectors are permitted for connecting fixed cables and lines only. The operator must ensure adequate strain relief.
- The device is to be attached so that the cable gland is protected from mechanical damage (degree of mechanical hazard "low" – impact energy: 4 joules).
- Unused guide openings must be sealed off using sealing plugs, the plastic transport sealing plug does not meet this requirement and must therefore be replaced during installation.



For devices intended for use in hazardous areas, please read the information and comply with the instructions in the Ex documentation (XA).

#### 6.1.1 Required tools

For the terminals:



0.6 x 3.5 mm

For the cable gland:



25 mm (AF) (plastic) or 22 mm (AF) (metal)

#### 6.1.2 Connecting cable requirements

The connecting cables provided by the customer must fulfil the following requirements:

- Electrical safety in accordance with applicable national regulations.
- Permitted temperature range →  53
- Normal installation cable with at least three wires
- Cable cross-sections: 0.2 to 2.5 mm<sup>2</sup> (24 to 12 AWG)

For the optionally supplied mating connectors, the following requirements apply:

- Clamping range of the cable:
  - 6 ... 8 mm (M12 mating connector, Binder series 713/763)
  - 7 ... 10.5 mm (Harting HAN8D mating connector)
- Cable cross-section: max. 0.75 mm<sup>2</sup> (18 AWG)

#### NOTICE

For the electrical connection with connectors there are prefabricated connecting cables available as accessories. →  51

## 6.2 Potential equalization

The following requirements apply to the potential equalization:

- The potential equalization must be connected to the external ground terminal on the FQR56/FDR56.
- For optimal electromagnetic compatibility, the potential equalization line should be as short as possible.
- The recommended minimum cable cross-section is 2.5 mm<sup>2</sup>.
- The potential equalization for the FQR56/FDR56 must be integrated into the existing potential equalization on site.

## 6.3 Connecting the device

The electrical connection is realized by internal terminals or external connectors.

### NOTICE

- For the electrical connection with connectors there are suitable mating connectors available for ordering according to the product configurator or as accessory.
- Prefabricated connection cables with suitable mating connectors are also available as accessory.
- For more information on the range of available accessories  
→  51

### 6.3.1 Connection of F16 (plastic) housing

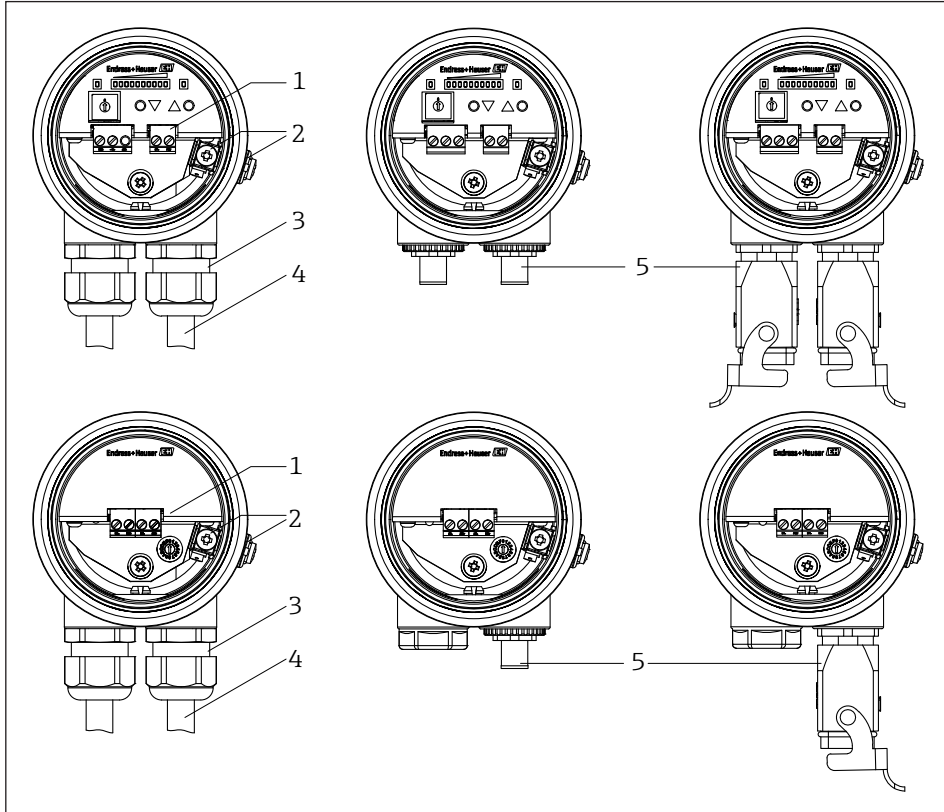

12 Device connection F16 housing

- 1 Connection terminals
- 2 Potential equalization connection
- 3 Cable gland  
(clamping areas 5 to 10 mm as per EN 50262 or 7 to 10 mm as per UL-514 B)
- 4 Connection cable
- 5 Mating connector (optional with prefabricated connection cable)

Procedure of connection with terminals and cable glands:

1. Insert cable into cable gland, tighten cap nut until the rubber seal is touched all around and then tighten cap nut with by  $\frac{1}{2}$  turn.
2. Connect the protective ground.
3. Connect the power supply and signal output.

Procedure of connection with connectors:

1. Connect the protective ground.
2. Connect the connectors and fix them.



### 6.3.2 Connection of F15 (stainless steel) and F34 (aluminium) housing

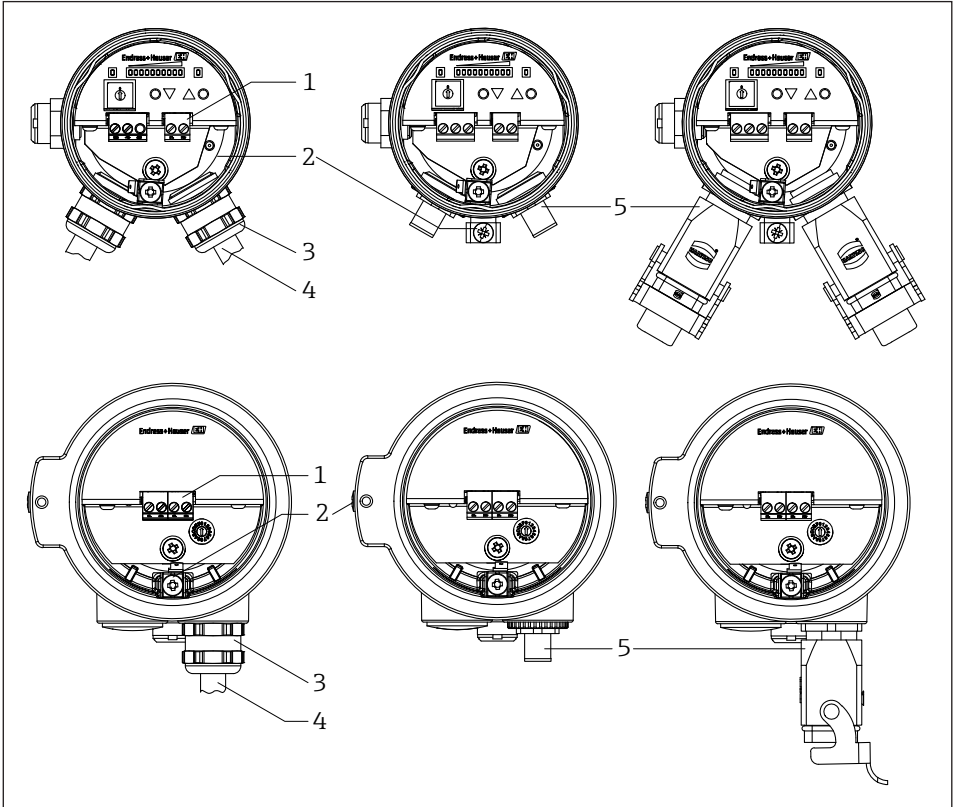

13 Device connection F15 and F34 housing

- 1 Connection terminals
- 2 Potential equalization connection
- 3 Cable gland  
(clamping area 7 to 10.5 mm)
- 4 Connection cable
- 5 Mating connector (optional with prefabricated connection cable)

Procedure of connection:

1. Insert cable into cable gland, tighten the cap nut (torque of up to 10 Nm).
2. Connect the protective ground.
3. Connect the power supply and signal output.

Procedure of connection with connectors:

1. Connect the protective ground.
2. Connect the connectors and fix them.

### 6.3.3 Power supply connection

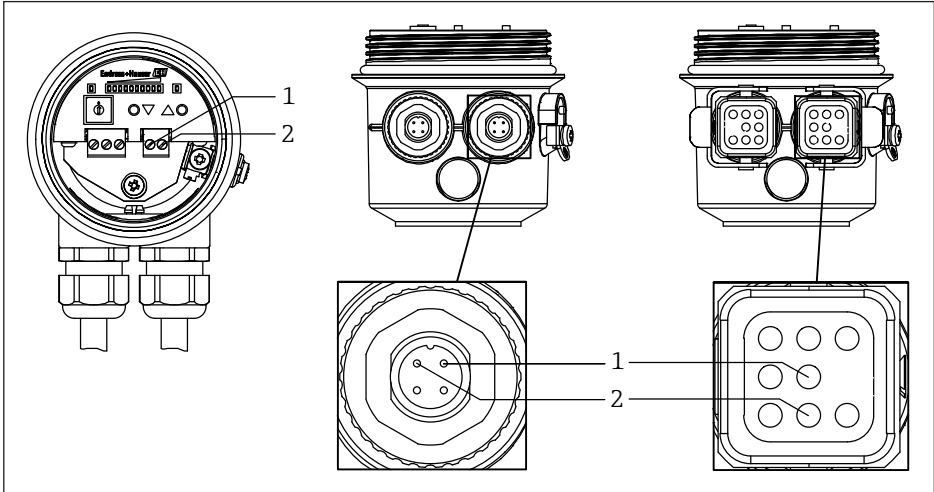

14 Power supply connection (connector 1)

Depending on the device version selected, a power supply with the following values can be connected:

- ~ 85 to 253 V, 50/60 Hz
- = 20 to 60 V or ~ 20 to 30 V, 50/60 Hz

Electrical connection	Power supply
Connection terminals	Terminal 1 - 2
M12 connector (Binder series 713/763)	Connector 1, contact 1 - 2
Harting connector type HAN8D	Connector 1, contact 1 - 2

#### NOTICE

- The polarity of the supply voltage can be set as required.
- The electrical connection with connector is only available for the power supply with = 20 ... 60 V or ~ 20 ... 30 V, 50/60 Hz (ordering option "E").

### 6.3.4 Signal output connection (only FDR56)

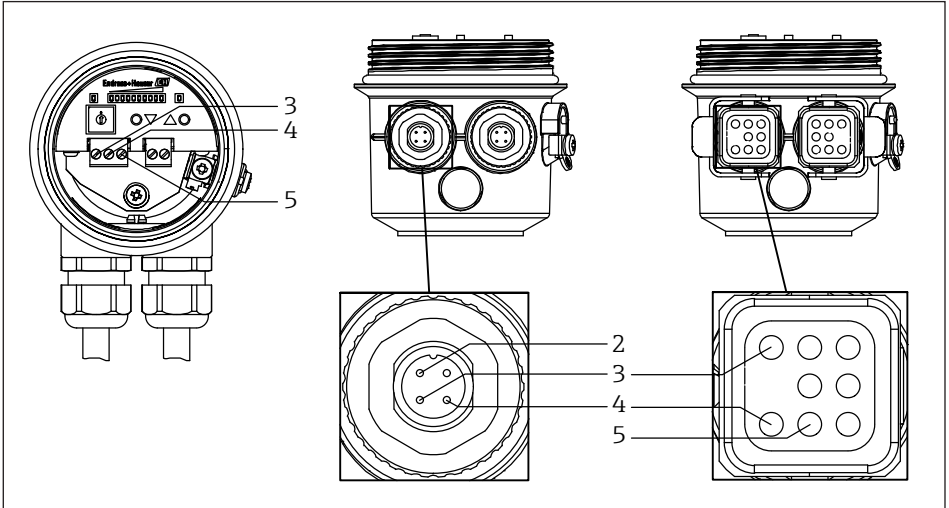

15 Signal output connection (connector 2)

#### 6.3.4.1 Relay

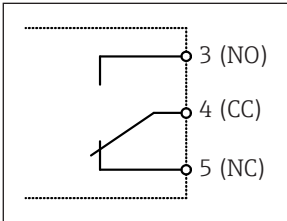

The following characteristic data apply for the relay signal output (floating switchover contact):

- Switching capacity:  
~ 250 V / 4 A, = 125 V / 0.4 A or 30 V / 4 A
- Switching frequency: max. 4 Hz

Electrical connection	Relay		
Connection terminals	Terminal 3 (NO)	Terminal 4 (CC)	Terminal 5 (NC)
M12 connector (Binder series 713/763)	Connector 2		
	Terminal 2 (NO)	Terminal 3 (CC)	Terminal 4 (NC)
Harting connector type HAN8D	Connector 2		
	Terminal 3 (NO)	Terminal 4 (CC)	Terminal 5 (NC)

#### NOTICE

- The contact material is also suitable for switching small-signal circuits. However, this is possible only if no inductive loads or higher currents have been switched previously.
- For a high switching frequency, please use the solid-state relay.
- When using the Harting connector type HAN8D the maximum switching voltage is = 120 V or ~ 50 V.

### 6.3.4.2 Solid-state relay

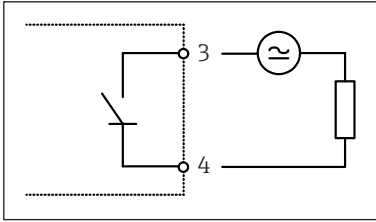

The following characteristic data apply for the solid-state relay signal output (switching contact of a semiconductor relay):

- Switching capacity:  $\sim 30\text{ V} / 0.4\text{ A}$  or  $\approx 40\text{ V} / 0.4\text{ A}$
- Switching frequency: max. 4 Hz

Electrical connection	Solid-state relay
Connection terminals	Terminal 3 – 4
M12 connector (Binder series 713/763)	Connector 2, contact 3 – 4
Harting connector type HAN8D	Connector 2, contact 3 – 4

### NOTICE

The polarity of the solid-state relay can be set as required.

### 6.3.4.3 Current output

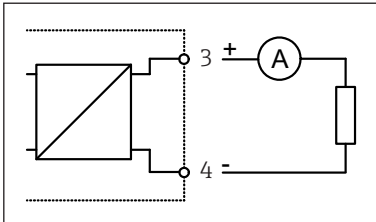

The following characteristic data apply for the current output:

- 4-20 mA, active
- Max. load: 600  $\Omega$

Electrical connection	Current output
Connection terminals	Terminal 3 (+) – 4 (-)
M12 connector (Binder series 713/763)	Connector 2, contact 3 (+) – 4 (-)
Harting connector type HAN8D	Connector 2, contact 3 (+) – 4 (-)

## 6.4 Post-connection check

<input type="checkbox"/>	Are the device and the connecting cable(s) undamaged (visual inspection)?
<input type="checkbox"/>	Do the cables used comply with the requirements?
<input type="checkbox"/>	Do the mounted cables have adequate strain relief?
<input type="checkbox"/>	Are all cable glands or connectors installed, firmly tightened and correctly sealed?
<input type="checkbox"/>	Does the supply voltage match the specifications on the nameplate?
<input type="checkbox"/>	Is the terminal assignment correct?
<input type="checkbox"/>	If power supply is switched on: Is the device operational (at least the green LED illuminated)?
<input type="checkbox"/>	Is the housing cover installed and firmly tightened?
<input type="checkbox"/>	For Ex version only: Is the lid safeguard installed correctly?

## 7 Operating options

### 7.1 Overview

#### 7.1.1 FDR56 transceiver

The microwave barrier is configured on the FDR56 using a function selection switch (encoding switch) and two operating buttons. With these, among other think, the adjustment of the sensitivity is carried out for clear and unambiguous limit detection.

The parameter configuration is stored internally and is retained even after the supply voltage is disconnected. No other operator intervention is necessary during operation.

The adjustment to the process conditions only needs to be performed during initial installation. Later alterations can be performed and saved at any time.

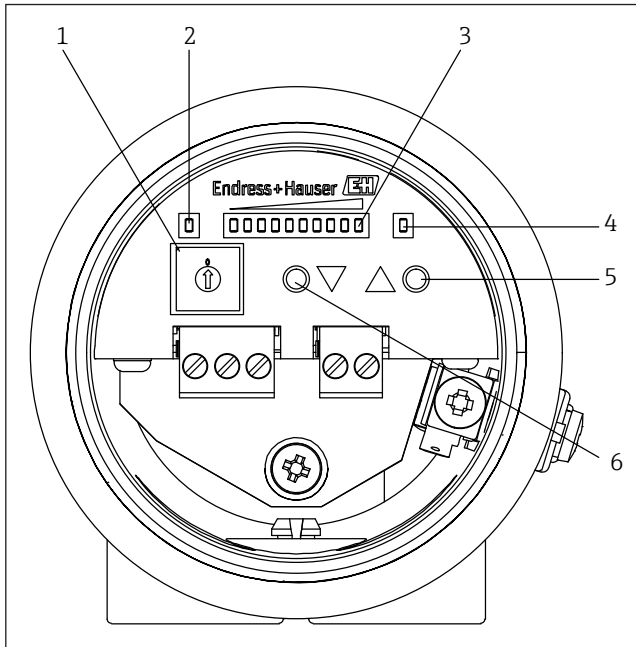

16 Display and operating elements of the FDR56

- 1 Function selection switch
- 2 Ready LED (green)
- 3 Display
  - Signal strength in normal mode
  - Function number and function value in configuration mode
- 4 Switch output LED (yellow), relay
- 5 Operating button for increase or toggle
- 6 Operating button for decrease or toggle

**NOTICE**

- The device is in operating mode in encoding switch position "0" only. All other positions are for parameter configuration. The microwave barrier continues to work in the background, changed settings are taken into account directly.
- Remember to reset the encoding switch to the initial position "0" (= operation) when you have finished configuring settings.

**7.1.2 FQR56 transmitter**

To prevent intermodulation interference from microwave barriers located close to each other, different channels (various operating frequencies) for parallel operation (→ 33) can be configured with the rotary coding switch on the FQR56 transmitter.

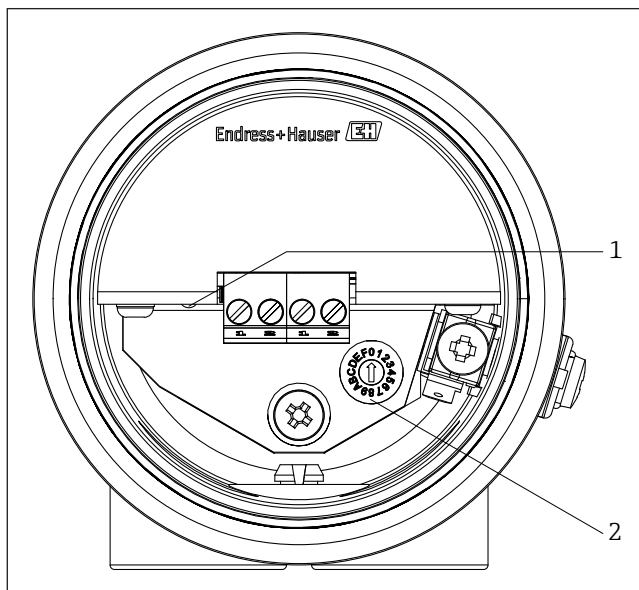

17 Display and operating elements of the FQR56

- 1 Ready LED (green)
- 2 Parallel channel switch

**NOTICE**

In individual operation, the switch position is irrelevant and can be any desired position.

## 7.2 Structure and function of the operating menu

### 7.2.1 FDR56

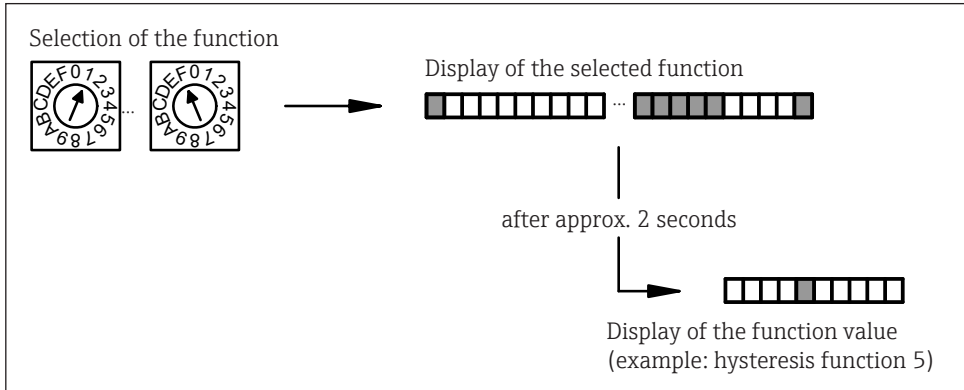

18 Operation of the FDR56





Procedure of parametrization:

1. Select any function (overview → 55)
  - Encoding switch 1 to F
  - The display shows the selected function for two seconds.
  - Example function 3:
2. Setting the selected function
  - Example: Function 3 (manual setup on free path)
  - You can use the two operating buttons and to increase or decrease the sensitivity.
  - or
  - or
  - ...
3. The configured value is stored as soon as the function is switched. The value can be displayed again at any time by selecting the corresponding parameter configuration function and changed if necessary.
4. Once parameter configuration is complete (i.e. once the microwave barrier has been adapted to the medium in question), the encoding switch must be returned to the "0" position. The Soliwave FDR56 is now ready for operation.



## 7.2.2 FQR56

The following channels (operating frequencies) can be select according to the following table.

Channel	1	2	3	4	5
Switch position					



### NOTICE

- Use the channels in sequential order, i.e. 1, 2, etc. to 5, then back to 1, etc.
- The switch positions 5 ... F are without function, the channel corresponds to the position 0 in these settings.

## 8 Commissioning

### 8.1 Installation and function check

Make sure that the post-installation and post-connection checks have been carried out before you commission your measuring point:

- "Post-installation check" checklist →  21
- "Post-connection check" checklist →  29

 You can write down all selected settings for documentation purposes (table →  54).

### 8.2 Switching on the device



The microwave barrier will be switched on by an applied power supply on FQR56 transmitter and FDR56 transceiver.

 The green LED glows on both devices when power supply is applied.

### 8.3 Configuring the device

The microwave barrier can be calibrated on the FDR56. The setup can be made on free or covered path. Therefore there are functions for automatic and manual setup available.

For most applications the automatic setup is sufficient.

 Additional settings for optimal adaptation  
 →  37  
 Setup parallel operation mode  
 →  33

#### 8.3.1 Calibration with free or minimum covered path (function 1)



This automatic setup function can be used if the path is free or minimum covered.

1. Set encoding switch to Position 1  
 → Display of the function number



After 2 seconds: Display of the current signal strength, example:



2. Simultaneously press the  and  keys on the device with free or minimum covered path  
 → Automatic calibration is carried out  
 → Display of the signal strength with maximum solid flow



3. Move the encoding switch to the initial position 0  
 → Display of the current signal strength

### Optional: Additional manual calibration with maximum covered path (function 4)

For most applications the automatic setup is sufficient. The manual setup can be used to adapt the microwave barrier individually to the application or medium.

If after an automatic setup on free path (function 1) the medium can not be detected safely (switching point of the limit detection is not undercut on maximum covered path), the sensitivity must be reduced with this manual setup function 4.

1. Move the encoding switch to position 4

→ Display of the function number



After 2 seconds: Display of the current signal strength, example:



2. Press the ▲ or ▼ key on the device to achieve an increase or reduction of the signal strength display with maximum covered path  
→ Display of the signal strength with maximum covered path (all 10 LEDs are not lit)



3. Move the encoding switch to the initial position 0  
→ Display of the current signal strength

### NOTICE

- The Soliwave microwave barrier is calibrated, if with maximum covered path
  - a) and devices with switching output the switching point (LED 5) is undercut safely or
  - b) on devices with current output all 10 LEDs are not lit.
- A repeated automatic calibration (function 1 or function 2) resets any calibration carried out earlier.

### 8.3.2 Calibration with maximum covered path

This automatic setup function can be used if the path is maximum covered.

1. Move the encoding switch to position 2

→ Display of the function number



After 2 seconds: Display of the current signal strength, example:



2. Simultaneously press the ▲ and ▼ keys on the device with maximum covered path

→ Automatic calibration is carried out

→ Display of the signal strength with maximum covered path



3. Move the encoding switch to the initial position 0

→ Display of the current signal strength

#### Optional: Additional manual calibration with free or minimum covered path (function 3)

For most applications the automatic setup is sufficient. The manual setup can be used to adapt the microwave barrier individually to the application or medium.

If after an automatic setup with covered path (function 2) the condition "free path" can not be detected safely (switching point of the limit detection is not exceeded with free or minimum covered path), the sensitivity must be increased with this manual setup function 3.

1. Move the encoding switch to position 3

→ Display of the function number



After 2 seconds: Display of the current signal strength, example:



2. Press the ▲ or ▼ key on the device to achieve an increase or reduction of the signal strength display with free or minimum covered

→ Display of the signal strength with free or minimum covered path (all 10 LEDs illuminate)



3. Move the encoding switch to the initial position 0

→ Display of the current signal strength

#### NOTICE

- The Soliwave microwave barrier is calibrated, if with free or minimum covered path
  - a) and devices with switching output the switching point (LED 5) is exceeded safely or
  - b) on devices with current output a minimum of 6 LEDs are lit (ideally all 10 LEDs are lit).
- A repeated automatic calibration (function 1 or function 2) resets any calibration carried out earlier.

## 8.4 Advanced settings

The following settings are optional and not required in most cases; it may make sense to use them only for special adaptations to the application and/or to the downstream analysis (process control system):

- Hysteresis (**function 5**): Adjusting of a switching hysteresis (only for signal output relay or solid-state relay, → 437)
- Limit signal function (**function 6**): Adjusting of the switching characteristics (only for signal output relay or solid-state relay, → 438)
- Switching delay (**function 7** and **function 8**): Adjusting of a switch-on and/or switch-off delay (only for signal output relay or solid-state relay, → 439)
- Damping (**function A**): Averaging of the detected signal strength (→ 441)

### NOTICE

Overview of the factory defaults

→ 44



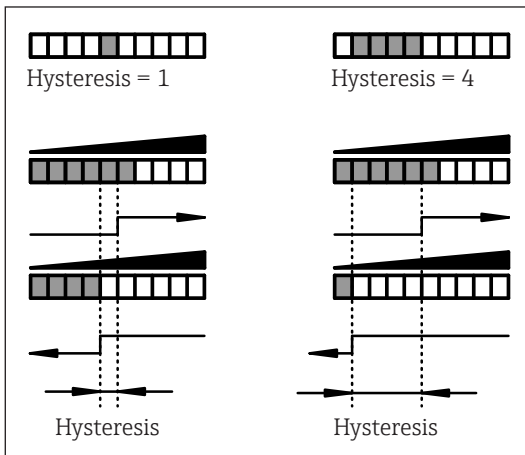

#### 8.4.1 Hysteresis (function 5)

A hysteresis from 1 to 4 LEDs can be programmed for the switch output (change-over contact with relay, normally open contact with solid-state relay, of no significance for current output). The fixed switch point with increasing signal strength is at the transition from LED 5 to LED 6. For decreasing signal strength, the switch point can be configured between the transition from LED 5 to LED 4 (minimum hysteresis of an LED) and maximum between LED 2 to LED 1 (maximum hysteresis of four LEDs).



19 Adjustment of the switching hysteresis

The hysteresis is configured as follows:

1. Move the encoding switch to position 5  
→ Display of the function number  
  
→ After 2 seconds: Display of the configured hysteresis, example:  

2. Press the  or  key on the device in order to configure the hysteresis in the range from 1 to 4 LEDs  
→ Display of the changed hysteresis, example:  
 (hysteresis increased from 3 LEDs to 4 LEDs)
3. Move the encoding switch to the initial position 0  
→ Display of the current signal strength

## NOTICE

- A larger hysteresis can also be used to prevent the output from continuously switching with a fluctuating signal strength. If, for example, the signal strength continuously fluctuates between the third and eighth LED, the factory default hysteresis of an LED would lead to the switch output continuously switching when the fourth LED is undershot.
- This setting has no significance for the current output.

### 8.4.2 Limit signal function (function 6)

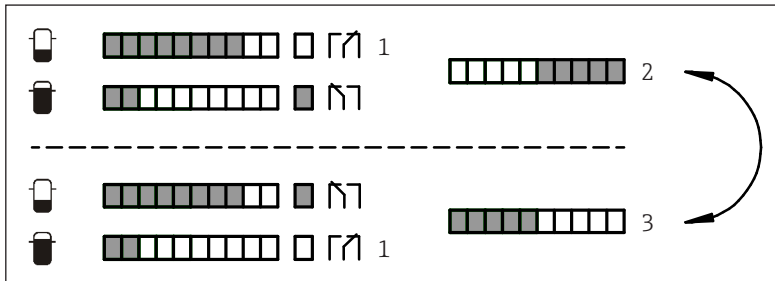



For devices with a relay and solid-state relay, the limit signal function determines the switching behavior upon exceeding and undershooting the limit value (upper limit value LED 5, lower limit determined by hysteresis).







 20 Adjustment of limit signal function

- 1 Rest position (supply voltage missing)
- 2 Minimum safety
- 3 Maximum safety (default setting)

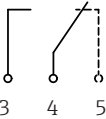
The limit signal function is configured as follows:

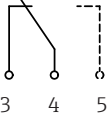
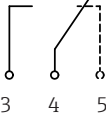
1. Move the encoding switch to position 6  
 → Display of the function number  
  
 → After 2 seconds: Display of the configured limit signal function, example:  

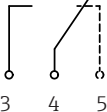
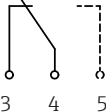
2. Press the  or  key on the device in order to change between the two possible limit signal functions  
 → Display of the changed limit signal function, example:  

3. Move the encoding switch to the initial position 0  
 → Display of the current signal strength

Output	Rest position	Setting	Exceeding of switch point (LED 5)	Undershooting hysteresis (function 5)
Relay (Contact 3-4-5) or Solid-state relay (Contact 3-4)				
				

**NOTICE**

- These settings are for adapting the switching function to the downstream analysis (process control system).
- This setting has no significance for the current output.

**8.4.3 Switching delay (function 7 and 8)**

An additional switch-on and/or switch-off delay can be configured for the switch output. This can be used, for example, to stabilize the switch output when the signal strength fluctuates greatly, so that the relay does not switch until the switch point has been exceeded or undershot for a corresponding time.

As long as the times, in which a maximum limit is exceeded, are smaller than the switch-off delays, the switch output remains in the "uncovered state" (function 6 = standard setting).

**NOTICE**

The following figure depends on the setting of the limit signal function (function 6)

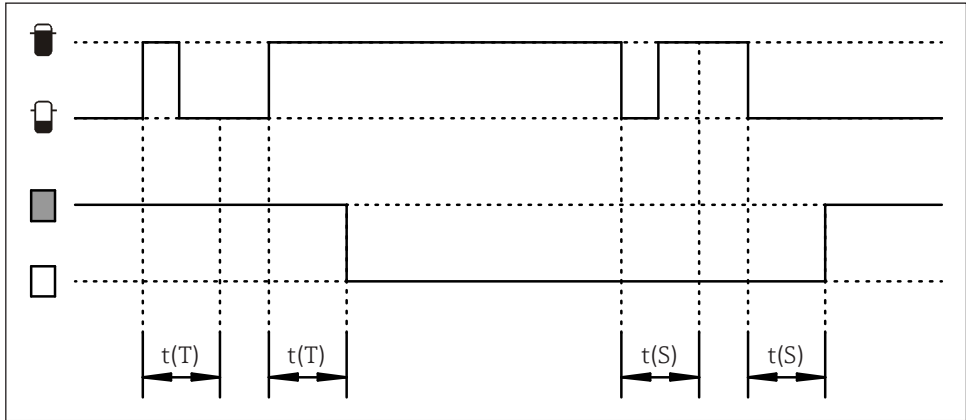

21 Adjustment of switching delays

$t(S)$  Switch-on delay (function 7)

$t(T)$  Switch-off delay (function 8)

Setting	Delay $t(S), t(T)$	Setting	Delay $t(S), t(T)$
	off		2 s
	100 ms		3 s
	200 ms		5 s
	300 ms		10 s
	500 ms		20 s
	1 s		

The switching delays  $t(S)$  and  $t(T)$  are configured as follows:

1. Move the encoding switch to position 7 (**switch-on delay  $t(S)$** ) or position 8 (**switch-off delay  $t(T)$** )  
 → Display of the function number, switch-off delay example  
  
 → After 2 seconds: Display of the configured delay time, example:  
 (switch-off delay = off)
2. Press the or key on the device to configure the delay time  
 → Display of the changed delay time, example:  
 (switch-off delay = 300 ms)
3. Move the encoding switch to the initial position 0  
 → Display of the current signal strength











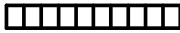

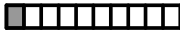
**NOTICE**

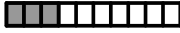

- The delays impact only the switch outputs (relay and solid-state relay); they have no significance for the current output.
- If the process conditions are unstable, the signal strength can be calmed with a parameterizable damping (function A).

**8.4.4 Damping (function A)**

For unstable process conditions, the display of the signal strength can be stabilized by a configurable damping; averaging of the output signal takes place here over the set time.

Setting	Damping	Setting	Damping
	off		2 s
	100 ms		3 s
	200 ms		5 s
	300 ms		10 s
	500 ms		20 s
	1 s		

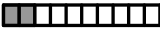
The damping is configured as follows:

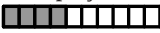

1. Move the encoding switch to position A  
→ Display of the function number  
  
→ After 2 seconds: Display of the configured damping, example:  
 (damping = 200 ms)
2. Press the  or  key on the device to configure the damping  
→ Display of the changed damping, example:  
 (damping increased to 500 ms)
3. Move the encoding switch to the initial position 0  
→ Display of the current signal strength

**NOTICE**











- The set time not only damps the signal strength display, but also impacts the switch output (for example, a delayed switching) and the current output (rises/falls with a delay).
- If only the switch output is to be stabilized, it is advisable to configure a switch-on and/or off delay (→ 39).
- The switch-on and/or off delay and damping can be combined, which causes the detection to be significantly slower.

## 8.5 Resetting to factory defaults (function F)

You can reset the FDR56 to its factory defaults with this function as follows:

1. Move the encoding switch to position F  
→ Display of the function number  
  
→ All LEDs go out after 2 seconds.
2. Press the  and  keys on the device to set it to the factory defaults  
→ All LEDs illuminate as confirmation.
3. Move the encoding switch to the initial position 0  
→ Display of the current signal strength

Overview factory defaults:

Function	Description	Default value
5 	Hysteresis	
6 	Limit signal function	
7 	Switch-on delay	
8 	Switch-off delay	
A 	Damping	



### NOTICE

- All unlisted functions are automatic functions without factory default.
- Overview device functions  
→  55

## 8.6 Simulation

The FDR56 gives you the ability to simulate a signal and thereby an output variable, independent of the process, for example, in order to configure a downstream PLC or a data logger.

The simulation is carried out as follows (function 6 = standard setting):

1. Move the encoding switch to position 9  
→ Display of the function number  
  
→ After 2 seconds: Display of the simulated signal strength  
 (signal strength = 0 LEDs, switch output: not switched, current output: 4 mA)
2. Press the ▲ or ▼ key on the device to configure the desired signal strength  
→ Display of the changed simulated signal strength, example:  
 (signal strength = 8 LEDs, switch output: switched, current output: 16.8 mA)
3. Move the encoding switch to the initial position 0  
→ Display of the current signal strength

### NOTICE

The simulation ends as soon as the encoding switch is no longer at position 9.

## 9 Diagnostics and troubleshooting

### 9.1 General troubleshooting





Make sure beforehand that the following checks have been carried out:

- "Post-mounting check" checklist (→ 21)
- "Post-connection check" checklist (→ 29)

#### NOTICE



If the detection range is under 300 mm, the FQR56 and FDR56 should be installed at an angle of 90° relative to one another, to avoid possible overrangings and therefore faulty measurements (→ 4).

### 9.2 Overview of diagnostic information

Fault	Reason	Remedy
Yellow LED off with uncovered path	No power or power too low (green LED does not light up)	Check power supply
	Transmitter FQR56 defective	Replace transmitter
	Path of rays covered (e.g. window dirty)	Check path of rays and clean if necessary
	Wrong installation	Check installation →  29
	Wrong settings	Check settings →  34
Yellow LED on with covered path	Transceiver FDR56 defective	Replace transceiver
	Attenuation of the product too low	Adjust sensitivity →  34
	Wrong settings	Check settings →  34
Strong fluctuation of signal strength	Turbulent application, reflections and so on	Increase signal damping →  41

### 9.3 Resetting the device

To reset the FDR56 transceiver, proceed as follows:

- De-energise the device or disconnect the connector; all settings are retained  
→ 19
- Activate the reset function **F**; all settings will be replaced by factory defaults  
→ 42

## 10 Maintenance

No special maintenance work is required.

### 10.1 Maintenance recommendation

If medium is building up, however, we recommend regularly checking the beam path and cleaning where appropriate. This can be done using:

- PTFE or ceramic disk at the process connection
- Sight glass fitting or configurable accessories with PTFE or ceramic disk
- Materials the customer uses in the process that allow microwaves to pass through

### 10.2 Endress+Hauser services

Endress+Hauser offers a wide variety of services for maintenance such as on-site inspection, including maintenance or device tests.



Contact your Endress+Hauser sales center for information on services and spare parts.

# 11 Repair

The FQR56 and FDR56 devices of the Soliwave microwave barrier are not to be repaired on-site.

## 11.1 General notes

### 11.1.1 Repair policy

The Endress+Hauser repair policy provides that repairs to the modularly designed devices can be carried out by Endress+Hauser Service or customers with corresponding training.

Spare parts are combined in useful kits and are accompanied by the associated replacement instructions. For more information on service and spare parts, please contact Endress+Hauser Service.

### 11.1.2 Repairing Ex-certified devices

When repairing Ex-certified devices, please also note the following:

- Ex-certified devices may be repaired only by properly trained personnel or Endress+Hauser Service.
- Relevant standards, national regulations and safety instructions (XA) and certificates must be observed.
- Only original Endress+Hauser spare parts may be used.
- When ordering spare parts, please note the device designation on the nameplate. Parts may only be replaced with the same parts.
- Carry out repairs according to the instructions. Following a repair, the individual testing prescribed for the device must be carried out.
- A certified device may be converted to another certified version by Endress+Hauser Service only.
- All repairs and modifications must be documented.

### 11.1.3 Replacing the electronics or a device

After replacing the electronics or a device (FDR56), a new calibration is required, since the settings are saved in the electronic insert.

If you are still able to read out the settings before making the replacement, make note of them (→  54) and reenter them after the replacement. In any way, a new calibration must be done after that!

#### NOTICE

The electronics of device variants with connector and extended ordering option "electronics encapsulated" can only be replaced by the manufacturer.



Details about the available device variants can be viewed in the product configurator on the Endress+Hauser homepage [www.endress.com](http://www.endress.com).

## 11.2 Spare parts

Electronic inserts are available for all device versions. Specifications for the electronics you need are located on the nameplate.

### NOTICE



- All spare parts for the device, including the order code, are listed and can be ordered at the Internet site [www.endress.com/deviceviewer](http://www.endress.com/deviceviewer) (W@M Device Viewer). If available, the corresponding Installation Instructions can also be downloaded there.
- Each electronic insert is identified by an order number. When making a replacement, please make sure that only the correct electronics are installed.

### WARNING

- In the case of devices certified for potentially explosive areas, installation of incorrect electronics leads to loss of conformity, which means the device is no longer permitted to be operated in a hazardous area.
- Selection of an incorrect supply voltage can lead to the immediate destruction of the electronics.
- Selection of an incorrect signal output can lead to the downstream machine getting damaged.

### 11.2.1 Available electronics

Order number	Device variant	Approval
<ul style="list-style-type: none"> <li>▪ 71125423</li> <li>▪ 71324253</li> <li>▪ 71324267</li> <li>▪ 71125424</li> <li>▪ 71324258</li> <li>▪ 71324268</li> <li>▪ 71125425</li> <li>▪ 71324271</li> <li>▪ 71125426</li> <li>▪ 71324274</li> <li>▪ 71125427</li> <li>▪ 71324276</li> <li>▪ 71125428</li> <li>▪ 71324277</li> </ul>	FDR56-AA1A****, F15/F16 (Datecode up to 04.2016) FDR56-AA1A****, F15/F16 (Datecode from 05.2016) FDR56-AA1A****, F34 FDR56-AA1E****, F15/F16 (Datecode up to 04.2016) FDR56-AA1E****, F15/F16 (Datecode from 05.2016) FDR56-AA1E****, F34 FDR56-AA2A****, F15/F16 FDR56-AA2A****, F34 FDR56-AA2E****, F15/F16 FDR56-AA2E****, F34 FDR56-AA3A****, F15/F16 FDR56-AA3A****, F34 FDR56-AA3E****, F15/F16 FDR56-AA3E****, F34	 without
<ul style="list-style-type: none"> <li>▪ 71125417</li> <li>▪ 71324242</li> <li>▪ 71125418</li> <li>▪ 71324243</li> </ul>	FQR56-AAA****, F15/F16 FQR56-AAA****, F34 FQR56-AAE****, F15/F16 FQR56-AAE****, F34	

Order number	Device variant	Approval
<ul style="list-style-type: none"> <li>■ 71125429</li> <li>■ 71324279</li> <li>■ 71324300</li> <li>■ 71125430</li> <li>■ 71324280</li> <li>■ 71324301</li> <li>■ 71125431</li> <li>■ 71324324</li> <li>■ 71125432</li> <li>■ 71324325</li> <li>■ 71125433</li> <li>■ 71324327</li> <li>■ 71125434</li> <li>■ 71324329</li> </ul>	FDR56-BA1A****, F15 (Datecode up to 04.2016) FDR56-BA1A****, F15 (Datecode from 05.2016) FDR56-BA1A****, F34 FDR56-BA1E****, F15 (Datecode up to 04.2016) FDR56-BA1E****, F15 (Datecode from 05.2016) FDR56-BA1E****, F34 FDR56-BA2A****, F15 FDR56-BA2A****, F34 FDR56-BA2E****, F15 FDR56-BA2E****, F34 FDR56-BA3A****, F15 FDR56-BA3A****, F34 FDR56-BA3E****, F15 FDR56-BA3E****, F34	 ATEX
<ul style="list-style-type: none"> <li>■ 71125419</li> <li>■ 71324246</li> <li>■ 71125420</li> <li>■ 71324247</li> </ul>	FQR56-BAA****, F15 FQR56-BAA****, F34 FQR56-BAE****, F15 FQR56-BAE****, F34	
<ul style="list-style-type: none"> <li>■ 71258315</li> <li>■ 71258316</li> <li>■ 71258317</li> <li>■ 71258318</li> <li>■ 71258319</li> <li>■ 7125832</li> </ul>	FDR56-CA1A****, F15/F16 FDR56-CA1E****, F15/F16 FDR56-CA2A****, F15/F16 FDR56-CA2E****, F15/F16 FDR56-CA3A****, F15/F16 FDR56-CA3E****, F15/F16	 CSA
<ul style="list-style-type: none"> <li>■ 71258291</li> <li>■ 71258311</li> </ul>	FQR56-CAA****, F15/F16 FQR56-CAE****, F15/F16	
<ul style="list-style-type: none"> <li>■ 71258322</li> <li>■ 71258324</li> <li>■ 71258325</li> <li>■ 71258327</li> <li>■ 71258329</li> <li>■ 71258330</li> </ul>	FDR56-CB1A****, F15 FDR56-CB1E****, F15 FDR56-CB2A****, F15 FDR56-CB2E****, F15 FDR56-CB3A****, F15 FDR56-CB3E****, F15	 CSA
<ul style="list-style-type: none"> <li>■ 71258313</li> <li>■ 71258314</li> </ul>	FQR56-CBA****, F15 FQR56-CBE****, F15	



Order number	Device variant	Approval
<ul style="list-style-type: none"> <li>■ 71125436</li> <li>■ 71324380</li> <li>■ 71324382</li> <li>■ 71125437</li> <li>■ 71324381</li> <li>■ 71324383</li> <li>■ 71125438</li> <li>■ 71324387</li> <li>■ 71125439</li> <li>■ 71324388</li> <li>■ 71125440</li> <li>■ 71324389</li> <li>■ 71125441</li> <li>■ 71324390</li> </ul>	FDR56-IA1A****, F15 (Datecode up to 04.2016) FDR56-IA1A****, F15 (Datecode from 05.2016) FDR56-IA1A****, F34 FDR56-IA1E****, F15 (Datecode up to 04.2016) FDR56-IA1E****, F15 (Datecode from 05.2016) FDR56-IA1E****, F34 FDR56-IA2A****, F15 FDR56-IA2A****, F34 FDR56-IA2E****, F15 FDR56-IA2E****, F34 FDR56-IA3A****, F15 FDR56-IA3A****, F34 FDR56-IA3E****, F15 FDR56-IA3E****, F34	 IECEX
<ul style="list-style-type: none"> <li>■ 71125421</li> <li>■ 71324250</li> <li>■ 71125422</li> <li>■ 71324252</li> </ul>	FQR56-IAA****, F15 FQR56-IAA****, F34 FQR56-IAE****, F15 FQR56-IAE****, F34	

### 11.2.2 Replacing the electronics

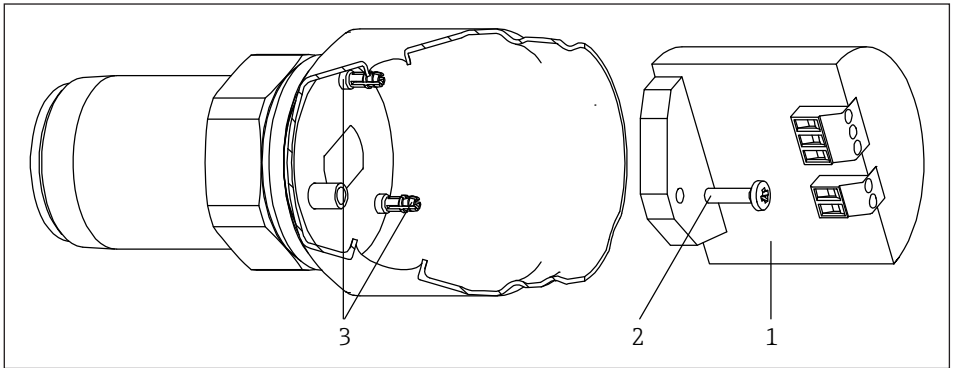

 22 Replacing the electronics

- 1 Electronics
- 2 Screw
- 3 Spacers

The electronics are attached to two self-clamping spacers and secured with a screw. To replace the electronics, proceed as follows:

1. Loosen the screw  
 PH2
2. Detach the electronic insert by pulling it from the two spacers and take it out of the device vertically
3. Insert the new electronic insert into the housing vertically, push it onto the spacers to snap it in and fasten it with the screw (1 ... 2 Nm)

## 11.3 Return

The device has to be returned in the event of repair, incorrect delivery or incorrect ordering. As an ISO certified company and due to legal regulations, Endress+Hauser is obligated to use particular handling techniques for all returned products that have come into contact with a medium.

To ensure the safe, proper and fast return of your device:

Learn about the procedure and basic conditions at the Endress+Hauser Internet site

[www.services.endress.com/return-material](http://www.services.endress.com/return-material)

### NOTICE

Preprinted form of the "Declaration of Contamination"

→  TI00443F/97/EN

## 11.4 Disposal



If required by the Directive 2012/19/EU on waste electrical and electronic equipment (WEEE), our products are marked with the depicted symbol in order to minimize the disposal of WEEE as unsorted municipal waste. Such products may not be disposed of as unsorted municipal waste and can be returned to Endress+Hauser for disposal at conditions stipulated in our General Terms and Conditions or as individually agreed.

### 11.4.1 Device removal

Perform the installation and connection steps from the "Installing the device" (→  19) and "Connecting the device" (→  23) in reversed order, taking into account the safety guidelines.

### WARNING

Danger to persons from process conditions! Take care in the presence of dangerous process conditions, such as high temperatures or aggressive or corrosive media.

### 11.4.2 Disposing of the device

### WARNING

**Danger to personnel and the environment from media that are hazardous to health.**

Ensure that the device and all cavities are free of any residual media that are hazardous to health or the environment, e.g. substances that have seeped into crevices or diffused through plastic.

### NOTICE

Observe the following when disposing of the device:

- Comply with the applicable national regulations.
- Ensure proper separation by substance types and recycling of the device components.

## 12 Accessories



Detailed information on accessories can be found in the technical documentation

→ TI00443F/97/EN

Designation	Additional information
Mating connector	<ul style="list-style-type: none"> <li>■ M12 Binder series 713/763, 4-pole</li> <li>■ Harting HAN8D</li> </ul>
Prefabricated connection cable	<ul style="list-style-type: none"> <li>■ M12 Binder series 713/763, 4-pole, length 2 m or 5 m</li> <li>■ Harting HAN8D, length 2 m or 5 m</li> </ul>
Mounting bracket	<ul style="list-style-type: none"> <li>■ Aluminum</li> <li>■ Plastic</li> </ul>
Installation flange	<ul style="list-style-type: none"> <li>■ Rp 1½ in accordance with EN 1092-1: DN 40 / PN 40 to DN 100 / PN 16, 316Ti</li> <li>■ 1½ NPT in accordance with ANSI/ASME: 1½" to 3 NPT", 150 lbs, 316Ti</li> <li>■ G 1½ in accordance with ISO 228-1: DN 40 / PN 40 to DN 100 / PN 16, 316Ti</li> <li>■ Optionally available with inspection certificate in accordance with EN 10204-3.1</li> </ul>
Window	<ul style="list-style-type: none"> <li>■ Welding assembly: DN 50 to DN 100, Tmax +200 °C, unpressurized, 316Ti</li> <li>■ Welding assembly: DN 50 to DN 100, Tmax +200 °C, Pmax 1 MPa (10 bar), 316Ti</li> <li>■ Flange assembly: DN 50 to DN 100, Tmax +200 °C, Pmax 2.5 MPa (25 bar), 316Ti</li> </ul>
High-temperature adapter	<ul style="list-style-type: none"> <li>■ R 1½/Rp 1½, 55 mm (AF), 316Ti (also suitable for devices with thread ISO 228 G 1½)</li> <li>■ 1½ NPT, 55 mm (AF), 316Ti</li> <li>■ Optionally available with inspection certificate in accordance with EN 10204-3.1</li> </ul>
Extension	For high-temperature adapters and other accessories: 225 to 525 mm (8.86 to 20.67 in), R 1½/Rp 1½ (also suitable for devices with thread ISO 228 G 1½) or 1½ NPT, 55 mm (AF), 316Ti
High-pressure adapter	<ul style="list-style-type: none"> <li>■ Process connection: G 1½ in accordance with ISO 228-1</li> <li>■ Device connection: G 1½ in accordance with ISO 228-1 (also suitable for R 1½ in accordance with EN 10226) or 1½ NPT in accordance with ANSI/ASME</li> <li>■ Material: 316Ti (window allowing radiation to pass through: PTFE)</li> <li>■ Optionally available with inspection certificate in accordance with EN 10204-3.1</li> </ul>
Weather protection cover	<ul style="list-style-type: none"> <li>■ 316L</li> <li>■ Adaptable to the installation situation</li> </ul>

<b>Designation</b>	<b>Additional information</b>
Weld-in nozzle	FAR50 → TI01362F/97/EN
Insertion adapter	FAR51 → TI01368F/97/EN
Process adapter	FAR52 → TI01369F/97/EN
Spacer tube	FAR53 → TI01370F/97/EN
Plug	FAR54 → TI01371F/97/EN
Wave guide	FAR55 → TI01372F/97/EN

## 13 Technical specifications



Further information on the technical specifications can be found in the technical documentation

→ TI00443F/97/EN

















Power supply	
Supply voltage	<ul style="list-style-type: none"> <li>■ AC version: 85 ... 253 V, 50/60 Hz</li> <li>■ DC version: 20 ... 60 V or 20 ... 30 V, 50/60 Hz</li> </ul>
Power consumption	<ul style="list-style-type: none"> <li>■ FQR56:               <ul style="list-style-type: none"> <li>- max. 7 VA (~ 85 ... 253 V, 50/60 Hz)</li> <li>- max. 1 W (= 20 ... 60 V) bzw. 1.5 VA (~ 20 ... 30 V, 50/60 Hz)</li> </ul> </li> <li>■ FDR56:               <ul style="list-style-type: none"> <li>- max. 9 VA (~ 85 ... 253 V, 50/60 Hz)</li> <li>- max. 2.4 W (= 20 ... 60 V) bzw. 4 VA (~ 20 ... 30 V, 50/60 Hz)</li> </ul> </li> </ul>
Environment	
Ambient temperature	-40 to +70 °C (-40 to +158 °F)
Ambient pressure	80 to 110 kPa (0.8 to 1.1 bar) absolute
Degree of protection	IP66 (IP20 if the housing is open)
Process	
Process temperature	<ul style="list-style-type: none"> <li>■ -40 to +70 °C (-40 to +158 °F)</li> <li>■ -40 to +450 °C (-40 to +842 °F) with optional high-temperature adapter</li> </ul>
Process pressure	<ul style="list-style-type: none"> <li>■ 50 to 680 kPa (0.5 to 6.8 bar) absolute</li> <li>■ 80 to 510 kPa (0.8 to 5.1 bar) absolute with optional high-temperature adapter</li> <li>■ 50 to 2000 kPa (0.5 to 20 bar) absolute with optional high-pressure adapter</li> </ul>

## 14 Appendix





















### 14.1 Settings of the Soliwave FDR56

You can make a note of your settings for documentation purposes using the following table:

Order code: <b>FDR56 -</b>	
Instrument number:	

Function/meaning	Value range	Setting
5 =  Hysteresis	 (Minimum) ...  (Maximum)	
6 =  Limit signal function (Min./Max. safety, relay output only)	 Relay switches on free microwave barrier or  Relay switches on covered microwave barrier	
7 =  Switching delay (switch-on delay)	 (off)	
8 =  Switching delay (switch-off delay)	 (100 ms) ... (200/300/500 ms, 1/2/3/5/10 s)	
A =  Damping	 (20 s)	

## 14.2 Overview of the device functions

Function	Description	Default value
0 	Display of the signal strength	—
1 	Automatic configuration with free path	—
2 	Automatic configuration with covered path	—
3 	Manual configuration with free path	—
4 	Manual configuration with covered path	—
5 	Hysteresis	
6 	Limit signal function	
7 	Switch-on delay	
8 	Switch-off delay	
9 	Simulation	—
A 	Damping	
B 	- has no function -	—
C 	- has no function -	—
D 	- has no function -	—
E 	- has no function -	—
F 	Reset to factory settings	—

# Index

<b>A</b>	
Accessories.....	51
Ambient pressure.....	53
Ambient temperature.....	53
<b>C</b>	
Calibration.....	34
Commissioning.....	34
Configuring.....	34
Connecting cable.....	22
Connectors.....	22
Current output.....	28
<b>D</b>	
Damping.....	41
Degree of protection.....	53
Device-specific symbols.....	6
Device variants.....	10
Diagnostics.....	44
Dimensions.....	18
Documentation.....	7
<b>E</b>	
Electrical connection.....	22
Electrical symbols.....	5
Electronics.....	47
<b>F</b>	
Factory defaults.....	42
<b>H</b>	
Hysteresis.....	37
<b>I</b>	
Installation.....	13, 19
Installation requirements.....	13
<b>L</b>	
Limit signal function.....	38
<b>M</b>	
Maintenance.....	45
<b>N</b>	
Nameplate.....	12
<b>O</b>	
Operating.....	30
Operating menu.....	32
Overview of the device functions.....	55
<b>P</b>	
Parallel use.....	16, 33
Potential equalization.....	23
Power supply.....	26, 53
Process pressure.....	53
Process temperature.....	53
Product identification.....	11
<b>R</b>	
Reflectors.....	16
Relay.....	27
Repair.....	46
Resetting.....	42, 44
Rest position.....	39
<b>S</b>	
Safety instructions.....	8
Settings.....	54
Signal output.....	27
Signal quality.....	15
Simulation.....	43
Solid-state relay.....	28
Spare parts.....	47
Switching capacity.....	27
Switching delay.....	39
Switching frequency.....	27
Switching on.....	34
<b>T</b>	
Technical specifications.....	53
Troubleshooting.....	44
<b>W</b>	
Weather protection cover.....	51









[www.addresses.endress.com](http://www.addresses.endress.com)

---