

# Operating Instructions

## Liquisys M COM223/253

Transmitter for Dissolved Oxygen

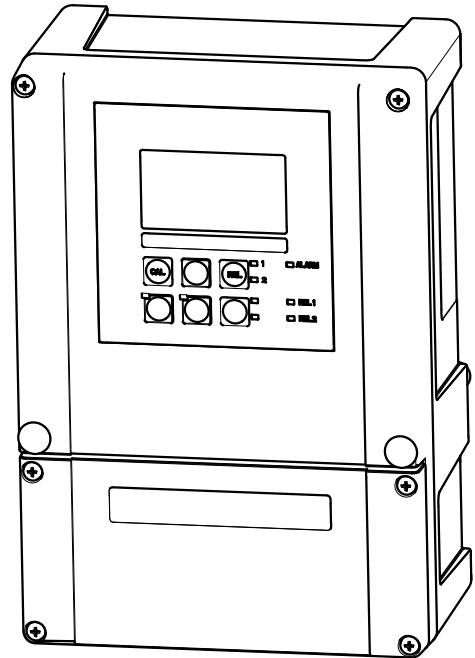

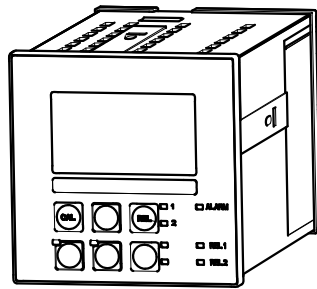





## Table of contents

<b>1</b>	<b>Document information</b> .....	<b>5</b>	<b>6</b>	<b>Operation options</b> .....	<b>28</b>
1.1	Warnings .....	5	6.1	Quick operation guide .....	28
1.2	Symbols used .....	5	6.2	Display and operating elements .....	28
1.3	Symbols on the device .....	5	6.2.1	Display .....	28
1.4	Electrical symbols .....	6	6.2.2	Operating elements .....	30
<b>2</b>	<b>Basic safety instructions</b> .....	<b>7</b>	6.2.3	Key functions .....	30
2.1	Requirements for personnel .....	7	6.3	Local operation .....	33
2.2	Designated use .....	7	6.3.1	Automatic/manual mode .....	33
2.3	Occupational safety .....	7	6.3.2	Operating concept .....	34
2.4	Operational safety .....	8	<b>7</b>	<b>Commissioning</b> .....	<b>36</b>
2.5	Product safety .....	8	7.1	Function check .....	36
2.5.1	State of the art .....	8	7.2	Switching on .....	36
2.5.2	IT security .....	8	7.3	Quick Setup .....	38
<b>3</b>	<b>Incoming acceptance and product identification</b> .....	<b>9</b>	7.4	Device configuration .....	40
3.1	Incoming acceptance .....	9	7.4.1	Setup 1 (oxygen) .....	40
3.2	Scope of delivery .....	9	7.4.2	Setup 2 (salinity and temperature) ...	42
3.3	Product identification .....	10	7.4.3	Current input .....	42
3.3.1	Nameplate .....	10	7.4.4	Current outputs .....	46
3.3.2	Product identification .....	10	7.4.5	Alarm .....	51
3.4	Certificates and approvals .....	10	7.4.6	Check .....	52
3.4.1	CE mark .....	10	7.4.7	Relay configuration .....	56
3.4.2	CSA General Purpose .....	10	7.4.8	Service .....	70
<b>4</b>	<b>Installation</b> .....	<b>11</b>	7.4.9	E+H Service .....	72
4.1	Installation at a glance .....	11	7.4.10	Interfaces .....	73
4.1.1	Measuring system .....	12	7.4.11	Communication .....	73
4.2	Installation conditions .....	13	7.5	Calibration .....	74
4.2.1	Field device .....	13	<b>8</b>	<b>Diagnostics and troubleshooting</b> ...	<b>78</b>
4.2.2	Panel-mounted device .....	14	8.1	Trouble shooting instructions .....	78
4.3	Installation instructions .....	15	8.2	System error messages .....	78
4.3.1	Field device .....	15	8.3	Process-specific errors .....	81
4.3.2	Panel-mounted device .....	17	8.4	Device-specific errors .....	85
4.4	Post-installation check .....	17	<b>9</b>	<b>Maintenance</b> .....	<b>87</b>
<b>5</b>	<b>Electrical connection</b> .....	<b>18</b>	9.1	Maintenance of the entire measuring point ..	87
5.1	Wiring .....	18	9.1.1	Cleaning the transmitter .....	87
5.2	Electrical connection, version 1 (DX/DS with COS41) .....	18	9.1.2	Checking version 1 (DX/DS with COS41) .....	89
5.2.1	Wiring diagram .....	18	9.1.3	Checking version 2 (WX/WS with COS31 or COS71) .....	89
5.2.2	Measuring cables and sensor connection .....	21	9.1.4	Maintenance of oxygen sensors .....	90
5.3	Electrical connection, version 2 (WX/WS with COS31, COS61 or COS71) .....	22	9.1.5	Assembly .....	90
5.3.1	Wiring diagram .....	22	9.1.6	Connecting cables and junction boxes .....	90
5.3.2	Measuring cables and sensor connection .....	25	<b>10</b>	<b>Repair</b> .....	<b>92</b>
5.4	Alarm contact .....	27	10.1	Spare parts .....	92
5.5	Post-connection check .....	27	10.2	Disassembling the panel-mounted device ....	92
			10.3	Disassembling the field device .....	95
			10.4	Replacing the central module .....	98
			10.5	Return .....	98
			10.6	Disposal .....	99



<b>11</b>	<b>Accessories</b> .....	<b>100</b>
11.1	Sensors .....	100
11.2	Connection accessories .....	100
11.3	Installation accessories .....	101
11.4	Software and hardware add-ons .....	102
<b>12</b>	<b>Technical data</b> .....	<b>103</b>
12.1	Input .....	103
12.2	Output .....	103
12.3	Power supply .....	106
12.4	Performance characteristics .....	107
12.5	Environment .....	107
12.6	Mechanical construction .....	108
<b>13</b>	<b>Appendix</b> .....	<b>109</b>
	<b>Index</b> .....	<b>122</b>

# 1 Document information

## 1.1 Warnings

Structure of information	Meaning
 <b>DANGER</b> <b>Causes (/consequences)</b> Consequences of non-compliance (if applicable) ► Corrective action	This symbol alerts you to a dangerous situation. Failure to avoid the dangerous situation <b>will</b> result in a fatal or serious injury.
 <b>WARNING</b> <b>Causes (/consequences)</b> Consequences of non-compliance (if applicable) ► Corrective action	This symbol alerts you to a dangerous situation. Failure to avoid the dangerous situation <b>can</b> result in a fatal or serious injury.
 <b>CAUTION</b> <b>Causes (/consequences)</b> Consequences of non-compliance (if applicable) ► Corrective action	This symbol alerts you to a dangerous situation. Failure to avoid this situation can result in minor or more serious injuries.
 <b>NOTICE</b> <b>Cause/situation</b> Consequences of non-compliance (if applicable) ► Action/note	This symbol alerts you to situations which may result in damage to property.











## 1.2 Symbols used

-  Additional information, tips
-  Permitted or recommended
-  Forbidden or not recommended

## 1.3 Symbols on the device

Symbol	Meaning
	Reference to device documentation

## 1.4 Electrical symbols

Symbol	Meaning
 <small>A0027423</small>	<b>Direct current</b> A terminal at which DC is present or through which DC flows.
 <small>A0027424</small>	<b>Alternating current</b> A terminal at which alternating voltage (sine-wave) is applied or through which alternating current flows.
 <small>A0027425</small>	<b>Direct current or alternating current</b> A terminal at which direct voltage or alternating voltage is present or through which direct current or alternating current flows.
 <small>A0027426</small>	<b>Ground connection</b> A terminal which, from the user's point of view, is already grounded via a grounding system.
 <small>A0027427</small>	<b>Protective ground connection</b> A terminal which must be connected to ground prior to establishing any other connections.
 <small>A0019929</small>	<b>Class II equipment</b> Reinforced or double insulation
 <small>A0027420</small>	<b>Alarm relay</b>
 <small>A0027428</small>	<b>Input</b>
 <small>A0027429</small>	<b>Output</b>
 <small>A0027430</small>	<b>DC voltage source</b>
 <small>A0027431</small>	<b>Temperature sensor</b>

## 2 Basic safety instructions

### 2.1 Requirements for personnel

- Installation, commissioning, operation and maintenance of the measuring system may be carried out only by specially trained technical personnel.
- The technical personnel must be authorized by the plant operator to carry out the specified activities.
- The electrical connection may be performed only by an electrical technician.
- The technical personnel must have read and understood these Operating Instructions and must follow the instructions contained therein.
- Measuring point faults may be repaired only by authorized and specially trained personnel.

 Repairs not described in the Operating Instructions provided may only be carried out directly by the manufacturer or by the service organization.

### 2.2 Designated use

Liquisys M is a transmitter for determining the oxygen content of liquid media.

The transmitter is particularly suited for use in the following areas:

- Wastewater treatment plants
- Wastewater treatment
- Drinking water
- Water treatment and water monitoring
- Surface water (rivers, lakes, seas)
- Fish farming

Use of the device for any purpose other than that described, poses a threat to the safety of people and of the entire measuring system and is therefore not permitted.

The manufacturer is not liable for damage caused by improper or non-designated use.

### 2.3 Occupational safety

As the user, you are responsible for complying with the following safety conditions:

- Installation guidelines
- Local standards and regulations

#### **Electromagnetic compatibility**

- The product has been tested for electromagnetic compatibility in accordance with the applicable European standards for industrial applications.
- The electromagnetic compatibility indicated applies only to a product that has been connected in accordance with these Operating Instructions.

## 2.4 Operational safety

1. Before commissioning the entire measuring point, verify that all connections are correct. Ensure that electrical cables and hose connections are undamaged.
2. Do not operate damaged products, and safeguard them to ensure that they are not operated inadvertently. Label the damaged product as defective.
3. If faults cannot be rectified:  
Take the products out of operation and safeguard them to ensure that they are not operated inadvertently.

## 2.5 Product safety

### 2.5.1 State of the art

The product is designed to meet state-of-the-art safety requirements, has been tested, and left the factory in a condition in which it is safe to operate. The relevant regulations and European standards have been observed.

### 2.5.2 IT security

We only provide a warranty if the device is installed and used as described in the Operating Instructions. The device is equipped with security mechanisms to protect it against any inadvertent changes to the device settings.

IT security measures in line with operators' security standards and designed to provide additional protection for the device and device data transfer must be implemented by the operators themselves.



## 3 Incoming acceptance and product identification

### 3.1 Incoming acceptance

1. Verify that the packaging is undamaged.
  - ↳ Notify your supplier of any damage to the packaging.  
Keep the damaged packaging until the matter has been settled.
2. Verify that the contents are undamaged.
  - ↳ Notify your supplier of any damage to the delivery contents.  
Keep the damaged products until the matter has been settled.
3. Check the delivery for completeness.
  - ↳ Check it against the delivery papers and your order.
4. Pack the product for storage and transportation in such a way that it is protected against impact and moisture.
  - ↳ The original packaging offers the best protection.  
The permitted ambient conditions must be observed (see "Technical data").

If you have any questions, please contact your supplier or your local sales center.

### 3.2 Scope of delivery

The delivery of the field device comprises:

- 1 transmitter COM253
- 1 plug-in screw terminal, 3-pin
- 1 cable gland Pg 7
- 1 cable gland Pg 16 reduced
- 2 cable glands Pg 13.5
- 1 set of Operating Instructions
- For versions with HART communication:
  - 1 set of Operating Instructions: Field communication with HART
- For versions with PROFIBUS interface:
  - 1 set of Operating Instructions: Field communication with PROFIBUS PA/DP

The delivery of the panel-mounted device comprises:

- 1 transmitter COM223
- 1 set of plug-in screw terminals
- 2 tensioning screws
- 1 set of Operating Instructions
- For versions with HART communication:
  - 1 set of Operating Instructions: Field communication with HART
- For versions with PROFIBUS interface:
  - 1 set of Operating Instructions: Field communication with PROFIBUS PA/DP

## 3.3 Product identification

### 3.3.1 Nameplate

The nameplate provides you with the following information on your device:

- Manufacturer identification
- Order code
- Extended order code
- Serial number
- Ambient and process conditions
- Input and output values
- Safety information and warnings

 Compare the data on the nameplate with your order.

### 3.3.2 Product identification

The order code and serial number of your product can be found in the following locations:

- On the nameplate
- In the delivery papers

#### Obtaining information on the product

1. Go to the product page for your product on the Internet.
2. In the navigation area on the right-hand side, select "Check your device features" under "Device support".
  - ↳ An additional window opens.
3. Enter the order code from the nameplate into the search field.
  - ↳ You will receive information on each feature (selected option) of the order code.

## 3.4 Certificates and approvals

### 3.4.1 CE mark

The product meets the requirements of the harmonized European standards. As such, it complies with the legal specifications of the EC directives. The manufacturer confirms successful testing of the product by affixing to it the **CE** mark.

### 3.4.2 CSA General Purpose

The following device versions meet the requirements of CSA and ANSI/UL for Canada and the US:

- COM253-\*\*2/3/7\*\*\*
- COM223-\*\*2/3/7\*\*\*

## 4 Installation

### 4.1 Installation at a glance

Proceed as follows to completely install the measuring point:

- Install the transmitter (see the "Installation instructions" section).
- If the sensor is not yet installed in the measuring point, install it (see Technical Information of the sensor).
- Connect the sensor to the transmitter as illustrated in the "Electrical connection" section.
- Connect the transmitter as illustrated in the "Electrical connection" section.
- Commission the transmitter as explained in the "Commissioning" section.

### 4.1.1 Measuring system

A complete measuring system comprises:

- Transmitter Liquisys M COM223 or COM253
- Oxygen sensor
  - COS41 for Liquisys M COM2x3-DS/DX
  - COS61 for Liquisys M COM2x3-WS/WX

Optionally:

- Extension cable OM, junction box VS
- Weather protection cover CYY101 for field housing

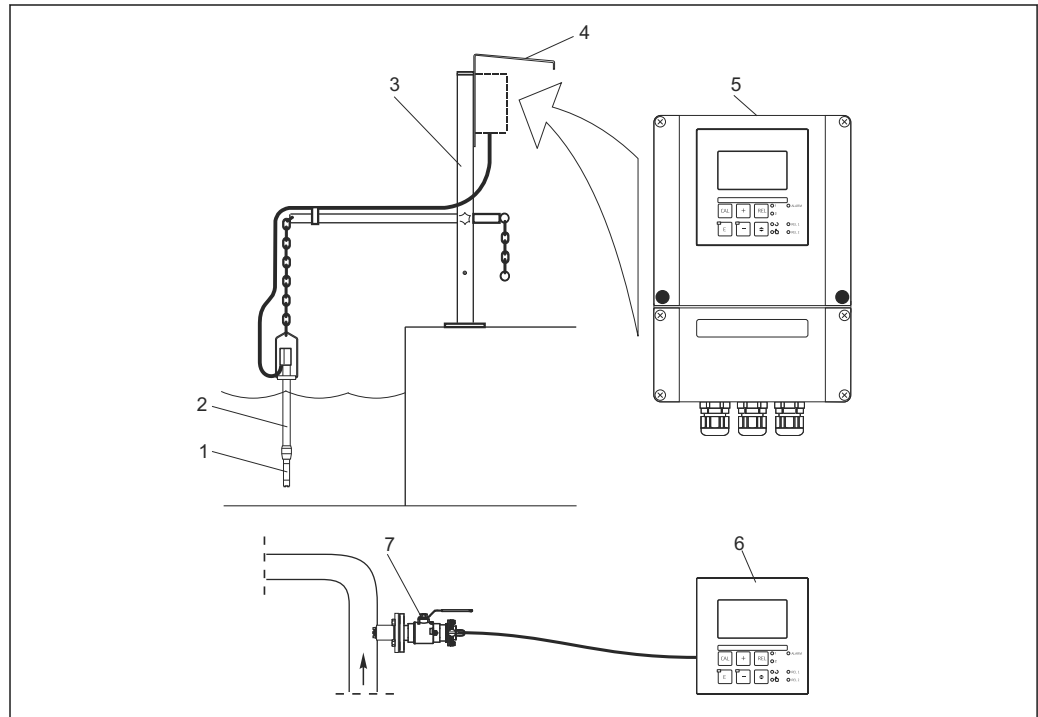

A0024087

#### 1 Complete measuring systems

- 1 Oxygen sensor
- 2 Immersion assembly CYA112
- 3 Universal suspended assembly holder CYH112
- 4 Weather protection cover CYY101
- 5 Liquisys M COM253
- 6 Liquisys M COM223
- 7 Retractable assembly COA451

## 4.2 Installation conditions

### 4.2.1 Field device

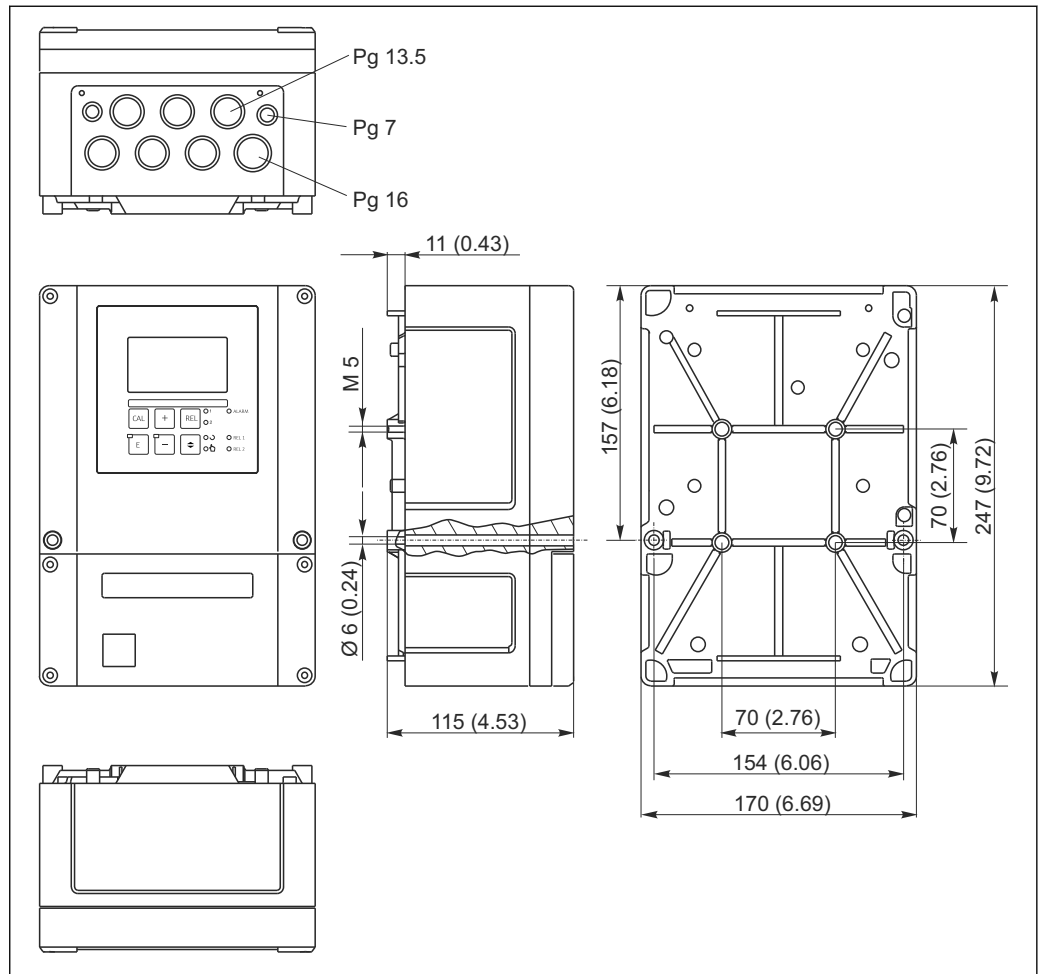

2 Field device, dimensions in mm (inch)

- i** There is a hole in the perforation for the cable entry (connection of supply voltage). It serves as a pressure balance during air shipment. Make sure no moisture penetrates the inside of the housing before the cable installation. The housing is completely air-tight after cable installation.

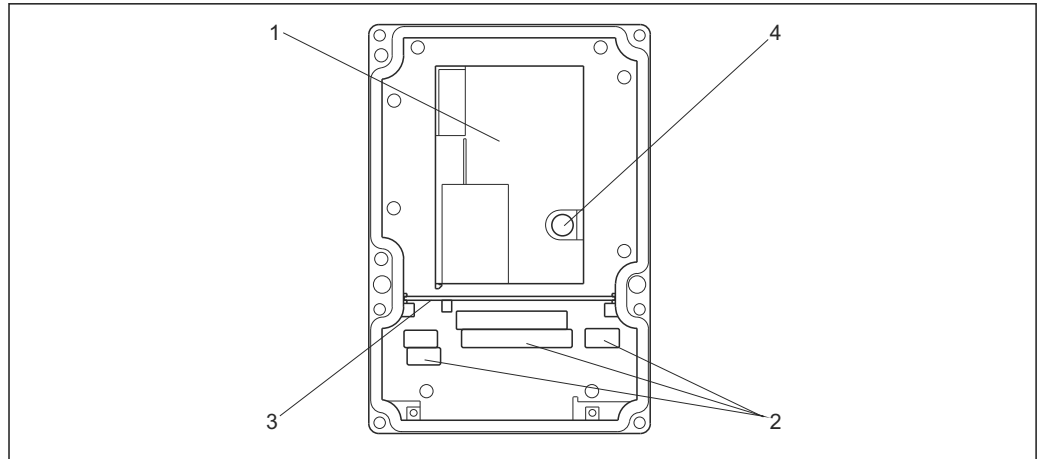

A0024640

3 View into the field housing

- 1 Removable electronics box
- 2 Terminals
- 3 Partition plate
- 4 Fuse

### 4.2.2 Panel-mounted device

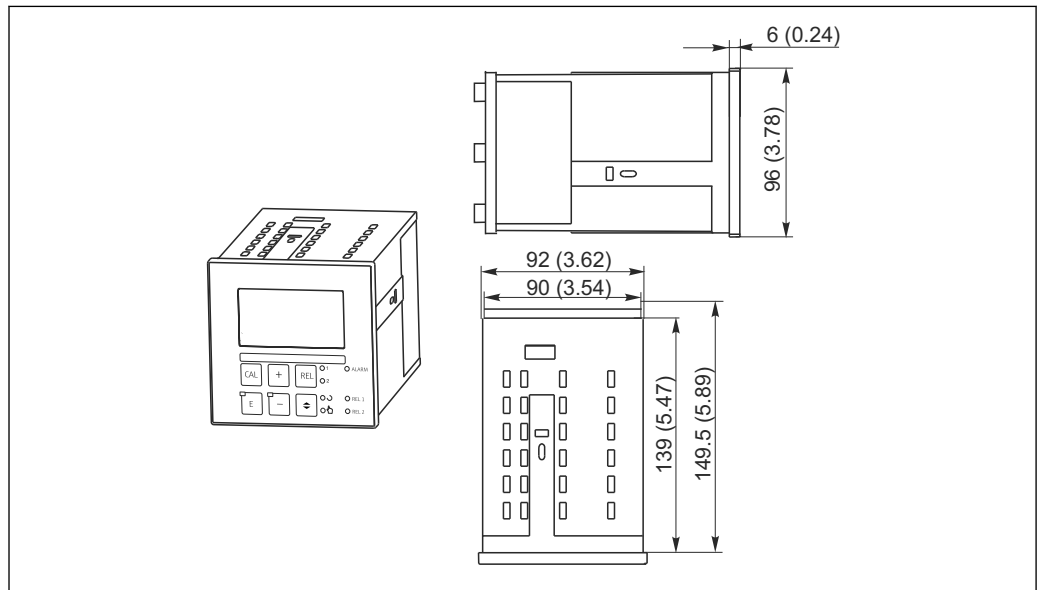

A0024641

4 Panel-mounted device, dimensions in mm (inch)

## 4.3 Installation instructions

### 4.3.1 Field device

There are several ways of securing the field housing:

- Wall mounting with fixing screws
- Post mounting to cylindrical pipes
- Post mounting to a square securing mast

#### NOTICE

**Effect of climatic conditions (rain, snow, direct sunlight etc.)**

Impaired operation to complete transmitter failure

- ▶ When installing outside, always use the weather protection cover (accessory).

#### Transmitter wall mounting

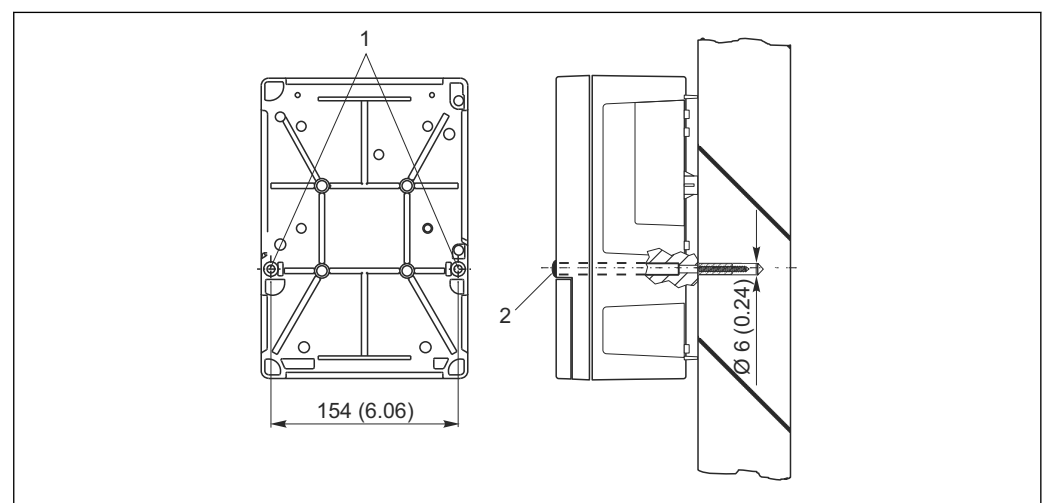

A0024638

#### 5 Field device wall mounting

- 1 Fixing bore holes
- 2 Plastic caps

Proceed as follows to mount the transmitter on the wall:

- Create the bore holes as shown in → 5.
- Drive two fixing screws through the fixing bore holes (1) from the front.
- Mount the transmitter on the wall as shown.
- Cover the bores with plastic caps (2).

#### Transmitter post mounting

- i** You require a post mounting kit to secure the field device to horizontal and vertical posts or pipes (max. Ø 60 mm (2.36")). This can be acquired as an accessory (see the "Accessories" section).

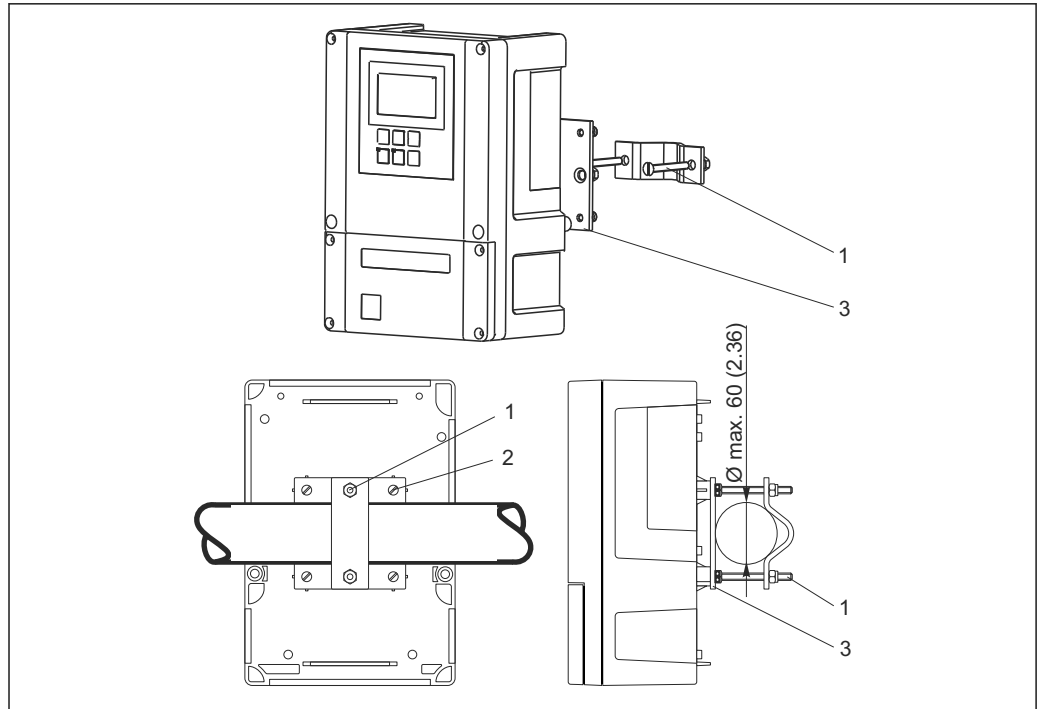

A0024635

6 Field device on horizontal or vertical pipes

- 1 Securing screws
- 2 Fixing screws
- 3 Securing plate

Proceed as follows to mount the transmitter on a post:

1. Guide the two securing screws (1) of the mounting kit through the openings on the securing plate (3).
2. Screw the securing plate onto the transmitter using the four fixing screws (2).
3. Secure the bracket with the field device on the post or pipe using the clip.

You can also secure the field device to the Flexdip CYH112 bracket in conjunction with the weather protection cover. These can be acquired as accessories, see the "Accessories" section.

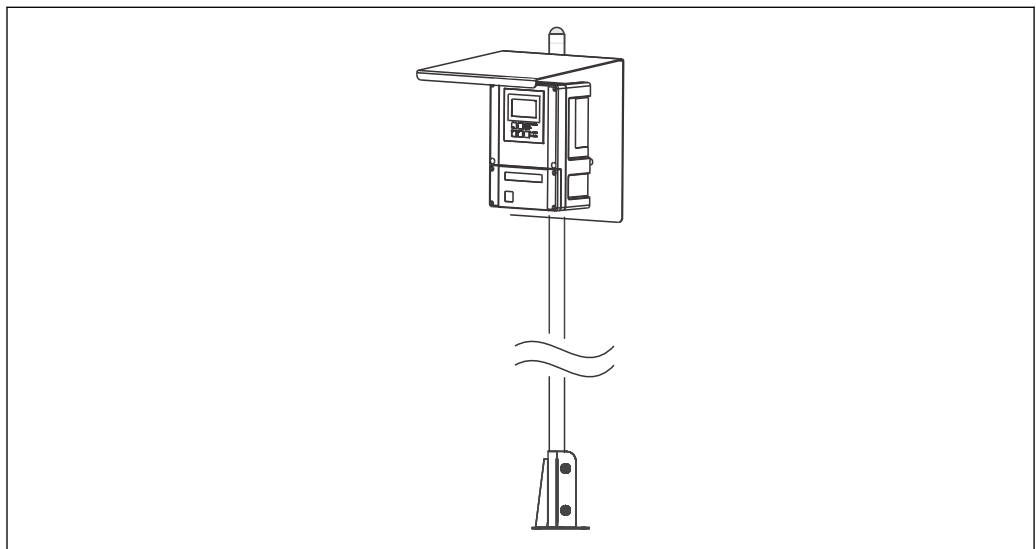

A0027433

7 Field device on Flexdip CYH112 bracket with weather protection cover



### 4.3.2 Panel-mounted device

The panel-mounted device is secured with the tensioning screws supplied →  8

The necessary installation depth is approx. 165 mm (6.50").

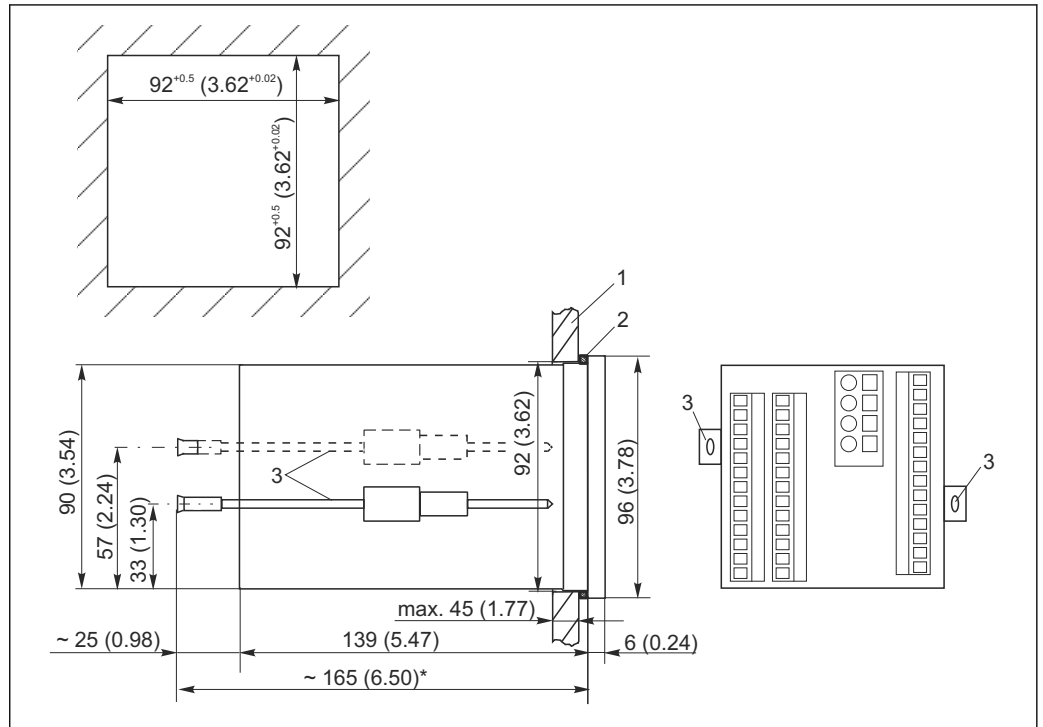

 8 Dimensions in mm (inch)

1 Mounting plate

2 Seal

3 Tensioning screws

\* Necessary installation depth

### 4.4 Post-installation check

- After installation, check the transmitter for damage.
- Check whether the transmitter is protected against moisture and direct sunlight (e.g. by the weather protection cover).

## 5 Electrical connection

### **⚠ WARNING**

#### **Device is live**

Incorrect connection may result in injury or death.

- ▶ The electrical connection may be performed only by an electrical technician.
- ▶ The electrical technician must have read and understood these Operating Instructions and must follow the instructions contained therein.
- ▶ **Prior** to commencing connection work, ensure that no voltage is present on any cable.

### 5.1 Wiring

#### **⚠ WARNING**

#### **Risk of electric shock!**

- ▶ At the supply point, the power supply must be isolated from dangerous live cables by double or reinforced insulation in the case of devices with a 24 V power supply.

#### **NOTICE**

#### **The device does not have a power switch**

- ▶ The customer must provide a protected circuit breaker in the vicinity of the device.
- ▶ The circuit breaker must be a switch or power switch, and you must label it as the circuit breaker for the device.

The electrical connection of the transmitter differs depending on the device version:

- If you are using a DX/DS version of the device (with COS41), follow the instructions and illustrations in the "Electrical connection of Liquisys M, version 1" section.
- If you are using a WX/WS version of the device (with COS31, COS61 or COS71), follow the instructions and illustrations in the "Electrical connection of Liquisys M, version 2" section.

### 5.2 Electrical connection, version 1 (DX/DS with COS41)

#### 5.2.1 Wiring diagram

The wiring diagram shows the connections of a device equipped with all the options.

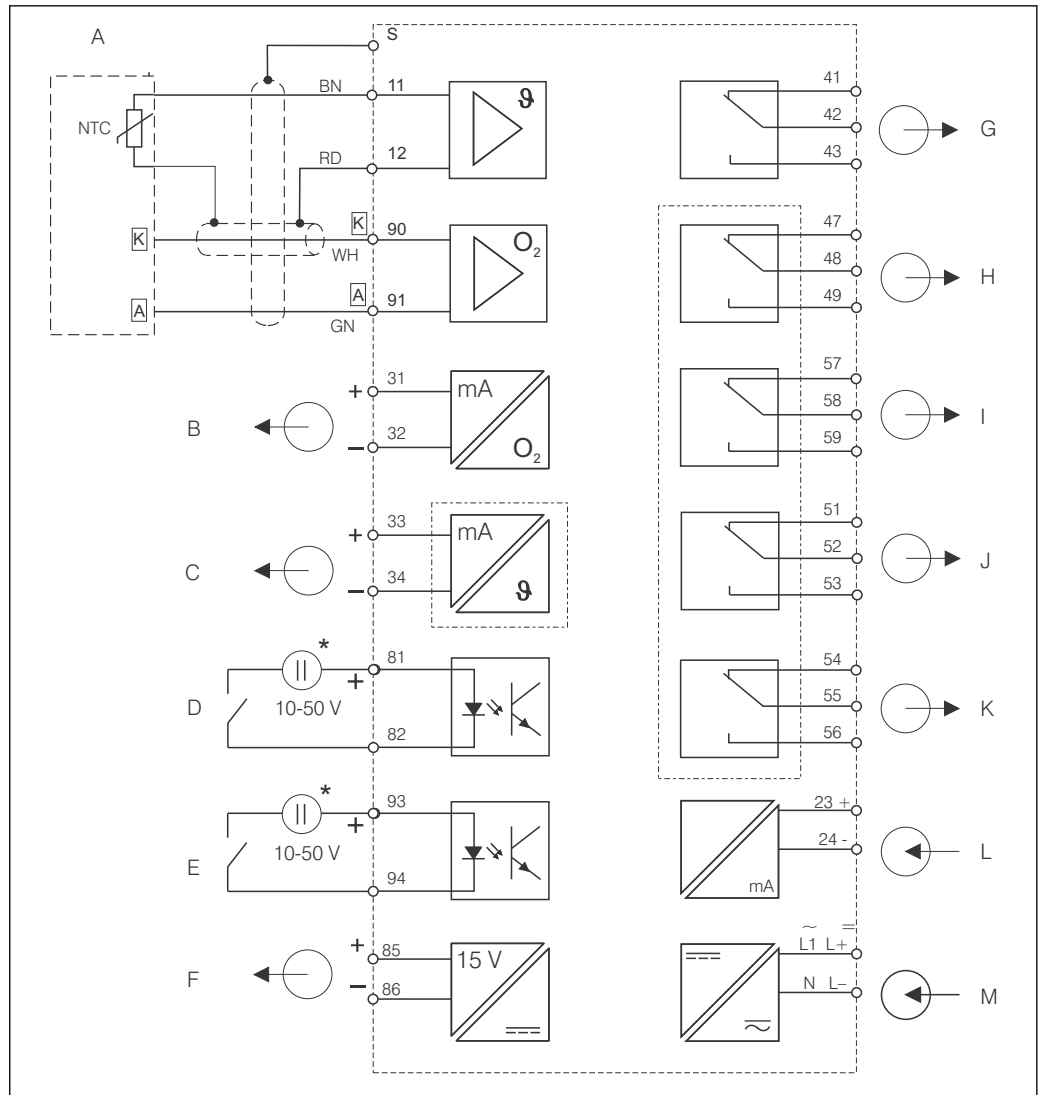

A0026034

9 Electrical connection of the transmitter, DX or DS version

- |   |   |   |   |
|---|---|---|---|
| A | Oxygen sensor COS41                             | G | Alarm (current-free contact position)   |
| B | Signal output 1, oxygen                         | H | Relay 1 (current-free contact position) |
| C | Signal output 2, temperature/actuating variable | I | Relay 2 (current-free contact position) |
| D | Binary input 1 (hold)                           | J | Relay 3 (current-free contact position) |
| E | Binary input 2 (Chemoclean)                     | K | Relay 4 (current-free contact position) |
| F | Auxiliary voltage output                        | L | Current input 4 to 20 mA                |
| * | Auxiliary voltage of terminal 85/86 can be used | M | Power connection                        |

**i** The device is approved for protection class II and is generally operated without a protective ground connection. Circuits "C" and "F" are not galvanically isolated from each other.

**Field device connection, DX/DS version**

Proceed as follows to connect the field device:

1. Open the housing cover to access the terminal block in the connection compartment.
2. Break through the perforation for a cable gland, mount a Pg gland and guide the cable through this Pg gland.
3. Connect the cable in accordance with the terminal assignment.
4. Tighten the Pg gland again.

**NOTICE**

**Non-observance could cause incorrect measurement**

- ▶ Make absolutely sure to protect the cable ends and terminals from moisture.
- ▶ Terminals marked NC may not be connected.
- ▶ Unmarked terminals may not be connected.

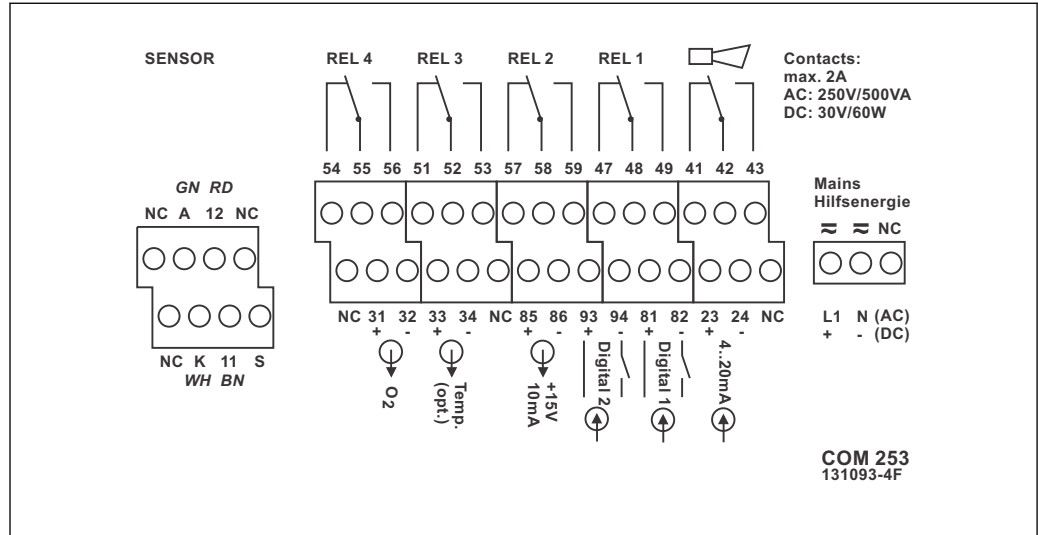

A0026035

10 Field device connection compartment sticker

**i** Please label the sensor terminal block with the sticker provided.

**Panel-mounted device connection**

To connect the panel-mounted device, connect the cables in accordance with the terminal assignment to the terminals on the rear of the device.

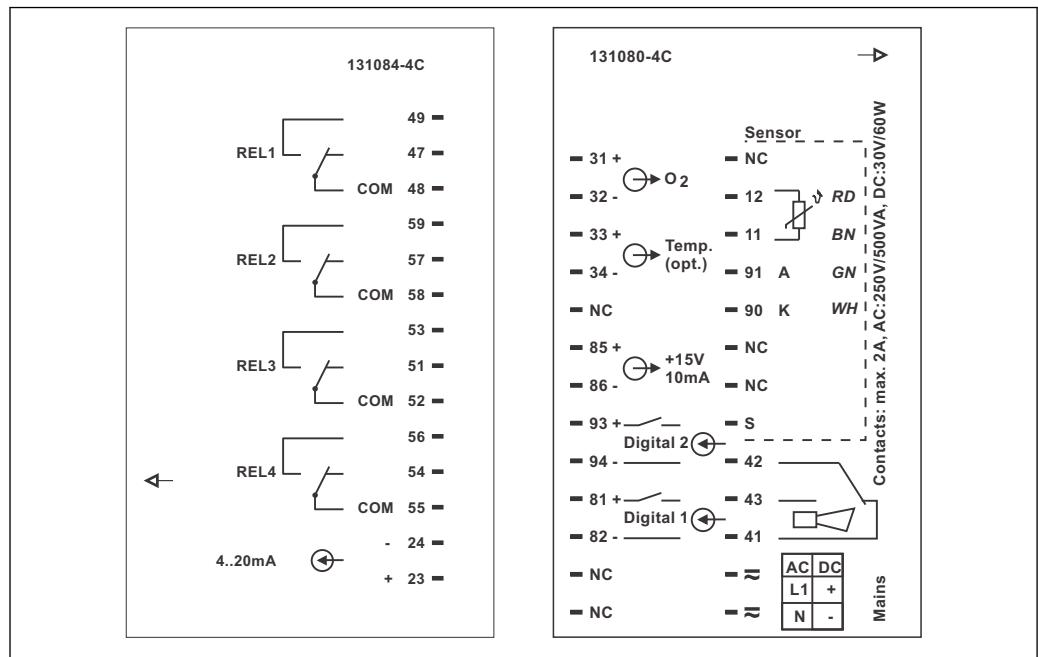

A0026036

11 Connection compartment sticker for panel-mounted device

**NOTICE**

**Non-observance could cause incorrect measurement**

- ▶ Make absolutely sure to protect the cable ends and terminals from moisture.
- ▶ Terminals marked NC may not be connected.
- ▶ Unmarked terminals may not be connected.

**5.2.2 Measuring cables and sensor connection**

You require a multi-core, shielded special measuring cable to connect the COS41 oxygen sensors to the transmitter. Use a junction box and an extension cable to extend the measuring cable:

Sensor type	Cable	Extension
COS41	CYK71	VBM box + CYK71 cable

Maximum cable length	
COS41	50 m with CYK71 cable

Alternatively you can also use the measuring cable CMK.

**Structure and termination of the measuring cable**

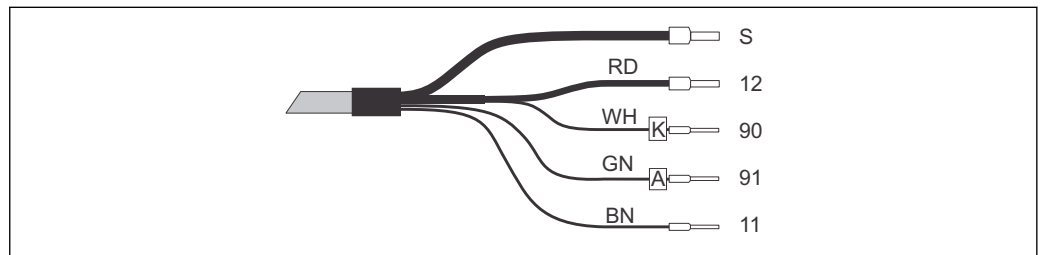

12 Messkabel CMK bzw. CYK71

- S Outer shield
- 12 Active inner shield (NTC)
- 90 Cathode
- 91 Anode
- 11 NTC temperature sensor

**i** For further information on the cables and junction boxes, please refer to the "Accessories" section.

**Example of connecting the oxygen sensor**

The following diagram shows the connection of a COS41 oxygen sensor.

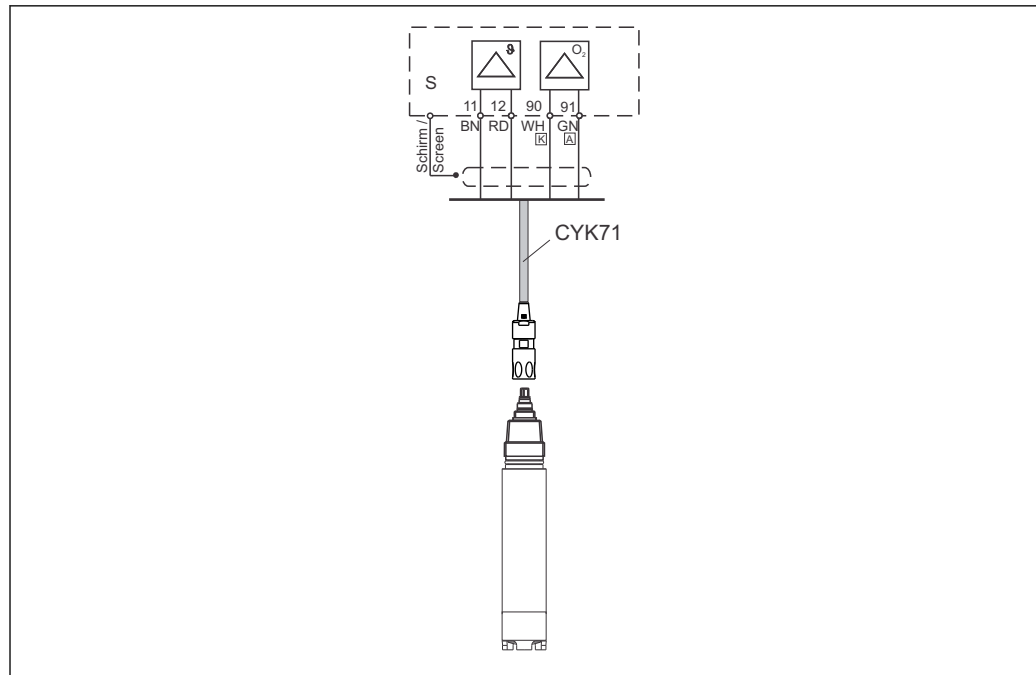

A0026038

13 Connection of the COS41 with the CYK71 cable

## 5.3 Electrical connection, version 2 (WX/WS with COS31, COS61<sup>1)</sup> or COS71)

### 5.3.1 Wiring diagram

The wiring diagram shows the connections using a COS31, COS61 (as of serial number 79xxxx) or COS71 type of oxygen sensor with full wiring.

1) as of serial number 79xxxx

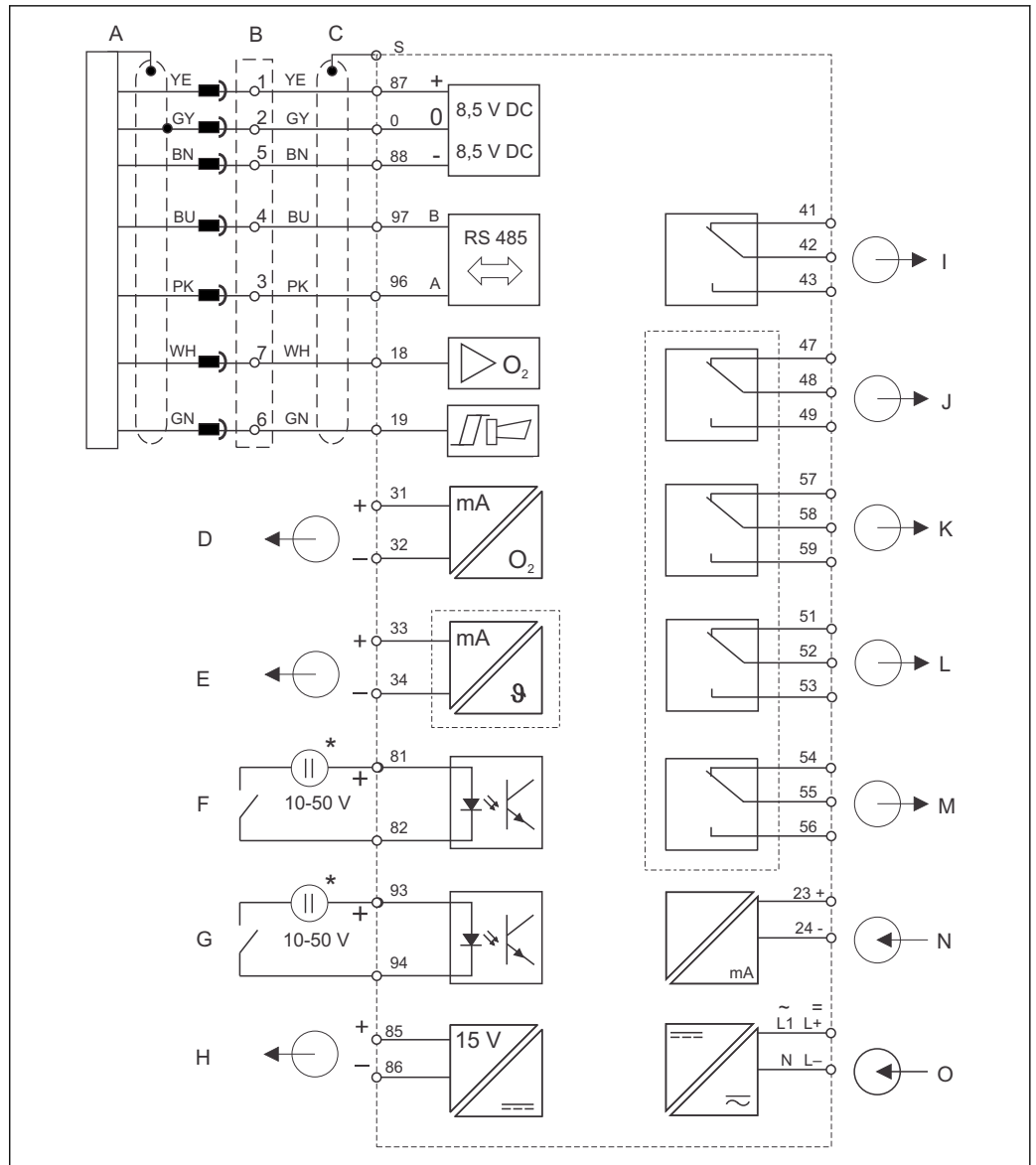

14 Electrical connection of Liquisys M COM223/253, version WX or WS

- |   |   |   |   |
|---|---|---|---|
| A | Oxygen sensor COS31/61/71   | H | Auxiliary voltage output                |
| B | VS box for extension  | I | Alarm (current-free contact position)   |
| C | COM223: plug-in connection for O <sub>2</sub> connector<br>COM253: connector of sensor cable must be removed or VS box must be used | J | Relay 1 (current-free contact position) |
| D | Signal output 1, oxygen   | K | Relay 2 (current-free contact position) |
| E | Signal output 2, temperature/actuating variable   | L | Relay 3 (current-free contact position) |
| F | Binary input 1 (hold)   | M | Relay 4 (current-free contact position) |
| G | Binary input 2 (Chemoclean)   | N | Current input 4 to 20 mA                |
| * | Auxiliary voltage of terminal 85/86 can be used   | O | Power connection                        |

- i** The device is approved for protection class II and is generally operated without a protective ground connection.
  - Circuits "E" and "H" are not galvanically isolated from each other
  - The "sensor signal" and "alarm" signals are not assigned in TOP68 versions.

**Field device connection, version WX/WS**

To connect the field device, the measuring cables are guided through the cable glands of the field device and connected according to the wiring diagram in the following graphic. The sensor is connected from the outside (seven-pin SXB socket).

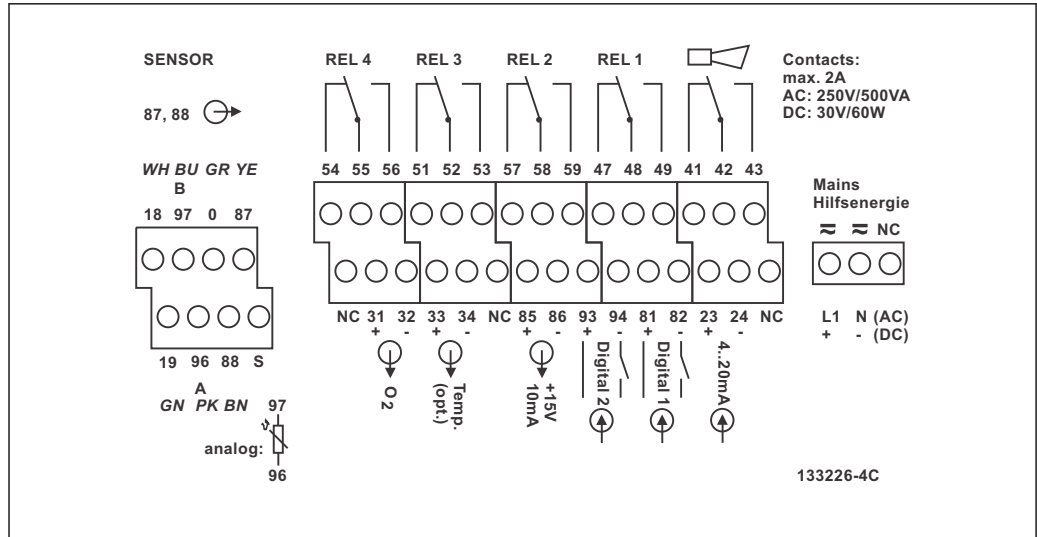

A0026040

15 Connection compartment sticker on Liquisys M field device, version WX/WS

**i** Please label the sensor terminal block with the sticker provided.

**Panel-mounted device connection**

To connect to COM 223-WX/WS, the sensor connector must be removed and the strands connected directly. If the connector should remain as a disconnectable connection, a VS box can be connected between the sensor and device.

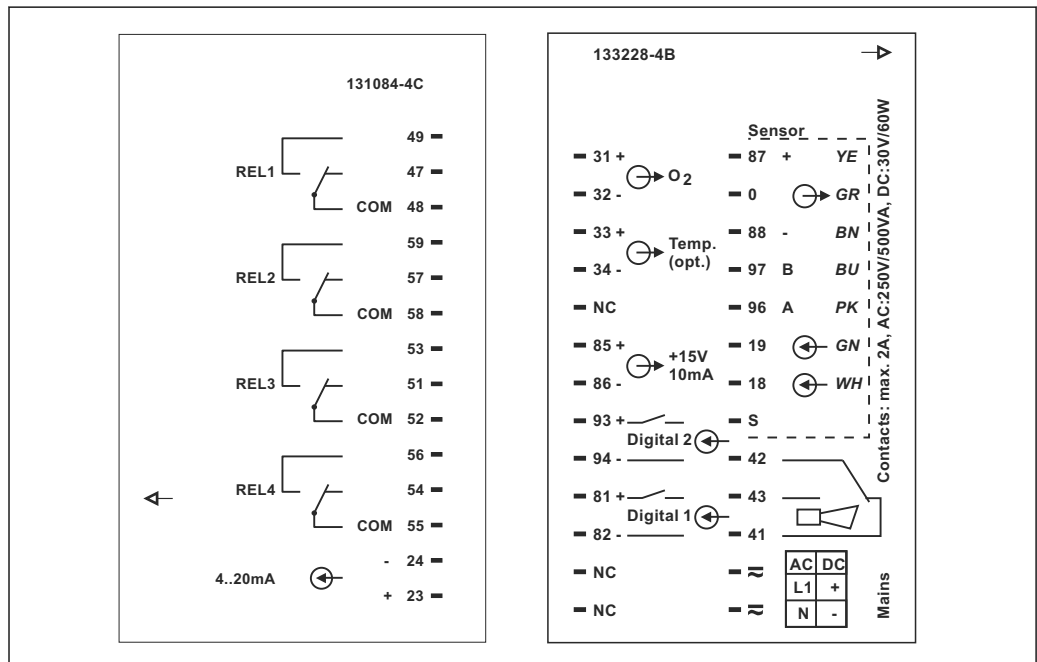

A0026041

16 Connection compartment sticker on Liquisys M panel-mounted device, version WX/WS

**NOTICE**

**Non-observance could cause incorrect measurement**

- ▶ Terminals marked NC may not be connected.
- ▶ Unmarked terminals may not be connected.



### 5.3.2 Measuring cables and sensor connection

You require a junction box and an extension cable to extend the measuring cable:

Sensor type	Cable	Extension
COS31/61/71 with fixed cable connection	OMK with SXP connector	VS box + OMK cable
COS31/61/71 with TOP 68 connection	CYK71 with SXP connector	VS box + OMK cable

Maximum cable length	
COS31/61/71	100 m with OMK / CYK71 cable

#### Assignment of the SXP connector

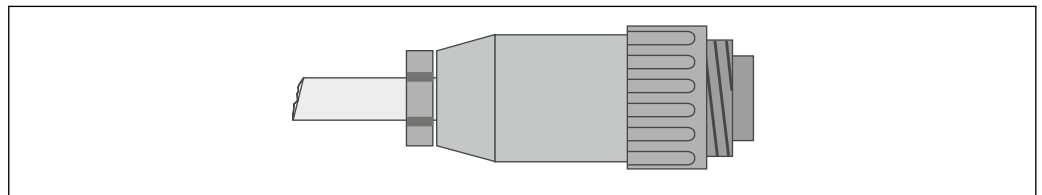

A0026042

 17 Termination of the sensor connector with special measuring cable OMK

Pin	OMK		CYP	
	Color	Signal	Signal	Color
1	yellow	+UB	+UB	yellow
2	gray	0 V	0 V	white
3	pink	RS 485 (NTC)	RS 485 (NTC)	green
4	blue	RS 485 (NTC)	RS 485 (NTC)	brown
5	brown	- UB	- UB	Coax, inside
6	green	Alarm	NC	
7	white	Sensor signal	NC	

 For further information on the cables and junction boxes, please refer to the "Accessories" section.

#### Example of connecting the oxygen sensor

The following diagram shows the connection of a COS31/71 oxygen sensor.

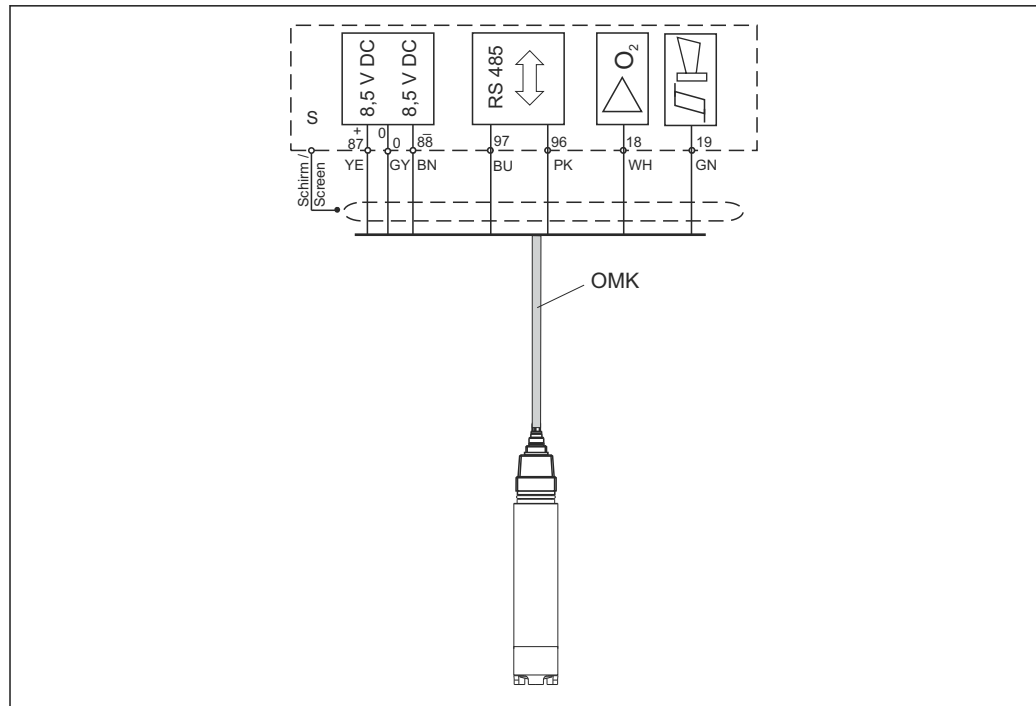

A0026043

18 Connection of COS31/71 with an OMK cable

**i** The **sensor signal** and **alarm** signals are not assigned in COS61 and the TOP68 versions.

### 5.4 Alarm contact

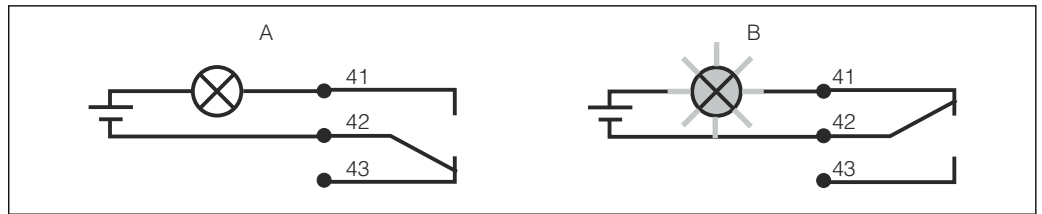

A0006415

19 Recommended fail-safe switching for the alarm contact

- A Normal operating status
- B Alarm condition

**Normal operating status**

- Device in operation and no error message present (alarm LED off):
- Relay energized
  - Contact 42/43 closed

**Alarm condition**

- Error message present (alarm LED red) or device defective or de-energized (alarm LED off):
- Relay de-energized
  - Contact 41/42 closed

### 5.5 Post-connection check

Carry out the following checks once you have made the electrical connection:

Device state and specifications	Notes
Are the devices and cables free from damage on the outside?	Visual inspection

Electrical connection	Notes
Are the mounted cables strain relieved?	
Are the connected cables provided with strain relief?	
Is the cable run correct, without loops and cross-overs?	
Are the power cable and signal cables connected correctly and in accordance with the wiring diagram?	
Are all the screw terminals tightened?	
Are all the cable entries fitted, tightened and leak-proof?	

## 6 Operation options

### 6.1 Quick operation guide

You have the following ways of operating the transmitter:

- On site via the key field
- Via the HART interface (optional, with corresponding order version) with:
  - HART handheld terminal
  - PC with HART modem and the Fieldcare software package
- Via PROFIBUS PA/DP (optional, with corresponding order version) by PC with a corresponding interface and the Fieldcare software package or via a programmable logic controller (PLC).

 For operation via HART or PROFIBUS PA/DP, please read the relevant sections in the additional Operating Instructions:







- PROFIBUS PA/DP, field communication for Liquisys M CXM223/253, BA00209C/07/EN
- HART, field communication for Liquisys M CXM223/253, BA00208C/07/EN

The following section only explains operation via the keys.

### 6.2 Display and operating elements

#### 6.2.1 Display

##### LED displays

  <small>A0027220</small>	Indicates the current operating mode, "Auto" (green LED) or "Manual" (yellow LED)
 1  2 <small>A0027222</small>	Indicates the activated relay in the "Manual" mode (red LED) The status of relays 3 and 4 is indicated on the LC display.
 REL 1  REL 2 <small>A0027221</small>	Indicates the working status of relay 1 and 2 LED green: measured value within the permitted limit, relay inactive LED red: measured value outside the permitted limit, relay active
 ALARM <small>A0027218</small>	Alarm display, e.g. in event of continuous limit value overshoot, temperature sensor failure or system error (see error list)

## LC display

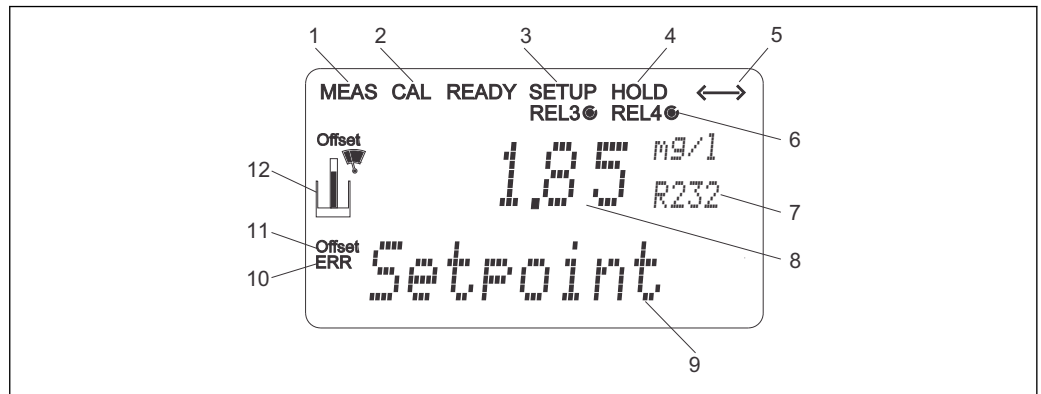

A0027224-EN

20 Transmitter LC display

- 1 Indicator for measuring mode (normal operation)
- 2 Indicator for calibration mode
- 3 Indicator for setup mode (configuration)
- 4 Indicator for "Hold" mode (current outputs remain at last current state)
- 5 Indicator for receipt of a message on devices with communication
- 6 Indicator of working status of relays 3/4: ○ inactive, ● active
- 7 Function code
- 8 In measuring mode: measured variable - in setup mode: configured variable
- 9 In measuring mode: secondary measured value - in setup/calibr. mode: e.g. set value
- 10 "Error": error display
- 11 Temperature offset
- 12 Sensor symbol

## 6.2.2 Operating elements

The display shows the current measured value and the temperature simultaneously, which means you have an overview of the most important process data at once. Help text in the configuration menu helps users configure the device parameters.

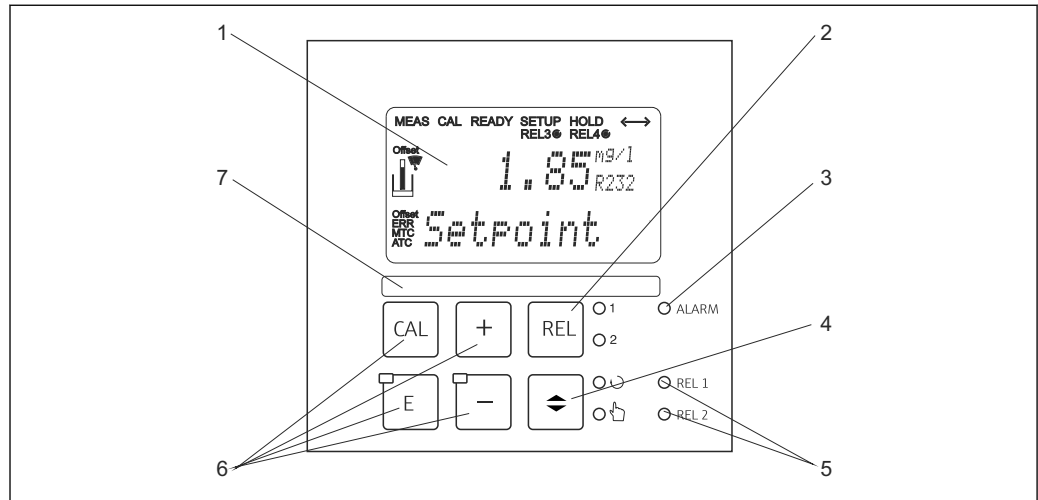





A0024633-EN



### 21 Operating elements

- 1 LC display for displaying the measured values and configuration data
- 2 Key to switch relays in manual mode and to display the active contact
- 3 LED for alarm function
- 4 Changeover switch for automatic/manual mode
- 5 LEDs for limit contactor relay (switch status)
- 6 Main operating keys for calibration and device configuration
- 7 Field for user-defined information

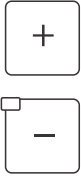
## 6.2.3 Key functions

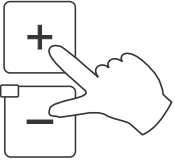
 <p>A0027235</p>	<p><b>CAL key</b></p> <p>When you press the CAL key, the device first prompts you for the calibration access code:</p> <ul style="list-style-type: none"> <li>■ Code 22 for calibration</li> <li>■ Code 0 or any other code for reading the last calibration data</li> </ul> <p>Use the CAL key to accept the calibration data or to switch from field to field within the calibration menu.</p>
 <p>A0027236</p>	<p><b>ENTER key</b></p> <p>When you press the ENTER key, the device first prompts you for the setup mode access code:</p> <ul style="list-style-type: none"> <li>■ Code 22 for setup and configuration</li> <li>■ Code 0 or any other code for reading all the configuration data.</li> </ul> <p>The ENTER key has several functions:</p> <ul style="list-style-type: none"> <li>■ Calls up the Setup menu from the measuring mode</li> <li>■ Saves (confirms) data entered in the setup mode</li> <li>■ Moves on within function groups</li> </ul>

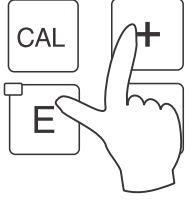
 <p style="text-align: right; font-size: small;">A0027240</p>	<p><b>PLUS key and MINUS key</b></p> <p>In the <b>Setup mode</b>, the PLUS and MINUS keys have the following functions:</p> <ul style="list-style-type: none"> <li>■ Selection of function groups. Press the MINUS key to select the function groups in the order given in the "System configuration" section.</li> <li>■ Configuration of parameters and numerical values</li> <li>■ Operation of the relays in manual mode</li> </ul> <p>In the <b>measuring mode</b>, the following sequence of functions is accessed by <b>repeatedly pressing the PLUS key</b>:</p> <ul style="list-style-type: none"> <li>■ Temperature displayed in °F</li> <li>■ Temperature is hidden</li> <li>■ Measured value display in mg/l</li> <li>■ Measured value display in %SAT</li> <li>■ Measured value display in hPa</li> <li>■ Sensor current in nA/mV</li> <li>■ Current input signal in %</li> <li>■ Current input signal in mA</li> <li>■ Return to basic settings</li> </ul> <p>In the measuring mode, the following sequence of information is displayed by <b>repeatedly pressing the MINUS key</b>:</p> <ul style="list-style-type: none"> <li>■ The current errors are displayed consecutively (max. 10).</li> <li>■ Once all the errors have been displayed, the standard measurement display appears. In the function group F, an alarm can be defined separately for each error code.</li> </ul>
 <p style="text-align: right; font-size: small;">A0027241</p>	<p><b>REL key</b></p> <p>In the manual mode, you can use the REL key to switch between the relay and the manual start of cleaning.</p> <p>In automatic mode, you can use the REL key to read out the switch-on points (for limit contactor) or set points (for PID controller) assigned to the relay in question.</p> <p>Press the PLUS key to jump to the settings of the next relay. Use the REL key to get back to the display mode (automatic return after 30 s).</p>
 <p style="text-align: right; font-size: small;">A0027234</p>	<p><b>AUTO key</b></p> <p>Use the AUTO key to switch between automatic mode and manual mode.</p>
 <p style="text-align: right; font-size: small;">A0027237</p>	<p><b>Escape function</b></p> <p>If you press the PLUS and MINUS key simultaneously, you return to the main menu, or are taken to the end of calibration if calibrating.</p> <p>If you press the PLUS and MINUS key again, you return to the measuring mode.</p>

 <p style="text-align: right; font-size: small;">A0027238</p>	<p><b>Locking the keyboard</b></p> <p>Press the PLUS and ENTER key simultaneously for at least 3 s to lock the keyboard against any unauthorized data entry. All the settings can continue to be read. The code prompt displays the code 9999.</p>
 <p style="text-align: right; font-size: small;">A0027239</p>	<p><b>Unlocking the keyboard</b></p> <p>Press the CAL and MINUS key simultaneously for at least 3 s to unlock the keyboard. The code prompt displays the code 0.</p>







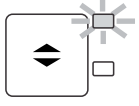
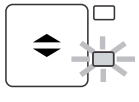

## 6.3 Local operation

### 6.3.1 Automatic/manual mode

The transmitter normally operates in automatic mode. Here, the relays are triggered by the transmitter. In the manual mode, you can trigger the relays manually using the REL key or start the cleaning function.

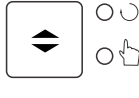
How to change the operating mode:

 <p>A0027242</p>	1.	The transmitter is in automatic mode. The top LED (green) next to the AUTO key is lit.
 <p>A0027243</p>	2.	Press the AUTOMATIC key.
 <p>A0027240</p>	3.	To enable the manual mode, enter the code 22 via the PLUS and MINUS keys and press ENTER to confirm. The lower LED (manual mode) is lit.
 <p>A0027241</p>	4.	Select the relay or the function. You can use the REL key to switch between the relays. The relay selected and the switch status (ON/OFF) is displayed on the second line of the display. In the manual mode, the measured value is displayed continuously (e.g. for measured value monitoring for dosing functions).
 <p>A0027240</p>	5.	Switch the relay. The relay is switched on with PLUS and switched off with MINUS. The relay remains in this switched state until it is switched again.
 <p>A0027234</p>	6.	Press the AUTOMATIC key to return to the measuring mode, i.e. to the automatic mode. All the relays are triggered again by the transmitter.

- 
  - The operating mode remains in effect even after a power failure. The relays assume the quiescent state, however.
  - The manual mode has priority over all other automatic functions.
  - Hardware locking is not possible in the manual mode.
  - The manual settings are kept until they are actively reset.
  - Error code E102 is signaled during manual operation.

## 6.3.2 Operating concept

### Operating modes

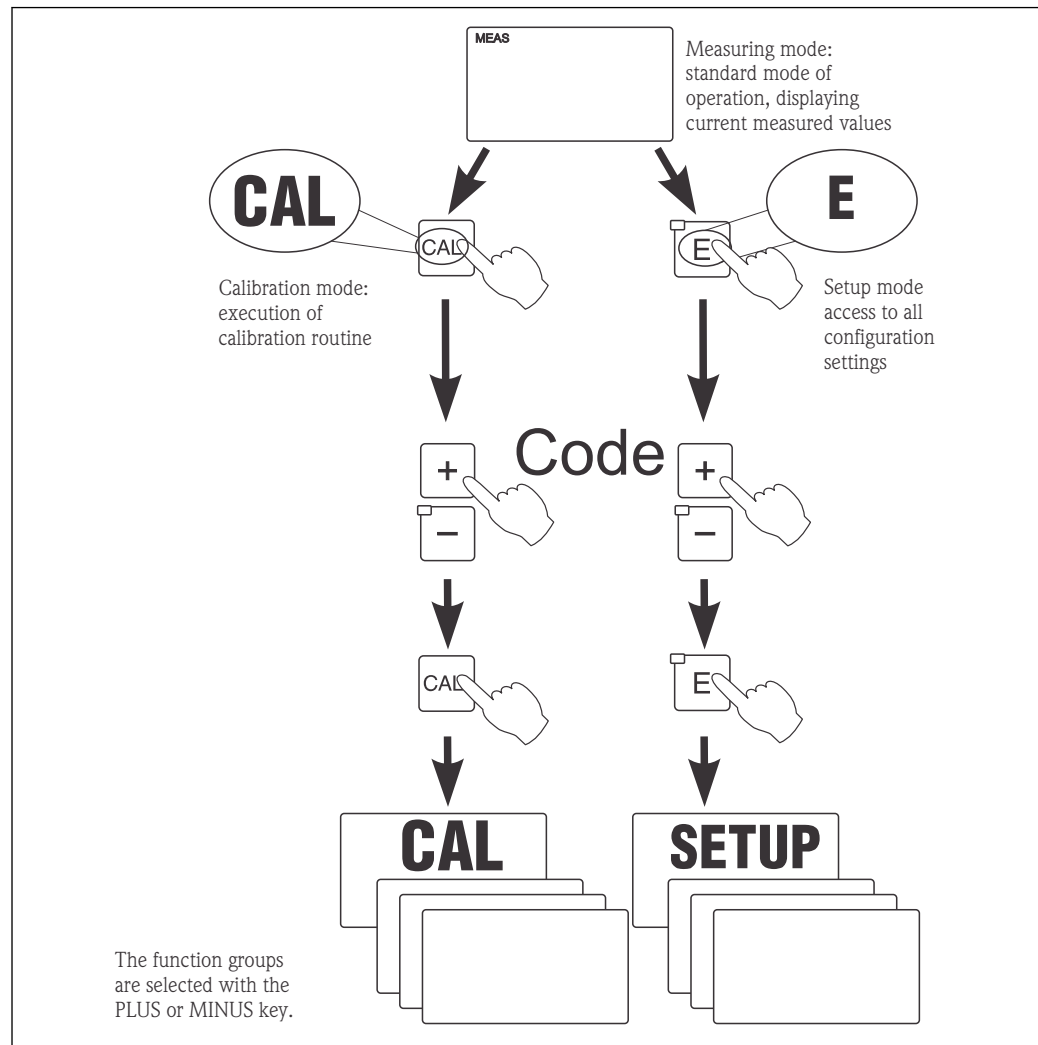

A0027244-EN

22 Description of the possible operating modes

**i** If no key is pressed in the setup mode for approx. 15 min, the device automatically returns to the measuring mode. Any active hold (hold during setup) is canceled.

#### Access codes

All device access codes are fixed and cannot be altered. When the device requests the access code, it distinguishes between different codes.

- **CAL key + code 22**: access to Calibration and Offset menu
- **ENTER key + code 22**: access to the menus for the parameters which make configuration and user-specific settings possible
- **PLUS + ENTER keys** simultaneously (min. 3 s): lock the keyboard
- **CAL + MINUS keys** simultaneously (min. 3 s): unlock the keyboard
- **CAL or ENTER key + any code**: access to read mode, i.e. all the settings can be read but not modified.

The device continues measuring in the read mode. It does not shift to the "Hold" status. The current output and the controllers remain active.

### Menu structure

The configuration and calibration functions are arranged in function groups.

- In the setup mode, select a function group with the PLUS and MINUS keys.
- In the function group itself, switch from function to function with the ENTER key.
- Within the function, select the desired option with the PLUS and MINUS keys or edit the settings with these keys. Then confirm with the ENTER key and continue.
- Press the PLUS and MINUS keys simultaneously (Escape function) to exit programming (return to the main menu).
- Press the PLUS and MINUS keys simultaneously again to switch to the measuring mode.

 If a modified setting is not confirmed by pressing ENTER, the old setting is retained.  
An overview of the menu structure is provided in the Appendix to these Operating Instructions.

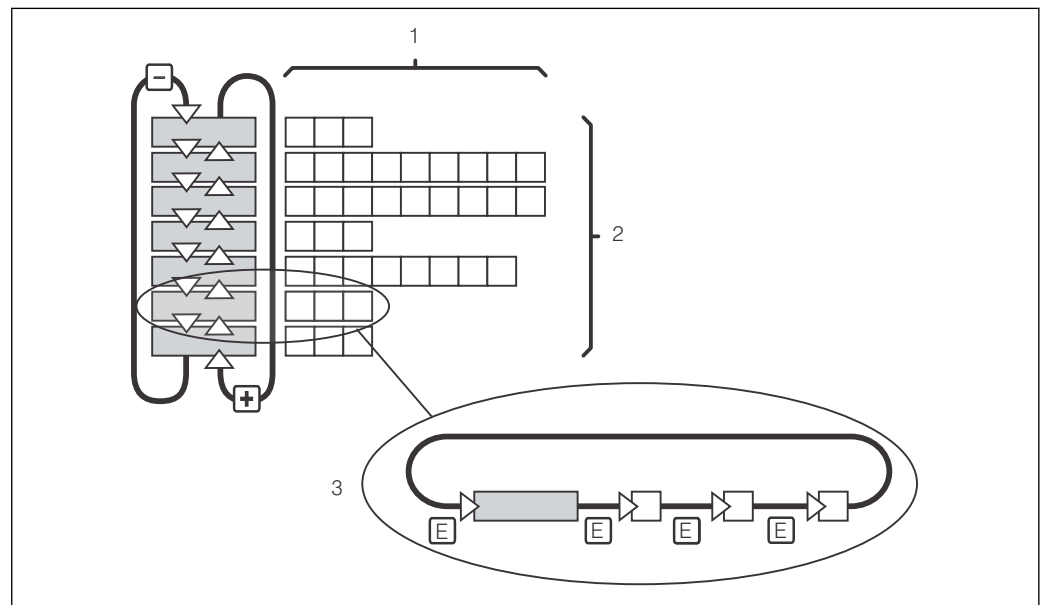

 23 Menu structure

- 1 Functions (selection of parameters, entry of numbers)
- 2 Function groups, scroll backwards and forwards with the PLUS and MINUS keys
- 3 Switch from function to function with the ENTER key

### Hold function: "freeze" the outputs

In both the setup mode and during calibration, the current output can be "frozen" (factory setting), i.e. it constantly retains its current status. "HOLD" appears on the display. If the controller actuating variable (steady control 4 to 20 mA) is output via current output 2, it is set to 0/4 mA during a hold.

- Hold settings can be found in the "Service" function group.
- During a hold, all contacts assume a quiescent state.
- An active hold has priority over all other automatic functions.
- With every hold, the I-component of the controller is set to "0".
- Any alarm delay is reset to "0".
- This function can also be activated externally via the hold input (see Wiring diagram; binary input 1).
- A manual hold (field S3) remains active even after a power failure.

## 7 Commissioning

### 7.1 Function check

#### **⚠ WARNING**

#### **Incorrect connection, incorrect supply voltage**

Safety risks for staff and device malfunctions

- ▶ Check that all connections have been established correctly in accordance with the wiring diagram.
- ▶ Ensure that the supply voltage matches the voltage indicated on the nameplate.

### 7.2 Switching on

Familiarize yourself with the operation of the transmitter before it is first switched on. In particular please read the "Basic safety instructions" and "Operation options" sections. After power-up, the device performs a self-test and then goes to the measuring mode.

Now calibrate the sensor in accordance with the instructions in the "Calibration" section.

**i** During initial commissioning, the sensor must be calibrated so that the measuring system can return precise measurement data.

Then perform the first configuration in accordance with the instructions in the "Quick setup" section. The values set by the user are kept even in the event of a power failure.

The following function groups are available in the transmitter (the groups that are only available in the Plus Package are marked accordingly in the functional description):

#### **Setup mode**

- SETUP 1 (A)
- SETUP 2 (B)
- CURRENT INPUT (Z)
- CURRENT OUTPUT (O)
- ALARM (F)
- CHECK (P)
- RELAY (R)
- SERVICE (S)
- E+H SERVICE (E)
- INTERFACE (I)

#### **Calibration and offset mode**

CALIBRATION (C)

**i** A detailed explanation of the function groups available in the transmitter can be found in the "Device configuration" section.

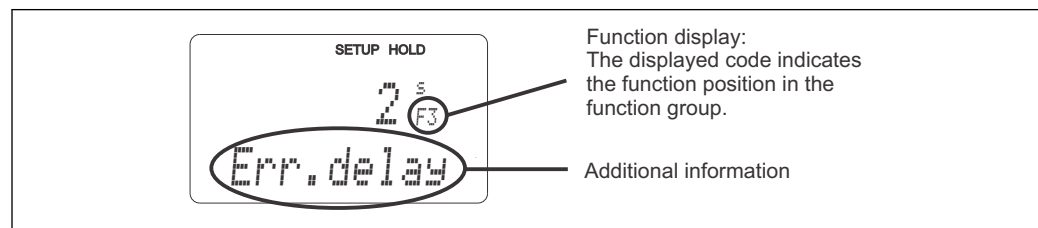

**24** Information for the user on the display

A0025560-EN

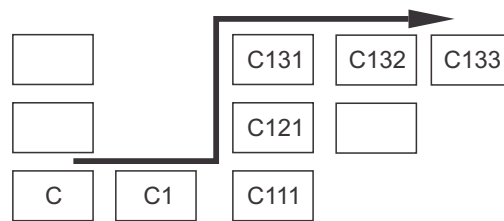

To make it easier for you to select and find function groups and functions, a code for the corresponding field is displayed for each function → 24. The structure of this code is illustrated in → 25. The function groups are indicated as letters in the first column (see the names of the function groups). The functions of the individual groups are displayed incrementally by row and by column.

A0027502

25 Function code

### Factory settings

The first time the device is switched on, the factory setting is set for all the functions. The table below provides an overview of the most important settings.



All other factory settings can be found in the description of the individual function groups in the "System configuration" section (the factory setting is highlighted in **bold**).

Function	Factory setting
Type of measurement	Oxygen concentration in mg/l Temperature measurement in °C
Automatic pressure compensation*	Off (only for WX/WS/DS version)
Altitude	0 m above sea level
Salinity	0.0 % salt content
Current outputs 1 and 2*	4 to 20 mA
Current output 1: measured value for 4 mA signal current	0.00 mg/l 0.000 mg/l (only with COS71 sensor)
Current output 1: measured value for 20 mA signal current	10.00 mg/l 10.000 mg/l (only with COS71 sensor)
Current output 2: temperature value for 4 mA signal current*	0.0 °C
Current output 2: temperature value for 20 mA signal current*	40.0 °C
Alarm contact	Steady contact
Alarm delay	Setting in minutes
Error current for alarm	22 mA
Check functions*	Off. Can be switched on if required
Set point for oxygen	5.00 mg/l 5.000 mg/l (only with COS71 sensor)
Language	English

\* with appropriate version

## 7.3 Quick Setup

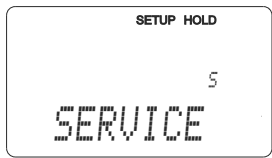
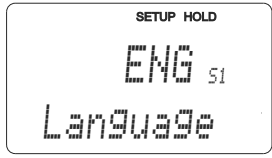
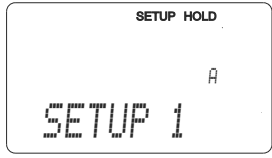
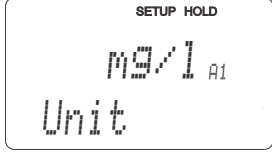
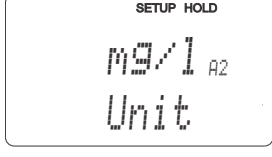
After power-up, you must make some settings to configure the most important functions of the transmitter which are required for correct measurement. The following section gives an example of this.

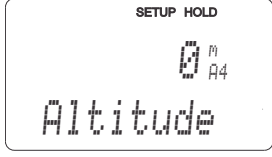

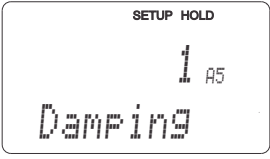
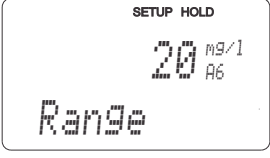
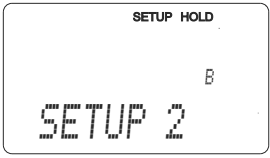
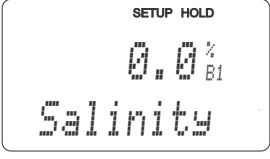
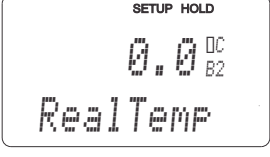
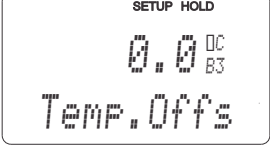

User entry		Range of adjustment (factory settings in bold)	Display
1.	Press the ENTER key		
2.	Enter the code 22 to open access to the menus. Press the ENTER key.		
3.	Press the MINUS key until you get to the "Service" function group.		
4.	Press ENTER to be able to make your settings.		A0008408-EN
5.	Select your language in S1, e.g. "ENG" for English. Press ENTER to confirm your entry.	<b>ENG = English</b> GER = German FRA = French ITA = Italian NEL = Dutch ESP = Spanish	
6.	Press the PLUS and MINUS key simultaneously to exit the "Service" function group.		A0008409-EN
7.	Press the MINUS key until you get to the "Setup 1" function group.		
8.	Press ENTER to be able to make your settings for "Setup 1".		A0007824-EN
9.	In A1, select the desired mode of operation, e.g. "mg/l" for oxygen concentration. Press ENTER to confirm your entry.	<b>mg/l</b> ppm ppb	
			A0024893-EN
10.	In A2, select the desired engineering unit. Press ENTER to confirm your entry.	<b>mg/l</b> ppm ppb	
			A0024894-EN
11.	If you are using a WX, WS or DS version of the device, switch automatic pressure compensation on or off in A3. Automatic compensation takes account of both the altitude dependent and the weather dependent proportion of the air pressure. Press ENTER to confirm your entry.	<b>Off</b> On	
			A0024895-EN
12.	If automatic pressure compensation is not available or if you have switched it off, enter the altitude of your site in A4. Press ENTER to confirm your entry.	<b>0 m</b> 0 to 4000 m	
			A0024896-EN

User entry		Range of adjustment (factory settings in bold)	Display
13.	In A5, enter the damping factor. Measured value damping averages the individual measured values and serves to stabilize the display and the signal output. Enter "1" if no measured value damping is required. Press ENTER to confirm your entry.	<b>1</b> 1 to 60	 A0024897-EN
14.	In A6, enter the oxygen measuring range: <ul style="list-style-type: none"> <li>▪ If you are using COS41, COS61 or COS71, select "20 mg/l" / "200 %SAT" / "400 hPa".</li> <li>▪ If you are using COS31, enter the measuring range required for your process: every range is possible.</li> </ul> Press ENTER to confirm your entry. The display returns to the initial display of the "Setup 1" function group.	<b>20 mg/l</b> 60 mg/l <b>200 %SAT</b> 600 %SAT <b>400 hPa</b> 1200 hPa	 A0024898-EN
15.	Press the MINUS key until you get to the "Setup 2" function group. Press ENTER to make your settings for "Setup 2".		 A0007830-EN
16.	In B1, specify the salinity of your medium. Press ENTER to confirm your entry.	<b>0.0 %</b> 0.0 to 4.0 %	 A0024899-EN
17.	In B2, enter the correct temperature of your process (only if the temperature measurement requires correction). Press ENTER to confirm your entry.	<b>Current measured value</b> -10 to 60 °C	 A0024900-EN
18.	The difference between the measured and entered temperature is displayed. Press the ENTER key The display returns to the initial display of the "Setup 2" function group.	<b>Current measured value</b> -5.0 to 5.0 °C	 A0024901-EN
19.	Press PLUS and MINUS simultaneously to switch to the measurement mode.		

## 7.4 Device configuration

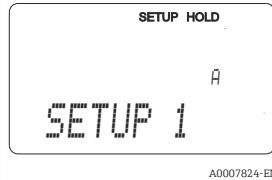
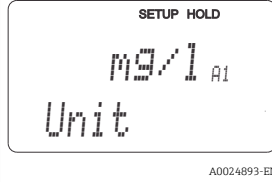
### 7.4.1 Setup 1 (oxygen)

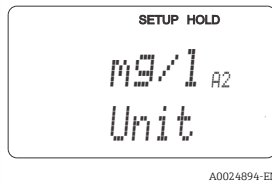
In the SETUP 1 function group, you can change the settings for the measuring mode and the sensor.

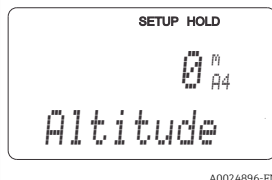
Coding	Field	Range of adjustment (factory settings in bold)	Display	Info
A	<b>SETUP 1</b> function group		 A0007824-EN	Configuration of basic functions
A1	Select the operating mode auswählen	<b>mg/l</b> %SAT hPa	 A0024893-EN	mg/l= oxygen concentration %SAT= oxygen saturation index hPa= oxygen partial pressure  When the operating mode is changed, all user settings are automatically reset to the factory settings. If other units only need to be read, change the display using the PLUS key.
A2	Select the display unit auswählen	<b>mg/l</b> ppm ppb	 A0024894-EN	
A3	Switch automatic pressure compensation on or off	<b>Off</b> On	 A0024895-EN	Field only provided in version WX, WS or DS. The absolute air pressure is measured. Compensation takes account of both the altitude dependent and the weather dependent proportion of the air pressure.
A4	Enter the altitude	<b>0 m</b> 0 to 4000 m	 A0024896-EN	Only displayed if pressure compensation in A2 is switched off or not available.

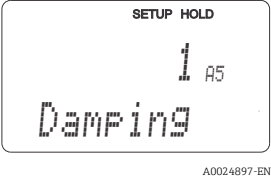
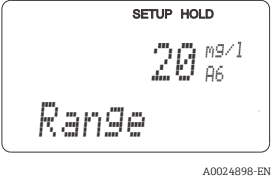

Coding	Field	Range of adjustment (factory settings in bold)	Display	Info
A5	Enter the value for measured value damping eingeben	<b>1</b> 1 to 60		Measured value damping causes averaging over the specified number of individual measured values. This is used, for example, to stabilize the display if the measurement is unstable. There is no damping if "1" is entered.
A6	Enter the oxygen measuring range	<b>20 mg/l, 20 ppm, 20000 ppb</b> 60 mg/l, 60 ppm, 60000 ppb (depending on the display unit selected) <b>200 %SAT</b> 600 %SAT <b>400 hPa</b> 1200 hPa		<b>COS41/61/71 sensor:</b> The measuring range must be 0 to 20mg/l (0 to 200%SAT, 0 to 400hPa). <b>COS31 sensor:</b> Both measuring ranges are possible in each case.

### 7.4.2 Setup 2 (salinity and temperature)

Use this function group to change the settings for the salinity and temperature measurement.

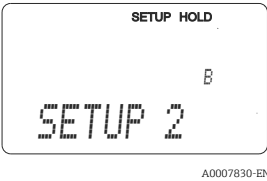
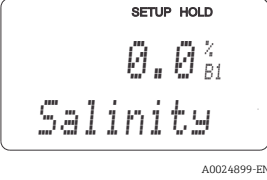
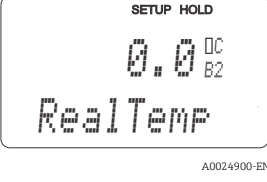
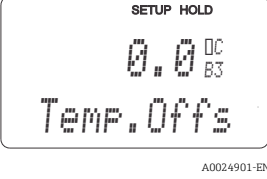
Coding	Field	Range of adjustment (factory settings in bold)	Display	Info
B	<b>SETUP 2</b> function group		 A0007830-EN	Settings for salinity and for temperature measurement
B1	Enter the salinity	<b>0.0 %</b> 0.0 to 4.0 %	 A0024899-EN	The salt content is entered
B2	Enter the correct process temperature	<b>Current measured value</b> -10.0 to 60.0 °C	 A0024900-EN	You can edit the displayed value. The value can be changed by a maximum of ±5 °C. As the measurements are very accurate, the value generally does not need to be adjusted.
B3	Temperature difference (offset) is displayed	<b>Current offset</b> -5.0 to 5.0 °C	 A0024901-EN	The offset is the difference between the measured temperature and the temperature entered.

### 7.4.3 Current input

For the "Current input" function group, you require a relay card with a current input which is not available in the basic device version. With this function group, you can monitor process parameters and use them for feedforward control. For this purpose, you must connect the current output of an external measured variable (e.g. flowmeter) to the 4 to 20mA input of the transmitter. The following assignment applies:

Flow in main stream	Current signal in mA	Current input signal in %
Flowmeter start of measuring range	4	0
Flowmeter end of measuring range	20	100

#### Flow monitoring in the main stream

This arrangement is particularly practical if the sample flow through a flow assembly in an open outlet is independent of the flow in the main stream.

This permits signaling of an alarm condition in the main stream (flow too low or has completely stopped) and triggers dosing switch-off even if the medium flow is maintained due to the method of installation.

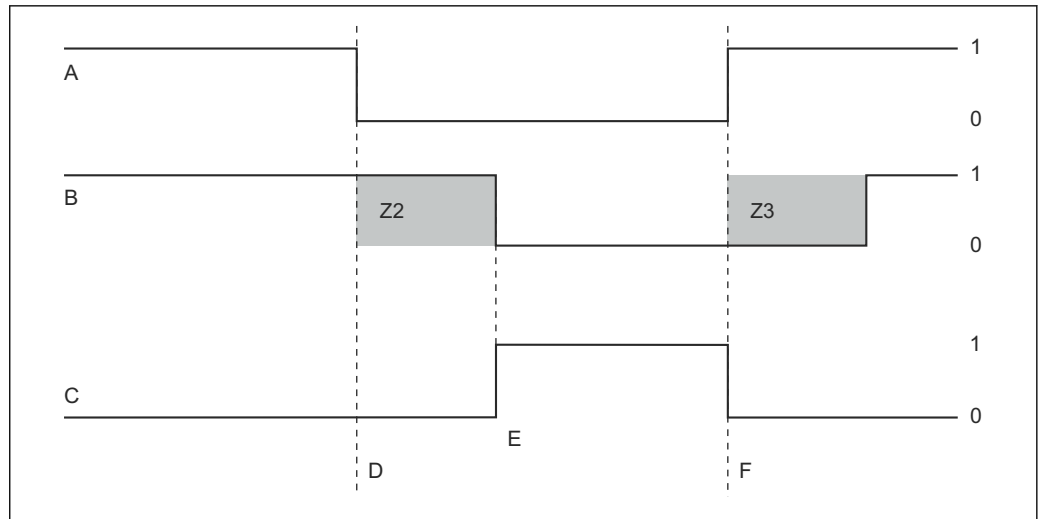

A0008923

26 Alarm signaling and dosing switch-off by the main stream

- |   |   |    |   |
|---|---|----|---|
| A | Flow in main stream                             | F  | Flow restoration                              |
| B | Relay contacts of PID controller                | Z2 | Delay for controller switch-off, see field Z2 |
| C | Alarm relay                                     | Z3 | Delay for controller switch-on, see field Z3  |
| D | Flow below switch-off limit Z 4 or flow failure | 0  | Off   |
| E | Flow alarm                                      | 1  | On  |

**Feedforward control to PID controller**

You can optimize control on control systems with very short response times by measuring the medium flow rate in addition to the oxygen content. Then apply this flow rate value (4 to 20 mA) as feedforward control to the PID controller.

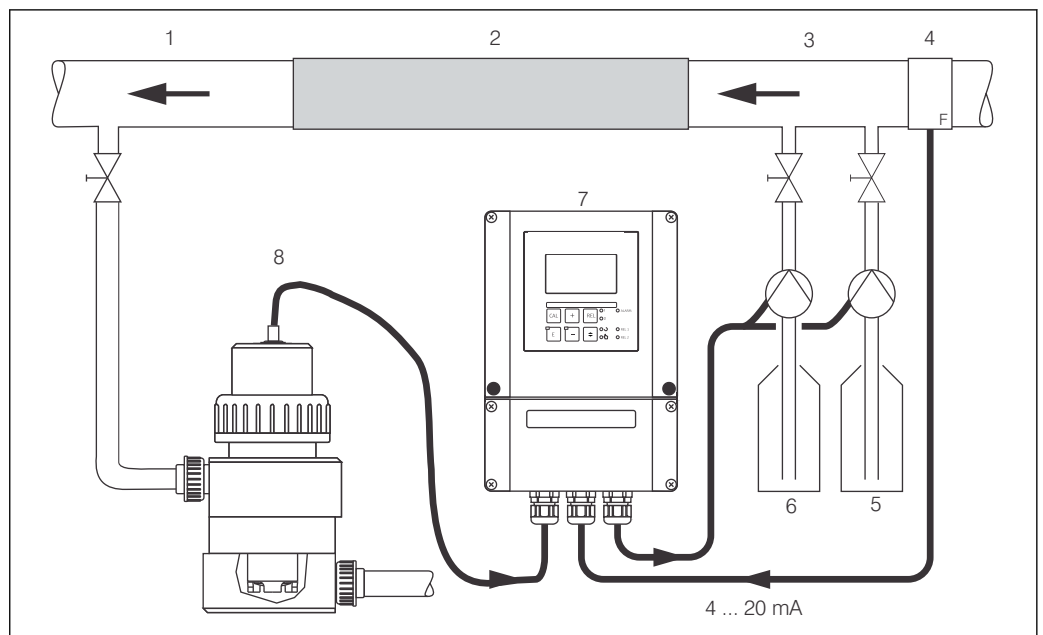

A0024956

27 Sample arrangement for feedforward control of the flow in the main stream to the PID controller

- |   |                      |   |                 |
|---|----------------------|---|-----------------|
| 1 | Medium tapping point | 5 | Reducing agent  |
| 2 | Static mixer         | 6 | Oxidizing agent |

3 Injection points

7 Liquisys COM253

4 Flowmeter

8 COA250 with COS31

Feedforward control is a multiplying function as illustrated in the figure below (example with factory setting):

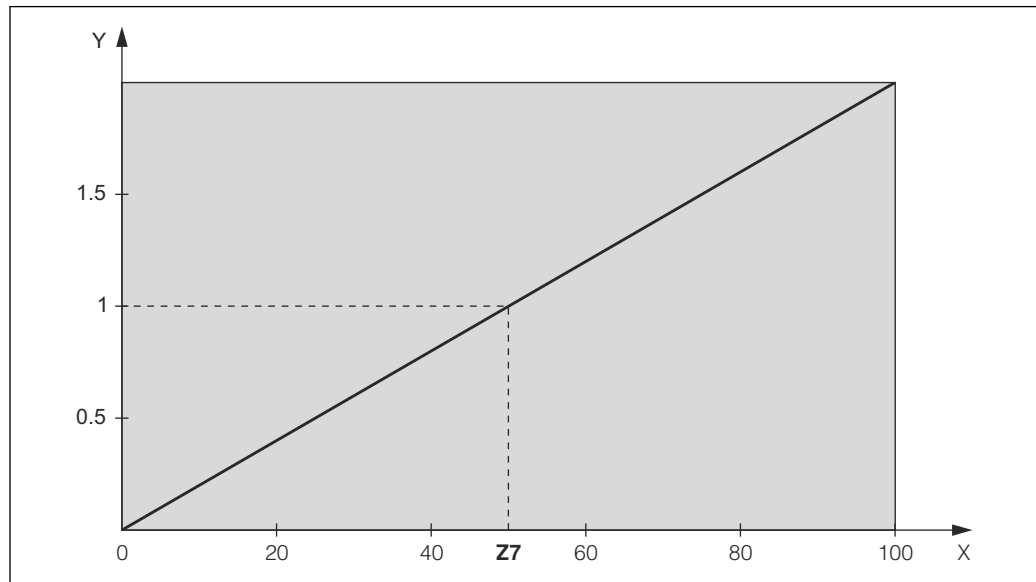

A0008942

28 Multiplying feedforward control

Y Gain  $K_{infl}$

X Current input signal in [%]

Functions marked in *italics* are not supported by the basic device version.

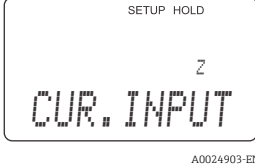
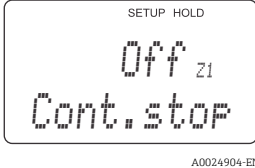
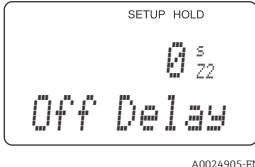
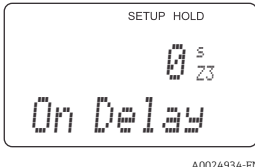
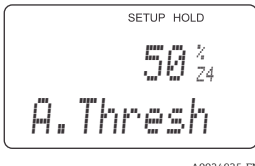
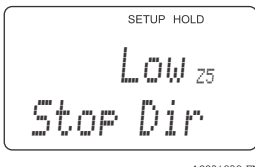
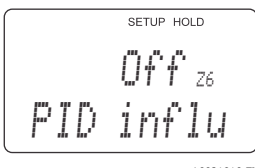
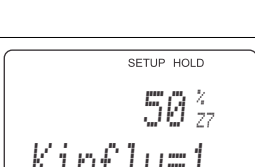
Coding	Field	Range of adjustment (factory settings in bold)	Display	Info
Z	<b>CURRENT INPUT function group</b>			Current input settings
Z1	Select flow monitoring of main stream (with controller switch-off)	<b>Off</b> On		Flow monitoring may only be switched on if the flowmeter is connected in the main stream. If Z1 = off, fields Z2 to Z5 are not available.
Z2	Enter the delay for controller switch-off through current input	<b>0 s</b> 0 to 2000 s		Brief flow shortfalls can be suppressed by this delay and do not result in controller switch-off.
Z3	Enter the delay for controller switch-on through current input	<b>0 s</b> 0 to 2000 s		In the case of a controller, a delay until the reception of a representative measured value is recommended after a long period without flow.
Z4	Enter the switch-off limit value for the current input	<b>50 %</b> 0 to 100 %		0 to 100% corresponds to 4 to 20 mA at the current input. Observe measured value assignment to the current output of the flowmeter.
Z5	Enter the switch-off direction for the current input	<b>Low</b> High		The controller is switched off if the value entered in Z4 is undershot or overshoot.
Z6	Select feedforward control to PID controller	<b>Off</b> Lin = linear Basic		If Z6 = off, the field Z7 is not available. Z6 = basic: disturbance variable only affects the basic load (alternatively dosing in proportion to quantity, if usual PID controller not possible, e.g. defective sensor).
Z7	Enter value for feedforward control at which gain = 1 applies	<b>50 %</b> 0 to 100 %		When the value is set, the controller actuating variable is the same size when feedforward control is switched on as when feedforward control is switched off.

### 7.4.4 Current outputs

Use the "Current output" function group to configure the individual outputs. You can enter either a linear characteristic (O3 (1)) or a user-defined current output characteristic in conjunction with the Plus Package (O3 (3)). Exception: if you have chosen a "continuous controller" for current output 2, you cannot enter a user-defined current output characteristic for this current output.

In addition, you can also simulate a current output value (O3 (2)) to check the current outputs.

If a second current output is present, you can output the controller actuating variable via the current output in accordance with field R237.

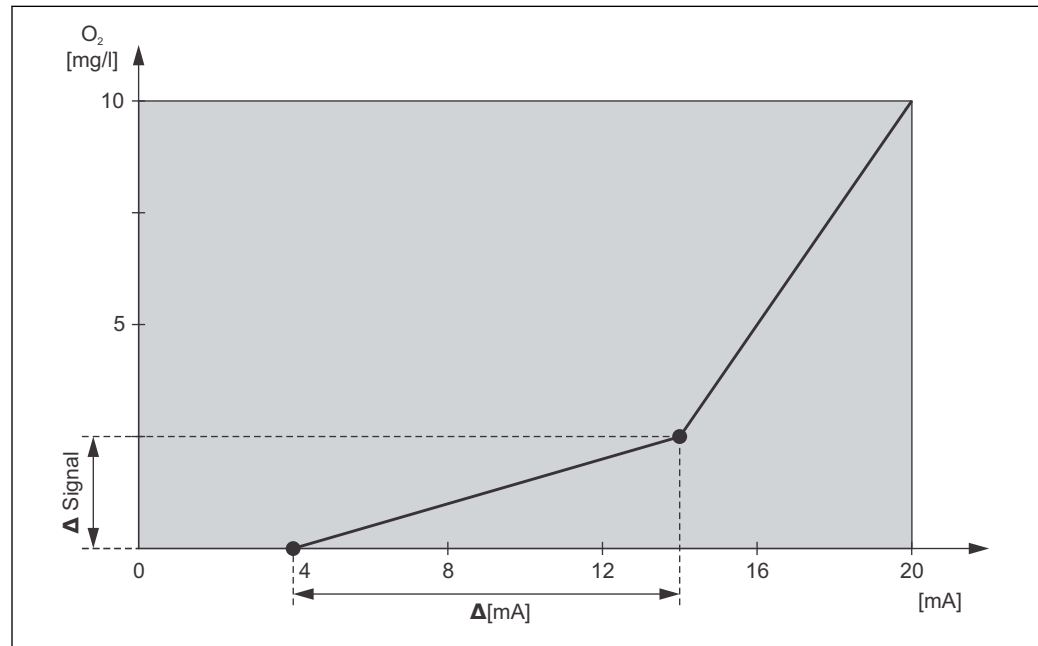

29 User-defined current output characteristic (example)

The current output characteristic must increase or decrease very monotonically.

The distance per mA between two table value pairs must be greater than:

	Measuring range	Minimum distance per mA
Oxygen	0 to 20 mg/l	0.13 mg/l
	0 to 60 mg/l	0.38 mg/l
	0 to 200 % SAT	1.30 %SAT
	0 to 600 % SAT	3.80 %SAT
	0 to 400 hPa (0 to 6 psi)	2.50 hPa
	0 to 1200 hPa (0 to 6 psi)	7.50 hPa
Temperature	-10 to 60 °C	0.45 °C

The values for the sample characteristic →  29 are entered in the following table. The distance per mA is calculated from  $\Delta \text{ signal} / \Delta \text{ mA}$ .

Value pair	Current output 1			Current output 2		
	Oxygen [mg/l] [%SAT] [hPa]	Current [mA]	Distance per mA	Temperature [°C] [°F]	Current [mA]	Distance per mA
1	0	4				
2	2.5	14	0.25			
3	10	20	1.25			

First enter the desired current output configuration into the following blank table with a pencil. Calculate the resulting signal distance per mA to observe the necessary minimum slope. Then enter the values in the device.

Value pair	Current output 1			Current output 2		
	Oxygen [mg/l; %SAT; hPa]	Current [mA]	Distance per mA	Temperature [°C; °F]	Current [mA]	Distance per mA
1						
2						
3						
4						
5						
6						
7						
8						
9						
10						

Functions marked in *italics* are not supported by the basic device version.

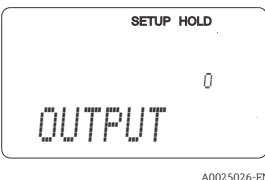
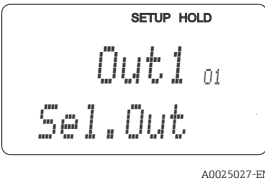
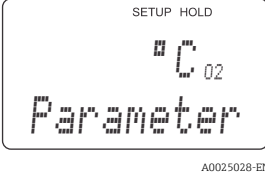
Coding	Field	Range of adjustment (factory settings in bold)	Display	Info
0	<b>CURRENT OUTPUT function group</b>		 <small>A0025026-EN</small>	Configuration of the current output (does not apply for PROFIBUS).
01	Select current output	<b>Out 1</b> <i>Out 2</i>	 <small>A0025027-EN</small>	A characteristic can be selected for every output.
02	Select measured variable for 2nd current output	<b>°C</b> mg/l, ppm <i>Contr</i>	 <small>A0025028-EN</small>	R237=curr (current output 2) can only be selected if O2=Contr (controller) is selected (relay card required).

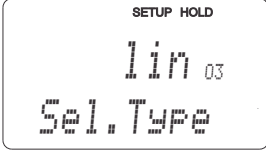
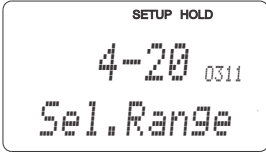
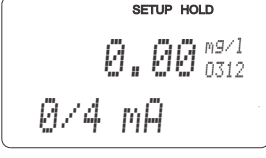
Coding	Field	Range of adjustment (factory settings in bold)	Display	Info
O3 (1)	Enter the characteristic type	<b>Lin = linear (1)</b> Sim = simulation (2) Tab = table (3)	 <p style="text-align: right; font-size: small;">A0025029-EN</p>	The characteristic can have a positive or negative slope for the measured value output. In the case of actuating variable output (O2 = Contr), an increasing current corresponds to an increasing actuating variable.
O311	Select current range	<b>4 to 20mA</b> 0 to 20 mA	 <p style="text-align: right; font-size: small;">A0025030-EN</p>	
O312	0/4 mA value: Enter the associated measured value	Version with DX/DS or WX/WS with COS61: <b>0.00 mg/l*</b> 0.00 to 20.00 mg/l <b>0.0 %SAT</b> 0.0 to 200.0 %SAT <b>0 hPa</b> 0 ... hPa WX/WS with COS31: <b>0.00 mg/l*</b> 0.00 to 60.00 mg/l <b>0.0 %SAT</b> 0.0 to 600.0 %SAT <b>0 hPa</b> 0 to 1200 hPa (0 to 6 psi) WX/WS with COS71: <b>0.000 mg/l*</b> 0.000 to 20.000 mg/l <b>0.0 %SAT</b> 0.0 to 200.0 %SAT <b>0 hPa</b> 0 to 400 hPa (0 to 6 psi) <b>0.0 °C</b> -10.0 to 60.0 °C	 <p style="text-align: right; font-size: small;">A0025031-EN</p>	Here you can enter the measured value at which the min. current value (0/4 mA) is applied at the transmitter output (not for controller). For the minimum distance between the 0/4 mA and 20 mA value, see field O313 * Displayed data depend on setting in field A2.

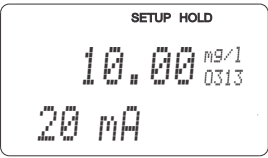
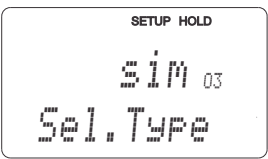
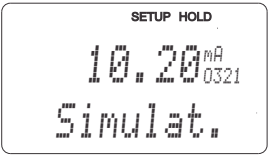
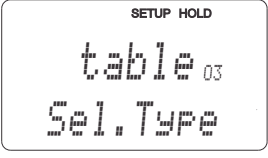
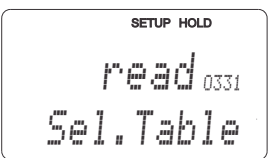
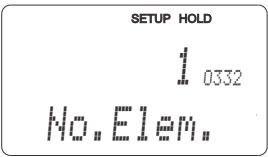

Coding	Field	Range of adjustment (factory settings in bold)	Display	Info
0313	20 mA value: Enter the associated measured value	Version with DX/DS or WX/WS with COS61: <b>10.00 mg/l*</b> 0.00 to 20.00 mg/l <b>100.0 %SAT</b> 0.0 to 200.0 %SAT <b>200 hPa</b> 0 ... hPa WX/WS with COS31: <b>10.00 mg/l*</b> 0.00 to 60.00 mg/l <b>100.0 %SAT</b> 0.0 to 600.0 %SAT <b>200 hPa</b> 0 to 1200 hPa (0 to 6 psi) WX/WS with COS71: <b>10.000 mg/l*</b> 0.000 to 20.000 mg/l <b>100.0 %SAT</b> 0.0 to 200.0 %SAT <b>200 hPa</b> 0 to 400 hPa (0 to 6 psi) <b>40.0 °C</b> -10.0 to 60.0 °C	 A0025032-EN	Here you can enter the measured value at which the max. current value (20 mA) is applied at the transmitter output (not for controller). Minimum distance between the 0/4 mA and 20 mA value must be as follows: Oxygen: <ul style="list-style-type: none"> <li>DX/DS or WX/WS with COS61: 0.2 mg/l / 2 %SAT / 4 hPa</li> <li>WX/WS with COS31: 0.6 mg/l / 6 %SAT / 12 hPa</li> <li>WX/WS with COS71: 0.02 mg/l / 0.2 %SAT / 0.4 hPa</li> </ul> Temperature: All versions: 7 °C * Displayed data depend on setting in field A2.
03 (2)	Simulate current output	Lin = linear (1) <b>Sim = simulation (2)</b> Tab = table (3)	 A0025039-EN	Simulation is not ended until O3(1) or O3(3) is selected. For further characteristics, see O3 (1), O3 (3).
0321	Enter simulation value	<b>Current value</b> 0.00 to 22.00 mA	 A0025040-EN	Entering a current value results in this value being directly output at the current output.
03 (3)	Enter current output table	Lin = linear (1) Sim = simulation (2) <b>Tab = table (3)</b>	 A0025041-EN	Only for S version Values can also be subsequently added or modified. The values entered are automatically sorted by increasing current value. For further characteristics, see O3 (1), O3 (2).
0331	Select table option	<b>Read</b> Edit	 A0025042-EN	
0332	Enter number of table value pairs	<b>1</b> 1 to 10	 A0025043-EN	Enter the number of pairs of x and y values (measured value and current value) here.

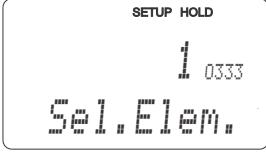
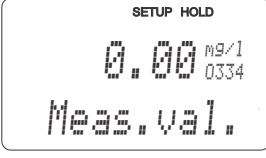
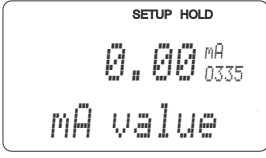
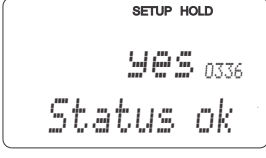
Coding	Field	Range of adjustment (factory settings in bold)	Display	Info
O333	Select table value pair	<b>1</b> 1 to no. elem. Assign	 <p>A0025044-EN</p>	The system runs through the O333 to O335 function chain as often as indicated in O332. "Assign" appears as the last step. The display goes to O336 after confirmation.
O334	Enter x value	Version with DX/DS or WX/WS with COS61: <b>0.00 mg/l*</b> 0.00 to 20.00 mg/l <b>0.0 %SAT</b> 0.0 to 200.0 %SAT <b>0 hPa</b> 0 ... hPa WX/WS with COS31: <b>0.00 mg/l*</b> 0.00 to 60.00 mg/l <b>0.0 %SAT</b> 0.0 to 600.0 %SAT <b>0 hPa</b> 0 to 1200 hPa (0 to 6 psi) WX/WS with COS71: <b>0.000 mg/l*</b> 0.000 to 20.000 mg/l <b>0.0 %SAT</b> 0.0 to 200.0 %SAT <b>0 hPa</b> 0 to 400 hPa (0 to 6 psi) <b>0.0 °C</b> -10.0 to 60.0 °C	 <p>A0025046-EN</p>	x value = measured value specified by user.
O335	Enter y value	<b>0.00 mA</b> 0.00 to 20.00 mA	 <p>A0025048-EN</p>	y value = user-defined current value pertaining to O334. Return to O333 until all values are entered.
O336	Message as to whether table status is OK	<b>Yes</b> No	 <p>A0025049-EN</p>	Back to O3. If status = no, correct the table (all settings made up until now remain intact) or go back to the measuring mode (table is deleted).





## 7.4.5 Alarm

You can use the "Alarm" function group to define various alarms and configure output contacts.

Each individual error can be defined to be effective or not (at the contact or as an error current).

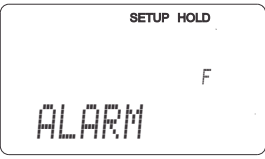
In the event of an alarm, a cleaning function can also be activated (F8).

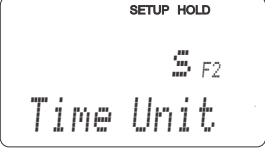
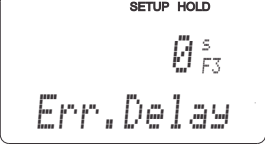
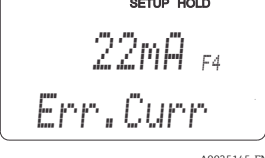
Functions marked in italics are not supported by the basic device version.

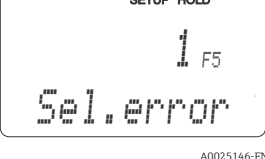
Coding	Field	Range of adjustment (factory settings in bold)	Display	Info
F	<b>ALARM</b> function group		 A0025141-EN	Alarm function settings.
F1	Select contact type	<b>Latch = latching contact</b> Momen = momentary contact	 A0025142-EN	The option selected only applies for the fault-signaling contact, not for the error current.
F2	Select the time unit for the alarm delay	<b>s</b> min	 A0025143-EN	
F3	Enter alarm delay	<b>0 s (min)</b> 0 to 2000 s (min)	 A0025144-EN	Depending on the option selected in F2, the alarm delay can be entered in s or min.
F4	Select error current	<b>22 mA</b> 2.4 mA	 A0025145-EN	 If "0-20 mA" was selected in O311, "2.4 mA" may not be used.
F5	Select the error number	<b>1</b> 1 to 255	 A0025146-EN	Here you can select all the errors which should trigger an alarm. The errors are selected by the error numbers. Please refer to the table in the "System error messages" section for the meaning of the individual error numbers. The factory settings remain in effect for all errors that are not edited.

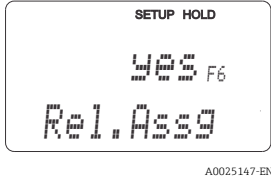
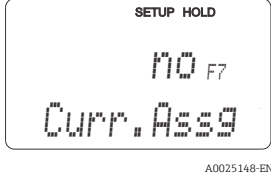
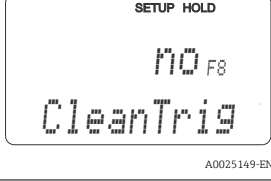
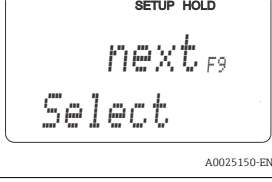
Coding	Field	Range of adjustment (factory settings in bold)	Display	Info
F6	Set alarm contact to be effective for the selected error	<b>Yes</b> No	 <p>A0025147-EN</p>	If "no" is selected, all the other alarm settings are deactivated (e.g. alarm delay). The settings themselves are maintained. This setting <b>only</b> applies to the error currently selected in F5.
F7	Set error current to be effective for the selected error	<b>No</b> Yes	 <p>A0025148-EN</p>	The option selected in F4 is effective or not effective in the event of an error. This setting <b>only</b> applies to the error currently selected in F5.
F8	<i>Automatic cleaning function start</i>	<b>No</b> Yes	 <p>A0025149-EN</p>	This field is not available for certain errors, see the "Troubleshooting and fault elimination" section.
F9	Select return to menu or next error	<b>Next</b> = next error number ←R	 <p>A0025150-EN</p>	If ←R is selected, you return to F. If Next is selected, you go to F5.

### 7.4.6 Check

The CHECK function group is only available for devices with a Plus Package.

In the CHECK function group, you can select different monitoring functions for the measurement.

By default all monitoring functions are switched off. The Sensor Check System is adapted to the current application conditions by adding and setting the suitable functions.

#### Alarm threshold monitoring

In the case of oxygen measurement without dosage control (ventilation) sensor errors cause a measured value error, but have no impact on the process medium (example: monitoring measurements in surface water or in water works). Sensor errors generally cause implausibly high or low readings. This is detected and signaled by user-definable alarm thresholds.

#### Controller monitoring

In the case of oxygen measurement with simultaneous dosage control, sensor errors not only cause incorrect measured values but also have a direct impact on the state of the process medium. Particularly in the case of oxygenation control in wastewater treatment plants, due to the closed control loop there is the risk that the aeration will not switch on if the measured value is constantly too high. If the oxygen supply is too low, this creates a considerable risk for the microbiology system and the cleaning performance of microbes. On the other hand, a measured value which is constantly too low results in increased operating costs due to the continuous operation of the aeration units. These cases are detected and signaled using user-definable monitoring times for maximum permitted limit value overshoot and undershoot.

### Sensor activity monitoring

The effect of the process medium on the sensor can also result in incorrect measured values. The collection of solid matter at the sensor or thick deposit buildup on the sensor membrane can cause a very sluggish or even completely passive measuring signal. This passive behavior is detected and signaled by constantly monitoring the signal activity.

### Overview of SCS monitoring functions



	Mode of operation	Possible setting	Alarm event	Use
Alarm threshold monitoring (P1 to P4)	<ul style="list-style-type: none"> <li>▪ User-definable lower alarm threshold (AS)</li> <li>▪ User-definable upper alarm threshold (AS)</li> </ul>	Off	-	Applications <b>with</b> or <b>without</b> oxygenation control
		Only lower alarm threshold	Lower alarm threshold reached or undershot	
		Only upper alarm threshold	Upper alarm threshold reached or exceeded	
		Lower and upper alarm threshold	Lower alarm threshold reached or undershot or upper alarm threshold reached or exceeded	
Controller monitoring (CC: controller check, P5 to P8)	<ul style="list-style-type: none"> <li>▪ Switch-on duration monitoring</li> <li>▪ Switch-off duration monitoring</li> </ul>	Off	-	Applications <b>with</b> oxygenation control
		On	Set maximum duration for permanent switch-on or switch-off exceeded	
Sensor activity monitoring (AC: alternation check, P5 to P8)	Signal change monitoring	Off	-	Applications <b>with</b> or <b>without</b> oxygenation control
		On	Change within 1 hour less than <ul style="list-style-type: none"> <li>▪ <math>\pm 0.1</math> mg/l</li> <li>▪ <math>\pm 1</math> %SAT mg/l</li> <li>▪ <math>\pm 2</math> hPa mg/l</li> </ul>	

You can use the "Check" function group to monitor the measured value for permissible upper and lower limits and trigger an alarm.

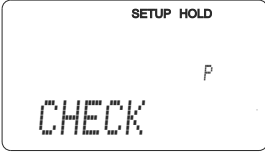
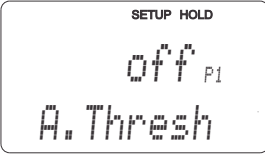
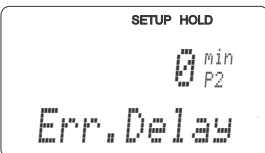
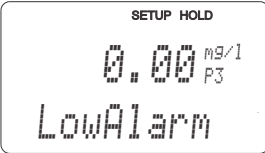
Functions marked in italics are not supported by the basic device version.

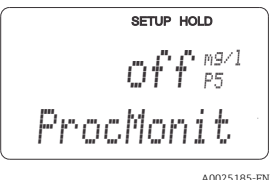
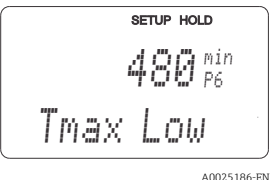
Coding	Field	Range of adjustment (factory settings in bold)	Display	Info
P	<b>CHECK function group</b>		 A0009045-EN	Settings for sensor and process monitoring
P1	Select alarm threshold monitoring	<b>Off</b> Low High LoHi = low and high Lo! Hi! LoHi!	 A0025181-EN	Alarm possible with or without controller switch-off. xxxx = without controller switch-off xxxx! = with controller switch-off
P2	Enter alarm delay	<b>0 min (s)</b> 0 to 2000 min (s)	 A0025182-EN	Depending on the option selected in F2, the alarm delay can be entered in s or min. This delay must first elapse before undershooting/overshooting in accordance with fields P3/P4 results in an alarm.
P3	Enter lower alarm threshold	<ul style="list-style-type: none"> <li>▪ DX/DS version or WX/WS version with COS61: <b>0.00 mg/l*</b> 0.00 to 19.00 mg/l <b>0.0 %SAT</b> 0.0 to 190.0 %SAT <b>0 hPa</b> 0 to 380 hPa</li> <li>▪ WX/WS with COS31: <b>0.00 mg/l*</b> 0.00 to 59.00 mg/l <b>0.0 %SAT</b> 0.0 to 590.0 %SAT <b>0 hPa</b> 0 to 1180 hPa</li> <li>▪ WX/WS with COS71: <b>0.000 mg/l*</b> 0.000 to 19.000 mg/l <b>0.0 %SAT</b> 0.0 to 190.0 %SAT <b>0 hPa</b> 0 to 380 hPa</li> </ul>	 A0025183-EN	* Displayed data depend on setting in field A2.

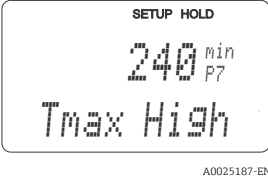
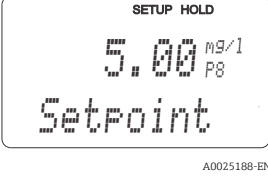
Coding	Field	Range of adjustment (factory settings in bold)	Display	Info
P4	Enter upper alarm threshold	<ul style="list-style-type: none"> <li>■ DX/DS version or WX/WS version with COS61:  <b>20.00 mg/l*</b>                      1.00 to 20.00 mg/l  <b>200.0 %SAT</b>                      0.0 to 200.0 %SAT  <b>400 hPa</b>                      20 to 400 hPa</li> <li>■ WX/WS with COS31:  <b>20.00 mg/l*</b>                      1.00 to 60.00 mg/l  <b>200.0 %SAT</b>                      10.0 to 600.0 %SAT  <b>400 hPa</b>                      20 to 1200 hPa</li> <li>■ WX/WS with COS71:  <b>20.000 mg/l*</b>                      0.010 to 20.000 mg/l  <b>200.0 %SAT</b>                      0.5 to 200.0 %SAT  <b>400 hPa</b>                      20 to 400 hPa</li> </ul>		* Displayed data depend on setting in field A2.
P5	Select process monitoring	Off AC CC AC+CC AC! CC! AC+CC!		AC = sensor activity monitoring CC = controller monitoring AC monitoring limits: <ul style="list-style-type: none"> <li>■ ±0.1 mg/l</li> <li>■ ±1 %SAT</li> <li>■ ±2 hPa per hour</li> </ul> xxxx = without controller switch-off xxxx! = with controller switch-off
P6	Enter maximum permissible duration for limit value undershoot	<b>480 min</b> 0 to 2000 min		Must only be configured if controller monitoring (CC) is switched on in field P5.

Coding	Field	Range of adjustment (factory settings in bold)	Display	Info
P7	Enter maximum permissible duration for limit value overshoot	<b>240 min</b> 0 to 2000 min	 A0025187-EN	Must only be configured if controller monitoring (CC) is switched on in field P5.
P8	Enter set point	<ul style="list-style-type: none"> <li>■ DX/DS version or WX/WS version with COS61: <b>5.00 mg/l*</b> 0.00 to 20.00 mg/l <b>50.0 %SAT</b> 0.0 to 200.0 %SAT <b>200 hPa</b> 0 to 400 hPa (0 to 6 psi)</li> <li>■ WX/WS with COS31: <b>5.00 mg/l*</b> 0.00 to 60.00 mg/l <b>50.0 %SAT</b> 0.0 to 600.0 %SAT <b>200 hPa</b> 0 to 1200 hPa (0 to 6 psi)</li> <li>■ WX/WS with COS71: <b>1.000 mg/l*</b> 0.000 to 20.000 mg/l <b>10.0 %SAT</b> 0.0 to 200.0 %SAT <b>20 hPa</b> 0 to 400 hPa (0 to 6 psi)</li> </ul>	 A0025188-EN	<p>Limit value for monitoring according to fields P6 and P7.</p> <p> When performing external control from a process control system with an external set point, make sure that the setting matches that in field P8.</p> <p>* Displayed data depend on setting in field A2.</p>

### 7.4.7 Relay configuration

For the "RELAY" function group, you require a relay card which is not available in the basic device version.

The following relay contacts can be selected and configured as desired (max. four contacts, depending on options installed):

- Limit contactor for oxygen measured value: R2 (1)
- Limit contactor for temperature: R2 (2)
- PID controller: R2 (3)
- Timer for cleaning function: R2 (4)
- Chemoclean function: R2 (5)

#### Limit contactor for oxygen measured value and temperature

The transmitter has different ways of assigning a relay contact. Switch-on and switch-off points and pickup and dropout delays can be assigned to the limit contactor. In addition, you can configure an alarm threshold to output an error message and to start a cleaning function in conjunction with this.

These functions can be used both for the primary value and for temperature measurement.

Please refer to the switch states in →  30 for a clear illustration of the relay contact states.



- When the measured values increase (maximum function), the relay contact is closed as of  $t_2$  after the switch-on point ( $t_1$ ) has been exceeded and the pickup delay has elapsed ( $t_2 - t_1$ ).  
The alarm contact switches if the alarm threshold ( $t_3$ ) is reached and the alarm delay ( $t_4 - t_3$ ) has also elapsed (errors E067 to E070).
- When the measured values decrease, the alarm contact is reset when the value falls below the alarm threshold ( $t_5$ ) again, as is the relay contact ( $t_7$ ) after the dropout delay ( $t_7 - t_6$ ).
- If the pickup and dropout delays are set to 0 s, the switch-on and switch-off points are also switch points of the contacts.

The same settings can also be made for a minimum function in the same way as for the maximum function.

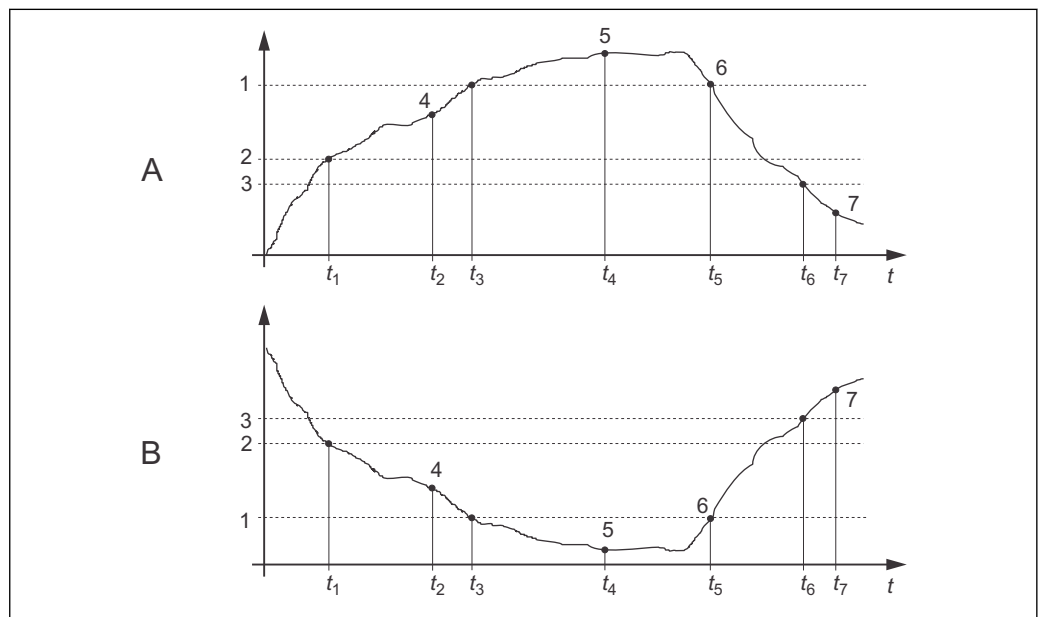

30 Illustration of the alarm and limit value functions

- A Switch-on point > switch-off point: Max. function  
 B Switch-on point < switch-off point: Min. function  
 1 Alarm threshold  
 2 Switch-on point  
 3 Switch-off value  
 4 Contact ON  
 5 Alarm ON  
 6 Alarm OFF  
 7 Contact OFF

### P(ID) controller

You can define various controller functions for the transmitter. On the basis of the PID controller, P, PI, PD and PID controllers can be implemented. For an optimum control system, use the controller that best suits your application.

#### ■ P controller

Used for simple linear control purposes with small system deviations. Where major changes are to be controlled, overshooting may occur. In addition, a lasting control deviation must be expected.

#### ■ PI controller

Is used for control systems where overshooting is to be avoided and no lasting control deviation should occur.

#### ■ PD controller

Is used for processes that require quick changes and where peaks must be corrected.

#### ■ PID controller

Is used for processes where a P, PI or PD controller does not control sufficiently.

### Configuration options of the P(ID) controller

The following configuration options are available for a PID controller:

- Change control gain  $K_p$  (P influence)
- Set integral action time  $T_n$  (I influence)
- Set derivative action time  $T_v$  (D influence)

### Basic load dosing (basic)

You can set a constant dosage amount (field R2311) with basic load dosing (field R231).

### PID control plus basic load dosing

If you have selected this function (PID + Basic) in field R231, the PID-controlled dosage amount does not drop below the basic load value entered in field R2311.

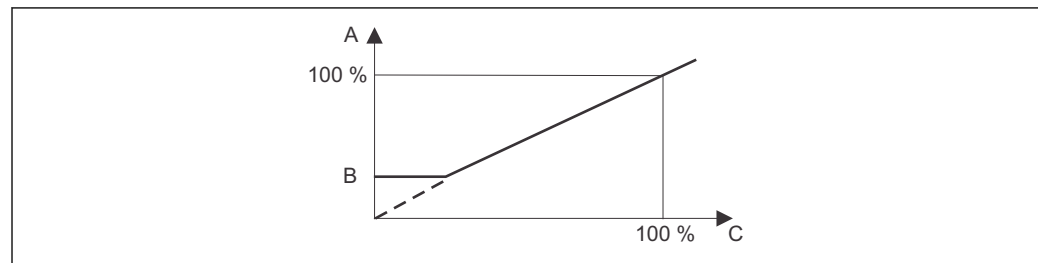

A0025221

31 Control characteristic of PID controller with basic load dosing

A PID plus basic load

B Basic load

C PID

### Commissioning

If you do not yet have any experience for setting the control parameters, set the values that yield the greatest possible stability in the control circuit. Proceed as follows to optimize the control circuit further:

- Increase the control gain  $K_p$  until the controlled variable just starts to overshoot.
- Reduce  $K_p$  slightly again and then reduce the integral action time  $T_n$  so that the shortest possible correction time without overshooting is achieved.
- To reduce the response time of the controller, also set the derivative action time  $T_v$ .

### Control and fine optimization of the set parameters with a recorder

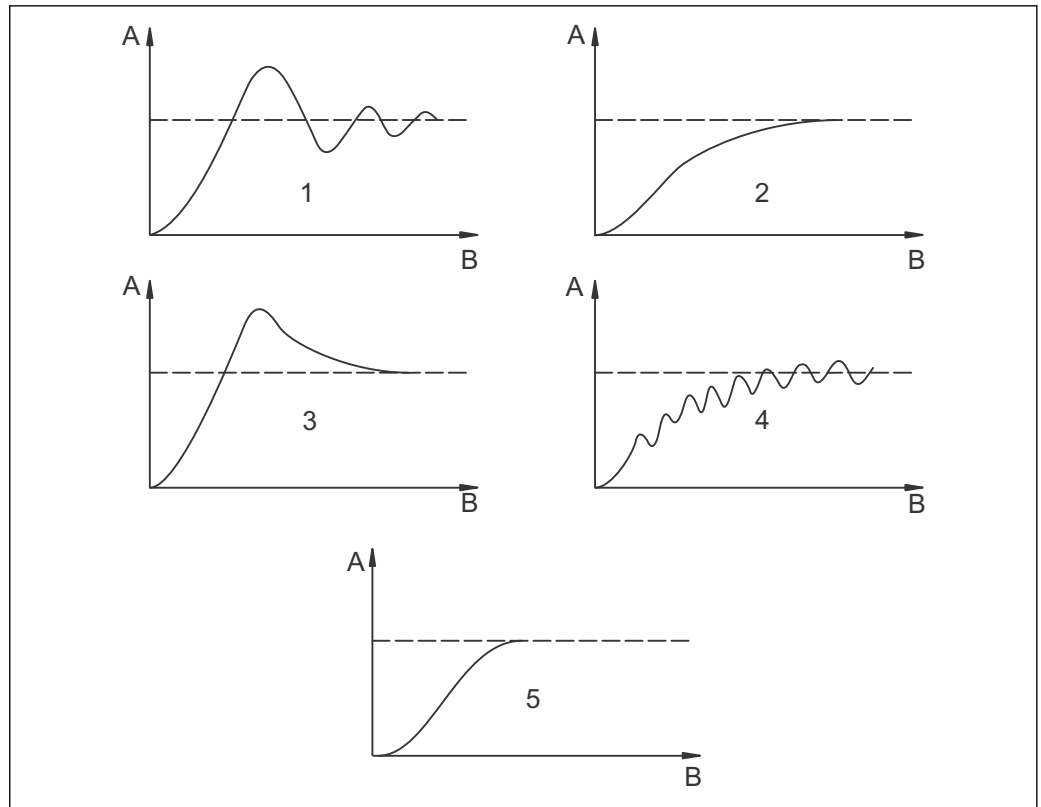

A0025218

32 Optimization of settings  $T_n$  and  $K_p$

A Actual value

B Time

1  $T_n$  too small

2  $T_n$  too large

3  $K_p$  too large

4  $K_p$  too small

5 Optimum setting

### Actuating signal outputs via contacts (R237 to R2310)

Each control contact outputs a cyclical signal whose intensity corresponds to the controller's actuating value. A distinction is made according to the type of signal cycle:

#### ■ Pulse length modulation

The bigger the calculated manipulated variable is, the longer the contact affected remains picked up. The period  $T$  can be set to be between 0.5 and 99 s (field R238). Outputs with pulse length modulation are used to activate solenoid valves.

#### ■ Pulse frequency modulation

The bigger the calculated manipulated variable is, the higher the switching frequency of the contact affected. The maximum switching frequency  $1/T$  can be set to be between 60 and  $180 \text{ min}^{-1}$  (field R239). The on-time  $t_{\text{on}}$  is constant. It depends on the set maximum frequency and is approx. 0.5 s for  $60 \text{ min}^{-1}$  and approx. 170 ms for  $180 \text{ min}^{-1}$ . 170 ms. Outputs with pulse frequency modulation are used to activate directly controlled solenoid dosing pumps.

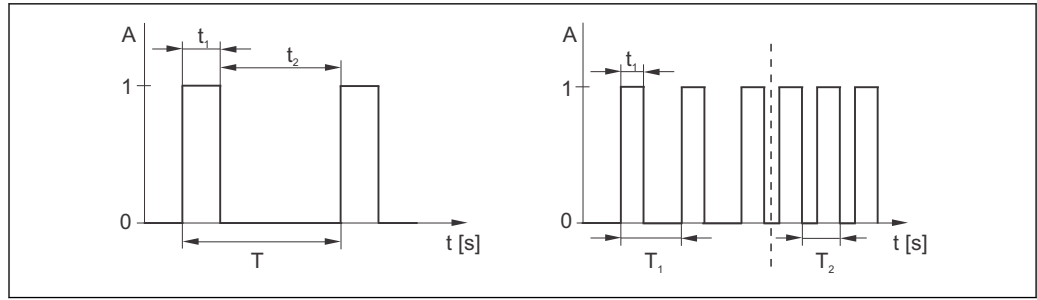

33 Signal of a pulse-length modulated controller contact (left) and of a pulse frequency-modulated controller contact (right)

Contact: 1 = on, 0 = off      T      Period  
 Time (s):  $t_1 = t_{on}$   $t_2 = t_{off}$       T1 T2      Impulse period length (  $1/T_1$  and  $1/T_2$  )

**Constant controller**

The controller can also control the second analog current output (if provided). This is configured in fields R237 and O2.

**Control characteristic for direct and inverse control action**

You can choose between two control characteristics in the R236 field:

- Direct control action = maximum function
- Inverse control action = minimum function

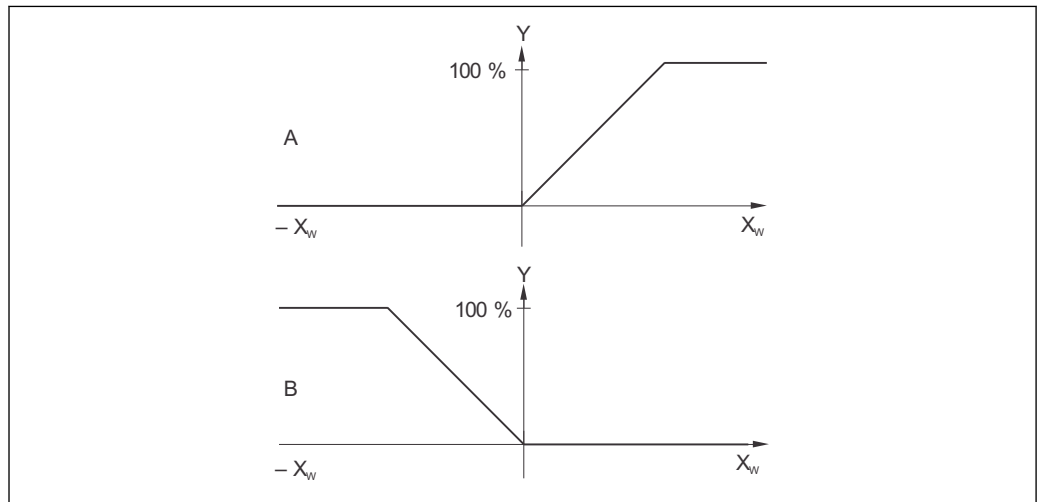

34 Control characteristic of a proportional controller with direct and inverse control action

A Direct = maximum function  
 B Inverse = minimum function  
 XW Control deviation  
 Y Current output signal = controller actuating variable

**Timer for cleaning function**

This function includes a simple cleaning option. You can set the time interval after which cleaning should start. Therefore you can only select a constant interval sequence.

Other cleaning functions are available for selection in conjunction with the Chemoclean function (device version with four contacts required, see the "Chemoclean function" section).

**i** The timer and Chemoclean do not work independently of one another. While one of the two functions is active, the other cannot be started.

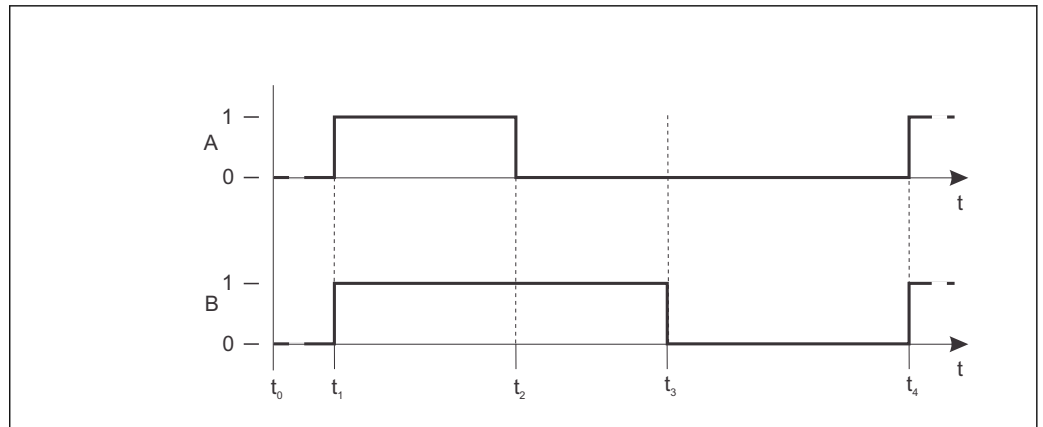

A0025223

35 Connection between cleaning time, pause time and hold dwell period

A Wiper and/or spray cleaning system

B Hold function

0 Inactive

1 active

t0 Normal operation

t1 cleaning start

t2-t1 Cleaning time

t3-t2 Clean hold dwell period (0 to 999 s)

t4-t3 Pause time between two cleaning intervals (1 to 7200 min)

### Chemoclean function

Just like the timer function, Chemoclean can also be used to start a cleaning cycle. However, Chemoclean also gives you the added option of defining various cleaning and rinsing intervals and of dosing cleaning agent.

Therefore, it is possible to clean irregularly with different repeat cycles and to separately set the cleaning times with post rinse times.

Please note the following:

- To use the Chemoclean function the transmitter has to be equipped with a designated relay board (see product structure or chapter "accessories").
- The timer and Chemoclean are mutually dependent. While one of the two functions is active, the other cannot be started.
- For the Chemoclean function, the relays 3 (water) and 4 (cleaner) are used.
- If the cleaning is prematurely aborted, a post rinse time always follows.
- If the setting is "Economy", cleaning only takes place with water.

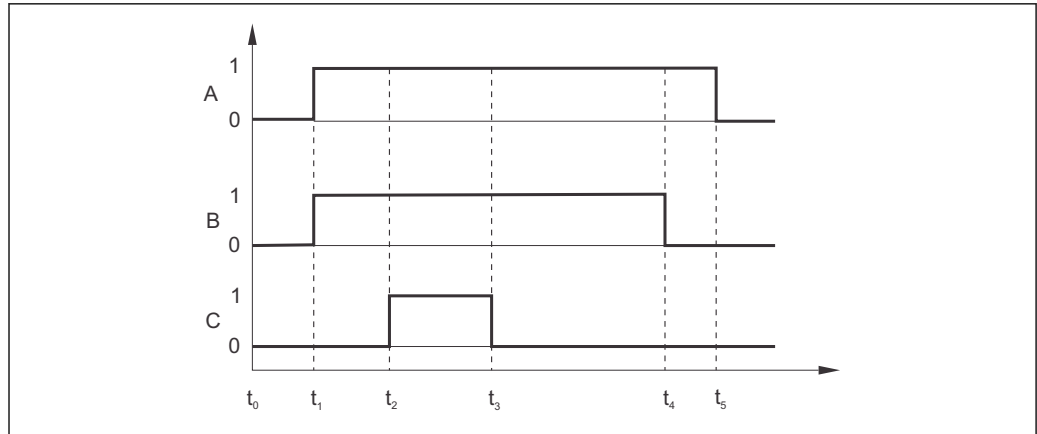

A0025216

36 Sequence of a cleaning cycle

- A Hold function
- B Water valve is triggered
- C Cleaning valve is triggered
- 0 Contact off
- 1 Contact on
- $t_0$  Normal operation
- $t_1$  cleaning start
- $t_2-t_1$  Pre-rinse time
- $t_3-t_2$  Cleaning time
- $t_4-t_3$  Post rinse time
- $t_5-t_4$  Hold dwell period

Functions marked in italics are not supported by the basic device version.

Coding	Field	Range of adjustment (factory settings in bold)	Display	Info
R	RELAY		<p>ATC RELAYS</p> <p>A0009058-EN</p>	Relay contact settings
R1	Select the contact to be configured	<b>Rel1</b> Rel2 Rel3 Rel4	<p>Rel1 <sub>R1</sub>                      Sel. Relay</p> <p>A0009059-EN</p>	Rel3 (water) and Rel4 (cleaner) are only available with the relevant version of the transmitter. If Chemoclean is used as the cleaning method, Rel4 is not available.
R2 (1)	Configure limit contactor for O <sub>2</sub> measurement	<b>LC PV = limit contactor O<sub>2</sub> (1)</b> LC °C = limit contactor T (2) PID controller (3) Timer (4) Clean= Chemoclean (5)	<p>LC PV <sub>R2</sub>                      Sel. Type</p> <p>A0009060-EN</p>	PV = process value If Rel4 is selected in the R1 field, Clean = Chemoclean cannot be selected. By confirming with ENTER, another relay function already switched on is switched off and its settings are reset to the factory settings.

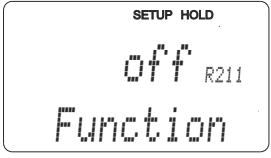
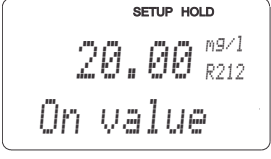
Coding	Field	Range of adjustment (factory settings in bold)	Display	Info
R211	Switch function of R2 (1) off or on	<b>Off</b> On	 <p style="text-align: right; font-size: small;">A0009067-EN</p>	All the settings are retained.
R212	Enter the switch-on point of the contact	<ul style="list-style-type: none"> <li>▪ DX/DS version or WX/WS version with COS61:  <b>20.00 mg/l</b>                          0.00 to 20.00 mg/l  <b>200.0 %SAT</b>                          0.0 to 200.0 %SAT  <b>400 hPa</b>                          0 to 400 hPa (0 to 6 psi)</li> <li>▪ WX/WS with COS31:                          WX/WS with COS31:  <b>20.00 mg/l</b>                          0.00 to 60.00 mg/l  <b>200.0 %SAT</b>                          0.0 to 600.0 %SAT  <b>400 hPa</b>                          0 to 1200 hPa (0 to 6 psi)</li> <li>▪ WX/WS with COS71:  <b>20.000 mg/l</b>                          0.00 to 20.000 mg/l  <b>200.0 %SAT</b>                          0.0 to 200.0 %SAT  <b>400 hPa</b>                          0 to 400 hPa (0 to 6 psi)</li> </ul>	 <p style="text-align: right; font-size: small;">A0025392-EN</p>	Never set the switch-on point and the switch-off point to the same value! (Only the operating mode selected in A1 is displayed.)

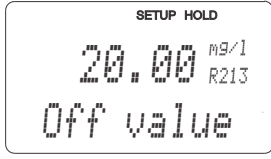
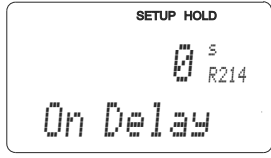
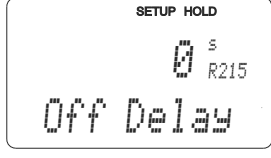
Coding	Field	Range of adjustment (factory settings in bold)	Display	Info
R213	Enter the switch-off point of the contact	<ul style="list-style-type: none"> <li>▪ DX/DS version or WX/WS version with COS61:  <b>20.00 mg/l</b>            0.00 to 20.00 mg/l  <b>200.0 %SAT</b>            0.0 to 200.0 %SAT  <b>400 hPa</b>            0 to 400 hPa (0 to 6 psi)</li> <li>▪ WX/WS with COS31:            WX/WS with COS31:  <b>20.00 mg/l</b>            0.00 to 60.00 mg/l  <b>200.0 %SAT</b>            0.0 to 600.0 %SAT  <b>400 hPa</b>            0 to 1200 hPa (0 to 6 psi)</li> <li>▪ WX/WS with COS71:  <b>20.000 mg/l</b>            0.00 to 20.000 mg/l  <b>200.0 %SAT</b>            0.0 to 200.0 %SAT  <b>400 hPa</b>            0 to 400 hPa (0 to 6 psi)</li> </ul>	 <p style="text-align: center; font-size: small;">A0025393-EN</p>	<p>Entering a switch-off point selects either a Max contact (switch-off point &lt; switch-on point) or a Min contact (switch-off point &gt; switch-on point), thereby implementing a hysteresis that is constantly required (see "Illustration of the alarm and limit functions" figure).</p> <p>(Only the operating mode selected in A1 is displayed.)</p>
R214	Enter pickup delay	<b>0 s</b> 0 to 2000 s	 <p style="text-align: center; font-size: small;">A0009070-EN</p>	
R215	Enter dropout delay	<b>0 s</b> 0 to 2000 s	 <p style="text-align: center; font-size: small;">A0009071-EN</p>	

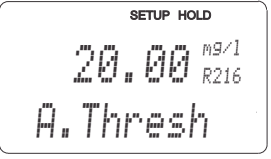
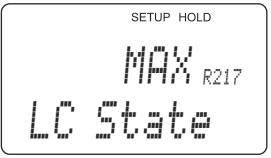
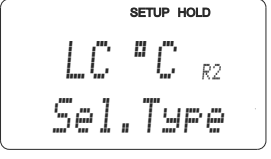
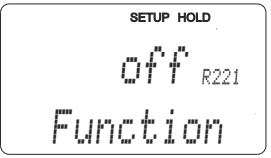
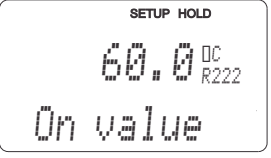

Coding	Field	Range of adjustment (factory settings in bold)	Display	Info
R216	Enter alarm threshold (as absolute value)	<ul style="list-style-type: none"> <li>DX/DS version or WX/WS version with COS61:  <b>20.00 mg/l</b>                      0.00 to 20.00 mg/l  <b>200.0 %SAT</b>                      0.0 to 200.0 %SAT  <b>400 hPa</b>                      0 to 400 hPa (0 to 6 psi)                 </li> <li>WX/WS with COS31:  <b>20.00 mg/l</b>                      0.00 to 60.00 mg/l  <b>200.0 %SAT</b>                      0.0 to 600.0 %SAT  <b>400 hPa</b>                      0 to 1200 hPa (0 to 6 psi)                 </li> <li>WX/WS with COS71:  <b>20.000 mg/l*</b>                      0.000 to 20.000 mg/l  <b>200.0 %SAT</b>                      0.0 to 200.0 %SAT  <b>400 hPa</b>                      0 to 400 hPa (0 to 6 psi)                 </li> </ul>	 <p style="text-align: right; font-size: small;">A0025394-EN</p>	If the alarm threshold is undershot/overshot, this triggers an alarm with the error message (E067 to E070) and an error current at the transmitter (note alarm delay in field F3). If defined as a Min contact, the alarm threshold must be < switch-off point. Only the operating mode selected in A1 is displayed.
R217	Display status for limit contactor	<b>MAX</b> MIN	 <p style="text-align: right; font-size: small;">A0009073-EN</p>	Display only
R2 (2)	Configure limit contactor for temperature measurement	LC PV = limit contactor O <sub>2</sub> (1) <b>LC °C = limit contactor T (2)</b> PID controller (3) Timer (4) Clean= Chemoclean (5)	 <p style="text-align: right; font-size: small;">A0009061-EN</p>	By confirming with ENTER, another relay function already switched on is switched off and its settings are reset to the factory settings.
R221	Switch function of R2 (2) off or on	<b>Off</b> On	 <p style="text-align: right; font-size: small;">A0009074-EN</p>	
R222	Enter switch-on temperature	<b>60.0 °C</b> -10.0 to 60.0 °C	 <p style="text-align: right; font-size: small;">A0025396-EN</p>	Never set the switch-on point and the switch-off point to the same value!

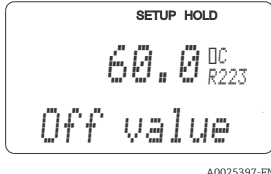
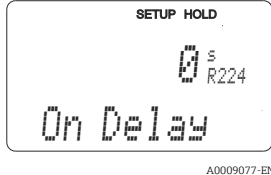
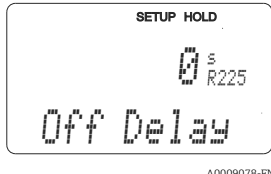
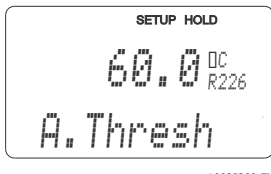
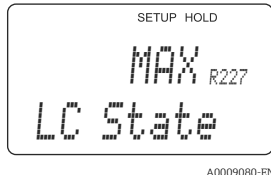
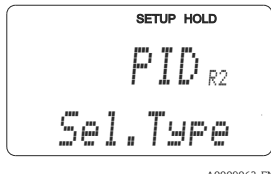
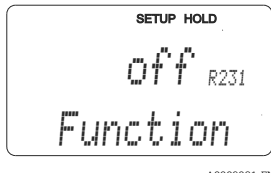
Coding	Field	Range of adjustment (factory settings in bold)	Display	Info
R223	Enter switch-off temperature	<b>60.0 °C</b> -10.0 to 60.0 °C	 <p>A0025397-EN</p>	Entering a switch-off point selects either a Max contact (switch-off point < switch-on point) or a Min contact (switch-off point > switch-on point), thereby implementing a hysteresis that is constantly required (see "Illustration of the alarm and limit functions" figure).
R224	Enter pickup delay	<b>0 s</b> 0 to 2000 s	 <p>A0009077-EN</p>	
R225	Enter dropout delay	<b>0 s</b> 0 to 2000 s	 <p>A0009078-EN</p>	
R226	Enter alarm threshold (as absolute value)	<b>60.0 °C</b> -10.0 to 60 °C	 <p>A0025399-EN</p>	If the alarm threshold is undershot/overshot, this triggers an alarm with the error message (E067 to E070) and an error current at the transmitter (note alarm delay in field F3). If defined as a Min contact, the alarm threshold must be < switch-off point.
R227	Display status for limit contactor	<b>MAX</b> MIN	 <p>A0009080-EN</p>	Display only
R2 (3)	Configure P(ID) controller	LC PV = limit contactor O <sub>2</sub> (1) LC °C = limit contactor T (2) <b>PID controller (3)</b> Timer (4) <i>Clean= Chemoclean (5)</i>	 <p>A0009062-EN</p>	By confirming with ENTER, another relay function already switched on is switched off and its settings are reset to the factory settings.
R231	Switch function of R2 (3) off or on	<b>Off</b> On Basic PID+B	 <p>A0009081-EN</p>	On = PID controller Basic = basic load dosing PID+B = PID controller + basic load dosing

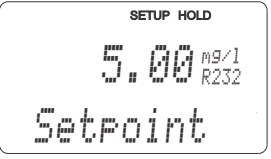
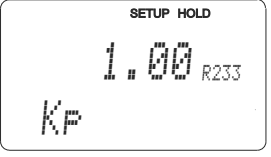
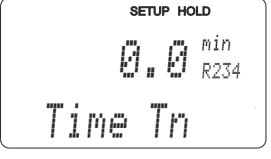
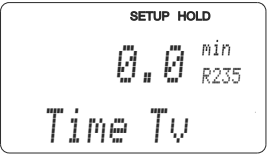
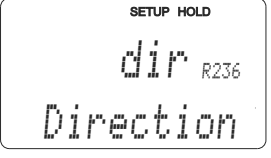
Coding	Field	Range of adjustment (factory settings in bold)	Display	Info
R232	Enter set point	<ul style="list-style-type: none"> <li>■ DX/DS version or WX/WS version with COS61: <b>5.00 mg/l</b> 0.00 to 20.00 mg/l <b>50.0 %SAT</b> 0.0 to 200.0 %SAT <b>200 hPa</b> 0 to 400 hPa (0 to 6 psi)</li> <li>■ WX/WS with COS31: <b>5.00 mg/l</b> 0.00 to 60.00 mg/l <b>50.0 %SAT</b> 0.0 to 600.0 %SAT <b>200 hPa</b> 0 to 1200 hPa (0 to 6 psi)</li> <li>■ WX/WS with COS71: <b>5.000 mg/l*</b> 0.000 to 20.000 mg/l <b>50.0 %SAT</b> 0.0 to 200.0 %SAT <b>200 hPa</b> 0 to 400 hPa (0 to 6 psi)</li> </ul>	 <p style="text-align: right; font-size: small;">A0025401-EN</p>	The set point is the value to be maintained by the control system. Using this control process, this value is restored when an upwards or downwards deviation occurs. Only the operating mode selected in A1 is displayed.
R233	Enter control gain $K_p$	<b>1.00</b> 0.01 to 20.00	 <p style="text-align: right; font-size: small;">A0009085-EN</p>	See the "P(ID) controller" section.
R234	Enter integral action time $T_n$ (0.0 = no I-component)	<b>0.0 min</b> 0.0 to 999.9 min	 <p style="text-align: right; font-size: small;">A0009086-EN</p>	See the "P(ID) controller" section. With every hold, the I-component is set to zero. Although the hold can be deactivated in field S2, this does not apply for Chemoclean and timer!
R235	Enter derivative action time $T_v$ (0.0 = no D-component)	<b>0.0 min</b> 0.0 to 999.9 min	 <p style="text-align: right; font-size: small;">A0009087-EN</p>	See the "P(ID) controller" section.
R236	Select controller characteristic	<b>Dir = direct</b> Inv = inverse	 <p style="text-align: right; font-size: small;">A0009088-EN</p>	The setting is required depending on the control deviation (upward or downward deviation, see the "P(ID) controller" section).

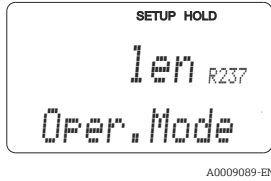
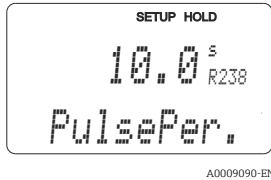
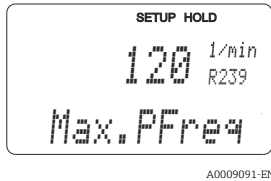
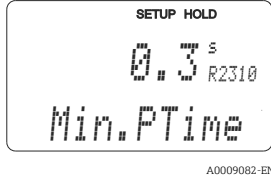
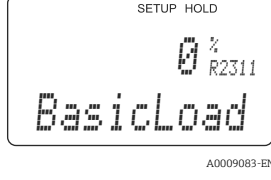
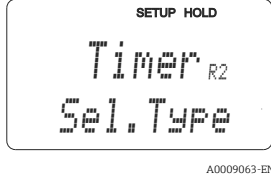
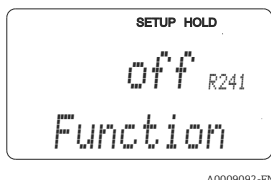
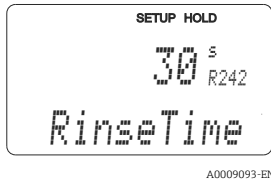

Coding	Field	Range of adjustment (factory settings in bold)	Display	Info
R237	Select pulse length or pulse frequency	Len = pulse length Freq = pulse frequency Curr = current output 2		Pulse length e.g. for solenoid valve, pulse frequency e.g. for solenoid dosing pump, see the "Actuating signal outputs" section. Curr = current output 2 can only be selected if O2 = Contr.
R238	Enter pulse interval	<b>10.0 s</b> 0.5 to 999.9 s		This field only appears if pulse length is selected in R237. If pulse frequency is selected, R238 is skipped and entries continue with R239.
R239	Enter maximum pulse frequency of the adjuster	<b>120 min<sup>-1</sup></b> 60 to 180 min <sup>-1</sup>		This field only appears if pulse frequency is selected in R237. If pulse length is selected, R239 is skipped and entries continue with R2310.
R2310	Enter minimum switch-on time $t_{ON}$	<b>0.3 s</b> 0.1 to 5.0 s		This field only appears if pulse length is selected in R237.
R2311	Enter basic load	<b>0 %</b> 0 to 40 %		When you select the basic load, you enter the desired dosing quantity. 100% basic load would correspond to: <ul style="list-style-type: none"> <li>Constantly on if R237 = len</li> <li>Fmax if R237 = freq (field R239)</li> <li>20 mA if R237 = curr</li> </ul>
R2 (4)	Configure cleaning function (timer)	LC PV = limit contactor O <sub>2</sub> (1) LC °C = limit contactor T (2) PID controller (3) <b>Timer (4)</b> Clean= Chemoclean (5)		Only one cleaning agent (generally water) is used for the cleaning. By confirming with ENTER, another relay function already switched on is switched off and its settings are reset to the factory settings.
R241	Switch function of R2 (4) off or on	<b>Off</b> On		
R242	Enter rinsing/cleaning time	<b>30 s</b> 0 to 999 s		Settings for hold and relay are active for this time.

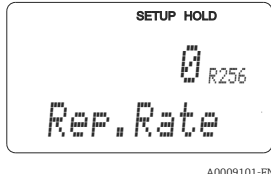
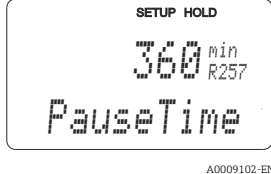
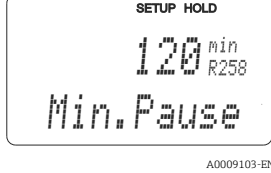
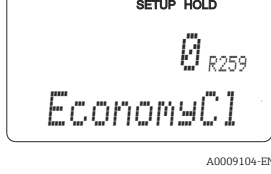
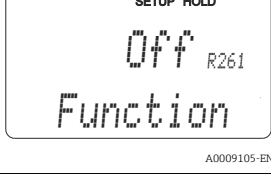
Coding	Field	Range of adjustment (factory settings in bold)	Display	Info
R243	Enter pause time	<b>360 min</b> 1 to 7200 min	<p>SETUP HOLD 360<sup>Min</sup> R243 PauseTime</p> <p>A0009094-EN</p>	The pause time is the time between two cleaning cycles (see the "Timer for cleaning function" section).
R244	Enter minimum pause time	<b>120 min</b> 1 to R243	<p>SETUP HOLD 120<sup>Min</sup> R244 Min.Pause</p> <p>A0009095-EN</p>	The minimum pause time prevents constant cleaning if a cleaning trigger is pending.
R2 (5)	Configure cleaning with Chemoclean (for version with four contacts, Chemoclean option and contacts 3 and 4 assigned)	LC PV = limit contactor O <sub>2</sub> (1) LC °C = limit contactor T (2) PID controller (3) Timer (4) <b>Clean= Chemoclean (5)</b>	<p>SETUP HOLD Clean R2 Sel.Type</p> <p>A0009064-EN</p>	See the "Chemoclean function" section. By confirming with ENTER, another relay function already switched on is switched off and its settings are reset to the factory settings.
R251	Switch function of R2 (5) off or on	<b>Off</b> On	<p>SETUP HOLD off R251 Function</p> <p>A0009096-EN</p>	
R252	Select type of start pulse	<b>Int = internal (time-controlled)</b> Ext = external (digital input 2) I+ext = internal + external I+stp = internal, suppressed by external	<p>SETUP HOLD int R252 CleanTrig</p> <p>A0009097-EN</p>	The cycle for the "int" function is started when the pause time ends (R257). No real time clock is available. External suppression is required for irregular time intervals (e.g. weekends).
R253	Enter pre-rinse time	<b>20 s</b> 0 to 999 s	<p>SETUP HOLD 20<sup>s</sup> R253 PreRinse</p> <p>A0009098-EN</p>	Rinsing is performed with water.
R254	Enter cleaning time	<b>10 s</b> 0 to 999 s	<p>SETUP HOLD 10<sup>s</sup> R254 CleanTime</p> <p>A0009099-EN</p>	Cleaning is performed with cleaning agent and water.
R255	Enter post rinse time	<b>20 s</b> 0 to 999 s	<p>SETUP HOLD 20<sup>s</sup> R255 PostRinse</p> <p>A0009100-EN</p>	Rinsing is performed with water.

Coding	Field	Range of adjustment (factory settings in bold)	Display	Info
R256	Enter number of repeat cycles	<b>0</b> 0 to 5	 A0009101-EN	R253 to R255 is repeated.
R257	Enter pause time	<b>360 min</b> 1 to 7200 min	 A0009102-EN	The pause time is the time between two cleaning cycles (see the "Chemoclean function" section).
R258	Enter minimum pause time	<b>120 min</b> 1 to R257	 A0009103-EN	The minimum pause time prevents constant cleaning if an external cleaning start is pending.
R259	Enter number of cleaning cycles without cleaning agent (economy function)	<b>0</b> 0 to 9	 A0009104-EN	After cleaning with cleaner, up to 9 cleaning sessions can be carried out with water only until the next cleaning session with cleaner takes place.
R261	Switch function of R2 (6) off or on	<b>Off</b> On	 A0009105-EN	

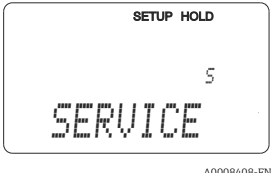
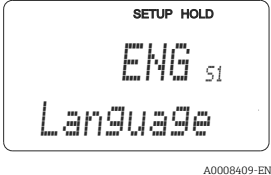
### 7.4.8 Service

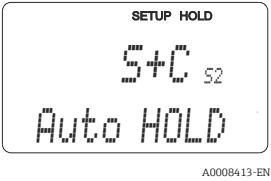
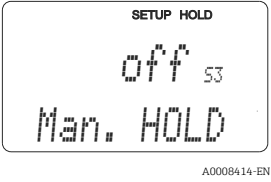
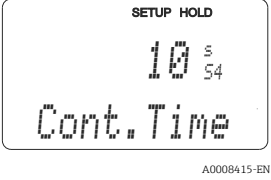
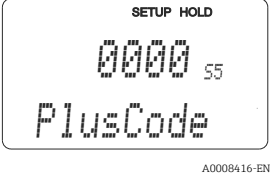
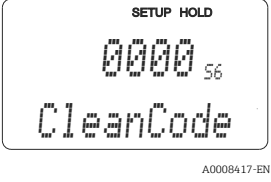
Coding	Field	Range of adjustment (factory settings in bold)	Display	Info
S	<b>SERVICE</b> function group		 A0008408-EN	Service function settings.
S1	Select language	<b>ENG = English</b> GER = German FRA = French ITA = Italian NL = Dutch ESP = Spanish	 A0008409-EN	The option selected only applies for the fault-signaling contact, not for the error current.

Coding	Field	Range of adjustment (factory settings in bold)	Display	Info
S2	Configure a hold	<b>S+C = hold during configuration and calibration</b> Cal = hold during calibration Setup = hold during configuration None = no hold	 <p>A0008413-EN</p>	S = setup C = calibration
S3	Manual hold	<b>Off</b> On	 <p>A0008414-EN</p>	The setting is retained even in the event of a power failure.
S4	Enter hold dwell period	<b>10 s</b> 0 to 999 s	 <p>A0008415-EN</p>	
S5	Enter SW upgrade release code (Plus Package)	<b>0000</b> 0000 to 9999	 <p>A0008416-EN</p>	The code can be found on the nameplate. If an incorrect code is entered, you are taken back to the measurement menu. The number is edited with the PLUS or MINUS key and confirmed with the ENTER key. "1" is displayed if the code is active.
S6	Enter SW upgrade release code for Chemoclean	<b>0000</b> 0000 to 9999	 <p>A0008417-EN</p>	The code can be found on the nameplate. If an incorrect code is entered, you are taken back to the measurement menu. The number is edited with the PLUS or MINUS key and confirmed with the ENTER key. "1" is displayed if the code is active.
S7	Order number is displayed		 <p>A0025488-EN</p>	If the device is upgraded, the order code is changed automatically.
S8	Serial number is displayed		 <p>A0008420-EN</p>	

Coding	Field	Range of adjustment (factory settings in bold)	Display	Info
S9	Reset the device to the basic settings	<b>No</b> Sens = sensor data Facy = factory settings	<p>SETUP HOLD NO S9 S. Default A0008421-EN</p>	Sens = last calibration is deleted and is reset to factory setting. Facy = all data (apart from A1 and S1) are deleted and reset to the factory setting!
S10	Perform device test	<b>No</b> Displ = display test	<p>SETUP HOLD NO S10 Test A0008410-EN</p>	
S11	Absolute air pressure is displayed	Actual value	<p>SETUP HOLD 1000 hPa S11 Pressure A0025490-EN</p>	Do not compare against the barometer. The barometer indicates the relative air pressure (in relation to sea level). The transmitter requires the absolute air pressure.



### 7.4.9 E+H Service

Coding	Field	Range of adjustment (factory settings in bold)	Display	Info
E	<b>E+H SERVICE function group</b>		<p>SETUP HOLD E E+H SERV A0007857-EN</p>	Information on the device version
E1	Select module	<b>Contr = controller (central module) (1)</b> Trans = transmitter (2) Main = power unit (3) Rel = relay module (4) Sens = sensor (5)	<p>SETUP HOLD Contr E1 Select A0007858-EN</p>	The "Sens = sensor" option is only available in WX or WS device versions.
E111 E121 E131 E141 E151	Software version is displayed		<p>SETUP HOLD XX.XX E111 SW-Vers. A0007859-EN</p>	If E1 = contr: device software If E1 = trans, main, rel: module firmware If E1 = sens: sensor software
E112 E122 E132 E142 E152	Hardware version is displayed		<p>SETUP HOLD XX.XX E112 HW-Vers. A0007861-EN</p>	Info display

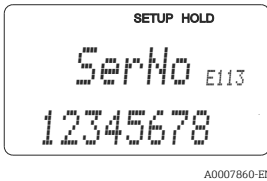
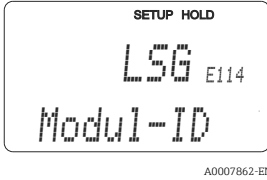

Coding	Field	Range of adjustment (factory settings in bold)	Display	Info
E113 E123 E133 E143 E153	Serial number is displayed		 <p>SETUP HOLD SerNo E113 12345678 A0007860-EN</p>	Info display
E114 E124 E134 E144 E154	Module ID is displayed		 <p>SETUP HOLD LSG E114 Modul-ID A0007862-EN</p>	Info display

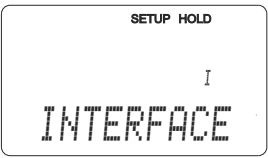
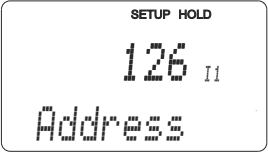
### 7.4.10 Interfaces

Coding	Field	Range of adjustment (factory settings in bold)	Display	Info
I	<b>INTERFACE</b> function group		 <p>SETUP HOLD I INTERFACE A0007863-EN</p>	Communication settings (only for HART or PROFIBUS device version).
I1	Enter bus address	Address HART: <b>0</b> to 15 or PROFIBUS: 0 to <b>126</b>	 <p>SETUP HOLD 126 I1 Address A0007864-EN</p>	Each address may only be assigned once in a network. If a device address ≠ 0 is selected for a HART device, the current output is automatically set to 4 mA and the device prepares for multi-drop operation.
I2	The tag name is displayed		 <p>SETUP HOLD Tag I2 @@@@@ A0007865-EN</p>	

### 7.4.11 Communication

For devices with a communication interface, please also refer to the separate Operating Instructions BA00208C/07/EN (HART®) or BA00209C/07/DE (PROFIBUS®).

## 7.5 Calibration

Use the CAL key to access the calibration function group.



Use this function group to calibrate the measuring point. The sensor is calibrated in air or in the medium.

Please note the following:

- During initial commissioning of amperometric sensors, calibration is absolutely essential so that the measuring system can return precise measurement data.
- The optical oxygen sensor COS61 does not need to be calibrated during initial commissioning.
- If the calibration procedure is aborted by pressing the PLUS and MINUS keys at the same time (return to C113 or C124) or if the calibration is faulty, then the previous calibration data are reinstated. A calibration error is indicated by "ERR" and the sensor symbol flashes on the display.  
Repeat calibration!
- For each calibration, the device automatically switches to hold (factory setting).
- On completion of the calibration, the device returns to the measurement mode. The "hold" symbol appears on the display during the hold dwell period (field S4).

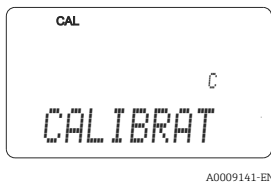
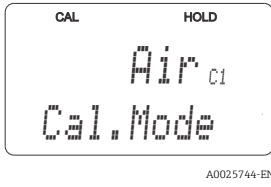
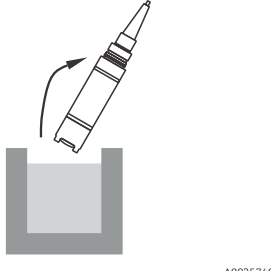
In the case of the optical oxygen sensor COS61, the slope is calibrated in air or in air-saturated water. The zero point is calibrated in nitrogen or in oxygen-free water (water containing zero solution). The sensor automatically distinguishes between calibration of the slope (75 % to 140 %SAT) and calibration of the zero point (0 to 10 %SAT). Therefore no further options need to be selected. These limits apply for all three calibration methods: "air", "water" and "ref".

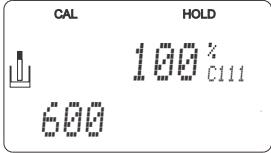
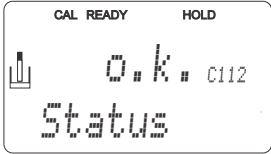
Coding	Field	Range of adjustment (factory settings in bold)	Display	Info
C	<b>CALIBRATION</b> function group:	<b>Oxygen</b> calibration		
C1(1)	Select the type of calibration	<b>Air</b> H <sub>2</sub> O Ref		Calibration in air is only possible if the air temperature is ≥ -5 °C.
Remove the sensor from the medium. Dry the membrane with a soft cloth.				

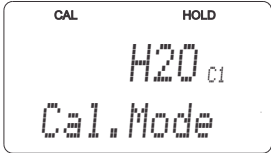
Coding	Field	Range of adjustment (factory settings in bold)	Display	Info
C111	Start calibration	<b>Last sensor slope</b> The counter on the second row counts down: 600 s → 0 s	 <p>A0025747-EN</p>	<p><b>COS31/41/71:</b> After 530 s, the sensor slope is checked for 10 s, permitted range 75 % to 140 % (with COS41 50 % to 150 %), otherwise the error E032 is displayed and the calibration is aborted.</p> <p>The stability of the signal (&lt;1%) is checked during the last 60 s of the calibration, otherwise the error E044 is displayed and calibration is aborted.</p> <p><b>COS61:</b> The calibration procedure takes between 60 s and 600 s seconds. The signal stability (&lt;1%) and the sensor slope (75 % to 140 %) are checked for 60s in each case. If the result is OK the data are transmitted. If the result is negative, the next 60 second cycle begins. Calibration is aborted after 600 seconds at the very latest. The error E032 (sensor slope) or E044 (sensor stability) is displayed.</p>
C112	Calibration status is displayed	<b>o.k.</b> E xxx	 <p>A0025748-EN</p>	If a calibration error (Exxx) is displayed, see the "System error messages" section.
If C112 = o.k., immerse the sensor in the medium again.			 <p>A0025741</p>	
C113	Store calibration result?	<b>Yes</b> No New	 <p>A0025749-EN</p>	If C112 = E xxx, then only No or <b>New</b> . If New, return to C. If Yes/No, return to "Measurement".
<b>C1(2)</b>	Calibration in air-saturated water	Air <b>H<sub>2</sub>O</b> Ref	 <p>A0025745-EN</p>	

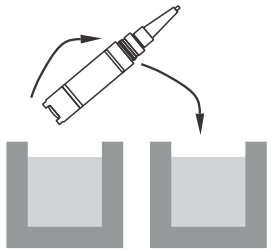
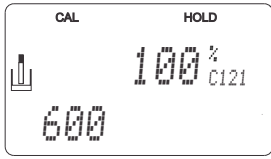
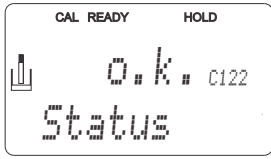
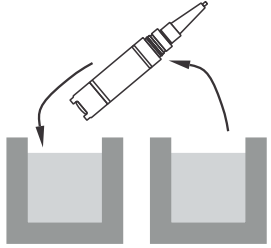
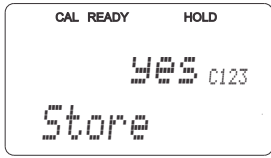
Coding	Field	Range of adjustment (factory settings in bold)	Display	Info
			 <p style="text-align: right; font-size: small;">A0025742</p>	
C121	Start calibration	<b>Last sensor slope</b> The counter on the second row counts down: 600 s → 0 s	 <p style="text-align: right; font-size: small;">A0025750-EN</p>	<p><b>COS31/41/71:</b> After 530 s, the sensor slope is checked for 10 s, permitted range 75 % to 140 % (with COS41 50 % to 150 %), otherwise the error E032 is displayed and the calibration is aborted.</p> <p>The stability of the signal (&lt;1%) is checked during the last 60 s of the calibration, otherwise the error E044 is displayed and calibration is aborted.</p> <p><b>COS61:</b> The calibration procedure takes between 60 s and 600 s seconds. The signal stability (&lt;1%) and the sensor slope (75 % to 140 %) are checked for 60s in each case. If the result is OK the data are transmitted. If the result is negative, the next 60 second cycle begins. Calibration is aborted after 600 seconds at the very latest. The error E032 (sensor slope) or E044 (sensor stability) is displayed.</p>
C122	Calibration status is displayed	<b>o.k.</b> E xxx	 <p style="text-align: right; font-size: small;">A0025751-EN</p>	If a calibration error (Exxx) is displayed, see the "System error messages" section.
			 <p style="text-align: right; font-size: small;">A0025743</p>	
C123	Store calibration result?	<b>Yes</b> No New	 <p style="text-align: right; font-size: small;">A0025752-EN</p>	If C122 = E xxx, then only No or <b>New</b> . If New, return to C. If Yes/No, return to "Measurement".

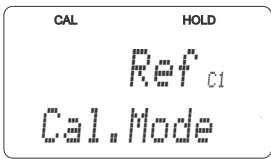
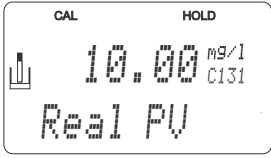
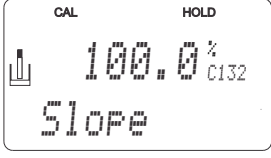
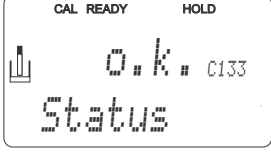
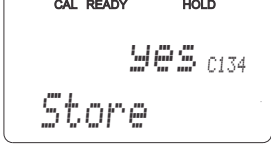
Coding	Field	Range of adjustment (factory settings in bold)	Display	Info
C1(3)	One-point calibration in the medium	Air H <sub>2</sub> O <b>Ref</b>	 <p style="text-align: right; font-size: small;">A0025746-EN</p>	<p>The calibration value must be determined via an external process, e.g.:</p> <ul style="list-style-type: none"> <li>■ Oxygen handheld instrument</li> <li>■ Winkler titration</li> </ul>
C131	Enter calibration value (= value determined externally)	<b>Current measured value</b>	 <p style="text-align: right; font-size: small;">A0025753-EN</p>	<p>The minimum value must be 0.2 mg/l. The display value should be stable when measuring and entering the calibration value.</p>
C132	Slope is displayed	<b>100.0 %</b> 75.0 to 140 %	 <p style="text-align: right; font-size: small;">A0025754-EN</p>	
C133	Calibration status is displayed	<b>o.k.</b> E xxx	 <p style="text-align: right; font-size: small;">A0025755-EN</p>	<p>If a calibration error (Exxx) is displayed, see the "System error messages" section.</p>
C134	Store calibration result?	<b>Yes</b> No New	 <p style="text-align: right; font-size: small;">A0025756-EN</p>	<p>If C133 = E xxx, then only No or <b>New</b>. If New, return to C. If Yes/No, return to "Measurement".</p>

## 8 Diagnostics and troubleshooting

### 8.1 Trouble shooting instructions

The transmitter continuously monitors its functions itself. If an error occurs which the device recognizes, this is indicated on the display. The error number is shown below the display of the main measured value. If more than one error occurs, you can call these up with the MINUS key.

Refer to the "System error messages" table for the possible error numbers and remedial measures.

Should a malfunction occur without any transmitter error message, please refer to the "Process-specific errors" or the "Device-specific errors" tables to localize and rectify the error. These tables provide you with additional information on any spare parts required.

### 8.2 System error messages

You can display and select the error messages with the MINUS key.

Error No.	Display	Tests/remedial action	Alarm contact	Error current	Autom. cleaning start	PROFIBUS Status
			Facty	Facty	Facty	PV <sup>1)</sup>
			User	User	User	Temp
E001	EEPROM memory error	<ul style="list-style-type: none"> <li>▪ Switch off device and switch it on again.</li> <li>▪ Load software compatible with hardware</li> </ul>	Yes	No	X	0C
					X	0C
E002	Device not calibrated, calibration data invalid, no user data or user data invalid (EEPROM error), device software not suitable for hardware (controller)	<ul style="list-style-type: none"> <li>▪ Load measurement-parameter specific device software.</li> <li>▪ If the error persists, send in the device for repair to your local sales center or replace the device.</li> </ul>	Yes	No	X	0C
					X	0C
E003	Download error	Invalid configuration. Repeat download.	Yes	No	No	0C
						0C
E004	Device software version not compatible with module hardware version	Load software compatible with hardware Load measurement-parameter specific device software.	Yes	No	No	0C
						0C
E007	Transmitter malfunction, device software not compatible with transmitter version		Yes	No	X	0C
					X	0C
E008	Sensor or sensor connection faulty	Check sensor and sensor connection	Yes	Yes	X	0C
					X	80
E010	Temperature sensor defective	Send sensor in for repair.	Yes	No	X	80
					X	0C
E017	Sensor electrode section defective	COS31/41/71: send sensor in for repair. COS61: replace sensor cap, calibrate sensor.	Yes	Yes	X	0C
					X	0C

Error No.	Display	Tests/remedial action	Alarm contact	Error current	Autom. cleaning start	PROFIBUS Status
			Facty	Facty	Facty	PV <sup>1)</sup>
			User	User	User	Temp
E018	Sensor membrane damaged (not sealed) or membrane cap not completely screwed on	COS31/41/71: replace membrane cap. Completely screw on membrane cap. COS61: replace sensor cap during next maintenance.	Yes	No	X	0C
					X	80
E020	Signal range of sensor undershot	Check medium and sensor.	Yes	No	X	44
					X	80
E022	Signal range of sensor exceeded	Check medium and sensor.	Yes	No	X	44
					X	80
E032	Signal during calibration outside permitted slope range 75 to 140 % (50 to 150 % for COS41)	Check sensor (see the "Maintenance of oxygen sensors" section) and recalibrate.	No	No	X	80
					X	80
E044	During calibration sensor unstable	Check sensor (see the "Maintenance of oxygen sensors" section) and recalibrate.	No	No	No	80
						80
E055	Below main parameter measuring range	Check measurement, control and connections	Yes	No	No	44
						80
E057	Main parameter measuring range exceeded		Yes	No	No	44
						80
E059	Below temperature measuring range		Yes	No	No	80
						44
E061	Temperature measuring range exceeded		Yes	No	No	80
						44
E063	Below current output range 1	Check measured value and current assignment	Yes	No	No	80
						80
E064	Current output range 1 exceeded		Yes	No	No	80
						80
E065	Below current output range 2		Yes	No	No	80
						80
E066	Current output range 2 exceeded		Yes	No	No	80
						80
E067	Set point exceeded limit contactor 1	Check configuration	Yes	No	No	80
						80
E068	Set point exceeded limit contactor 2		Yes	No	No	80
						80
E069	Set point exceeded limit contactor 3		Yes	No	No	80
						80
E070	Set point exceeded limit contactor 4		Yes	No	No	80
						80

Error No.	Display	Tests/remedial action	Alarm contact	Error current	Autom. cleaning start	PROFIBUS Status
			Facty	Facty	Facty	PV <sup>1)</sup>
			User	User	User	Temp
E080	Current output 1 range too small	Increase range in "Current outputs" menu.	Yes	No	X	80
					X	80
E081	Current output 2 range too small		Yes	No	X	80
					X	80
E082	Air pressure range undershot (< 500 hPa)	Measurement only possible when uncompensated or with altitude data.	Yes	No	No	80
						80
E083	Air pressure range exceeded (> 1100 hPa)		Yes	No	No	80
						80
E085	Incorrect setting for error current	If the current range "0 to 20 mA" was selected in field O311, the error current may not be set to "2.4 mA".	Yes	No	No	80
						80
E100	Current simulation active		Yes	No	X	80
					X	80
E101	Service function active	Switch off service function or switch device off and then on again.	No	No	X	80
					X	80
E102	Manual mode active		No	No	X	80
					X	80
E106	Download active	Wait for download to finish.	No	No	X	80
					X	80
E116	Download error	Repeat download.	Yes	No	X	0C
					X	0C
E152	Measuring signal of main parameter delayed or frozen (AC function/alternation check)	Check, service or replace sensor and connecting cable.	Yes	No	No	44
						44
E154	Below lower alarm threshold for period exceeding alarm delay	Perform manual comparison measurement if necessary. Service sensor and recalibrate.	Yes	No	No	X
						X
E155	Above upper alarm threshold for period exceeding alarm delay		Yes	No	No	X
						X
E156	Actual value undershoots alarm threshold for longer than the set permissible maximum period		Yes	No	No	X
						X
E157	Actual value exceeds alarm threshold for longer than the set permissible maximum period		Yes	No	No	X
						X
E162	Dosage stop	Check settings in the CURRENT INPUT and CHECK function groups.	Yes	No	No	X
						X



Error No.	Display	Tests/remedial action	Alarm contact	Error current	Autom. cleaning start	PROFIBUS Status
			Facty	Facty	Facty	PV <sup>1)</sup>
			User	User	User	Temp
E171	Flow in main stream too low or zero	Restore flow.	Yes	No	No	X
						X
E172	Switch-off limit for current input exceeded	Check process variables at sending measuring device. Change range assignment if necessary.	Yes	No	No	X
						X
E173	Current input < 4 mA		Yes	No	No	X
						X
E174	Current input > 20 mA		Yes	No	No	X
						X

1) PV = process variable, primary value

### 8.3 Process-specific errors

Use the following table to localize and rectify any errors occurring.

Error	Possible cause	Tests/remedial action	Tools, spare parts
Value displayed 0.0	Wrong sensor	Check sensor type	COS41 for COM2x3-DX/DS COS31/71 for COM2x3-WX/WS
	Sensor defective	<ul style="list-style-type: none"> <li>■ Test with new sensor</li> <li>■ Device test with sensor simulation</li> <li>■ Sensor current test</li> </ul>	Sensor type according to device version For sensor simulation, see the "Simulation of oxygen measurement" section
	Sensor extension line interrupted	Check junction boxes and line	Simulation, see the "Simulation of oxygen measurement" section
	Incorrect sensor connection	Check connection	For connection, see the "Electrical connection" section
	Device input defective	Replace MKO1 module (DX/DS) Replace MKO5 module (WX/WS)	See spare parts list in the "Spare parts" section
No or slow change of readings	Sensor fouled	Clean sensor membrane.	See instructions for COSxx. Use spray cleaning for very contaminated media
	Sensor installed in dead zone	Check installation position, move sensor to area with optimum flow conditions.	
Value indicated too small/might not be possible to calibrate sensor	Membrane soiled	Clean sensor membrane	See instructions for COSxx. Use spray cleaning for very contaminated media.
	Incorrect temperature measurement	Check temperature value	Comparison measurement / thermometer
	Incorrect altitude setting	Check altitude setting	
	Incorrect air pressure measurement	Check pressure value in field S11 Sea level: approx. 1013 hPa 500 m above mean sea level: approx. 950 hPa	Only for WX/WS/DS version Caution: display value = absolute air pressure value

Error	Possible cause	Tests/remedial action	Tools, spare parts
	Electrolyte used up or contaminated	Replace electrolyte	See instructions for COSxx
	Flow too low	Check installation position, move sensor to area with optimum flow conditions.	
	Sensor type recognition (COS31/61/ 71) has not occurred	Calibrate sensor in air	See description in the "Calibration" section
	Polarization not complete	After commissioning the sensor (also after interruption in operation), wait for the polarization time to elapse	Polarization is complete when the measured value is stable, max. approx. 60 minutes
Value indicated too high/might not be possible to calibrate sensor	Incorrect altitude setting	Check altitude setting	
	Incorrect air pressure measurement	Check pressure value in field S11 Sea level: approx. 1013 hPa 500 m above mean sea level: approx. 950 hPa	Only for WX/WS/DS version Caution: display value = absolute air pressure value
	Electrolyte contaminated	Replace electrolyte	See instructions for COSxx
	Air pocket under membrane	Mount new membrane cap	For procedures and spare parts ordering see instructions for COSxx
	Anode coating worn (silver color)	Have sensor regenerated in factory	Anode is normally brownish in color
	"S" membrane on standard sensor	Install correct membrane cap	"S" membrane cap recognizable by white color (COS31). In the COS31 sensor, the S-version is recognized automatically during calibration
	Sensor type recognition (COS31/61/ 71) has not occurred	Calibrate sensor in air	See description in the "Calibration" section
Simulation with sensor is incorrect	Incorrect sensor voltage	Required sensors 6.5 to 7.5 VDC	See the "Function, simulation and testing with COS31 and COS71" section
Constant, incorrect measured value	Device in impermissible operating condition (does not respond when key pressed)	Disconnect line voltage for approx. 10 seconds	Possibly EMC problem, if this persists, check the grounding and line routing or have checked by E+H Service.
Incorrect temperature value	Incorrect sensor connection	Check connections using wiring diagram.	Wiring diagram in "Electrical connection" section
	Measuring cable defective	Check cable for interruptions/ short-circuit/shunt.	Ohmmeter or local simulation
	Temperature sensor in the sensor is defective	Measure resistance value in sensor (brown and red sensor wires), only possible with COS41	Ohmmeter/values, see the "Simulation of temperature sensor" section
Fluctuations in measured value	Interference on measuring cable	Connect cable shield as per wiring diagram	See the "Electrical connection" section
	Interference on signal output cable	Check cable routing, possibly route cable separately	Route signal output and measuring input lines separately

Error	Possible cause	Tests/remedial action	Tools, spare parts
	Irregular flow / turbulence / large air bubbles	Select more favorable installation location or calm turbulence. Possibly use large factor for measured value damping.	Measured value damping, see field A4.
Controller or timer cannot be activated	No relay module available	Install LSR1-2 or LSR1-4 module	
Controller/limit contact does not work	Controller switched off	Activate controller	See fields R2xx
	Controller in operating mode "Manual off"	Select "Auto" or "Manual on" mode	Keyboard, REL key
	Pickup delay setting too long	Switch off or shorten pickup delay time	See fields R2xx
	"Hold" function active "Hold" dwell period too long	"Auto hold" for calibration, "Hold" input activated; "Hold" active via keyboard	See fields S2 to S4
Controller/limit contact works continuously	Controller in operating mode "Manual on"	Select "Auto" or "Manual off" mode	Keyboard, REL and AUTO keys
	Dropout delay setting too long	Shorten dropout delay time	See fields R2xx
	Control loop interruption	Check measured value, current output value, actuators, chemical supply	
No current output signal	Cable disconnected or short-circuited	Disconnect cable and measure directly at device	mA meter 0–20 mA
	Output defective	See the "Device-specific errors" section	
Fixed current output signal	Current simulation active	Switch off simulation.	See field O2
	Impermissible operating state of processor system	Disconnect line voltage for approx. 10 seconds	Possibly EMC problem: if problem persists, check grounding and wire routing.
Incorrect current output signal	Incorrect current assignment	Check current assignment: 0–20 mA or 4–20 mA?	Field O211
	Total load in the current loop too high (> 500 Ω)	Disconnect output and measure directly at device	mA meter for 0–20 mA DC
	EMC (interference coupling)	Disconnect both output cables and measure directly at device	Use shielded cables, ground shields at both ends, where necessary route cable in another cable duct
Current output table is not accepted	Value interval too small	Select practical intervals	
No temperature output signal	Device does not have a second current output	Check version using nameplate, if necessary replace the LSCH-x1 module	LSCH-x2 module, see the "Spare parts" section
	Device with PROFIBUS-PA	PA device has no current output!	
Chemoclean function not available	No relay module (LSR1-x) installed or only LSR1-2 available Additional function not enabled	Install LSR1-4 module. Chemoclean is enabled using the release code supplied by the manufacturer in the Chemoclean retrofit kit. To check the version, see the nameplate	LSR1-4 module, see the "Spare parts" section

Error	Possible cause	Tests/remedial action	Tools, spare parts
Plus Package functions not available	Plus Package not enabled (enable by entering a code which depends on the serial number and which is supplied by E+H when a Plus Package is ordered)	<ul style="list-style-type: none"> <li>■ For Plus Package retrofit: code is supplied by E+H → enter this code.</li> <li>■ After replacing a defective LSCH/LSCP module: first enter device serial number manually (see nameplate), then enter the existing code number.</li> </ul>	For a detailed description, see the "Replacement of central module" section.
No HART communication	No HART central module	Verify using nameplate: HART = -xxx5xx and -xxx6xx	Upgrade to LSCH-H1 / -H2
	No or incorrect DD (device description)	For further information, see BA00208C/07/EN, "HART field communication with Liquisys CxM223/253"	
	HART interface missing		
	Current output < 4 mA		
	Load too small (must be > 230 Ω)		
	HART receiver (e.g. FXA 191) not connected via load but via power supply		
	Incorrect device address (addr. = 0 for single operation, addr. > 0 for multidrop operation)		
	Line capacitance too high		
	Interference on line		
	Several devices set to same address		Assign addresses correctly
No PROFIBUS communication	No PA/DP central module	Verify using the nameplate: PA = -xxx3xx /DP = xxx4xx	Upgrade to LSCP module, see the "Spare parts" section
	Incorrect device software version (without PROFIBUS)	For further information, see BA00209C/07/EN "PROFIBUS PA/DP - Field communication for Liquisys CxM223/253".	Information about PROFIBUS configuration is provided in Technical Information TI00260F, while detailed information about instrumentation and accessories is provided in Operating Instructions BA00198F
	With Commuwin (CW) II: CW II version and device software version incompatible		
	No or incorrect DD/DLL		
	Incorrect baud rate setting for segment coupler in DPV-1 server		
	Bus user (master) has wrong address or address assigned twice		
	Bus user (slave) has wrong address		
	Bus line not terminated		

Error	Possible cause	Tests/remedial action	Tools, spare parts
	Line problems (too long, cross-section too small, not shielded, shield not grounded, wires not twisted)		
	Bus voltage too low (Bus voltage typ. 24 V DC for non-Ex)	The voltage at the device's PA/DP connector must be at least 9 V	

## 8.4 Device-specific errors

The following table helps you during the diagnosis and points to any spare parts required.

Depending on the degree of difficulty and the measuring equipment present, diagnosis is carried out by:

- Trained operator personnel
- The user's trained electrical technicians
- Company responsible for system installation/operation
- Endress+Hauser Service

Information on the exact spare part designations and on how to install these parts can be found in the "Spare parts" section.

Error	Possible cause	Tests/remedial action	Execution, tools, spare parts
Device cannot be operated, display value 9999	Operation locked	Press CAL and MINUS keys simultaneously.	See the "Key functions" section
Display dark, no light-emitting diode active	No line voltage	Check whether line voltage is present	Electrical technician / e.g. multimeter
	Supply voltage wrong/too low	Compare actual line voltage and nameplate data	User (data for energy supply company or multimeter)
	Connection faulty	<ul style="list-style-type: none"> <li>■ Terminal not tightened</li> <li>■ Insulation jammed</li> <li>■ Wrong terminals used</li> </ul>	Electrical technician
	Device fuse defective	Compare line voltage and the nameplate data and replace fuse	Electrical technician/suitable fuse; see exploded drawing in the "Spare parts" section
	Power unit defective	Replace power unit, note version	Onsite diagnosis by Endress+Hauser Service, test module necessary
	Central module defective	Replace central module, note version	Onsite diagnosis by Endress+Hauser Service, test module necessary
	Field device: ribbon cable loose or defective	Check ribbon cable, replace if necessary	See the "Spare parts" section
Display dark, light-emitting diode active	Central module defective (module: LSCH/LSCP)	Replace central module, note version	Onsite diagnosis by Endress+Hauser Service, test module necessary
Values appear on display but: <ul style="list-style-type: none"> <li>■ Display does not change and / or</li> <li>■ Device cannot be operated</li> </ul>	Device or module in device not correctly mounted	Panel-mounted device: reinstall insert. Field device: remount display module	Perform with the aid of the installation drawings in the "Spare parts" section
	Impermissible operating system condition	Disconnect line voltage for approx. 10 seconds	Possibly Possible EMC problem: if this persists, check the installation or have checked by Endress+Hauser Service

Error	Possible cause	Tests/remedial action	Execution, tools, spare parts
Device gets hot	Voltage wrong/too high	Compare line voltage and nameplate data	User, electrical technician
	Power unit defective	Replace power unit	Diagnosis only by Endress+Hauser Service
O <sub>2</sub> measured value and/or temperature measured value incorrect	Transmitter module defective (module: MKO1/MKO 5), please first carry out tests and take measures as per the "Process-specific errors" section and by doing so make sure that the sensor or cabling is not the cause of the error	<ul style="list-style-type: none"> <li>■ Test the MKO1 measuring inputs: connect equivalent resistors for oxygen and temperature, see the "DX/DS oxygen measuring device" section</li> <li>■ Test the MKO5 measuring inputs: see the "WX/WS oxygen measuring device" section</li> </ul>	If the test is negative: replace module (note version). Perform with the aid of the exploded drawings in the "Spare parts" section. It is only possible to test the MKO5 measuring inputs with an intact sensor due to the digital data transmission between the sensor and device. If the test is positive, check peripheral equipment again.
Current output, incorrect current value	Incorrect adjustment	Check with integrated current simulation, connect mA meter directly to current output.	If simulation value incorrect: adjustment in factory or new LSCH module required. If simulation value correct: check current loop for load and shunts.
	Load too large		
	Shunt / short to ground in current loop		
	Incorrect mode of operation	Check whether 0–20 mA or 4–20 mA is selected.	
No current output signal	Current output stage defective (only for LSCH module; LSCP has no current output)	Check with integrated current simulation, connect mA meter directly to current output	If test negative: Replace central module (note version)
Additional relays not working	Field device: ribbon cable loose or defective	Check ribbon cable seating, replace cable if required.	See the "Spare parts" section
Only 2 additional relays can be triggered	LSR1-2 relay module with 2 relays is installed	Upgrade to LSR1-4 with 4 relays.	User or Endress+Hauser Service
Additional functions (Plus Package) missing	No or incorrect release code used	If retrofitting: check whether the correct serial number was quoted when ordering the Plus Package.	Handled by Endress+Hauser Sales
	Incorrect device serial number saved in LSCH/LSCP module	Check whether serial number on the nameplate matches SNR in LSCH/ LSCP (field S 8).	The serial number of the device is definitive for the Plus Package.
	Modified product strategy	Since entry -WX/WS: <ul style="list-style-type: none"> <li>■ WX/WS/DS is always with a pressure sensor.</li> <li>■ DX is always without a pressure sensor.</li> </ul>	For DX: use the altitude setting.
Additional functions (Plus Package and/or Chemoclean) missing after LSCH/LSCP module replacement	Replacement modules LSCH or LSCP have the device serial number 0000 when they leave the factory. The Plus Package or Chemoclean are not enabled on leaving the factory.	In the case of LSCH/LSCP with SNR 0000, a device serial number can be entered once in fields E115 to E117. Then enter the release codes for the Plus Package and/or Chemoclean if necessary.	For a detailed description, see the "Replacement of central module" section.
No HART or PROFIBUS PA/DP interface function	Incorrect central module	HART: LSCH-H1 or H2 module, PROFIBUS-PA: LSCP-PA module, PROFIBUS-DP: LSCP-DP module, see field E112.	Replace central module; User or Endress+Hauser Service.

Error	Possible cause	Tests/remedial action	Execution, tools, spare parts
	Wrong software	SW version, see field E111.	
	Bus problem	Remove some devices and repeat the test.	Contact Endress+Hauser Service.

## 9 Maintenance

### **⚠ WARNING**

#### **Process pressure and temperature, contamination, electrical voltage**

Risk of serious or fatal injury

- ▶ If the sensor has to be removed during maintenance work, avoid hazards posed by pressure, temperature and contamination.
- ▶ Make sure the device is de-energized before you open it.
- ▶ Power can be supplied to switching contacts from separate circuits. De-energize these circuits before working on the terminals.

Take all the necessary precautions in time to ensure the operational safety and reliability of the entire measuring point.

The maintenance of the measuring point comprises:

- Calibration
- Cleaning the controller, assembly and sensor
- Checking the cables and connections

When performing any work on the device, bear in mind any potential impact this may have on the process control system or on the process itself.

### **NOTICE**

#### **Electrostatic discharge (ESD)**

Risk of damaging the electronic components

- ▶ Take personal protective measures to avoid ESD, such as discharging beforehand at PE or permanent grounding with a wrist strap.
- ▶ For your own safety, only use genuine spare parts. With genuine parts, the function, accuracy and reliability are also ensured after maintenance work.

## 9.1 Maintenance of the entire measuring point

### 9.1.1 Cleaning the transmitter

Clean the front of the housing using commercially available cleaning agents only.

The front of the housing is resistant to the following in accordance with DIN 42 115:

- Ethanol (for a short time)
- Diluted acids (max. 2% HCl)
- Diluted alkaline solutions (max. 3% NaOH)
- Soap-based household cleaning agents

When performing any work on the device, bear in mind any potential impact this may have on the process control system or on the process itself.

**NOTICE****Prohibited cleaning agents**

Damage to the housing surface or housing seal

- ▶ Never use concentrated mineral acids or alkaline solutions for cleaning.
- ▶ Never use organic cleaners such as benzyl alcohol, methanol, methylene chloride, xylene or concentrated glycerol cleaner.
- ▶ Never use high-pressure steam for cleaning purposes.



### 9.1.2 Checking version 1 (DX/DS with COS41)

#### Simulation of oxygen measurement

The DX/DS device versions work with the COS41 sensor, i.e. with amperometric sensors without a preamplifier.

To perform a functional test of the device, the COS41 sensor can be simulated by resistors. As the display value depends heavily on the sensor slope setting and on the temperature, the following values should be considered as reference values:

Simulation resistance	Value display
$\infty$ (open)	0 mg O <sub>2</sub> /l
1.9 M $\Omega$	7 to 13 mg O <sub>2</sub> /l
With 1.9 M $\Omega$ and temperature equivalent resistor of 37.3 k $\Omega$ after calibration	9.0 to 9.2 mg O <sub>2</sub> /l
4.06 M $\Omega$	3 to 6 mg O <sub>2</sub> /l

#### Simulation of the temperature sensor

In the COS41 sensor, the temperature is measured by an NTC sensor 30.0 k $\Omega$ /25 °C.

Use the following equivalent resistors to test the temperature measurement:

Simulation resistance	Value display
95.0 k $\Omega$	0.0 °C
58.7 k $\Omega$	10.0 °C
37.3 k $\Omega$	20.0 °C
30.0 k $\Omega$	25.0 °C
24.3 k $\Omega$	30.0 °C

#### Test procedure

1. Connect the O<sub>2</sub> equivalent resistor (e.g. decade resistor) to terminals 90 and 91.
2. Connect the temperature equivalent resistor (e.g. decade resistor) to terminals 11 and 12.
3. Air pressure measurement: The measured air pressure can be checked in field S11 (note: absolute pressure).

There is no air pressure compensation for DX versions. Use the altitude setting to compensate for the influence of the air pressure.

### 9.1.3 Checking version 2 (WX/WS with COS31 or COS71)

#### Function, simulation and testing with COS31 and COS71

The WX/WS device versions work primarily with the COS31, COS31-S and COS71 sensors. These sensors have digital data transfer functionality with the RS485 interface. The COS31 or COS31-S sensors are recognized automatically during calibration. All the sensor data are sent to the transmitter by data exchange. Following a power failure, the data are resent to the transmitter. The sensors require power supply of 6.5 to 8.5 VDC from the transmitter.

Due to the digital data transmission, simulation of the sensor signals is not possible.

Test possibilities in digital mode:

- Measure supply voltage (6.5 to 8.5 VDC, see wiring diagram)
- Connect intact COS31, COS31-S or COS71 sensor
- Check the O<sub>2</sub> measured value and temperature value at the transmitter
- The O<sub>2</sub> input can be tested by measuring the analog sensor output signal.
  - Terminal 0 is the reference point, terminal 18 is the O<sub>2</sub> input:
    - 0mV = 0.0mg O<sub>2</sub>/l
    - -750 mV = O<sub>2</sub> saturation = 8.1 mg O<sub>2</sub>/l (at 25 °C). The display value depends on the last calibration
- Measure sensor current consumption (max. ± 5 mA)
- Sensor data can be read off in the fields "E+H-Service" E151 to 159.
- During operation, the sensor current can be displayed in nA by pressing the PLUS key.
  - Reference values:
    - COS31: approx. 40 nA corresponds to 1 mg O<sub>2</sub>/l at 25 °C
    - COS31-S: approx. 120 nA corresponds to 1 mg O<sub>2</sub>/l at 25 °C
    - COS61: approx. 1300 nA corresponds to 8 mg O<sub>2</sub>/l at 25 °C
    - COS71: approx. 800 nA corresponds to 1 mg O<sub>2</sub>/l at 25 °C

#### 9.1.4 Maintenance of oxygen sensors

Please refer to the Operating Instructions for your sensor for sensor maintenance and troubleshooting:

CCS120	BA00388C/07/EN
CCS140/141	BA00058C/07/EN
CCS240/241	BA00114C/07/EN
963	BA00039C/07/EN

The Operating Instructions contain detailed information including:

- Sensor design and function
- Mounting and installation
- Electrical connection
- Commissioning and calibration
- Calculation examples and tables for verification of measured values
- Maintenance, regeneration, cleaning
- Troubleshooting table
- Accessories and spare parts
- Technical data and ordering information

#### 9.1.5 Assembly

Refer to the assembly operating manual for information on servicing and troubleshooting the assembly. The assembly operating manual describes the procedure for mounting and disassembling the assembly, replacing the sensors and seals, and contains information on the material resistance properties, as well as on spare parts and accessories.

#### 9.1.6 Connecting cables and junction boxes

As COS41 works with low measuring currents, shunts in connecting cables and junction boxes may cause considerable inaccuracy.

Make sure that:

- Seals on covers and cable glands are intact
- Inner compartment is dry and clean (if necessary dry, clean and insert a dehydrating bag)
- Lines, ferrules, terminals and connectors are free of corrosion

- Terminal screws are tightened firmly
- Cables enter junction boxes and devices from below
- Cables loop downwards in the case of lateral cable entries to allow water to drip off

 If the function test described in the previous section is performed on the junction box instead of on the device, the junction box, terminals and connecting line to the device are automatically included in the test.

COS31, COS61 and COS71 sensors work with a digital interface and therefore are not sensitive to electrical faults and shunting caused by moisture. Nevertheless, follow the recommendations above.

## 10 Repair

### 10.1 Spare parts

Please order spare parts from your local Sales Office. For this purpose, use the order numbers listed in the "Spare part kits" section.

For safety, you should always provide the following additional data when ordering spare parts:

- Device order code
- Serial number
- Software version, if possible

You can take the order code and serial number from the nameplate.

The software version is provided in the device software provided that the device processor system is still working.

For more detailed information on spare parts kits, please refer to the "Spare Part Finding Tool" on the Internet:

[www.endress.com/spareparts\\_consumables](http://www.endress.com/spareparts_consumables)

### 10.2 Disassembling the panel-mounted device



Please note the effects on the process if the device is taken out of service!

See the exploded drawing for the item numbers.

1. Disconnect the terminal block (item 424 b) from the rear of the device to de-energize the device.
2. Then disconnect the terminal blocks (item 422 a and 430 where applicable) from the rear of the device. Now you can disassemble the device.
3. Press in the latches of the end frame (item 340) and remove the frame from the rear.
4. Release the special screw (item 400) by turning it counter-clockwise.
5. Remove the entire electronics block from the housing. The modules are only mechanically connected and can be easily separated:
6. Simply remove the processor/display module towards the front.
7. Pull out the brackets of the rear plate (item 320) slightly.
8. Now you can remove the side modules.
9. Remove the O2 transmitter (item 250/260) as follows:
10. Using a fine wire cutter, nip off the heads of the synthetic distance holders.
11. Then remove the module from above.

Assembly is the reverse of the disassembly sequence. Tighten the special screw finger-tight without using a tool.

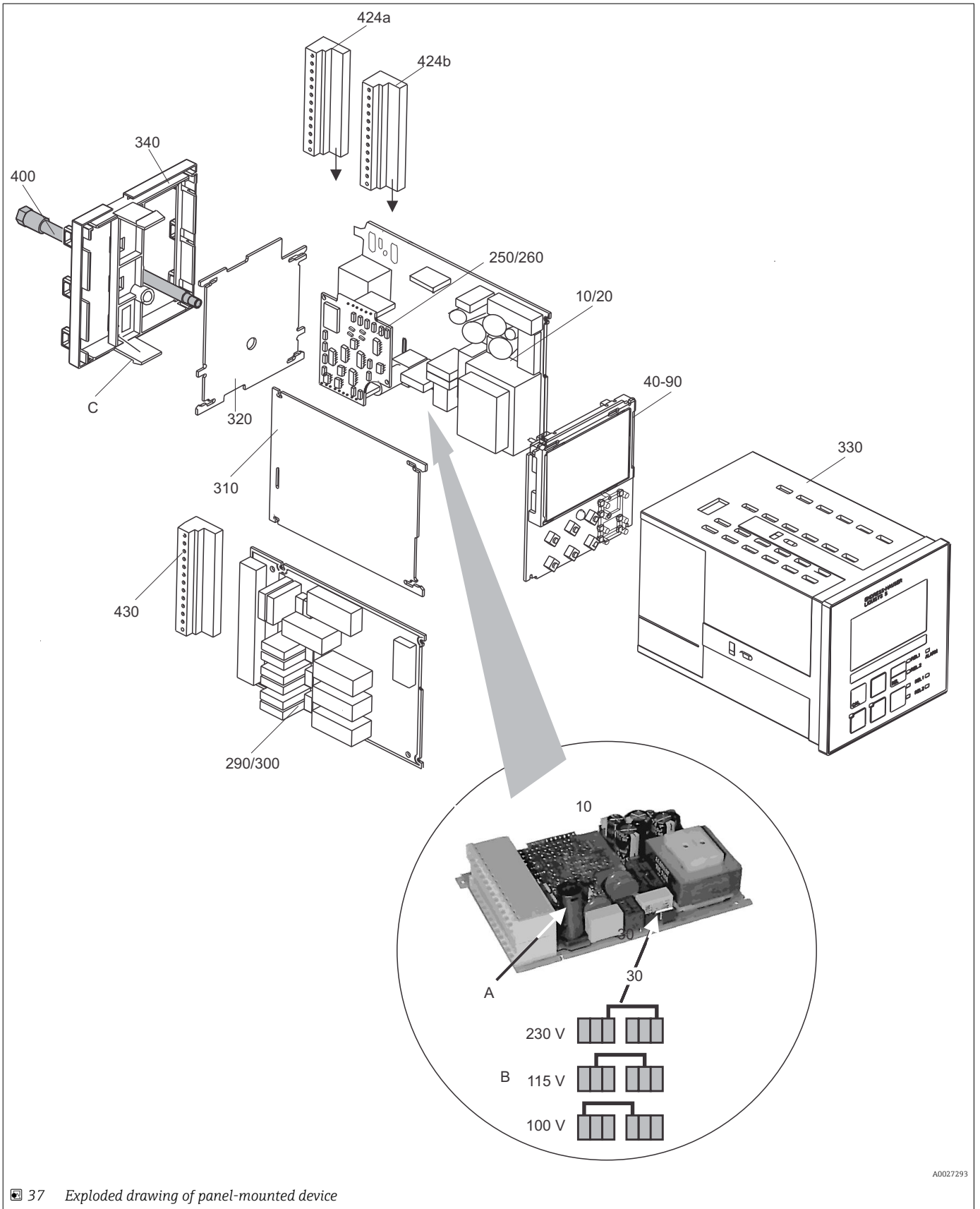

37 Exploded drawing of panel-mounted device

A0027293

The exploded drawing contains the components and spare parts of the panel-mounted device. You can take the spare parts and the corresponding order number from the following section using the item numbers.

Item	Kit description	Name	Function/contents	Order no.
10	Power unit	LSGA	100/115/230 V AC	51500317
20	Power unit	LSGD	24 V AC + DC	51500318
30	Jumper		Part of power unit, item 10	
40	Central module	LSCH-S1	1 current output	51501225
50	Central module	LSCH-S2	2 current outputs	51501222
60	Central module	LSCH-H1	1 current output + HART	51501223
70	Central module	LSCH-H2	2 current outputs + HART	51501226
80	Central module	LSCP	PROFIBUS PA/no current output	51501227
90	Central module	LSCP-DP	PROFIBUS DP/no current output	51502500
90	Kit for COM2x3 central module PROFIBUS DP	LSCP	PROFIBUS DP central module Relay module + 2 relays Current input + DP terminals Hardware version 2.10 and higher	71134729
250	O <sub>2</sub> transmitter	MKO1 (-DX/DS)	O <sub>2</sub> + temperature O <sub>2</sub> + temperature + air pressure	51501207 51501208
260	O <sub>2</sub> transmitter	MKO5(- WX/ WS)	O <sub>2</sub> + temperature + air pressure	51506938
290	Relay module	LSR1-2	2 relays	51500320
290	Relay module	LSR2-2i	2 relays + 4-20 mA current input	51504304
290	Kit for Cxm2x3 relay module PROFIBUS DP	LSR2-DP	Relay module + 2 relays Curr. input + DP terminals Hardware version 2.10 and higher	71134732
300	Relay module	LSR1-4	4 relays	51500321
300	Relay module	LSR2-4i	4 relays + 4-20 mA current input	51504305
310	Side panel		Kit with 10 parts	51502124
310, 320, 340, 400	Housing mechanical parts		Rear plate, side panel, end frame, special screw	51501076
330, 400	Housing module		Housing with front membrane, sensory tappets, seal, special screw, tensioning dogs, connection plates and nameplates	51501075
340	End frame		Rear frame for PROFIBUS DP	51502513
424a, 424b	Complete terminal strip set Standard + HART / DX + DS		Terminal strip set, inputs/outputs, power supply, alarm relay	51501204
424a, 424b	Complete terminal strip set PROFIBUS-PA / DX + DS		Terminal strip set, inputs/outputs, power supply, alarm relay	51502127
424a, 424b	Complete terminal strip set PROFIBUS-DP / DX + DS		Terminal strip set, inputs/outputs, power supply, alarm relay	51502492
430	Terminal strip		Terminal strip for relay modules	51501078
A	Fuse		Part of power unit, item 10	
B	Choice of line voltage		Position of jumper on power unit, item 10 depending on line voltage	
C	End frame latches		Part of the end frame	

## 10.3 Disassembling the field device

 Please note the effects on the process if the device is taken out of service!

See the exploded drawing for the item numbers.

You require the following tools to disassemble the field device:

- Standard set of screwdrivers
- Torx screwdriver, size TX 20

Proceed as follows to disassemble the field device:

1. Open and remove the cover of the connection compartment (item 420).
2. Disconnect the supply terminal (item 470) to de-energize the device.
3. Open the display cover (item 410) and release the ribbon cables (item 310/320) on the central module side (item 40 to 90).
4. To remove the central module (item 40) release the screw in the display cover (item 450 b).
5. Proceed as follows to remove the electronics box (item 330):
6. Turn the screws in the housing base (item 450 a) by two revolutions to release them.
7. Then push the entire box backwards and remove it from above while making sure that the module locks do not open.
8. Release the ribbon cables (item 310/320).
9. Bend the module locks out and remove the modules.
10. To remove the docking module (item 340) remove the screws in the housing base (item 450 c) and remove the entire assembly from above.
11. To remove the O2 transmitter (item 250/260) nip off the heads of the synthetic distance sleeves using a fine wire cutter.
12. Then remove the module from above.

To assemble, carefully push the modules into the guide rails of the electronics box and let them engage in the side box noses.

 It is not possible to mount the modules incorrectly. Modules inserted in the electronics box incorrectly are not operable since the ribbon cables cannot be connected.

Make sure the cover seals are intact to guarantee IP 65 ingress protection.

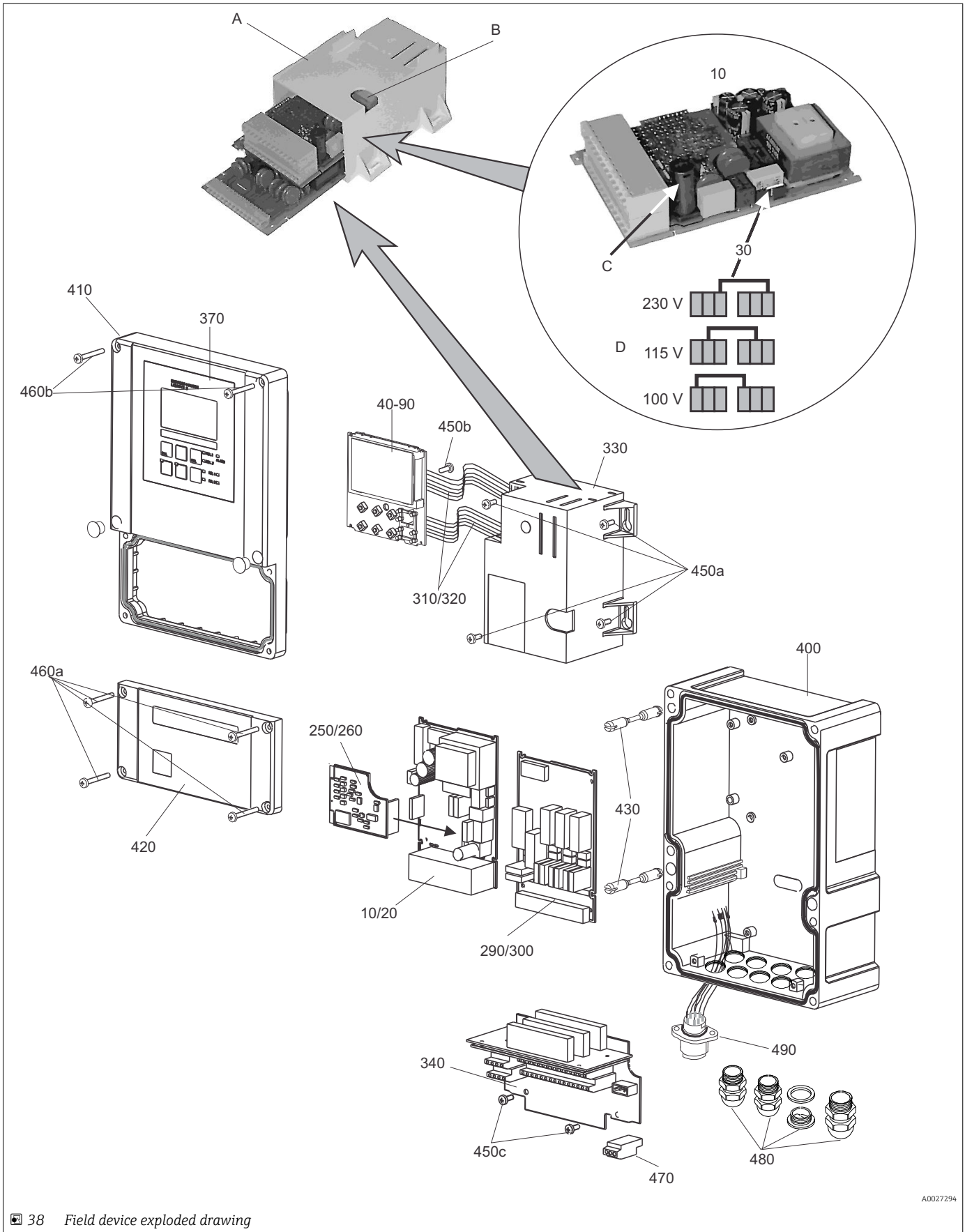



The exploded drawing contains the components and spare parts of the field device. You can take the spare parts and the corresponding order number from the following section using the item numbers.

Item	Kit description	Name	Function/contents	Order no.
10	Power unit	LSGA	100/115/230 V AC	51500317
20	Power unit	LSGD	24 V AC + DC	51500318
30	Jumper		Part of power unit, item 10	
40	Central module	LSCH-S1	1 current output	51501225
50	Central module	LSCH-S2	2 current outputs	51501222
60	Central module	LSCH-H1	1 current output + HART	51501223
70	Central module	LSCH-H2	2 current outputs + HART	51501226
80	Central module	LSCP	PROFIBUS PA/no current output	51501227
90	Central module	LSCP-DP	PROFIBUS DP/no current output	51502500
90	Kit for COM2x3 central module PROFIBUS DP	LSCP	PROFIBUS DP central module Relay module + 2 relays Current input + DP terminals Hardware version 2.10 and higher	71134729
250	O <sub>2</sub> transmitter	MK01 (-DX/DS)	O <sub>2</sub> + temperature O <sub>2</sub> + temperature + air pressure	51501207 51501208
260	O <sub>2</sub> transmitter	MK05(- WX/ WS)	O <sub>2</sub> + temperature + air pressure	51506938
290	Relay module	LSR1-2	2 relays	51500320
290	Relay module	LSR2-2i	2 relays + 4-20 mA current input	51504304
290	Kit for Cxm2x3 relay module PROFIBUS DP	LSR2-DP	Relay module + 2 relays Curr. input + DP terminals Hardware version 2.10 and higher	71134732
300	Relay module	LSR1-4	4 relays	51500321
300	Relay module	LSR2-4i	4 relays + 4-20 mA current input	51504305
310, 320	Ribbon cable lines		2 ribbon cable lines	51501074
330, 340, 450	Inner housing fittings		Docking module, empty electronics box, small parts	51501073
450a, 450c	Torx screws K4x10		Part of inner housing fittings	
450b	Torx screw for central module		Part of inner housing fittings	
370, 410, 420, 430, 460	Housing cover		Display cover, connection compartment cover, front membrane, hinges, cover screws, small parts	51501068
460a, 460b	Cover screws		Part of housing cover	
430	Hinges		2 pairs of hinges	51501069
440, 480	Housing base		Base, threaded joints	51501072
470	Terminal strip		Terminal strip for connection to power supply	51501079
490	SXB sensor socket		Sensor connection	51506966
A	Electronics box with relay module LSR1-x (bottom) and power unit LSGA/LSGD (top)			
B	Fuse also accessible if electronics box installed			

Item	Kit description	Name	Function/contents	Order no.
C	Fuse		Part of power unit, item 10	
D	Choice of line voltage		Position of jumper on power unit, item 10 depending on line voltage	

## 10.4 Replacing the central module

 Generally, when a central module has been replaced, all data which can be changed are set to the factory setting.

If possible, note the customized settings of the device, such as:

- Calibration data
- Current assignment, main parameter and temperature
- Relay function selections
- Limit value/controller settings
- Cleaning settings
- Monitoring functions
- Interface parameters

Proceed as described below if a central module is replaced:

1. Disassemble the device as explained in the "Dismantling the panel-mounted instrument" or "Dismantling the field instrument" section.
2. Use the part number on the central module to check whether the new module has the same part number as the previous module.
3. Reassemble the device with the new module.
4. Put the device back into operation and check the basic functions (e.g. measured value and temperature display, operation via keyboard).
5. Read the serial number ("ser-no.") off the nameplate of the device (e.g. 6A345605G00) and enter this number in fields E115 (1st digit = year, one-digit (6 in the example)), E116 (2nd digit: month, one-digit (A in the example)), E117 (digits 3-6 cons. number, four-digit (3456 in the example)).
  - ↳ In the field E118, the complete number is displayed again so you can check it is correct.

 You can only enter the serial number for new modules with the serial number 0000. This can only be done once! For this reason, make sure the number entered is correct before you press ENTER to confirm!

If an incorrect code is entered, the additional functions are not enabled. An incorrect serial number can only be corrected at the factory!

1. Press ENTER to confirm the serial number or cancel the entry to enter the number again.
2. If available, enter the release codes for the Plus Package and/or Chemoclean in the "Service" menu.
3. Check the Plus Package release (e.g. by opening the function group CHECK / Code P) or the Chemoclean function.
4. Make the customized device settings again.

## 10.5 Return

The product must be returned if repairs or a factory calibration are required, or if the wrong product was ordered or delivered. As an ISO-certified company and also due to legal regulations, Endress+Hauser is obliged to follow certain procedures when handling any returned products that have been in contact with medium.

To ensure swift, safe and professional device returns, please read the return procedures and conditions at [www.endress.com/support/return-material](http://www.endress.com/support/return-material).

## 10.6 Disposal

The device contains electronic components and must therefore be disposed of in accordance with regulations on the disposal of electronic waste.

Observe the local regulations.

## 11 Accessories

### 11.1 Sensors

#### Oxymax COS41

- Oxygen sensor for drinking water and industrial water measurement, amperometric measuring principle
- Material: POM
- Product Configurator on the product page: [www.endress.com/cos41](http://www.endress.com/cos41)



Technical Information TI00248C

#### Oxymax COS61

- Optical oxygen sensor for drinking water and industrial water measurement
- Measuring principle: quenching
- Material: stainless steel 1.4571 (AISI 316Ti)
- Product Configurator on the product page: [www.endress.com/cos61](http://www.endress.com/cos61)



Technical Information TI00387C

### 11.2 Connection accessories

#### OMK

- Unterminated measuring cable for COS61 oxygen sensors
- For extension between VS junction box and transmitter
- Sold by meter, Order No.: 50004124

#### VS

- Junction box for cable extension of COS61 sensor with SXP plug-in connector
- With socket and 7-pin connector
- Degree of protection: IP 65
- Order number: 50001054

#### VBM

- Junction box for cable extension
- 10 terminal strips
- Cable entries: 2 x Pg 13.5 or 2 x NPT ½"
- Material: aluminum
- Degree of protection: IP 65
- Order numbers
  - Cable entries Pg 13.5 : 50003987
  - Cable entries NPT ½": 51500177

### 11.3 Installation accessories

#### CYY101

- Weather protection cover for field devices
- Absolutely essential for field installation
- Material: stainless steel 1.4301 (AISI 304)
- Order No. CYY101-A

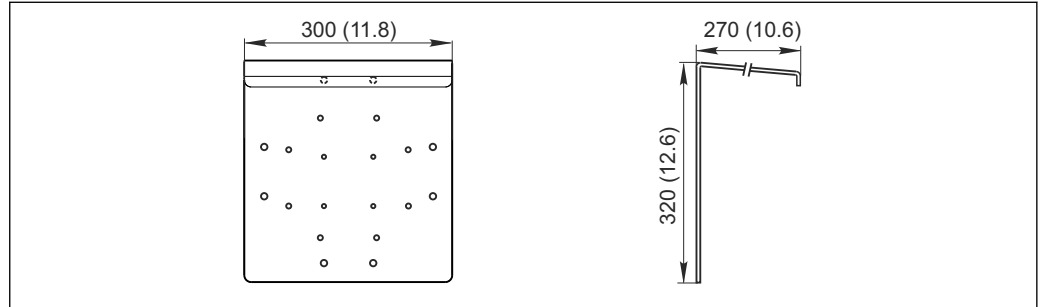

A0024627

39 Dimensions in mm (inch)

#### Flexdip CYH112

- Modular holder system for sensors and assemblies in open basins, channels and tanks
- For Flexdip CYA112 water and wastewater assemblies
- Can be affixed anywhere: on the ground, on the capstone, on the wall or directly onto railings.
- Stainless steel version
- Product Configurator on the product page: [www.endress.com/cyh112](http://www.endress.com/cyh112)

 Technical Information TI00430C

#### Post mounting kit

- For securing the field housing to horizontal and vertical posts and pipes
- Material: stainless steel 1.4301 (AISI 304)
- Order No. 50086842

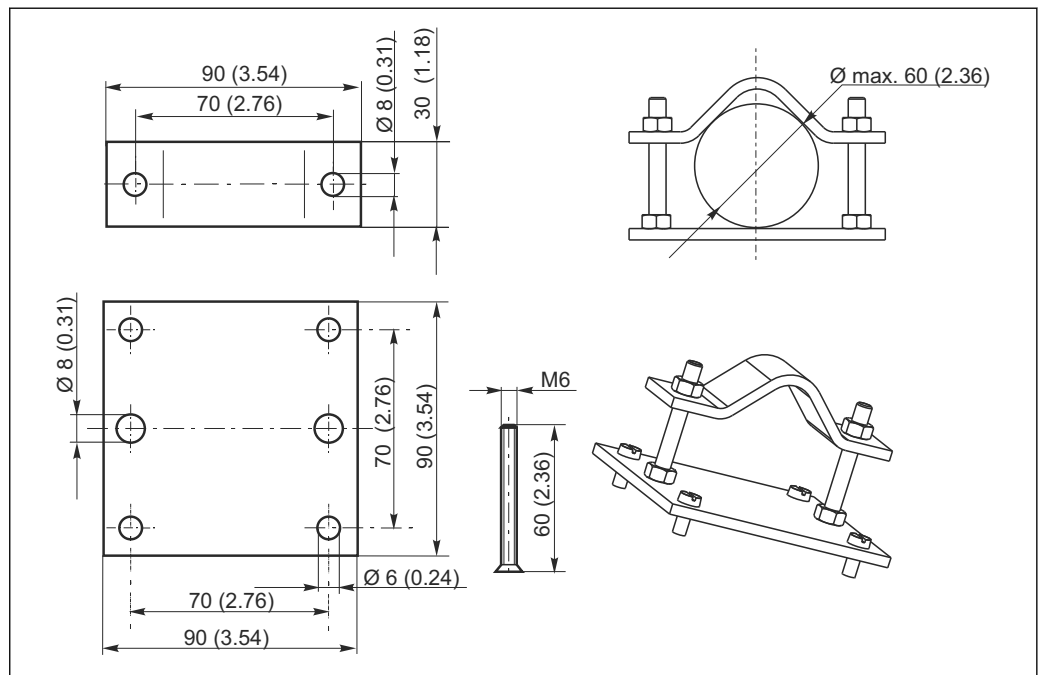

A0024660

40 Dimensions in mm (inch)

## 11.4 Software and hardware add-ons

The add-ons can only be ordered by quoting the serial number of the device in question.

- Plus Package  
Order No. 51501679
- Chemoclean function (requires four-relay card)  
Order No. 51500963
- Two-relay card  
Order No. 51500320
- Four-relay card  
Order No. 51500321
- Two-relay card with current input  
Order No. 51504304
- Four-relay card with current input  
Order No. 51504305

## 12 Technical data

### 12.1 Input

Measured variables	Oxygen Temperature	
Measuring range	Concentration	0 to 20 mg/l
	Saturation index	0 to 200 % SAT
	Partial pressure	0 to 400 hPa (0 to 6 psi)
	Temperature	-10 to 60 °C (can also be displayed in °F)
O <sub>2</sub> signal input	DS/DX version	0 to 3000 nA
	WS/WX version	Digital communication or 0 to -7500 mV
Binary inputs	Voltage	10 to 50 V
	Current consumption	Max. 10 mA
Current input	4 to 20 mA, galvanically isolated Load: 260 Ω for 20 mA (voltage drop 5.2 V)	

### 12.2 Output

Output signal	<b>HART</b>	
	Signal encoding	Frequency Shift Keying (FSK) + 0.5 mA via current output signal
	Data transmission rate	1200 baud
	Galvanic isolation	Yes
	<b>PROFIBUS PA</b>	
	Signal encoding	Manchester Bus Powered (MBP)
	Data transmission rate	31.25 kBit/s, voltage mode
	Galvanic isolation	Yes (IO modules)
	<b>PROFIBUS DP</b>	
	Signal encoding	RS485
	Data transmission rate	9.6 kBd, 19.2 kBd, 93.75 kBd, 187.5 kBd, 500 kBd, 1.5 MBd
	Galvanic isolation	Yes (IO modules)
Signal on alarm	2.4 or 22 mA in the event of an error	
Load	Max. 500 Ω	

Transmission range	Concentration	$\Delta$ 0.2 to $\Delta$ 20 mg/l
	Saturation index	$\Delta$ 2 to $\Delta$ 200 % SAT
	Partial pressure	$\Delta$ 4 to $\Delta$ 400 hPa
Signal resolution	Max. 700 digits/mA	
Separation voltage	Max. 350 V <sub>RMS</sub> / 500 V DC	
Auxiliary voltage output	Output voltage	15 V $\pm$ 0.6 V
	Output current	Max. 10 mA
Contact outputs	Switching current with ohmic load (cos $\varphi$ = 1)	Max. 2 A
	Switching current with inductive load (cos $\varphi$ = 0.4)	Max. 2 A
	Switching voltage	Max. 250 V AC, 30 V DC
	Switching power with ohmic load (cos $\varphi$ = 1)	Max. 500 VA AC, 60 W DC
	Switching power with inductive load (cos $\varphi$ = 0.4)	Max. 500 VA AC, 60 W DC
Limit contactors	Pickup/dropout delay	0 to 2000 s
Controller	Function (configurable)	Pulse length/pulse frequency controller, continuous controller
	Controller behavior	P, PI, PD, PID, basic load dosing
	Control gain $K_p$	0.01 to 20.00
	Integral action time $T_n$	0.0 to 999.9 min
	Derivative action time $T_v$	0.0 to 999.9 min
	Period length for pulse length controller	0.5 to 999.9 s
	Frequency for pulse frequency controller	60 to 180 min <sup>-1</sup>
	Basic load	0 to 40 % of max. actuating variable
Alarm	Function (switchable)	Latching/momentary contact
	Alarm threshold adjustment range	O <sub>2</sub> / temperature: entire measuring range depending on sensor used
	Alarm delay	0 to 2000 s
	Monitoring time for lower limit violation	0 to 2000 min
	Monitoring time for upper limit violation	0 to 2000 min



## Protocol-specific data

<b>HART</b>	
Manufacturer ID	11 <sub>h</sub>
Device type	0094 <sub>h</sub>
Transmitter-specific revision	0001 <sub>h</sub>
HART version	5.0
Device description files (DD)	<a href="http://www.endress.com/hart">www.endress.com/hart</a>
HART load (communication resistor)	250 Ω
Device variables	None (only dynamic variables PV and SV)
Supported features	-

<b>PROFIBUS PA</b>	
Manufacturer ID	11 <sub>h</sub>
Device type	1518 <sub>h</sub>
Device revision	0001 <sub>h</sub>
Profile version	2.0
GSD files	<a href="http://www.endress.com/profibus">www.endress.com/profibus</a>
GSD version	
Output values	Primary value, temperature
Input variables	PCS display value
Supported features	Device lock: The device can be locked using the hardware or software.

<b>PROFIBUS DP</b>	
Manufacturer ID	11 <sub>h</sub>
Device type	151E <sub>h</sub>
Profile version	2.0
GSD files	<a href="http://www.endress.com/profibus">www.endress.com/profibus</a>
GSD version	
Output values	Primary value, temperature
Input variables	PCS display value
Supported features	Device lock: The device can be locked using the hardware or software.

## 12.3 Power supply

Supply voltage  
 Depending on order version:  
 ■ 100/115/230 V AC +10/-15 %, 48 to 62 Hz  
 ■ 24 V AC/DC +20/-15 %

Power supply via fieldbus

<b>HART</b>	
Supply voltage	Not applicable, active current outputs
Reverse polarity protection	Not applicable, active current outputs

<b>PROFIBUS PA</b>	
Supply voltage	9 V to 32 V, max. 35 V
Sensitivity to reverse polarity	No
FISCO/FNICO compliant according to IEC 60079-27	No

<b>PROFIBUS DP</b>	
Supply voltage	9 V to 32 V, max. 35 V
Sensitivity to reverse polarity	Not applicable
FISCO/FNICO compliant according to IEC 60079-27	No

Power consumption Max. 7.5 VA

Mains fuse Fine-wire fuse, semi-delay 250 V/3.15 A

Circuit breaker

**NOTICE**  
**The device does not have a power switch**  
 ► The customer must provide a protected circuit breaker in the vicinity of the device.  
 ► The circuit breaker must be a switch or power switch, and you must label it as the circuit breaker for the device.  
 ► At the supply point, the power supply for the 24 V versions must be isolated from dangerous live cables by double or reinforced insulation.

Cable specification  
 Cable length COS61 Max. 100 m (330 ft)  
 Cable length COS41 Max. 50 m (160 ft)

Overvoltage protection According to EN 61000-4-5

## 12.4 Performance characteristics

Reference operating conditions	Reference temperature:	25 °C (77 °F)
	Reference pressure:	1013 hPa (15 psi)
	Reference application:	Air-saturated water
Measured value resolution	Oxygen	0.01 mg/l / 0.1 % SAT / 1 hPa
	Temperature	0.1 °C
Maximum measured error	Display	
	Oxygen	Max. 0.5 % of measuring range
	Temperature	Max. 1.0 % of measuring range
	Signal output	
	Oxygen	Max. 0.75 % of measuring range
	Temperature	Max. 1.25 % of measuring range
 Measured errors in accordance with DIN IEC 746 Part 1, at rated operating conditions		
Repeatability	Max. 0.2 % of measuring range	
Slope adjustment	COS41	75 to 140 % (nominal 290 nA, in air, 20 °C, 1013 hPa)
	COS61	75 to 140 % (nominal 1340 nA, in air, 20 °C, 1013 hPa)

## 12.5 Environment

Ambient temperature range	-10 to +55 °C (+10 to +130 °F)	
Storage temperature	-25 to +65 °C (-10 to +150 °F)	
Electromagnetic compatibility	Interference emission and interference immunity as per EN 61326-1:2006, EN 61326-2-3:2006	
Degree of protection	Field device	IP 65 / integrity according to NEMA 4X
	Panel-mounted device	IP 54 (front), IP 30 (housing)
Electrical safety	As per EN/IEC 61010-1:2010, overvoltage category II for installations up to 2000 m (6500 ft) above MSL	
CSA	Device versions with CSA General Purpose approval are certified for indoor use.	
Relative humidity	10 to 95%, not condensing	

---

Degree of contamination      The product is suitable for pollution degree 2.

## 12.6 Mechanical construction

---

Dimensions	Panel-mounted device	L x B x D: 96 x 96 x 145 mm (3.78" x 3.78" x 5.71") Installation depth: approx. 165 mm (6.50")
	Field device	L x B x D: 247 x 170 x 115 mm (9.72" x 6.69" x 4.53")
Weight	Panel-mounted device	Max. 0.7 kg (1.54 lbs.)
	Field device	Max. 2.3 kg (5.07 lbs.)
Materials	Panel-mounted device housing	Polycarbonate
	Field housing	ABS PC FR
	Front membrane	Polyester, UV-resistant
Terminals	Cable cross-section	Max. 2.5 mm <sup>2</sup> (14 AWG)

---

# 13 Appendix

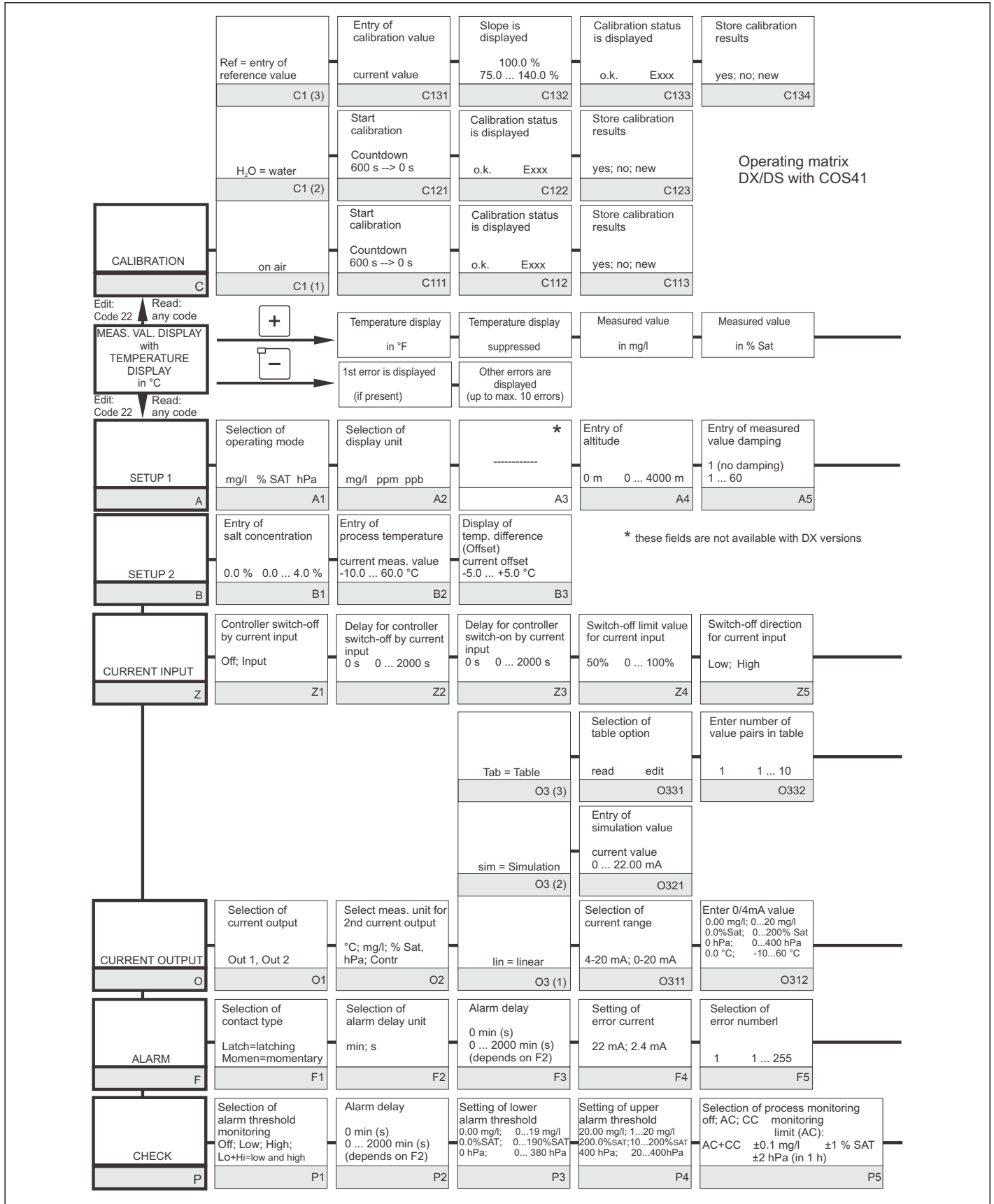

A0027486-EN

Measured value in hPa	Measured value Sensor signal in nA / mV	Measured value Current input in %	Measured value Current input in mA
--------------------------	--	--------------------------------------	---------------------------------------

only display switch!!

Selection of measuring range 20 mg/l    60 mg/l 200%Sat   600% Sat 400 hPa   1200 hPa
A6

Feedforward control to PID controller Off; lin = linear Basic = basic load	Feedforward control gain = 1 at 50%   0 ... 100%
Z6	Z7

Selection of value pair in table 1 1 ... no. of value pairs assign	Entry of x-value (measured value) 0.00 mg/l; 0...20 mg/l 0.0%SAT; 0...200%SAT 0 hPa;   0...400 hPa	Entry of y-value (current) 0.00mA; 0...20.00mA	Table status o.k. yes; no
O333	O334	O335	O336

Enter 20mA value 10.00 mg/l;   0...20 mg/l 100.0%SAT; 0...200%SAT 200 hPa;    0...400hPa 40.0 °C;    -10...60 °C
O313

Activate alarm contact yes; no	Activate error current for previously set error no; yes	Automatic start of cleaning function no; yes	Selection "next error" or return to menu Next=next error <--- R
F6	F7	F8	F9

Setting of maximum permissible limit violation period (below limit) 480 min; 0...2000 min	Setting of maximum permissible limit violation period (upper limit) 240 min; 0...2000 min	Setting of limit value 5.00 mg/l;   0...20 mg/l 50.0 %SAT; 0...200%SAT 200 hPa;    0...400 hPa
P6	P7	P8

Field for customer settings

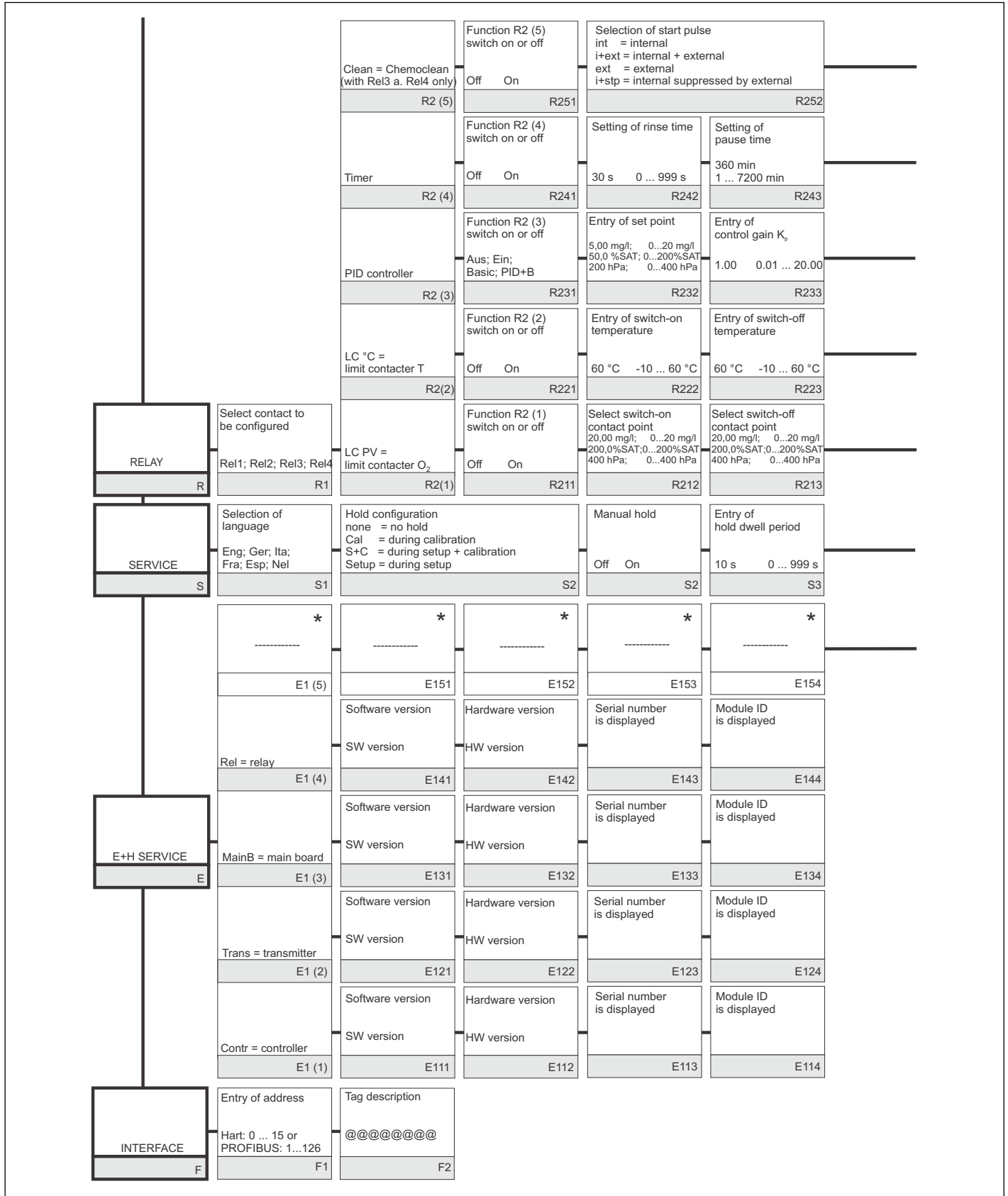

A0027488-EN



Entry of pre-rinse time 30 s 0 ... 999 s R253	Entry of cleaning time 10 s 0 ... 999 s R254	Entry of post-rinse time 30 s 0 ... 999 s R255	Number of repeat cycles 0 0 ... 5 R256	Setting of interval between 2 cleaning cycles (pause time) 360 min 1...7200 min R257	Setting of minimum pause time 120 min 1...3600 min R258	Number of cleaning cycles without cleaning agent 0 0 ... 9 R259	Chemoclean: uses 2 contacts, only permissible for contacts 3 (+4)		
Setting of minimum pause time 120 min 1...3600 min R244									
Entry of integral action time T <sub>n</sub> (0.0=no I component) 0.0 s 0.0...999.9 min R234	Entry of derivative action time T <sub>v</sub> (0.0=no D component) 0.0 s 0.0...999.9 min R235	Selection of control characteristics inv = invers dir = direct R236	Selection len = pulse length freq = pulse frequency curr = current output R237	Entry of pulse interval 10.0 s 0.5...999.9 s R238	Entry of pulse frequency 120 min <sup>-1</sup> 60 ... 180 min <sup>-1</sup> R239	Entry of minimum on time t <sub>on</sub> 0.3 s 0.1 ... 5.0 s R2310	Entry of basic load 0% 0 ... 40% R2311		
Setting of pick-up delay 0 s 0 ... 2000 s R224	Setting of drop-out delay 0 s 0 ... 2000 s R225	Setting of alarm threshold (absolute value) 60 °C -10 ... 60 °C R226	LC status MIN; MAX R227						
Setting of pick-up delay 0 s 0 ... 2000 s R214	Setting of drop-out delay 0 s 0 ... 2000 s R215	Setting of alarm threshold (abs. value) 20.00 mg/l; 0...20 mg/l 200.0%SAT;0...200%SAT 400 hPa; 0...400 hPa R216	LC status MIN; MAX R217						
Entry of SW upgrade release code (Plus package) 0000 0000 ... 9999 S2	Entry of SW upgrade release code Chemoclean 0000 0000 ... 9999 S6	Display of order number S7	Display of serial number S8	Reset instrument to default values no; sens; factory S9	Perform instrument test no; display S10	* ----- S11			
* ----- E155	* ----- E156	* ----- E157	* ----- E158	* ----- E159					
* these fields are not available with COS 41									

A0027489-EN

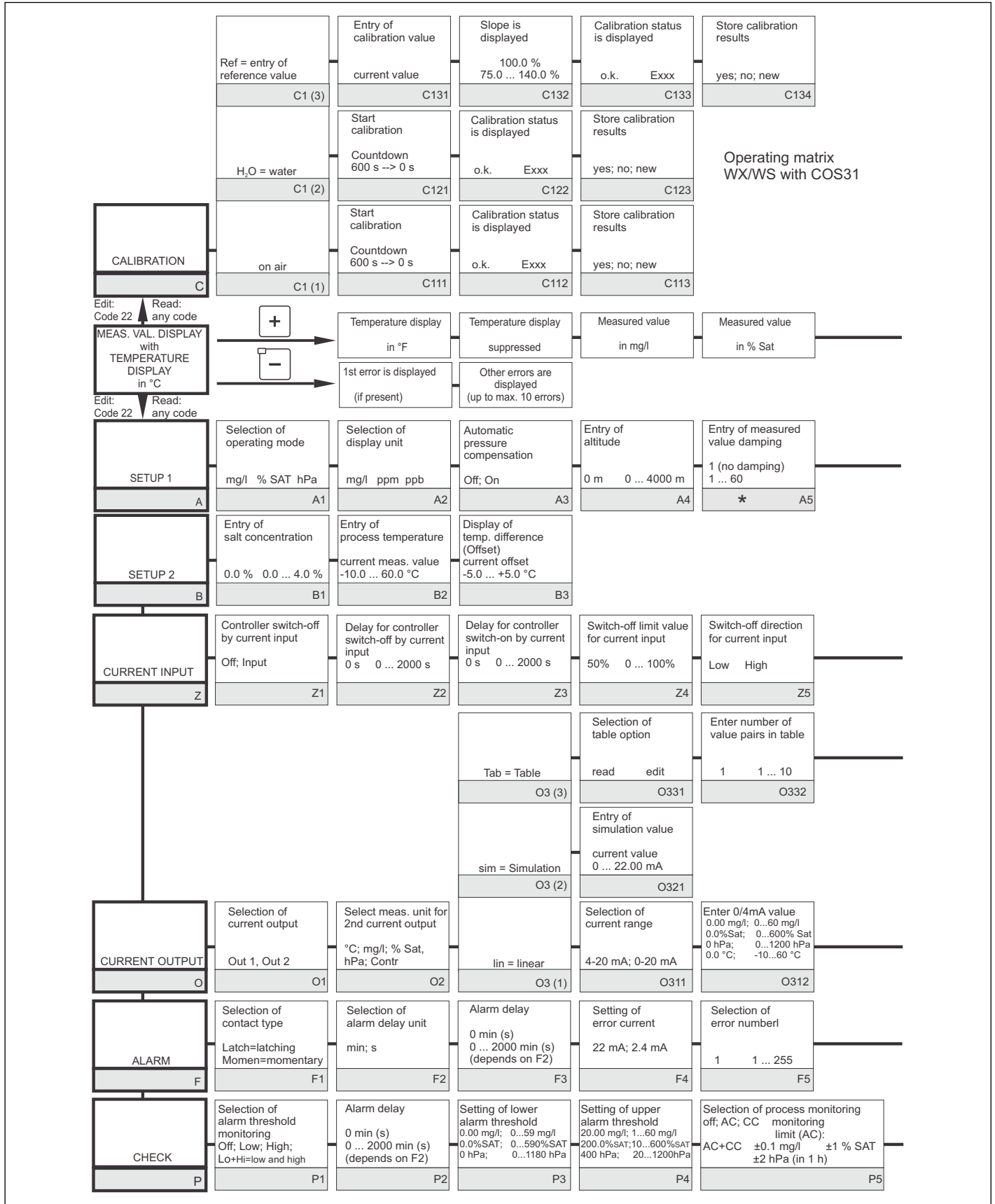

A0027490-EN

Measured value in hPa	Measured value Sensor signal in nA / mV	Measured value Current input in %	Measured value Current input in mA
--------------------------	--	--------------------------------------	---------------------------------------

only display switch!!

Selection of measuring range 20 mg/l    60 mg/l 200%Sat   600% Sat 400 hPa   1200 hPa
A6

Feedforward control to PID controller Off; lin = linear Basic = basic load	Feedforward control gain = 1 at 50%   0 ... 100%
Z6	Z7

Selection of value pair in table 1 1 ... no. of value pairs assign	Entry of x-value (measured value) 0.00 mg/l; 0...60 mg/l 0.0%SAT; 0...600%SAT 0 hPa; 0...1200 hPa	Entry of y-value (current) 0.00mA; 0...20.00mA	Table status o.k. yes; no
O333	O334	O335	O336

Enter 20mA value 10.00 mg/l; 0...60 mg/l 100.0%SAT; 0...600%SAT 200 hPa; 0...1200hPa 40.0 °C; -10...60 °C
O313

Activate alarm contact yes; no	Activate error current for previously set error no; yes	Automatic start of cleaning function no; yes	Selection "next error" or return to menu Next=next error <--- R
F6	F7	F8	F9

Setting of maximum permissible limit violation period (below limit) 480 min; 0...2000 min	Setting of maximum permissible limit violation period (upper limit) 240 min; 0...2000 min	Setting of limit value 5.00 mg/l; 0...60 mg/l 50.0 %SAT; 0...600%SAT 200 hPa; 0...1200 hPa
P6	P7	P8

Field for customer settings

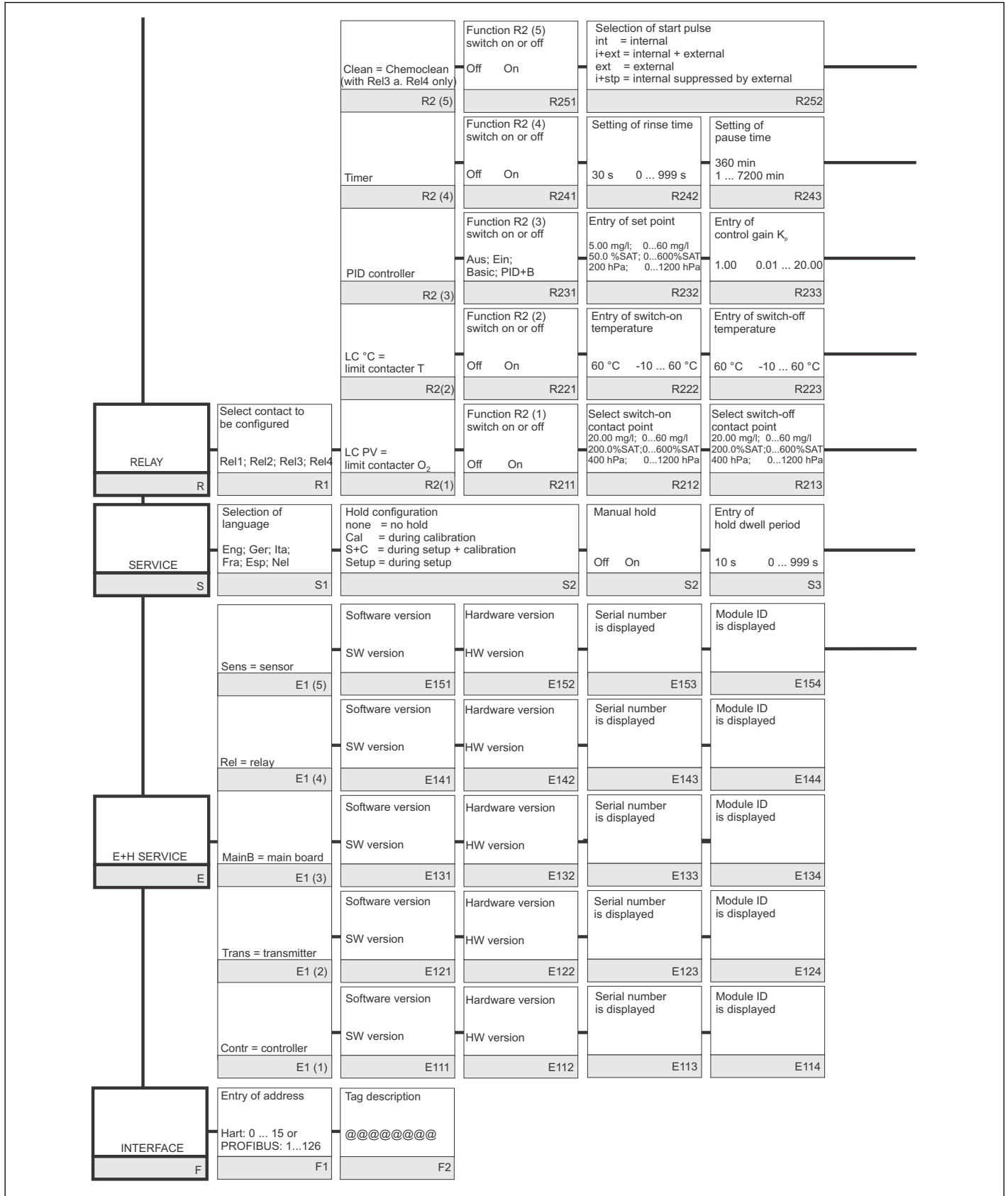

A0027492-EN

Entry of pre-rinse time 30 s 0 ... 999 s R253	Entry of cleaning time 10 s 0 ... 999 s R254	Entry of post-rinse time 30 s 0 ... 999 s R255	Number of repeat cycles 0 0 ... 5 R256	Setting of interval between 2 cleaning cycles (pause time) 360 min 1...7200 min R257	Setting of minimum pause time 120 min 1...3600 min R258	Number of cleaning cycles without cleaning agent 0 0 ... 9 R259	Chemoclean: uses 2 contacts, only permissible for contacts 3 (+4)		
Setting of minimum pause time 120 min 1...3600 min R244									
Entry of integral action time Tn (0.0=no I component) 0.0 s 0.0...999.9 min R234	Entry of derivative action time Tv (0.0=no D component) 0.0 s 0.0...999.9 min R235	Selection of control characteristics inv = invers dir = direct R236	Selection len = pulse length freq = pulse frequency curr = current output R237	Entry of pulse interval 10.0 s 0.5...999.9 s R238	Entry of pulse frequency 120 min <sup>-1</sup> 60 ... 180 min <sup>-1</sup> R239	Entry of minimum on time t <sub>on</sub> 0.3 s 0.1 ... 5.0 s R2310	Entry of basic load 0% 0 ... 40% R2311		
Setting of pick-up delay 0 s 0 ... 2000 s R224	Setting of drop-out delay 0 s 0 ... 2000 s R225	Setting of alarm threshold (absolute value) 60 °C -10 ... 60 °C R226	LC status MIN; MAX R227						
Setting of pick-up delay 0 s 0 ... 2000 s R214	Setting of drop-out delay 0 s 0 ... 2000 s R215	Setting of alarm threshold (abs. value) 20.00 mg/l; 0...60 mg/l 200.0%SAT;0...600%SAT 400 hPa; 0...1200 hPa R216	LC status MIN; MAX R217						
Entry of SW upgrade release code (Plus package) 0000 0000 ... 9999 S2	Entry of SW upgrade release code Chemoclean 0000 0000 ... 9999 S6	Display of order number S7	Display of serial number S8	Reset instrument to default values no; sens; factory S9	Perform instrument test no; display S10	Display of absolute air pressure S11			
Serial number sensor head existing serial no. 00000000...99999999 E155	Serial number sensor existing serial no. 00000000...99999999 E156	Order number sensor existing order no. COS31-...COS31-ZZZZ E157	Display of minimum temperature E158	Display of maximum temperature E159					

A0027493-EN

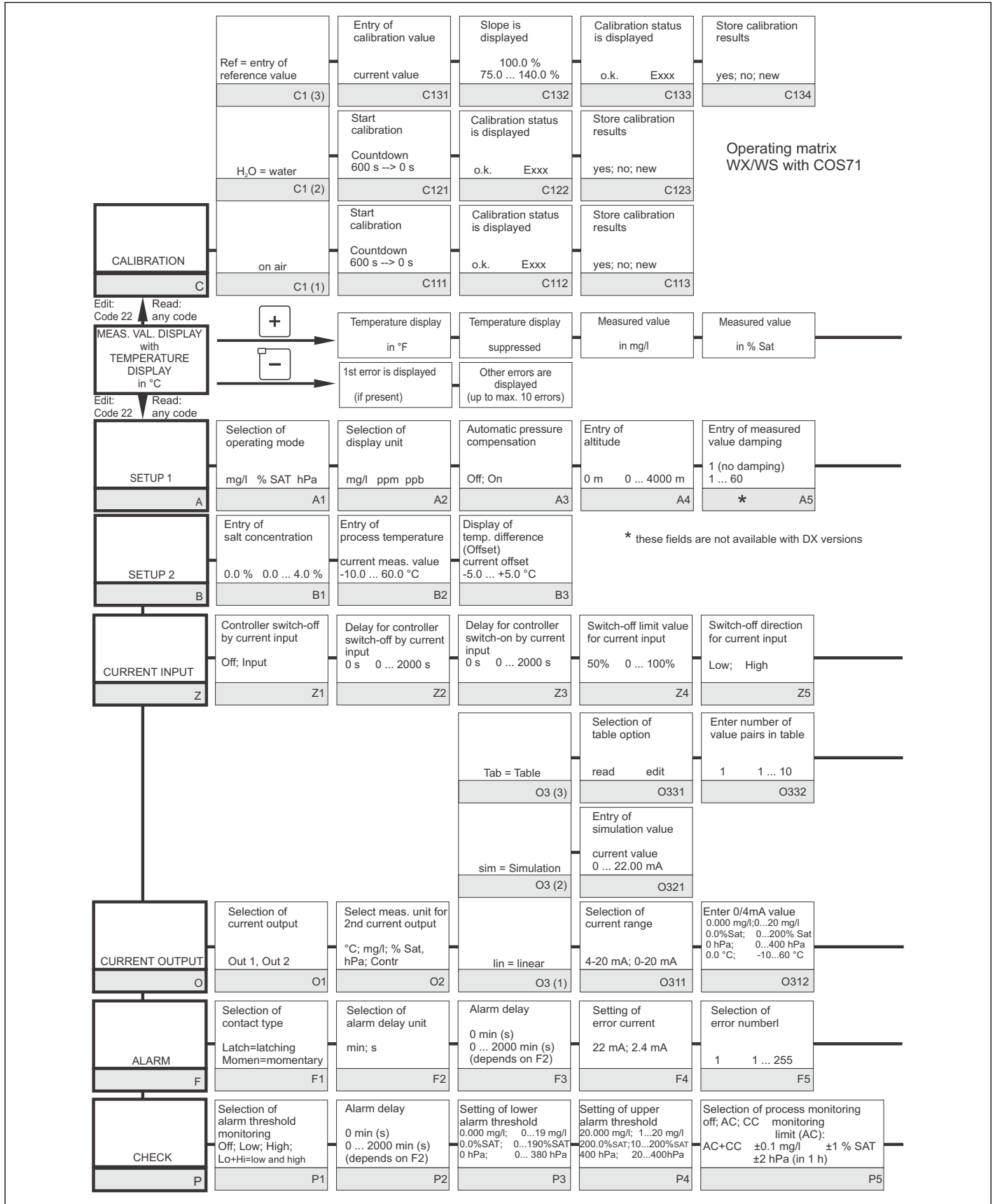

A0027494-EN

Measured value in hPa	Measured value Sensor signal in nA / mV	Measured value Current input in %	Measured value Current input in mA
--------------------------	--	--------------------------------------	---------------------------------------

only display switch!!

Selection of measuring range 20 mg/l    60 mg/l 200%Sat   600% Sat 400 hPa   1200 hPa
A6

Feedforward control to PID controller Off; lin = linear Basic = basic load	Feedforward control gain = 1 at 50%   0 ... 100%
Z6	Z7

Selection of value pair in table 1 1 ... no. of value pairs assign	Entry of x-value (measured value) 0.000 mg/l; 0...20 mg/l 0.0%SAT; 0...200%SAT 0 hPa;   0...400 hPa	Entry of y-value (current) 0.00mA; 0...20.00mA	Table status o.k. yes; no
O333	O334	O335	O336

Enter 20mA value 10.000 mg/l; 0...20 mg/l 100.0%SAT; 0...200%SAT 200 hPa;   0...400hPa 40.0 °C;   -10...60 °C
O313

Activate alarm contact yes; no	Activate error current for previously set error no; yes	Automatic start of cleaning function no; yes	Selection "next error" or return to menu Next=next error <--- R
F6	F7	F8	F9

Setting of maximum permissible limit violation period (below limit) 480 min; 0...2000 min	Setting of maximum permissible limit violation period (upper limit) 240 min; 0...2000 min	Setting of limit value 1.000 mg/l;   0...20 mg/l 50.0 %SAT; 0...200%SAT 20 hPa;   0...400 hPa
P6	P7	P8

Field for customer settings

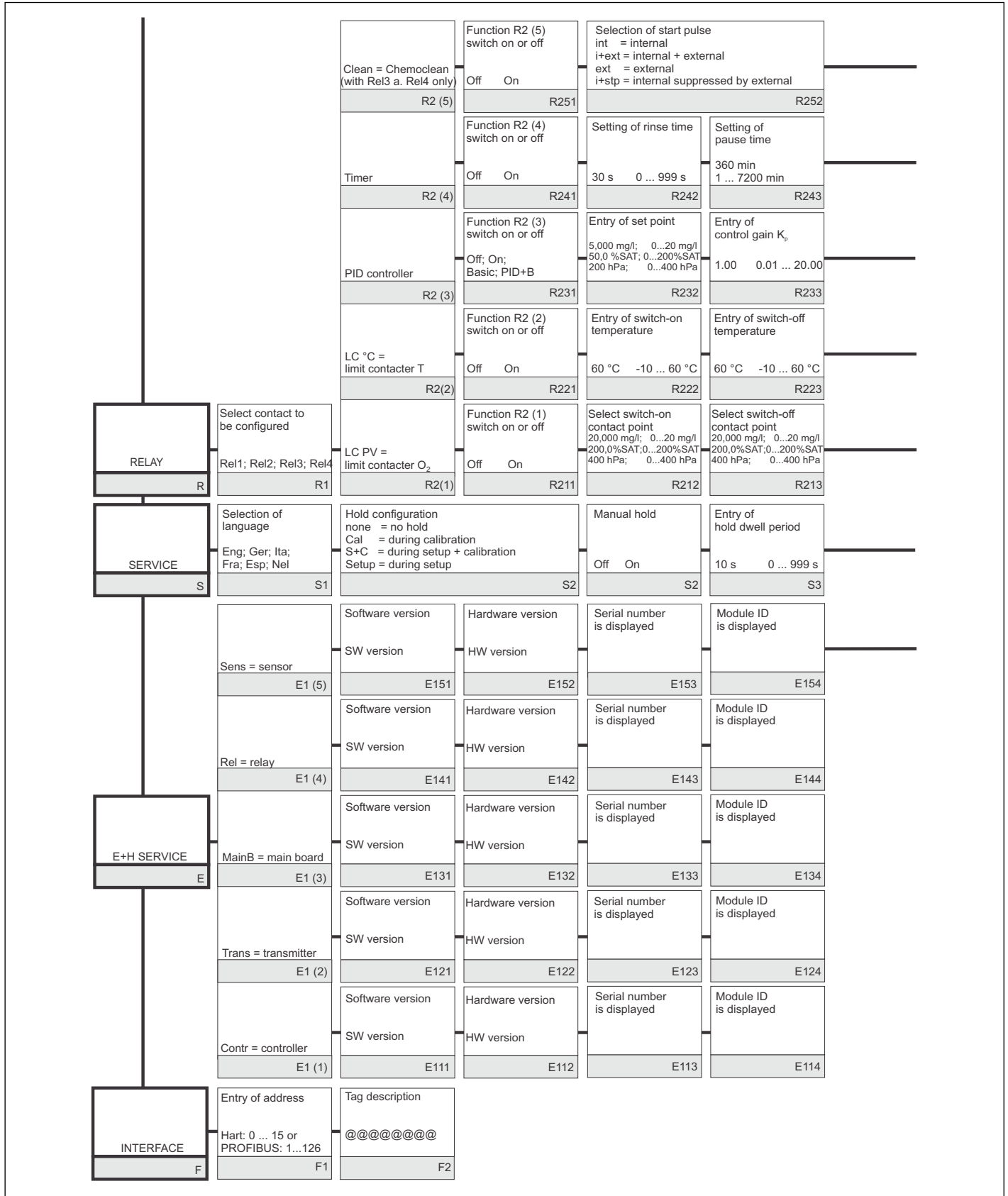



Entry of pre-rinse time 30 s 0 ... 999 s R253	Entry of cleaning time 10 s 0 ... 999 s R254	Entry of post-rinse time 30 s 0 ... 999 s R255	Number of repeat cycles 0 0 ... 5 R256	Setting of interval between 2 cleaning cycles (pause time) 360 min 1...7200 min R257	Setting of minimum pause time 120 min 1...3600 min R258	Number of cleaning cycles without cleaning agent 0 0 ... 9 R259	Chemoclean: uses 2 contacts, only permissible for contacts 3 (+4)	
Setting of minimum pause time 120 min 1...3600 min R244	Entry of integral action time T <sub>n</sub> (0.0=no I component) 0.0 s 0.0...999.9 min R234	Entry of derivative action time T <sub>v</sub> (0.0=no D component) 0.0 s 0.0...999.9 min R235	Selection of control characteristics inv = invers dir = direct R236	Selection len = pulse length freq = pulse frequency curr = current output R237	Entry of pulse interval 10.0 s 0.5...999.9 s R238	Entry of pulse frequency 120 min <sup>-1</sup> 60 ... 180 min <sup>-1</sup> R239	Entry of minimum on time t <sub>on</sub> 0.3 s 0.1 ... 5.0 s R2310	Entry of basic load 0% 0 ... 40% R2311
Setting of pick-up delay 0 s 0 ... 2000 s R224	Setting of drop-out delay 0 s 0 ... 2000 s R225	Setting of alarm threshold (absolute value) 60 °C -10 ... 60 °C R226	LC status MIN; MAX R227	Setting of pick-up delay 0 s 0 ... 2000 s R214	Setting of drop-out delay 0 s 0 ... 2000 s R215	Setting of alarm threshold (abs. value) 20.000 mg/l; 0...60 mg/l 200.0%SAT;0...600%SAT 400 hPa; 0...1200 hPa R216	LC status MIN; MAX R217	
Entry of SW upgrade release code (Plus package) 0000 0000 ... 9999 S2	Entry of SW upgrade release code Chemoclean 0000 0000 ... 9999 S6	Display of order number S7	Display of serial number S8	Reset instrument to default values no; sens; factory S9	Perform instrument test no; display S10	Display of absolute air pressure S11		
Serial number sensor head existing serial no. 00000000...99999999 E155	Serial number sensor existing serial no. 00000000...99999999 E156	Order number sensor existing order no. COS71-...COS71-ZZZZ E157	Display of minimum temperature E158	Display of maximum temperature E159				

A0027497-EN

# Index

## A

Access codes	34
Accessories	100
Alarm	51
Alarm contact	27
Approvals	10
Automatic mode	33

## C

Calibration	74
Central module replacement	98
Certificates	10
Check	52
Version 1	89
Version 2	89

## Cleaning

Transmitter	87
-------------	----

Commissioning	36
---------------	----

Communication	73
---------------	----

Connecting cables	90
-------------------	----

Current input	42
---------------	----

Current outputs	46
-----------------	----

## D

Designated use	7
----------------	---

Device configuration	40
----------------------	----

Device-specific errors	85
------------------------	----

Diagnostics	78
-------------	----

## Disassembling

Field device	95
--------------	----

Panel-mounted device	92
----------------------	----

Display	28
---------	----

Disposal	99
----------	----

## E

E+H Service	72
-------------	----

Electrical connection	18
-----------------------	----

Version 1	18
-----------	----

Version 2	22
-----------	----

Environment	107
-------------	-----

## F

Feedforward control	43
---------------------	----

## H

Hold function	35
---------------	----

## I

Incoming acceptance	9
---------------------	---

Input	103
-------	-----

Installation	11
--------------	----

Installation conditions	13
-------------------------	----

Installation instructions	15
---------------------------	----

Interfaces	73
------------	----

## J

Junction boxes	90
----------------	----

## K

Key functions	30
---------------	----

## L

Local operation	33
-----------------	----

## M

Maintenance	87
-------------	----

Assembly	90
----------	----

Sensor	90
--------	----

Maintenance of the entire measuring point	87
---	----

Manual mode	33
-------------	----

Measuring system	12
------------------	----

Mechanical construction	108
-------------------------	-----

Menu structure	35
----------------	----

## N

Nameplate	10
-----------	----

## O

Operating concept	34
-------------------	----

Operating elements	30
--------------------	----

Operating modes	34
-----------------	----

Operation	28
-----------	----

Output	103
--------	-----

## P

P(ID) controller	58
------------------	----

Performance characteristics	107
-----------------------------	-----

Post mounting	15
---------------	----

Post-connection check	27
-----------------------	----

Post-installation check	17
-------------------------	----

Power supply	106
--------------	-----

Process-specific errors	81
-------------------------	----

Product identification	9
------------------------	---

## Q

Quick Setup	38
-------------	----

## R

Relay configuration	56
---------------------	----

Repair	92
--------	----

Replacing the central module	98
------------------------------	----

Return	98
--------	----

## S

Safety instructions	7
---------------------	---

Scope of delivery	9
-------------------	---

SCS monitoring functions	53
--------------------------	----

## Sensor connection

Version 1	21
-----------	----

Version 2	25
-----------	----

Service	70
---------	----

Setup 1	40
---------	----

Setup 2	42
---------	----

Spare parts	92
-------------	----

Switching on	36
--------------	----

Symbols . . . . .	5
System error messages . . . . .	78

**T**

Technical data . . . . .	103
Trouble shooting instructions . . . . .	78
Troubleshooting . . . . .	78

**U**

Use . . . . .	7
---------------	---

**W**

Wall mounting . . . . .	15
Warnings . . . . .	5
Wiring . . . . .	18
Wiring diagram	
Version 1 . . . . .	18
Version 2 . . . . .	22



[www.addresses.endress.com](http://www.addresses.endress.com)

---