

A2 PRESSURE TRANSMITTER INSTRUCTION SHEET



⚠️ WARNING! READ ⚠️ BEFORE INSTALLATION

1. GENERAL:

A failure resulting in **injury** or **damage** may be caused by excessive overpressure, excessive vibration or pressure pulsation, excessive instrument temperature, corrosion of the pressure containing parts, or other misuse. Consult Ashcroft Inc., Stratford, Connecticut, USA before installing if there are any questions or concerns.

2. OVERPRESSURE:

Pressure spikes in excess of the rated overpressure capability of the transducer may cause **irreversible electrical and/or mechanical damage** to the pressure measuring and containing elements.

Fluid hammer and surges can destroy any pressure transducer and must always be avoided. A pressure snubber should be installed to eliminate the damaging hammer effects. Fluid hammer occurs when a liquid flow is sud-

denly stopped, as with quick closing solenoid valves. Surges occur when flow is suddenly begun, as when a pump is turned on at full power or a valve is quickly opened.

Liquid surges are particularly damaging to pressure transducers if the pipe is originally empty. To avoid damaging surges, fluid lines should remain full (if possible), pumps should be brought up to power slowly, and valves opened slowly. To avoid damage from both fluid hammer and surges, a surge chamber should be installed.

Symptoms of fluid hammer and surge's damaging effects:

- Pressure transducer exhibits an output at zero pressure (large zero offset).
- Pressure transducer output remains constant regardless of pressure
- In severe cases, there will be no output.

FREEZING:

Prohibit freezing of media in pressure port. Unit should be drained (mount in vertical position with electrical termination upward) to prevent possible overpressure damage from frozen media.

3. STATIC ELECTRICAL CHARGES:

Any electrical device may be susceptible to damage when exposed to static electrical charges. To avoid damage to the transducer observe the following:

- Operator/installer should follow the proper ESD (electrostatic discharge) protection procedures before handling the pressure transducer.
- Ground the body of the transducer **BEFORE** making any electrical connections
- When disconnecting, remove the ground **LAST!**

Note: The shield and drain wire in the cable (if supplied) is not connected to the transducer body, and is not a suitable ground.

Ashcroft® A2 Pressure Transmitter, Typical Dimensions and Construction*

Enclosure Options "S" and "Z"

Threaded housing with zero & span access

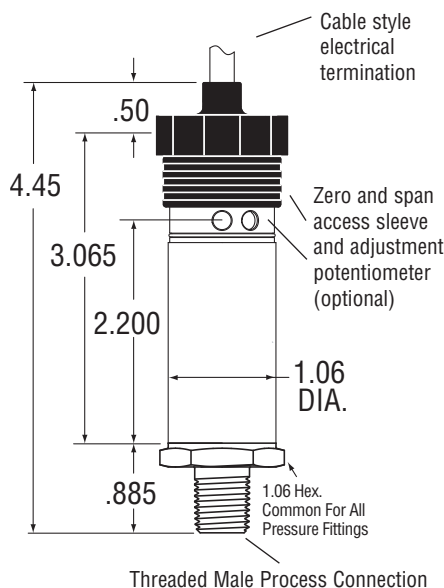

Enclosure Option "W"

Welded housing without zero and span access

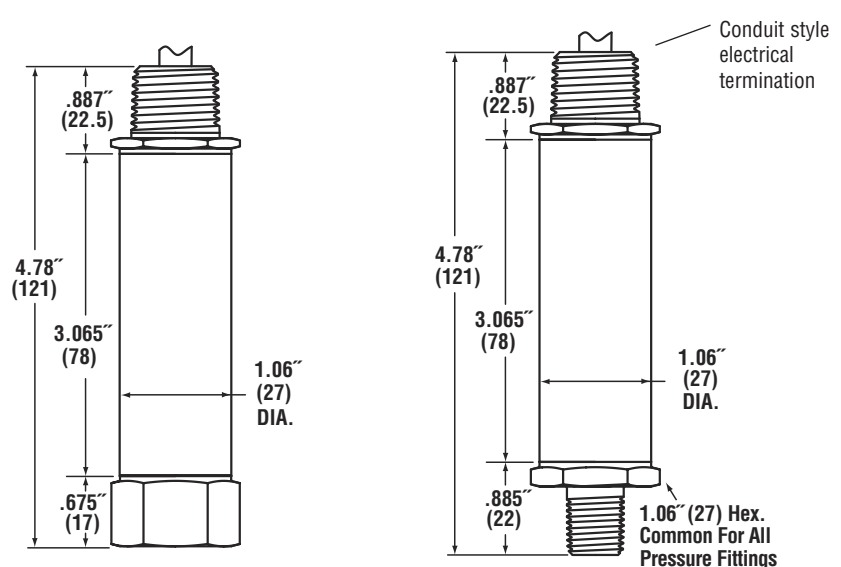

*Dimensions and construction details may vary based on product specified.

A2 PRESSURE TRANSMITTER INSTRUCTION SHEET



Mounting

The A2 transmitter requires no special mounting hardware, and can be mounted in any plane with negligible position error.

Although the unit can withstand normal vibration without damage or significant output effects, it is always good practice to mount the transducer where there is minimum vibration.

For units with NPT type pressure fittings apply Teflon® tape or an equivalent sealant to the threads before installing.

When tightening, apply a wrench to the hex wrench flats located just above the pressure fitting. **DO NOT** tighten by using a pipe wrench on the housing.

Power Supply

Output Signal	Power Supply Voltage	
	Min	Max
0-5Vdc	10V	30V
1-5Vdc	10V	30V
1-6Vdc	10V	30V
0-10V	14V	30V
4-20mA	12V*	36V

* For transmitters with 4-20mA output signal, the minimum voltage at the terminals is 12Vdc. However, the minimum supply voltage should be calculated using the following graph and formula.

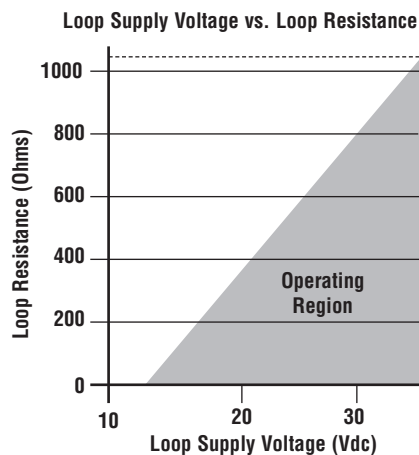

$$V_{min} = 12V + (.022A \times RL) \text{ (includes a 10\% safety factor)}$$

$$RL = RS + RW$$

RL = Loop Resistance (ohms)
RS = Sense Resistance (ohms)
RW = Wire Resistance (ohms)

Noise

For minimum noise susceptibility, avoid running the transducer's cable in a conduit that contains high current AC power cables. Where possible avoid running the cable near inductive equipment.

Shielded Cable

Units with shielded cable electrical termination, connect the drain wire to the guard terminal on the read out device or measuring instrument, if available. In all other cases connect to the ground or to the power supply negative terminal.

Sintered Metal Filter

All units less than 500 psi include a small metal sintered filter at the top of the unit. This is necessary to equalize the internal pressure with atmospheric pressure but can be a point of moisture ingress.

A2 Wiring Diagrams

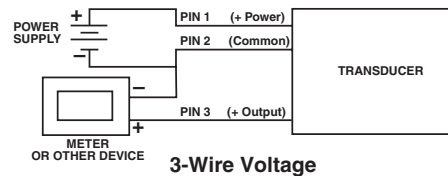
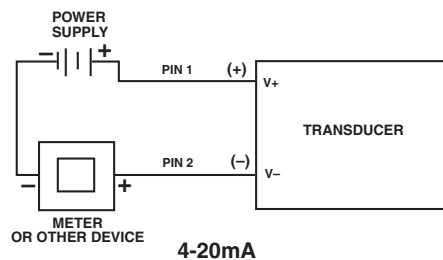

A2 transducer has internal transient protection: for safety, limit line-to-ground voltage to 36 Vdc max.

Zero and Span Adjustment

Instructions below apply to the particular configurations noted, not all A2 configurations offer Zero and Span access. While Zero adjustment is not normally necessary, it may be desirable to trim out any offset in the system. However, proper Span calibration requires a pressure standard three to five times more accurate than the accuracy of the transducer, and there may also be interaction of Span on Zero.

1. Side access zero and span adjustment (Enclosure Options "Z," "Y") A2 configurations with side access "Z" and "S" potentiometers (pots) have a black plastic access sleeve towards the elec-

trical termination end of the unit (see diagram on front page).

To gain access to the zero and span adjustment pots, slide the access sleeve upward toward the connector. On the label there is a "Z" and "S" to indicate zero and span. (Looking at the A2 vertically as in the diagram, zero is on the left and the span is on the right). Using a small trim pot adjustment tool you can adjust zero $\pm 10\%$ of full scale and span $\pm 10\%$ of full scale.

2. Top/rear access zero and span adjustment

Access to "Z" and "S" pots via the top (electrical termination end) of the unit is standard on all "S" enclosure units with 4-20mA output. Access is gained by removing the black threaded cap, once removed you will see the pots indicated by "Z" and "S"

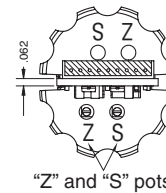

respectively as shown below. Using a small trim pot tool, you can adjust zero $\pm 10\%$ of full scale and span $\pm 10\%$ of full scale.

Recalibration Instructions:

1. Apply 0% full scale pressure.
2. Adjust the output using the zero adjust trim pot.
3. Apply 100% full scale pressure.
4. Adjust the output using the span adjustment trim pot.
5. Repeat steps 1 through 4 as necessary.

A2 PRESSURE TRANSMITTER INSTRUCTION SHEET



Pin #	Voltage Output	Current Output
A	(+) Power	(+) Power
B	(+) Output	None
C	Field Gnd.	Field Gnd.
D	(-) Power	(-) Power

Wire Color	Voltage Output	Current Output
Red	(+) Power	(+) Power
White	(+) Output	None
Black	(-) Power	(-) Power

Wire Color	Voltage Output	Current Output
Red	(+) Power	(+) Power
White	(+) Output	None
Black	(-) Power	(-) Power

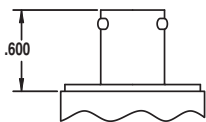
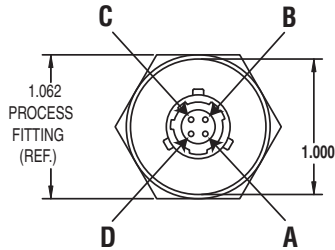

(4) PIN BENDIX STYLE
ELECTRICAL TERMINATION
SHELL SIZE 8
(B4), (H1), (L1), (P2)

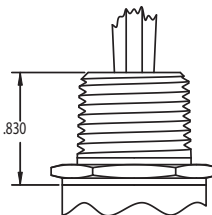
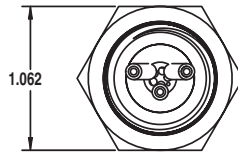

FLYING LEADS
ELECTRICAL TERMINATION
CONDUIT - 1/2 NPT MALE
(C2), (C5)

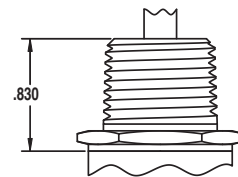
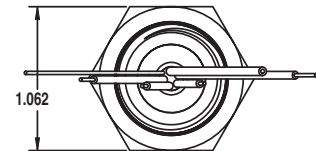

SHIELDED CABLE (PIG TAIL)
ELECTRICAL TERMINATION
CONDUIT - 1/2NPT MALE
(C1), (C6), (C7), (P7)

ELECTRICAL TERMINATIONS FOR WELDED HOUSINGS ONLY

Pin No.	Voltage Output	Current Output	Mating Cable Color
1	(+) Power	(+) Power	Red
2	(+) Output	None	White
3	Field Gnd.	Field Gnd.	Green
4	(-) Power	(-) Power	Black

Pin No.	Voltage Output	Current Output	Mating Cable Color
1	(+) Power	(+) Power	Red
2	(-) Power	(-) Power	Black
3	(+) Output	None	White
GND	Field Gnd.	Field Gnd.	Green

Pin No.	Voltage Output	Current Output	Mating Cable Color
A	(+) Power	(+) Power	Red
B	(+) Output	None	White
C	Field Gnd.	Field Gnd.	Green
D	(-) Power	(-) Power	Black

Wire Color	Voltage Output	Current Output
Red	(+) Power	(+) Power
White	(+) Output	None
Black	(-) Power	(-) Power
Green	Field Gnd.	Field Gnd.

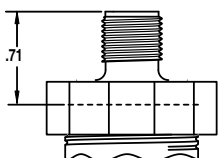
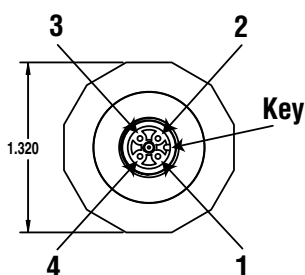

M12
ELECTRICAL TERMINATION
(EW), (E0), (E1), (E2)

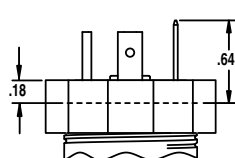
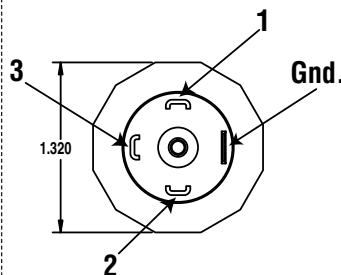

DIN 43650-A
ELECTRICAL TERMINATION
(DN), (D0), (D1), (D2)

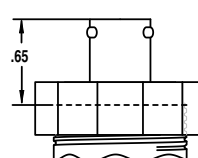
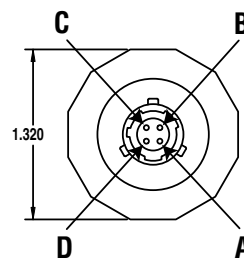

(4) PIN BENDIX STYLE
ELECTRICAL TERMINATION
SHELL SIZE 8
(B4), (H1), (L1), (P2)

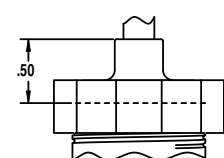
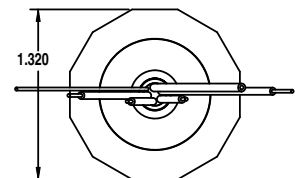

PIGTAIL
ELECTRICAL TERMINATION
PLASTIC MOLDED
(F2), (P1)

Visit our web site www.ashcroft.com

Ashcroft Inc.
250 East Main Street
Stratford, CT 06614-5145 USA
Tel: 203-378-8281 • Fax: 203-385-0402
email: info@ashcroft.com
www.ashcroft.com