

FACTORY SET (APS) MODELS ONLY

Standard Ranges – 30IMV, 15, 30, 60, 100, 200, 400, 600, 1000, 2000 psi

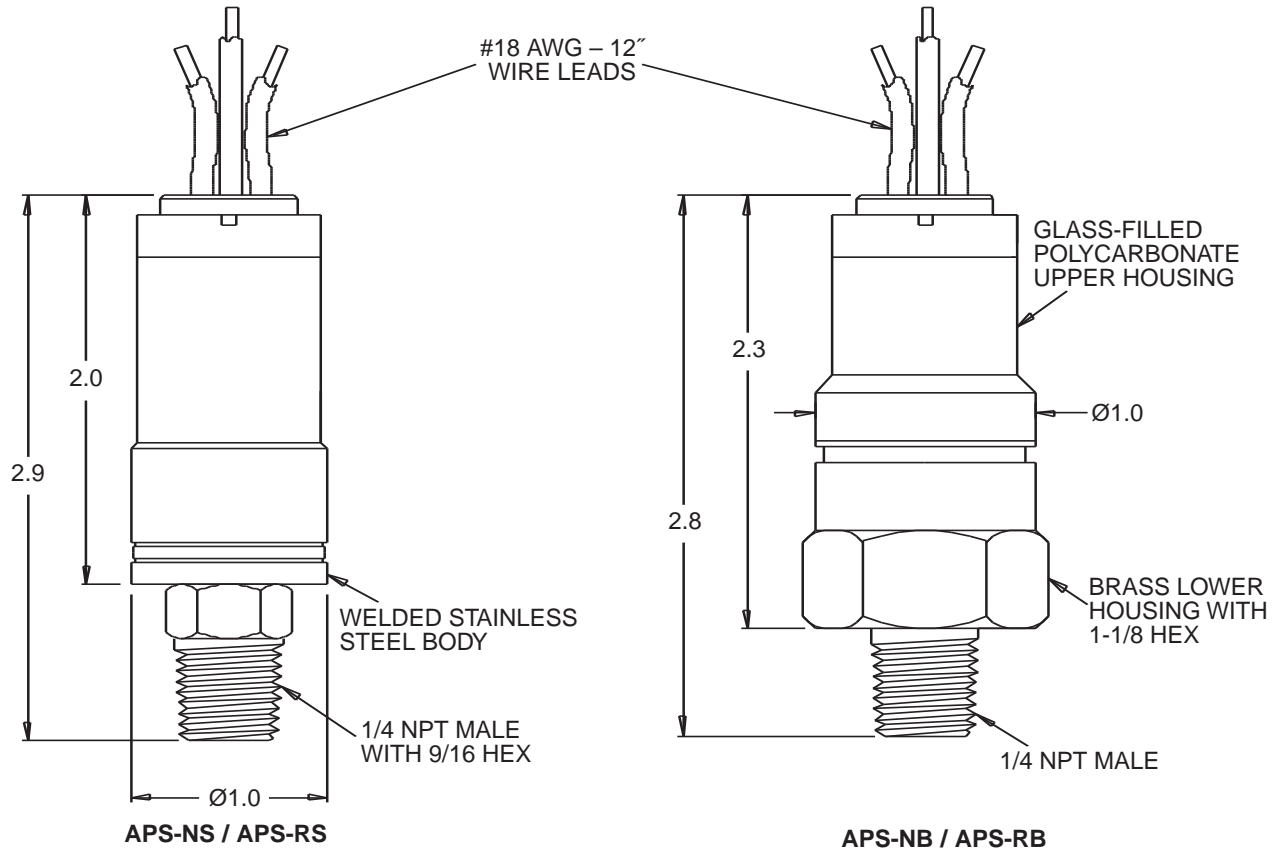

INTRODUCTION

The APS pressure switch features an all-welded stainless steel body (APS-NS/RS) or a machined brass pressure connection combined with a durable glass-filled polycarbonate upper housing (APS-NS/RB). Located inside the upper housing lies one (D/M) or two (DD/MM) SPDT general purpose or gold contact snap acting switches. The deadband is fixed and the setpoint is factory set. The APS pressure switch is supplied with various pressure connections and electrical terminations.

INSTALLATION

Torque should always be applied to the hex portion of the body when installing, never to any other part of the body for it may alter the setpoint. It is recommended that Teflon tape or other sealant be used on the threads prior to installing to prevent leaks in the system.

ELECTRICAL CONNECTION

The APS pressure switch is available with many various electrical

connections; wire leads (L), screw terminals (S), spade terminals (T) and a Form C DIN connector (H). Contact factory for other special connection requirements.

When furnished with wire leads, the wires are color coded. (White-Common, Blue-Normally Open, Red-Normally Closed.)

Refer to figure below for identification of terminals for screw, spade and DIN connections.

When furnished with a DIN connector the terminal block of the connector can be removed by first removing the screw from the center of the connector, then pushing out the terminal block through the hole in the top of the connector to force it out the bottom. Attach wires to the terminal block then insert terminal block back into housing.

Make all connections according to the figures below and circuit requirements.

Note: Since vacuum models are already above the setpoint at atmosphere, the Common and Normally Open (NO) circuit will be closed as received.

**Installation and Maintenance Instructions
for ASHCROFT® A-Series Miniature
Pressure Switches**

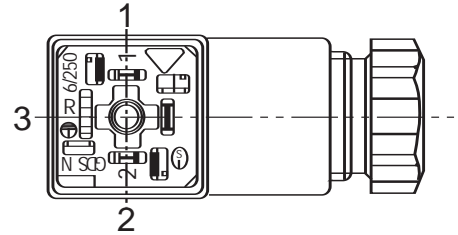
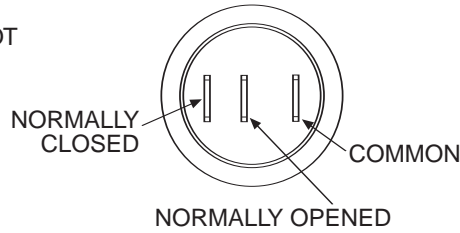
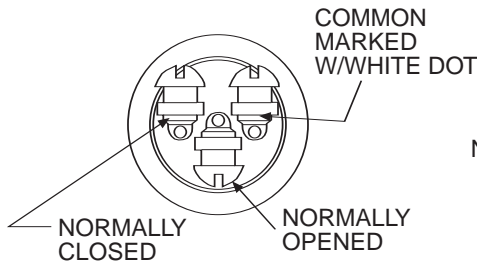

- 1 – COMMON
- 2 – NORMALLY CLOSED
- 3 – NORMALLY OPEN

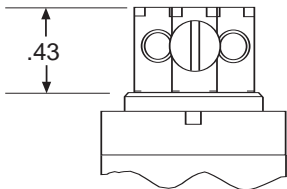

SCREW TERMINALS

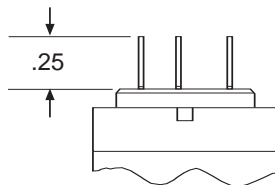

SPADE TERMINALS

**FORM "C"
DIN CONNECTOR**

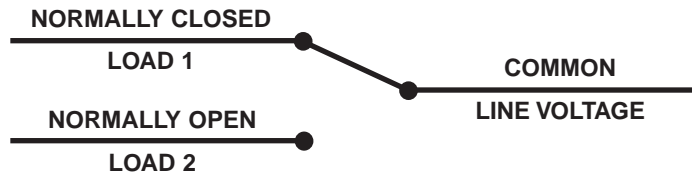

WIRING DIAGRAM

OTHER OPTIONS

AVAILABLE IN
BOTH BRASS AND
STAINLESS STEEL

