



ADT760 Automatic Handheld Pressure Calibrator



Additel 760 Automatic Handheld Pressure Calibrator

—————User Manual

Latest version at www.additel.com

[Version:2005V05]

Additel Corporation

STATEMENT

This user manual provides operating and safety instructions for the ADT760 Automatic Handheld Pressure Calibrator. To ensure correct operation and safety, please follow the instructions in this manual. Additel Corporation reserves the right to change the contents and other information contained in this manual without notice.

CONTENT

Welcome	1
How to Contact Additel.....	1
Safety Information	2
1. Introduction	5
1.1 Model Information	5
1.2 Basic Structure	6
1.3 Features.....	8
1.3 Features.....	8
1.4 Technical Specification	9
1.4.1 General Specification	9
1.4.2 Environment Specification	10
1.4.3 Electrical Specification	11
1.4.4 Internal Modules Specification	11
1.5 Power	14
1.6 Standard Equipment	15
2. Get Started	17
2.1 Battery.....	17
2.2 Internal Pressure Module.....	20
2.3 Starting the Calibrator.....	21
2.4 Electric Connections.....	21

2.5 Pressure Connection	23
3. Operation	24
3.1 Display and Operation.....	24
3.1.1 Main Screen	24
3.1.2 Pressure Unit.....	26
3.1.3 Pressure Output	27
3.1.4 Current/Voltage Measurement.....	32
3.1.5 Mechanical Switch	34
3.1.6 NPN /PNP Switch.....	35
3.1.7 Current Output.....	36
3.1.8 External Pressure Module	38
3.2 HART (Only available on 760-X-DL)	40
3.2.1 Poll.....	40
3.2.2 Operation Window.....	42
3.2.3 Settings.....	43
3.2.4 Service	46
3.2.5 Process	49
3.3 Zeroing	50
3.4 Vent	50
4. Typical Applications.....	51
4.1 Pressure Gauge (Includes dial and digital pressure gauges)	52
4.2 Current / Voltage Transmitter	54

4.3 HART Transmitter	56
4.4 Pressure Switch	58
4.5 I/P Converter	60
4.6 Documenting.....	62
5. Setup	64
5.1 Control Settings.....	64
5.2 24V Power	64
5.3 Communication	65
5.4 Head Correction	65
5.5 Services	67
5.5.1 Calibration	67
5.5.2 Diagnosis	72
5.5.3 System Log	72
5.5.4 Maintenance	73
5.5.5 Factory Reset.....	73
5.5.6 Updates	73
5.6 Sound	74
5.7 Personalization	74
5.7.1 Date and Time	74
5.7.2 Language	74
5.7.3 Theme	75
5.7.4 Safety Data	75

5.8 Power Management.....	75
5.9 System Information.....	76
6. Task (Only available on 760-X-DL).....	77
6.1 New Task.....	77
6.1.1 Dial Pressure Gauge.....	78
6.1.2 Digital Pressure Gauge.....	79
6.1.3 Pressure Transmitter (Current, Voltage, HART).....	80
6.1.4 Pressure Switch.....	81
6.1.5 I/P Converter.....	82
6.2 Task Execution.....	83
6.2.1 Dial Pressure Gauge.....	83
6.2.2 Digital Pressure Gauge.....	85
6.2.3 Pressure Transmitter (Current, Voltage, HART).....	87
6.2.4 Pressure Switch.....	89
6.2.5 I/P Converter.....	90
6.3 Task Delete.....	91
6.4 End of Task.....	92
7. Data Logger (Only available on 760-X-DL).....	93
8. Application.....	95
8.1 Leak Test.....	95
8.2 Pressure Unit Converter.....	96
9. Service.....	97

9.1 Inlet Port Filter	97
9.2 Pressure Outlet Port Filter and O-ring (Same as REF port)	98
Appendix 1: SCPI List.....	99
A1.1 IEEE488.2	99
A1.2 Measurement and configuration	101
A1.3 Output.....	107
A1.4 Calculation	110
A1.5 System.....	111
A1.6 Status	118
A1.7 Unit	119
A1.8 Data Record.....	120
A1.9 HART	123
Appendix 2: Unit	127
Appendix 3: Software.....	129
A3.1 Additel ACal	131
A3.2 Additel PCal.....	134
A3.3 Additel Land.....	139
A3.4 Additel Log II	142
A3.5 How to install ADT760 Driver by using Zadig	145

Table Content

Table 1 Symbols.....	4
Table 2 Model Information.....	5
Table 3 Basic Structure.....	7
Table 4 Electrical Specification.....	11
Table 5 Selection Guide-Differential Pressure.....	13
Table 6 Selection Guide-Gauge Pressure.....	14
Table 7 Standard Equipment.....	15
Table 8 Electric Connections.....	22
Table 9 Pressure Output Control Settings.....	27
Table 10 Auto Step.....	30
Table 11 Min / Max / Avg.....	33
Table 12 Scale.....	33
Table 13 External Pressure Module Information.....	39
Table 14 HART Device Information.....	43
Table 15 ART device sensor information.....	44
Table 16 HART Device Output.....	45
Table 17 HART Device Variable.....	49
Table 18 Pressure Gauge Test Settings.....	52
Table 19 Current / Voltage Transmitter Test Settings.....	54
Table 20 HART Device Test Settings.....	56

Table 21 Pressure Switch Test Settings.....	58
Table 22 I/P Converter Test Settings	61
Table 23 Test Information.....	62
Table 24 Test Save Options.....	63
Table 25 Communication Settings.....	65
Table 26 Head Pressure Correction.....	66
Table 27 Date and Time Settings.....	74
Table 28 Power Management	75
Table 29 Dial Pressure Gauge Information Settings	78
Table 30 Pressure Transmitter Information Settings.....	80
Table 31 Pressure Switch Information Settings.....	81
Table 32 I/P Converter Information Settings.....	82
Table 33 Dial Pressure Gauge Task Settings	83
Table 34 Digital Pressure Gauge Task Settings	85
Table 35 Pressure Transmitter Task Settings	87
Table 36 Pressure Switch Task Settings	89
Table 37 I/P Converter Task Settings	90
Table 38 Task Save Operation.....	92
Table 39 Data Logger Setup.....	94
Table 40 Data Logger Chart	94
Table 41 Leak Test	95

Figure Content

Figure 1 Basic Structure	6
Figure 2 Standard Equipment.....	16
Figure 3 Battery Install and Charging	18
Figure 4 Internal Pressure Module Switching	20
Figure 5 Electric Connection	21
Figure 6 Pressure Connection	23
Figure 7 Main Screen	25
Figure 8 Output Connection.....	28
Figure 9 Current / Voltage Measurement	32
Figure 10 Mechanical Switch Measurement.....	34
Figure 11 Electrical Switch Measurement.....	35
Figure 12 Current Output.....	36
Figure 13 External Pressure Module Connection.....	38
Figure 14 HART Device (Internal Power, Internal Resistor)	40
Figure 15 HART Device (External Power, External Resistor).....	41
Figure 16 Jog Function	52
Figure 17 Barometer Sensor Calibration	71
Figure 18 Inlet Port Filter	97

Figure 19 REF and Outlet Port Filter.....	98
---	----

Welcome

The Additel 760 Automatic Handheld Pressure Calibrator is a hand held controller, as well as a documenting process calibrator, all rolled into one with high precision and control stability. Each unit comes with an internal pressure module ranged to cover the full scale range of the unit. The internal module is located at the back of the calibrator and is removable allowing for the selection of lower range pressure to improve accuracy. In addition, the calibrator can work with two external pressure modules at the same time. With high precision electrical signal measurement function, this calibrator can be used for dial pressure gauges, digital pressure gauges, differential pressure gauges, pressure transmitters, I/P converters, or pressure switch calibration. For the most up-to-date manual, please visit www.additel.com.

How to Contact Additel

Additel Corporation

Phone: +1-714-998-6899

Fax: +1-714-998-6999

E-mail: sales@additel.com or service@additel.com

Website: www.additel.com

Safety Information

WARNINGS identify action or condition that may be hazards to the user;

CAUTIONS identify action or condition that may damage the calibrator or the equipment under test.

WARNINGS:

To prevent personal injury, please follow this user manual.

To prevent possible electrical shock, fire, or personal injury, please:

- ◆ Check product exterior before use
- ◆ Read and follow all instructions carefully
- ◆ Do NOT apply more than 30V AC or DC between any two electric jacks
- ◆ Correctly place and lock the battery before use
- ◆ Avoid close contact to the vent port when venting
- ◆ Charge the battery immediately with supplied power adapter when the low battery indication occurs. This will prevent potential pressure release due to a loss of electrical power
- ◆ Do NOT use the product if it is damaged or operates incorrectly
- ◆ Do NOT use in flammable, high humidity, or dusty environments
- ◆ Only use accessories, test leads, and probes that have the same measurement specification

CAUTIONS:

- ◆ Do NOT shake, drop, or bump the calibrator while in use
- ◆ If condensation occurs, thoroughly dry out the calibrator before startup
- ◆ Do NOT use any power adapter other than 9816-X
- ◆ Charge the battery immediately when low battery symbol indicates
- ◆ Do not remove the battery while it is in charging or when the calibrator is in use
- ◆ Release the system pressure before turning off the calibrator

Product Symbols Table 1.





Symbol	Meaning
	Important information Danger See user manual
	Risk of electrical shock Hazardous voltage
	Conforms to European Union directives
	Please recycle
	Lithium-ion battery

Table 1 Symbols

1. Introduction

1.1 Model Information

Model	Model No.	Pressure Range	Pressure Type
Low Differential Pressure	LLP	± 30 inH ₂ O (± 75 mbar)	D, G
Differential Pressure	D	-12.5 to 35 psi (-0.86 to 2.5 bar)	D, G
General Pressure	MA	-12.5 to 300 psi (-0.86 to 20 bar)	G, A

Table 2 Model Information

NOTE: D - Differential; G - Gauge; A - Absolute.

1.2 Basic Structure

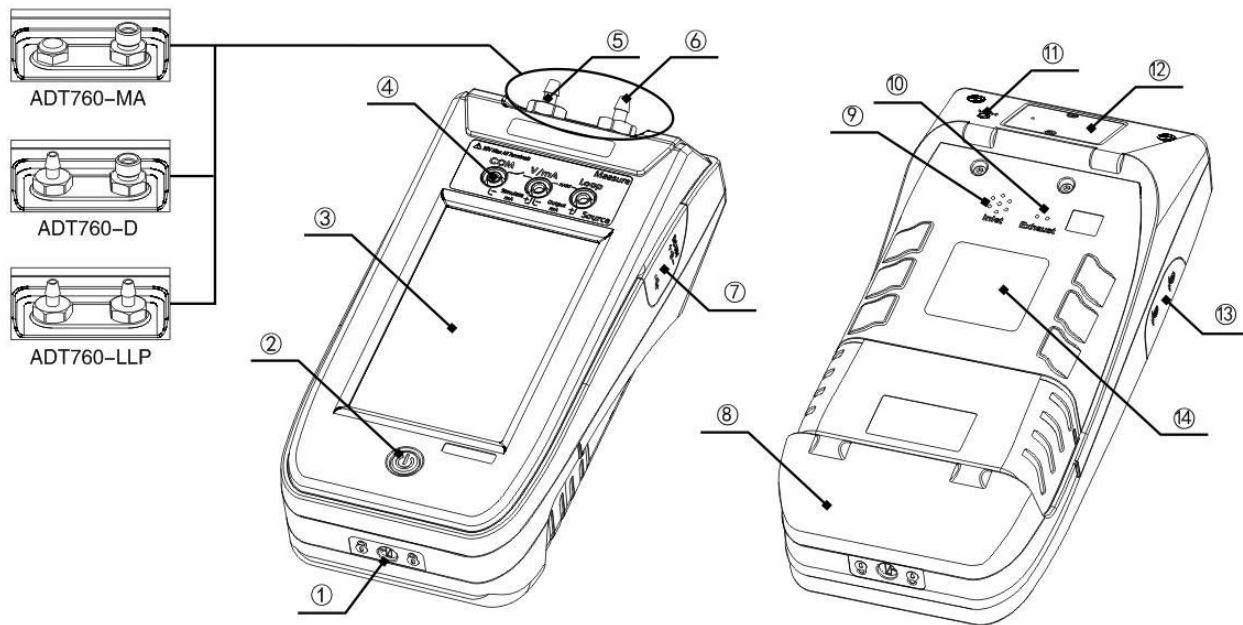
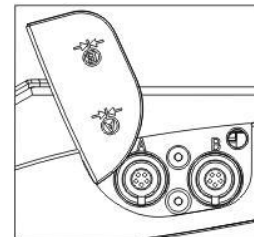
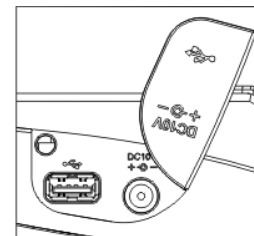
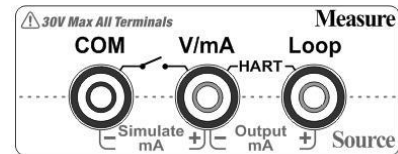

Figure 1 Basic Structure

No.	Name
(1)	Battery Lock
(2)	Power Switch
(3)	Touch Screen
(4)	Electrical Measurement Panel
(5)	REF Port (-MA: Barometer Sensor Calibration Port)
(6)	Pressure Outlet Port
(7)	Power Adapter and USB Port Panel
(8)	Battery
(9)	Inlet Port
(10)	Exhaust Port
(11)	VENT Port
(12)	Internal Pressure Module
(13)	External Pressure Module Connection Ports (A & B)
(14)	Product Nameplate

Table 3 Basic Structure



1.3 Features

- ◆ Fully automatic calibrator with built-in pump and controller
- ◆ Switchable internal pressure modules for expandable ranges
- ◆ Accuracy (1 year) of 0.02%FS
- ◆ External pressure modules available (measurement only)
- ◆ Less than 4 lbs. (1.8 kg) for handheld operation
- ◆ Source pressure, measure pressure and measure electrical
- ◆ 4 channels
- ◆ Optional HART communication
- ◆ Optional data logging and documentation
- ◆ USB, Wi-Fi, and Bluetooth communications

1.3 Features

1.4 Technical Specification

1.4.1 General Specification

- ◆Media: Clean Air
- ◆Internal module temperature compensation range: 32 ~ 122°F (0 ~ 50°C)
- ◆Stability: 0.005%FS or 0.05 pa whichever is greater, based on FS of the switchable internal pressure module.
- ◆Display: 5 inch 480 x 800 TFT color touch screen
- ◆Size: 9.37" x 4.33" x 2.76" (238mm x 110mm x 70mm)
- ◆Weight: less than 4 lbs. (1.8 KG)
- ◆Connection:
 - 1) -LLP:
 - Two Barb fittings
 - 2) -D:
 - One Barb fitting
 - One Hose, 5 ft (1.5m), with built-in filter to 1/4 BSPF, 1/4 NPTF, and M20F adapters
 - 3) -MA:
 - One Hose, 5 ft (1.5m), with built-in filter to 1/4 BSPF, 1/4 NPTF, and M20F adapters
 - One barometer sensor calibration port

NOTE: Filters are installed in the pressure connection ports. By passing the filter will void the product warranty.

-
- ◆ Inlet filter: Dedicated filter, 50 μ m
 - ◆ Electrical Measuring Jacks: Φ 4 mm electrical jacks
 - ◆ USB: Standard USB port, type A
 - ◆ External Pressure Module Port: Two 5-pin connections (A & B)

1.4.2 Environment Specification

- ◆ Working Temperature: 32 ~ 122°F (0 ~ 50°C)
- ◆ Storage Temperature: -4 ~ 158°F (-20 ~ 70°C)
- ◆ Humidity: 0 ~ 90% (32 ~ 122°F or 0 ~ 50°C), Non condensation
- ◆ Atmosphere Pressure: Less than 9,800 ft. (3,000 m)
- ◆ Protect Level: IP54

1.4.3 Electrical Specification

Signal Type	Range	Resolution	Accuracy	Note
Current Measurement	±30 mA	0.0001 mA	±(0.01%RD + 0.005%FS)	Input : <10 Ω
Voltage Measurement	±30 V	0.0001 V	±(0.01%RD + 0.005%FS)	Input : >1M Ω
Current Output	24 mA	0.001 mA	±(0.01%RD + 0.005%FS)	20 mA @ 1K
Loop Power Source	24 V	N/A	±1 V	Max Load: 50 mA
Pressure Switch	Open, close. Support for mechanical switch and NPN / PNP digital switches.			
Temperature Compensation	41°F to 95 °F (5°C to 35 °C)			
Temperature Coefficient	<(±0.001%RD + 0.001%FS) / °C outside of 5°C to 35 °C			

Table 4 Electrical Specification

1.4.4 Internal Modules Specification

Selection Guide-Differential Pressure								
Module	Module Range ^[5]		Media	Accuracy (%FS) ^[1]	Burst Pressure	760-LLP	760-D	760-MA
	inH2O	mbar						
DP025	±0.25	±0.62	G	0.2 ^[2]	100x	•		
DP050	±0.5	±1.25	G	0.1 ^[3]	100x	•		
DP1	±1	±2.5	G	0.05 ^[4]	100x	•		
DP2	±2	±5	G	0.05 ^[4]	100x	•		
DP5	±5	±10	G	0.05 ^[4]	50x	•		
DP10	±10	±25	G	0.05 ^[4]	20x	•	•	
DP20	±20	±50	G	0.05	20x	•	•	
DP30	±30	±75	G	0.05	20x	•	•	
DP50	±50	±160	G	0.05	3x		•	
DP100	±100	±250	G	0.02	3x		•	
DP150	±150	±350	G	0.02	3x		•	
DP300	±300	±700	G	0.02	3x		•	
DP400	-380 to 400	-950 to 1K	G	0.02	3x		•	
DP800	-380 to 800	-950 to 2K	G	0.02	3x		•	
DP1K	-380 to 1K	-950 to 2.5K	G	0.02	3x		•	

Table 5 Selection Guide-Differential Pressure

[1] FS specification applies to the span of the module range. Accuracy includes one-year stability, except for DP025 to DP10 modules.

[2] Accuracy is a 6 months spec, 1-year long-term drift is 0.2%FS.

[3] Accuracy is a 6 months spec, 1-year long-term drift is 0.1%FS.

[4] Accuracy is a 6 months spec, 1-year long-term drift is 0.05%FS.

[5] The low module pressure range may be outside the pressure range of the calibrator

Selection Guide-Gauge Pressure								
Module	Module Range ^[3]		Media	Accuracy (%FS) ^[1]	Burst Pressure	760-LLP	760-D	760-MA
	psi	bar						
CP10	±10	±0.7	G	0.02 ^[2]	3x		•	•
CP15	-13.5 to 15	-0.95 to 1	G	0.02 ^[2]	3x		•	•
CP30	-13.5 to 30	-0.95 to 2	G	0.02 ^[2]	3x		•	•
CP35	-13.5 to 35	-0.95 to 2.5	G	0.02 ^[2]	3x		•	•
CP50	-13.5 to 50	-0.95 to 3.5	G	0.02 ^[2]	3x			•
CP100	-13.5 to 100	-0.95 to 7	G	0.02 ^[2]	3x			•
CP150	-13.5 to 150	-0.95 to 10	G	0.02 ^[2]	3x			•
CP200	-13.5 to 200	-0.95 to 14	G	0.02 ^[2]	3x			•

CP300	-13.5 to 300	-0.95 to 20	G	0.02 ^[2]	3x			•
-------	--------------	-------------	---	---------------------	----	--	--	---

Table 6 Selection Guide-Gauge Pressure

[1] FS specification applies to the span of the module range. Accuracy includes one-year stability, except for DP025 to DP10 modules.

[2] Specification based on gauge measurement. An additional 60 pa uncertainty will need to be included when measuring in absolute mode. Applicable only for use with the ADT760-MA

[3] The low module pressure range may be outside the pressure range of the calibrator

1.5 Power

- ◆ Power Supply: Power supplied by rechargeable Li-Ion battery or an external 10 V power adapter
- ◆ Li-Ion rechargeable battery is removable and can be charged directly using the external power adapter
- ◆ The battery should be removed from the calibrator and charged directly for the fastest charge time
- ◆ Charge Time: Full charge, less than 4 hours when removed from the calibrator and charged directly
- ◆ The charging time will be extended when battery is charged through calibrator
- ◆ Battery Working Time: More than 10 hours or 100 cycle of full scale pressure

1.6 Standard Equipment

Model	Quantity	-LLP	-D	-MA
760 Calibrator	1	•	•	•
9724 Rechargeable Li-ion Battery	1	•	•	•
9816-X External Power Adapter	1 pc	•	•	•
9025 Test Leads	1 set (2 red, 1 black)	•	•	•
Alligator Clip	2 sets (2 red, 1 black for each set)	•	•	•
Silicone Tube	Depends on 760 model	• (2 pcs)	• (1 pc)	
ADT100 Hose	1 pc		•	•
ADT100-760-KIT Adapter Set	1 set (1/4BSPF, 1/4NPTF, and M20F)		•	•
Barb Fitting Adapter	1 pc		•	
O-ring	1 pack	•	•	•
Filter for Outlet Port	2 pcs	•	•	•
Filter for Inlet Port	2 pcs	•	•	•
CD Manual	1 pc	•	•	•
NIST-Traceable Certificate	1 pc	•	•	•

Table 7 Standard Equipment

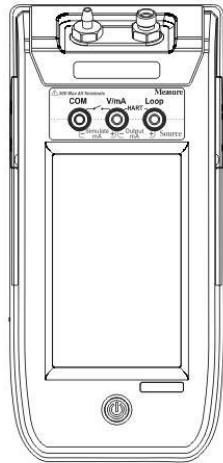

760 Calibrator



9724 Rechargeable
Li-ion Battery

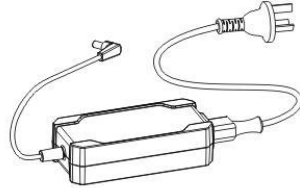

9816-X External Power Adapter



ADT 100-760-KIT Adapter Set
(1/4 BSPF, 1/4 NPTF, M20F)



Filter for
Inlet Port



9025 Test Leads



ADT 100 Hose



Alligator Clip
x 2 Sets



Silicone Tube



O-ring



Filter for
Outlet Port

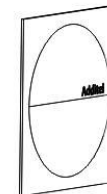

CD Manual



Barb Fitting
Adapter

Figure 2 Standard Equipment

2. Get Started

2.1 Battery

WARNINGS:

- ◆ Lithium-ion batteries may get hot or ignite and cause serious injury if not treated properly
- ◆ Do NOT incinerate or heat the battery
- ◆ Do NOT storage the battery in direct sunlight
- ◆ Do NOT try to disassemble the battery
- ◆ The battery contains dangerous chemical substances
- ◆ Please clean with water and look for medical treatment if exposure to chemicals occurs
- ◆ Continuously charging the battery of this unit will significantly reduce the life of the battery

CAUTIONS:

- ◆ Please remove the battery and store in a cool, dry, ventilated area if it will not be used for a long period
- ◆ Do not store batteries with hazardous or combustible materials
- ◆ Discontinue use and contact Additel or an authorized distributor immediately if the battery leaks
- ◆ Do not short circuit the battery
- ◆ Only use the dedicated power adapter (9816-X) to charge the battery
- ◆ Be sure to properly dispose of the battery if it is no longer usable

The Additel 760 Automatic Handheld Pressure Calibrator uses a dedicated rechargeable, Li-Ion battery (model 9724). Each battery has a built-in protection circuit allowing the battery to be charged independent of being attached to the calibrator.

Each battery contains an illuminated charge indicator. Push  button to see the level of charge. The battery is fully charged when 5 blue LEDs are illuminated.

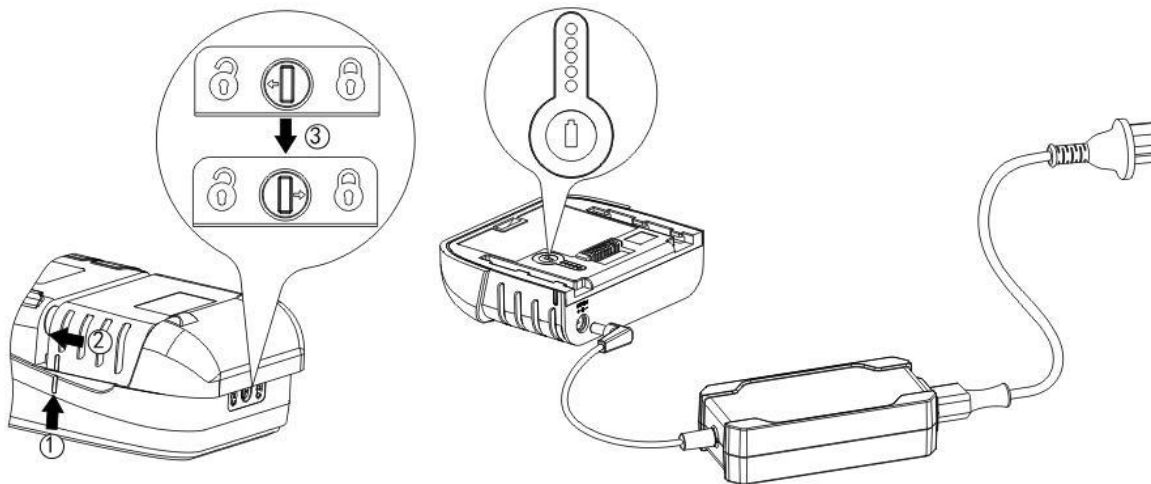

Figure 3 Battery Install and Charging

◆ To Install the battery:

- 1) Align to alignment markings of the calibrator and battery
- 2) Push the battery
- 3) Use a flat-head screwdriver to lock the battery

-
- ◆ To Remove the battery:
 - 1) Turn off the calibrator
 - 2) Turn the battery lock to the unlock position with a flat-head screwdriver
 - 3) Remove the battery
 - ◆ 9816-X External Power Adapter:
 1. Input: AC 85V ~ AC 265V, 50Hz / 60Hz
 2. Output: DC 10V, 2A, 40W MAX

2.2 Internal Pressure Module

The Additel 760 Calibrator comes with an internal pressure module which covers the full span of the unit. This pressure module is user-switchable and Additel offers a large variety of different range pressure modules.

◆ To switch the internal pressure module:

- 1) VENT the system pressure (see section 5.5.3)
- 2) Turn off the calibrator, disconnect the power adapter if it is connected, and remove the battery
- 3) Unscrew both screws on the pressure module until the screw pin is loose and the screw pin can be extended out
- 4) Firmly pull the sensor out of the calibrator
- 5) Insert a new internal pressure module (please pay attention to module direction)
- 6) Tighten both screws on the pressure module until the screws reach the bottom

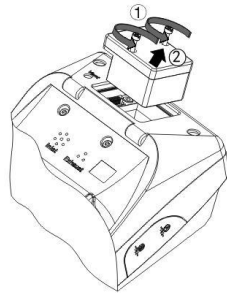

Disassembly

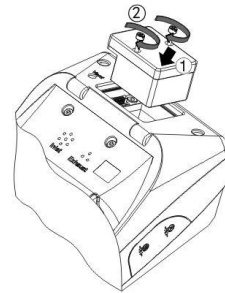

Installation

Figure 4 Internal Pressure Module Switching

2.3 Starting the Calibrator

Push the power button to turn on the calibrator. The display will illuminate and the Additel logo will display. It will take a few seconds for the operating system to load after which the main screen will display.

- ◆ Date and Time: To change date and time setting, please see section 5.7.1
- ◆ Language: The default language is English. To change the language please refer to section 5.7.2

2.4 Electric Connections

Electric connection instruction:

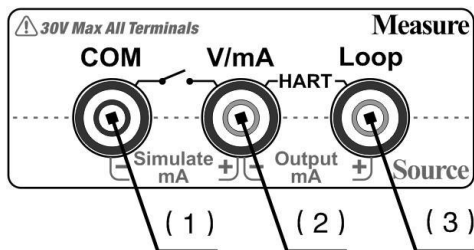

Figure 5 Electric Connection

Main Jacks			Power Supply Jack	
Function	Black (1)	Red (2)	Red (3)	Function
±30 V Voltage	●	○		
±30 mA Current	●	○		
2-wire 4 ~ 20 mA Loop Transmitter		○	○	
3-wire Voltage/Current Transmitter	●	○	○	Non-isolated 24 V power output
Mechanical Switch	●	○		
NPN/PNP Switch	●	○	○	Non-isolated 24 V power output
HART Transmitter (Internal resistor, Internal power supply)		○	○	
HART Device (External resistor, External power supply)		○	○	
0~20 mA Loop Current Output (Internal power supply)		○	○	
0~20 mA Loop Current Output (External power supply)	●	○		

Table 8 Electric Connections

2.5 Pressure Connection

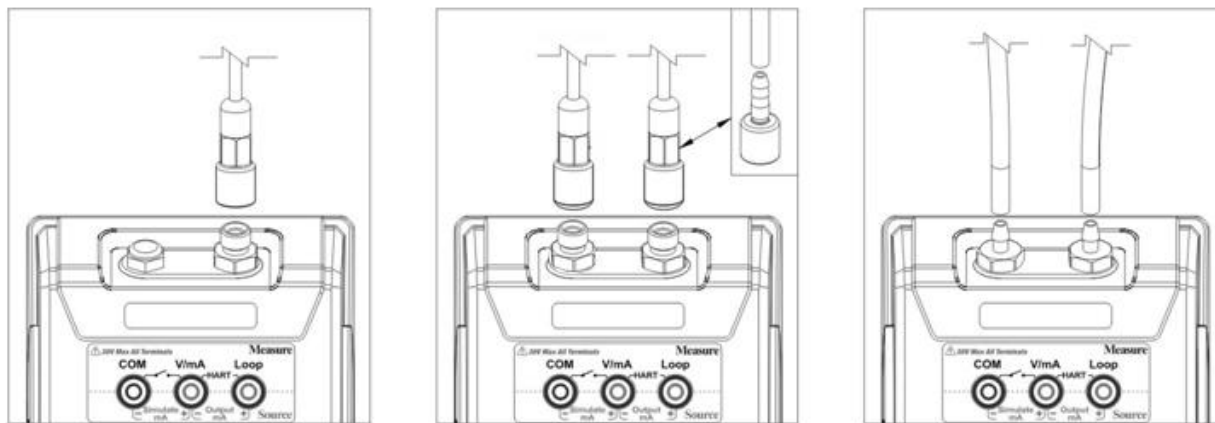





Figure 6 Pressure Connection

3. Operation



3.1 Display and Operation

3.1.1 Main Screen

The main screen normally contains the Status Bar, Title Bar, Electrical Measurement Window, Pressure Window, and Control Bar.

① Status Bar: Includes date and time, external pressure module status , communication status , 24V internal power status , and battery status .

NOTE: Information on Status Bar is read only. All other icons, pressure units, and output values can be selected for further operation.

② Title Bar: Includes screen lock , abnormal notification , and system menu: .



◆ Abnormal notification sign  can be cleared by rebooting the calibrator. Specific information about the abnormal condition can be reviewed in the system log, please see section 5.5.3.

③ Electrical Measurement Window: Includes measurement value, data analysis (current/voltage measurement and transmitter test only), current output step (current output only), and loop current value (transmitter test only).

④ Pressure Window: Includes pressure set point value , current pressure value, pressure unit, step control, and step size.

⑤ Control Bar: Including Vent, Measure, and Control button.

◆ Do not point the VENT port toward personal during venting

- ◆ When using one or two external pressure modules, the main screen will add additional windows to display the added module or modules
- ◆ Every window can be collapsed
- ◆ Press  on the top right corner of the window and select collapse
- ◆ Press  on the top right corner of a collapsed window and select expand to open that window

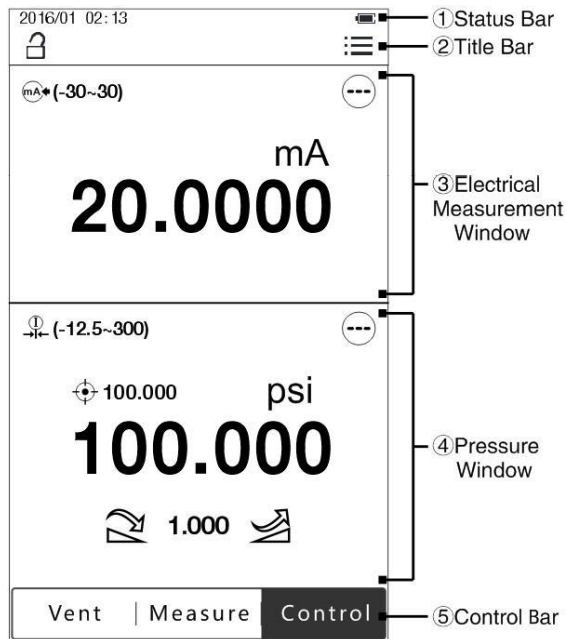



Figure 7 Main Screen

3.1.2 Pressure Unit

Press the pressure unit on Pressure Window to change system unit. There are 25 default pressure units which can be selected: kPa, Pa, MPa, hPa, bar, mbar, torr, atm, psi, gf/cm², kgf/cm², inH₂O@4°C, inH₂O@68°F, mmH₂O@4°C, mmH₂O@20°C, ftH₂O@4°C, ftH₂O@68°F, inHg@0°C, mmHg@0°C, mtorr, lb/ft², tsi, psf, inH₂O@60°F, ftH₂O@60°F.

In addition, there are 5 customizable pressure units which can be set up.

◆ To set up a custom pressure unit:

1) Press  in pressure unit selection screen and set up three parameters:

①Factor: This is the multiplier against the reference pressure unit.

②Unit Name: Custom unit name.

③Reference: Reference pressure unit, should be selected from one of the 25 default pressure units.

◆ The calculation equation is: Factor * Unit Name = Reference

For example:

Factor	Unit Name	Reference
2	USER1	1*kPa

In this way, 1 USER1 pressure equals to 0.5 kPa.

3.1.3 Pressure Output

1. Pressure Output Control Settings:

Press  on the Pressure Window to enter the control settings menu:

Subject	Valid Value	Comment
Pressure Type	Diff. / Gauge / Absolute	The pressure type displayed will depend on the ADT760 model
Resolution	4 / 5 / 6	Display digit
Slew Rate	0~100%	Pressurization speed, depends on internal pressure module
Stability Limit	$\pm (0.003\sim 1) \% FS$	Pressure control stability condition
Vent Limit	Depends on 760 model	Pressure at which the vent valves will open to atmosphere
Auto Zero	On / Off	Pressure measurement will auto zero every time the unit is vented (not available with all models)
Set Point Limits	On / Off	Limits the pressure output ranges
Set Point Limits (on)	Depends on internal pressure module	User editable for 0% and 100% of span ranges
Module Information	N/A	Information is read only and includes range, pressure type, accuracy, SN, version, and manufacture date
Running Information	N/A	Information is read only and includes supply pressure, vacuum pressure, and atmosphere

Table 9 Pressure Output Control Settings

2. Connection:

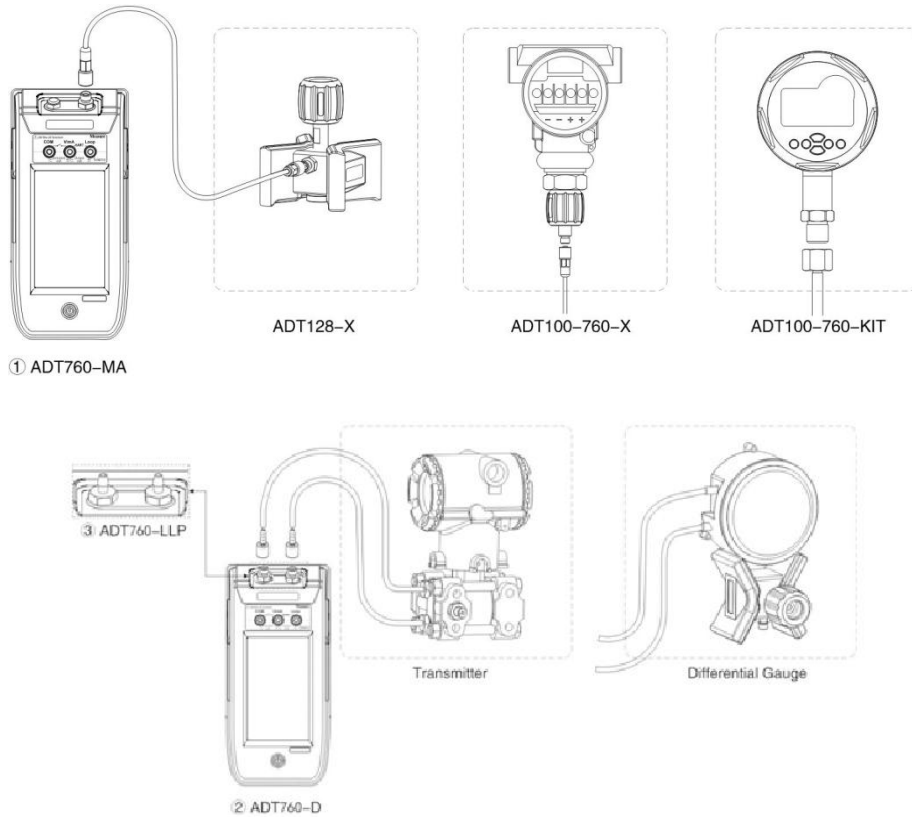



Figure 8 Output Connection



3. Pressure Set Point:



① Manual Input:

- 1) Press pressure set point value or current pressure value on the Pressure Window and input the target pressure.
- 2) Press the enter key or  .

NOTE: Pressure set point should not exceed pressure range limit shown above the keyboard.

② Manual Step:

- 1) Press step size on the Pressure Window and input the target step size.
- 2) Press  /  to decrease or increase pressure by the target step size.

③ Auto Step: Press  on Pressure Window, then select  Auto Step:

1) Auto Step settings:





Subject	Valid Value	Comment
Range	Depends on internal pressure module	The start and end points of auto step
Step Mode	By  Points/ %Percent /  Size	Calculation method for pressure change of each step
 Points	Pressure change of each step = Range ÷ Points	Pressure change calculation
%Percent	Pressure change of each = Range × Percent ÷ 100	
 Step Size	Pressure change of each = Step Size	
Stroke	Round Trip / One Way	Auto Step stroke type
Dwell Time	0~100,000,000 (s)	Retention time after each step
Repeat	1 / +∞	Repeating criteria

Table 10 Auto Step

2) Press  , then select Start.

4. Discontinue Control or Pressurization:

◆ Manual Input and Manual Step:

Press Measure to pause and press Control to restart.

Press Vent and the pressure will decrease and release.

◆Auto Step:

Press Pause to pause.

Press Exit to exit and the calibrator will release the pressure.

Press Vent to release the pressure then press Exit to stop the test or Continue to resume the test.

5. Pressure Stabilization:

If the difference between current output pressure value and set point is smaller than Stability Limit, the current pressure value on the Pressure Window will turn to green with a beep to indicate the output pressure has reached the set point stability criteria.

3.1.4 Current/Voltage Measurement

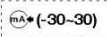
1. Press on Electrical Measurement option () on the top left corner of Electrical Measurement Window and select: (-30~30) mA or (-30~30) V.

- ◆ Do not apply current / voltage that exceeds current / voltage measuring range
- ◆ Apply a short circuit to zero
- ◆ If the measurement value falls outside of the current/voltage measuring range, then it will turn red with an alarm
- ◆ If measure value exceeds measure limit of the calibrator, it will display "-----" with alarm

2. Connection

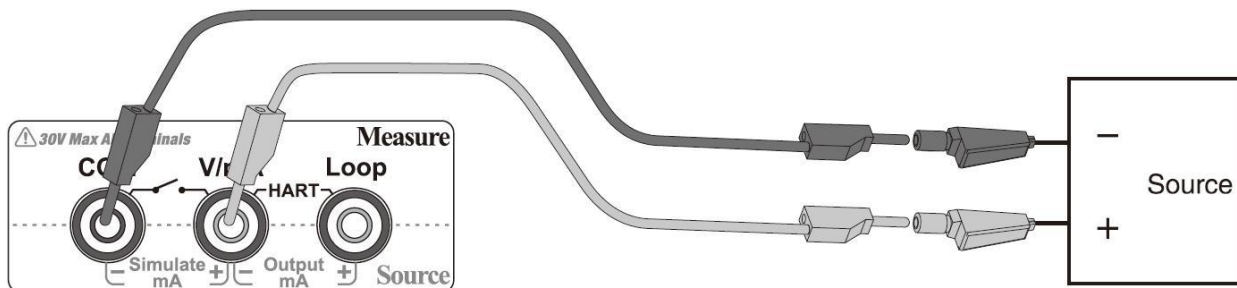

Figure 9 Current / Voltage Measurement

3. Data Analysis:

Press  and select one of the functions below:

①  Min / Max / Avg: Shows the minimum, the maximum, and the average

Subject	Valid Value	Comment
Samples	1~100	Sample collection quantity

Table 11 Min / Max / Avg

②  Scale:

Subject	Valid Value	Comment
Measuring Range	Depends on measurement type	Electrical measurement range
Scale Range	Number, letter, or pressure, temperature, electric unit	Scale unit
	-999999~999999	Zero point value
	-999999~999999	100% point value
Resolution	4, 5, 6	Display digit
Transfer Function	Linear / Square Root	Transfer function type

Table 12 Scale

◆ To turn off data analysis function press  and select  or .

3.1.5 Mechanical Switch

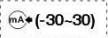
1. Press the Electrical Measurement option () on the top left corner of Electrical Measurement Window and select Switch.
2. Connection

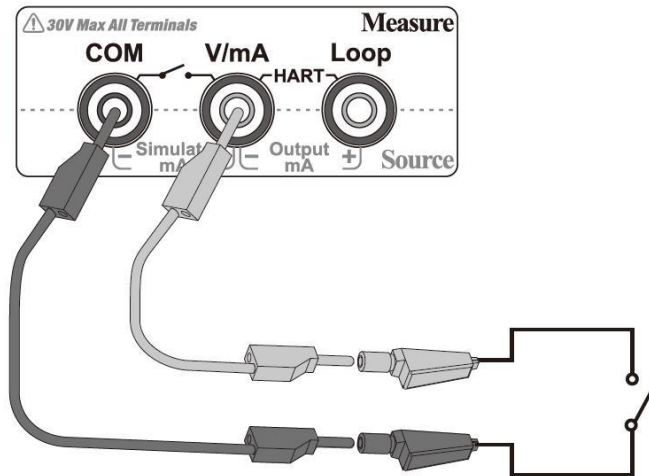
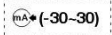

Figure 10 Mechanical Switch Measurement

3. Trip Values

- ◆ The calibrator records the trip values and the state (open / close) of the switch.

3.1.6 NPN /PNP Switch

1. Press the Electrical Measurement option () on the top left corner of Electrical Measurement Window and select Switch NPN or Switch PNP.
2. Connection
3. Trip Values
 - ◆ The calibrator records the trip values and the state (open / close) of the switch.

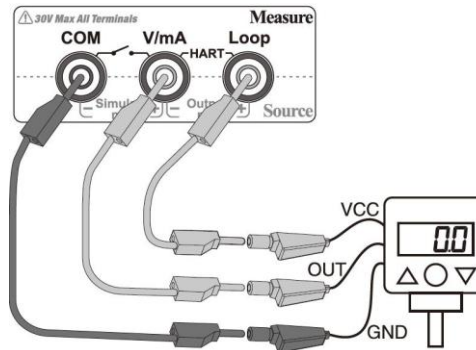
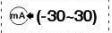

Figure 11 Electrical Switch Measurement

3.1.7 Current Output

1. Press the Electrical Measurement option () on the top left corner of Electrical Measurement Window and select Simulate mA or (0 ~ 24) mA.
2. Connection:

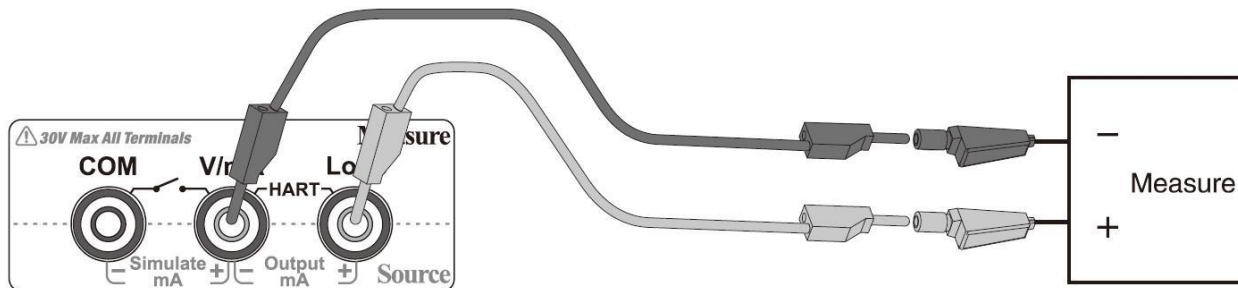

Figure 12 Current Output

3. 24V Internal Power:

◆ Simulate mA:

Internal 24 V power should be turned off automatically, for more information please see section 5.2

◆ (0~24) mA:



Internal 24 V power should be turned on automatically, for more information please see section 5.2

4. Current Set Point:

① Manual Input:

- 1) Click Measure Value on the Electrical Measurement Window, and input the target value
- 2) Press .

② Manual Step:

- 1) Press step size on the Electrical Measurement Window and input the current output range
- 2) Press / each time to decrease or increase current output by 25% of range

NOTE: Current output range shall not exceed 0~24 mA.

3.1.8 External Pressure Module

1. Connection:

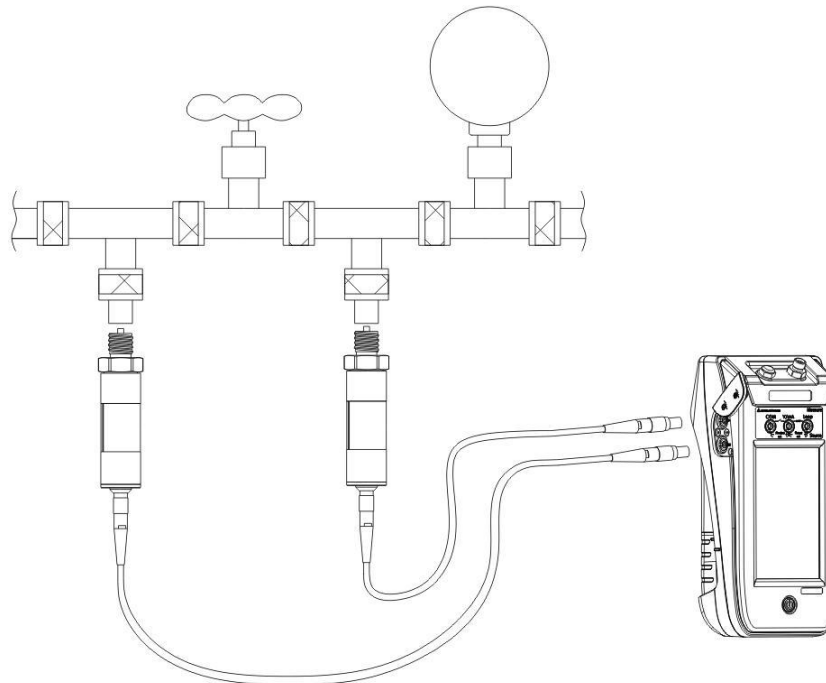



Figure 13 External Pressure Module Connection

2. Display

◆ Symbols  /  indicate the associated external pressure modules are connected.



The main screen will add one/two additional windows when connecting one/two external pressure module.

◆ The external pressure module can only be used for pressure measurement, not for pressure control.

◆ If the measurement value falls outside of the range then it will turn red with an alarm.

◆ If measurement values exceed the limit of the calibrator then it will display "-----" with an alarm.

3. Settings:

Press  /  on the external pressure module window to enter external pressure module setting menu:

Subject	Valid Value	Comment
Pressure Type	Gauge / Absolute / Diff.	External pressure module pressure type
Resolution	4 / 5 / 6	Display digit
Unit	Up to 25 default units or 5 custom units	External pressure module unit is independent of the system unit, see section 3.1.2
Module Information	N/A	This information is read only: including range, pressure type, accuracy, SN, version, and manufacture date

Table 13 External Pressure Module Information

3.2 HART (Only available on 760-X-DL)

3.2.1 Poll

1. Connection

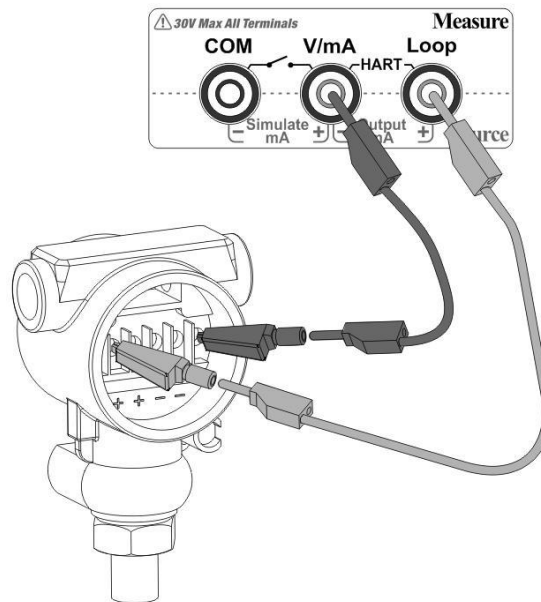

Figure 14 HART Device (Internal Power, Internal Resistor)

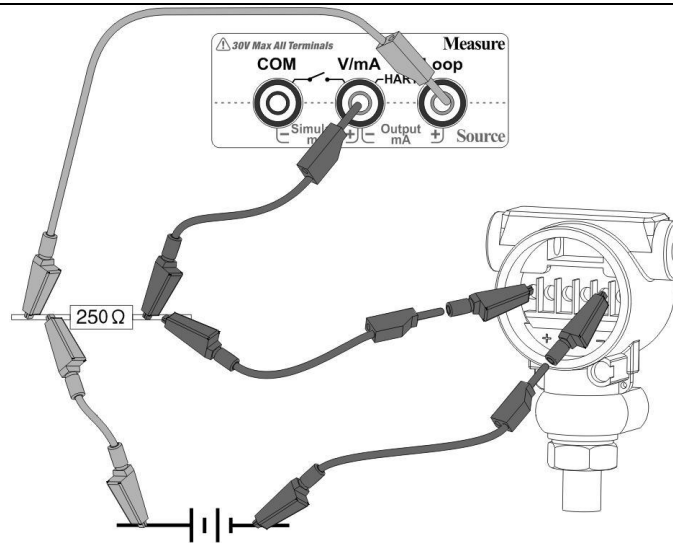





Figure 15 HART Device (External Power, External Resistor)

2. HART Device Type Selection:

On top of Electrical Measurement Window please press  (or ) and select:

- 1).  Internal Power and Resistor
- 2).  External Power and Resistor

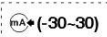

2. Search

1) Poll

Press on Electrical Measurement option () on the top left corner of the Electrical Measurement Window and select HART. The calibrator will poll address 0 if no connection detected. Then it will scan addresses 1 to 15 automatically.

2) Manual Search

HART device manual search is available if necessary.

1) Press  on Electrical Measurement Window, then select  Search. The calibrator will list all HART device detected.



2) Select the device which needs to be tested. If still no required HART device are detected then press  to scan address from 1 to 15 automatically.

3.2.2 Operation Window

The HART measurement value will display on the Electrical Measurement Window. Other process variables can be displayed, see section 3.2.5. Loop current and HART device name are displayed on the bottom of the window.

- ◆ Press the pressure unit to change HART device pressure measuring unit
- ◆ Changing HART device pressure measure unit will not change the calibrator system unit

3.2.3 Settings

Press  and select  Settings to enter HART device settings menu:

1. Device Information: HART device information

Subject	Type	Comment
Manufacturer	Read Only	Manufacturer of HART device
Device Type	Read Only	HART device type
Device ID	Read Only	HART device ID number
Tag	Editable	Alphanumeric content (8 max length)
Date	Editable	HART device date setting
Write Protect	Read Only	Write protection for HART device
Message	Editable	Alphanumeric content (32 max length)
Descriptor	Editable	Alphanumeric content (12 max length)
Final Assembly Number	Editable	Numeric content (12 max length)
Preambles	Editable	Numeric content (12 max length)
Universal Revision	Read Only	Universal version number
Software Revision	Read Only	Software version number
Hardware Revision	Read Only	Hardware version number
Device Revision	Read Only	Device version number

Table 14 HART Device Information

2. Sensor: HART device sensor information

Subject	Type	Comment
Sensor Serial Number	Read Only	HART device sensor SN
Sensor Unit	Read Only	HART device pressure measurement unit (user selectable, see section 3.2.2)
Sensor Lower Limit	Read Only	HART device sensor measurement range lower limit
Sensor Upper Limit	Read Only	HART device sensor measurement range upper limit
Sensor Min Span	Read Only	HART device sensor measurement resolution



Table 15 ART device sensor information

3. HART Device Output

Subject	Type	Valid Value	Comment
PV / Range Unit	Editable	Select from 25 default units or from 5 custom units	HART device pressure measurement unit, see section 3.1.2
PV LRV	Editable	Within HART device sensor range	Process variable lower range
PV URV	Editable	Within HART device sensor range	Process variable upper range
Transfer function	Editable	Linear / Square Root	Transfer function type
Alarm State	Read Only	N/A	Alarm State
Damping	Editable	1~100	Damping time, only support one digit after decimal point
Polling Address	Editable	0~15	HART device polling address
Burst Mode	Editable	On / Off	Burst mode status
Burst Command	Editable	1 / 2 / 3	Burst command, depends on HART device

Table 16 HART Device Output

3.2.4 Service

Press  and select  Service to enter HART device service menu:

1. Loop Test:

This test allows you to compare the HART device current output value with the ADT760 calibrator current measurement value.

◆ The loop test function available only when HART device address is 0

- 1). Input a current value or select Fetch to capture the calibrator current measurement value and then press the enter key or select  to apply.
- 2). After few seconds, the calibrator will send a signal to HART device comparing the HART device current output value (on the top left window) with the calibrator's current measurement value. If the difference is out of tolerance it is recommended to trim the HART device.

2. Pressure Zero Trim:

This test is designed to do a zero point trim on the HART device.

- 1). If using an external pressure module ensure the correct module is selected.
- 2). The calibrator will automatically vent the pressure. Wait until the measurement stabilizes and turns green.
- 3). Press Zero to trim HART device pressure zero point.

3. D/A Trim:

This test is designed to trim the HART device current output value at zero and span.

◆ D/A Trim function available only when HART device address is 0.

① D/A Zero:

- 1). Input a current value (4 mA is typical) or select Fetch to capture the calibrator measurement value (on the top right window). Then press the enter key or select  to apply.
- 2). After few seconds, the calibrator will send a signal to HART device to trim the current value.

② D/A Gain:

- 1). Input a current value (20 mA is typical) or select Fetch to capture the calibrator measurement value (on the top right window). Then press the enter key or select  to apply.
- 2). After few seconds, the calibrator will send a signal to HART device to trim the current value.

4. Sensor Trim:

This test is designed to trim the HART device sensor and the lowest and highest points of the range.

① Low trim:

- 1). Calibrator will control pressure to the lowest point of HART device range automatically.
- 2). Input calibrator pressure measuring value (on the top left window) through soft key board or select Fetch to catch 760 Calibrator current measuring value to trim HART device pressure measuring value.

3). Press the enter key or select  to apply.

② High trim:

- 1). The calibrator will automatically control the pressure to the highest point of the HART device

range.



2). Input the calibrator pressure measurement value (on the top left window) or select Fetch to capture the calibrator value to trim the HART device.

3). Press the enter key or select  to apply.

③ Trim Reset:

This feature will reset the HART device back to factory parameters.

3.2.5 Process

Press  and select  Process to enter the HART device process variable setting menu:



Subject	Comment
PV	Process variable
PVAO	Digital current value
%range	Percentage of pressure range
SV	Secondary variable
TV	Tertiary variable
QV	Quaternary variable
Loop Current	Loop current value

Table 17 HART Device Variable

◆ Selected process variable will be displayed at the top left corner of Electrical Measurement Window, after the  HART- icon

3.3 Zeroing

The zeroing function is available for current/voltage measurement and pressure measurement either internal or external pressure modules.

- ◆ To zero: Press  and select 
- ◆ Apply a short circuit for current / voltage zeroing
- ◆ Allowable zeroing range:
 - Pressure: within 1%FS;
 - Current / Voltage: within 0.1%FS.

3.4 Vent

Press Vent on Control Bar and the calibrator will run the vent process.

- ◆ The vent process will end pressurization during a regular test, typical application, task, and leak test
- ◆ The VENT port should not face the operator during venting process
- ◆ Dust or contaminants may blow out through the VENT port
- ◆ Any moisture or liquid may also blow out through the vent port

4. Typical Applications



The Additel 760 Automatic Handheld Pressure Calibrator supports six typical applications.

To start, please select  Calibrator under Main Menu:☰, then select the desired application.

◆ In the operation interface, press  to re-select from the application list

◆ In the operation interface, press  to enter the new test set up

◆ Zeroing: If current / voltage measurement or internal pressure module requires zeroing then press

 and select  to zero the measurement, see section 3.3

◆ Custom applications can be built with several simple selections

4.1 Pressure Gauge (Includes dial and digital pressure gauges)

In pressure gauge mode, pressure is the only output function available.

1. Pressure Output



- ◆ Ensure proper pressure connections
- ◆ For pressure output, please see section 3.1.3
- ◆ Jog: Press  and select  Jog, which allows for a digit to be selected and numerically incremented, see Figure 16



Figure 16 Jog Function

- ◆ Numeric Keyboard: Press  and select  to allow for quick entry of pressure values

2. New Test:

2.1 New Test Settings:

① JUT (Unit Under Test):

Subject	Valid Value	Comment
Range	Depends on UUT	UUT range











Table 18 Pressure Gauge Test Settings

② Test Method:

See section 3.1.3-3-③Auto Step.

2.2 Test Execution:

After test settings are complete, press  to execute the test:

- 1). Press  to zero pressure module if necessary;
 - 2). Press  to start the test;
- ◆ The calibrator will pressurize to the first set point (which may be zero)
 - ◆ Press  /  /  to switch calibration interface
 - ◆ Press  to check or change test settings
- 3). Standard test steps:
 - (1). After the pressure shows it is stable, the gauge pressure value can be entered in the box on the right. Press  /  /  to switch the calibration interface.
 - (2). Press the enter key or  for next test point and the calibrator will start to pressurize again
 - (3). Wait for the pressure value to be generated and stabilize and then enter the UUT values and proceed to the next point.
 - (4). Repeat step (2) and (3) until all test points passed.

2.3 Report:

Once the test is complete, the test report interface will appear. For more information, please see section 4.6.

4.2 Current / Voltage Transmitter

In the Current / Voltage Transmitter mode, only current, voltage, and pressure are available functions.

1. Current / Voltage Measurement:

- ◆ Correct electrical connection please see Figure 9
- ◆ Data Analysis: Please see section 3.1.4-3

2. Pressure Output

- ◆ Correct output connection please see Figure 8
- ◆ Pressure output: Please see section 3.1.3

3. New Test:

3.1 New Test Settings:

① UUT (Unit Under Test):

Subject	Valid Value	Comment
Input	Depends on UUT	UUT pressure measuring range
Output	Depends on UUT	UUT electrical signal output range
Transfer Function	Linear	Transfer function type









Table 19 Current / Voltage Transmitter Test Settings

② Test Method:

See section 3.1.3-3-③ Auto Step

3.2 Test Execution:

After test settings are complete, press  to execute the test:

- 1). Press  to zero the pressure if necessary.
 - 2). Press  to run a manual test, or press  to run an automatic test.
 - (1). In manual mode, run next test point by pressing , and the calibrator will automatically record the electrical signal and pressure value.
 - (2). In automatic mode, the calibrator will run the test and record the electrical and pressure values automatically without the need to advance the calibrator to the next set point.
- ◆ Press  /  /  to switch calibration interface
 - ◆ Press  to check or change test settings

3.3 Report:

Once the test is complete the test report interface will appear. For more information, please see section 4.6.

4.3 HART Transmitter

In HART Transmitter mode, only the Process Variable function and the Pressure function are available.

1. HART Function:

◆ Correct electrical connection and HART function, please see section 3.2

2. Pressure Output:

◆ Correct output connection please see Figure 8

◆ Pressure output: Please see section 3.1.3

3. New Test:

3.1 New Test Settings:

① UUT (Unit Under Test):

Subject	Valid Value	Comment
Input	Depends on UUT	UUT pressure measuring range
Transfer Function	Linear / Square Root	Transfer function type









Table 20 HART Device Test Settings

② Test Method:

See section 3.1.3-3-③ Auto Step

3.2 Test Execution:

After test settings are complete, press ✓ to execute the test:

-
- 1). Press  to zero the pressure if necessary.
 - 2). Press  to run a manual test, or press  to run a automatic test.
 - (1). In manual mode, run the next test point by press  calibrator and the calibrator will automatically record the electrical signal and pressure value.
 - (2). In automatic mode, the calibrator will run the test and record the electrical and pressure values automatically without the need to advance the calibrator to the next set point.
- ◆ Press  /  /  to switch calibration interface
 - ◆ Press  to check or change test settings

3.3 Report:

Once the test is complete the test report interface will appear. For more information, please see section 4.6.

4.4 Pressure Switch

In the Pressure Switch mode only switch and pressure measurement functions are available.

◆ Press  on the top left corner of Switch Measurement window to select the switch type: Mechanical Switch, Switch NPN, or Switch PNP.

1. Switch Measurement:

◆ Correct electrical connection please see Figure 9

2. Pressure Output

◆ Correct output connection please see Figure 8

◆ Pressure output: Please see section 3.1.3

3. New Test:

3.1 New Test Settings:

① UUT (Unit Under Test):

Subject	Valid Value	Comment
Range	Depends on UUT	UUT pressure range
Accuracy	0.01 ~ 100	UUT accuracy
Switch Type	NC (normal close) / NO (normal open)	Pressure switch type
Repeatability	On / Off	Pressure switch repeatability

Table 21 Pressure Switch Test Settings

3.2 Test Execution:

After test settings are complete, press ✓ to execute the test:

1). Press  to run test automatically

◆ Press  to check or change test settings

3.3 Report:

Once the test is complete the test report interface will appear. For more information, please see section 4.6.

4.5 I/P Converter





In the I/P Converter mode only pressure and current functions are available.

◆ Press  on the top left corner of Current Output window to select the switch type: (0~24) or Simulate mA.

1. Pressure Output

- ◆ Correct output connection please see Figure 8
- ◆ Do not exceed the pressure range of the calibrator
- ◆ Please select Measure on Control Bar

2. Current Output:

- ◆ Correct electrical connection and Current Output function, please see section 3.1.7
- ◆ Jog: Press  and select  Jog, current output value could be adjusted by each digit in this mode, see Figure 16
- ◆ Scale: Press  and select  Scale for scale function, more detail please see section 3.14-3-②

3. New Test:

3.1 New Test Settings:

① JUT (Unit Under Test):

Subject	Valid Value	Comment
Input	Depends on UUT	UUT current measuring range
Output	Depends on UUT	UUT pressure output range
Transfer Function	Linear / Square Root	Transfer function type

Table 22 I/P Converter Test Settings



② Test Method:

See section 3.1.3-3-③ Auto Step

3.2 Test Execution:

After test settings are complete, press  to execute the test:

1). Press  to zero the pressure if necessary.

2). Press  to run a manual test, or press  to run an automatic test.

(1). In manual mode, run the next test point by press  and the calibrator will automatically record the electrical signal and pressure value.

(2). In automatic mode, the calibrator will run the test and record the electrical and pressure values automatically without the need to advance the calibrator to the next set point.

◆ Press  /  /  to switch calibration interface

◆ Press  to check or change test settings





3.3 Report:

Once the test is complete the test report interface will appear. For more information, please see

section 4.6.

4.6 Documenting

Once the test is complete the test report interface will appear.

- ◆ Report interface can be switched between chart view and data view by pressing  / 
- ◆ The test results will be canceled and the test will restart by pressing 
- ◆ Report results are saved by pressing  and entering the information below

1. Save to task:

Subject	Valid Value	Comment
Name	Alphanumeric content (16 max length)	Test ID
Serial Number	Alphanumeric content (16 max length)	Test serial number
Location	Alphanumeric content (16 max length)	Test location
Notes	Alphanumeric content (16 max length)	Note
Accuracy	0.001~100	Test accuracy requirement
Range	N/A	Under test pressure gauge range

Table 23 Test Information

2. Save Options:

Subject	Valid Value	Comment
Operator	Alphanumeric content (16 max length)	Test operator ID
Execute Date	2000/01/01 ~ 2099/12/31	Execution date
Temperature	-20 ~ 100	Environment temperature during test , unit: °C
Humidity	0 ~ 100	Environment humidity during test

Table 24 Test Save Options

- ◆ Results can be recorded as As Found, As Left or Both (As Found and As Left)

5. Setup

To enter the setup menu, please select  Setup under Main Menu:☰.

◆ Any changes made in the Setup will become the default values after the calibrator is rebooted.

5.1 Control Settings

See section 3.1.3-1

5.2 24V Power

To turn on  24V or turn off  24V internal 24V power supply.

◆ For safety and operation convenience, 24V power will be turned on or off automatically depending on the calibration operation.

5.3 Communication

Communication settings:

Subject	Valid Value	Comment
WLAN Settings		
WLAN	On / Off	Enable or disable Wi-Fi communication function
SSID	Depends on network environment (only available when WLAN is on)	Select Wi-Fi router
Network Port	N/A	760 calibrator network port, read only
MAC	N/A	760 calibrator MAC address, read only
Advanced	DHCP / Static	Network address acquisition mode
USB Settings		
Host / Slave Mode	Host / Slave	USB communication mode: Host: For firmware update Slave (device): For communication with computer

Table 25 Communication Settings

5.4 Head Correction

Head pressure correction can be enabled or disabled.

◆ If head pressure correction is enabled:

Subject	Valid Value	Comment
Correction Type	Auto / Fixed	Head pressure correction value calculation type
Correction Type: Fixed		
Correction Value	Depends on internal pressure module	Fixed correction value
Correction Type: Auto		
Correction Value	N/A	Calculated value, read only
Unit	SI / BS	Unit standard: SI: Metric unit BS: Imperial unit
Density	Air / Nitrogen / Custom	Density of gas in used
Height	-1000 ~ 1000 cm (4 digit after decimal point)	Altitude difference between UUT pressure inlet port and 760 calibrator pressure outlet port
Gravity	9 ~ 10 m/s ² (4 digit after decimal point)	The gravity acceleration at the location of 760 calibrator
Temperature	0 ~ 100°C (2 digit after decimal point)	Temperature at the location of 760 calibrator

Table 26 Head Pressure Correction

NOTE: Default air and nitrogen density is 0°C @ 1 013,25 hPa. After inputting your height and temperature the ADT760 will calculate the correction value.

5.5 Services

5.5.1 Calibration

To calibrate 760 calibrator system.

CAUTIONS:

- ◆ The calibrator should be powered to warm up 30 minutes prior to starting the calibration
- ◆ Current / voltage measurement, current output, and internal pressure module need to be calibrated periodically
- ◆ Carefully read user manual and follow the instruction before 760 calibrator system calibration operation
- ◆ Incorrect system calibration operation will decrease the accuracy of 760 calibrator, even shutting down
- ◆ During system calibration operation, pressing  will restore the factory calibration and change the calibration date to "----/--/--"
- ◆ A higher accuracy standard should be used to calibrate the ADT760 calibrator
- ◆ The calibration operation password is: 123456
- ◆ Once the calibration is completed and saved the new data will be immediately loaded and used. A new calibration date will also be uploaded
- ◆ Once a new calibration has been finished and saved any previous calibrations will be permanently deleted except for the factory calibration

5.5.1.1 Current / Voltage Measurement Calibration

1. Connection:

◆ Correct electrical connection please see Figure 9

2. Calibration point setup:

Select the calibration point which needs to be changed, then input value

◆ 3 points for current / voltage measurement calibration

◆ Default current measurement calibration points are -30 mA, 0 mA, 30 mA

Default voltage measurement calibration points are -30 V, 0 V, 30 V

◆ Additel does not recommend changing calibration points.

3. Calibration Execution:

1). Press  to start calibration process

2). Output current / voltage from standard to 760 calibrator and the standard output value needs to be the same as the corresponding calibration set point

3). When Measured Value is stable, press  to record data and move to the next calibration point

◆ If the difference between Calibration Point and Measured Value is unacceptable, the Measured Value will display red.

5.5.1.2 Current Output Calibration

1. Connection:



◆ Correct electrical connection please see Figure 3-3.

2. Calibration point setup:

Select the calibration point which needs to be changed, then input value

- ◆ 3 points for current output calibration
- ◆ Default current output calibration points are 1mA, 10mA, 20mA
- ◆ Additel does not recommend changing calibration points.

3. Calibration Execution:

- 1). Press  to start calibration process
- 2). Output current from 760 calibrator to standard
- 3). When standard measuring value is stable, press correspondent **Measured Value** and input measuring value displayed on the standard then select Enter button or  to confirm and then press  to record data and move to the next calibration point.

5.5.1.3 Internal Pressure Module Calibration

1. Output Connection:

Select Internal / External pressurizing;

- ◆ For Internal pressurizing: Please connect 760 calibrator pressure outlet port to the standard ensuring the standard is in measurement mode
- ◆ For External pressurizing: Please connect 760 calibrator pressure outlet port with the standard, ensuring the standard is in pressure generation mode

2. Calibration point setup:

Select the calibration point which needs to be changed, then input value

- ◆ 3 points for internal pressure module calibration
- ◆ Default calibration points are the lower limit, zero point, and the upper limit of internal pressure

module

◆ Additel does not recommend changing calibration points



NOTE: The lower limit of some internal pressure modules may exceed the lower limit of 760 calibrator pump, please use External pressurizing to calibrate these internal pressure modules.

3. Calibration Execution:

1). Press  to start calibration process

2). Pressurization:

① Internal pressurizing:

Generate pressure using the 760 internal pump. When the pressure is stable press Reference value and input the value and select the Enter key or  to confirm, then press  to record data and move to the next calibration point.

② External pressurizing:

Output pressure from standard to 760 calibrator, and not the standard output value shall be the same as correspondent calibration set point. When Measured Value is stable, press  to record data and move to the next calibration point.

5.5.1.4 Auto Tune

This function is only used during when recommended by Additel Corporation to service the calibrator

5.5.1.5 Pressure Sensor

This function is for positive and negative pressure sensor check with atmosphere.

5.5.1.6 Barometer (Only for -MA & -MA-DL)

This function is for barometer sensor calibration.

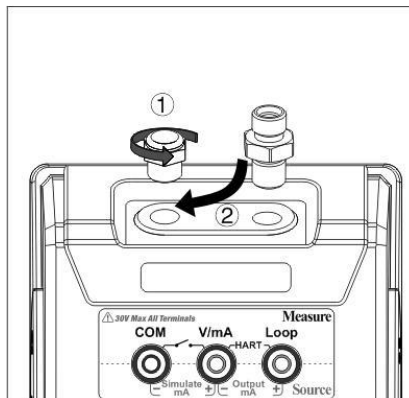

Figure 17 Barometer Sensor Calibration

1. Connection: Please connect 760 calibrator barometer sensor calibration port with standard pressure outlet port.
2. Calibration point setup:
Select the calibration point which needs to be changed, then input value
 - ◆ 2 points for current output calibration
 - ◆ Default calibration points are 60kPa and 110kPa
 - ◆ Additel does not recommend changing calibration points
3. Pressure Outlet: The output pressure from the standard needs to be the same as the corresponding calibration set points. When the Measured Value is stable, enter the Reference

value displayed on the standard and press the Enter key or ✓ to confirm, then press ▶| to record data and move to the next calibration point.

5.5.1.7 Touch Screen

To check the touch screen, please press the center of black cross displayed on the screen five times.

- ◆ If pressed on the deviation from the center of black cross, the test will repeat until it is precisely pressed five times on the center of the black cross.

5.5.2 Diagnosis

This menu provides diagnostic information from the main board, control board, and electrical board which may help indicate if anything is working improperly.

- ◆ If a problem is detected then please contact Additel for further assistance
- ◆ More information:
 1. Password: 123456

5.5.3 System Log

Lists all abnormal information. Powering off or rebooting will not clear the information. The information can be cleared by an update, please see section 5.5.4, or factory reset, please see section 5.5.5.

5.5.4 Maintenance

This menu is used to depressurize the unit when switching internal pressure models.

◆ Press  to start.

5.5.5 Factory Reset

Resets all data to factory default settings.

◆ Password: 123456

5.5.6 Updates

To update 760 calibrator firmware, please:

- 1). Copy update file into an USB root directory
- 2). Insert USB into 760 calibrator USB port
- 3). Select Updates by USB on calibrator
- 4). Wait for the update to complete in which a notification will be given

◆ Password: 123456

◆ The USB has to be in FAT16 or FAT32 type

◆ The calibrator will switch USB port to Host type automatically

5.6 Sound

To enable or disable **Touch Beep** and **Over range alarm beep**.

5.7 Personalization

5.7.1 Date and Time

Subject	Valid Value	Comment
Time	0:00 ~ 23:59	Time
Date	2000-1-1 ~ 2099-12-31	Date
Date Format	YYYY-MM-DD / MM-DD-YYYY / DD-MM-YYYY	Date format
Date Separator	-, /, .	Date format separator

Table 27 Date and Time Settings

5.7.2 Language

The calibrator is equipped with a multi-language user interface. Use this menu to change from the offered languages.

5.7.3 Theme

Switch to **Light Theme** or **Dark Theme**.

5.7.4 Safety Data

Switch ON/OFF a warning before data deletion.

5.8 Power Management

Subject	Valid Value	Comment
Brightness	1~100%	Adjusting this setting may impact the battery life.
Battery Info	N/A	Battery Information: remaining capacity, full capacity, temperature, voltage, cell voltage I & II, Charging / Discharging Current
Auto Backlight Off	Never, 15 sec, 30 sec, 1 min, 5 min, 15 min, 30 min	Touch the screen to turn the backlight on
Auto Off	Never, 5 min, 15 min, 30 min, 1 hour, 2 hour	Auto power off after backlight is turned off. There will be a 30s countdown

Table 28 Power Management

5.9 System Information

1. Main:

Main information of 760 calibrator: including serial number, application, system version, Wi-Fi, BLE (Bluetooth), control board, electric board information

2. Battery:

Battery information: including serial number, version, manufacture date information.

3. Internal module:

Internal pressure module information: including range, pressure type, accuracy, serial number, version, manufacture date information.

6. Task (Only available on 760-X-DL)

The Additel 760 calibrator provides task functionality for automated calibration while storing and archiving the calibration data. To use the task function, please select  Task under Main Menu:☰

6.1 New Task

Press \oplus and select UUT (Unit Under Test) type to enter a New Task interface and add UUT information.

6.1.1 Dial Pressure Gauge

UUT (Unit Under Test) information:

Subject	Valid Value	Comment
Name	Enter an alphanumeric content (16 max length)	UUT ID
Serial Number	Enter an alphanumeric content (16 max length)	UUT serial number
Location	Enter an alphanumeric content (16 max length)	Task location
Note	Enter an alphanumeric content (16 max length)	Task note
Pressure Type	Gauge / Absolute / Diff.	UUT pressure type
Range	Depends on UUT	UUT pressure measuring range
Accuracy	0.06%, 0.1%, 0.16%, 0.25%, 0.4%, 0.6%, 1%, 1.6%, 2.5%, 4%, Custom	UUT accuracy
Resolution	0.0001~999999999999	The pressure difference represented by nearest two scale on UUT.

Table 29 Dial Pressure Gauge Information Settings

Press to complete UUT information set up and the calibrator will switch back to the task list. For further instruction, please see section 6.2.1.

6.1.2 Digital Pressure Gauge

Please see section 6.1.1.

Press ✓ to complete UUT information set up and the calibrator will switch back to the task list. For further instruction, please see section 6.2.2.

6.1.3 Pressure Transmitter (Current, Voltage, HART)

UUT (Unit Under Test) information:

Subject	Valid Value	Comment
Name	Enter an alphanumeric content (16 max length)	UUT ID
Serial Number	Enter an alphanumeric content (16 max length)	UUT serial number
Location	Enter an alphanumeric content (16 max length)	Task location
Note	Enter an alphanumeric content (16 max length)	Task note
Pressure Type	Gauge / Absolute / Diff.	UUT pressure type
Input	Depends on UUT	UUT pressure measuring range
Output	Analog: 4~20 mA / 0~10 mA / 0~20 mA / 1~5 V / 0~5 V / 0~10 V / Custom	Current / voltage pressure transmitter output electrical signal type
	HART: PV / % range / PVAO / Loop Current	HART transmitter output electrical signal display type
Transfer Function	Linear / Square Root	Transfer function type
Accuracy	0.05%, 0.1%, 0.2%, 0.5%, 1%, 1.5%, 2%, 2.5%, Custom	UUT accuracy

Table 30 Pressure Transmitter Information Settings

Press  to complete UUT information set up and the calibrator will switch back to the task list. For further instruction, please see section 6.2.3.

6.1.4 Pressure Switch

UUT (Unit Under Test) information:

Subject	Valid Value	Comment
Name	Enter an alphanumeric content (16 max length)	UUT ID
Serial Number	Enter an alphanumeric content (16 max length)	UUT serial number
Location	Enter an alphanumeric content (16 max length)	Task location
Note	Enter an alphanumeric content (16 max length)	Task note
Pressure Type	Gauge / Absolute / Diff.	UUT pressure type
Range	Depends on UUT	UUT pressure measuring range
Set point	Depends on UUT	Pressure switch activation set point
Accuracy	0.06%, 0.1%, 0.16%, 0.25%, 0.4%, 0.6%, 1%, 1.6%, 2.5%, 4%, Custom	UUT accuracy
Switch Type	NC (normal close) / NO (normal open)	Pressure switch type
Deadband	Depends on UUT	Dead band range of pressure switch

Table 31 Pressure Switch Information Settings

Press  to complete UUT information set up and the calibrator will switch back to the task list. For further instruction, please see section 6.2.4.

6.1.5 I/P Converter

UUT (Unit Under Test) information:

Subject	Valid Value	Comment
Name	Enter an alphanumeric content (16 max length)	UUT ID
Serial Number	Enter an alphanumeric content (16 max length)	UUT serial number
Location	Enter an alphanumeric content (16 max length)	Task location
Note	Enter an alphanumeric content (16 max length)	Task note
Pressure Type	Gauge / Absolute / Diff.	UUT pressure type
Input	Depends on UUT	UUT electrical signal measuring range
Output	Depends on UUT	UUT pressure output range
Transfer Function	Linear / Square Root	Transfer function type
Accuracy	0.025%, 0.05%, 0.1%, 0.16%, 0.25%, 0.4%, 1%, 1.6%, 2.5%, 4%, Custom	UUT accuracy

Table 32 I/P Converter Information Settings

Press  to complete UUT information set up and the calibrator will switch back to the task list. For further instruction, please see section 6.2.5.

6.2 Task Execution

Please select UUT(Unit Under Test) from the task list, and check UUT information. Next select  to view and or edit the task information and execute the test.

◆To edit UUT information, please select UUT from the task list then select  .

6.2.1 Dial Pressure Gauge

1. Task Execution Setup (Run Information):





Subject	Valid Value	Comment
Set Points	2~17; Set point values depend on UUT range	Set point values will be calculated automatically. ◆To edit the number of set points: press  /  or press on set point number at the bottom of the screen and input value through soft keyboard ◆To edit value: select and input value through soft keyboard
Repeat	1 / 2 / 3	Task cycle times
Stroke	Round Trip / One Way	Task stroke type
Readout format	Value / Scale	1.Value: Input dial pressure gauge indicated value 2.Scale: Input scale number indicated on dial pressure gauge. For example, Resolution of UUT is 0.1 kPa, input 2 as scale number means UUT measurement value is 0.2 kPa
Tapping	On / Off	To enable or disable tapping after reach each set point during the test

Table 33 Dial Pressure Gauge Task Settings

2. Task Execution:

Press  to execute the task:

1). Press  to zero pressure module if necessary

2). Press  to start the test;

◆The calibrator start pressurizing to the first test point

◆Press  /  /  to switch calibration interface

3). Standard test steps:



(1). After pressure is stable , enter the UUT pressure value on the top right UUT window or press

 /  /  to switch the calibration interface.

(2). Press the Enter key or  for the next test point in which the calibrator will pressurize again.

Note: if the tapping function is enabled, you should tap the dial gauge at each set point.

(3). After the next pressure is stable then enter the UUT value in the UUT window or press

 /  /  to switch the calibration interface.

(4). Repeat step (2) and (3) until all test points are completed.

3. Report:

Once test is done, the reporting interface will appear. For more information please see section 6.4.

6.2.2 Digital Pressure Gauge

1. Task Execution Setup (Run Information):





Subject	Valid Value	Introduction
Set Points	2~17; Set point values depend on UUT range	Set point values will be calculated automatically. ◆To edit the number of set points press: press  /  or press on Set point number at the bottom of the screen and input value ◆To edit value: select and input value
Repeat	1 / 2 / 3	Task cycle times
Stroke	Round Trip / One Way	Task stroke type

Table 34 Digital Pressure Gauge Task Settings

2. Task Execution:

Press  to execute task:



1). Press  to zero pressure module if necessary.

2). Press  to start the test;

◆The calibrator start pressurization to the first test point

◆Press  /  /  to switch calibration interface

3). Standard test steps:

(1). After the pressure is stable at the first test point then enter the UUT pressure value on the top right UUT window or press  /  /  to switch the calibration interface.

(2). Press the Enter key or  for the next test point in which the calibrator will begin pressurizing

again.

(3). After the pressure is stable enter the UUT value.

(4). Repeat step 2 and 3 until all test points are completed.

3. Report:

Once a test is complete, the test report interface will appear. For more information please see section 6.4.

6.2.3 Pressure Transmitter (Current, Voltage, HART)

1. Task Execution Setup (Run Information):

Subject	Valid Value	Comment
Set Point	2~17; Set point values depend on UUT range	Set point values will be calculated automatically. ◆ To edit the number of set points press: press ☹ / ☺ or press on set point number at the bottom of the screen and input value ◆ To edit value: select and input value
Repeat	1 / 2 / 3	Task cycle times
Stroke	Round Trip / One Way	Task stroke type
Dwell Time	1~36000	Dwell time after pressure stabilized at each set point, unit: sec

Table 35 Pressure Transmitter Task Settings

2. Task Execution:

Press ✓ to execute the task:



1). Press 00 to zero pressure module if necessary.

2). Press MP to run the test manually, or press AP to run the test automatically.

(1). In manual mode, run the next test point by pressing ►, the calibrator will record electrical signal and pressure value automatically

(2). In automatic mode the calibrator will run the test and record the electrical and pressure values

automatically.

◆ Press  /  /  to switch calibration interface

3. Report:

Once a test is complete, the test report interface will appear. For more information please see section 6.4.

6.2.4 Pressure Switch

1. Task Execution Setup (Run Information):

Subject	Valid Value	Comment
Repeat	1 / 2 / 3	Task cycle times
Select Current Source Channel	Switch(Mechanical Switch) / Switch PNP / Switch NPN	Pressure switch type

Table 36 Pressure Switch Task Settings

2. Task Execution:

Press  to execute task:

Press  to run test automatically;

◆ The calibrator will run the test and record electrical signal and pressure value automatically

3. Report:

Once a test is complete, the test report interface will appear. For more information please see section

6.4.

6.2.5 I/P Converter

1. Task Execution Setup (Run Information):







Subject	Valid Value	Comment
Set Points	2~17; Set point values depend on UUT range	Set point values will be calculated automatically. ◆To edit the number of set points press: press  /  or press on set point number at the bottom of the screen and input the value ◆To edit the value: select and input value
Repeat	1 / 2 / 3	Task cycle times
Stroke	Round Trip / One Way	Task stroke type
Dwell Time	1~36000	Dwell time after pressure stabilized at each set point, unit: sec
Select Current Source Channel	(0~24) mA / Simulate mA	Electrical signal type measured by I/P converter

Table 37 I/P Converter Task Settings

2. Task Execution:

Press  to execute task:

- 1). Press  to zero pressure module if necessary.
- 2). Press  to run the test manually, or press  to run the test automatically.

(1).In manual mode, run the next test point by pressing ►I, the calibrator will record electrical signal and pressure value automatically.

(2).In automatic mode, the calibrator will run the test and record electrical signal and pressure value automatically.



◆ Press  /  /  to switch calibration interface

3. Report:

Once a test is complete, the test report interface will appear. For more information please see section 6.4.





6.3 Task Delete

To delete a task: In task list, press  and select **Clear All Tasks** or **Task delete management**.

◆ In task delete management interface, select  to select all tasks or select single or multiple tasks, then press  to delete selected tasks.

6.4 End of Task

Once a test is complete, the test report interface appears.

- ◆ Report interface can be displayed in a chart or data format by pressing  / 
- ◆ The test data can be canceled and the test will restart by pressing 
- ◆ To save the report press  and enter the information below:

Save Options:

Subject	Valid Value	Comment
Operator	Alphanumeric content (16 max length)	Test operator ID
Execute Date	2000/01/01~2099/12/31	Execution date
Temperature	-20~100	Environment temperature during test , unit: °C
Humidity	0~100	Environment humidity during test

Table 38 Task Save Operation

- ◆ The report can be saved as As Found, As Left or Both (As Found and As Left)

7. Data Logger (Only available on 760-X-DL)

To use data logger function, please select  Data Logger under Main Menu:☰.

1. The data logging functions available are listed below:

① Electrical Signal: Current / voltage measurement, pressure switch (mechanical, PNP, NPN) measurement, current output (0~24 mA, simulate mA), and HART device electrical signal are available for data logging.

② Pressure Measurement: Internal pressure module and external pressure module.

◆ Data logging is available when the external pressure module is properly connected

◆ At most, 4 channels can be logged independently or together: One electrical signal channel, one pressure measurement channel and two external pressure module channels;

2. Data Logger Channel Setup:

Press ⊕ or ⊖ to add or delete channels.

◆ By selecting a channel from the channel list, you can view the channel number, change the logging content and change the units

◆ Channel numbers will be rearranged once a channel has been deleted

3. Data logger setup:

Press the data logger details area which is on the bottom of the screen to change data logger setup:

Subject	Valid Value	Comment
Trigger	Periodic	Data logger activate type, read only
Interval	0.1~999999	Data logging internal, unit: sec
Samples	1-999999	Data logging sample number
Time	0:00:00~999:59:59	Data logging total time span

Table 39 Data Logger Setup

NOTE: Interval x Samples = Times

4. To start data logging, press :

1). Input data logging name, notes, and operator information, then select .

2). The calibrator will start data logging automatically.

◆When the data logging process has started, data begins to record automatically

◆Press  to see data logging chart

◆When in the chart view the different channels are represented by a different color:

Theme	Channel 1	Channel 2	Channel 3	Channel 4
White	Blue	Orange	Aqua	Green
Black	Blue	Orange	Deep Pink	Green

Table 40 Data Logger Chart

◆To stop logging press 

◆Press  to enter Logger Results interface for data review

◆ In review interface, press  to switch between chart and data view

8. Application

To use additional applications, please select  Application under Main Menu: .

8.1 Leak Test

Leak test is used to check the leak rate in the calibration system.

To start a test, press the > in the top right portion of the leak test screen. this will allow you to modify the following parameters.

Subject	Valid Value	Comment
Pressure Module	Internal Pressure Module (INT.P) / External Pressure Module (PM)	Select pressure module
Pressure Type	Gauge / Absolute / Diff.	Pressure module pressure type, depends on 760 model
Unit	One from 25 default units or from 5 custom units	760 Calibrator pressure unit, see section 3.1.2
Test Time	0:00:00~999:59:59	Leak test total time span
Wait Time	0:00:00~999:59:59	Waiting time before leak test started
Set Point	Depends on internal pressure module	Leak test pressure set point

Table 41 Leak Test

Press  to start leak test.

8.2 Pressure Unit Converter

Each Additel 760 calibrator has a built-in pressure unit converter.

◆ Press on any unit and input the value you would like to convert to

9. Service

9.1 Inlet Port Filter

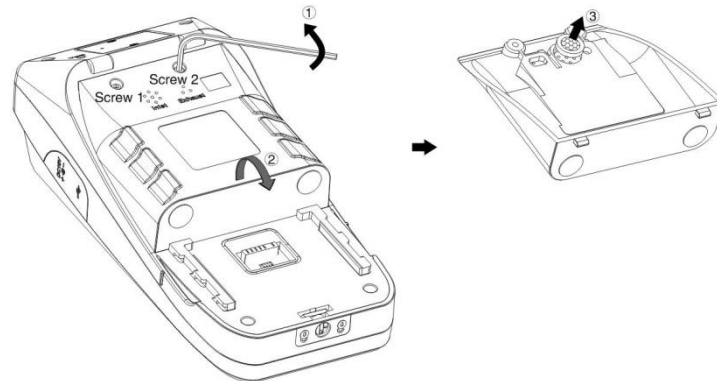

Figure 18 Inlet Port Filter

To change inlet port filter:

- 1). Remove battery and screw 1 and 2 by using Allen Key (2.5mm)
- 2). Remove back cover
- 3). Change the filter

Maintenance Cycle: 3 ~ 6 months depending on use.

9.2 Pressure Outlet Port Filter and O-ring (Same as REF port)

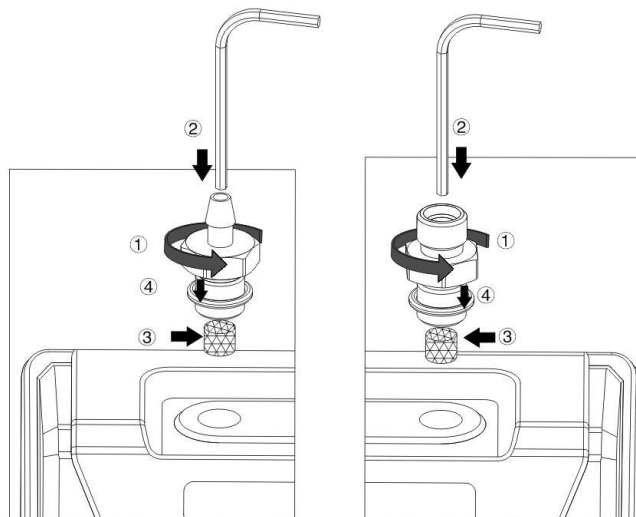

Figure 19 REF and Outlet Port Filter

To change pressure outlet port filter and o-ring:

- 1). Remove pressure outlet port by turning in counter-clockwise direction
- 2). Push out the filter by using Allen Key ($\leq 2.5\text{mm}$)
- 3). Clean by water or replace with a new one
- 4). Change o-ring if needed.

Maintenance Cycle: 3 ~ 6 months depending on use.

Appendix 1: SCPI List

NOTE: In the system, pressure unit is an independent parameter. Current / voltage unit is used as a parameter along with its numerical value.

A1.1 IEEE488.2

S/N	Command	Description	Parameter	Return Value
1	*CLS	The command removes the following register: Standard event register; Query event register; Operational event register; Status byte register; Error queue.	-	-
2	*ESE <enable value>	Set the value of standard event enable register	<Nrf>,0-255	-
3	*ESE?	Read the value of standard event enable register	-	<NR1>
4	*ESR?	Read the value of standard event register. On execution of the order, the value of standard event register will be reset.	-	<NR1>
5	*IDN?	In inquiring the apparatus marking, the	-	Product series No.

S/N	Command	Description	Parameter	Return Value
		return data shall be divided into 2 parts: a.Product series No; b.Software version No.		and software Ver. No.
6	*OPC	After the equipment implements *OPC command, set the "operation complete" of standard event register at 1.	-	-
7	*OPC?	After *OPC? Order, return to 1.	-	1
8	*RST	Reset main program	-	-
9	*SRE <enable value>	Set the value of status byte enable register	<NRf>,0-255	-
10	*SRE?	Read the value of status byte enable register	-	<NR1>
11	*STB?	Read the value of status byte register	-	<NR1>
12	*WAI	Wait for completion of operation.	-	-

A1.2 Measurement and configuration

S/N	Command	Description	Parameter	Return Value
1	MEASure[:SCALar][:PRESsure<n>]?	<p>Pressure measurement. n valuing 1~6.</p> <p>PRESsure1 means reading the pressure of pressure module under control (the value adjusted by air column under the currently set pressure type);</p> <p>PRESsure2 means reading the pressure of internal module (as original value);</p> <p>PRESsure3 means reading the pressure of external module (as original value);</p> <p>PRESsure4 means reading the pressure of positive pressure module (as original value);</p> <p>PRESsure5 means reading the pressure of negative pressure module (as original value);</p> <p>PRESsure6 means reading atmospheric pressure</p>	-	Measurement value: name of unit
2	MEASure[:SCALar]:CURRENT?	Current measurement. For multi-channel measurement, n=1~4.	-	Measurement value

S/N	Command	Description	Parameter	Return Value
		On receiving the command, the controller sets the measurement item as mA measurement, conduct measurement, and return to the measurement value. The current measurement has only one range (-30~30) mA, displaying the fixed bit width of 6.		
3	MEASure[:SCALar]:VOLTage?	Voltage measurement		Measurement value
4	MEASure[:SCALar]:SWITCh:REGular?	Mechanical Switch status test	-	1 : Open ; 0 : Close.
5	MEASure[:SCALar]:SWITCh:PNP?	PNP Switch status test		1 : Open ; 0 : Close.
6	MEASure[:SCALar]:SWITCh:NPN?	NPN Switch status test		1 : Open ; 0 : Close.
7	MEASure[:SCALar]:ELECTricity?	Read current measurement value.		Measurement value, unit.
8	SENSe:ELECTricity:FUNCTion "<function>"	Switch measurement type due to "<function>"	Measurement type: "CURRent" : current	-

S/N	Command	Description	Parameter	Return Value
			measurement ; "CURRent:SOURce" :current output "VOLTage": voltage measurement within (-300~300)mV range ; "SWITch:REGular" : Switch test; "SWITch:PNP" : PNP switch test; "SWITch:NPN" : NPN switch test.	
9	SENSe:ELEctricity:FUNCTion?	Read measurement type	-	
10	SENSe:PRESSure<n>:MODE ABSolute GAUGE	Pressure type switching, n=1~3 1. Internal pressure module 2. External pressure module A 3. External pressure module B	ABSolute : Absolute pressure ; GAUGE : Gauge pressure ;	-
11	SENSe:PRESSure<n>:MODE?	Read pressure type, n=1~3 1. Internal pressure module	-	Pressure type

S/N	Command	Description	Parameter	Return Value
		2. External pressure module A 3. External pressure module B		
12	SENSe:PRESSure<n>:DIG it 4 5 6 7 MINimum MAXimum	Set pressure value display bit wide. 7 bit is only available for quartz pressure module. n=1~3 1. Internal pressure module 2. External pressure module A 3. External pressure module B	Bit wide: MIN stands for minimum bit wide; MAX stands for maximum bit wide ;	-
13	SENSe:PRESSure<n>:DIG it? [MINimum MAXimum]	Set pressure value display bit wide. n=1~3 1. Internal pressure module 2. External pressure module A 3. External pressure module B	MINimum stands for minimum bit wide; MAXimum stands for maximum bit wide; Current set Ignore this parameter	Bit wide
14	SENSe:PRESSure<n>:RANGe:UPPer?	Read the upper limit of current pressure control module	-	Upper limit, unit
15	SENSe:PRESSure<n>:RANGe:LOWer?	Read the lower limit of current pressure control module	-	Lower limit, unit
16	SENSe:PRESSure<n>:ZER	Zero pressure measurement value of	-	-

S/N	Command	Description	Parameter	Return Value
	O	current pressure control module. n=1~3 1. Internal pressure module 2. External pressure module A 3. External pressure module B		
17	SENSe:ELEctricity:ZERO	Zero current electrical measurement value	-	-
18	SENSe:VOLTage[:DC]:RANGe? [MINimum MAXimum]	Read voltage measurement range	MINimum stands for minimum range ; MAXimum stands for maximum range ; All available ranges will be returned if ignore this parameter.	Lower limit, upper limit
19	SENSe:CURRent[:DC]:RANGe? NGe?	Read current measurement range	-	Lower limit, upper limit
20	SENSe<n>:ONLine?	Read pressure module status. n=1~3 1. Internal pressure module 2. External pressure module A		1 : Online 0 : Offline

S/N	Command	Description	Parameter	Return Value
		3. External pressure module B		
21	SENSe<n>:VERSionSW H W	Read pressure module version. n=1~3 1. Internal pressure module 2. External pressure module A 3. External pressure module B	SW : Software Version HW : Hardware Version	

A1.3 Output

S/N	Command	Description	Parameter	Return Value
1	[SOURCE:]PRESsure<pressure_value>	Set targeted pressure value and output pressure.	Pressure value : <numeric_value> , unit is the current set unit of system	-
2	[SOURCE:]PRESsure?	Read target pressure value	-	Target value, unit
3	[SOURCE:]PRESsure:LIMit: UPPer?	Read pressure output upper limit	-	Upper limit, unit
4	[SOURCE:]PRESsure:LIMit: LOWer?	Read pressure output lower limit	-	Lower limit, unit
5	[SOURCE:]PRESsure:SLEW <value>	Set pressure control rate	Pressure control rate: <numeric_value> , unit is the current set unit of system	-
6	[SOURCE:]PRESsure:SLEW ? [LOWer UPPer]	Read pressure control rate	LOWER: Read lower limit UPPER: Read upper limit Read current	Pressure control rate, unit

S/N	Command	Description	Parameter	Return Value
			pressure control rate if ignore this parameter	
7	[SOURce:]PRESsure:SLEW :TYPEMAX CUSTom	Set pressure control rate type	Max: Maximum rate Custom: Custom rate	-
8	[SOURce:]PRESsure:SLEW :TYPE?	Read pressure control rate type	-	Pressure control rate type
9	[SOURce:]PRESsure:TOLe rance<value>	Set pressure stability	Pressure stability: <numeric_value> , %FS	-
10	[SOURce:]PRESsure:TOLe rance?	Read pressure stability	-	Pressure stability
11	OUTPut[:PRESsure]:MOD E CONTrol MEASure VENT	Set controller working type	CONTrol ; MEASure ; VENT.	-
12	OUTPut[:PRESsure]:MOD E?	Read controller working type	-	controller working type
13	OUTPut[:PRESsure]:STABI	Read pressure stability status	-	1 : Stable ; 0 : Unstable

S/N	Command	Description	Parameter	Return Value
	e?			
14	OUTPut:GPIO<n>[:STATUs] <Boolean> LOW HIGH	Set IO port status , n=1~30 , stands for the IO port pin position. For example, GPIO2 stands for the second pin of IO port.	1 or HITH : High electrical level ; 0 or LOW : Low electrical level	-
15	OUTPut:GPIO<n>[:STATUs]?	Read IO port status	-	1 : High electrical level ; 0 : low electrical level
16	OUTPut:24V[:STATE]0 1 OFF ON	Set 24V power status	1 or ON 0 or OFF	OK, ERROR
17	OUTPut:24V[:STATE]?	Read 24V power status	-	24V power status
18	[OUTPut:]CURREnt:SOURce<Value>[,<Mode>]	Current output	Value : current output value Mode : Output mode 0 : Original value 1 : End value Default is 1	
19	[OUTPut:]CURREnt:SOURce?	Read current output value		

A1.4 Calculation

S/N	Command	Description	Parameter	Return Value
1	CALCulate[:PRESsure]:LI Mit:LOWer<low>	Set pressure lower limit	Pressure lower limit, unit is the current set unit of system	-
2	CALCulate[:PRESsure]:LI Mit:LOWer?	Read pressure lower limit	-	Pressure lower limit, unit
3	CALCulate[:PRESsure]:LI Mit:UPPer<high>	Set pressure upper limit	Pressure upper limit, unit is the current set unit of system	-
4	CALCulate[:PRESsure]:LI Mit:UPPer?	Read pressure upper limit	-	Pressure upper limit, unit
5	CALCulate[:PRESsure]:LI Mit:STATe<Boolean> ON OFF	Set whether the output range limit is enabled	1 or ON : Enable 0 or OFF : Disable	-
6	CALCulate[:PRESsure]:LI Mit:STATe?	Inquire whether the output range limit is enabled	-	1 : Enable 0 : Disable
7	CALCulate[:PRESsure]:LI Mit:VENT<value>	Set venting pressure	Venting pressure: <numeric_value> ,	-

S/N	Command	Description	Parameter	Return Value
			unit is the current set unit of system	
8	CALCulate[:PRESsure]:LI Mit:VENT?	Read venting pressure	-	Venting pressure, unit

A1.5 System

S/N	Command	Description	Parameter	Return Value
1	SYStem:VERSion? [<module>]	Read module SCPI Ver No.. Default is the system SCPI version number	"APPLication" : Main program version "CONTRoller:FIR Mware" : Controller firmware version "CONTRoller:HAR Dware" : Controller hardware version "ELECtricity:FIRM	Version number

S/N	Command	Description	Parameter	Return Value
			ware" : Electrical measurement board firmware version "EIECTricity:HARD ware" : Electrical measurement board hardware version	
2	SYSTem:ERror[:NEXT]?	Check next error item in the error queue, and delete the item from the queue. The error queue can store 50 pieces of error information. The last piece will be replaced by -350 "Queue overflow" in the case of over 50 pieces. System power off or *CLS order can remove error queue.	-	Error information
3	SYSTem:DATE?	Read system date	-	Year, month, day
4	SYSTem:TIME?	Read system time	-	Hour, minute, second
5	SYSTem:KLOCK<Boolean > ON OFF	Set screen lock	1 or ON: Lock screen ;	-

S/N	Command	Description	Parameter	Return Value
			0 or OFF: Unlock screen	
6	SYSTem:KLOCK ?	Read screen lock status	-	1 : Lock 0 : Unlock
7	SYSTem:MAINtenance:MODE<Boolean> ON OFF	Set system maintenance status	1 or ON: Maintenance start 0 or OFF: Maintenance stop	-
8	SYSTem:MAINtenance:STATE?	Read system maintenance status	-	Outlet pressure, positive, and negative pressure venting status InProgress : Being venting Completed : Complete venting Failed : Venting failed
9	SYSTem:COMMunicate:SOCKET:WLAN[:STATE]<Boolean> ON OFF	Set WIFI status NOTE : The serial port will be disabled if WiFi is on. During conversion time,	1 or ON : Turn on WIFI ; 0 or OFF : Turn off	-

S/N	Command	Description	Parameter	Return Value
		communicate with controller through the Ethernet.	WIFI	
10	SYSTem:COMMunicate:SOCKET:WLAN[:STATE]?	Read WIFI Status	-	1 : WIFI is on ; 0 : WIFI is off
11	SYSTem:COMMunicate:SOCKET:WLAN:ADDRESS<IP address>	Set WIFI IP address	IP address : Without quotation marks, the format is <NR1>.<NR1>.<NR1>.<NR1>	-
12	SYSTem:COMMunicate:SOCKET:WLAN:ADDRESS?	Read WIFI IP address	-	IP address
13	SYSTem:COMMunicate:SOCKET:WLAN:MASK<IP address>	Set subnet mask	IP address : Without quotation marks, the format is <NR1>.<NR1>.<NR1>.<NR1>	-
14	SYSTem:COMMunicate:SOCKET:WLAN:MASK?	Read subnet mask	-	IP address

S/N	Command	Description	Parameter	Return Value
15	SYSTem:COMMunicate:SOCKeT:WLAN:GATeway <IPaddress>	Set WIFI gateway	IP address : Without quotation marks, the format is <NR1>.<NR1>.<NR1>.<NR1>	-
16	SYSTem:COMMunicate:SOCKeT:WLAN: GATeway?	Read WIFI gateway	-	IP address
17	SYSTem:COMMunicate:SOCKeT:WLAN:MAC?	Read WIFI MAC address	-	MAC address
18	SYSTem:COMMunicate:SOCKeT:WLAN:DHCP[:STaTe] <Boolean> OFF ON	Set WIFI DHCP status	1 or ON: DHCP on; 0 or OFF: DHCP off	-
19	SYSTem:COMMunicate:SOCKeT:WLAN:DHCP[:STaTe]?	Read WIFI DHCP status	-	1: DHCP on; 0: DHCP off
20	SYSTem:COMMunicate:SOCKeT:WLAN:SSID? [ALL]	If this parameter is ALL, the search is performed, and returns all the search to the SSID name and encryption methods. If ignoring parameters, returns the current	-	{["ssid: encryption method"]}

S/N	Command	Description	Parameter	Return Value
		connection name and SSID encryption, no connection or not to return to the hot search""		
21	SYSTem:COMMunicate:SOCKET:WLAN:CONNECT <ssid>,encryptionMode[,<password>]	Connect to specific hot spot	1) ssid: Hot spot name, string with quotation marks ; 2) encryptionMode: encryption method , OPEN WPA WPA2 ; 3) password: password, string with quotation marks	-
22	SYSTem:COMMunicate:SOCKET:WLAN:CONNECT?	Read WIFI connection status	-	Successfully, Initialization, SSIDNotFound SSIDNotConfigured, JoinFaile

S/N	Command	Description	Parameter	Return Value
				ScanningConfiguredSSID WaitingIPConfiguration ModuleJoinedListeningSockets
23	SYSTem:COMMunicate:SOCKET:WLAN:DISConnect	Disconnect WIFI	-	-
24	SYSTem:COMMunicate:SOCKET:WLAN:DBM?	Read WIFI DBM value	-	DBM value , uint is dBm

A1.6 Status

S/N	Command	Description	Parameter	Return Value
1	STATUS:OPERation:ENABLE<enable value>	Set operation status enable register	Enable value: <numeric_value>, 0-65535	-
2	STATUS:OPERation:ENABLE?	Read operation status enable register	-	<enable value>:NR1
3	STATUS:OPERation[:EVENT]?	Read the value of operation status register. On execution of the command, the value of operation status register shall be reset.	-	<value>:NR1
4	STATUS:QUESTIONable:ENABLE<enable value>	Set problem data enable register	Enable value : <numeric_value>, 0-65535	-
5	STATUS:QUESTIONable:ENABLE?	Read problem data enable register	-	<enable value>:NR1
6	STATUS:QUESTIONable[:EVENT]?	Read the value of problem data incident Register. The value of the problem data enable register will be cleared after the command is executed.	-	<value>:NR1
7	STATUS:PRESet	Remove the value operation status enable register and problem data enable register	-	-

A1.7 Unit

S/N	Command	Description	Parameter	Return Value
1	UNIT:PRESSure<n><unit_name> <unit_ID>	Set pressure unit	Unit :Can be a unit name or unit ID, unit name is a string with quotes, unit ID is number.	-
2	UNIT:PRESSure<n>?	Read pressure unit	-	Unit name
3	UNIT:PRESSure<n>:ID?	Read system unit ID n= 1~3 1. Internal pressure module 2. External pressure module A 3. External pressure module B		Unit ID

A1.8 Data Record

S/N	Command	Description	Parameter	Return Value
1	DATALOGGER:COUNT?		Read the total number of data records	Result quantity
2	DATALOGGER:CAtalog? <Index>,<count>	Index: Starting position count : Qty. (0-5)	Read data record brief information (GUID, record name, operator, notes, record time, sampling number, sampling interval)	ClassName , Base64 character data , CRC16 check code (Data obtained by anti serialization)
3	DATALOGGER:LOGGerinfo ? <guid>	guid : Unique identifier for data records	Read a record information (the number of channels, channel information, etc.)	ClassName , Base64 character data , CRC16 check code (Data obtained by anti serialization)
4	DATALOGGER:DATA? <guid>,<start>,<length>	guid : Unique identifier for data records start : Relative starting position length :Length of information reading in one	Read log data	data ,Base64 character data , CRC16 check code (Data need to

S/N	Command	Description	Parameter	Return Value
		time (less than 750 bytes)		be converted into an array of byte, and then converted to float values for presentation)
5	DATALOGGER:DElete<guid>	guid : Unique identifier for data records	Delete record	
6	DATALOGGER:CLEar		Clear all records	
7	DATALOGGER:SEARChcount ? <Condition>	<p>Condition : Condition, strings with quotation marks</p> <p>Format : "Type,Param"</p> <p>Type: Searching method</p> <p>0: Result name</p> <p>1: operator</p> <p>2: Note</p> <p>3: Start and stop time</p> <p>Param: The parameters of the search method, separated by a comma.</p> <p>Muilt-condition searching are available.</p> <p>eg:</p>	Number of searching result which meets the condition	Result quantity

S/N	Command	Description	Parameter	Return Value
		DATALOGGER:SEARhcount? "0,test;1,sun;2,heihei;3,2000/01/28,2016/10/ 28"		
8	"DATALOGGER:SEARhinfo [:ECHO]? < Condition>,< Index>,< count>"	Conditon: Same as above Index: Starting position count : Qty. (0-5)	Read the brief information that satisfies the condition data record	ClassName , Base64 character data , CRC16 check code (Data obtained by anti serialization)

A1.9 HART

S/N	Command	Description	Parameter	Return Value
1.	HART:SUPPLYMODE?		Read power supply type	0 :Internal ;1 :External ;
2.	HART:SUPPLYMODE Int Ext 0 1	0 or Int : Internal ; 1 or Ext : External ;	Set power supply type (the electrical measurement will switch to HART measurement if power supply type is changed)	
3.	HART:SEARCHStart Stop Zero[,<Numeric>][,<Numeric>]	Start : Start searching ; Stop : Stop searching ; Zero : Only search where address is 0 NOTE: address range parameter can be added follow "Start" and "Stop", such as "0,15"	HART search ;	
4.	HART:DEVICES?		Return to the searched device list (address and	

S/N	Command	Description	Parameter	Return Value
			type)	
5.	HART:CONnect<address>	Address:	Connect to searched device	
6.	HART:ONLDEvice:PROces s?			PV or 0 : Process variable ; AO or 1 : Digital current value ; % or 2 : Percentage of pressure range ; SV or 3 : Secondary variable ; TV or 4 : Tertiary variable ; FV or 5 : Quaternary variable ;
7.	HART:ONLDEvice:PROces s PV AO % SV TV FV 0 1 2 3 4 5	PV AO % SV TV FV 0 1 2 3 4 5	Switching process variable	
8.	HART:ONLDEvice:PARame	name: parameter name	Read parameter	

S/N	Command	Description	Parameter	Return Value
	ter? <name>			
9.	HART:ONLDEvice:PARame ter[:ECHO] <name>,< "value" > <value>	name: parameter name value: Value (with a quoted string, or number)	Set parameter	
10.	HART:ONLDEvice:INFO?	No or < parameter name > parameter name listed below: Tag Manufacturer Devicetype Deviceid writeprotect date message descriptor finalassemble preambles universalrev hardwarerev softwarerev devicerev	Return HART device information	Returns all device information values when no parameters are entered; Corresponding parameter values returns when the parameter name is specified;

S/N	Command	Description	Parameter	Return Value
11.	HART:ONLDEvice:SENSor?	No or < parameter name > parameter name listed below: sn unit lrl url minspan	Return sensor information	Returns all device information values when no parameters are entered; Corresponding parameter values returns when the parameter name is specified;
12.	HART:ONLDEvice:OUTput?	No or < parameter name > parameter name listed below: unit lrv urv damping transferFunction	Return HART device output parameter value	Returns all device information values when no parameters are entered; Corresponding parameter values returns when the parameter name is specified;

Appendix 2: Unit

S/N	Unit Name	Unit Name in System	Unit ID in System
1	Pa	Pa	1130
2	kPa	kPa	1133
3	MPa	MPa	1132
4	hPa	hPa	1136
5	bar	bar	1137
6	mbar	mbar	1138
7	torr	torr	1139
8	atm	atm	1140
9	psi	psi	1141
10	gf/cm ²	GF	1144
11	kgf/cm ²	KGF	1145
12	inH ₂ O@4°C	INH2O	1147
13	inH ₂ O@68°F		1148
14	mmH ₂ O@4°C	H2O	1150
15	mmH ₂ O@20°C	mmH2O@20C	1151
16	ftH ₂ O@4°C	ftH2O@4°C	1153
17	ftH ₂ O@68°F	ftH2O@68°F	1154
18	inHg@0°C	inHg	1156

S/N	Unit Name	Unit Name in System	Unit ID in System
19	mmHg@0°C	Hg	1158
20	mtorr	mtorr	2001
21	lb/ft ²	lb/ft2	2002
22	tsi	tsi	2003
23	psf	psf	2004
24	inH ₂ O@60°F	inH2O@60°F	2005
25	ftH ₂ O@60°F	ftH2O@60°F	2006

Appendix 3: Software

The Additel 760 calibrator can work with 4 Additel software:

	Calibration Program	Data Logging		Task Management		Control
		Export	Recording	Uploading <i>(760 → Computer)</i>	Downloading <i>(Computer → 760)</i>	
ACal	✓			✓	✓	✓
PCal	✓					
Land		✓		✓		
Log II		✓	✓			

The ADT760 communicates with Additel software via a standard USB cable. Additel offers a cable below.

Order Info:

Model Number	Description	Picture
1311000019	USB to USB cable, 1 meter	

- ◆ Please connect ADT760 to computer by a USB to USB cable
- ◆ Please follow section A3.1, A3.2, A3.3, A3.4 for ADT760 driver installation
- ◆ Driver installation is only required once.

A3.1 Additel ACaI

Step 1. Additel/ACaI must be updated to version 1.1.2980 or later

Step 2. Follow ACaI user manual and select ADT760 as reference

Step 3. Click on "Start Cal", then click on the Manual Install icon

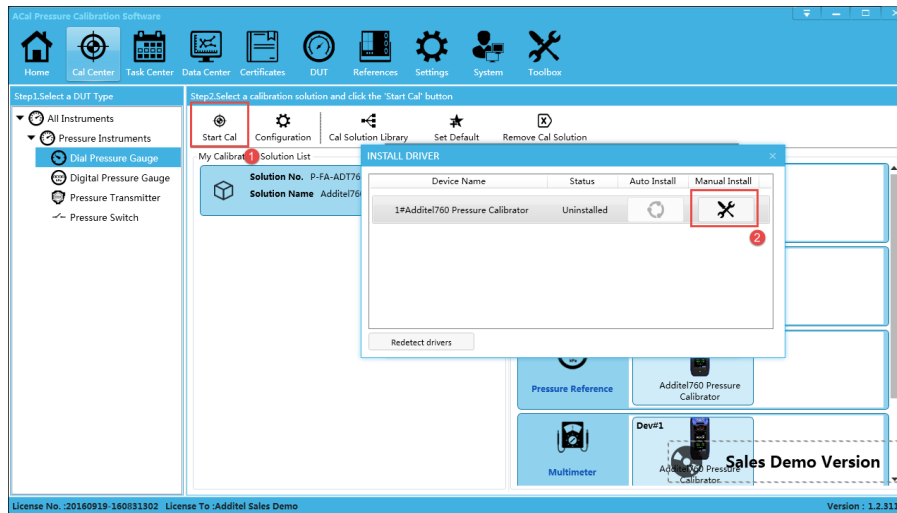

Step 4. Double click on "zadig.exe"

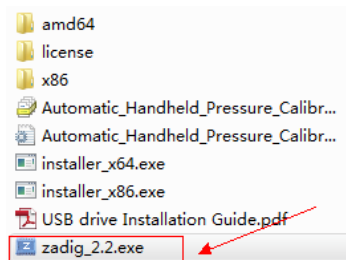

Step 5. Follow section A3.5 to install ADT760 driver

Step 6. Close the "zadig" program and the folder and check the driver status in ACal

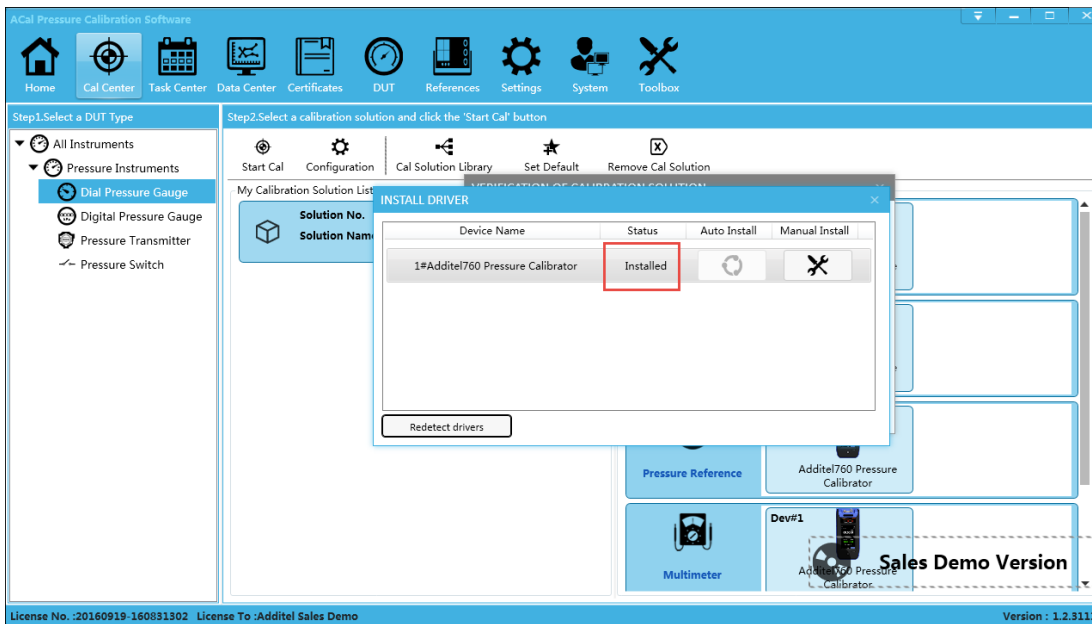

Step 7. After the ADT760 driver has been successfully installed, please follow ACal user manual for further operation.

A3.2 Additel PCal

Step 1. Additel/PCal must be updated to version 1.5.7 or later

Step 2. Click on Calibration Wizard

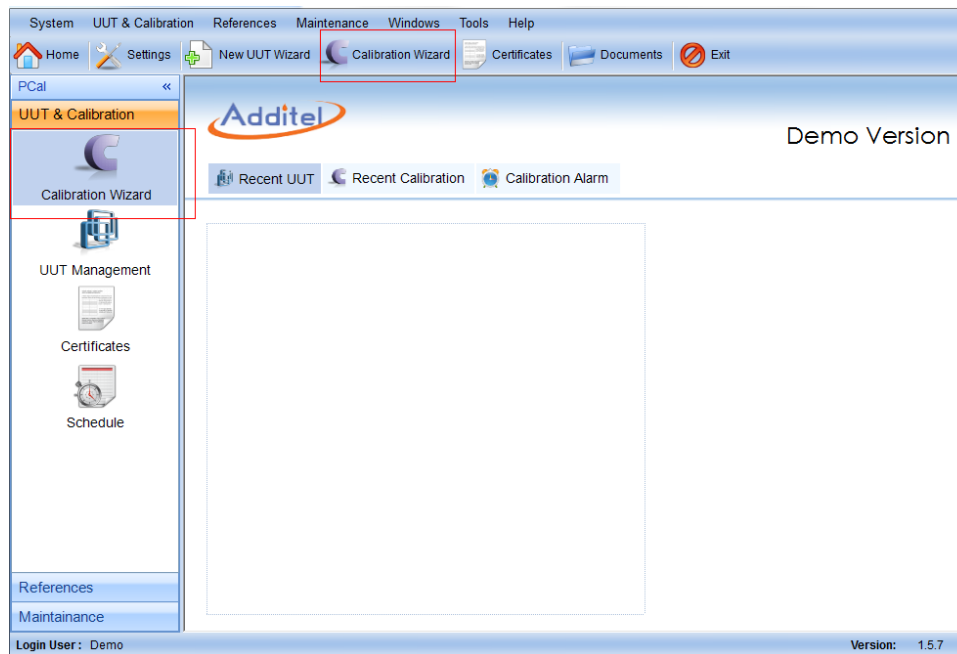

Step 3. Select UUT (Unit Under Test) type, then wait few seconds for the auto calibration reference detection

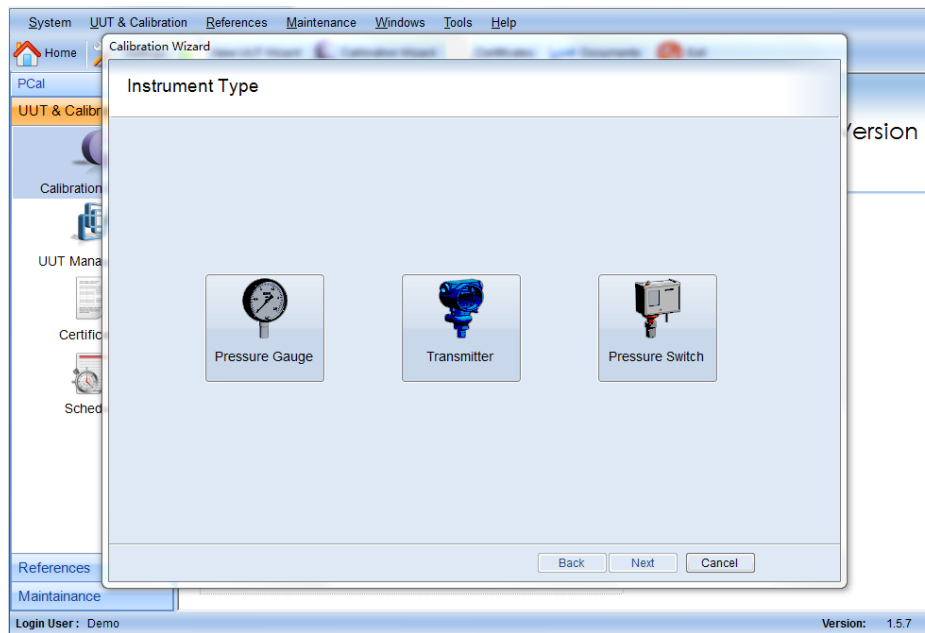

Step 4. Click on "Manual Install"

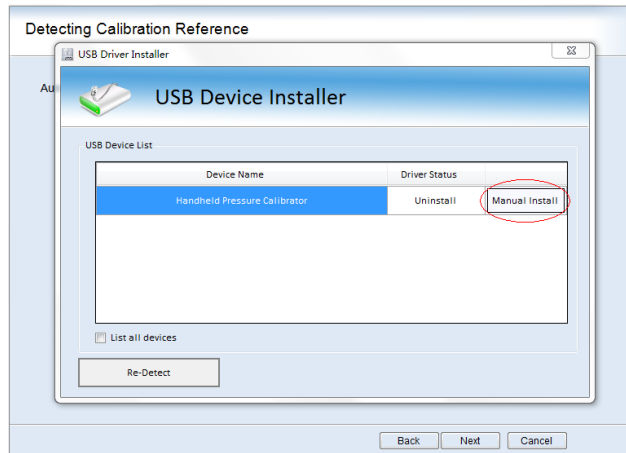

Step 5. Double click on "zadig.exe"

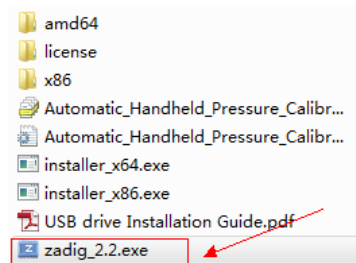

Step 6. Follow section A3.5 to install ADT760 driver

Step 7. Close the "zadig" program and the folder, then click on "Re-Detect" and wait for few seconds

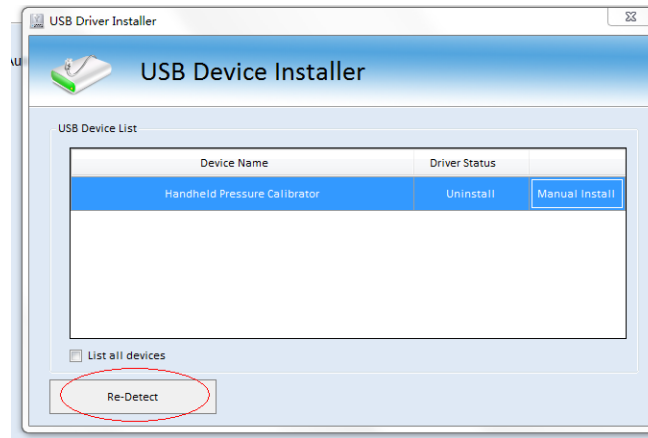

Step 8. Close the window and wait few seconds for re-detection

Step 9. When the ADT760 driver has been installed successfully, please follow PCal user manual for further operation.

A3.3 Additel Land

Step 1. Additel Land must be updated to version 3.5.8 or later

Step 2. Click on "Scan", then click on "Manual Install"

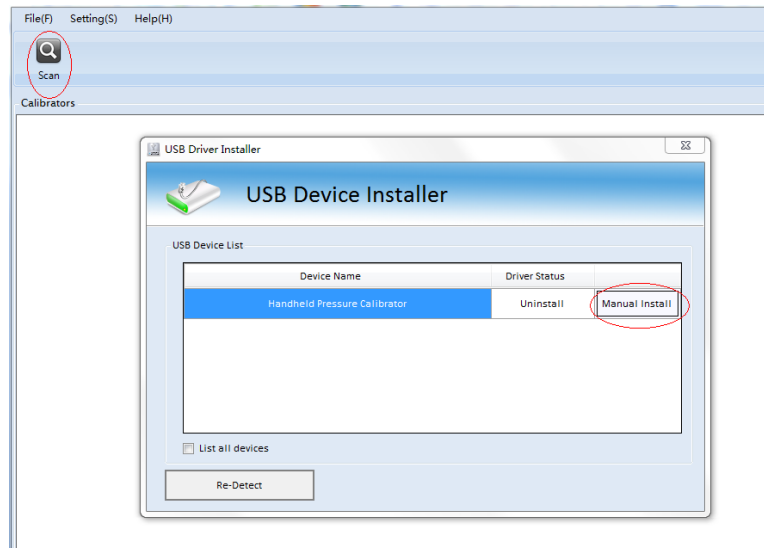

Step 3. Double click on "zadig.exe"

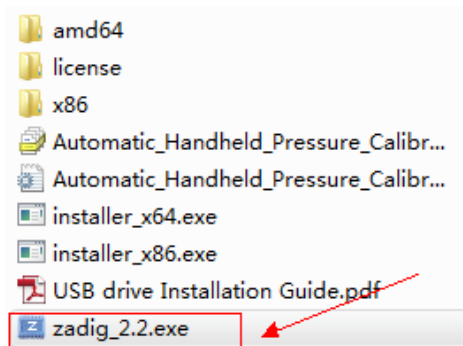

Step 4. Follow section A3.5 to install the ADT760 driver

Step 5. Close the "zadig" program and the folder, then click on "Re-Detect" and wait for few seconds

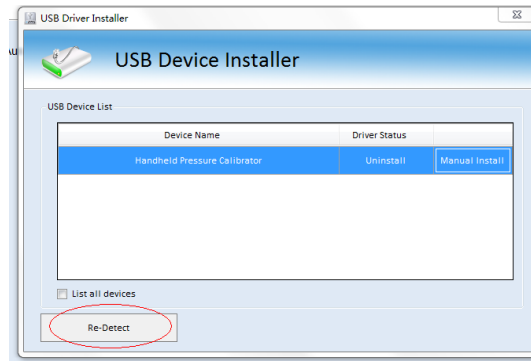

Step 6. Close the window and wait few seconds for re-detection

Step 7. When the ADT760 driver has been installed successfully, please follow Land user manual for further operation.

A3.4 Additel Log II

Step 1. Additel Log II must be updated to version 2.4.1 or later

Step 2. Wait for few seconds, then click on "Manual Install"



Step 3. Double click on "zadig.exe"

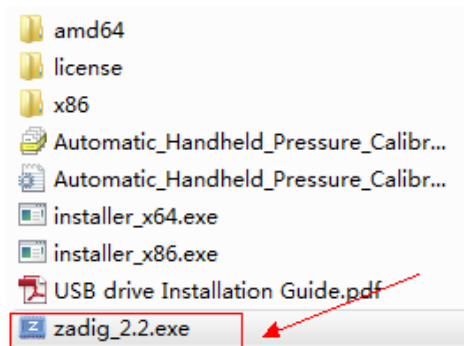

Step 4. Follow section A3.5 to install the ADT760 driver

Step 5. Close the "zadig" program and the folder, then click on "Re-Detect" and wait for few seconds

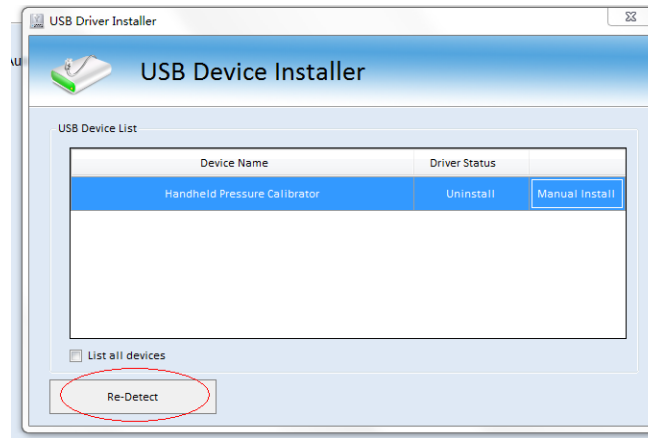

Step 6. Close the window and wait few seconds for re-detection

Step 7. Please follow Log II user manual for further operation.

A3.5 How to install ADT760 Driver by using Zadig

We suggest a third party software which is called Zadig to simplified ADT760 driver installation. This software is packed into all Additel software, no additional download required after initial installation.

Step 1. Right click "Zadig.exe", Choose "Run as administrator", then Select "Yes".

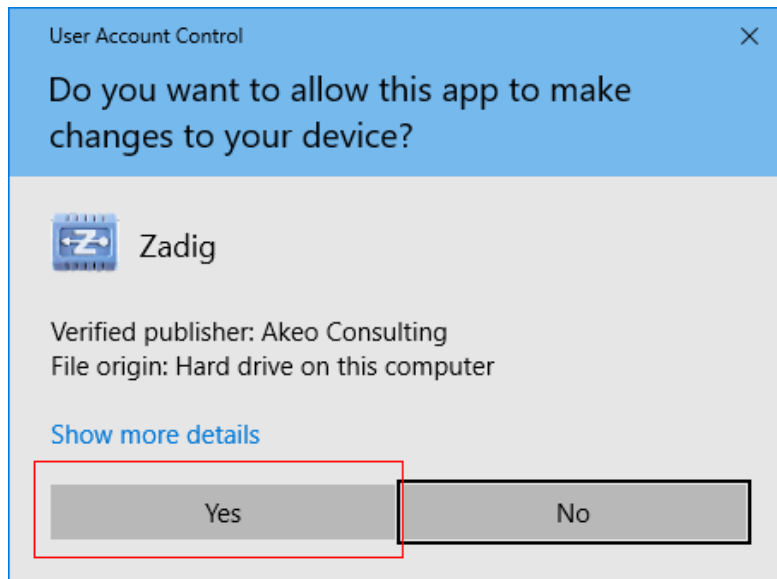

Step 2. Select "No" to skip update process.

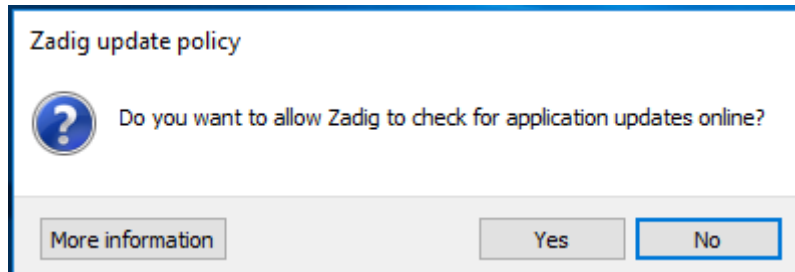

Step 3. In the first red Frame ,select “Generic Serial (PROTOTYPE—Remember to change idVendor) ”, In the second red Frame, select “Install Driver”.

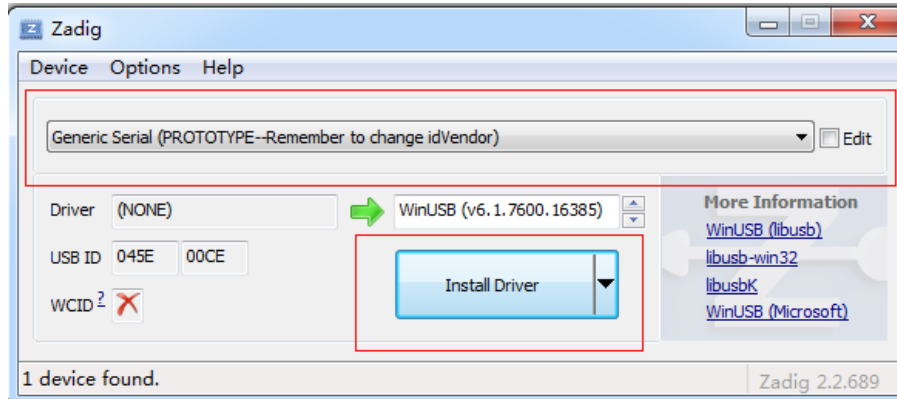

Step 4. Select “Always trust software”, and Click “Install” button. Wait for a few seconds for the driver installation.

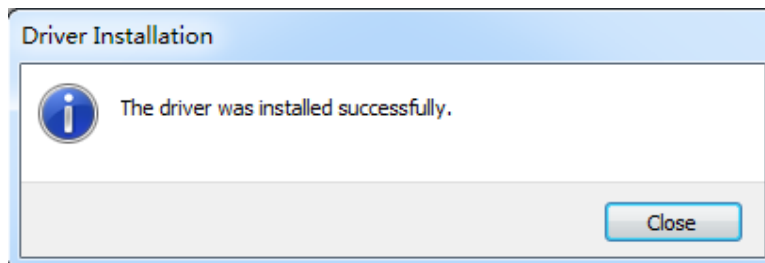
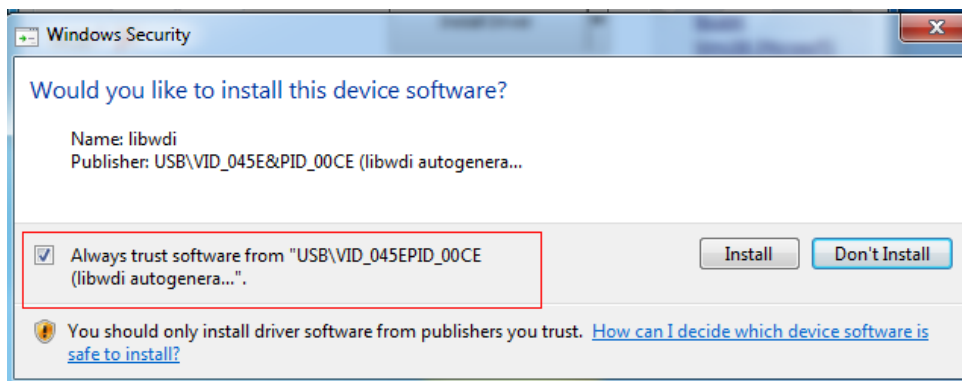

Check: In "**Device manager**" panel, there is a new option which means the Device drive has been installed successfully.

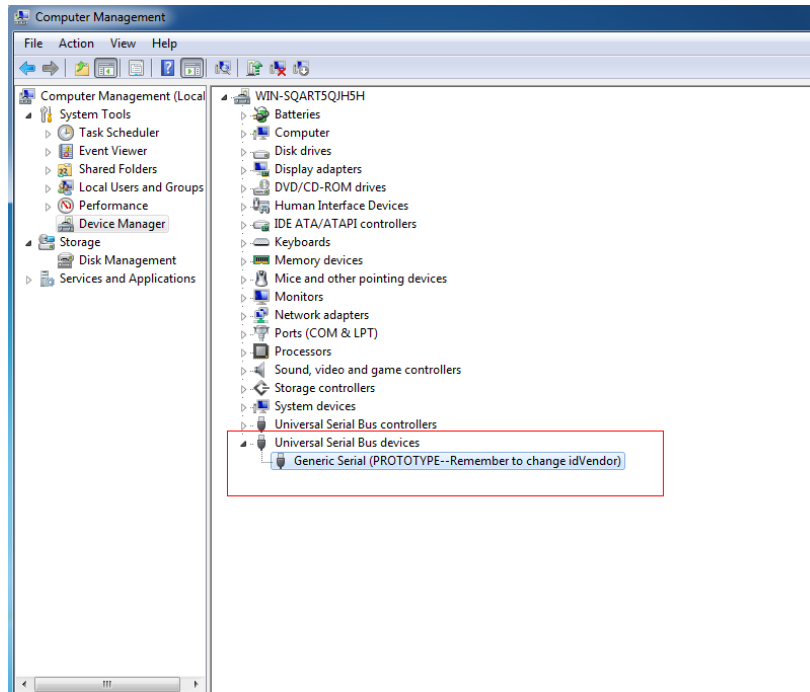



Additel Corporation

2900 Saturn St #B

Brea, CA 92821, USA

Phone: 714-998-6899

Email: service@additel.com

website: www.additel.com