



USER MANUAL

VA5 Pro A4404 – SAB Virtual Unit



Content:

VA5 Pro vs. A4404 – SAB	7
VA5 Pro.....	7
A4404 – SAB (Signal Analyzer Box).....	7
Before Switching On	9
General Warnings	9
General Information	10
Front View	10
Top View	10
Rear View (with IR camera connected)	10
Battery Charging	11
Switching on.....	11
Switching off.....	11
Sleep Mode	12
Auto Switch off	12
Emergency Switch off.....	12
Capacity Warning.....	12
Connection to the computer.....	12
Input Channels	14
IN1 Socket.....	14
IN2 Socket.....	14
IN3 Socket.....	15
IN4 Socket.....	15
TRIG Socket.....	15
Standard Cable Wiring	16
A4409 - BNC Box.....	16
Main Screen	17
Buttons.....	17
Modules	18
MENU button.....	18
Shortcuts.....	18
Battery Lifetime	18
PC Connection Indication	19
Touch keyboard.....	19
How to work with menus.....	20
How to work with lists	23
MENU	24
MENU / SETTINGS	25
Global Settings.....	25
Touchscreen	28
Keyboard.....	28
Language	28
Brightness	28
Appearance.....	28
Profiles	29
User Notes Settings	29
Date/Time.....	30
Shortcuts.....	30
Signal Source.....	31
Trigger Settings.....	31
Runup	35
Spectrum Settings.....	36
Sensors.....	36

ADASH	VA5 Pro
AC Sensors	37
DC Sensors	40
Tacho / External Sensors	41
Sensor Properties for Records	42
MENU / RUN	43
Stethoscope	43
Camera	43
IR Camera	43
Gallery	43
Calculator	43
Update	44
Help	44
Screenshot	44
Export All	44
About	45
Power Off	45
Speed detection	46
Analyzer	47
Basic concepts	47
Export Project to VA5_DISC (flash disk)	47
Project List	48
Project Menu	48
Graphs Screen	50
Measurement Definition in the Set	51
Input Buffering	56
Graph Max/Min	56
Buttons Modes	57
Set Menu	58
Meas Menu	59
Edit Measurement	67
Graph Properties	75
FASIT	85
Overall	86
Spectrum	88
Time	90
G-demod Spectrum	92
G-demod Time	93
G-demod Overall	93
amp+phase	93
Orbit	94
Filtered Orbit	95
Speed	96
ACMT	97
Orders	97
Order Spectrum (Order Tracking Analysis)	98
Phase Shift	99
DC	100
Frf	100
Octave Spectrum, Sound Level and Equivalent Sound Level	102
Center line	102
Smax	103
Complex Smax	103
Cepstrum	105
Ultrasound	105
Record	106

Route	107
Loading of the route to the instrument	107
Creation of the route tree in the instrument.....	107
Route Tree	107
Sensors Check.....	108
Measurement process	109
Route Meas Mode	110
Route Status	110
Last and reference values	111
Manual Entry	111
Notes.....	111
Speed in the Route.....	113
Limits.....	113
Export to VA5_DISC.....	114
Runup	115
Runup Measurement.....	115
Trends.....	116
Trend Menu.....	118
Recorder	119
Project List	119
Project Menu	119
Record Settings.....	121
Recording.....	122
Record Preview	123
Export to wav Settings.....	124
Temporary record.....	125
Balancer	126
Planes and Points	126
Project.....	126
Project List	126
Project Menu	127
Balancer Settings	128
Basic Settings	128
Units Settings	130
Rotor Settings	131
Single Plane Balancing.....	132
Dual Plane Balancing	140
Balancing Errors.....	147
Balancer Menu	148
Advanced Balancer	150
Project.....	150
Project List	150
Project Menu	151
Balancer Settings	152
Basic Settings	152
Units Settings	154
Balancing Procedure	154
Balancing Errors.....	161
Balancer Menu	161
FASIT	162
Adash Vibration Limits.....	162
FASIT Settings	164
Sensor Settings.....	164
Units.....	165
Measurement	165

ADASH	VA5 Pro
FASIT screen	165
Stethoscope	167
The delay of audio output	167
Playback Settings.....	167
Lubri - the greasing control	169
Two Ways How to Mount a Sensor.....	169
Procedure.....	170
Octave Analysis	172
Measurement Settings.....	172
Measurement	173
Octave Analysis Algorithm.....	173
Bump Test	174
Settings	174
Amplitude Trigger	174
Response Spectrum.....	175
Analysis.....	176
Buttons.....	177
ADS	178
ADS project.....	178
Project List	178
Project Menu.....	179
ADS Settings.....	179
Views	180
Buttons for Machine View.....	183
Buttons for Measurement View.....	183
Ultrasound.....	185
Sensor Setting.....	185
Settings	185
Measurement	186
Camera.....	187
Buttons.....	187
IR Camera	188
Operation	188
Focus	188
Warming Up	188
Cursor	188
Buttons.....	189
Temperature Calibration.....	189
IR Image Correction	189
Graph Properties.....	190
Gallery.....	192
Buttons.....	192
Buttons for maximized IR Camera picture	193
MCSA	194
Sensors Settings	194
MCSA Settings.....	194
Measurement	195
MCSA Screen	196
Errors and warnings	200
One phase measurement.....	200
A4404 – SAB and Virtual Unit	201
Installation.....	201

ADASH	VA5 Pro
Update	201
Operation	201
VA5 Virtual unit and VA5 Pro connection.....	202
Appendix A: Technical Specification	203
Inputs	203
Measurement Functions	203
Recording:.....	204
Balancing:	204
General:	204
Camera:	205
IR camera:.....	205
Appendix B : Phase measurement conventions	206
Single channel measurement with tacho	206
Dual channel measurement.....	209
Last reminder	209
Appendix C: Symbols and Abbreviations.....	210
Inputs	210
Abbreviations in Graphs	210

VA5 Pro vs. A4404 – SAB

The **VA5 Pro** instrument, the **A4404 – SAB (Signal Analyzer Box)** device and the **Virtual Unit** application will be described in this user manual. This chapter should clear up the difference between them.

VA5 Pro



VA5 is a portable vibration analyzer which is based on unique *Digital Signal Processing (DSP)* board developed by *Adash*.

A4404 – SAB (Signal Analyzer Box)



A4404 – SAB is a pocket size vibration analyzer which contains input connectors for sensors. It uses the same *DSP* board as *VA5* but it doesn't contain keyboard and screen. It must be connected to a computer via USB. You need to install **Virtual Unit** application which is the same software used in *VA5*. Almost all functions described in this manual work both in the instrument and in the *Virtual Unit*. You will be notified when some difference occurs. *Virtual Unit* and *A4404 – SAB* peculiarities will be described in a standalone chapter in the end of the manual.

ADASH

VA5 Pro



Before Switching On

Ignoring any recommendations mentioned below may cause failure of the device.
Operating with a power higher than 24 V can cause an accident.

General Warnings

Never connect higher than 30 V to the Analyzer!

Only suitable ICP powered sensors can be connected to the AC signal inputs.

If the measurement without ICP power is required, ICP power must be switched off. You can damage the external signal source, which is not protected against ICP powering.

AC channels - voltage higher than ± 18 V (peak) can damage the instrument.

DC channels - voltage higher than ± 30 V (peak) can damage the instrument.

Always use only original cables designed for connection with sensor.

Use only the original charger with the original connector.

Never use any reduction to connect the charger with the instrument.

Use the charger only if the instrument is turned off. Only charge the instrument indoors, in dry environment without vibrations.

Long push and hold of *Power* button evokes incorrect instrument switching off. Data could be lost.

If you are unsure, contact your distributor or the manufacturer.

General Information

Front View



Top View



Rear View (with IR camera connected)

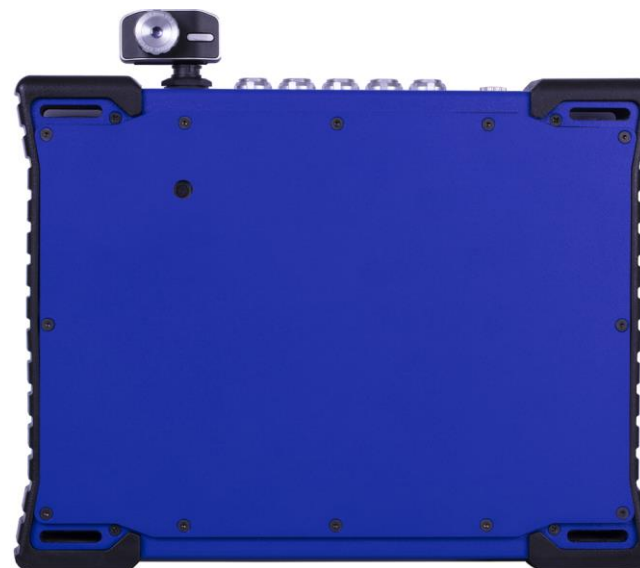

Battery Charging

Charge the battery only at 0 - 40°C (30 - 100 °F)!

Do not use the charger during measurement (higher noise).

The socket for external charger is on the top panel. The battery LED diode lights orange during charging and lights green when fully charged.

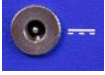

The VA5 instrument uses Li-ION (LiON) batteries. This type of battery should not be discharged completely. If the battery is discharged below certain Voltage, we call it deep discharging. The deep discharging shortens battery life. The charging of deeply discharged battery takes much longer.

If the instrument is not charged for longer period of time, then the deep discharge can occur. It is caused by self-discharging of the battery. It is also a common mistake to switch the instrument to sleep by pushing the *Power* button instead of switching it totally off. When the battery is deeply discharged, it takes much longer to charge it again. Sometimes the indicator on the charger does not light when the battery is deeply discharged – it does not mean it is not charging. Please keep the battery charging even if the indicator does not light, the indicator will start light later.

To avoid deep discharge of the instrument, charge it regularly, even when you don't use it. We recommend you to check if it is charged every 3 months.

WHAT TO DO WHEN YOU CANNOT SWITCH ON THE INSTRUMENT/ WHEN THE INSTRUMENT CANNOT BE CHARGED NORMALLY:

- **Discharged battery**
battery needs to be charged (charging for approximately 5 hours), the instrument can be switched on normally with the charger connected
- **Deeply discharged battery, when the instrument wasn't charged for longer period of time**
the instrument needs to be charged completely until the indicator on the charger starts light green. It can take more than 12 hours. The indicator on the charger does not light from the beginning of charging process. Sometimes it is not possible to switch on the instrument even with the charger connected.
- **Damaged charger**
when the charger is connected, the indicator should start to light (green or orange color), only with deep discharge the indicator does not light immediately.
- **Sudden decrease of battery life**
the instrument needs to be charged and discharged completely few times (usually 2-5 times). The battery lifetime should increase this way.

Switching on

The **Power** button is in bottom left corner of the front panel. Push the button for a few seconds until a power LED begins to light. First it blinks orange for a while, then it lights blue. A keyboard backlight blinks for a while.



Switching off

Use a **Power Off** in main *MENU* and confirm.

Attention! The *Power* button (intended for the switching on) doesn't turn the instrument off. It switches it into a sleep mode!

Sleep Mode

Use the *Power* button to switch the instrument into a sleep mode. The screen is off and power consumption is lower in the sleep mode. Use the same *Power* button to wake up again.

Note! You can use any button to wake the instrument up. However, notice that the button push isn't ignored by the system even in the sleep mode and the push can cause some unexpected event in the application. The reaction to the button push is same like not being in the sleep mode.

Auto Switch off

If no button is pushed in 5 minutes from switching on, the instrument will be switched off.

Emergency Switch off

This is not correct method to switch the instrument off. Using it can cause data corruption. Use this method only in case of emergency (e.g. when the system freezes).

Push and hold the *Power* button for about 10 seconds. Instrument will switch off.

Capacity Warning

If this warning message appears, you need to get free disc space by removing the measurements, routes or records, which are not needed.

90% of disc is full.
Longer measurements not available.

Connection to the computer

VA5_DISC

All data like projects, measurements, readings, setups and so on are stored to a high capacity hard disk which is intended for internal purposes only. Furthermore, the instrument contains the **VA5_DISC**, it is a flash memory, which is accessible from external computer. The **VA5_DISC** is an interface for data. For example, you save a route from *DDS* to the **VA5_DISC**, the instrument copies it automatically to hard disk. Then you measure the route and then you export the route back to the **VA5_DISC**. Here you can read it from computer. You don't need to export all data from internal hard disk. Export only the data which you want to read from computer. A detailed description how to export will be stated later in chapters about project's control for each module.

Connection

To make a connection between computer and instrument (more precisely its **VA5_DISC**) use the USB cable which is the standard accessory.



The connection to PC is indicated by icon located on the bottom right corner next to battery icon. For data download you must be in the main screen.

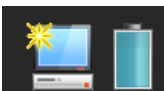

If you are not on main screen, the *VA5_DISC* remains accessible to the instrument processor and you cannot see it in your PC. The correct connection with PC is announced by the message box.

Connected to PC

To prevent data loss, always use **Safely Remove Hardware** icon on your computer before unplugging the USB cable!

VAX_DISC

Sometimes you may need higher capacity interface disk than the *VA5_DISC* (16GB). You can connect any external disk via USB. In order to the instrument is able to recognize your disk, you must name it as ***VAX_DISC***. Use a standard USB OTG cable (see bellow) to allow the instrument to act as a host. Connect the small plug to the instrument's USB socket then connect the *VAX_DISC* to the OTG's socket. When *VAX_DISC* is connected the instrument prefers it against *VA5_DISC*.

Note! The OTG cable is not a standard accessory of VA5 set.



Input Channels

All input sockets are in the top panel.

The input sockets IN1, IN2, IN3, IN4 are used for AC and DC signals. The TRIG input socket is used for trigger signals, usually tacho. All sockets have several pins. It enables to connect more signals to one socket (see wire diagrams).

The AC inputs enable to measure max voltage peak +/-12V. The DC channels enable to measure max +/-24V.

NC - not connected

GND - ground

SHLD - shielding

IN1 Socket

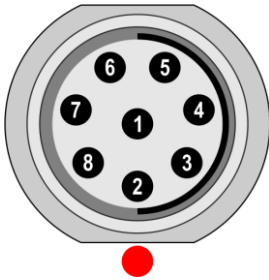

1 – NC or GND

2 – +5V/0.1A

3 – **DC1**

4 – NC

5 – SHLD

6 – +20V/5mA

7 – **GND**

8 – **AC1**

Attention! Pin 2 of IN1 socket (ultrasound sensor powering) is internally connected with pin 2 of TRIG socket (tacho probe powering).

IN2 Socket



1 – NC or GND

2 – AC4

3 – **DC2**

4 – AC3

5 – SHLD

6 – AC1

7 – **GND**

8 – **AC2**

Note! Pay attention to possibility of connecting all four AC channels to **IN2**.

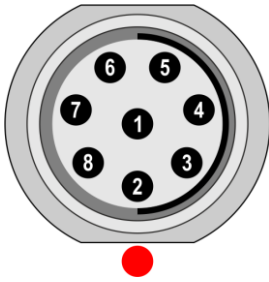
IN3 Socket

- 1 – NC or GND
- 2 – DC2
- 3 – **DC3**
- 4 – DC4
- 5 – SHLD
- 6 – DC1
- 7 – **GND**
- 8 – **AC3**

Note! Pay attention to possibility of connecting all four DC channels to IN3.

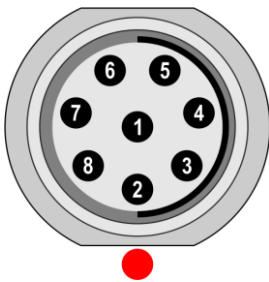
IN4 Socket

- 1 – NC or GND
- 2 – NC
- 3 – **DC4**
- 4 – NC
- 5 – SHLD
- 6 – +20V/5mA
- 7 – **GND**
- 8 – **AC4**

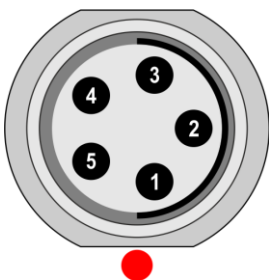
TRIG Socket

- 1 – TRIG
- 2 – +5V/0.1A
- 3 – SHLD

Attention! Pin 2 of IN1 socket (ultrasound sensor powering) is internally connected with pin 2 of TRIG socket (tacho probe powering).

Standard Cable Wiring

The standard cables, which are the part of the VA5 set, have the sensor signal connected to the pin number 8. The second sensor wire is connected to the ground (pin 7).

When you use this cable:

In IN1 socket, the signal will be measured on CH1.

In IN2 socket, the signal will be measured on CH2.

In IN3 socket, the signal will be measured on CH3.

In IN4 socket, the signal will be measured on CH4 (ver. 2.0 and higher).

If you want to use the tri-axial sensor, then you have to use the IN2 socket (pins 6, 8, 4) + ground (pin 7). You need the special cable for this purpose.

A4409 - BNC Box



This box can simplify the connection of more cables to VA5 inputs. The BNC input connectors are used on the top panel for connection of 4 AC channels and 4 DC channels. On the side panel are two connectors, which enable to connect all 4 AC channels to IN2 input and all 4 DC channels to IN3 input. See the wiring diagram of IN2 and IN3 in previous chapter. You see, that all 4 AC channels can be connected to one input IN2. In the same way all 4 DC channels can be connected to one input IN3.

Main Screen



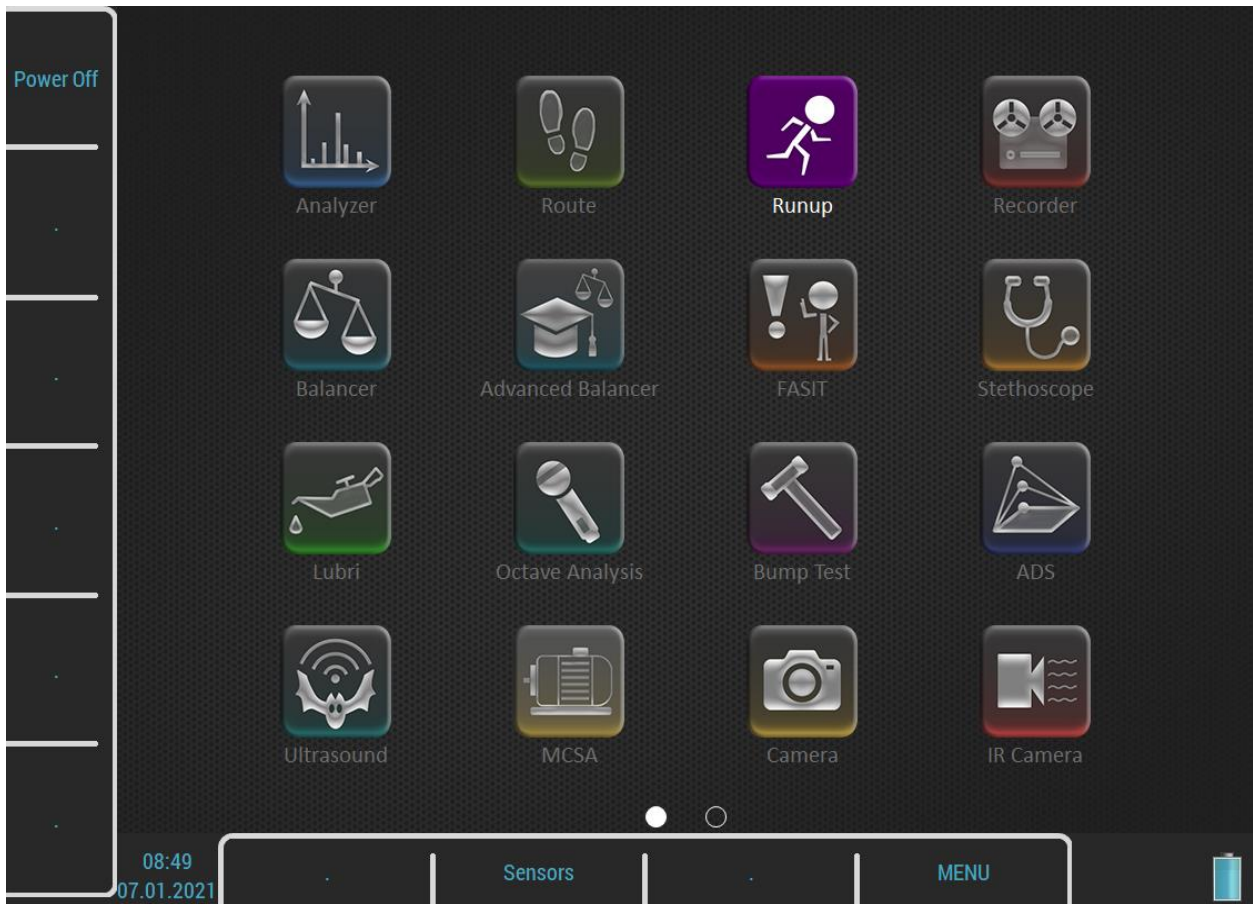



After initialization, the main screen appears.



You can control the instrument by buttons around the display or by touch screen.

Buttons

Buttons on right side have these meanings:

-  *Escape*
-  *Up*
-  *Left*
-  *Right*
-  *Down*
-  *Enter*



Backspace



Tab



Home

The meaning of next buttons can vary and is always written on the screen near the button. Such approach enables to use one button for many functions depending on actual needs. You can press the button or tap the touch screen to call the function.

Modules

The VA5 instrument contains many modules. Each module has an icon on the main screen. Select an icon using arrows or tap. Push *Enter* button or double tap to open a module. Each module will be described in separated chapter.

MENU button

The **MENU** button opens an instrument's main menu. This button is available on most screens.

Shortcuts

Left side and bottom buttons have no meaning on the main screen. They can be used for user defined shortcuts. You can define the meaning for each free button in [MENU / SETTINGS / Shortcuts](#). The free button is marked with the "." (dot) symbol. You can call the [Shortcuts](#) menu also by pressing the free key. In this case the dialog setups only the pressed key.

Two shortcuts are set by default, the **Power Off** on button 1 and The **Sensors** on button 8. You can change these shortcuts as well.

The button 8 is something special for shortcuts. A shortcut defined on this button is available also in other screens, not only on the main screen.

Battery Lifetime

The information about % of battery lifetime is displayed in the right bottom corner of the display.



Battery lifetime 75 – 100 %



Battery lifetime 50 – 75 %



Battery lifetime 20 – 50 %



Battery lifetime 8 – 20 %



Battery lifetime 7 %



Battery lifetime under 7 %. Instrument is switched off under 3%.

PC Connection Indication



It is shown next to the battery icon when instrument is connected to PC. More detailed description about connection is in [General Information](#) / [Connection to the computer](#).

Touch keyboard

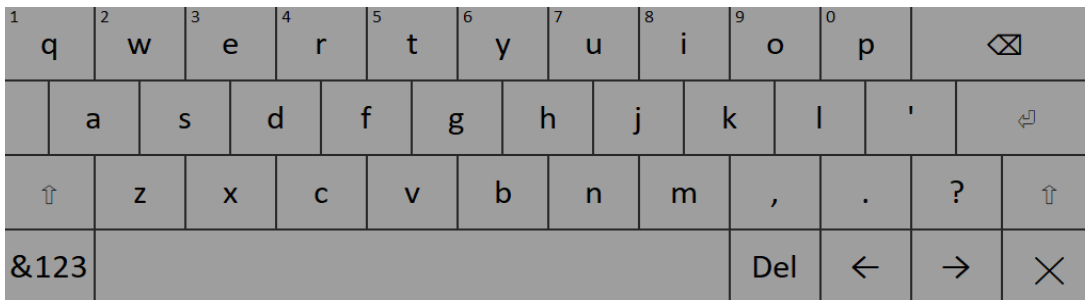

Touch keyboard is automatically opened when you enter a text. You can write by tapping keys on the keyboard.

By holding a key for a while you obtain an offer of alternative characters. Choose a character by moving on it and release.

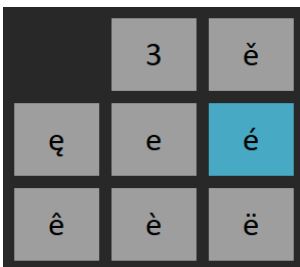

There are a few control buttons:

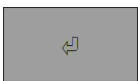

Enter confirms the text.



Escape cancels the text entering.



Backspace moves cursor one position backwards and deletes character on that position.



Shift switches the keyboard to enter upper case letters.



If you press the **shift** key it becomes selected. Letters on keyboard are changed to upper case. When you enter one letter the keyboard automatically returns to enter lower case letters.



letters.

Push the **Shift** key twice and it becomes **Caps Lock**. This keeps writing upper case



Switches the keyboard to enter numbers and symbols.

Note! You can enter a number also by pressing and holding a letter in first row. Letters from first row have number as an alternative character. The number is written in top left corner of the letter key.



Delete deletes one character on current position.



Left arrow moves cursor one position backwards.



Right arrow moves cursor one position forwards.

How to work with menus

You have to define many parameters for using the instrument. All those definitions are providing by menu items and windows. The procedure for operation with all is the same. We describe it on one example, the sensor properties definition.

Item Selection

Push **MENU** button to open instrument's main menu. Use arrow buttons and **Enter** or double tap an item to select it. Select and open **Sensors** menu.

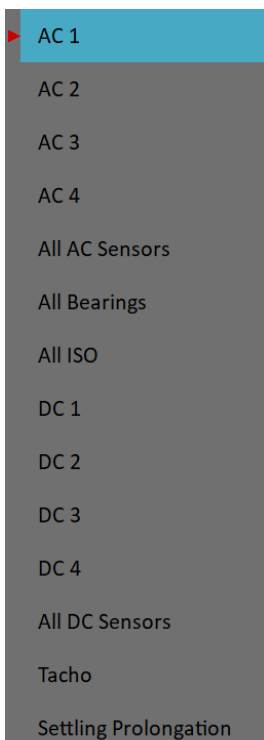

Next, open any AC sensor menu.

ICP	on
Sensitivity[mV/g]	100
Unit	g
Position[°]	undef
ISO Machine Group	undef
Bearing Type	undef
Save	

Value Selection

Use up and down arrows to highlight an item, e.g. **Sensitivity**. Then push *Enter* or right arrow. Alternatively, you may tap the parameter you want to setup to open submenu with possible values. Select a value by tapping or pushing *Enter*.

ICP	on	1
Sensitivity[mV/g]	100	10
Unit	g	100
Position[°]	undef	user
ISO Machine Group	undef	
Bearing Type	undef	
Save		

User Defined Values

You can select predefined sensitivity or you can enter a number (for example 45 mV/g). Select the **user** item. A text entry dialog opens.

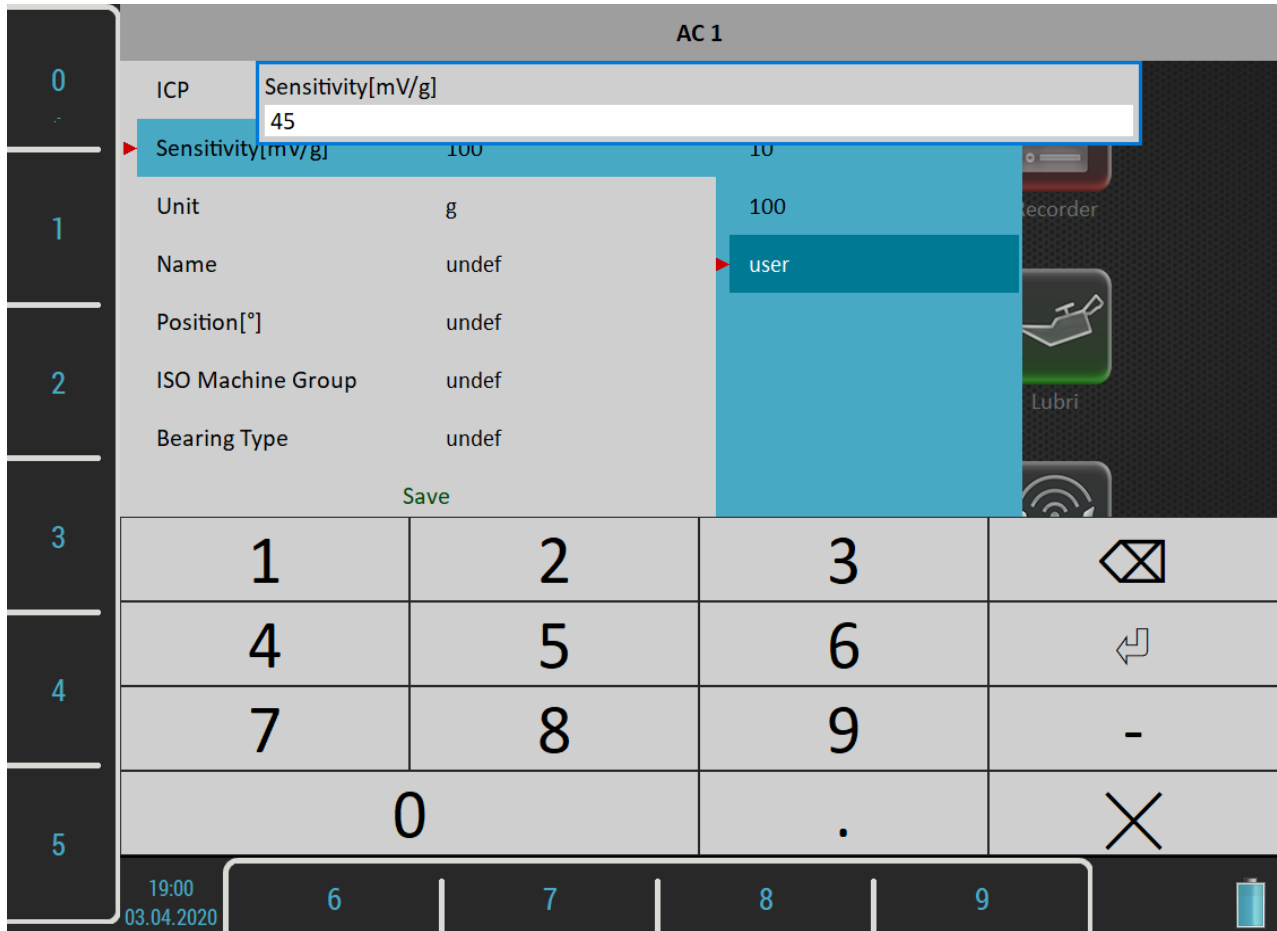

You may enter the number using buttons around the display. Decimal point or minus symbol are defined by several pushes of **Zero** button. Use **Backspace** button to delete entered characters. Use **Enter** button to confirm the value or **Escape** button to leave without any change. You may also enter the number using touch keyboard.

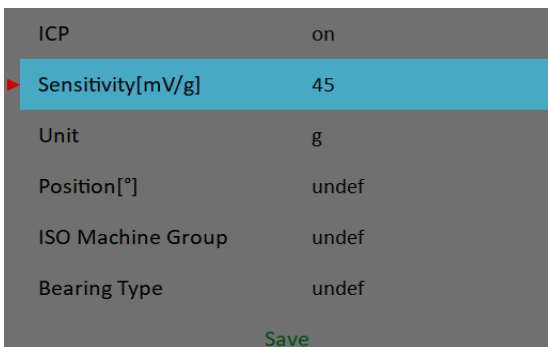

As we mentioned the value entry, also the text has to be entered in some menu items. The screen looks similar to the numerical screen. The only difference is the characters selection on buttons. It works like mobile phones keypad, for second character selection you must press the button two times.

Values Confirming

The last item of all menus is **Save**. When you select this item the menu closes and all values you have set will be saved. The **Save** button at the top left also has the same meaning. When **Escape** button is used then menu is closed without saving anything.

How to work with lists

Multi-selection of Items

Sometimes you may need to work with more items together. The usual example is the deleting of more items in one step.

The left button **Multi on / Multi off** enables to select more items at once. The text of the button indicates which mode is just active. Push the button to change the mode. When you move in the list by arrows and the multi-selection is on, you can select (or unselect) more items. The *Escape* button cancels all selections.

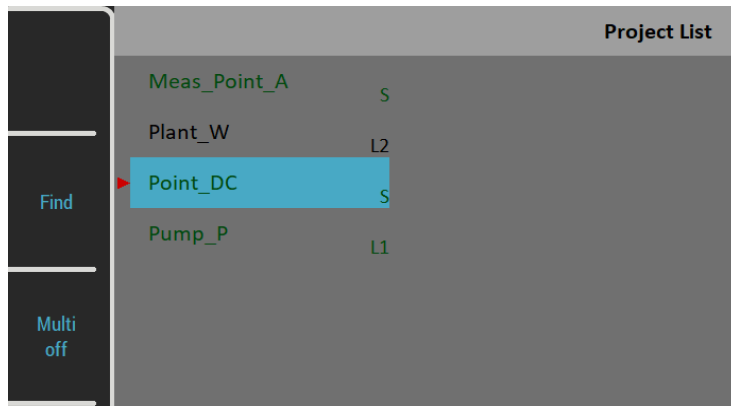

Searching an Item

If the list is too long or you know the name, then use the **Find** button. Enter the name or part of name and confirm.

MENU

Push the **MENU** button. Instrument's main menu is separated into two parts. Items in a **SETTINGS** part are used for opening next menus and items in a **RUN** part activate some tasks.

MENU		
SETTINGS		RUN
Global Settings	Signal Source	Stethoscope
Touchscreen	Trigger Settings	Camera
Keyboard	Runup	IR Camera
Language	Spectrum Settings	Gallery
Brightness	Sensors	Calculator
Appearance		Update
Profiles		Help
User Notes Settings		Screenshot
Date/Time		Export All
Shortcuts		About
		Power Off

MENU / SETTINGS

This section describes particular menus. Parameters descriptions contain also lists of possible values. Default values will be underlined.

Global Settings

Display Route Values

on, off

When you want to go faster during the route and you do not want to look at measurement results after each point, then set it **off**.

Route Autosave

on, off

When set to **on**, the data are saved after taking measurement at each point by itself. When set to **off**, then the user has to save it manually.

Route Auto Forward

on, **off**

After saving values, a screen with results automatically closes and a list of points appears. Next measurement point is selected. The necessary condition is, that all measurements from last point are taken and correctly saved.

Check Route Sensors

yes, no

Each point in the route contains the sensors setting, which is defined in *DDS*. The instrument contains also the sensors setting (menu [Sensors](#)). Both settings are compared for each point during the route readings. When the sensor setting in point is not equal the sensor setting in instrument, then the "**Used sensor**" window appears. It is the warning to the user. This check can be turned off by setting **no**.

Used Sensor
on AC1: 100 mV / g, ICP on

Display Small Values

on, **off**

When you are interested to see values under the 0,001, then set it to on and the values will be displayed in scientific notation (for example 5.26e-6). Otherwise the 0 (zero) will be displayed for small values.

Stop if ICP Error

on

The measurement is stopped, when ICP error occurs.

off

The measurement continues, ICP error is only informative.

Units

metric, imperial, both

Units available in menus.

Frequency unitHz, RPM, CPS, CPM**Speed unit**Hz, RPM, CPS, CPM**Power/Line Frequency**It is used for *Elect* value in synch table, which is displayed for spectra ([Synch Table](#))**Phase range**(-180, 180) , (0, 360)

Range of phase values

Displayed Spectra in Cascade32, 128, 256, 512, 1024

Number of displayed spectra in waterfall (cascade) graph. It is not the number of measured spectra!

Align Graphson, off

If more graphs of the same type are displayed, then the Zoom and Cursor function of all graphs can be aligned.

Graph Gridon, off**Cursor Type**linear, maxs

This item must be deeply explained. The graph width (for example spectrum frequency axe) is displayed on the approx. 600 screen pixels. But the spectrum could have 25600 lines and then 42 lines is displayed in one pixel line ($42=25600/600$). This number of lines in one graph pixel is different for other total line number and used zoom. In the older instruments we used the cursor movement procedure by lines. It means that the cursor moves inside one pixel without any real move on the screen. The users complained about it. Now we have used another procedure. The cursor moves by pixels, not by lines. In each pixel is hidden more lines and the cursor must display one specific line. What line should we use? When the Cursor type is set to **linear**, then the step of cursor movement is the number of lines in one pixel. When the **maxs** is set, then the cursor always moves to the maximum line, which is contained in one pixel.

Record analysis speedfast, real time

A record could be analyzed in two ways. Let's suppose the record length is 300 sec, it could be for example run up record. You want to measure the amp+phase measurement during the record. If you want to watch the continuous results, then select the **real time** mode and the processing of record will take 300 sec (the analyzing time is the same time as the recording time was). If you want to save results to the memory and not to watch them on the screen, then select **fast** mode. The analyzing time will be much faster than 300 sec. You can also imagine, that it is like tape recorder. You can push the button play (real time) or rewind (much faster). The instrument enables to analyze record also in fast (rewind) mode. It enables to analyze for example 1 hour length in several seconds.

Record Analysis Startcontinue, begin, again, ask

These options are used when the record is selected for analysis.

It would be better to use example for explanation. For example we use record which length is 60 sec. We define time signal measurement which length is 8 sec. It means when we push Start button, the reading takes 8 sec and position of cursor moves of 8 sec in record.

continue

The next reading will start on the end of last reading.

begin

The next reading will start on the beginning of record.

again

The next reading will start on the beginning of last reading.

ask

The user select any option before the reading.

When you moved the cursor manually, the next reading will always start from that position.

Wav Encoding

PCM, 24 bit, PCM, 16 bit

This is a setup of encoding for wav exports. The PCM is the shortcut for pulse-code modulation which is the most common way to encode signal into wav format. The number behind the PCM shortcut represents the number of bits per sample or bit depth.

The VA5 instrument uses 24 bit A/D converter, therefore 24 bits per sample is the default bit depth for the wav export. However, some software doesn't allow to process this bit depth and then the more common 16 bits per sample encoding can be used.

Note! The sample rate of the wav is same as sampling frequency of the exported signal and cannot be changed in the instrument. If you need to change it you need to use a 3rd party application to resample the exported wav (e.g. Audacity).

Angles Counting

with rotation (°WR), against rotation (°AR)

You can define the direction of angles (phases). The selected choice is then signed behind degree mark as WR (with rotation) or AR (against rotation).

Note! Although almost all degree symbols in the application are labeled with WR or AR mark you don't see this in the manual because many of the screenshots were taken before Angles Counting was implemented.

With rotation:

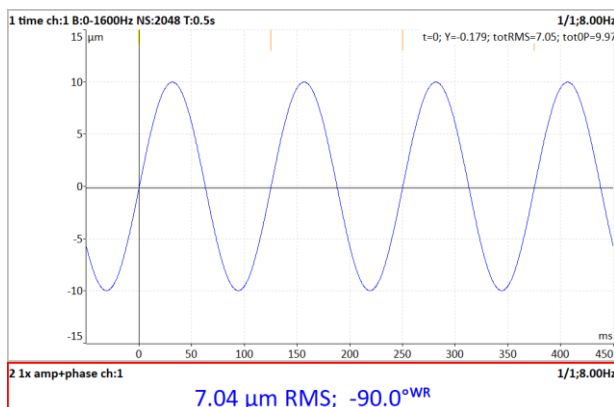

Against Rotation:

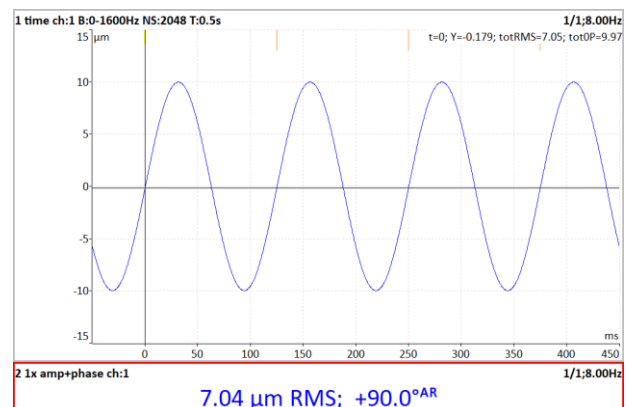

On the pictures above, you can see the time waveform with tacho marks. The tacho mark comes 90° before the maximum of the signal in the direction of rotation. If we choose the **with rotation**, then we say the tacho mark is 90° before the signal maximum and thus the angle (phase) is **-90°**.

In case of **against rotation**, we say the signal maximum is 90° behind the tacho and the angle is **+90°**.

The main use of this parameter is in balancing. Some users are used to count angles with rotation and other users want to count against rotation. The instrument enables to set your required direction.

Warning! By changing this value, all angles (phases) become opposite. Therefore, do not change it between readings if you want compare phases.

Touchscreen

Enable Touchscreen

yes, no

Keyboard

Keyboard Backlight

on, off

The keyboard backlight is always off after instrument's startup. This setup is not saved.

Language

Language

Select your language.

Brightness

Not for Virtual Unit!

Screen brightness settings

Appearance

Interface Style

For Virtual Unit only!

old (VA4 I), old (VA4 II), new (VA5)

You can choose which user interface the *Virtual Unit* uses, **VA4** or **VA5**. The change takes effect after the application restarts.

Use Right Buttons

Not for *Virtual Unit*!

yes, no

You can turn right buttons on on display and then push them on touch screen like in *Virtual Unit*. The change takes effect after the application restarts.

Attention! The useable area of display decreases while using right buttons. The PC connection icon is not visible.

Background Color

black, white

Background color of graphs

Profiles

All instrument parameters can be saved to the **Profile**. It is useful for example for saving of sensor sensitivities.

Save settings to "just opened profile name"

Save the parameters to the currently opened profile (updates the profile). **Note!** You have to create and open a profile otherwise this item is not visible.

Save settings as new profile

Save the parameters to the new profile (after name entry).

Factory

Open the factory default profile.

List of saved profiles

Select an existing profile. The **Delete** button removes selected profile.

User Notes Settings

You can create text notes in the instrument and attach them to various items, e.g. to route points. There are three ways how to enter a note text.

1. Enter the note text manually.
2. Select predefined note from **Factory notes** set.
3. Select predefined note from **User notes** set.

The user notes set is created and edited by user here, under the *User Notes Settings* menu item.

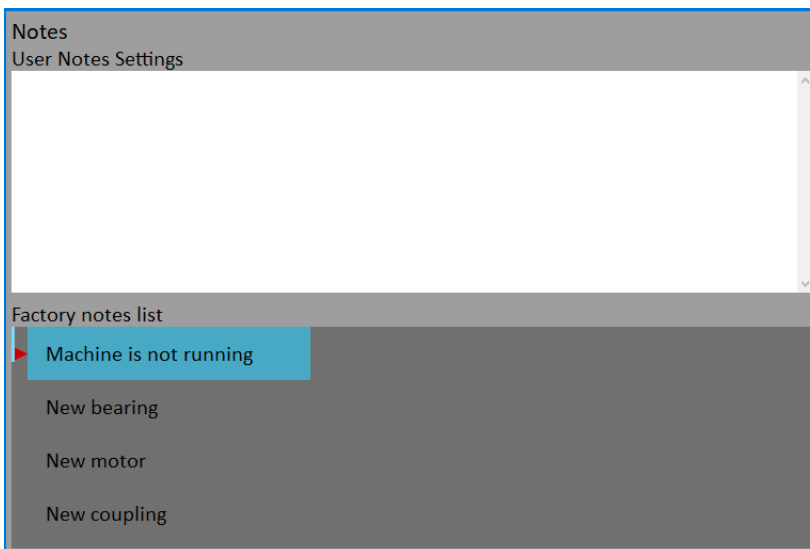

In upper half is the list of existing *User notes* (now empty). The predefined *Factory notes* are displayed in lower half.

Because usually the user wants to use only the *User notes*, you can copy any factory note to the user notes. Select it by arrows and push **Select** or *Enter* button or double tap it.

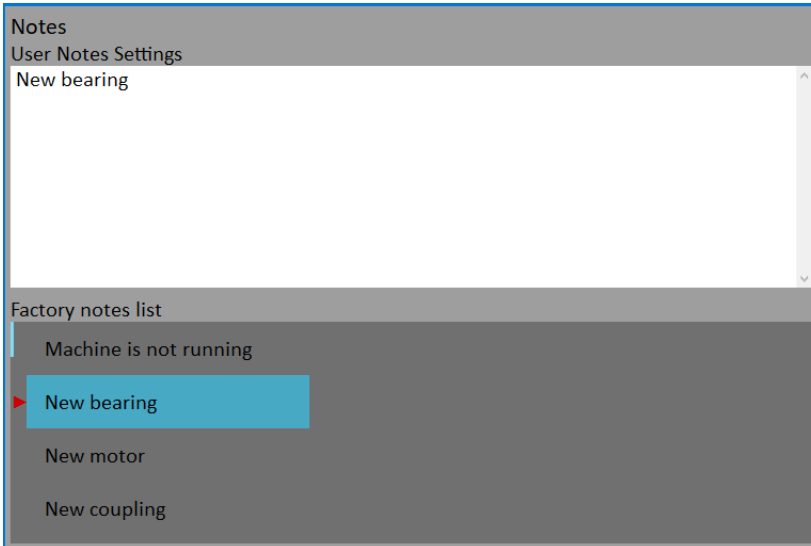

If you want to create your own note, then push **Edit text** button. Enter your note manually. Each line in text is one note. Push **Enter** button to add new line.

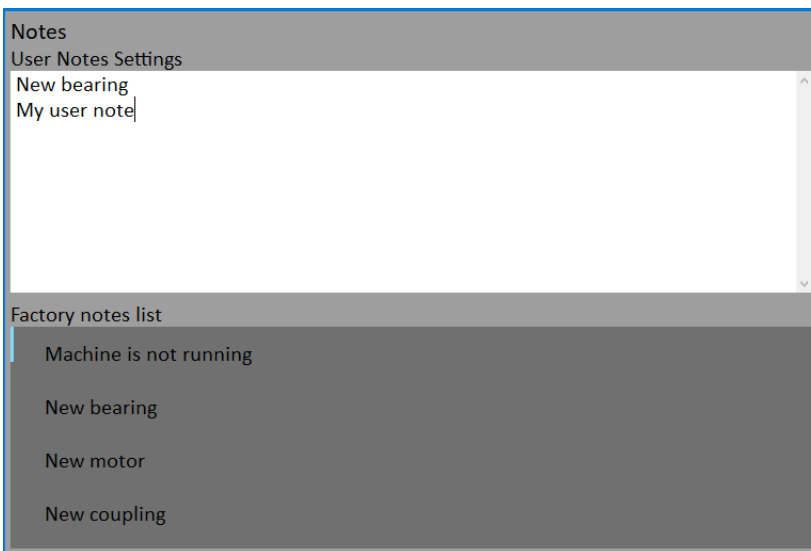

Push *Escape* button to skip back to the *Factory notes* list.

Push *Escape* button when *Factory notes* list is active to close the dialog. The “*Save changes*” question will appear. Confirm if you want.

Date/Time

Date format

yyyy/mm/dd

dd.mm.yy

mm/dd/yyyy (the a.m./p.m. is used)

Year, Month, Day, Hour, Minute, Second

Set the actual date and time

Shortcuts

Set the shortcuts for buttons.

Signal Source

The measurement can be taken from **LIVE** channels or from *record* (see [Recorder](#) chapter for understanding). All *records* saved in the instrument's memory are displayed in the *Signal Source* list below the **LIVE** item.

Trigger Settings

Parameters for measurement's triggering are entered in this menu.

Analyzer Trigger Mode

Measurement's trigger control for Analyzer module. It is used also in Octave Analysis module.

single

Only one *reading* of all *measurements* in a *set* is taken and displayed.

retrig

When you use the analogue oscilloscope, you see always the actual new signal on the screen. This means the similar thing. The measurement is repeated until you push the *Stop* button.

Runup Trigger Mode

Measurement's trigger control for Runup module. It has to be defined, how often the data will be taken.

Attention! In the Runup module, new measurement can begin after all measurements in a set are finished (with one exception, **asap all** mode).

asap

The next measurement is taken immediately after previous measurement without any delay.

manual

The user starts next measurement manually (by pressing the *Enter* button).

speed

The next measurement is taken when the speed is significantly different from the previous measurement speed. The user defines in **Speed change** item, what it is significant change.

time

All measurements are taken with the same time interval between them. The time interval length is define in **Time change** item.

time or speed

This option is the combination of speed and time. The next measurement is taken when time or speed change occurs.

asap all

Unlike the previous trigger modes, the *asap all* mode enables **all** measurements to be taken as soon as possible. This means, the next reading of each measurement is taken immediately after previous one. All previous modes wait for all measurement in a set to be completed before a retrig can occur. The *asap all* mode can retrig each measurement separately as soon as possible without waiting for other measurements in a set to be completed.

The following example shows the difference between the *asap* and *asap all* mode. We take three measurements with the length of 1 second, 4 seconds and 8 seconds. The first figure shows the *asap* mode. You can see three measurements, which takes 1, 4 and 8 seconds. The saving interval of all measurements is 8 seconds because the shorter measurements always wait for the longest measurement to be completed. The second figure shows the *asap all* mode where all measurements are taken as soon as possible.

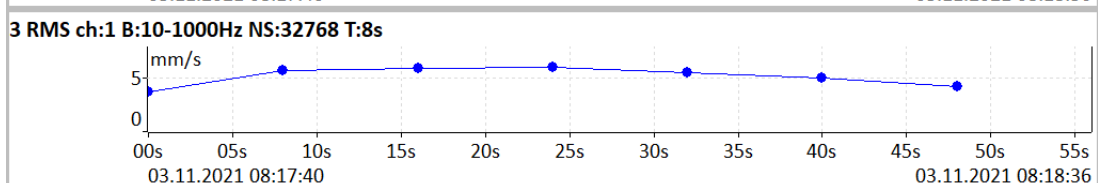
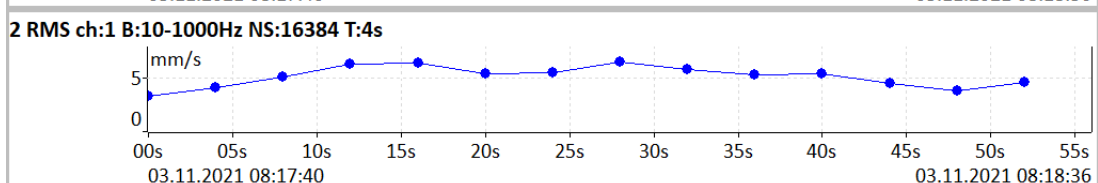
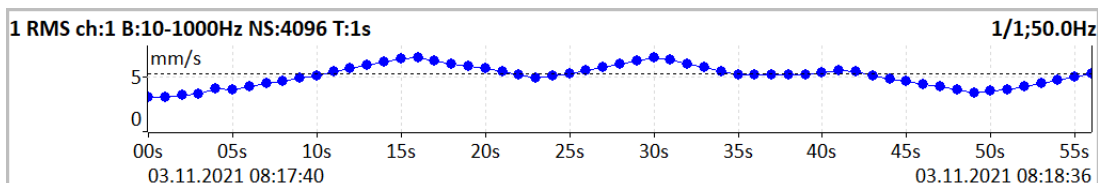
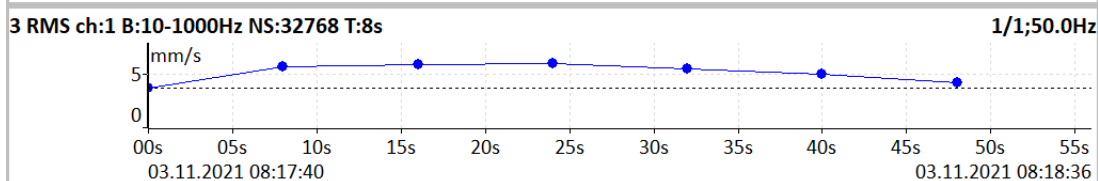
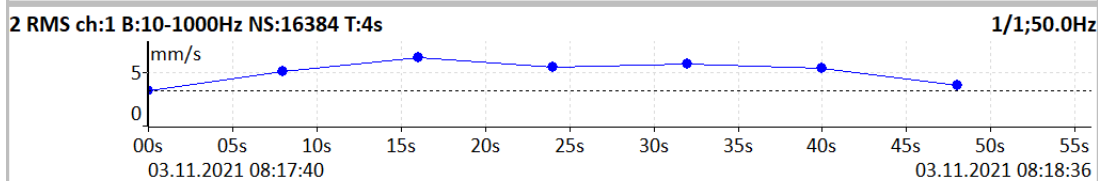
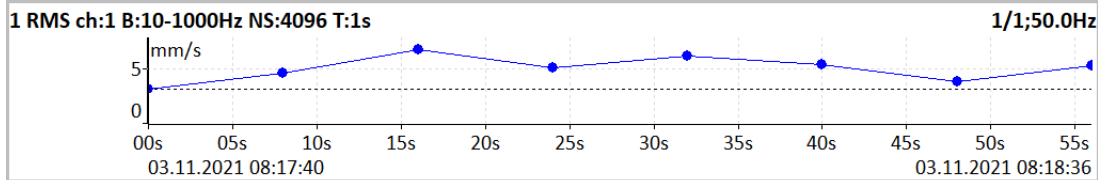

Note! When the *measurement process* waits for retrig event, a “**Waiting for retrig**” window appears. The text informs, which event is expected.

Waiting for manual retrig
Press enter for retrig

Waiting for time or speed retrig
10 s or 1.00 Hz

Speed Change

See [Runup Trigger Mode](#) item.

Time Change

See [Runup Trigger Mode](#) item.

Runup Minimum Speed, Runup Maximum Speed

undef, user

Runup measurements are taken only if actual speed is greater than *Runup Minimum Speed* (if defined) and less than *Runup Maximum Speed* (if defined). If the condition is not met the measurement is not running and a “**Waiting for runup speed**” window appears with the limit values as a note.

Note! You may define both values or just one of them.

Waiting for runup speed
<20;50> Hz

Waiting for runup speed
<undef;50> Hz

Waiting for runup speed
<20;undef> Hz

In the following figures, you can see the difference between measurement with undefined runup minimum and maximum speeds (figure on the left) and measurement with runup speeds set to 20Hz and 50Hz (figure on the right). As you can see, values greater than 50Hz and less than 20Hz are missing on the right figure. The example shows speed values, however, all measured data types are controlled by the speed value.

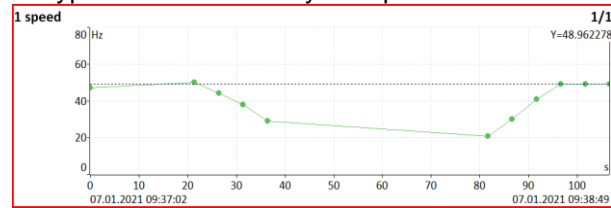
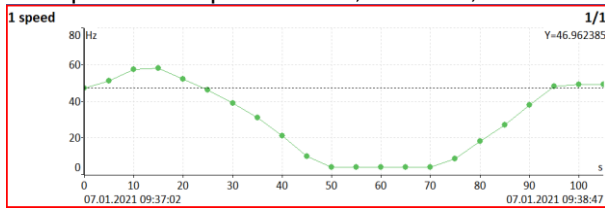

Trigger Source

Every measurement must be triggered (it means started). When you press the *Enter* button for taking the measurement, you run only the initialization. When everything is ready to take the data, then the *Trigger Source* item is applied.

In Runup mode, the frequency of measurements is controlled by [Runup Trigger Mode](#) at first. Then is applied the *Trigger Source*.

freerun

Measurement is triggered immediately after initialization without waiting for anything.

external

Measurement is triggered when signal on TRIG input exceeds [Tacho](#) / [Tacho Trig Level \[V\]](#) value.

Such signal may be generated for example when the machine starts to work. This type of signal is usually created in the control system.

Attention! If the external trigger source is set, the tacho probe is not supposed to be connected to the TRIG input. Therefore, in this case, no speed is evaluated. No speed dependent measurements like order analysis cannot be measured. Furthermore, no speed value is stored in data headers.

manual

Measurement is triggered after pressing the *Enter* button. Remember that you should push the *Enter* button twice. First pushing is for initialization, second for triggering.

manual sequential

Similar to manual, but every *average* during averaging must be started separately. For example when AVG is 10, then the *Enter* button must be used 10 times.

amplitude

Measurement is triggered when signal on the **Ampl Trig Channel** input exceeds the **Ampl Trig Level** (both are defined also in this menu). Both positive (rising edge) and negative (falling edge) levels are accepted. The signal amplitude is taken directly from sensor input, no additional filtering is applied.

Examples:

the level is set to 100mV - triggered when the raising signal goes from for example 99mV to 101mV

the level is set to -100mV - triggered when the falling signal goes from for example -99mV to -101mV

tacho

Measurement is triggered when signal on TRIG input exceeds **Tacho Trig Level** defined in the [Tacho](#) menu.

The tacho is special case of external trigger. When we talk about the tacho, we mean the signal (usually like TTL) which contains one or several pulses during one rotation of the shaft. It can be also understood like series of single external pulses.

Difference from external signal:

1. Treeshold level for tacho trigger is defined in the [Tacho](#) menu. For external trigger, it's defined here in the [Trigger Settings](#) menu.
2. Signal edge is always falling for tacho trigger. For external trigger, you may select falling or raising.
3. During averaging, tacho trigger is expected for each average, unlike in external triggering where the trigger is expected only in the beginning and then all averages are measured without triggering.

Note! When the *measurement process* waits for trigger event, a "**Waiting for trigger**" window appears. The text informs, which event is expected.

Waiting for external trigger

Waiting for amplitude trigger
3 g / AC 1

Waiting for manual trigger
Press enter for trigger

Use Ampl Tacho

yes, **no**

When **yes** is set, then the tacho pulses will be created by amplitude trigger level, not from tacho probe. Set the channel and level by the same way as for amplitude trigger. Set the **Ampl Tacho Hysteresis** to 30-50% of level to avoid creation of more pulses in near times. It could happen when signal is noisy. Sometimes you need to try more percentage values to find the correct one. See pictures for understanding.

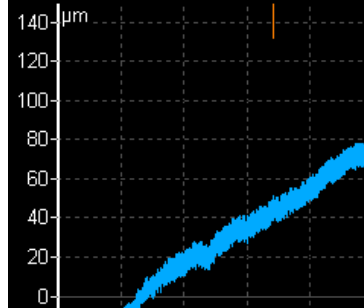
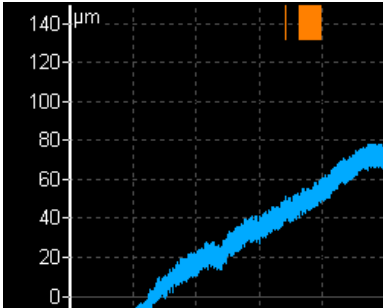

Ampl Trig Channel

See the [Trigger Source](#) set to **amplitude**.

Ampl Trig Level

See the [Trigger Source](#) set to **amplitude**. The value is set in physical unit of sensor on selected channel.

Ampl Tacho Hysteresis

See the [Use Ampl Tacho](#).

Negative Averaging

yes, **no**

Negative averaging is available only with an amplitude trigger. When turned on, a reference spectrum is taken in the measurement beginning after device initialization. This reference spectrum is remembered and then subtracted from each calculated spectrum. This is useful when performing a bump test on running machine. Please don't make hits during negative averaging initialization. You are noted by the window.

Negative Averaging Initialization
Please don't hit

Look at next example. On first picture, you can see a spectrum of a hit performed on stopped machine. Exponential window is applied.

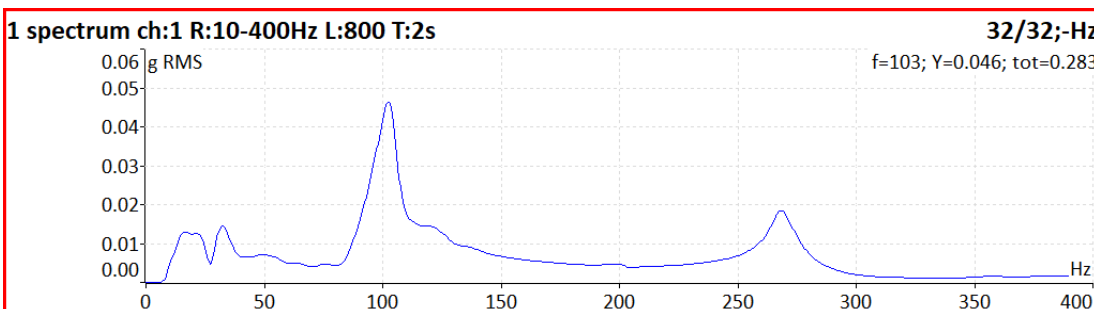

Next picture shows the hit performed on running machine. You can see a big peak value near 50 Hz.

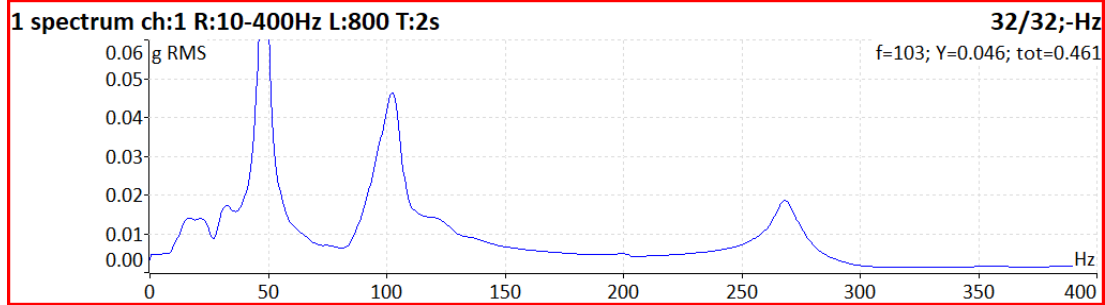

By using negative averaging, you can eliminate the unwanted peaks in spectrum, which are caused by machine running. Not by the resonances.

Note! It is recommended to use averaging (make more hits) with the negative averaging to obtain the best possible result.

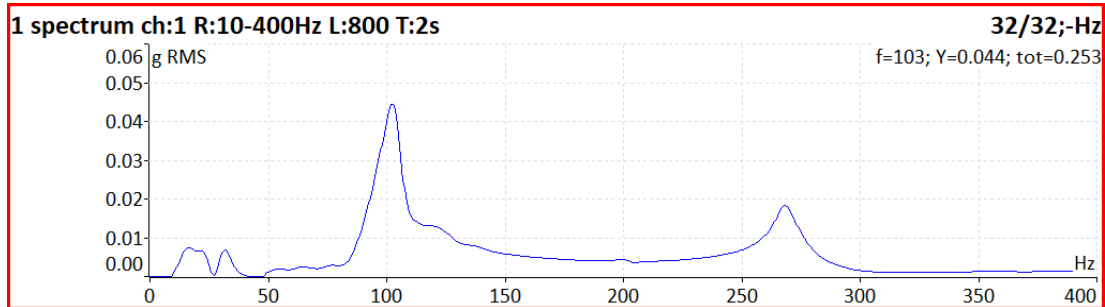

Pretrig [%]

[-100, 100]

Usually the taking of measurement (for example time signal) begins exactly from the trigger moment. But in some applications, you are interested also to know the signal before trigger. The required time should be defined in seconds, but in signal Analyzers is usually defined as percent part of the total signal length. When 1 second time signal is measured and pretrig is 25, then 0,25 seconds will be taken before trigger and 0,75 seconds after trigger. Also, the negative pretrig could be used. It means that the time signal will be taken later then trigger pulse.

Runup

This menu contains parameters for Runup module.

Max Memory Size [MB]

It enables partial savings of runup measurement. If the size of measured data exceeds the value, then data are saved and new runup is opened.

Time Unit

days, hours, minutes

The unit of **Length** parameter (see next line)

Length

undef, value

If defined, then measured data are saved to individual files, where each file contains defined length.

Trend Time Axe

relative the time axe begins from zero

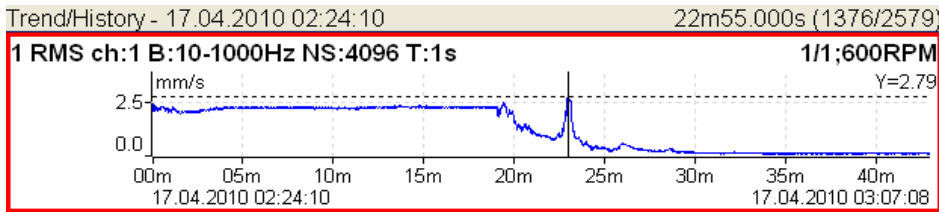

real time the time of measurement is displayed on time axe

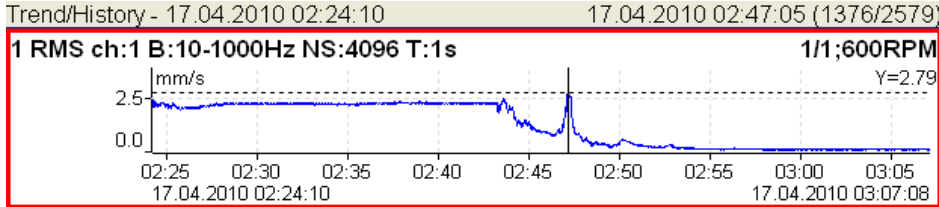

Trend Length

auto, value

The length of the trend graph (the range of X axe). It is used for Runup measurement and for the Graph Properties / View Trend. When the auto is used, then all data in the trend are displayed.

Spectrum Settings

Some spectrum [Graph Properties](#) parameters can be predefined here. Every new created spectrum graph will take these properties.

Detect Type

RMS, 0-P, P-P

Default detect type for spectral amplitude values.

Axe X

lin, log

Axe Y

lin, log, dB

Peaks list

on, **off**

Graph Lines

continuous, discrete

Sensors

When you connect the sensors to the instrument, you have to tell what kind of sensors you use. Select the **Sensors** item in the main *MENU*. In the next menu select channel you want to define.

AC1 – AC4

Setting of each AC channel properties (sensor, *ISO 10816* group, bearing).

All AC

Setting of all AC channels together.

All Bearings

Setting of one bearing to all AC channels.

All ISO

Setting of one *ISO 10816* group to all AC channels.

DC1 – DC4

Setting of each DC channel properties.

All DC

Setting of all DC channels.

Tacho / External

Setting of TACHO / EXTERNAL channel properties (TRIG input).

Settling Prolongation

Sometimes you can need longer time for sensor settling. Set the required additional time in seconds.

AC Sensors

AC (alternate current) sensors are used for signals, for example vibrations. The AC sensor menu can be opened using the *MENU / Sensors / AC1 – AC4* or *All AC*.

ICP

on, off

Select of required setting accordingly the sensor type

Sensitivity [mV / “unit”]

1, 10, 100, user

Define the sensitivity value in the sensor's physical unit.

Unit

Select the unit according to a sensor's type.

Name

undef, user

You can optionally enter a name of the sensor by choosing **user** item. Use **undef** item to reset the sensor name.

Note! The sensor's name is displayed in Sensors main menu.

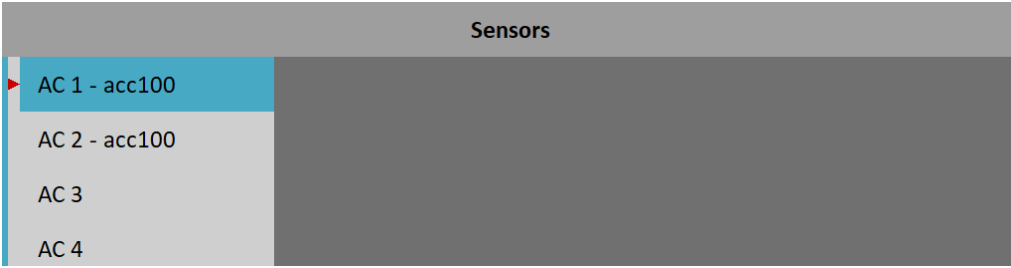

Saving sensor

Parameters of named sensor can be saved. After you enter the name, open the **Name** menu again. New item **save** is available now. When you choose this item, the sensor will be saved.

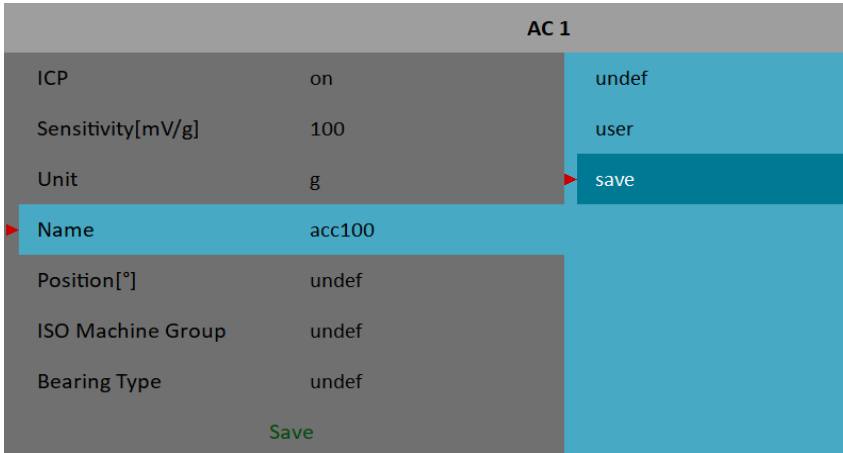

Note! If you want to save a sensor with a name which has been already defined, you'll be asked to rewrite its parameters.

Sensor "acc100" has been already defined.
Rewrite its parameters?

Loading sensors

Saved sensors are displayed on when you open the **Name** menu. Select a name of a saved sensor and press **Enter**. Then its parameters are loaded.

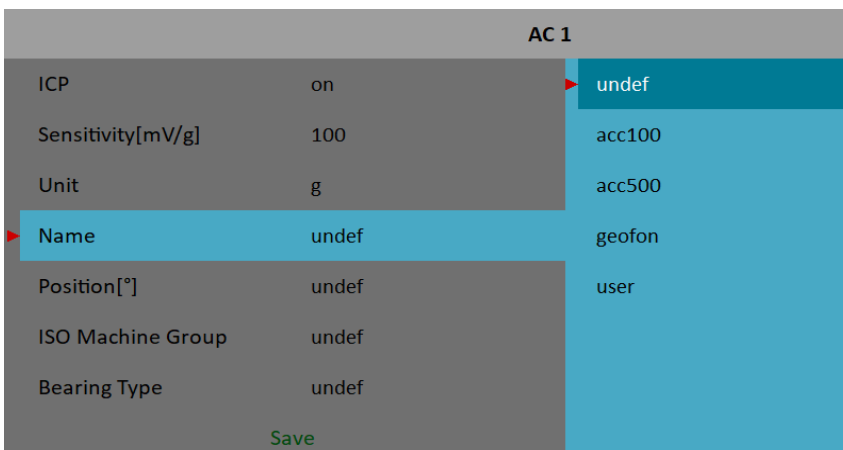

Note! If you choose **user** option and then enter a name which has been already saved (e.g. **acc500**) you'll be asked to load its parameters.

Sensor "acc500" has been already defined.
Load its parameters?

Deleting sensor

Select a sensor which you want to delete. Open the **Name** menu again. Now new item **delete** appears. Select this item and press *Enter*. The sensor will be removed from the list.

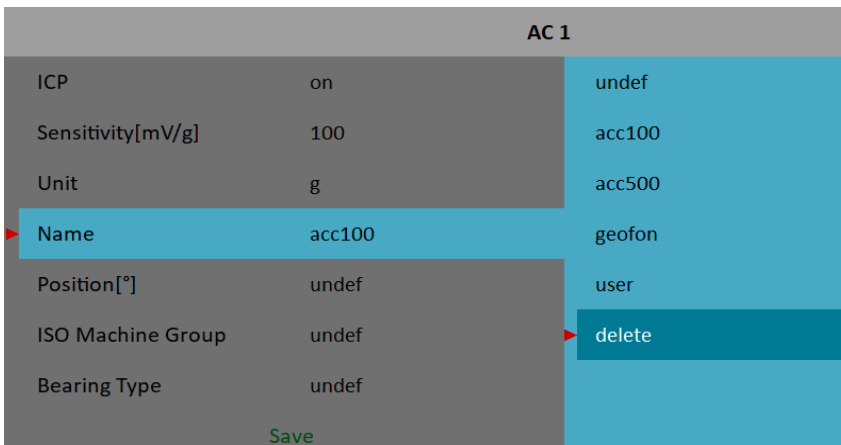

Sensors list import

In Virtual Unit, the list of saved sensors is available as **data\Sensors\sensors.json** file in Virtual Unit's working directory (by default *C:\ProgramData\Virtual Unit*). You can use this file to transfer your sensors list into instruments. Copy the *sensors.json* file into **VA5_DISC** root directory. Then, after starting the instrument, the file is automatically imported and the sensors list is used in the instrument.

Position

The angle of sensor (see picture below). Usually used for proximity sensors.

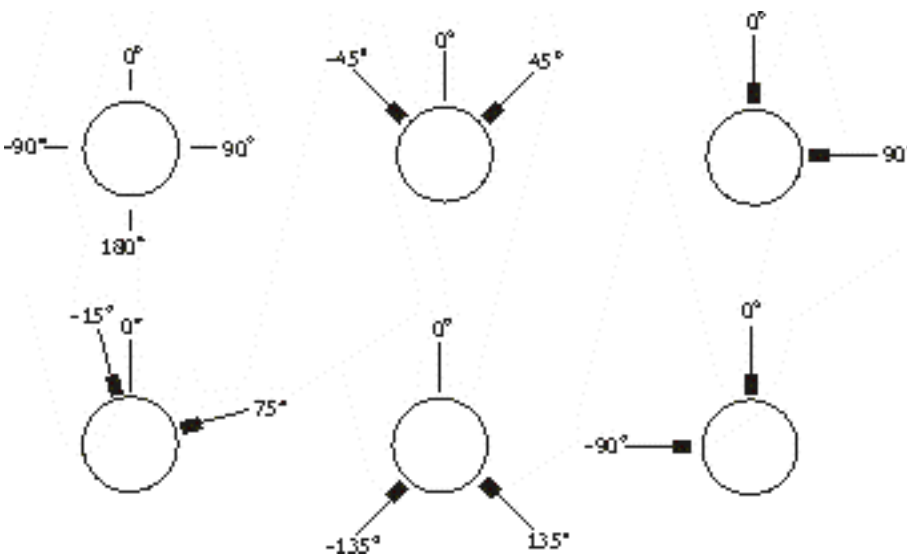

DC gap channel

In case of displacement sensor also DC channel could be entered, which is used for **gap** measurement (the sensor must be connected to both AC and DC input). The *gap* value is stored in time signal and orbit measurements and the value is added to a signal.

ISO Machine Group

You can set the appropriate machine group according the **ISO 10816** for each channel separately (the *AC1 – AC4* menu) or for all channels together (the *All ISO* menu).

The ISO 10816 group and foundation parameters are used for limit values calculations and green, orange, red indication.

ISO Machine Foundation

rigid, flexible

Only available if ISO machine group is defined.

Bearing

The fault bearing frequencies can be displayed in spectra. The bearing definition is required for that. You can set the bearing for each channel separately (the *AC1 – AC4* menu) or for all channels together (the *All Bearings* menu).

database

Select bearing from a database.

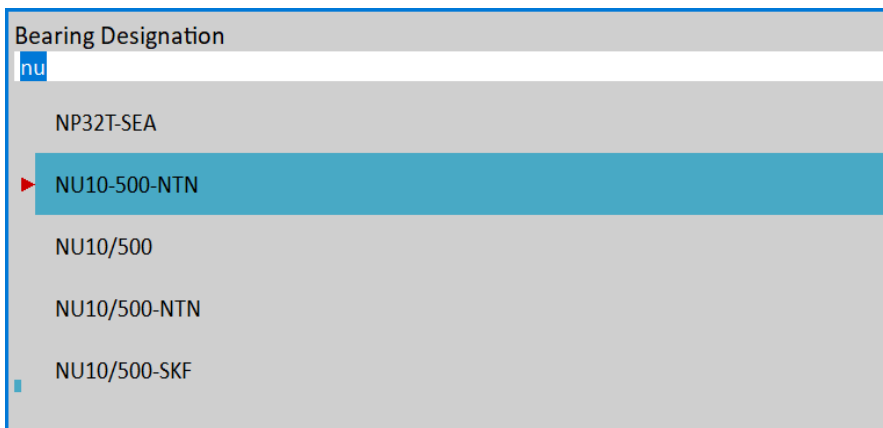

Enter the name (or part of the name) and use the up/down arrows. Confirm by *Enter* or tap an item.

user

If the required bearing is not in the database you can define the parameters manually.

undef

No bearing defined, the fault frequencies will not be displayed.

Rotating Race

inner, outer

Only available if a bearing is defined.

You must define which race rotates for correct bearing fault frequencies calculation.

DC Sensors

DC sensors are used for direct current signals, for example temperature, pressure, The DC sensor menu can be opened using the *MENU / Sensors / DC1 – DC4* or *All DC*.

Sensitivity [mV / "unit"]

1, 10, 100, user

Define the sensor's sensitivity value in the sensor's physical unit.

Offset [mV]

0, user

Define the sensor's offset value in milliVolts.

The used formula:

output value in "unit" = (input value in mV - Offset) / Sensitivity.

Unit

Select the unit according to a sensor's type.

Name

The name of sensor. See [AC Sensors](#) / [Name](#) for more details.

Position

The angle of sensor. See [AC Sensors](#) / [Position](#) for more details.

Tacho / External Sensors

The tacho probe or external trigger source is connected into the TRIG input. The TRIG input signal should contain pulses which can be used for speed calculation or for measurement triggering.

On the picture are the tacho signal (magenta line), the trig level (grey line) and created tacho pulse (yellow line).

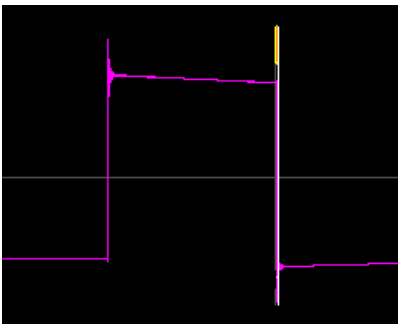
**Trig Level [V]**

The correct reference value has to be set. For example, when the standard tacho level is 0.5V and the pulses reach the 1.5V, then the value 1V should be correct. The negative pulses are not allowed, you need to use Adash converter for them.

Trig Edge

rising, falling

Edge for triggering.

The trig level together with the trig edge define the time of trigger (the time when the trig or tacho mark is generated).

If the edge is set to **falling**, then the time of trigger comes when the TRIG signal **decreases** from the value higher than trig level to the value lower than trig level.

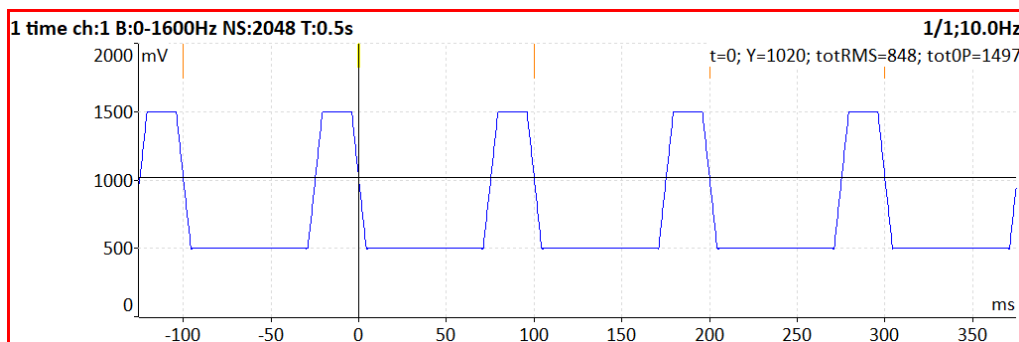

If the edge is set to **rising**, then the time of trigger comes when the TRIG signal **increases** from the value lower than trig level to the value higher than trig level.

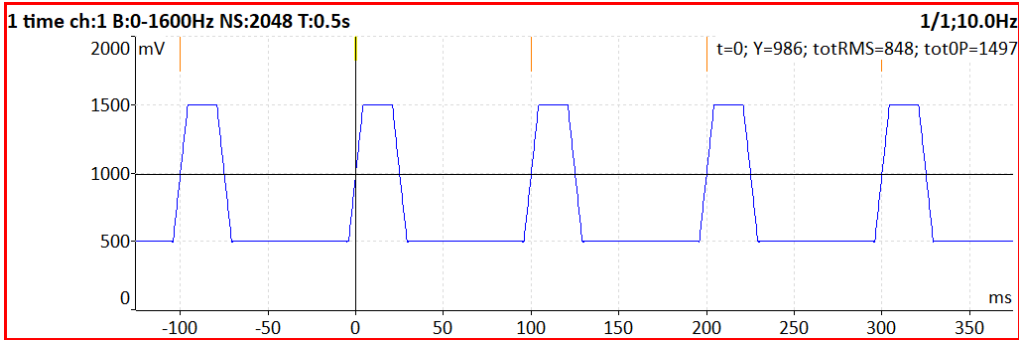

Pulses per rotation

This value has to be set for correct speed evaluation, when more pulses are generated during one rotation. Non integer values can be also entered. They are used for speed calculation in various stages of gearbox. If the *Pulses per rotation* not equals one the *Trigger Source* cannot be set to **tacho**. Then, the tachometer signal is used for speed calculation but cannot be used for triggering.

Min Speed

The lowest speed, which the user is interested to measure with tachometer. Lower speed than this value cannot be recognized. In other words, it means how long the instrument will wait for two tachometer pulses (the speed is calculated from the time between two pulses). When the pulses are missing, then the "No Speed" error is displayed. When you choose 1Hz, then the waiting interval is 1 second. When you enter 0.1Hz, then you will wait 10 seconds.

Attention! If the shaft speed is lower than *Min Speed*, no tachometer marks are generated and no tachometer trigger can occur.

Attention! By decreasing the value of *Min Speed*, you increase the time needed for tachometer probe failure recognition.

Sensor Properties for Records

When you use the *record* (recorded signal from memory) for analysis, then the sensor properties are defined in the record, because you had to define them before the recording. You can change them for next analysis, but this change is not written to the *record*. The original values are kept in the *record*.

The new values will be used only for analysing.
Nothing is rewritten in record.

MENU / RUN

This part of main *MENU* is used for running various tasks.

Stethoscope

Runs the [Stethoscope](#) module. This is next option how to run it. The basic option is to run it from main screen.

Camera

Runs the [Camera](#) module. This is next option how to run it. The basic option is to run it from main screen.

IR Camera

Runs the [IR Camera](#) module.

Gallery

Opens the **Gallery** module. This is next option how to open it. The basic option is to open it from main screen.

Calculator

Opens a menu to select from various calculators.

Note! The *Calculator* item is not available when [Touchscreen](#) / [Enable Touchscreen](#) is set to **no**.

Calculator	
CALCULATOR	VIBRATION CALCULATOR
Standard Calculator	Vibration Units Converter
Scientific Calculator	Bearings Calculator
Units Converter	Belt Frequency Calculator
	Gearbox Calculator

Standard Calculator

Simple calculator with functions similar to a small handheld calculator.

Scientific Calculator

Advanced version of the calculator designed to solve more complex mathematical operations.

Units Converter

Allows you to convert between commonly used units. Select the known unit in the left column, the desired units in the right columns, and enter a value to generate the resulting conversion.

Vibration Units Converter

Allows you to convert between commonly used vibration units. Enter the speed and known vibration value to generate the resulting conversion.

Bearings Calculator

Allows you to calculate bearing defect frequencies. Enter the required parameters to generate fault frequencies. You can also enter just bearing designation if is available. We have added new fault frequency named BSF2.

$BSF2 = BSF * 2$ is the bearing failure frequency which you can see exactly in the spectrum, because spinning defective ball hits the bearing twice during one ball revolution: once the ball hits outer ring and once it hits inner ring.

Belt Frequency Calculator

Allows you to calculate belt passing frequency. Enter the required parameters to generate belt frequencies.

Gearbox Calculator

Allows you to calculate the shaft speeds and the gearmesh frequencies. Enter the required parameters to generate gearmesh frequencies and output speed.

Update

Update of the instrument firmware. The Update item is available only when the MENU item was selected in the main screen. If any module is running, then the Update item is not displayed. You can download the updated firmware from producer website. Follow the procedure:

1. Download the file for update (for example VA5_ver0268.up3) and save it to your computer.
2. Connect the instrument to the computer.
3. Run the Explorer or other software, which you use for copy of files.
4. Copy the update file from the computer to the *VA5_DISC*.
5. Use "*Safely remove hardware*" function and disconnect instrument from the computer.
6. Select the *Update* item
7. Select the required update file from the list (more version files can be saved in the instrument).
8. The main screen window is closed now. The procedure of update is described in the new command window.
9. After the update the instrument is reset

Help

Displays html version of manual

Screenshot

The screenshot in png format will be saved to the *images* folder on *VA5_DISC*. You can watch the screenshots in the [Gallery](#).

Export All

Export all still unexported projects from all modules.

About

Version:	0275
Licence:	000000
Built:	11.01.2021 07:30:00
Installed:	11.01.2021 07:32:00
Disc Capacity:	57.1GB
Used Space:	10.5GB (18.4%)
Free Space:	40.6GB (81.6%)
VA5_DISC Free Space:	95.0%
Battery:	98%

Power Off

Switch off the instrument.

Speed detection

You need to know the speed of the measured machine in some cases. Usually, the route readings have set the Detected speed from DDS. We will describe here how the speed detection works.

Detection is done just before the measurement itself after pressing the Start button. During the detection there is information window displayed in bottom right corner.

If the tacho probe is used, then the speed is measured by that.

If the tacho is not used, then the spectrum is displayed. The highest peaks are found and displayed in the list. The highest amplitude speed in on the top of list. You can select the correct value.

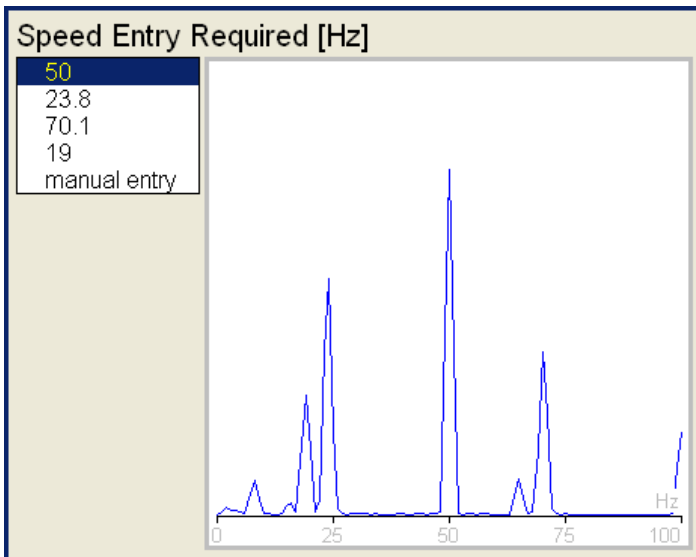

If no value in the list is correct, then select **manual entry** and enter the speed manually. If no value of speed is defined in this window, then the readings will be taken without it.

Enter the speed [Hz]

The speed detection is available only when vibration sensor is used for point reading. In other cases, the warning appears. Then the manual entry of speed is required.

Speed could not be detected
Improper sensor

If the measurement for speed detection fails, then error message appears. For example ICP error.

Speed could not be detected
ICP error

If the speed value is detected, it is automatically saved to the data head for following measurement in the same way as the speed value measured by tacho probe. If the speed probe is used in the same time the speed probe has the priority.

Analyzer

The **Analyzer** module is the basic module for signal analysis. If you have not prepared the **Route** measurement, then you use the **Analyzer** for analysis. All required parameters must be set by hand or you can use the saved measurement parameters from memory.

Basic concepts

Meas

The *Meas* means one measurement as it is usually understood, for example overall value or time signal or spectrum or other.

Graph

The graphical form of that *Meas* values displayed on the screen we will call the *Graph*. One Graph works with data from one *Meas* item. You should keep in mind that also one overall value is the *Graph*.

Set

The *Set* is the most important term in the Analyzer mode. The *Set* is the set (or group) of one or more *Meas* items, which the user wants to collect and display together. For example, you want to take 4 *Meas* together - acceleration overall, velocity overall, velocity time signal and velocity spectrum. You prepare the *Set*, which includes these 4 required *Meas* items. The definition of *Set* is saved in the Analyzer memory. You can save many various *Sets*, which can contain your often used sets of measurement. Then you select one *Set* and run it. The taking off all measurements included in the set is made simultaneously.

Reading

The Reading means all *Meas* items (signals and values) from one set measured together at the same time.

Project

You can use only various *sets* for analyzing. But sometimes you may need the more structured items then simple *set*. Such items we call **projects**.

Examples:

1. Meas_Point_A
This is only simple **Set Project**, which contain several measurements in one point.
2. Pump_P/ Point_1, Pump_P/Point_2, Pump_P/Point_3
The structured **project** of 3 *sets* (3 points) on one machine (Pump_P). This type of *project* we call **L1/Set Project**. It means Level1_Name/ Set_Names.)
3. Plant_X/ Pump_P/ Points
The structured **project** with name of Plant (Level2) , names of machines (Level1) and names of Sets. This Project type we call **L2/L1/Set Project**.

Export Project to VA5_DISC (flash disk)

The computer can read only data from VA5_DISC. All data are saved to instrument's internal disk during working with a project. Therefore, project which we want to transfer into computer must be exported to the VA5_DISC first. The export to flash is not done automatically because the writing procedure to flash is slow. That is why the user can determine, when the right moment to export the set is. Anytime when a project which has been modified is closed VA5 asks user "Export to VA5_DISC?".

Export Meas_Point_A to VA5_DISC?

Push Yes or No according to your needs.

You may also export a project later using **Project / Export** menu item.

Project List

The first Analyzer screen contains the list of Projects saved in the memory or the empty list, when no projects have been saved yet. The time and date of last saving of selected project is displayed in top right corner. Each item in project list has a note on right side, **S** (means *Set*), **L1** or **L2**.

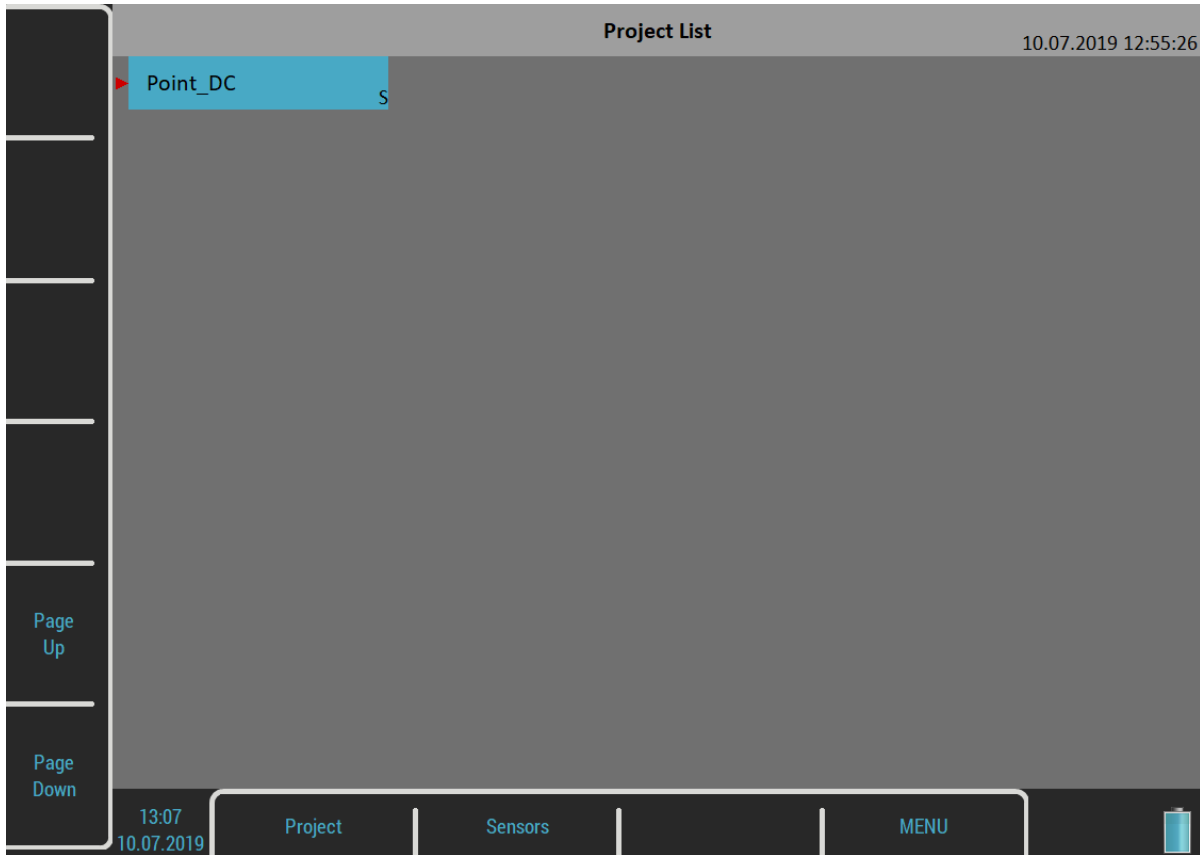

Project Menu

Push the *Project* button to open the menu.

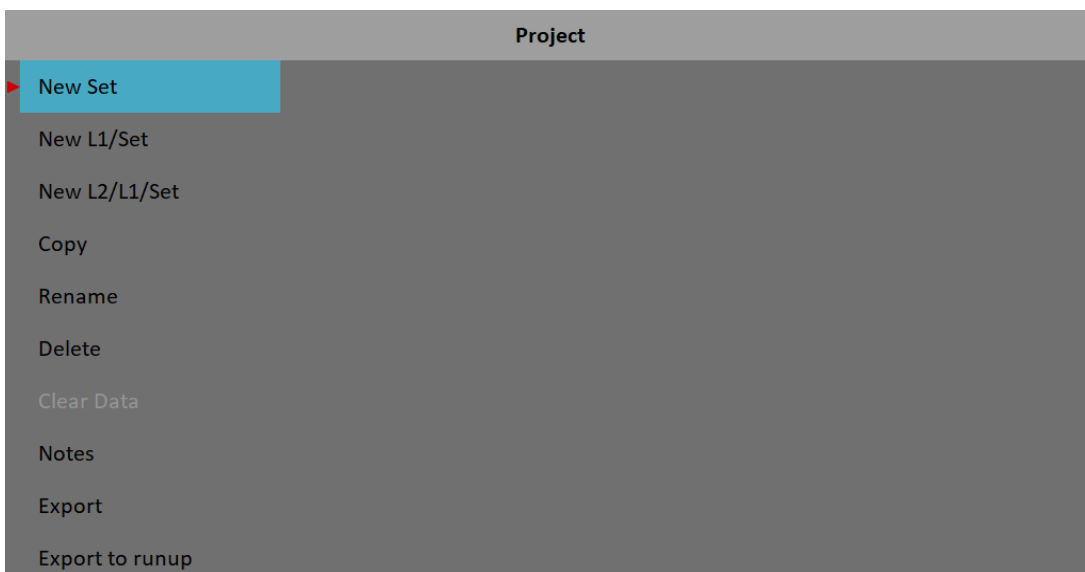

New Project - Set creation

Select the **New Set** item from the menu. The “*Enter the set name*” dialog appears.

Enter the set name.

Enter the name of new set. Your new item appears in the displayed *Project List* (alphabetical order).

Project List		10.07.2019 13:09:11
▶ Meas_Point_A	S	
Point_DC	S	

The **S** letter after the name is the **Set** type indication. Date and time of project last modification (here creation) is displayed in status bar right corner.

New Project - L1/Set creation

The *L1/Set* structure usually enables to create the machine item with several points. Select the **New L1/Set** item in the menu.

Enter the L1 name.

Enter the name on Level 1 (for example machine name). The *Project List* appears (alphabetical order).

Project List		10.07.2019 13:10:30
Meas_Point_A	S	
Point_DC	S	
▶ Pump_P	L1	

The **L1** letter after the name is the **Level 1** type indication.

New item is selected. Open it. The project will be opened and the list of included *Sets* appears (it is empty now).

Pump_P
Set List
Empty

Push the *Set* button and select *New* item.

Enter the set name.

Enter the set name. The *Set List* contains the new *set*.

Pump_P
Set List
▶ Point1

Use the *Escape* button to return back to the project list.

New Project - L2/L1/Set creation

The *L2/L1/Set* structure usually enables to create the plant with several machines. Every machine can contain several points. Select the **New L2/L1/Set** item in the menu.

Enter the L2 name.

Enter the name. The *Project List* appears (alphabetical order).

Project List		10.07.2019 13:12:45
Meas_Point_A	S	
▶ Plant_W	L2	
Point_DC	S	
Pump_P	L1	

The **L2** letter after the name is the **Level 2** type indication.
Open the project.

Plant_W
L1 List
Empty

The empty list of *L1* items appears. Push *L1* button and select *New*. Enter the name of new *Level 1* item.

Enter the L1 name.
Fan_X1

The *L1 List* appears.

Plant_W
L1 List
▶ Fan_X1

Open the *L1* item and create the *Set* in the same way as in the previous section.

Copy

Copy of selected item to the new one

Rename

Rename selected item

Delete

Erases selected item(s). You can also erase more items at once by using *multi on* function.

Clear Data

Erases measured data in selected item(s).

Notes

You may add notes to the selected item. See the [Route / Notes](#) chapter for more details how to deal with notes.

Export

Export of selected item to the *VA5_DISC*, where is accessible for computer.

Export to runup

Export selected item to a [Runup](#) module. Also you can export projects from Runup module to the Analyzer module (**Export to analyzer** item is available in the Runup module).

Graphs Screen

Open a *set project* (noted by *S*) from the *project list* or a *set* from the *set list* of a structured project.

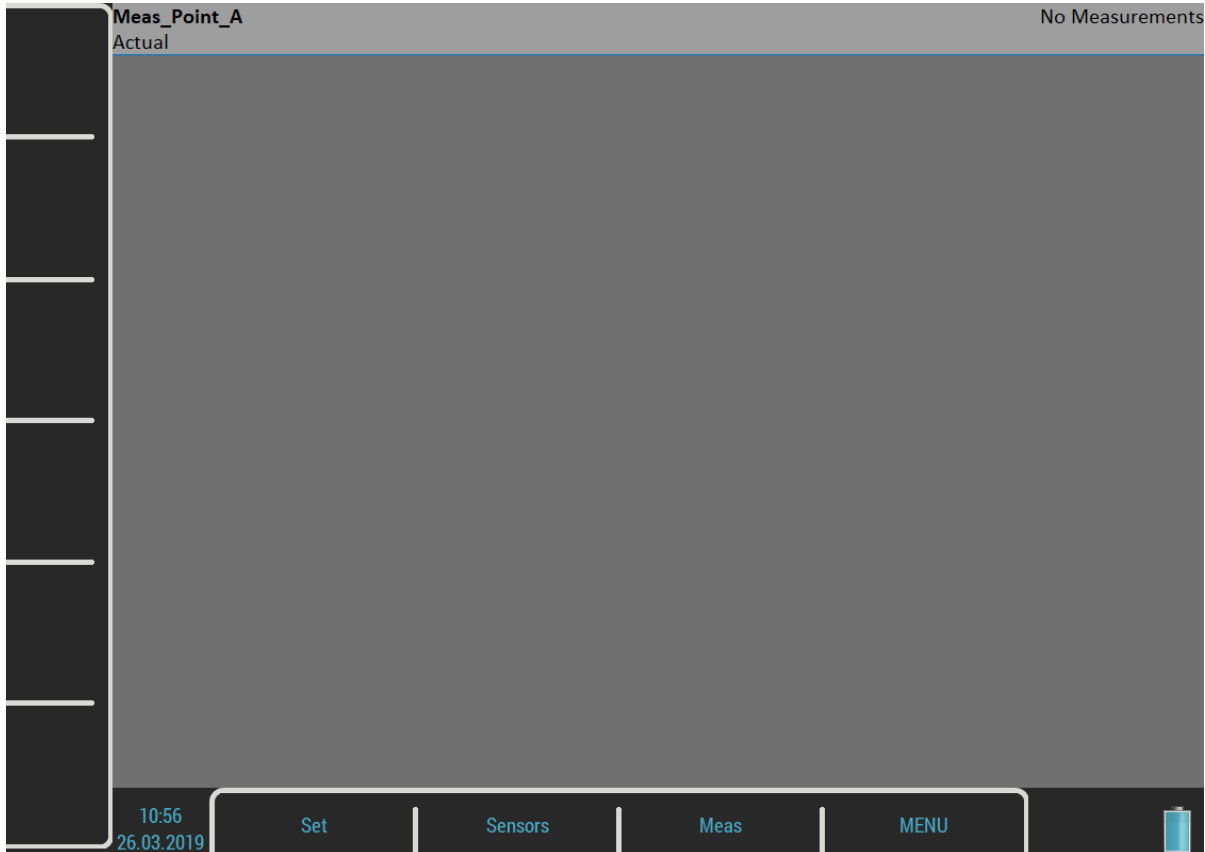

The **graphs screen** contains *graphs* of *set's* measurements (now empty).

The **status bar** contains several texts. The *set's* name (**Meas_Point_A**) takes place in the top left corner. The **Actual** indicator informs you that you are working with actual (currently measured) data. The **Trend/History** alternates the *Actual* if you are watching saved data. The **No Measurement** indicates there are no measurements yet. The selected graph index and the total number of graphs is written in this place if some graphs are on screen (e.g. **Graph 2 / 5**).

Two menus are available for the *graphs screen*, the **Set** menu and the **Meas** menu.

Measurement Definition in the Set

As has been described already the *set* contains definitions of measurements (*meas*), which we want to take together.

To show the example is the best way how to learn the process of measurement.

The example of requirements for the Set:

Meas 1: RMS overall value in mm/s, frequency band 10-1000Hz, from channel 1

Meas 2: RMS overall value in g, frequency band 500-25600Hz, from channel 1

Meas 3: time signal in mm/s, frequency band 10-1000Hz, from channel 1

Meas 4: Spectrum in mm/s, range 400Hz, 1600 lines, from channel 1, averaging 4

Meas 5: Spectrum in g, range 3200Hz, 3200 lines, from channel 1, averaging 8

First you need to define your measurements. Push the **Meas** button. The **Meas** menu will appear.



Select the **New Advanced** item. An **Edit Measurement** menu will appear.

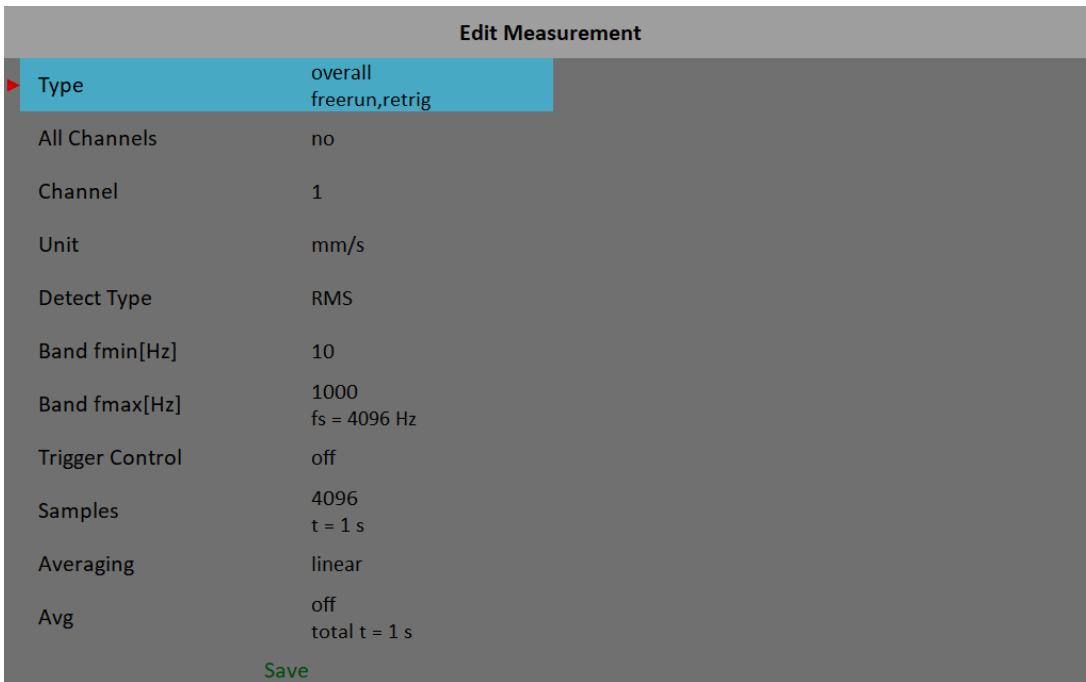

Current trigger settings are displayed as a note under the **Type** parameter's value. If you need to create same measurement on all channels set the **All channels** to **yes**. The **Band fmax** parameter determines required sampling frequency. Therefore the *fs* note is displayed under the **Band fmax** value. The measurement's length depends on the number of samples and number of values in an average. The time required for taking one average is under the **Samples** value. The total time for all averages is displayed under the **Avg** value.

You can edit the type and parameters of the measurement here. There are factory predefined parameters for ISO RMS which is exactly what we need as our first measurement. Just push the **Save** button and a new graph will be created.

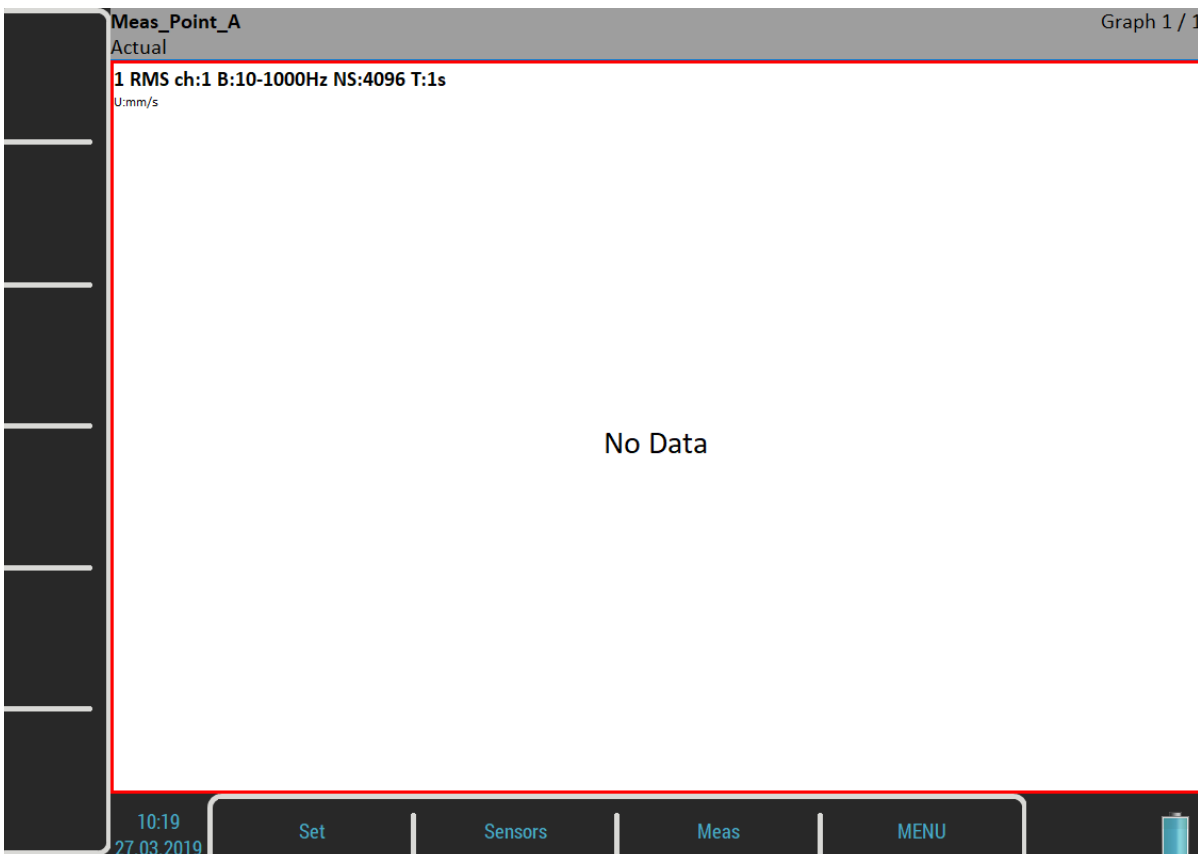

Create the second measurement. Use the *Meas / New Advanced* item again. Change the **Unit** to **g**, the **Band fmin** to 500 Hz , the **Band fmax** to 25600 Hz and the **Samples** to 65536. Confirm the dialog and the second measurement will be ready.

The number three measurement is a time signal. Change the **Type** parameter to **time**.

Type	time freerun, retrigger
All Channels	no
Channel	1
Unit	mm/s
Band fmin[Hz]	10
Band fmax[Hz]	1000 fs = 4096 Hz
Trigger Control	off
Samples	4096 t = 1 s
Avg	off total t = 1 s
Save	

Next two measurements are spectra. The *Edit Measurement* menu for spectrum looks like this.

Type	spectrum freerun, retrigger
All Channels	no
Channel	1
Window	hanning
Unit	mm/s
Zoom Spectrum	no
Band fmin[Hz]	10
Range[Hz]	1600 fs = 4096 Hz
Lines	1600 t = 1 s, df = 1 Hz
Averaging	linear
Avg	off total t = 1 s
Overlap	0%
Full Spectrum	no
Save	

The **Band fmax** has been changed to **Range**. Change the **Range** parameter to 400 Hz and the **Avg** to 4 and confirm.

To finish the set definition, create another spectrum measurement with the unit of g, range of 3200 Hz, 3200 lines and Avg 8.

The screen contains five graphs of just defined measurements. The graphs don't contain data yet.

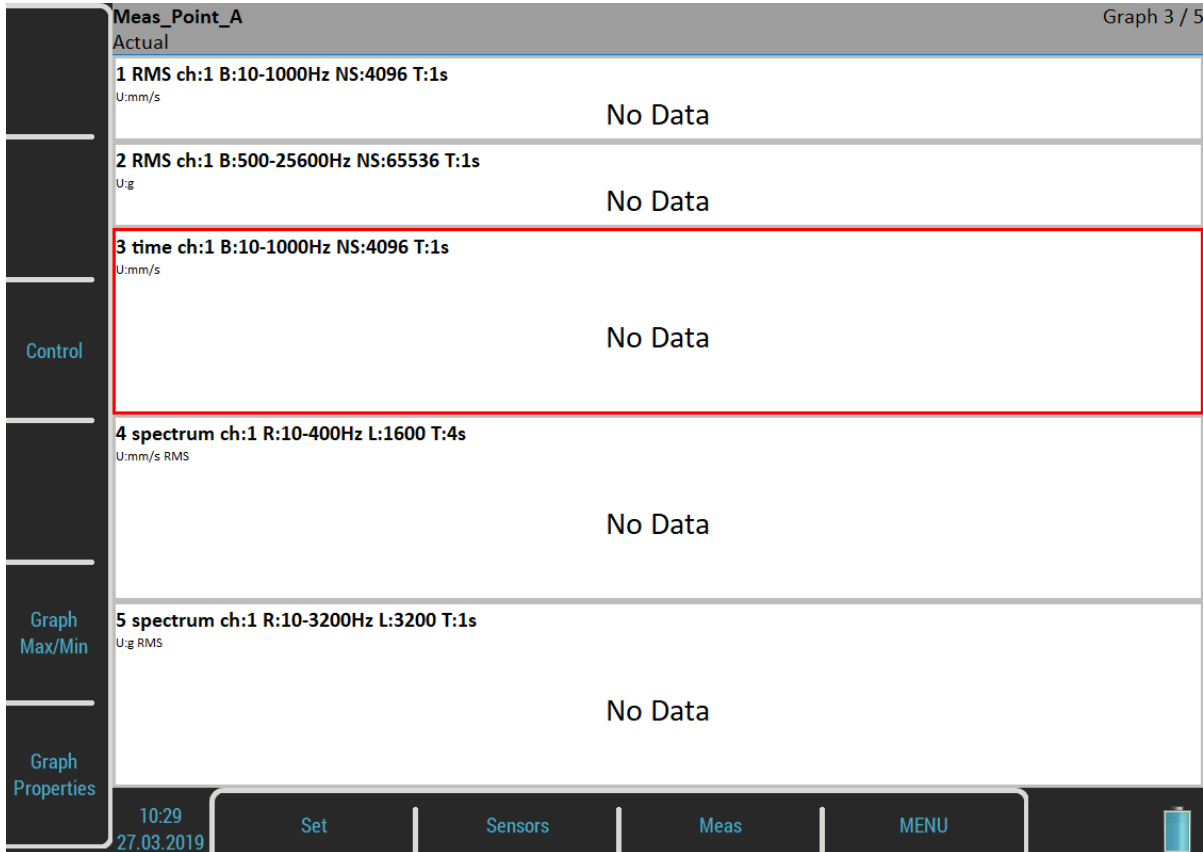

The **Graph 3 / 5** text in the status bar top right corner says that the third graph is selected (you see the red frame) and there are five graphs on the screen. Operations like edit, copy, delete are made on selected graph. Use up and down arrow button to change the selected graph.

The description of each graph is in the top. The complete list of symbols is stated in an appendix.

The description example:

1 RMS ch:1 B:10-1000Hz NS:4096 T:1s

The translation: Meas No.1, RMS value, Channel 1, Applied band filter 10 -1000Hz, Number of Samples of the signal 4096, Time length of signal 1s. The Signal means the time signal, from which the evaluation was made.

New buttons are available now, **Control**, **Grah Max/Min** and **Graph Properties** buttons. Their meaning will be explained later.

When the measurements definitions are done everything is ready to start a measurement process the real measurement. Push the **Enter** button.

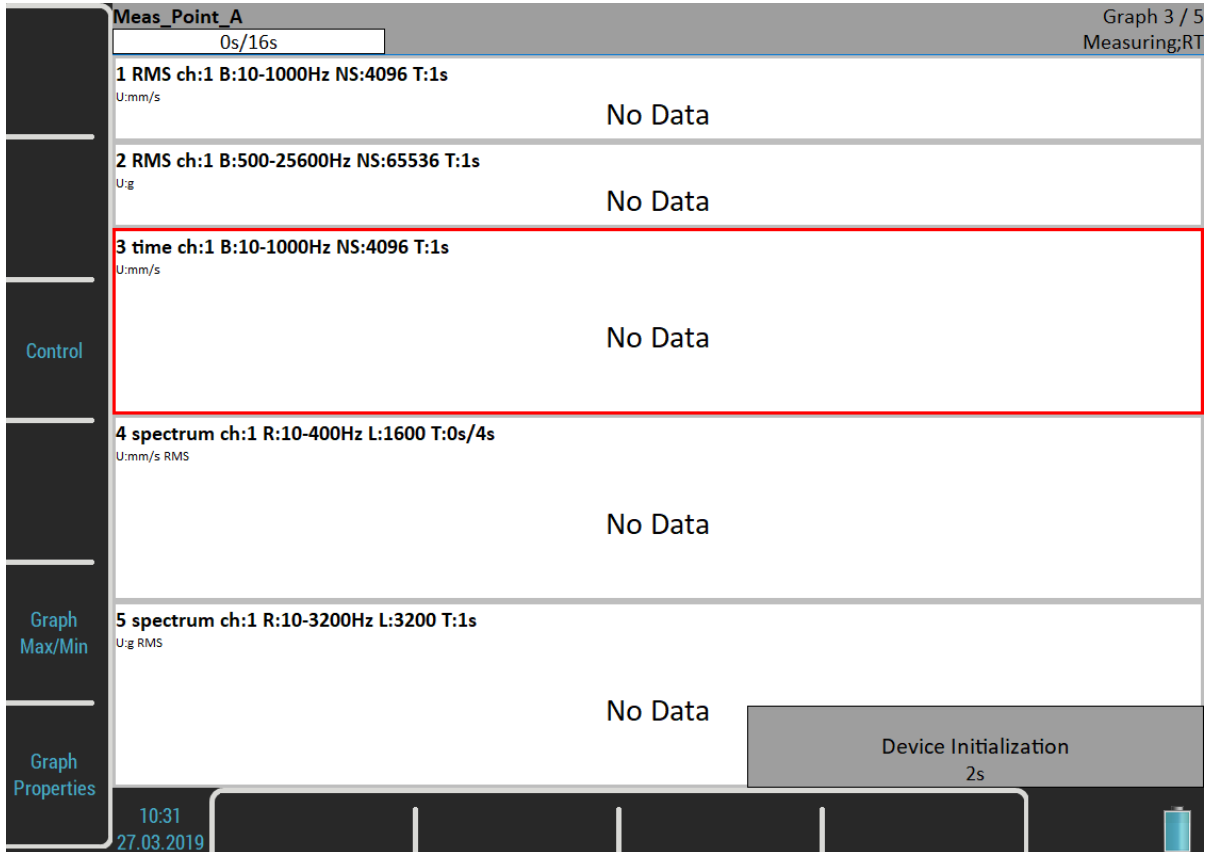

The **Device Initialization** count down appears in the bottom right corner before the measurement begins. The **Measuring** indication is in the bottom right corner of the status bar. The **RT** note means Real Time (see the [Input Buffering](#) chapter). The measurement count down indicator appears in the top left corner of the status bar if the total time of the longest measurement takes at least four seconds.

Note! If the [Analyzer Trigger Mode](#) is set to **single**, then only one reading of each measurement is taken. Then, the measurement process stops.

Note! If the [Trigger Source](#) is set to manual, use the **Enter** button to trigger the measurement.

Use the **Stop** button for stopping the measurement process. A "**Measurement is not completed**" warning appears when you push the **Stop** button and the measurement is not completed yet in the single mode. Push the **Stop Meas** button to stop it anyway or the **Continue** button otherwise.

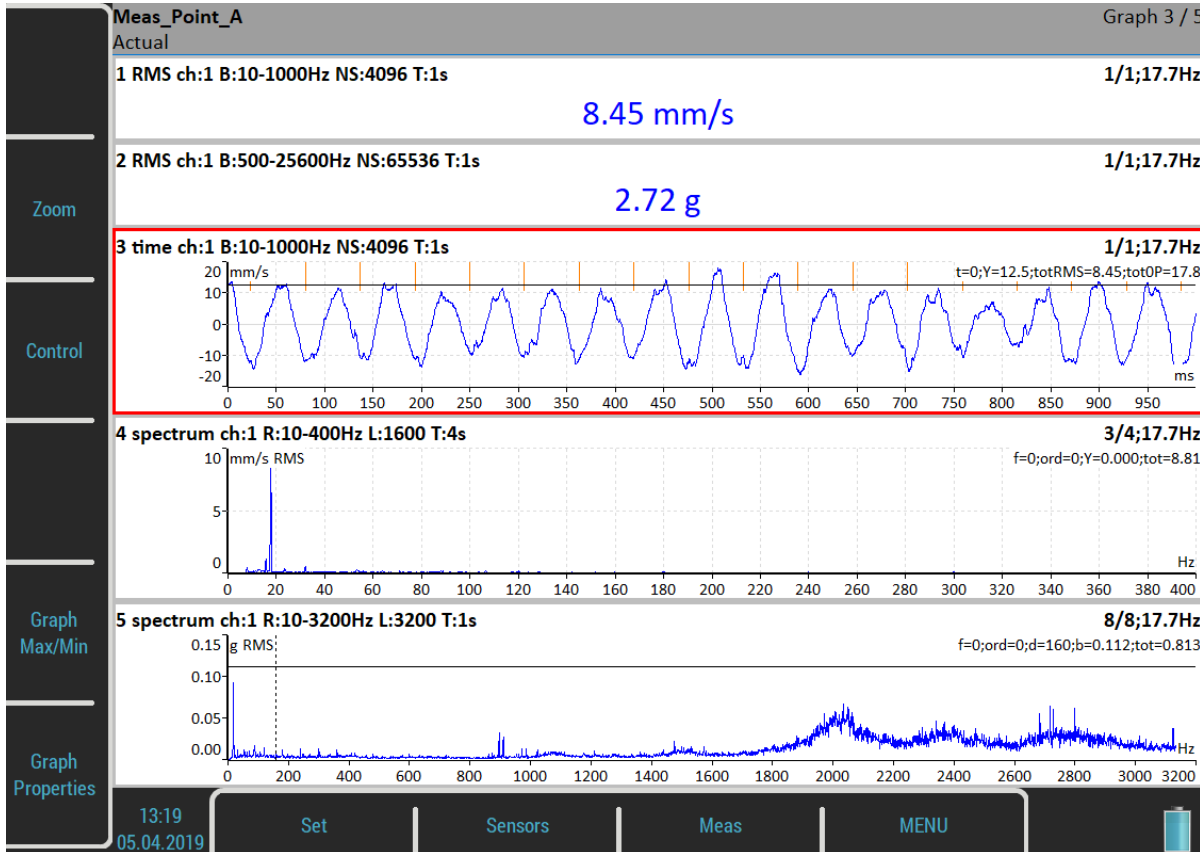

When a graph contains data, the averages and speed notification appear in the graph's top right corner. See the graph 4. The **3/4** means the 3 of 4 averages has been taken and **17.7Hz** is the speed on the beginning of the reading. The light orange lines in the time signal are **tacho marks**.

Input Buffering

Measured signal is collected into the input memory. The analyzing procedures read the signal data from the memory and compute all required results, which are displayed on the screen. In the case, when too many results are required, the computation is slow and displayed graphs are not in time - they are delayed. We are talking about **RT** (real time) measurement (you see the actual results) or about **non RT** measurement (delayed results).

This information is displayed in the status bar right bottom corner – **Measuring; RT** or **Measuring; non RT**.

After the measurement is stopped, the computation continues until the input memory is empty. The bellow window appears.

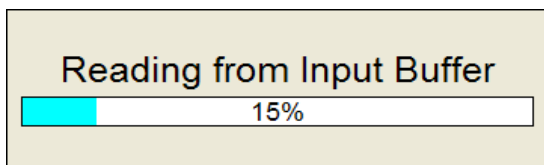

You can wait for all data acquisition or if you are not interested of measurement from input memory press the *Escape* button to stop data processing.

Graph Max/Min

The *Graph Max/Min* button maximizes the selected graph to the whole screen or returns back to the screen with more graphs.

Buttons Modes

Use up and down arrow button to change the selected graph. Use the left and right button to change the cursor position. You can do it also by tapping the touch screen. If you tap the non selected graph, it becomes selected. If you tap the selected graph, the cursor moves to the place you tapped (more precisely it will move to the nearest place on signal).

Another control functions are available under the side buttons. Push the **Zoom** button. The buttons mode will change. You will be able to zoom and move in selected graph. You can zoom and move also with standard gestures on touch screen.

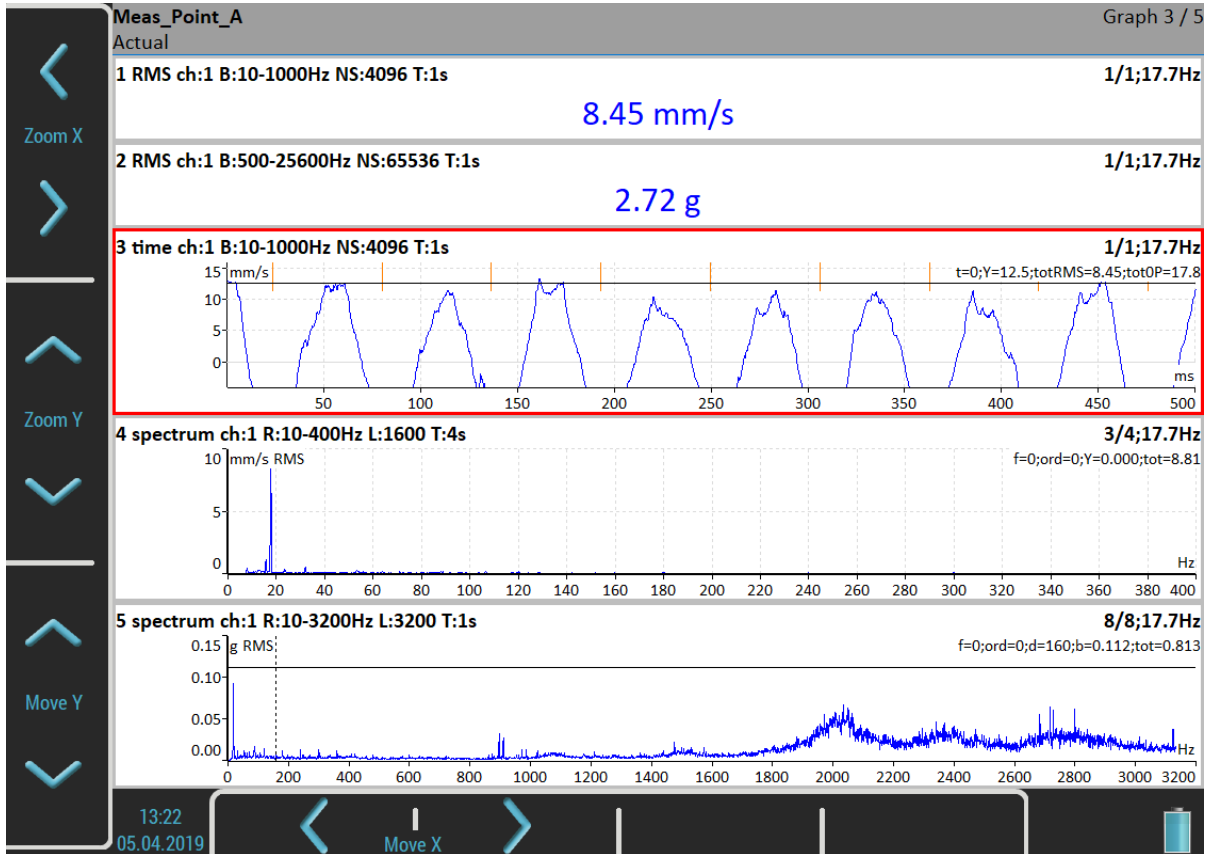

Use the **Backspace** button to restore the side buttons meaning. Then press the **Control** button. You will be able to change selected graph's **Position**.

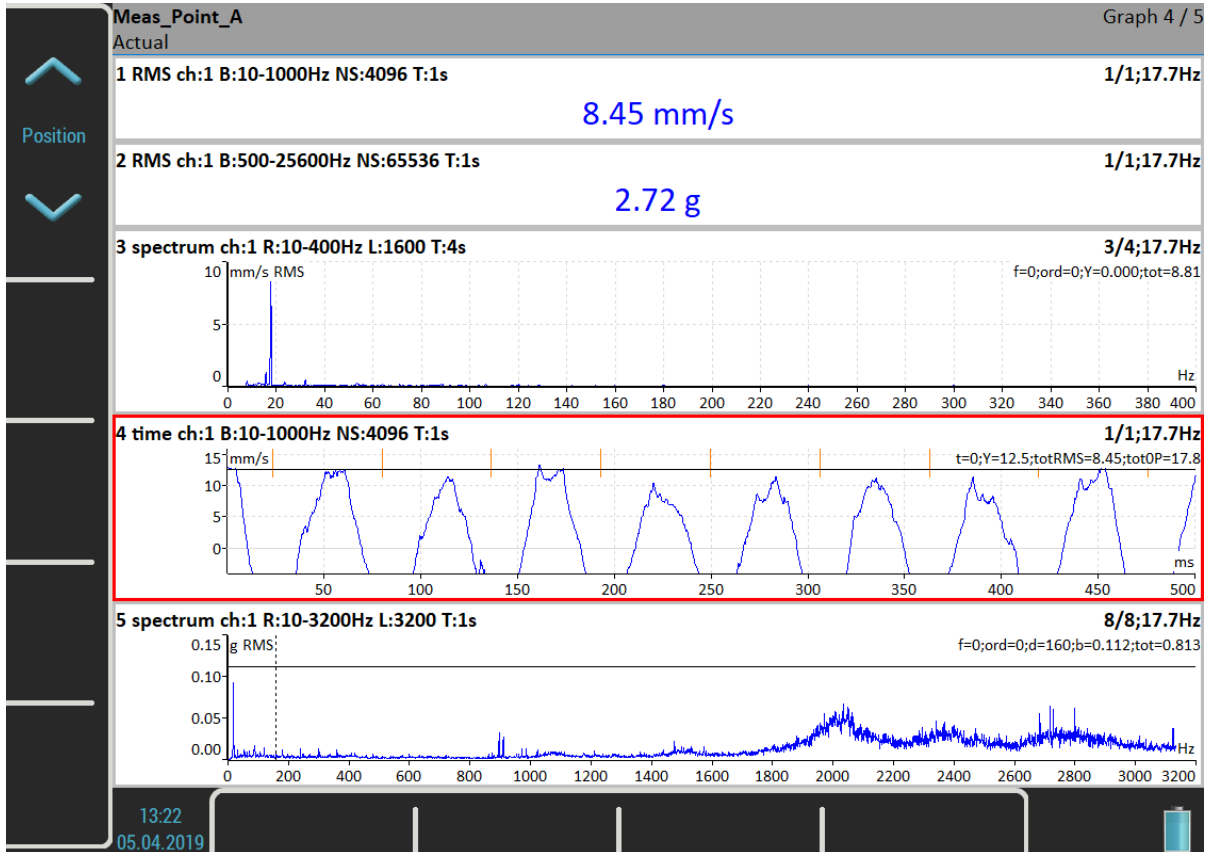

Next available functions of the *Control* mode are **Trend**, **Delta X**, **Zoom Z** and **Move Z**. These functions are hidden now and will be shown in certain situations.

The *Backspace* button restores side buttons again.

Another possibility how to switch side buttons mode is the *Tab* button. Push the *Tab* button once and the buttons change to the *Zoom* mode. Push it again and the *Control* mode will be active. Next push will restore the initial mode. This way you can rotate the buttons modes. In some situations there may also be more than two modes. You can use the *Backspace* button anytime to restore the initial mode.

Set Menu

Push the **Set** button. The menu appears.

Save data

Save last measured data. When you close the set without saving, the measured data will be lost. A "Save data?" question appears when you are leaving the set or restarting the measurement without saving.

Save data?

Notes

Open the **Notes** dialog for currently opened set. See the [Route](#) / [Notes](#) chapter for more details.

Clear Data

Clear all saved data from the set.

Enter speed / Cancel speed

Open the **Enter Speed** dialog or cancel currently entered speed. See the [Route / Enter Speed](#) chapter for more details.

View Trend / View Actual

User the **Set / View Trend** item to load saved data of the set. The screen while looking the saved data is on the picture. Notice the overall values are displayed as trends. The status bar contains **Trend/History** notification with the data and time of the beginning of the history. The date and time of currently displayed value takes place in the bottom right corner of the status bar. The 4/8 note means that 4th trend's item of 8 is displayed. You can move the trend cursor by left and right arrows or by tapping the trend. This is possible only for trends of static values. Graphs like time signals or spectra use the arrows for standard axe x cursor.

The **Control** mode of the side buttons contains a **Trend** function for moving the **trend cursor**. The **trend cursor** is common for all graphs. Values from same time are displayed on all graphs.

Use the **Set / View Actual** item or the **Escape** button to view the actual values again.

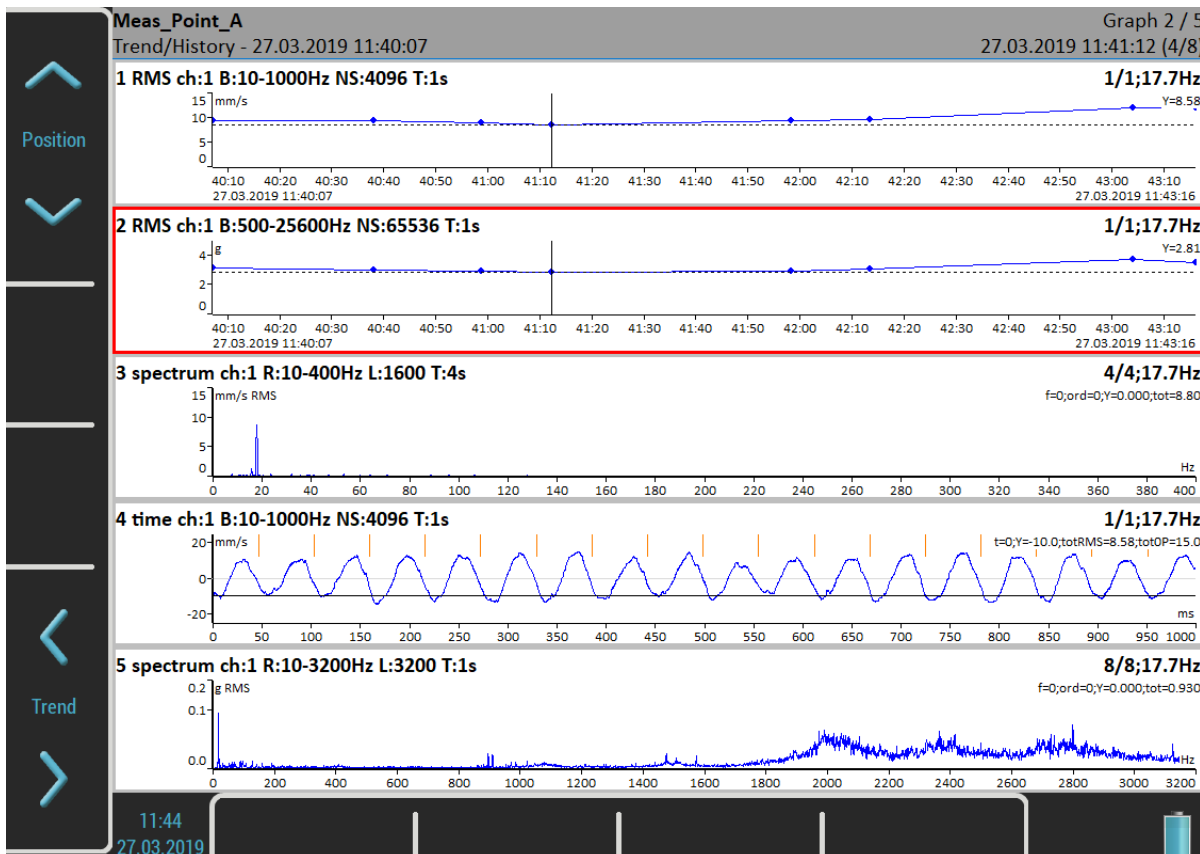

Clear Last Data

This item is available only when trend is displayed. It deletes last saved data from the set.

Meas Menu

Push the **Meas** button. The menu will appear.

New Basic

When you want create a measurement from a predefined list use the **New Basic**. The list of predefined basic measurements appears. Select required measurement from the list. This way is very fast.

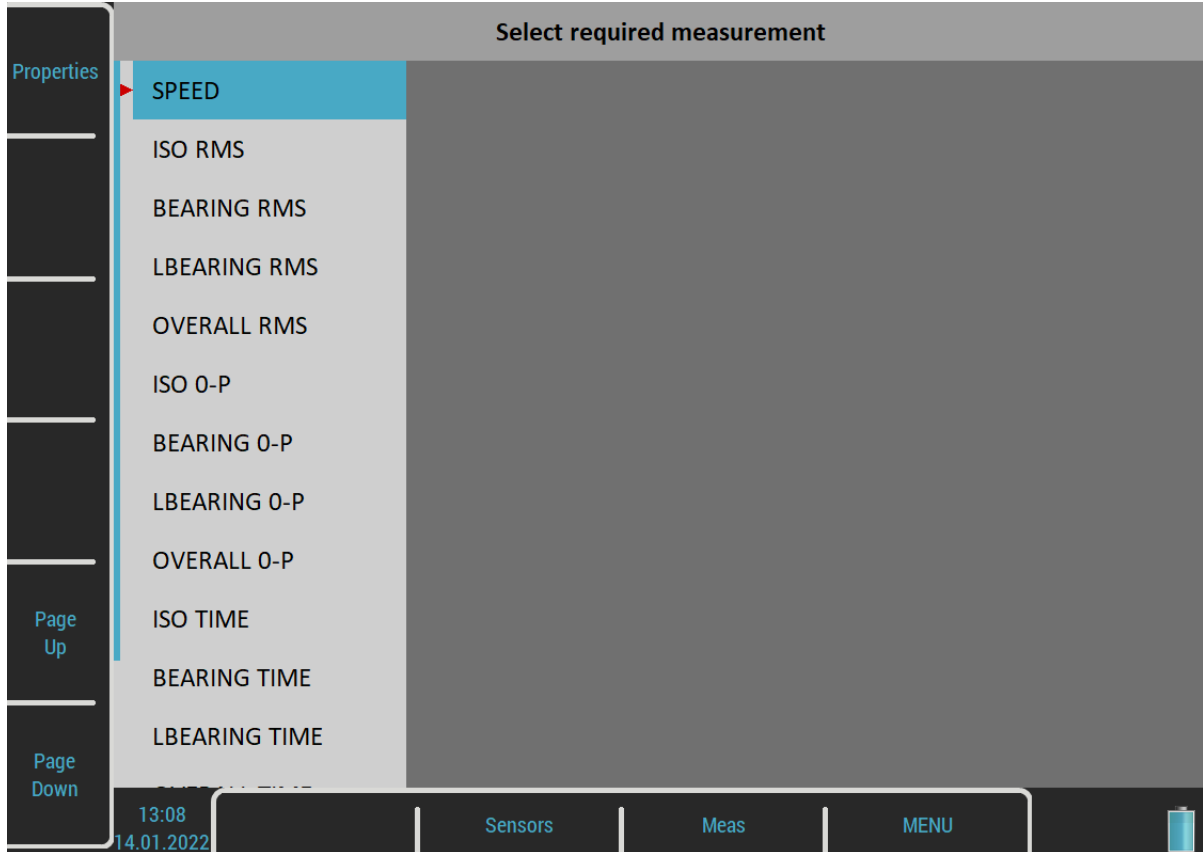

The following table shows parameters of predefined basic measurements.

Name	Type	Unit	Frequency Band/Range	Length	Samples	Lines	Average
RPM	speed	RPM					
ISO RMS	wideband RMS	vel	10-1000 Hz	1 sec			
BEARING RMS	wideband RMS	acc	5000-25600 Hz	1 sec			
LBEARING RMS	wideband RMS	acc	500-25600 Hz	1 sec			
OVERALL RMS	wideband RMS	acc	1-25600 Hz	1 sec			
ISO 0-P	wideband 0-P	vel	10-1000 Hz	1 sec			
BEARING 0-P	wideband 0-P	acc	5000-25600 Hz	1 sec			
LBEARING 0-P	wideband 0-P	acc	500-25600 Hz	1 sec			
OVERALL 0-P	wideband 0-P	acc	1-25600 Hz	1 sec			
ISO TIME	time signal	vel	10-1000 Hz	1 sec	4096		
BEARING TIME	time signal	acc	5000-25600 Hz	0,5 sec	32768		
LBEARING TIME	time signal	acc	500-25600 Hz	0,5 sec	32768		
OVERALL TIME	time signal	acc	1-25600 Hz	1 sec	65536		
ISO SPEC	spectrum	vel	1600 Hz	4 sec		1600	4
OVERALL SPEC	spectrum	acc	25600 Hz	1 sec		1600	16

The **Properties** button displays the parameters of selected basic measurement.

In addition, two more buttons are available in Virtual Unit. The **Insert** button allows you to insert a new measurement to the list and the **Delete** button allows you to delete a measurement from the list. The modified list can be transferred into instrument if you copy the *meas_templates* file from the *data\VA4template* directory in the Virtual Unit's working directory (by default *C:\ProgramData\Virtual Unit*) into **VA5_DISC** root directory. Then, after starting the instrument, the file is automatically imported and the modified basic measurement list is used in the instrument.

New Advanced

Creates new advanced measurement, where all parameters are available. You can edit type and parameters of the measurement as you need.

Copy

Creates new measurement with properties of selected measurement.

Info

Displays measurement properties.

Edit

Enables change the measurement parameters.

Delete

Deletes selected measurement.

Limits

You can define limit values for static measurement types (overall, speed, dc, ...). Limits give a notice to you when a measured value is over some critical value. During the measurement and also during examining the measured values, the appropriate alarm is displayed in graph of measurement with defined limits. The alarm informs you about the severity of the measured value.

Each **limit value** divides a numerical axis into two intervals, numbers below the limit value and numbers above it. You can edit the **alarm** for each interval. Alarm represents the severity or color for the values measured in the interval. You can choose one from four severities for the alarm, **Ok** signaled with green color, **Warning** signaled with yellow color, **Alert** signaled with orange color and **Danger** signaled with red color. It's up to you what severity you assign to which interval. The particular alarm is displayed when the measured value is in appropriate interval. You can define more than one limit values and divide the numerical axis into more intervals.

In the example bellow, we have defined two limit values, 1 and 4 mm/s. We have defined the alarm below 1 mm/s as *Ok* (green color), the alarm between 1 and 4 mm/s as *Warning* (yellow color) and the alarm above 4 mm/s as *Danger* (red color). In the first picture, you can see an actual measured value 2.61 mm/s which is greater than 1 and less than 4 (displayed as **> 1, < 4 mm/s** on the right side) and thus signaled as yellow color. The second picture shows a trend of values. You can see two limit lines in the trend, a yellow line on 1 mm/s and a red line on 4 mm/s. They represent the defined limit values and their colors correspond the alarms above the limit. Each value in the trend is drawn as a small colored circle whose color corresponds the alarm.

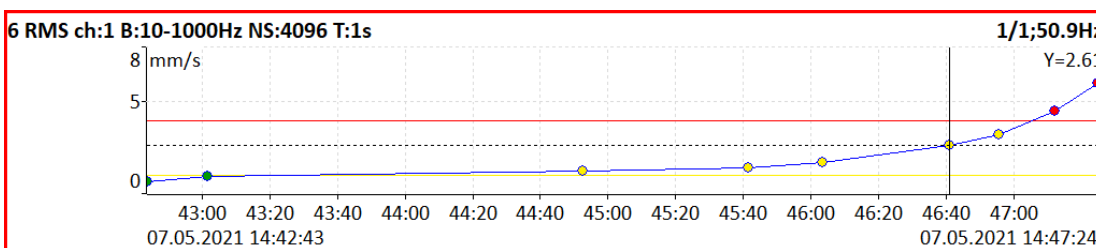
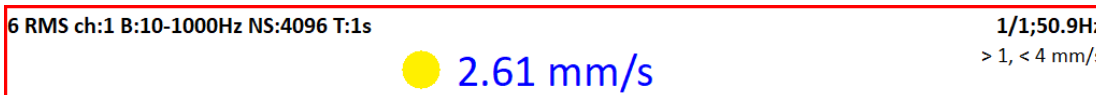

There are 3 ways how to create limits.

Adash Limits

Type	Adash
Limits Multiplier	1

Save

The limits are derived from Adash rules, which are developed for many years of Adash history. These limits require to know the speed value. Adash limits are available for two data cells types:

- velocity readings in frequency interval 10-1000Hz, which is very well suited for detecting the overall condition of the machine

Note! fmin lower than 10 Hz is also accepted , it means Adash limits can be also used for velocity measurements with fmin lower than 10 Hz.

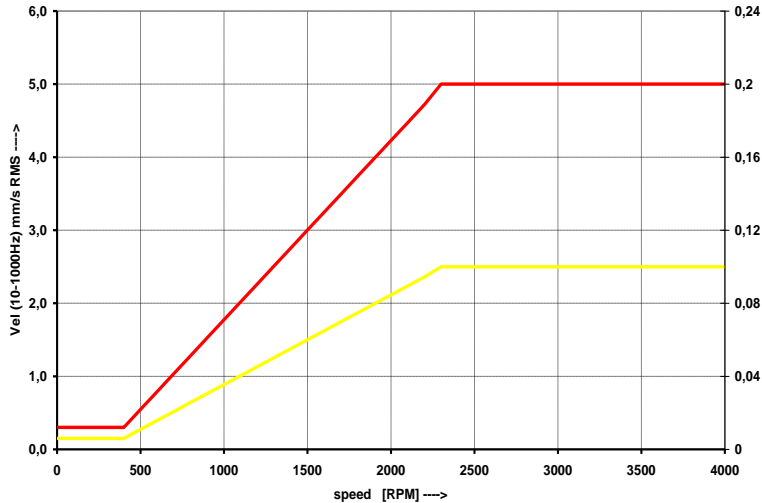

- acceleration readings in frequency interval 500 - 16 000 Hz, which is very well suited for detecting the bearing condition

Note! fmin higher than 500 Hz and fmax higher than 16000 are also accepted, it means Adash limits can be also used for acceleration measurements with fmin higher than 500 Hz and fmax higher than 16000 Hz

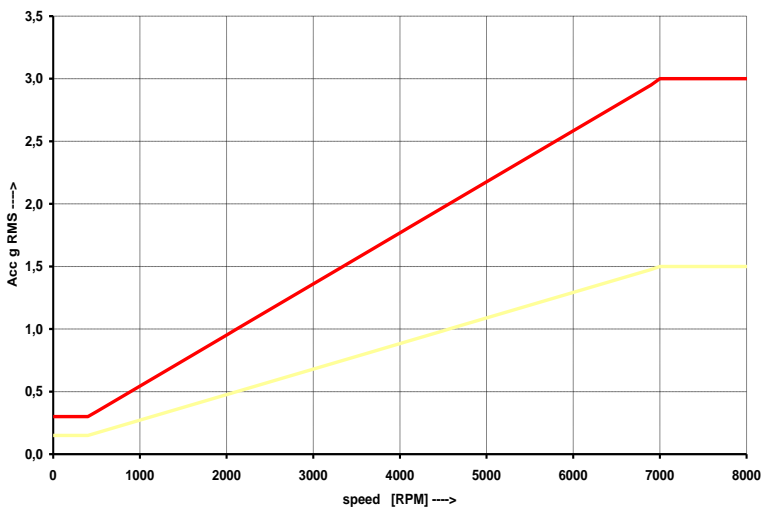

These limit values may be too or too little strict for some machines. Therefore, you can adjust them using the Limits Multiplier. Values greater than one increase the limits values and values less than one decrease them. A value of one means the limit remains as shown in the graphs above.

On following figures, you can see the effect of the multiplier. The first graph shows an alarm when the multiplier is set to 1. The second graph shows the same measurement, however this time the multiplier is set to 2, which means the limit value is twice as high as before. This means the limit is less strict and the alarm level is twice lower. The third case shows the situation with the multiplier set to 0.5.

1 RMS ch:1 B:500-25600Hz NS:65536 T:1s 1/1;50.0Hz
> 0.68, < 1.36 g

● 1.000 g

1 RMS ch:1 B:500-25600Hz NS:65536 T:1s 1/1;50.0Hz
< 1.36 g

● 1.000 g

1 RMS ch:1 B:500-25600Hz NS:65536 T:1s 1/1;50.0Hz
> 0.68 g

● 1.000 g

Note! For Adash limits, only the small colored circles are used in trends, the limit lines are not displayed. It is because of the relation to speed. Each reading can have different speed and therefore different limits.

ISO 10816

The limits are defined according the ISO 10816 standard and are available only for velocity readings in frequency interval 10 – 1000 Hz. The Machine Group and Machine Foundation has to be defined for appropriate channel before using this standard (see [MENU / SETTINGS / AC Sensors / ISO Machine Group](#) and [ISO Machine Foundation](#)).

Note! The severity in ISO limits are marked also by letter A, B, C, D. Used group and foundation is also displayed in graph.



user

User can define own limits.

Type	user
Unit	mm/s
Alarm 1	Ok
Add Limit Value	
Save	

By default, there is no limit value defined yet and the Alarm is set to *Ok* for all measured values. It is same as in DDS dialog for limits.

You can add a limit value using an **Add Limit Value** item and enter the value (eg. 1).

Type	user
Unit	mm/s
Alarm 1	Ok
Limit Value 1	1
Alarm 2	Warning
Add Limit Value	
Save	

Now you have defined one limit value (1 mm/s) which divides a numerical axis into two intervals (bellow 1 mm/s and above it). You can define alarm for each interval. Alarm 1 defines the alarm bellow the Limit Value 1 and Alarm 2 defines the alarm above the Limit Value 1. The same think can be done in DDS by clicking on ⊕ symbol and entering the number.

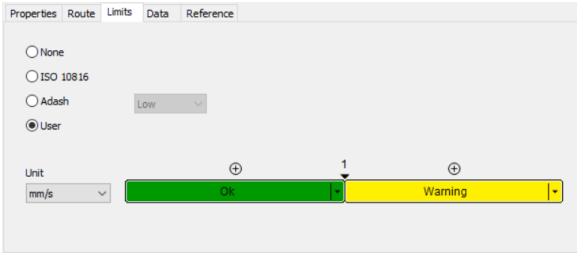

Same way you can add any number of limit values.

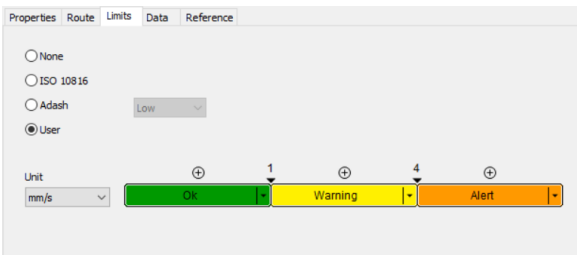
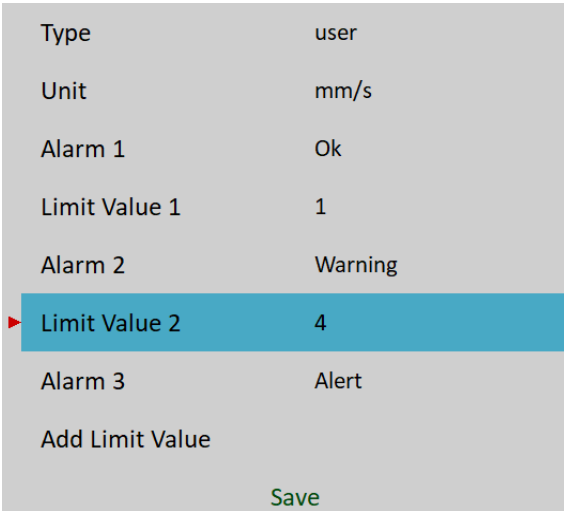

Limit values can be also edited or deleted using an appropriate **Limit Value** item.

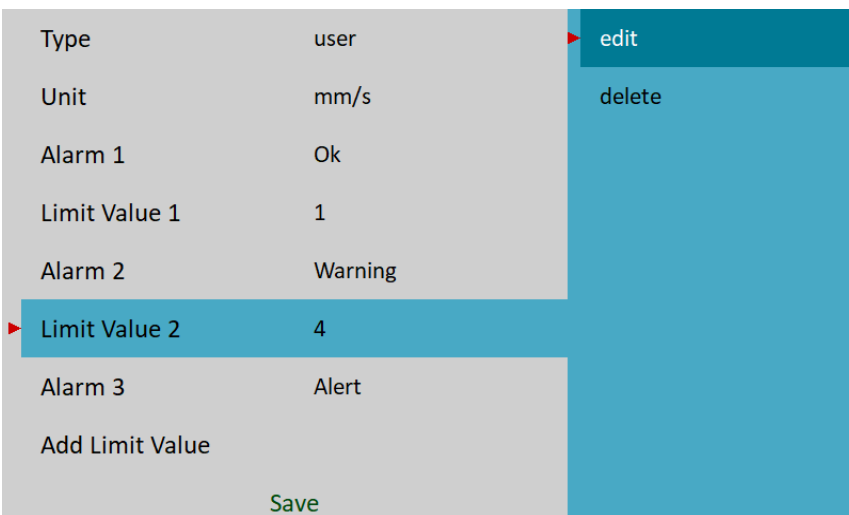

Alarms are defined using an appropriate **Alarm** item.

Type	user	Ok
Unit	mm/s	Warning
Alarm 1	Ok	Alert
Limit Value 1	1	Danger
Alarm 2	Warning	
Limit Value 2	4	
Alarm 3	Danger	
Add Limit Value		
Save		

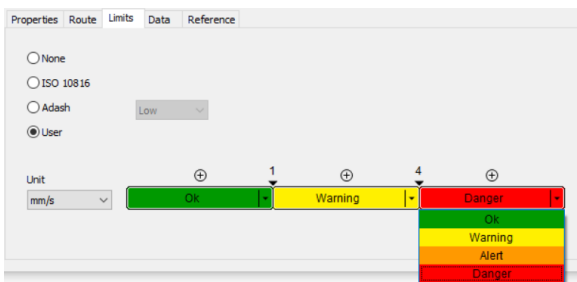

Note! You can assign alarms in any order. It's not required the Ok interval to be the lowest. Eg., for displacement measurements, there is often the Ok interval in the middle and Warning and Alert alarms are assigned to lower and higher intervals.

Type	user
Unit	µm
Alarm 1	Danger
Limit Value 1	50
Alarm 2	Warning
Limit Value 2	100
Alarm 3	Ok
Limit Value 3	300
Alarm 4	Warning
Limit Value 4	400
Alarm 5	Danger

Export to uff

Export data of selected measurement to the **uff** file format (not for all measurement types). The file is saved to **uff** folder on **VA5_DISC**.

If the **Actual** data are displayed then only this data will be exported. If the **Trend / History** data are displayed ([View Trend / View Actual](#)) then you can export just one displayed data or all data in history. You'll be asked "**Export (All/One)?**".

Export to wav

Export data of selected measurement to the **wav** file format (time signal and orbit only). The file is saved to **wav** folder on **VA5_DISC**.

Time signal is exported as one file with two channels (1st channel for signal, 2nd channel for trigger).

Orbit is exported as two files (A and B channel).

Before exporting, you need to enter the required range of signal in wav file. It enables to obtain better resolution in file. If the true peak of signal is for example 8mm/s, then enter for example 10mm/s.

Enter the wav full scale value [mm/s]

10

Note! You may choose the 24 bit or 16 bit encoding of the wav file using [MENU / SETTINGS / Global Settings / Wav Encoding](#)

Export to csv

Exports data of selected measurement to the **csv** file format. The file is saved to csv folder on the *VA5_DISC*.

Csv Header

The first line in a csv file is a header with information about the measurement. Parameters in the header begin with a sign and are separated by a semicolon (**sign: value;**). The following is a list of possible signs:

- **u:** unit (the serial number of the unit in which the csv was exported)
- **ch:** channel
- **n:** number of samples (lines)
- **d:** delta (the difference between two samples in x axe unit)
- **eu:** evaluation unit
- **t:** time of measurement
- **s:** speed during measurement
- **sensor:** if sensor's [Name](#) is defined, it is also saved in the csv header
- **note:** The header can also contain a note which is automatically included from the set's notes (see [Notes](#)). Only notes created after the measurement was taken are included.

Csv Data

The measurement data are saved in individual lines. Each line contains values depending of type of measurement.

Time, g-env Time, ACMT

time; amplitude; trigger

Orbit

time, amplitude A, amplitude B, amplitude X, amplitude Y, trigger

Spectrum, g-env Spectrum, Octave spectrum

frequency, amplitude

Orders, Order spectrum

order, amplitude, phase

Frf

frequency, amplitude, phase, coherence

Cepstrum

frequency, amplitude

Export to csv (all)

Exports to csv for all measurements which are in the set (to a folder).

Export to Records

Only when the **record** measurement is selected in analyzer!

The list of all records in the selected record measurement appears. Select one or more records from the list. If you select only one record then enter the new name. The default name of the new record begins of the set

name followed by the date and time of recording (yyyy_mm_dd_hh_mm_ss_msec). Selected records will be exported/copied to the [Recorder](#) module (folder). Now you can work with them in Recorder module.

Export to VA5_DISC

Only when the **record** measurement is selected!

This item is very similar to the previous one. Export selected records to *VA5_DISC VA4recorder* folder.

Edit Measurement

The *Edit Measurement* menu is opened using **Meas / Edit**. This menu is also automatically opened when new measurement is created. The content of the menu is implication of the measurement type selection (first row). All parameters of all measurement types will be described here.

Type

The type of measurement. Actual [Trigger Settings](#) is displayed bellow the type value.

All channels

You may set this parameter to yes to create the same measurement for all channels.

Channel

The input signal source channel for evaluation.

A channel number

First channel number for orbits.

B channel number

Second channel number for orbits.

Input channel

The input channel for the frf measurement

Output channel

The output channel for the frf measurement

Unit

Measurement's physical unit

User must first define sensor's unit according to his sensor. Then, he also defines measurement's unit which must be convertible from the sensor's unit. That means it can be any unit of the sensor's physical quantity. For some measurement types, there is also possible integration or derivation of the signal. E.g.: sensor's unit g (acceleration) enables measurement's unit g, m / s², mm / s, in / s, mil, um ...

In addition, voltage unit (V, mV) is also accepted as measurement's unit regardless the value of sensor's unit. In this case, raw input signal is measured without any recalculation to physical unit.

Detect Type

The type of wideband value calculation (P means Peak)

RMS

root mean square or effective value

$$\text{RMS} = \sqrt{\frac{1}{n} \sum_i x_i^2}$$

Scaled 0-P

$$\text{Scaled0} - P = 1.414 \cdot \text{RMS}$$

True 0-P

it is true 0-peak value in the waveform, the maximum value of signal's absolute values.

Scaled P-P

$$\text{ScaledP} - P = 2 \cdot \text{Scaled0} - P = 2 \cdot 1.414 \cdot \text{RMS}$$

True P-P

it is true peak-peak value in the waveform (the difference between highest positive and highest negative value in signal)

AVG

it is average value of absolute values of all samples

$$\text{AVG} = \frac{1}{n} \sum_i (|x_i|)$$

Crest

it is equal True 0-P/ RMS

$$\text{Crest} = \frac{\text{True0} - P}{\text{RMS}}$$

Kurtosis

$$\text{Kurtosis} = \frac{\frac{1}{n} \sum_i x_i^4}{\left(\frac{1}{n} \sum_i x_i^2\right)^2}$$

Detect Type (for ACMT)**RMS, PEAK**

The [ACMT](#) compression can work in two ways. The compressed time signal can keep the **RMS** or **TRUE PEAK** of original signal.

Result Type

Standard frequency response functions measured between source channel and response channel

H1

input noise,

H2

output noise,

H3

the average of H1 and H2.

PAS

Phase Assigned Spectrum – the amplitude spectrum of response channel and phase are displayed

Band fmin**none, 1, 2, 10, user**

The low cut-off frequency of band pass filter, which is applied to the signal before evaluation (removing low frequencies). The **none** value means, that only A/D converter input filter is applied.

Note! If you do not expect any important signal bellow 10Hz, use the 10 Hz filter instead of 1 Hz. The initialization time of 1Hz filter is much longer then 10Hz.

Note! The **none** value is available only for direct measurement without integration. The **none** value does not mean the DC part measurement. The HP filter on A/D converter is always used. But no additional filter is used. The frequency range with **none** filtering begins on 0.35 Hz (-3dB point). See the response graph.

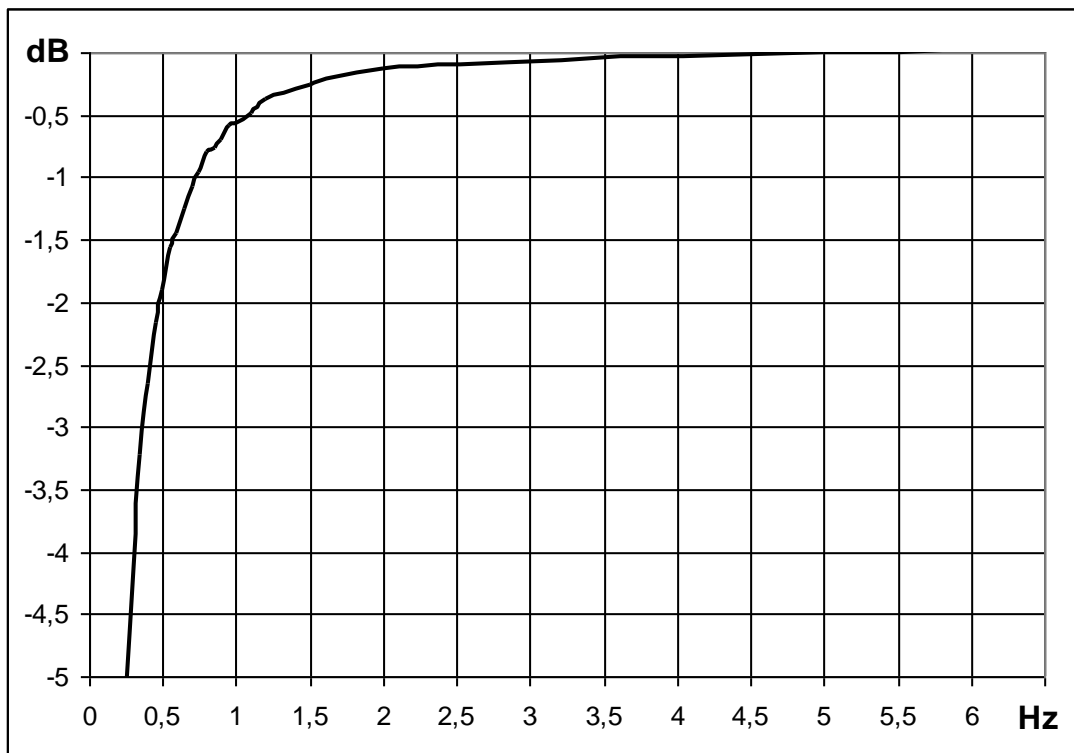

Band fmax

It is the high cut-off frequency of band pass filter, which is applied to the signal before evaluation (removes high frequencies). The **none** value means, that the highest frequency is determined only by input filter of an A/D converter.

Sampling Freq

By default, the sampling frequency is determined **by fmax** so as the sampling theorem is satisfied:

$$f_s > 2 * f_{max}$$

Sampling frequency can be only one of these values:

64, 128, 256, 512, 1024, 2048, 4096, 8192, 16384, 32768, 65536, 196608 Hz

Each value is power of two, except the last one. The highest value should be used in special cases where you need the highest possible frequency range. However, keep in mind the fast frequency is not power of two and as a consequence you will not get nice values for spectrum resolution or time waveform length because the number of samples of input signal is always power of two.

However, when you need to use a certain filter, the suggested sampling frequency may not be sufficient. Look at the sine wave with a frequency of 80 Hz. You may set *Band fmax* as 100 Hz which is suitable lowpass frequency for your signal. If you leave the sampling frequency determined by *fmax* then its value is estimated as 256 Hz. This means your signal will be sampled with 256 / 80 = 3.2 samples per period.

Band fmin[Hz]	10
Band fmax[Hz]	100
Sampling Freq[Hz]	256 by fmax

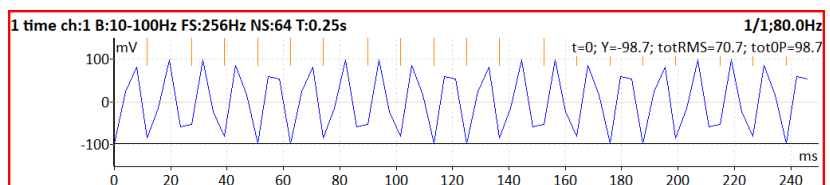

As you can see on the picture, it's hardly recognizable that it is a sine signal. It would be better if you use higher sampling frequency. And if you still need to use the band filter with 100 Hz *fmax* frequency, then the *Sampling*

Freq parameter enables you to define any higher sampling frequency from the frequencies row and use so called **oversampling**. With oversampling, the signal is rendered more precisely.

Band fmin[Hz]	10
Band fmax[Hz]	100
Sampling Freq[Hz]	2048 oversampling: 8x

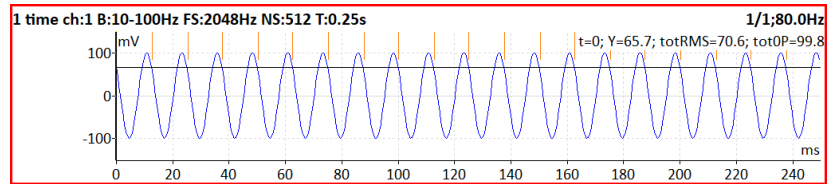

Oversampling is also useful when using filters in orbits. Compare same orbit with various sampling frequency.

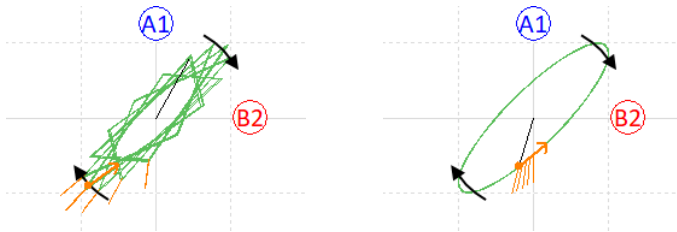

Warning! If the sampling frequency value differs from the “by fmax” value, the measurement cannot be correctly processed by instruments with firmware older than 0282.

DEMOD fmin

The low cut-off frequency of band pass filter, which is applied to the signal before demodulation (removing low frequencies).

DEMOD fmax

The high cut-off frequency of band pass filter, which is applied to the signal before demodulation (removing high frequencies).

The DEMOD fmax is used to determine a sampling frequency.

Range

Frequency range of the spectrum measurement. Under this item is also displayed the information about sampling frequency (*fs*), which will be applied for evaluation.

The Range is used to determine a sampling frequency.

ACMT FS

The sampling frequency for ACMT compression. It defines sampling frequency of the resulting signal, i.e. $1 / ACMT FS$ means time difference between two samples. Less value of *ACMT FS* means signal is more compressed.

Note! The input sampling frequency is hard coded as 65536 Hz or maximum possible frequency of input signal, i.e. when record with lower sampling frequency is used as input, then record's sampling frequency is used as acmt's input sampling frequency.

Note! $Input FS / ACMT FS$ gives a compression ratio, i.e. the number of samples which are resulting in one sample. With default value of 1024 you have $65536 / 1024 = 64$ samples are stored as one value.

Window

rectangular, hanning, transient, exponential, flat top

The standard offer of FFT windows functions.

When you select the Transient or the Exponential window you need to define it's **Shift** and **Length**, both in milliseconds. You can enter these values directly in the menu. But this can be impossible in most cases. Rather use the approach from the next example (used to setup an exponential window for a bump test).

Set the **exponential** window. Keep the default values of the *Shift* and *Length* parameters. Confirm the menu. Open the [Graph Properties](#) menu and set the *View* parameter to **time** so as to show the measured time signal instead of spectrum. Take first reading.

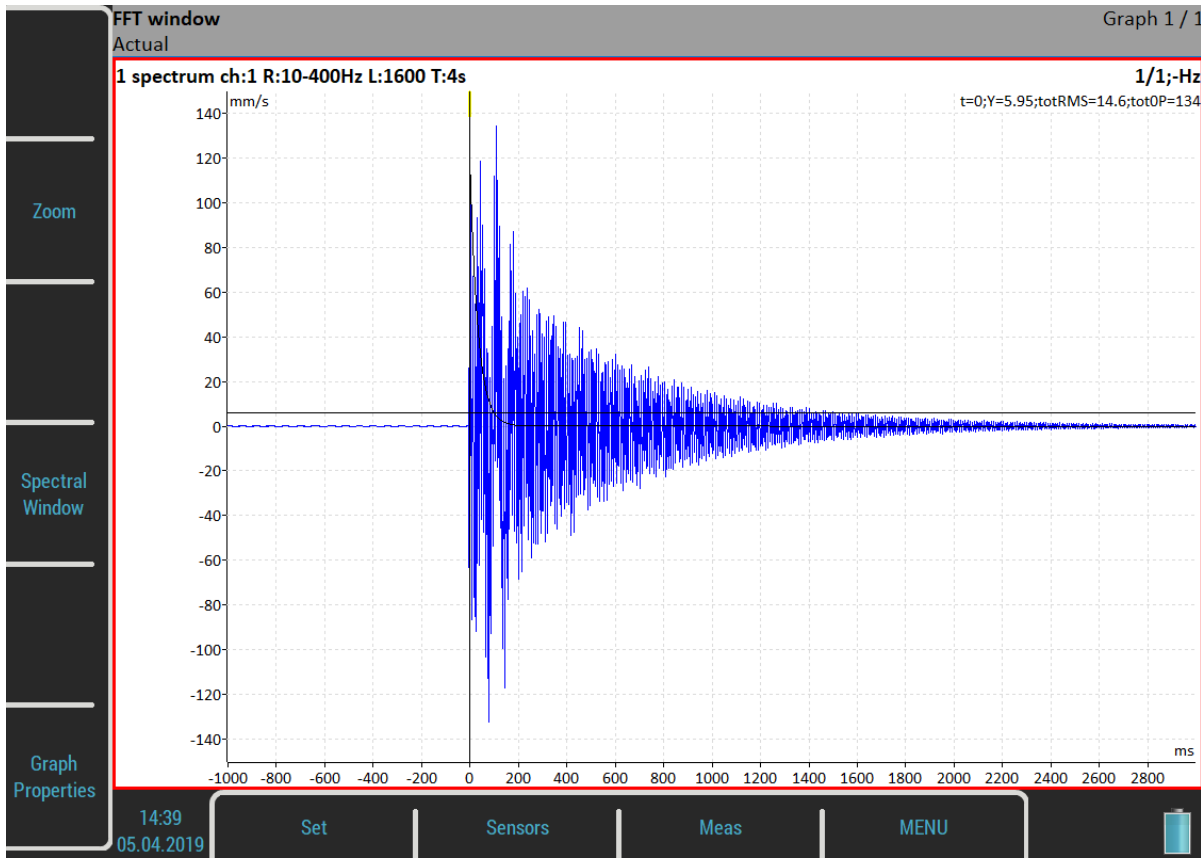

A **Spectral Window** option is available as a buttons mode now. Push the button and you will be able to setup the parameters according to the measured signal using **Shift1** and **Length1** functions. You may set these parameters also during measurement process.

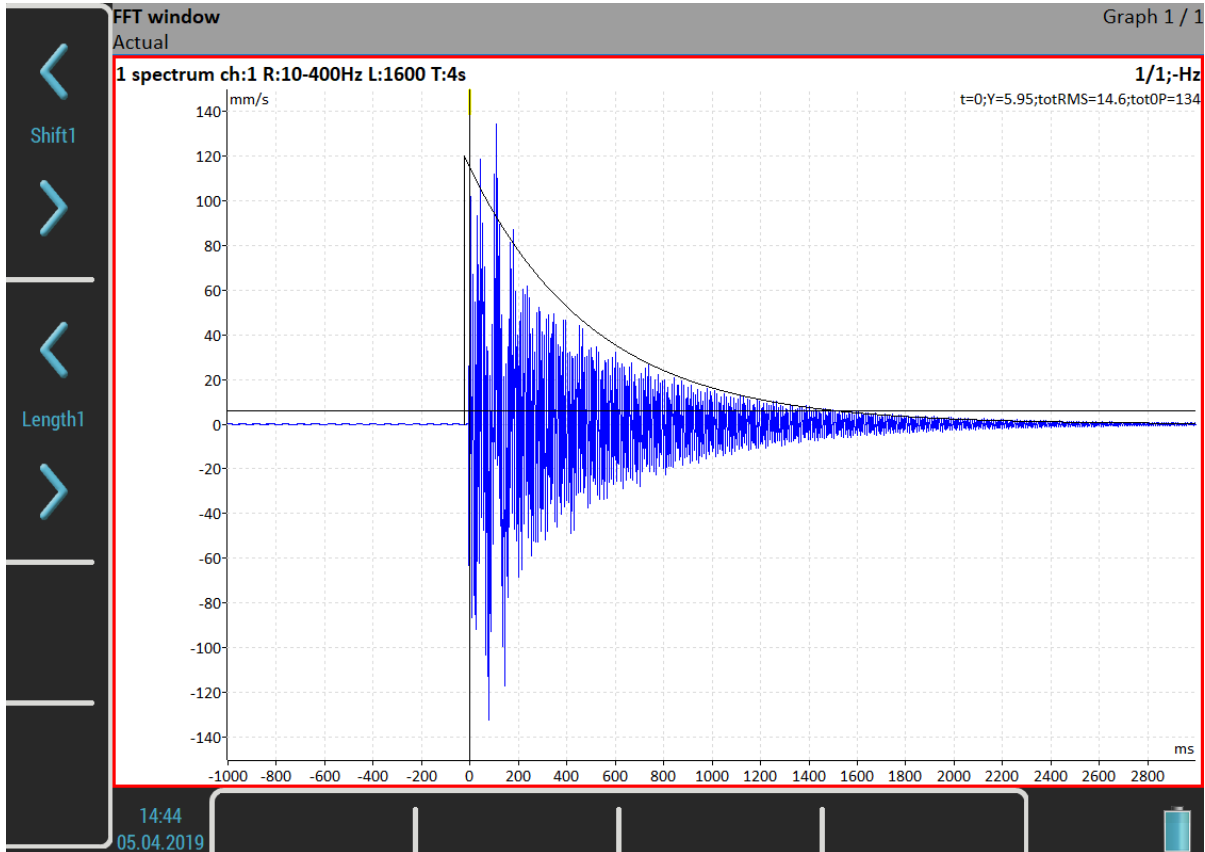

Now, when the window is set, change the view back to the spectrum and take your final reading.

In case of the frequency response function, you must setup two FFT windows for input and output signal. Then a **Shift2**, **Length2** and **Shift12** functions are available moreover.

Zoom spectrum

no

standard spectrum will be made (range from zero)

yes

zoom spectrum will be made (range around the center frequency)

Center freq

Center frequency for zoom spectrum

Trigger control

off

Time signal will contain defined number of samples

on

Time signal will contain defined number of triggers. E.g., if the [Trigger Source](#) is set to **tacho**, then it means number of revolutions.

Samples

Number of samples. The signal time length is displayed under this item.

Number of triggers

Required number of triggers (when [Trigger control](#) is **on**).

Lines

Number of lines of spectrum. The signal time length (t) and delta frequency between two lines (df) are displayed under this item.

Averaging

linear, **peak hold**, **time synchro** (for spectrum)

linear, **maximum**, **minimum**, **median** (for static values)

Time synchro averaging works in this way: the time signals are averaged (must be controlled by tacho in most cases) and from averaged time waveform is calculated the final spectrum. It can be set for non-enveloped and non-zoomed spectra.

Avg

off or number of values in average. The total time (*total t*) needed to take the whole measurement is displayed below this value.

Trigger Source determines how the measurement between particular values of an average is triggered:

- **freerun**
when the measurement is started, all signals needed for averaging is taken continuously
- **external**
when the external trigger comes, all signals needed for averaging is taken continuously without waiting for next trigger
- **tacho**
every signal for averaging is triggered by tacho (constant phase)
- **amplitude**
every signal for averaging is triggered by amplitude
- **manual**
first signal for averaging is triggered manually, next signals are taken freerun
- **manual sequential**
every signal for averaging is triggered manually

Note! If averaging is used, the **Min** and **Max** values are displayed in the static graph's bottom left corner. This represents minimum and maximum value during averaging. You can see the deviation of the measured value. These values are displayed only during measurement and are not saved to the trends.

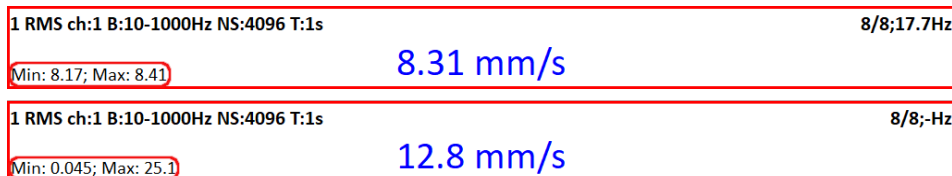

In the first graph, you can see a low deviation in the value (Min: 8.17; Max 8.41). This averaged value is acceptable. On the contrary, the second graph shows a measurement with a huge deviation (Min: 0.045; Max: 25.1). Pay attention to such measurements. The measured value is almost random.

Note! If averaging is used, you probably want the measurement to be finished with the number of averaged values as defined. Sometimes, it is not possible to stop the measurement right when the averaging has been finished. Therefore, when you press the *Stop* button during a measurement with uncompleted averaging, the measurement process will not stop immediately. Instead, a **Finishing Averaging** info window will appear. You may wait until the averaging is finished or push the *Stop* button again to stop the measurement process regardless the averaging is finished or not.

Finishing Averaging

Overlap

Overlapping of signals during averaging in percent of signal's length.

Overlap enables to speed up the procedure of averaging. E.g. overlap of 75% means that 75 % of already taken signal is used for next evaluation with 25 % of new signal.

Attention! The overlap is not used for **time synchro** [Averaging](#).

Attention! The overlap is used only for [Trigger Source](#) which doesn't wait for trigger between averages, i.e. **freerun, external, manual**.

Frequency

speed, user

The frequency value for phase shift measurement can be entered manually (user) or can be used the speed frequency from tach probe.

Order

Usually user needs the measurement of amplitude and phase on speed frequency. In Order parameter you can define any multiplication of speed and to measure amplitude and phase on that frequency.

measured frequency = Order * speed

Caution! You may enter any number as an order, but the phase can only be evaluated for integer orders.

Orders

1/2,1-5, 1-5, 1/2,1-10, 1-10

It defines which orders in order analysis will be measured.

Resolution

speed / value

This number defines the bandwidth of the spectrum line. When two near frequencies exist and they are contained in one spectrum line, then this line shows the sum of both. When we want to get correct amplitude and phase value for example on speed frequency, then we must ensure that the spectrum speed line bandwidth contains just the speed frequency. If other frequency exists in the speed line, then it makes disturbing and we get wrong value. The next important feature of the **speed / N** resolution is that the number N is number of revolutions in required time signal, from which the spectrum is made.

Example! The speed is 25 Hz. The entered resolution is **speed / 4** (it means that time signal contains 4 revolutions), i.e. 6.25 Hz. The line bandwidth in FFT will be 6.25 Hz. It means, that speed line contains all frequencies in the interval (21.875 , 28.125). If any disturbing frequency is in that interval, then higher resolution must be used, for example **speed / 8**.

Attention! When you select higher resolution (for example speed / 64 or even speed / 1024) then more revolutions must be taken and you will wait for results longer time. The higher resolution means longer time signal for evaluation. We do not recommend using always the maximum value, because you will wait for results longer (much longer). Use the high resolution only in cases, when your signal contains two close frequencies and you need to separate them.

Resolution in orders. The resolution value in order analysis is connected with the number of revolutions similarly as resolution in frequency spectrum is connected with the number of seconds. Resolution in frequency domain can be expressed as $\Delta f = 1 / T$, where T is the number of seconds per FFT record. Similarly, resolution in order analysis can be expressed as $\Delta \text{ord} = 1 / \text{rev}$, where rev is number of revolutions per FFT record. This resolution is defined in orders. If you want to express the order analysis resolution in frequency unit you need to multiply the resolution in orders by the speed frequency. Therefore, the value of resolution is entered as the fraction of speed frequency and the required number of revolutions is displayed in the note below the resolution value.

Resolution	speed / 4 t = 4 revs
------------	-------------------------

Attention! For measurements with adjustable order value, take care to correctly setup suitable resolution according to demanded order. The order value must be an integer multiple of the resolution in orders, i.e. an

integer multiply of the 1 / rev. The menu itself helps you meet this condition. Any time you enter the order, the lowest appropriate resolution is automatically set. Then, you may increase the resolution value according to your needs. The resolution submenu always contains suitable values for actual order. However, you may still enter any user value. The nearest possible order, which will be truly used in calculation, is shown as a note if the actual order is not possible for the entered resolution.

For example, when the resolution in Hz = speed/4, then resolution in orders = 1/4 = 0.25. The available orders are for example 1.25, 1.5, 1,75 etc.

Order	1.2 nearest possible = 1.25
Resolution	speed / 4 t = 4 revs

Attention! The order value should be at least four times higher than Resolution in orders. Instrument ensures this condition regardless the setup by increasing the number of revolutions.

Full spectrum

yes, no

The spectrum will have two sides, positive and negative (see literature about turbine analysis for more details). It is important to define correct sequence of channels. It must match the rotation direction. It means, the tachometer mark must come to A channel first and then to B channel. The angle must be less than 180 degrees. Otherwise the positive/negative parts would be transposed.

Graph Properties

Except measurement parameters, you may also set graph properties which influence the way how signals and values are displayed, e.g. axes scale, logarithmic axis and so on.

Note! All available properties will be described now. But not all of these properties are displayed always. During your work are always displayed only values/choices, which give sense at that moment. For example the Axis Z (third) axis is only visible in 3D graphs (for example cascade, spectrograph).

Display

value, trend

Available for overall values in the [Runup](#) module. It enables to display a trend during measurement process. When **value** is used then only last measured value is displayed (default setting).

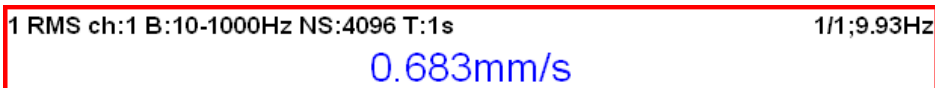

When **trend** is used all measured values are displayed in the trend.

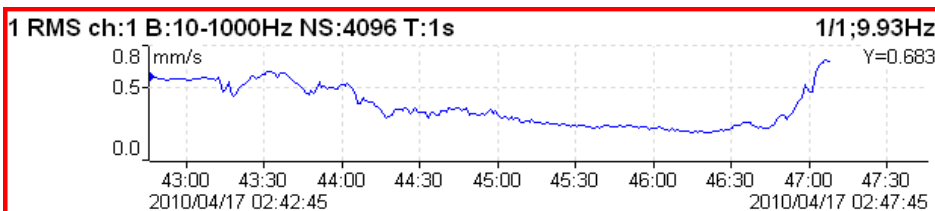

Scale

max

Y autoscale for every new signal, but the range is only increasing when higher value comes.

auto

Y autoscale according data values of every new signal.

user

User defines Y scale for an axe independently of data values.

Graph Unit (for spectra)

Set a physical unit which is used to display a signal in the graph. The unit may differ from the unit in which the signal was measured and stored ([Edit Measurement / Unit](#)). You can choose any unit from a menu. By default, a **same as meas** value is used, i.e. no recalculation is applied and the signal is displayed in the same unit as it was measured.

Note! Integration and derivation of the signal is available in spectra.

Cursor (for time signals)

single

standard simple cursor

periodic

multiplied cursor with several additions of delta time

delta

band cursor with delta time length

When you use periodic or delta cursor you need to setup a **Delta X** value. This can be done in the *Graph Properties* menu or using **Delta X** function available in the **Control** mode of side buttons. During initialization, the *Delta X* value is set according to speed if possible.

Cursor (for spectra)

single

standard cursor

harmonic

cursor with several additions of delta

sideband

cursor with one addition delta

delta

cursor with one addition delta

When you use sideband or delta cursor you need to setup a **Delta X** value. This can be done in the *Graph Properties* menu or using **Delta X** function available in the **Control** mode of side buttons. During initialization, the *Delta X* value is set according to speed if possible.

Cursor Position

The time or frequency position of cursor in the selected graph.

Delta X

The time or frequency interval used for delta cursor computation.

Axe X

lin., log

Axe Y

lin., log, dB

Axe Z

time

Signals are ordered according to a reading's time.

speed

Signals are ordered according to a reading's speed.

regular

Signals are ordered according to a reading's time but drawn with constant space between two readings regardless to when the readings were taken.

Order Z

first in front, last in front

The order of spectra on Z axe.

Detect Type

RMS, 0-P, P-P

Detect type for spectral amplitude values

Note! This value is same as global value defined in [MENU / SETTINGS / Spectrum Settings / Detect Type](#) until you change it here. That means, if you change the global value it will be changed here also. This will stop after the first time you enter a value here.

Peaks List

on, off

The 5 highest spectrum lines table.

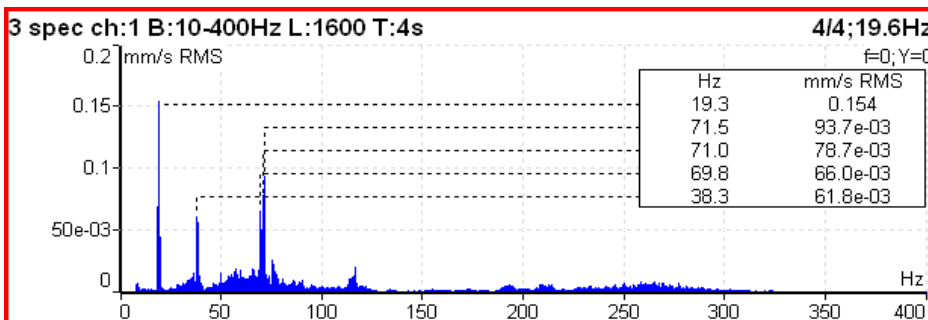

Synch Table

on, off

Table of values synchronized with speed and line frequency.

- **SubSynch**
value bellow speed frequency
- **Synch**
value on speed frequency and harmonics
- **NonSynch**
total value without SubSynch and Synch
- **Elect**
value on line frequency and harmonics (setting in [Global Settings / Power/Line Frequency](#))

All values are in displayed spectrum unit and in % of total value.

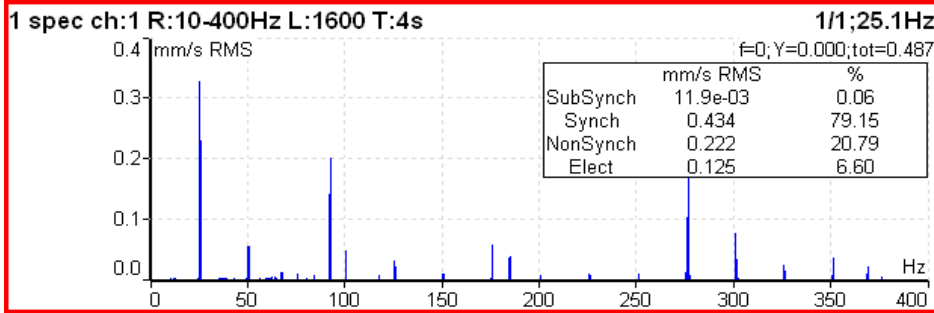

Orders Table

on, off

Table of values for particular orders in order analysis.

Statistics Table

The basic statistic values of trend are displayed:

- ***n***
number of measurements in trend
- ***EX***
mean value (arithmetic average)
- **σ (*sigma*)**
deviation average
- ***Xmax***
maximum value
- ***Xmin***
minimum value
- ***Xmax-Xmin***
the interval of measured values

Primary Cursor

When the [Global Settings](#) / [Cursor Type](#) is set to **max** then you may choose which signal will be the max searching applied to.

amplitude, phase for frf
X, Y for orbit

View (for center line trend)

center line

Standard 2D center line view in the xy plane.

AB

Two trends of values measured on A and B inputs.

XY

Two trends of values transferred to X and Y

View (for frf)

ampl, phase

real, imag

nyquist

amplitude

phase

coherence

time

amplitudes

View (for amp+phase trend and complex Smax)

aps_t

Trends of amplitude, phase and speed related to time of reading.

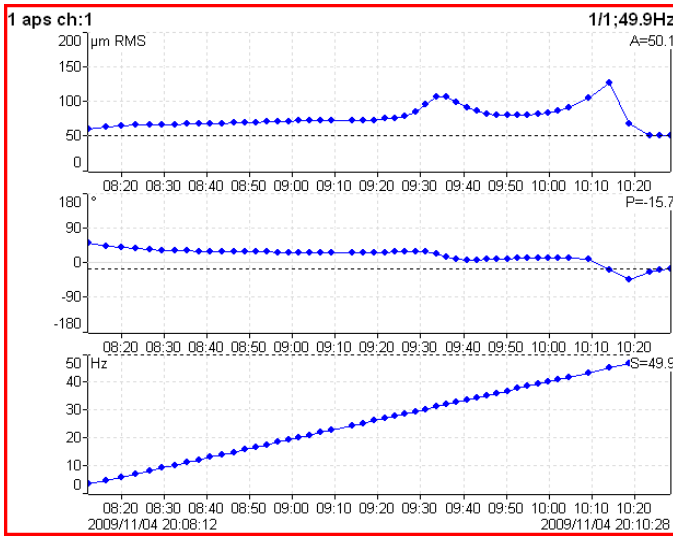

ap_s

Trends of amplitude and phase related to speed.

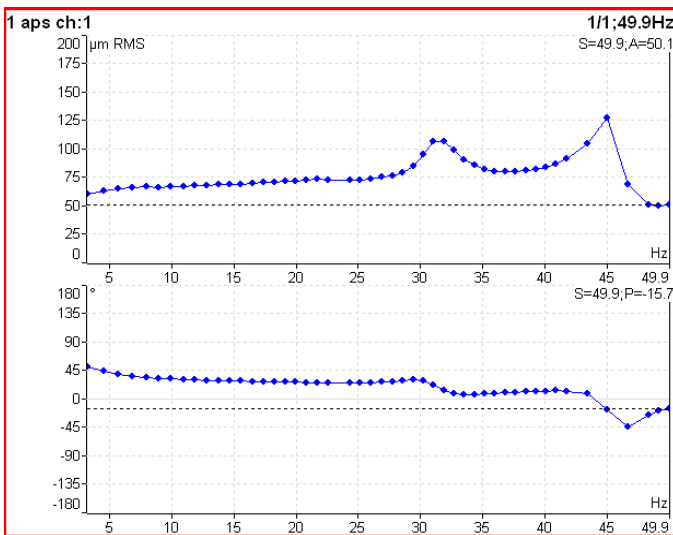

ad_s

Trends of amplitude (upper graph) and **difference amplitude** (lower graph) related to speed. The difference is related to the *trend cursor* position, thus it is always zero in the cursor position.

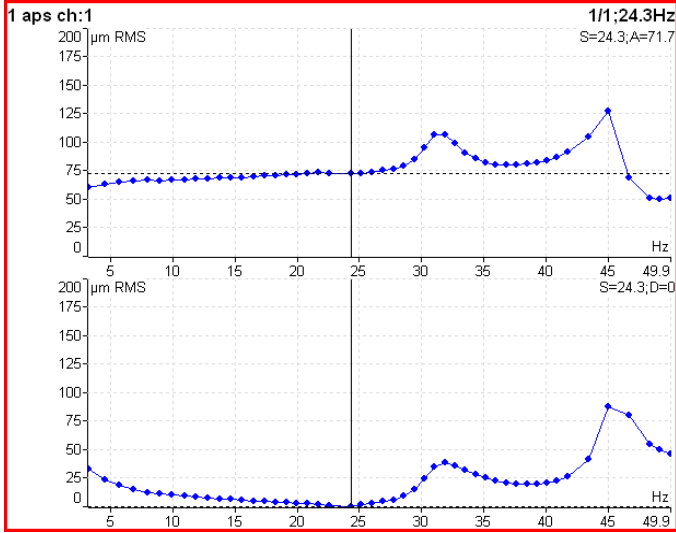

polar
2D complex view

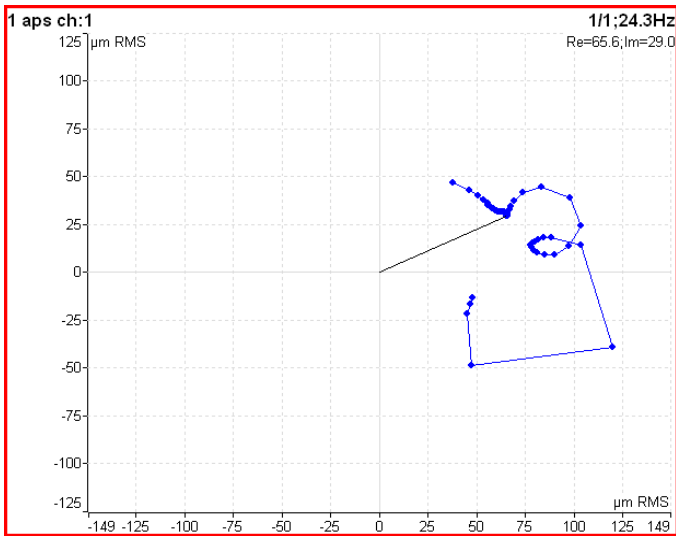

trend3D_t
The 3D "tube" view. It is the Nyquist graph expanded to z axis (time scale).

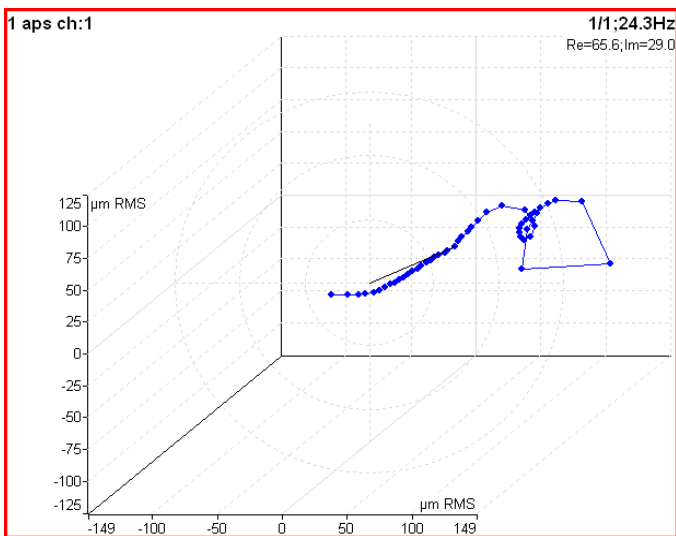

View (for phase shift trend)**linear**

Trend of phase shift, amplitude ratio and coherence related to the time scale.

polar

Polar plot of phase shift and amplitude ratio.

View (for spectrum trend)**amplitude**

One amplitude graph.

cascade

Cascade graph.

spectrograph

2D view of amplitudes vs. time

phase

One spectrum phase graph

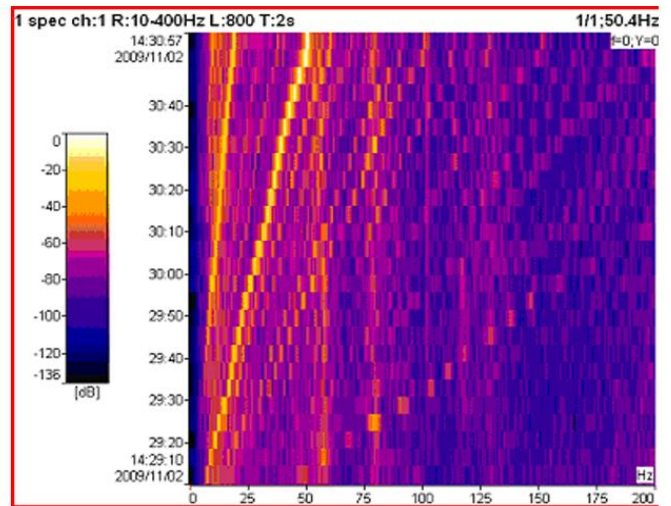
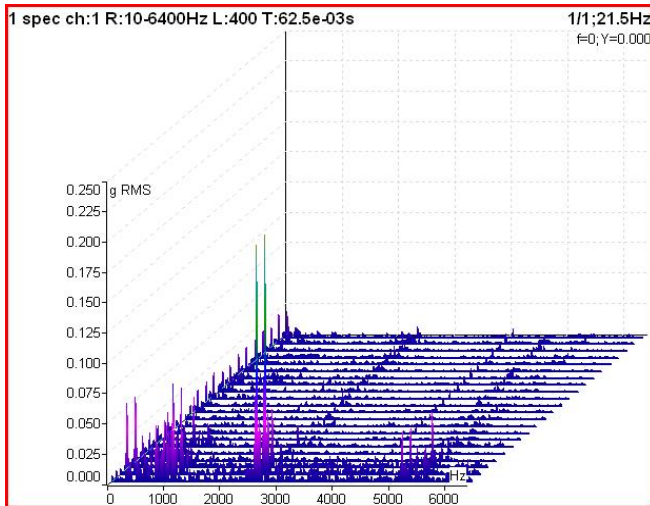
**View (for actual spectrum)****amplitude**

One amplitude graph.

time

Displays the time signal from which the FFT was developed.

phase

One phase graph.

View (for time waveform)**linear**

Standard drawing of time signal.

circular

Circular drawing

Note! When signal contains tacho pulses, then one rotation length is 360° (one circle). If not, then complete signal is drawn only in one circle.

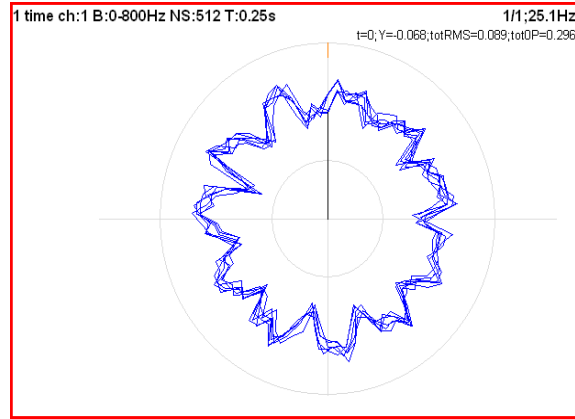
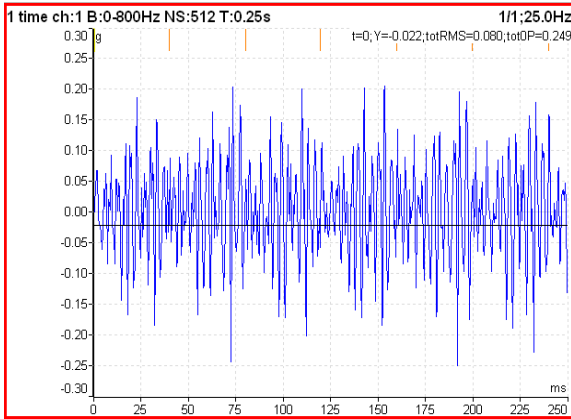

View (for orbit)

orbit

Standard 2D orbit view in xy plane.

AB

Two input time signals from channels A and B.

XY

Two time signals transferred to X and Y axes.

View (for filtered orbit)

orbit, orders

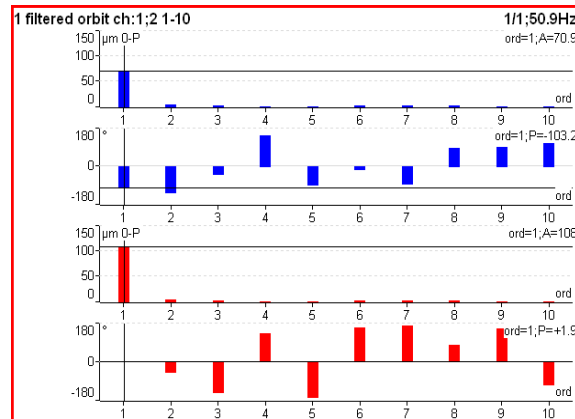
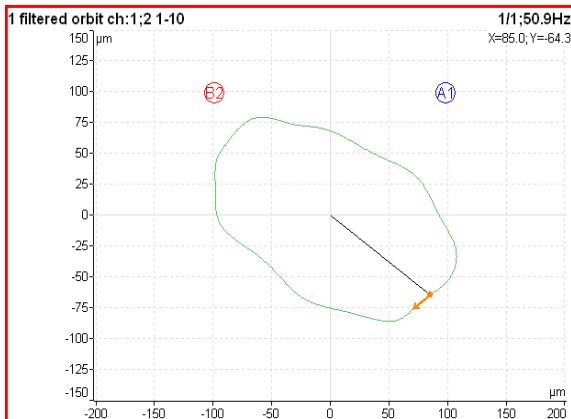

Time Axe Unit

time unit, degrees

By default, the time axe is marked by time units (milliseconds or seconds). However, you can set the time axe unit as degrees to determine the angle. The angle between two tacho marks is supposed to be 360°. According to [Angles Counting](#) setup the degrees are negative (for with rotation) or positive (for against rotation). This corresponds to the amp+phase measurement (the phase is negative when the signal maximum is behind the tacho mark and with rotation is set as Angles Counting).

Time Axe Unit = time unit:

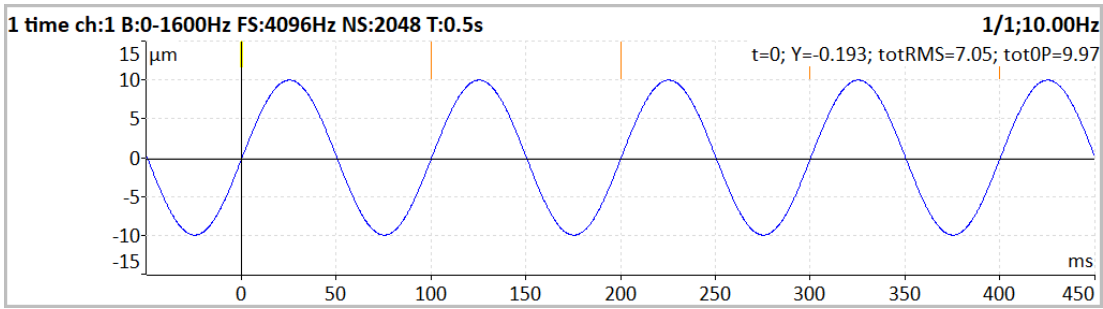

Time Axe Unit = degrees, Angles Counting = with rotation:

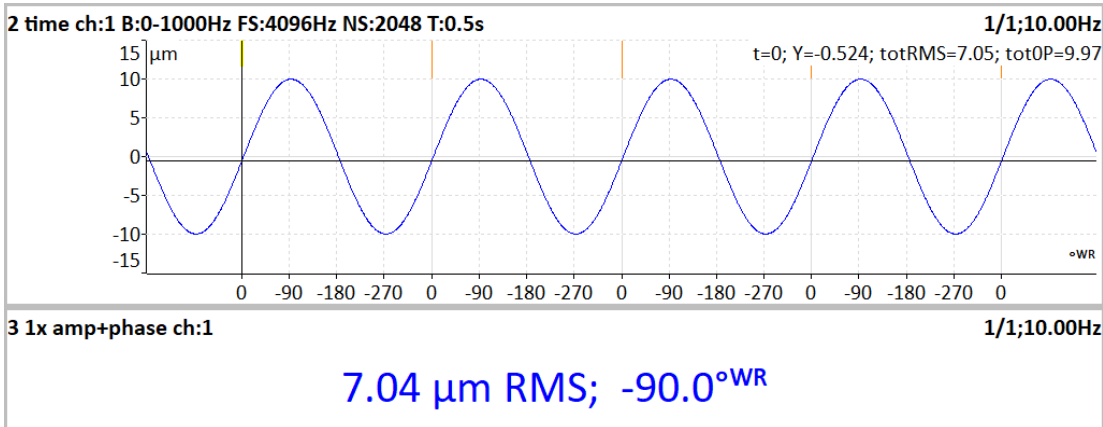

Time Axe Unit = degrees, Angles Counting = against rotation:

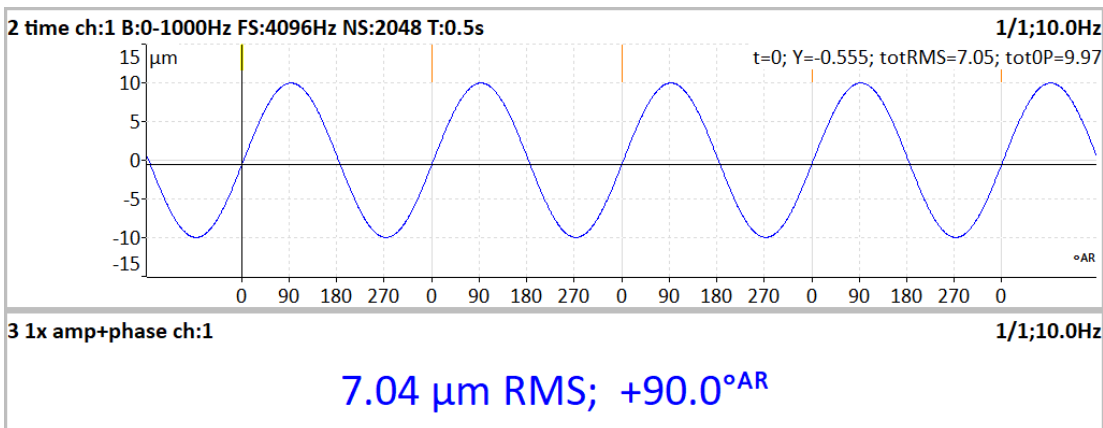

FFT Output (for spectrum)

- amplitude spectrum**
- power spectrum**
- amplitude spectral density**
- power spectral density (PSD)**
- energy spectral density (ESD)**

Frf Format (for frf)

When a FRF is used with force units on one channel and some vibration units on another channel, you may display the FRF in different units than the one in which it was measured. The alternative formats are created by performing math operations on the FRF:

Integration and differentiation: Acceleration can be changed to velocity or displacement.

Inversion: The FRF can be inverted, so it is input over output, rather than output over input.

default

No units conversion is applied. The FRF is displayed in same units as measured.

accelerance

acceleration / force

mobility

velocity / force

compliance

displacement / force

dynamic mass

force / acceleration

mechanical impedance

force / velocity

dynamic stiffness

force / displacement

Bearing Faults

on, off

If a bearing is defined in [Bearing Settings](#) and the measurement contains speed, then the fault frequencies are displayed in spectrum.

- **FTF**
Fundamental Train Frequency
- **BPFI**
Ball Pass Frequency of Inner ring
- **BPFO**
Ball Pass Frequency of Outer ring
- **BSF2**
Ball Spin Frequency * 2 = Ball defect frequency
BSF2 is the bearing failure frequency which you can see exactly in the spectrum, because spinning defective ball hits the bearing twice during one ball revolution: once hits outer ring and once inner ring.

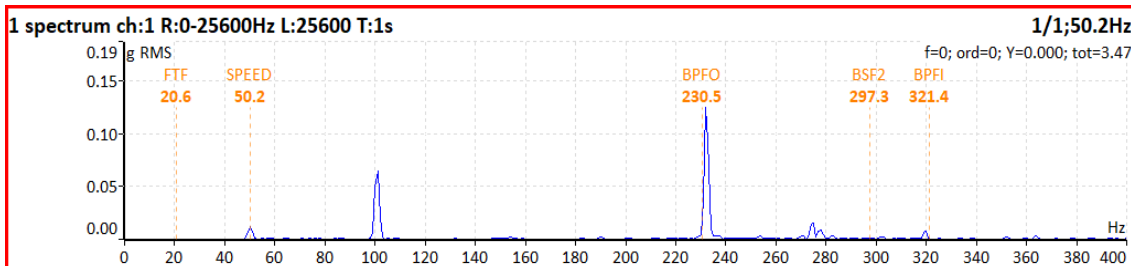

Note! If the measurement doesn't contain the speed information then cursor position represents the speed frequency.

FTF Period

on, off

The FTF time period is displayed in time signal

BSF2 Period

on, off

The BSF2 time period is displayed in time signal

BPFO Period

on, off

The BPFO time period is displayed in time signal

BPFI Period

on, off

The BPFI time period is displayed in time signal

Speed Period

on, off

the speed time period is displayed in time signal

Graph Lines

the spectrum can be drawn as line through the tops of line or as discrete vertical line for each frequency

continuous

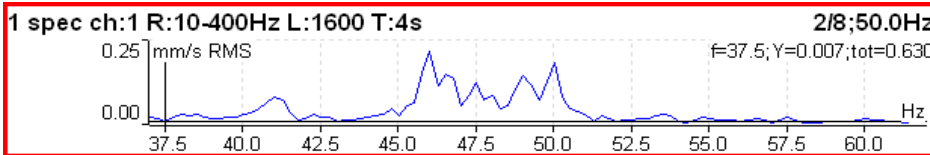

discrete

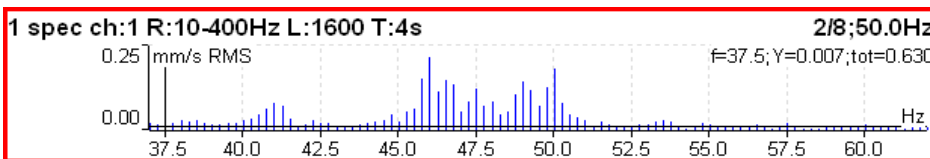

FASIT

It's a measurement type to find out machine's faults. There is a detailed description in the [FASIT](#) module chapter.

If the FASIT is measured, the [Speed detection](#) is done before the measurement process.

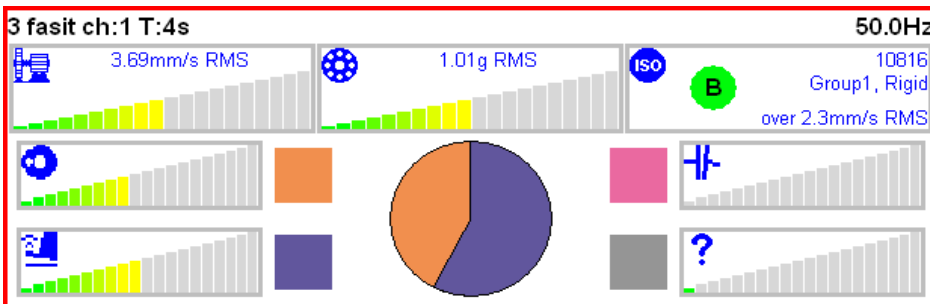

Type	overall freerun, retrig
All Channels	no
Channel	1
Unit	mm/s
Detect Type	RMS
Band fmin[Hz]	10
Band fmax[Hz]	1000 fs = 4096 Hz
Trigger Control	off
Samples	4096 t = 1 s
Averaging	linear
Avg	off total t = 1 s

Save

[Type](#), [All channels](#), [Channel](#), [Unit](#), [Detect Type](#), [Band fmin](#), [Band fmax](#), [Trigger control](#), [Samples](#), [Averaging](#), [Avg](#)

This is a typical example of overall measurement. The RMS value of vibration velocity in frequency range 10-1000 Hz is measured.

1 RMS ch:1 B:10-1000Hz NS:4096 T:1s 1/1;25.1Hz <p style="text-align: center; color: blue; font-weight: bold; margin-top: 10px;">0.570mm/s</p>
--

The first row contains used parameters. In the right top corner, there is an averaging index and number and a speed value.

Change the [Detect Type](#) to **True 0-P**.

1 0-P ch:1 B:10-1000Hz NS:4096 T:1s 1/1;25.1Hz <p style="text-align: center; color: blue; font-weight: bold; margin-top: 10px;">1.98mm/s</p>

Note, that the 1.98 is not 1.414 times bigger than 0.570. Some of users mistakenly think, that the formula $0-P = 1.414 * RMS$ is valid for every signal. It is not true. That formula is valid only for pure sine wave ! The true RMS and true peak measurement are generally independent. The only rule is that the peak value is always bigger than RMS value.

Let's change the Avg to 8. The eight individual values (1 sec length) will be taken and the result will be the linear average of them ($RV = (V1+V2+...+V8)/8$). The indication 8/8 is on the right top.

1 0-P ch:1 B:10-1000Hz NS:4096 T:1s 8/8;25.1Hz <p style="text-align: center; color: blue; font-weight: bold; margin-top: 10px;">2.00mm/s</p>

Let's change the Avg back to off and change the samples number to 32768. The measurement will be 8 sec long.

1 0-P ch:1 B:10-1000Hz NS:32768 T:8s 1/1;25.1Hz <p style="text-align: center; color: blue; font-weight: bold; margin-top: 10px;">2.12mm/s</p>
--

You see that the result is different from the previous value. It is clear, the max 0-P value in 8 sec signal is not equal the average of 8 0-P values (which takes 1 sec each).

Let's change the type back to RMS.

1 RMS ch:1 B:10-1000Hz NS:32768 T:8s 1/1;25.1Hz
0.572mm/s

Now change the length to 1 sec (4096 samples) and Avg=8.

1 RMS ch:1 B:10-1000Hz NS:4096 T:1s 8/8;25.1Hz
0.572mm/s

You see the same result. Both values are equal. The meaning of RMS differs from peak values. The RMS value depends only of total time of measurement. It does not care if one long signal was taken or several shorter signals were averaged.

You can define the signal length also by [Number of triggers](#), when you set the [Trigger control](#) to **on**.

Type	overall freerun, retrig
All Channels	no
Channel	1
Unit	mm/s
Detect Type	RMS
Band fmin[Hz]	10
Band fmax[Hz]	1000 fs = 4096 Hz
▶ Trigger Control	on
Number of Triggers	16
Averaging	linear
Avg	off
Save	

The *T* note changes to *R*, which means *Revolutions*, because the number of revolutions and tacho triggering is the most common usage.

1 RMS ch:1 B:10-1000Hz R:16 1/1;25.1Hz
0.545mm/s

ISO 10816 overall measurement

The ISO 10816 limit values are also available for overall measurements. The green / amber-orange/ red point is displayed in front of measured value according to the ISO limit.

If you want to use this function you need to define the correct measurement parameters (RMS velocity measurement in 10-1000Hz range) and the [ISO 10816 Machine Group](#) in the [Sensors](#) menu.

1 RMS ch:1 B:10-1000Hz NS:4096 T:1s 1/1;17.7Hz
D 8.30mm/s RMS ISO 10816: Group1, Rigid
 over 7.1mm/s RMS

The color of circle is related to the machine condition class A,B,C,D (the green for A or B, the orange for C and the red for D). Also the information about machine group and foundation are displayed. The limit which is exceeding is also displayed at the bottom.

Spectrum

Type	spectrum freerun, retrigger
All Channels	no
Channel	1
Window	hanning
Unit	mm/s
Zoom Spectrum	no
Band fmin[Hz]	10
Range[Hz]	400 fs = 1024 Hz
Lines	1600 t = 4 s, df = 0.25 Hz
Averaging	linear
Avg	8 total t = 32 s
Overlap	0%
Full Spectrum	no

Save

[Type](#), [All channels](#), [Channel](#), [Window](#), [Unit](#), [Zoom spectrum](#), [Band fmin](#), [Range](#), [Lines](#), [Averaging](#), [Avg](#), [Overlap](#), [Full spectrum](#)

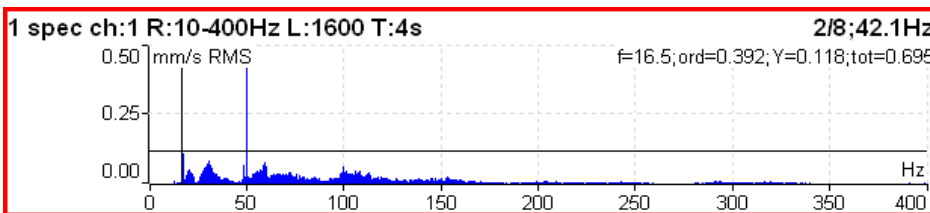

The information in top right corner contains averaging and speed and below them cursor position (f), order = f / speed (ord), cursor y-value (Y) and total RMS of spectrum (tot). The full list of symbols is in [Appendix C: Symbols and Abbreviations](#).

Full spectrum

Set [Full spectrum](#) to **yes**. Remember to set correct angles of both sensors. It influences the calculation. The FFT is applied to complex signal, first channel is real part and second channel is imaginary part.

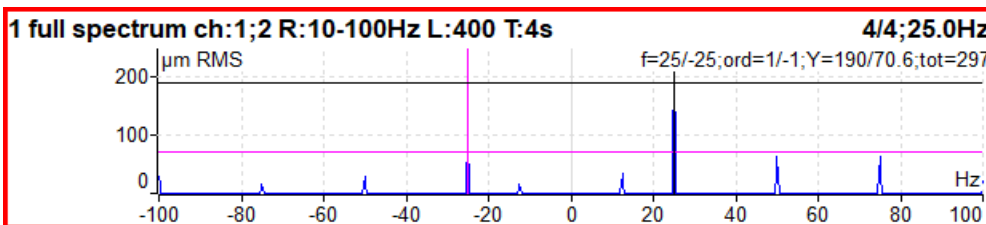

Note! Cursor is displayed on both sides. Different colors are used. Both cursor values are displayed.

Attention! The correct setting of A channel number and B is critical for correct result. If this setting is wrong then the negative and positive side are interchanged. Firstly we find the angle between A and B, which is less than 180° (usually it is 90°). The rotation mark must be firstly on A and then in B.

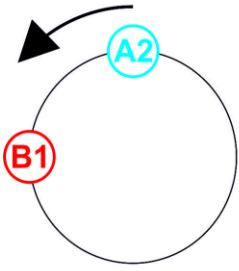

CORRECT

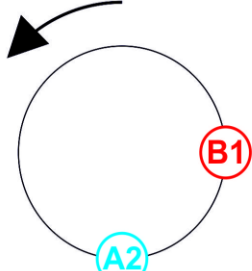

CORRECT

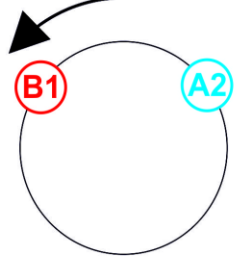

CORRECT

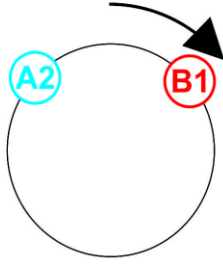

CORRECT

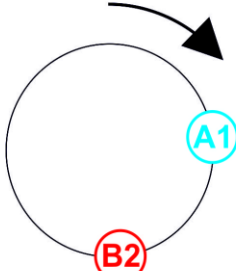

CORRECT

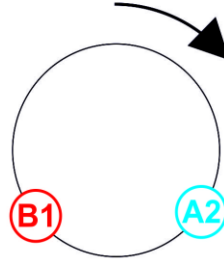

CORRECT

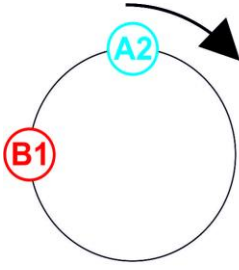

WRONG

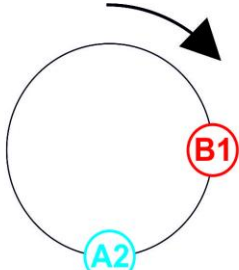

WRONG

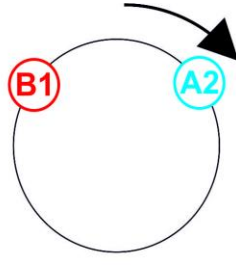

WRONG

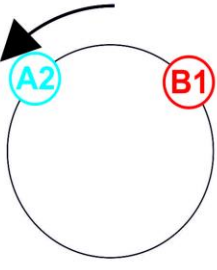

WRONG

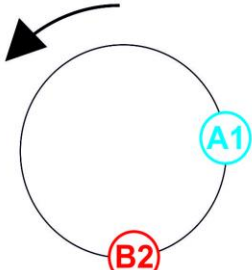

WRONG

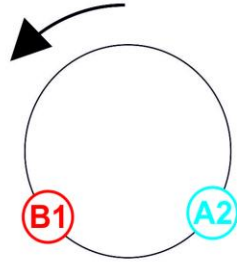

WRONG

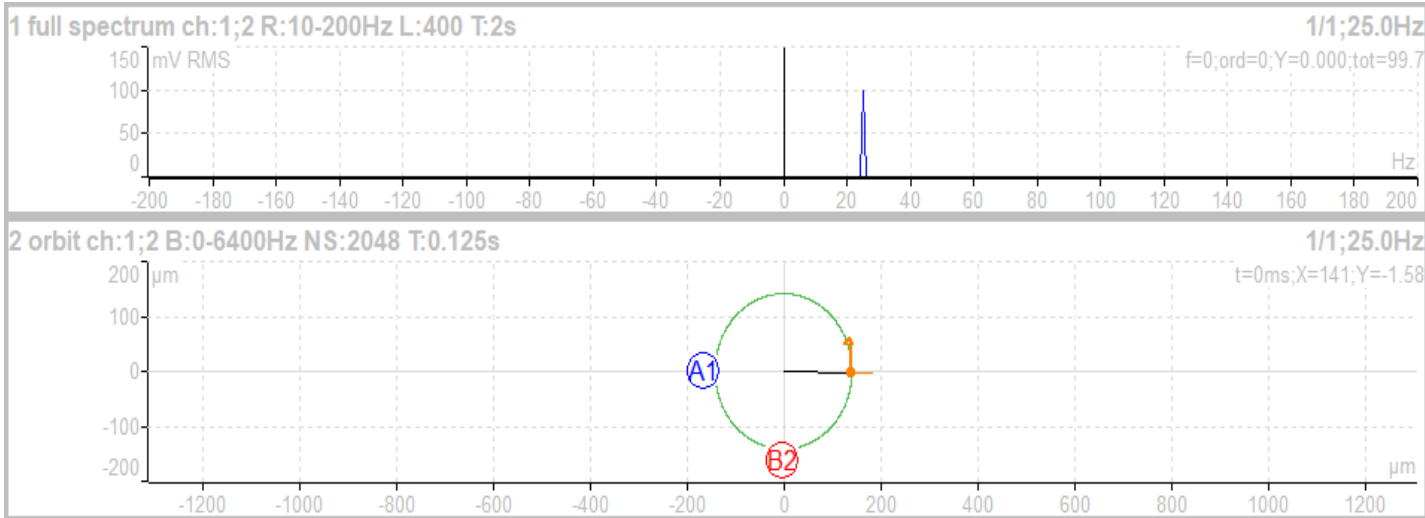

The vibration (orbit arrow) has the same direction as rotation.

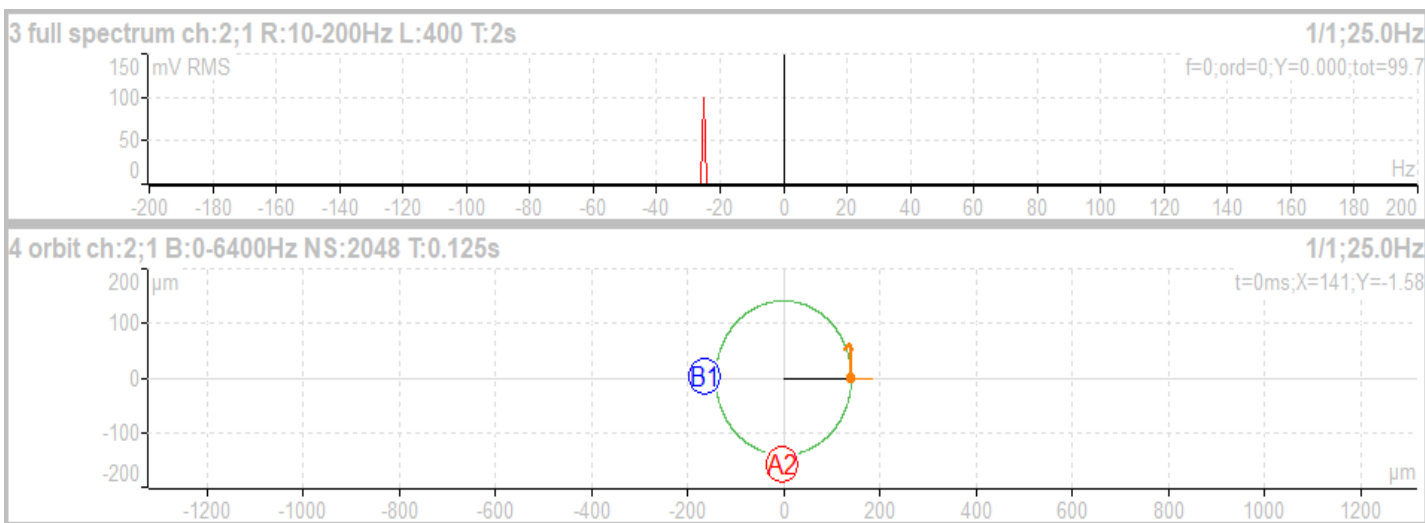

The vibration (orbit arrow) has the opposite direction as rotation.

Time

Type	time freerun, retrig
All Channels	no
Channel	1
Unit	g
Band fmin[Hz]	10
Band fmax[Hz]	1000 fs = 4096 Hz
Trigger Control	off
Samples	4096 t = 1 s
Avg	off total t = 1 s

Save

[Type](#), [All channels](#), [Channel](#), [Unit](#), [Band fmin](#), [Band fmax](#), [Trigger control](#), [Samples](#), [Avg](#)

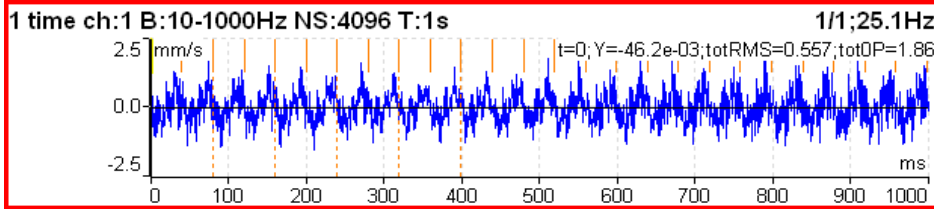

Similar parameter like for overall is used. The orange short vertical lines at the top of graph indicates the tachometer inputs. Total RMS (totRMS) and true peak (totOP) values are displayed besides the cursor value.

Time signal averaging

For averaging you need to set some [Trigger Source](#) in the [Trigger Settings](#) menu, because only triggered time signals can be averaged.

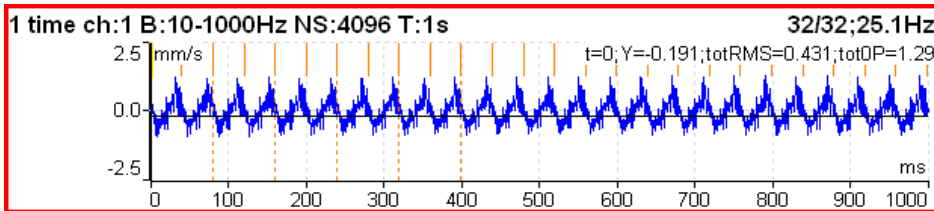

You see the effect of averaging in signal noise decrease.

Time signal with DC offset (gap)

You can measure a gap value from DC channel simultaneously with a **displacement** time signal. This gap value is added to the time signal.

How to connect a sensor

A displacement sensor must be connected to an AC and to a DC channel at the same time. You can find where all channels pins take place in an [Input Channels](#) chapter. You can order a cable with right connection from your instrument vendor.

How to setup a sensor

Open the [Sensors](#) menu and select used AC channel (the channel where the sensor is connected). Setup sensitivity and other values like usually. There is one more item for a displacement sensor, [DC gap channel](#). Its value is not defined by default. You need to enter the value of your DC channel here (this number is usually same as the AC channel). Then setup an associated DC sensor (sensitivity, unit and position must be same as in AC sensor).

Measurement

Setup and measure a time signal as usually. Time signal is modulated to a DC gap value measured from the associated DC channel.

First picture shows the signal without gap

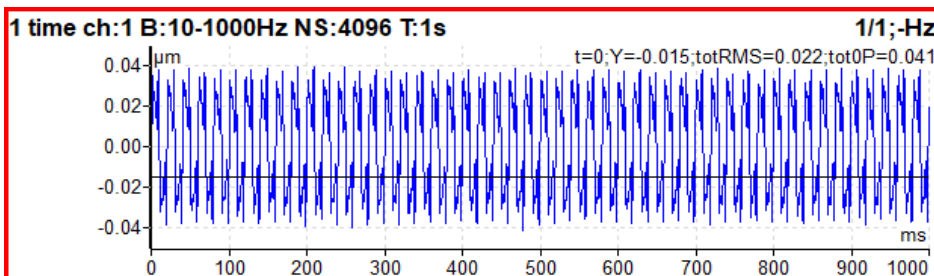

And the same signal with a gap

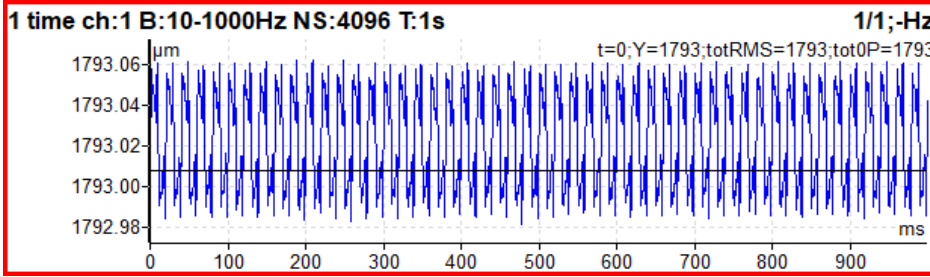

G-demod Spectrum

Type	g-demod spectrum freerun, retrig
All Channels	no
Channel	1
Window	hanning
Unit	g
DEMODO fmin[Hz]	500
DEMODO fmax[Hz]	25600 fs = 65536 Hz
Range[Hz]	800
Lines	800 t = 1 s, df = 1 Hz
Averaging	linear
Avg	8 total t = 8 s
Overlap	0%

Save

[Type](#), [All channels](#), [Channel](#), [Window](#), [Unit](#), [DEMODO fmin](#), [DEMODO fmax](#), [Range](#), [Lines](#), [Averaging](#), [Avg](#), [Overlap](#)

The signal is filtered in (DEMODO fmin, DEMODO fmax) range and demodulated then. Only the acceleration or voltage unit can be used. No integration of signal is enabled.

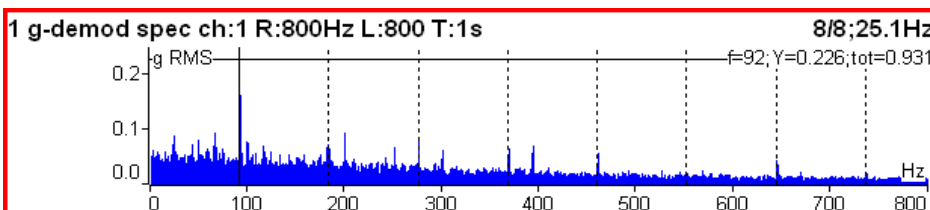

Example: the demodulated frequency 92Hz with harmonics.

G-demod Time

Type	g-demod time freerun, retrig
All Channels	no
Channel	1
Unit	g
DEMODO fmin[Hz]	500
DEMODO fmax[Hz]	25600 fs = 65536 Hz
Samples	512 t = 0.00781 s

Save

[Type](#), [All channels](#), [Channel](#), [Unit](#), [DEMODO fmin](#), [DEMODO fmax](#), [Samples](#)

This function enables to see the signal, when the standard envelope demodulation is used. The signal is filtered in (DEMODO fmin, DEMODO fmax) range and demodulated then. Only the acceleration or voltage unit can be used. No integration of signal is enabled.

G-demod Overall

Type	g-demod overall freerun, retrig
All Channels	no
Channel	1
Unit	g
Detect Type	RMS
DEMODO fmin[Hz]	500
DEMODO fmax[Hz]	25600 fs = 65536 Hz
Samples	8192 t = 0.125 s
Averaging	linear
Avg	off total t = 0.125 s

Save

[Type](#), [All channels](#), [Channel](#), [Unit](#), [Detect Type](#), [DEMODO fmin](#), [DEMODO fmax](#), [Samples](#), [Averaging](#), [Avg](#)

The signal is filtered in (DEMODO fmin, DEMODO fmax) range and demodulated then. Only the acceleration or voltage unit can be used. No integration of signal is enabled.

1 g-demod RMS ch:1 B:500-25600Hz NS:8192 T:0.125s 1/1;25.1Hz
4.32g

amp+phase

The amplitude and phase on speed frequency or its multiple (order) or on manually entered frequency.

Type	amp+phase freerun, retrigger
All Channels	no
Channel	1
Unit	mm/s
Averaging	linear
Avg	off
Frequency	speed
Order	1
Resolution	speed / 4 t = 4 revs

Save

[Type](#), [All channels](#), [Channel](#), [Unit](#), [Averaging](#), [Avg](#), [Frequency](#), [Order](#), [Resolution](#)

1 1x amp+phase ch:1	1/1;50.0Hz
10.1 mm/s RMS; -178.8°	

By default, the amp+phase is measured on speed frequency (Order = 1). However, you may define any value as the [Order](#) for the measurement. For example, if you want to measure amplitude and phase on 1/3x speed frequency, then you enter the order as 0.333333. The order value is announced in the graph's information line, the "1x" on the picture above means the order value is 1. Thus, the speed frequency is used for measurement.

Note! Remember to set appropriate resolution according to used order. See [Resolution](#) for more details.

Furthermore, you may enter any frequency using the [Frequency](#) parameter. In this case, the *order* parameter is not available. The [Resolution](#) parameter is entered as a fraction of the entered frequency. The entered frequency is announced by "f:" label in graph's information line.

1 amp+phase ch:1 f:33Hz	1/1;50.0Hz
7.18 mm/s RMS; -35.7°	

Orbit

Type	orbit freerun, retrigger
All Channels	no
A channel number	1
B channel number	2
Unit	μm
Band fmin[Hz]	none
Band fmax[Hz]	800 fs = 2048 Hz
Trigger Control	off
Samples	4096 t = 2 s
Avg	off total t = 2 s

Save

[Type](#), [All channels](#), [A channel number](#), [B channel number](#), [Unit](#), [Band fmin](#), [Band fmax](#), [Trigger control](#), [Samples](#), [Avg](#)

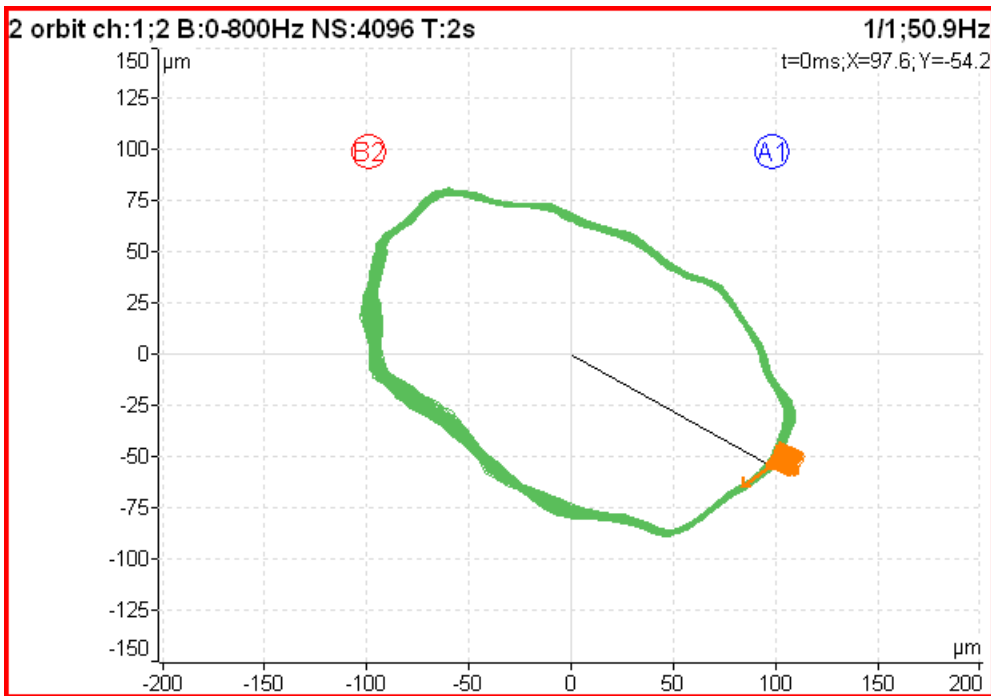

The **A1** means, that the [A channel number](#) is set to AC1 input and similarly **B2** means [B channel number](#) is set to AC2 input.

The position of A1 and B2 matches the sensor angles defined in [AC Sensors](#) / [Position](#). The knowledge of those angles enables to draw the correct shape of the orbit.

Attention! Correct SC sensors [Position](#) must be set for correct calculations.

Orbit averaging

The [Trigger Source](#) must be set to enable orbit averaging like in [Time signal averaging](#).

Orbit measurement with DC offset (gap)

An orbit contains two time signals. Each time signal could be modulated to a gap value as referred in [Time signal with DC offset \(gap\)](#) chapter. If you setup gap channels for orbit's time signals the resulting orbit will be displayed with an offset.

Filtered Orbit

Type	filtered orbit freerun, retrig
All Channels	no
A channel number	1
B channel number	2
Unit	µm
Orders	1-10
Averaging	linear
Avg	off
Save	

Type, All channels, A channel number, B channel number, Unit, Orders, Averaging, Avg

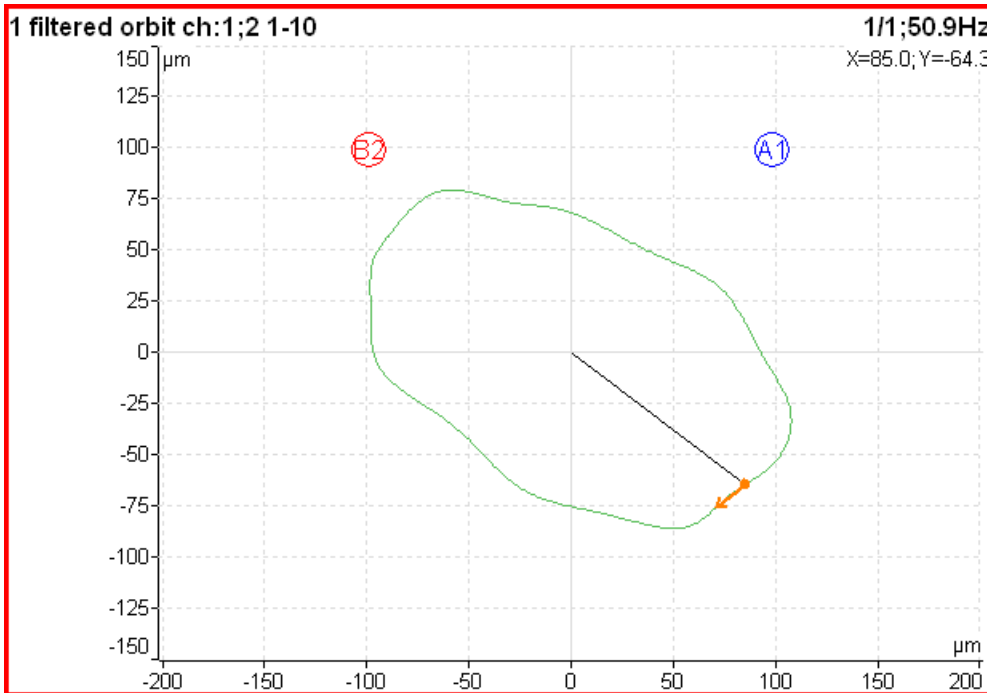

Filtered orbit is built up from two order analysis readings. Correct sensors [Position](#) (angle) must be set for correct calculations as for standard orbit graph. You can switch displayed orders on or off in the [Graph Properties](#) menu.

Speed

The machine speed (revolutions) is measured.

Type	speed freerun, retrig
Unit	Hz
Averaging	linear
Avg	off
Save	

Type, Unit, Averaging, Avg

When the tacho probe is used (connected to the TRIG input), then the impulses are generated in signal when a . In the time signal graph are marked by short lines.

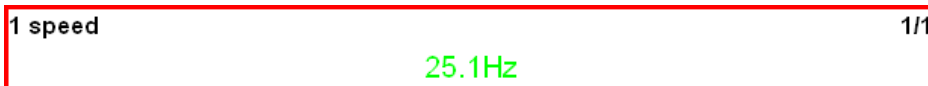
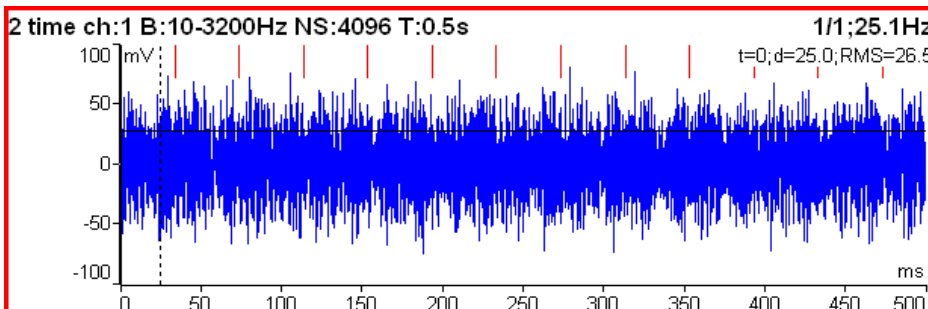

The speed measurement is taken 8 times in every second. The value is evaluated from 3 tachometer events in time signal. When the averaging is required, then more values are used. But keep in mind that only 8 values are taken in one second.

Note! The TRIG input signal is evaluated no matter if you have the speed measurement defined. If the signal contains pulses, the speed will be calculated and stored in data headers of all measurements in the set. Only if the [Trigger Source](#) is set to **external**, no speed is evaluated.

ACMT

Type	ACMT freerun, retrigger
All Channels	no
Channel	1
Unit	g
Detect Type	RMS
Band fmin[Hz]	500
ACMT FS[Hz]	1024
Samples	4096 t = 4 s

Save

[Type](#), [All channels](#), [Channel](#), [Unit](#), [Detect Type](#), [Band fmin](#), [ACMT FS](#), [Samples](#)

It enables to measure long time signals and compress them. It is used when you need high frequency range, for example 25.6kHz. The highpass filtering is used (Band fmin). The basic property of ACMT is resampling initial high frequency sampling to low [ACMT FS](#) frequency sampling.

The compressed ACMT time signal can keep the **RMS** or **TRUE PEAK** of original signal. Use the [Detect Type](#) parameter for selection. RMS value enables better trending.



The original time signal 8 sec long, which contains shocks. Signal contains 524288 samples.

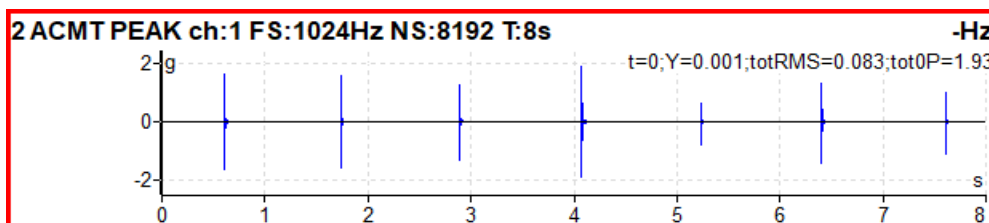

The ACMT time signal. You can see the same shocks, but signal contains only 8192 samples.

Orders

The amplitude and phase on speed frequency, harmonic frequencies and possibly subharmonic frequency.

Type	orders freerun, retrigger
All Channels	no
Channel	1
Unit	μm
Orders	1-10
Averaging	linear
Avg	off
Resolution	speed / 4 t = 4 revs

Save

[Type](#), [All channels](#), [Channel](#), [Unit](#), [Orders](#), [Averaging](#), [Avg](#), [Resolution](#)

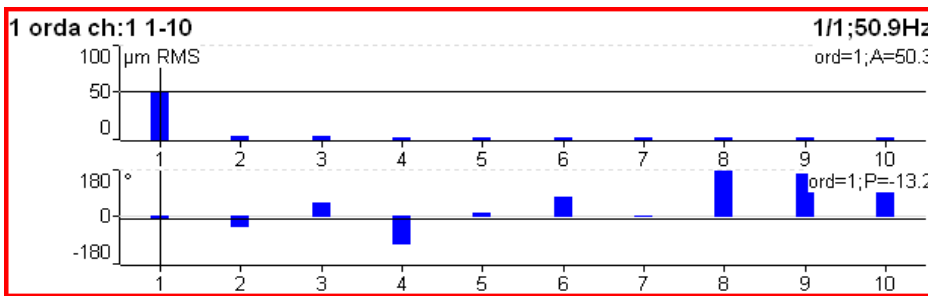

Order Spectrum (Order Tracking Analysis)

Type	order spectrum freerun, retrigger
All Channels	no
Channel	1
Window	hanning
Unit	mm/s
Band fmax[Hz]	3200 Low speed = 0,5 Hz
Lines	400
Orders	25 t = 16 revs
Averaging	linear
Avg	off
Full Spectrum	no

Save

[Type](#), [All channels](#), [Channel](#), [Window](#), [Unit](#), [Band fmax](#), [Lines](#), [Orders](#), [Averaging](#), [Avg](#), [Full spectrum](#)

The [Band fmax](#) defines the range of spectrum. All frequencies over this range will be zeroed. To define this range is necessary, when you need high number of orders. The required range is equal to number of orders multiplied by speed frequency. Be careful, higher [Band fmax](#) increases the minimum speed, which can be used. This minimum you can see below as a note "Low speed". When the speed is lower than this value, then measurement error is signed.

The number of revolutions is displayed below the number of orders (16 revs in image). Such number of revolutions is needed for one spectrum calculation. We cannot display it in time, like for spectrum. One revolution is the time quantity for order spectrum.

The 4 revolutions is the minimum number. It means that lines number must be 4 times greater than orders number as the minimum.

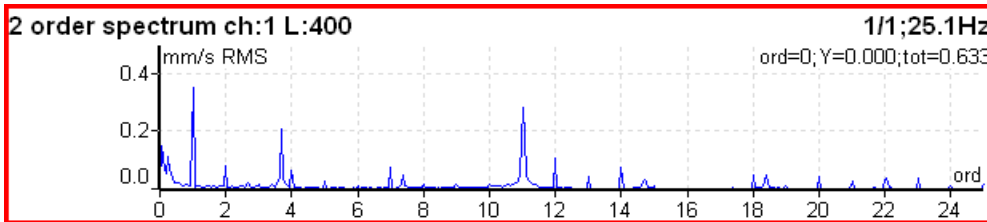

Order full spectrum

Set [Full spectrum](#) to **yes**. Remember to set correct angles of both sensors. It influences the calculation. The FFT is applied to complex signal, first channel is real part and second channel is imaginary part.

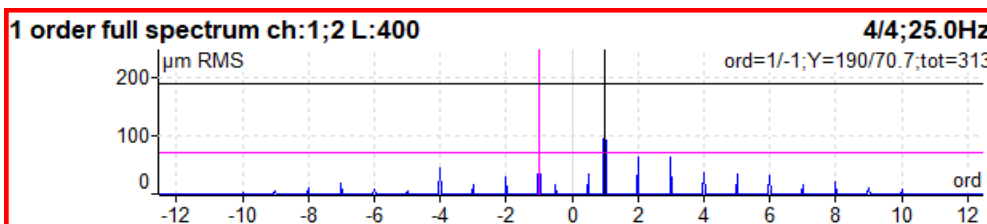

Note! Cursor is displayed on both sides. Different colors are used. Both cursor values are displayed.

Attention! The correct setting of [A channel number](#) and [B channel number](#) is critical for correct result. If this setting is wrong then the negative and positive side are interchanged. See the [Full spectrum](#) chapter for details.

Phase Shift

The measurement of phase shift between two channels, amplitude ratio and coherence on speed frequency or manually entered frequency.

Type	phase shift freerun, retrig
All Channels	no
A channel number	1
B channel number	2
Avg	8
Frequency	speed
Order	1
Resolution	speed / 4 t = 4 revs

Save

[Type](#), [All channels](#), [A channel number](#), [B channel number](#), [Avg](#), [Frequency](#), [Order](#), [Resolution](#)

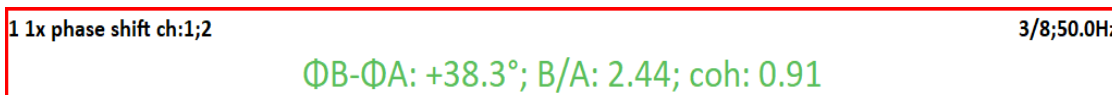

The result contains:

- phase shift value in degrees,
- amplitude ratio (ampl B/ ampl A),
- coherence

If the phase shift is reliable, then the coherence must be higher than 0.8.

By default, the phase shift is measured on speed frequency (Order = 1). However, you may define any value as the [Order](#) for the measurement. For example, if you want to measure amplitude and phase on 1/3x speed frequency, then you enter the order as 1/3. The order value is announced in the graph's information line, the "1x" on the picture above means the order value is 1. Thus, the speed frequency is used for measurement.

Furthermore, you may enter any frequency using the [Frequency](#) parameter. In this case the order parameter is not available, the [Resolution](#) parameter is entered as a fraction of the frequency and the entered frequency is announced by "f:" label in graph's information line.

1 phase shift ch:1;2 f:38Hz 1/1;50.0Hz

ΦB-ΦA: +98.3°; B/A: 0.342; coh: 0.91

DC

The direct DC signal can be measured by this function.

Type	dc freerun, retrig
Manual Entry	no
All Channels	no
Channel	1
Unit	°C
Averaging	linear
Avg	off

Save

[Type](#), [All channels](#), [Channel](#), [Unit](#), [Averaging](#), [Avg](#)

1 dc ch:1

22.6 °C

If you want to enter the value manually, then select **Manual Entry** to **yes**. All manual inputs are required before the measurement. The new window for each one appears.

Enter value [°C]
Manual Entry (Graph1)

22.6|

Frf

Frequency Response Function

Type	frf freerun, retrig
All Channels	no
Input	1
Window	transient
Shift[ms]	97.2
Length[ms]	6.35
Output	2
Window	exponential
Shift[ms]	97.7
Length[ms]	196
Result Type	H1
Range[Hz]	800 fs = 2048 Hz
Lines	1600 t = 2 s, df = 0.5 Hz
Avg	4 total t = 8 s
Overlap	0%

Save

[Type](#), [All channels](#), [Input channel](#), [Output channel](#), [Window](#), [Result Type](#), [Range](#), [Lines](#), [Avg](#), [Overlap](#)

The coherence displayed in the amplitude graph. The short horizontal line on Y axis is on position of value = 1 for coherence.

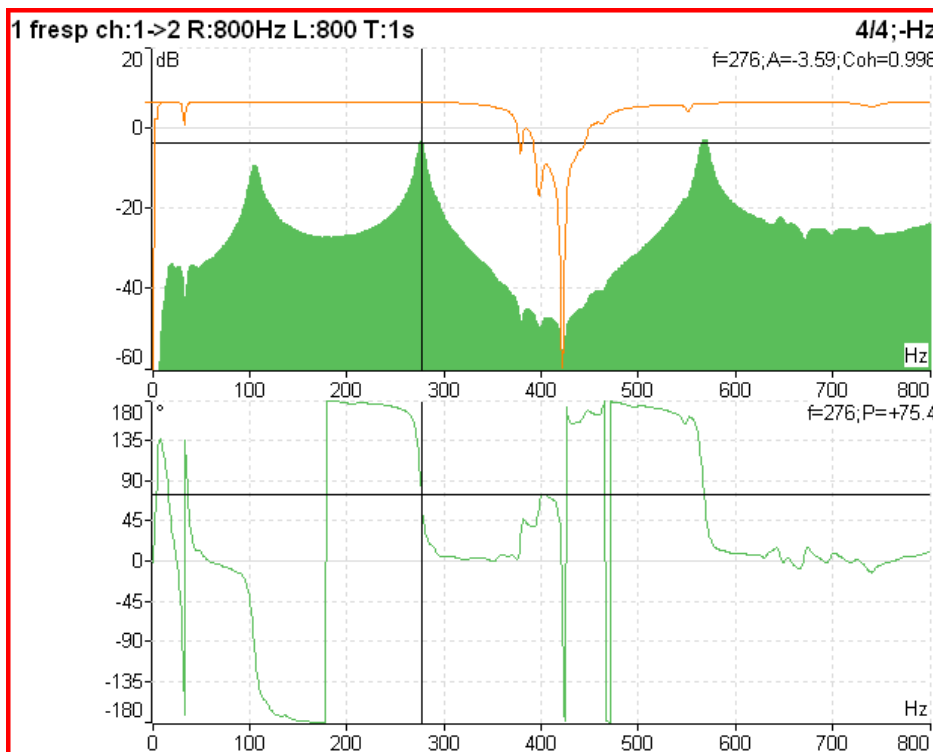

When you set the [View \(for frf\)](#) Frf view to **time**, you see the time signals from both channels.

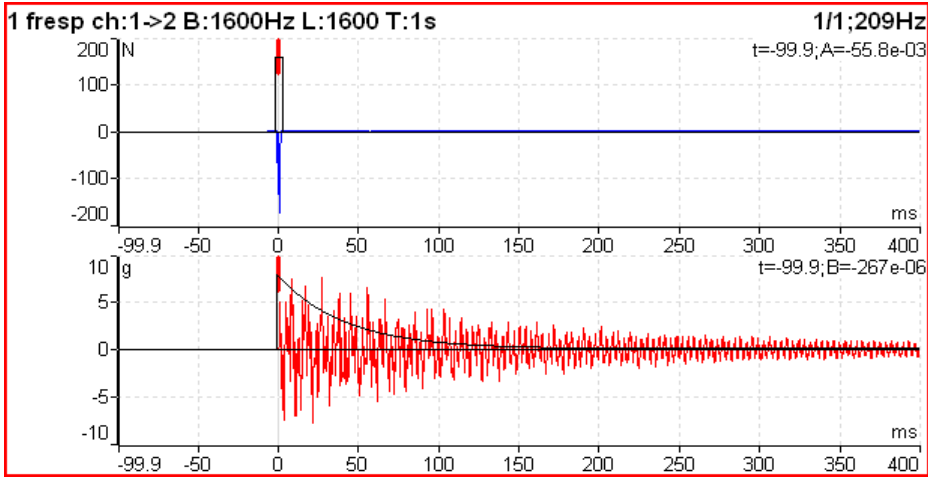

You may use this view to easily set [Window](#) parameters. Set the button mode to **Spectral widow**. Now you can simply shift the windows or change their length.

Frf Format

When a FRF is used with force units on one channel and some vibration units on another channel, you may change the units in which the frf is displayed using [Graph Properties](#) / [Frf Format](#).

Octave Spectrum, Sound Level and Equivalent Sound Level

All parameters are described in the [Octave Analysis](#) chapter. The exponential averaging is not available in the Analyzer module.

Center line

This measurement is often used for turbines. Its values define the static position of shaft in bearing. The signals from proximity sensors must be connected to DC channels. We need to remove the AC part and to hold the DC part. The DC inputs work in that way.

Type	center line freerun,single
All Channels	no
A channel number	1
B channel number	2
Unit	μm
Avg	off

Save

[Type](#), [All channels](#), [A channel number](#), [B channel number](#), [Unit](#), [Avg](#)

The *Center line* is related to the [Orbit](#) measurement. While in *orbit* we see the shape around the (0,0) position, in the *center line*, we see the position of shaft center without shape of orbit.

Attention! Correct DC sensors [Position](#) must be set for correct calculations.

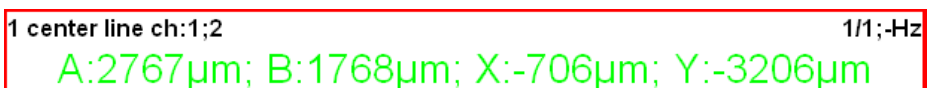

Two couples of values are displayed, A+B and X+Y. The A, B values represent distances of sensors from the reference position defined by offset value. The X, Y values represent that positions according the Cartesian X, Y coordinates (The position (0,0) correspond the position, where A,B are equal their offsets). The polar graph is displayed for trend.

Smax

It is the measurement of the maximum deflection on an [Orbit](#). Correct sensors [position](#) must be set for correct calculations as for standard orbits.

Type	Smax freerun, retrig
All Channels	no
A channel number	1
B channel number	2
Unit	μm
Band fmin[Hz]	none
Band fmax[Hz]	800 fs = 2048 Hz
Trigger Control	off
Samples	512 t = 0.25 s
Averaging	linear
Avg	4 total t = 1 s

Save

[Type](#), [All channels](#), [A channel number](#), [B channel number](#), [Unit](#), [Band fmin](#), [Band fmax](#), [Trigger control](#), [Samples](#), [Averaging](#), [Avg](#)



In the next picture, you can see the Smax value highlighted on the orbit.

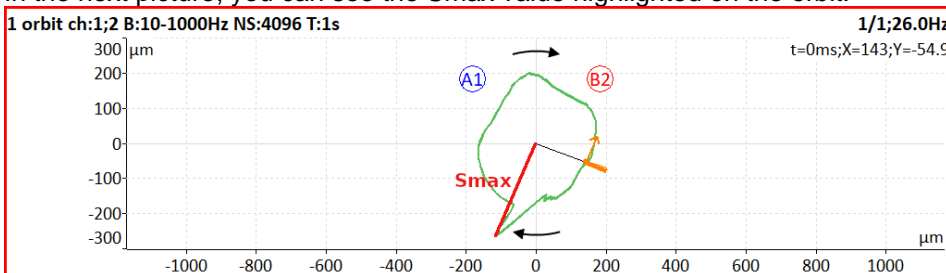

Complex Smax

It is the measurement of the maximum deflection on an [Orbit](#) together with an angle (ie. position) of this deflection. In other words, it is a Smax measurement with the position of maximum deflection. Correct sensors [position](#) must be set for correct calculations as for standard orbits.

Type	complex Smax freerun, single
A channel number	1
B channel number	2
Unit	μm
Band fmin[Hz]	1
Band fmax[Hz]	800 fs = 2048 Hz
Trigger Control	off
Samples	512 t = 0.25 s
Averaging	linear
Avg	off total t = 0.25 s

Save

[Type](#), [All channels](#), [A channel number](#), [B channel number](#), [Unit](#), [Band fmin](#), [Band fmax](#), [Trigger control](#), [Samples](#), [Averaging](#), [Avg](#)

1 complex Smax ch:1;2 B:10-1000Hz NS:4096 T:1s 1/1;25.8Hz
288 μm ; -156.2°

In the next picture, you can see the Smax value and its position highlighted on the orbit.

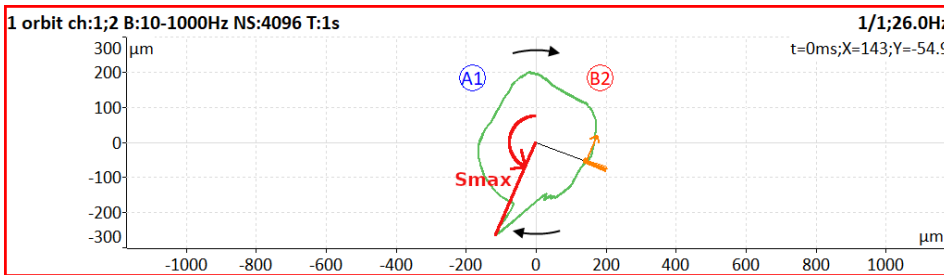

Note! The angle of the maximum displacement can be sometimes accidental. Let's consider a perfect circle shape orbit as an example below. The Smax angle in this case is a random number, and when averaging such Smax, the angle is undefined.

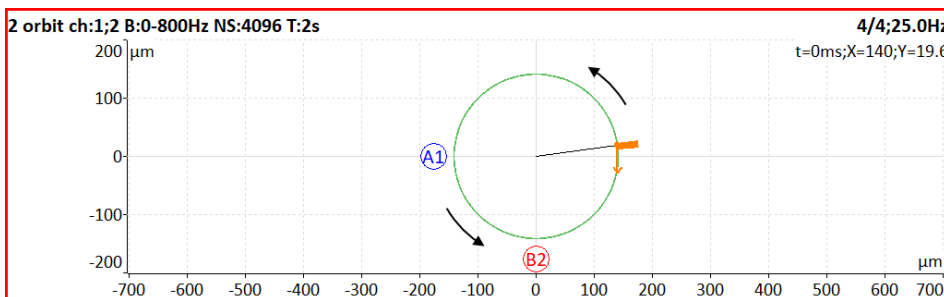

Type	cepstrum freerun, retrig
All Channels	no
Channel	1
Window	hanning
Unit	g
Band fmin[Hz]	10
Range[Hz]	800 fs = 2048 Hz
Lines	400 t = 0.5 s, df = 2 Hz
Avg	off total t = 0.5 s
Overlap	0%

Save

[Type](#), [All channels](#), [Channel](#), [Window](#), [Unit](#), [Band fmin](#), [Range](#), [Lines](#), [Avg](#), [Overlap](#)

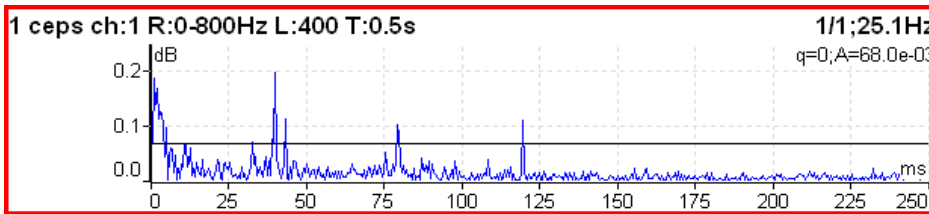

Used algorithm is:

$$\text{cepstrum}(x) = \text{ifft}(\text{fft}(\log_{10}(\text{abs}(\text{fft}(x))))))$$
 x input signal
 fft fast fourier transform
 abs absolute value
 log10 common logarithm
 ifft inverse fast fourier transform

Ultrasound

Type	ultrasound freerun, retrig
------	-------------------------------

Save

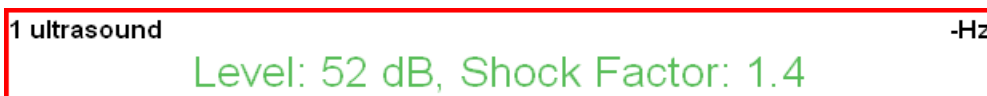

Two values are displayed. The **Level** of sound in dB (30-50kHz range) and **Shock Factor**. The **Shock factor** is defined as Peak value divide by RMS value. It means value 1.4 for pure sine. Higher values mean that transient shock events are in the sound signal.

Attention! The ultrasound sensor (microphone) required.

There is detailed description in the [Ultrasound](#) chapter.

Type	record
	freerun, retrig
Sampling Frequency[Hz]	65536
	Frequency Range=25600Hz
AC1	on
AC2	off
AC3	off
AC4	off
DC1	off
DC2	off
DC3	off
DC4	off
Trigger Channel	off
Time[minutes]	manually stopped
Start of Rec	freerun
	Save

1 record
00:00:25 / 00:01:00

Creates and saves the record during measurement. There is detailed description in the [Recorder](#) chapter.

Route

Loading of the route to the instrument

The cooperation with DDS software is required for the route measurement. The complete description how to create and load a route is in DDS manual. We do not describe all details about DDS function in here.

You can see that the structure of tree is changed when you create a route from a part of tree in DDS. This is because the VA5 instrument strictly requires the tree with the following structure *Route - Machine - Measuring Point - Measurement*. If there are more items in DDS tree in a path between these items, the names of such items are combined together (like in this example *Turbo Generator/Fans/Fan 1* or *Motor/L1RV* etc.). If the item name in a route tree is longer than 45 characters DDS is trying to truncate such names. To avoid this we recommend using shortcuts in tree items (in this case "Turbo Generator" should be "TG").

Creation of the route tree in the instrument

The route tree can be created also in the instrument. When you want to transfer this route to DDS you must prepare a database for it.

Route Tree

Routes are similar to *L1 Projects* in the [Analyzer](#) module. After opening the module, import of routes from *VA5_DISC* is done. Then, a **Route List** of all routes in instrument is displayed. The date and time of last modification of selected item is displayed in top right corner.

Note! Routes that are only modified on internal disk and have not yet been exported to [VA5_DISC](#) are marked with a cross symbol (X).

Route List		13.04.2023 09:49:28
Engines	X	
▶ TG Fans		

Select one route and push *Enter* or tap twice. A route tree is loaded and a **Machine List** of machines in the opened route is displayed.

TG Fans	
Machine List	
▶ Fan1	
Fan2	

An opened route's name is displayed in status bar by bold font. A list type is below the name, this indicates an actual tree level.

Walking through the tree is straightforward. Use up and down arrows to select an item. *Enter*, right arrow or double tap opens an item and its members are displayed in a new list. *Escape* or left arrow returns you one level higher. If a *Machine List* is opened *Escape* closes the route.

Open any machine. A **Point List** is displayed.

TG Fans/Fan1		
Point List		
▶ Motor/B1RV	1ch	ISO RMS L: 2.20 mm/s R: 2.00 mm/s
Motor/B1RH	1ch	BEARING RMS L: 0.849 g R: 1.00 g
Motor/B2RV	1ch	
Motor/B2RH	1ch	
Triax	3ch	

An item's complete path is displayed in status bar by bold font. Long names could be shortened.

The number of AC channels for each point is displayed behind the point name.

When no data has been taken yet, the *Last (L)* and *reference (R)* values of overall measurements within the selected point may be displayed next to the point list. These values are initially taken from the database and are stored together with the route. The last value is always changed when data is saved, while the reference value remains unchanged.

After taking a measurement, the measured values of overall measurements are displayed together with their difference in percent from the previous (L) and reference (R) values.

TG Fans/Fan1		
Point List		
▶ ✓ Motor/B1RV	1ch	ISO RMS 2.14 mm/s [L-3%, R+7%]
Motor/B1RH	1ch	BEARING RMS 0.912 g [L+8%, R-9%]
Motor/B2RV	1ch	
Motor/B2RH	1ch	
Triax	3ch	

You may start a measurement process of the selected point by pressing *Enter*. However, in the Route module, you may walk the tree down to a particular measurement level. Thus, you may work with any single measurement independently, e.g., you may measure only one measurement in the point. Open any point by pushing right button or double tap. In the **Meas List**, an index of a channel is before a name.

TG Fans/Fan1/Motor/B1RV		
Meas List		
▶ 1.ISO RMS		ISO RMS L: 2.20 mm/s R: 2.00 mm/s
1.BEARING RMS		
1.ISO TIME		
1.ISO SPECTRUM		

If *Point List* or *Meas List* are displayed, the *Enter* button starts measuring process on selected item. If you want to open graphs window and you don't want to start the measurement immediately, use a **Point (or Meas) / View Actual** menu item. A **Point (or Meas) / View Trends** opens trends of the selected item.

Sensors Check

Each point in the route contains the sensor setting, which is defined in DDS. The instrument contains also the sensors setting. Both settings are compared for each point while opening graphs window. When the sensors settings are not equal then the "**Used sensor**" message appears.

Used Sensor
on AC1: 100 mV / g, ICP on

Connect the requested sensor and confirm the message. Sensors setting will be automatically stored in the instrument and you don't need to set it. In case the "Used Sensor" message appears, measurement will not be started automatically. If you need to change any parameter you can do it in the [Sensors](#) menu.

There is a different approach for sensors with a [Name](#) defined. If one of the compared sensors has name defined, then only names are compared. If names are same, the sensors are supposed to be equal regardless of other parameters' setup and no parameters are redefined in the instrument. E.g., you may use it to setup different sensitivity of a sensor. In case the names differ, a "Used Sensors" message will appear with the sensor's name.

Used Sensor
ACC100 on AC1: 100 mV / g, ICP on

When you first open a point in Route module the "Used Sensor" message appears even if the sensors are same just to inform you which sensor you have actually defined.

You can turn the sensors check off and on again in [Global Settings](#) / [Check Route Sensors](#).

Measurement process

Push *Enter* button to begin the measurement process. All defined measurements will be taken together. The measured data are or are not displayed on the screen regarding the [Display Route Values](#) parameter in the [Global Settings](#) menu.

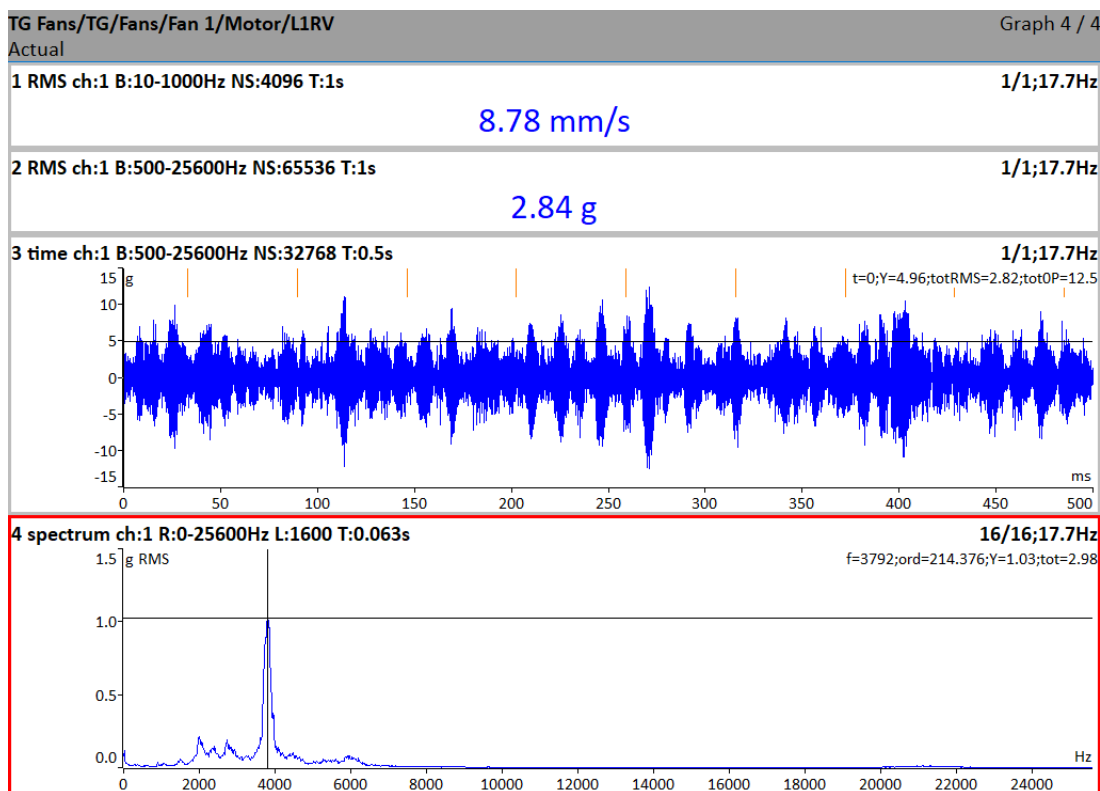

All values are automatically saved unless you defined the [Route Autosave](#) parameter in the [Global Settings](#) menu to **off**.

If the [Route Auto Forward](#) parameter in the [Global Settings](#) menu is set to **on**, then the graphs window will be automatically closed after all data are saved. Otherwise, use the *Escape* to return back to a list. The measured point is labeled by the symbol ✓ (all defined measurement were taken). The next point in the list will be selected if all measurements are correctly taken.

TG Fans/TG/Fans/Fan 1	
Point List	
✓ Motor/L1RV	1ch
▶ Motor/L1RH	1ch
Motor/L2RV	1ch
Motor/L2RH	1ch
Triax	3ch

Route Meas Mode

In DDS, measurement point properties / Other tab, you may set a Route Meas Mode property. If **Single** is set, only one reading is taken and the measurement process is stopped. If **Retrig** is set, the measurement process runs until user presses Stop button. No values are saved during the measurement. For both these modes, it depends on the [Global Settings](#) / [Route Autosave](#), whether the reading after finishing the measurement is saved or not. If **Continual Saving** is set, the measurement process also runs until user presses Stop button. Moreover, all readings are saved regardless [Route Autosave](#) parameter is set or not. It is designed for short series of measured value. For example, you want to measure one elevator run or one run of press machine. See more details in *DDS manual*.

Trend without continual saving:

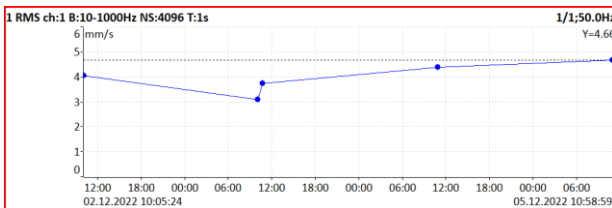

Trend using continual saving:

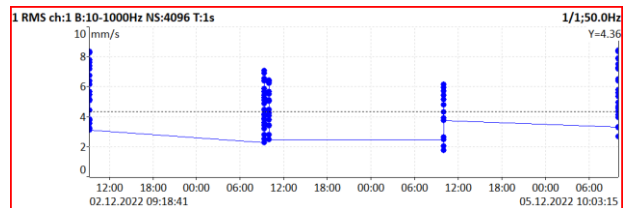

In case of Continual Saving, the *Measuring* indicator in status bar changes into *Continual Saving* and contains additional information, the number of saved readings (15) and the free memory size (30.2GB).

Graph 1 / 1
Continual Saving;RT;15;30.2GB

Route Status

All items in the route tree (points, machines or even whole routes) can be marked by a status symbol.

- ✓ - all measurements of the route tree item were correctly taken.
- ! - error during measurement process.
- - only some measurements of the route item were taken

TG Fans/TG/Fans/Fan 1	
Point List	
✓ Motor/L1RV	1ch
! Motor/L1RH	1ch
· Motor/L2RV	1ch
· Motor/L2RH	1ch
▶ Triax	3ch

Note! The symbol can be cleared using **Route / Clear Checks**. This action does not erase any data. It can be useful when you want to take the route again without transferring data into the database yet.

Last and reference values

The last measured and reference values can be downloaded from a database inside a route. In DDS, you'll be asked whether to store reference values during route creation. Last values are stored automatically by default (this can be turned off). See a DDS manual for more details.

For overall measurement, the last (L) and reference (R) values are displayed on the left side of a graph. The reference value is also displayed like a line in a trend view.

The differences in percent from the previous (L) and reference (R) values are displayed behind the measured value.

The last value is always changed when data is saved, while the reference value remains unchanged.

1 RMS ch:1 B:10-1000Hz FS:4096Hz NS:4096 T:1s 1/1;50.0Hz

L: 2.20 mm/s
R: 2.00 mm/s

2.14 mm/s [L-3%, R+7%]

Reference spectrum is displayed together with measured spectrum in the same graph.

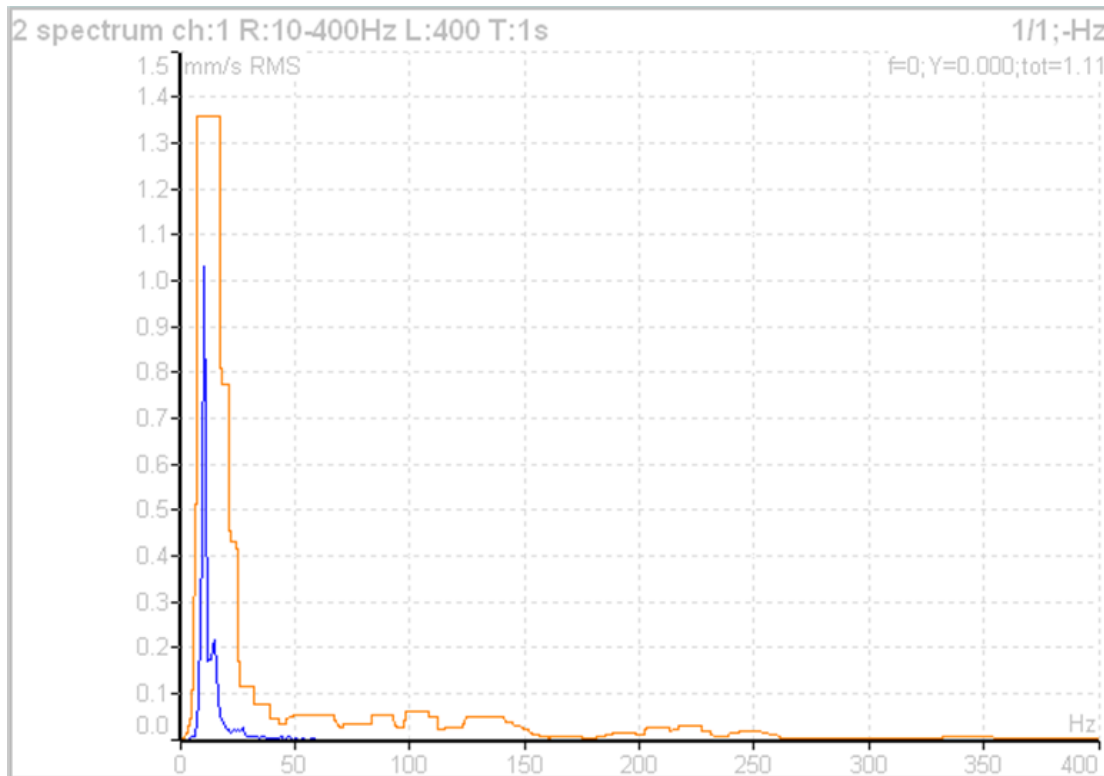

Manual Entry

The route may contain the measurements, which have to be entered manually (for example temperatures read from analogue display). These measurements are defined by a **Manual Entry** choice in DDS. An entry dialog is displayed for all manual entries during measurement process initialization. These values are saved together with the measured values.

Enter value [°C]
Temp1 (Graph1)

Notes

You can attach the short text notes to tree item in the route. The same is available in the Analyzer and Runup modules.

Push the left menu button (named as *Route*, *Machine* or *Point*, depending which level is currently displayed). Select the **Notes** item. The list of existing notes for selected item appears. It is empty when no note has been created yet.

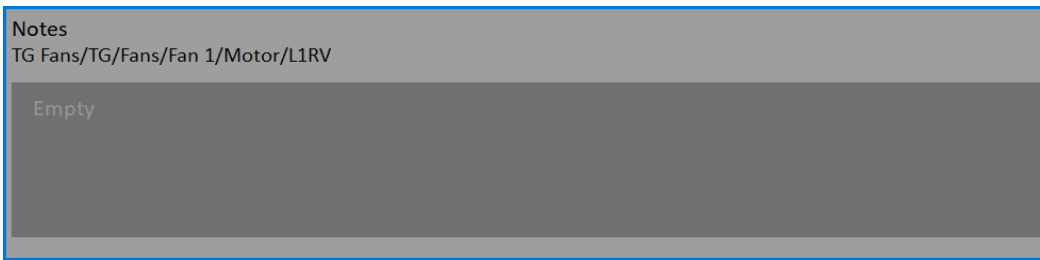

Push **Add** button to create a new note. New window appears. In the upper half area you can directly type the note. The User notes list is displayed in the bottom. The several ways how to create new note exist.

- Select one note from User notes list and press **Select**. Selected note is copied to the upper area.
- Push **User/Factory** button to change the User notes to Factory notes or back. Then choose the note from the list and press **Select**.

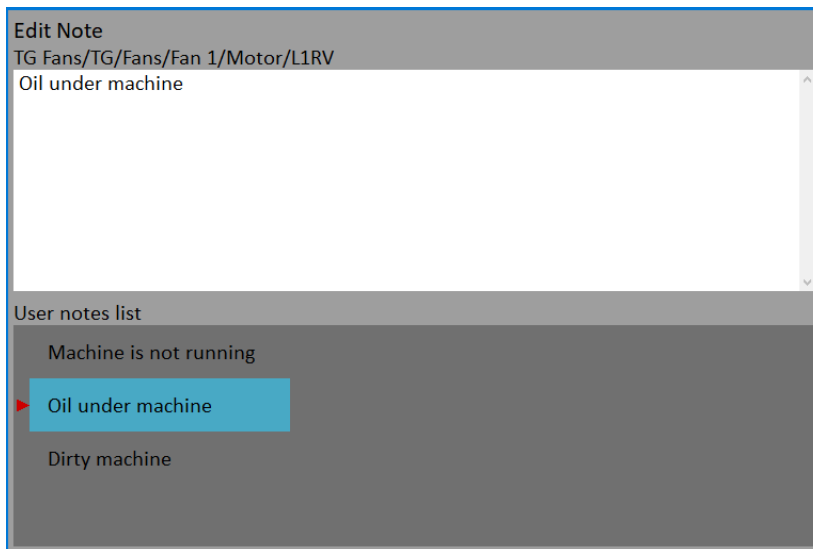

- If you want to enter your own text, then press **Edit Text** button. The cursor appears in upper area and you can enter the required note. Push *Escape* to return back to the selection of User/Factory note.

If the note is done, press the *Escape* button. You return back to the list of all notes for selected point.

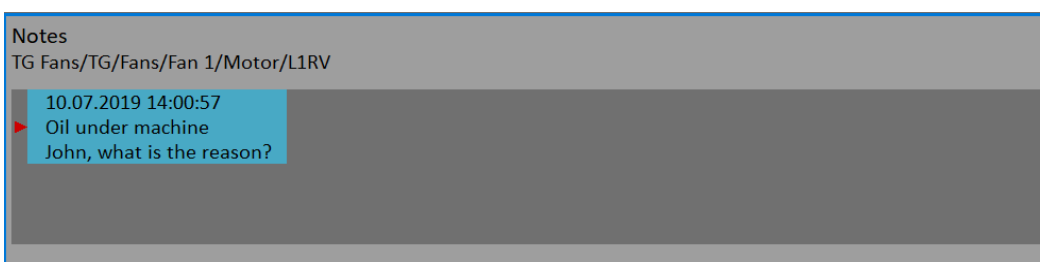

You can also edit any defined note. Press the *Enter* or **Edit** button when the Notes list is opened. The selected note opens for editing.

To delete the selected note press the **Delete** button.

Push *Escape* to leave the list of notes. The **N** letter appears behind the point name in the list.

Attention! The notes created at a measurement point (or set) after performing a measurements at a point are automatically included into csv header during export to csv (see [Analyzer](#) / [Meas Menu](#) / [Export to csv](#)).

Speed in the Route

There are various ways how to get the speed and transfer it to DDS. The ways are described here in the order from the lowest priority to the highest priority.

Entered Speed

You can manually enter a speed value which is then used instead of tacho measurement.

Push the left menu button (named as *Route*, *Machine* or *Point*, depending which level is currently displayed). Select the **Enter Speed** item. A dialog will open. Enter the value and confirm.

Enter the speed [Hz]

Warning! If tacho sensor is used then tacho speed has priority.

The entered speed value will be saved to all next readings. It is saved to the same position in the data head as the speed measured by tacho. If the speed is manually entered and also measured by tacho, then the tacho has priority and it is saved.

The manually entered speed is displayed on the right side at the top of the screen with the word "Speed:"

Speed: 50 Hz

The *entered speed* can be canceled using **Cancel Speed** item in the same menu. The *entered speed* is automatically closed when closing a machine.

Speed entered in DDS

The **Default Speed** can be set in DDS as a machine parameter. This value is sent to the instrument and it is used in place of tacho probe value. The three options of *Default Speed* are available for the machine item.

- **Entered value**
the value is sent to the instrument. The value is used only for FASIT measurement. If the value is entered, then no speed detection is used.
- **Detected**
option runs speed detection before measurement (see the [Speed detection](#) chapter).
- **Manually Entered**
opens "**Enter the speed**" dialog, where you enter the value, before measurement process

Current entered or detected speed value (if defined) is displayed in information panel at the right (if the measurement is not in progress).

Speed: 50 Hz

Note! Detected or manually entered speed is valid for whole machine. Unless you close the machine item, the same speed value is used.

Note! The *Default Speed* can be also set in other items, not only in the machine. In this case only numerical value is available. If you enter default speed value and in the same time you have set machine's default speed as **Detected** or **Manually Entered**, then the machine's setup has priority.

Measured Speed

If the speed is measured by tacho probe, it is saved always with data regardless the fact there were already defined by one of the previous ways.

Limits

In DDS, you can define limit values and alarm colors (see the DDS manual to find out how to do it). For static data cells, these limits are transferred into the instrument together with the route. Exceeding the limit values is signaled during the measurement and also in trends.

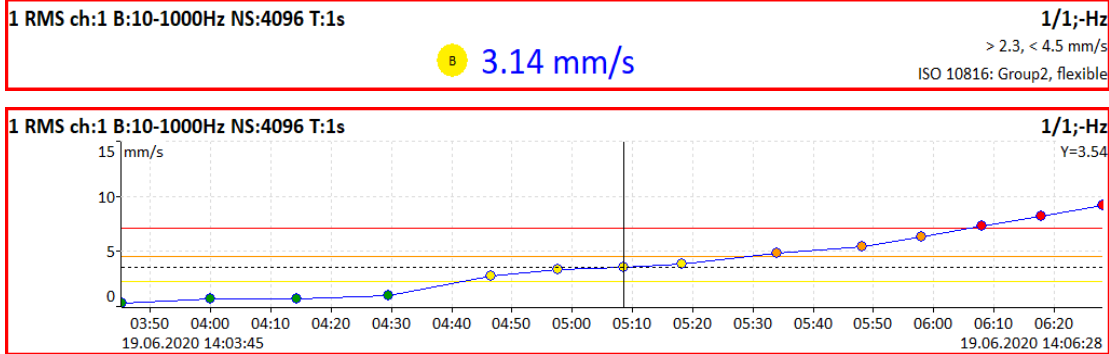

Export to VA5_DISC

The computer can read any data from *VA5_DISC* only. The route with measured data has to be exported to this memory before the transfer. During the route measurement all data are saved to the VA5 hard disk only. When the route is closed the VA5 asks the user "**Export to VA5_DISC?**" and user selects one option. The export to VA5_DISC is not done automatically because the writing procedure to flash is slow. The large route export can take several minutes. That is why the user can determine, when the right moment to export the route is. In the menu item **Route / Export** you can select the route and export it manually. Furthermore, there is an option [MENU / RUN / Export All](#) which exports all unexported projects from all modules.

Runup

When you need to measure Run Up or Coast Down of the machines, then you should use the Runup module. It enables the same measurements as the Analyzer module, but controlled continual saving of values.

What does it mean "controlled"? In Analyzer mode you can measure the set and then you have to save measurements manually. The Runup is different. The values are automatically saved during the measurement process.

You may control the number of saved values by several ways. The setup can be done in [Trigger Settings / Runup Trigger Mode](#). Usually the **speed** is used for that control and new measurement is made, when the speed changes from previous measurement of defined value (for example 10 RPM). Also the **time** can be used to control that procedure. Then you can take the measurement in defined time interval (for example each 60 sec). The **asap** is the next choice. It means no delay between measurements - **as soon as possible**. Be careful for such mode. You can fill the instrument's memory quickly.

The last choice is the **manual** mode.

In the Runup module, there are a number of readings and a free memory space displayed in the status bar besides common informations.

Runup Measurement

The meaning of the *set* and also the meaning of other terms is the same as in the Analyzer module.

We show the runup measurement on an easy example. For example we define only one measurement in the set. The proximity sensor on channel 1 is used. The sensor must be defined in the [Sensors](#) menu. The [Runup Trigger Mode](#) is set to **speed** and the value is **1Hz**. The measurement is defined like in the picture.

Edit Measurement	
Type	1x amp+phase freerun,time
All Channels	no
Channel	1
Unit	µm
Averaging	linear
Avg	off
Resolution	speed / 4
Save	

Push the *Enter* button to start a measurement process.

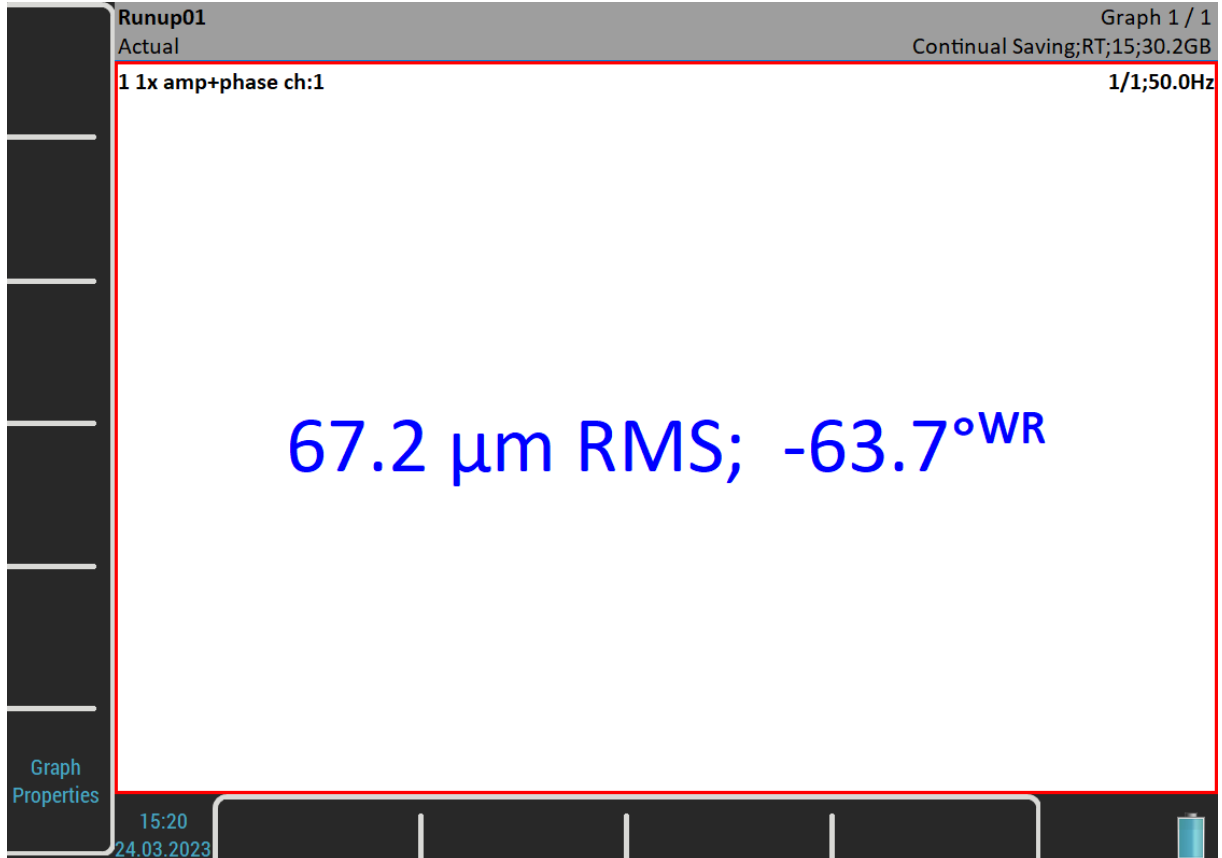

The *Measuring* indicator in status bar changes into *Continual Saving* during the runup measurement and contains additional information, the number of saved readings (15) and the free memory size (30.2GB).

The set screen looks same as in the Analyzer module. But there is one difference. The values are saved during the measurement.

The actual value is displayed on the picture above. Nevertheless, in the Runup module, you may display a trend during the measurement process already. Use the [Graph Properties](#) / [Display](#) for it.

Push the *Escape* button when you want to stop the measurement process.

Trends

In the Runup module, unlike the Analyzer module, one trend is saved during each measurement process. Push the **Set** button and select the **View Trend** item to open a **Trend List**. The date and time of trends are displayed in the list. If the analysis was made from record, then two time stamps are displayed. The analysis time is the first and the record time is the second.

One runup measurement can be divided into more files (into more trends), for example, if the measurement is too long. See [MENU / SETTINGS / Runup](#).

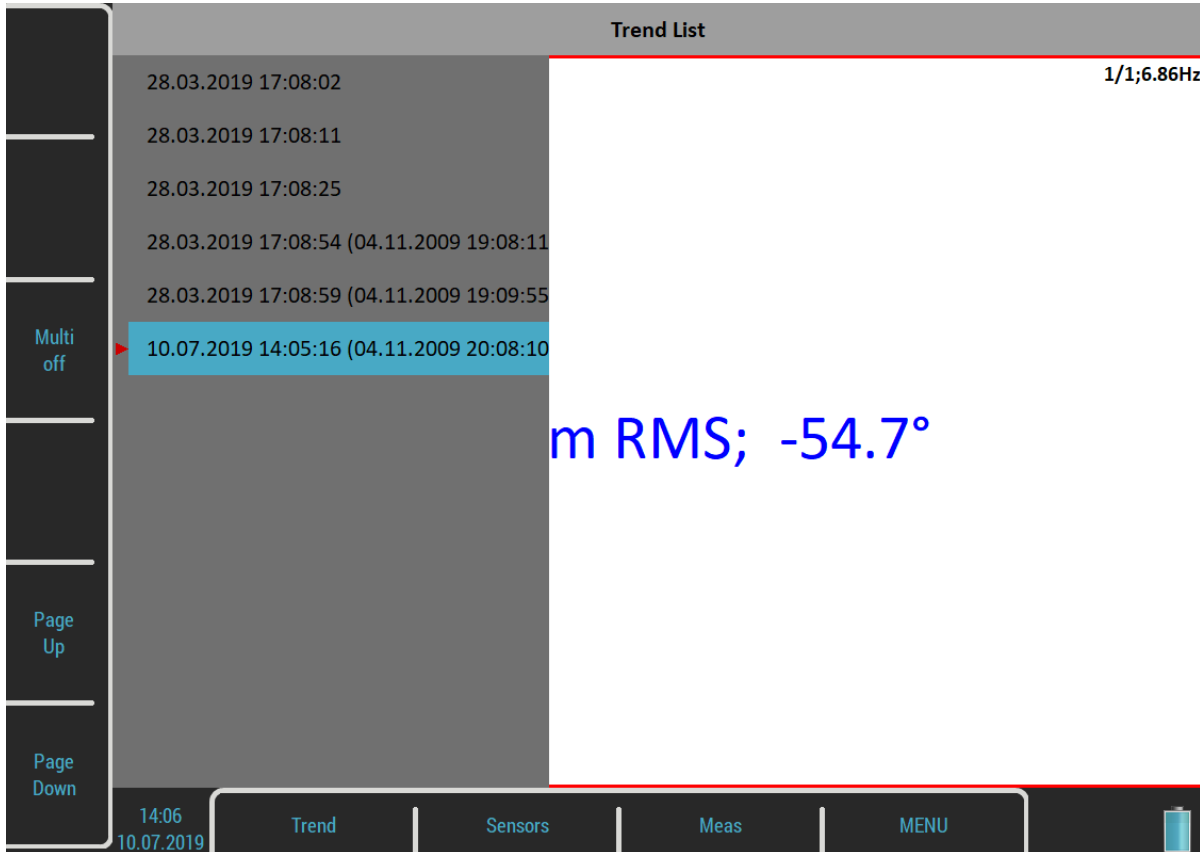

Select one item in the list and open it. The selected trend will be loaded and displayed.

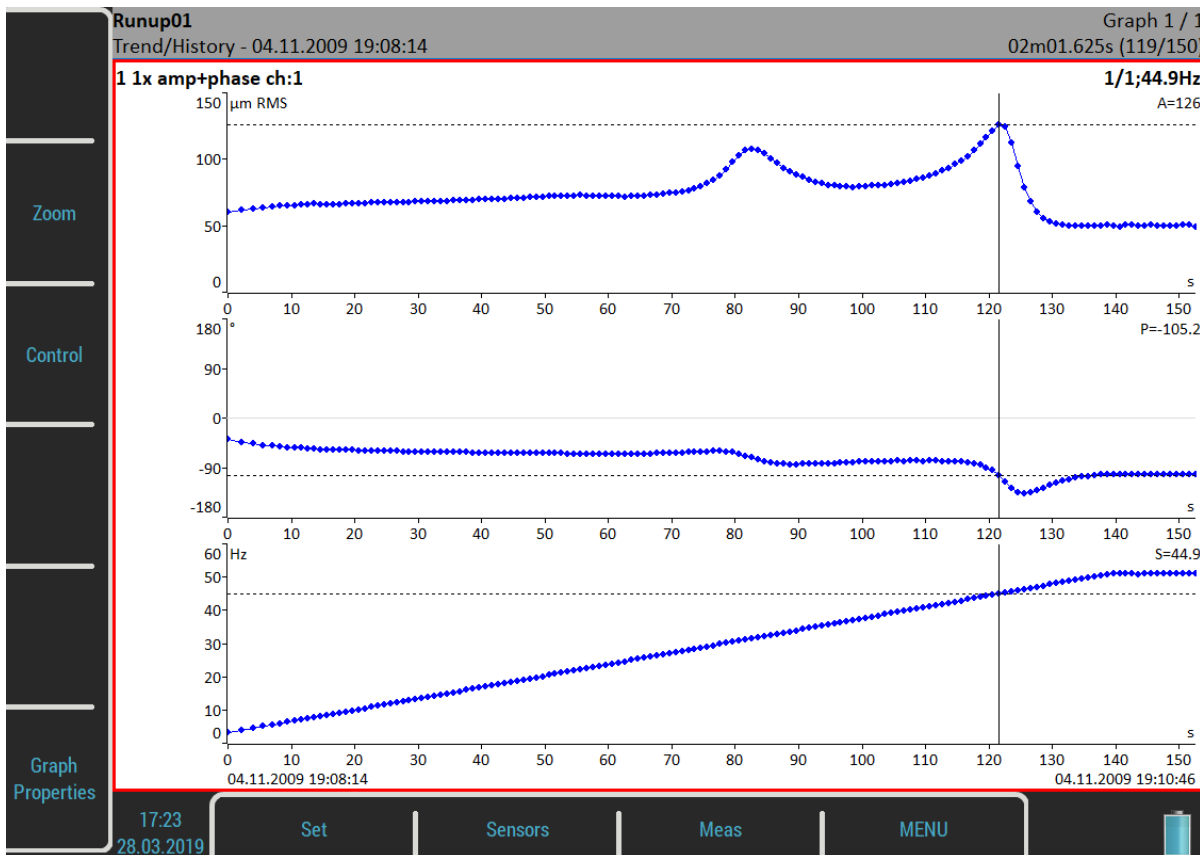

The date and time after the *Trend/History* indicator in the status bar means the beginning of the measurement. The time stamp in the bottom right corner of the status bar means the actual *trend cursor* position and the

119/150 means the index and the total number of readings in the trend. The trend axe is marked relatively from the beginning. This is the default setup. If you want absolute date and time change the [Trend Time Axe](#) parameter in the [MENU / SETTINGS / Runup](#) to a **real time** value.

Trend Menu

When the *trend list* is displayed, then a menu to work with trend list items is available. Push the ***Trend*** button to open the menu.

Delete

Delete selected trends.

Export

It is not necessary to export the whole set with all trends but you can export only the trends you need. You find them in the folder named as the current project (set) in the *VA4runup* folder on the *VA5_DISC*. Then you are able to work with them same way like you would export the whole project (for example import to DDS or copy to virtual unit). The project is particularly exported.

Recorder

Many of older engineers remember the past time, when the signal was recorded to the tape-recorder and consequently analyzed in Analyzer. Such approach had one important benefit. You can analyze the signal again and again. When you need to make all required analysis in real-time, you are under time pressure. If additionally the for example runup can be run only once, the pressure is extreme. The tape-recorder was the solution. It was simple unit with simple operation, no danger to loose the data. The same solution offers the Recorder module. It enables to record simultaneously all four AC and DC inputs and TRIG input into the memory.

Project List

For management purposes, **records** are referred as **projects**. The list of saved projects opens when you enter the Recorder module. The list is empty if you have no saved records yet. The recording date and time of the selected project is displayed in the status bar in the bottom right corner.

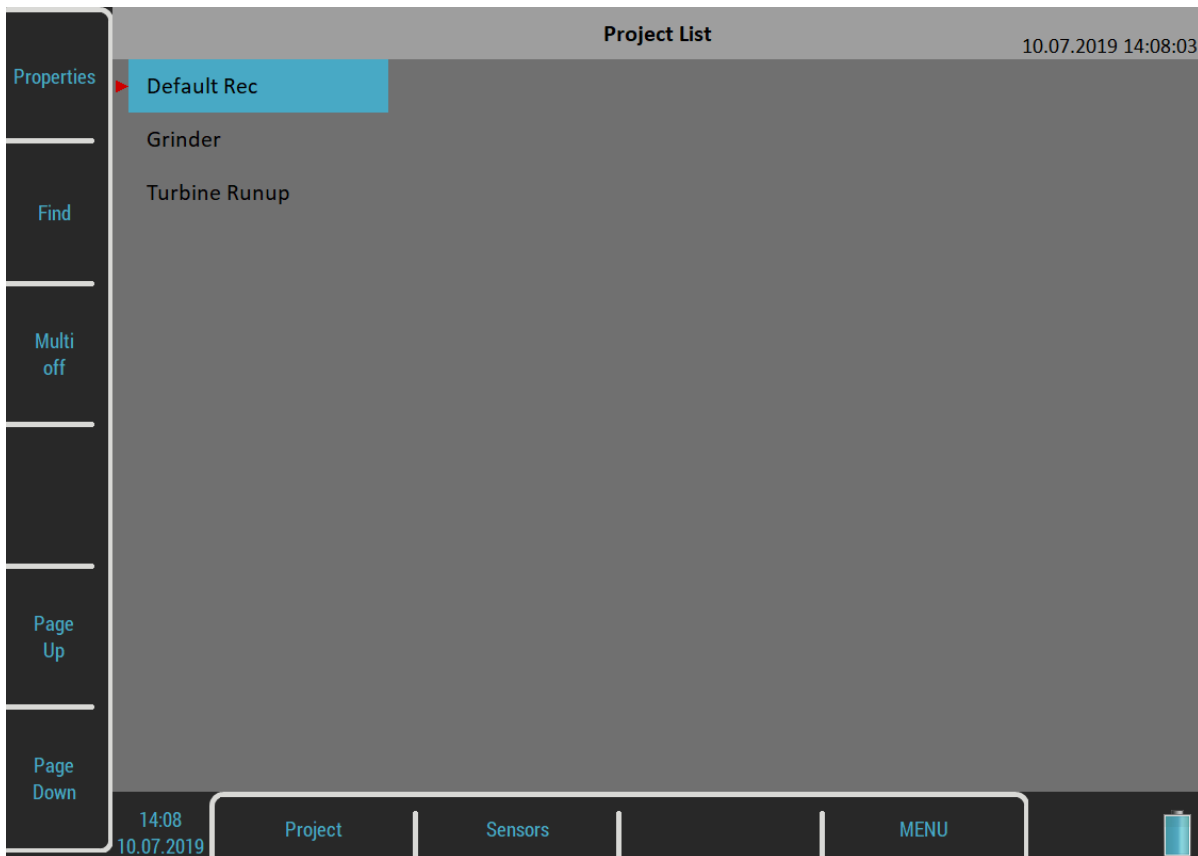

Project Menu

Use the **Project** button to manage the records in the list.

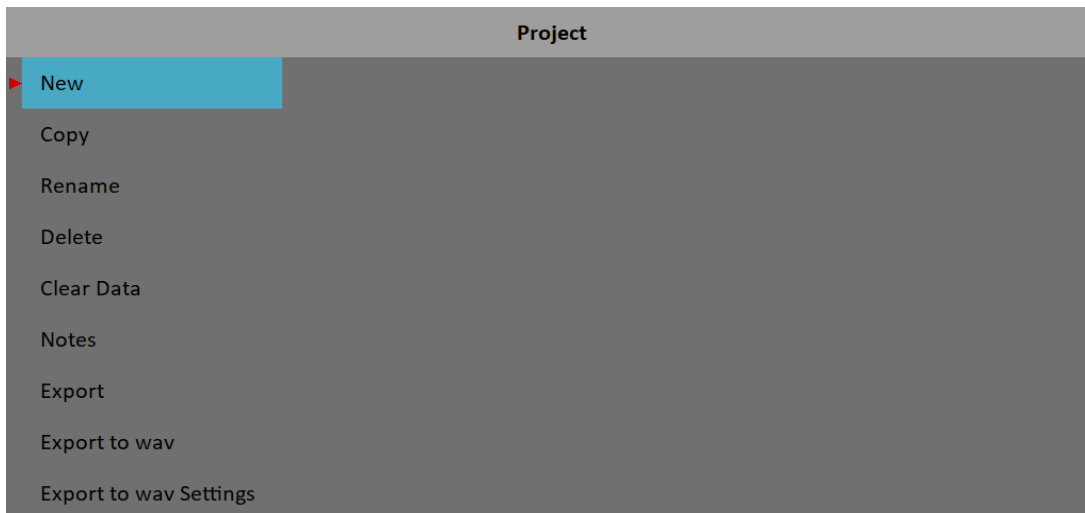

New

Creates a new project (record) and adds it to a *Project List*.

Copy

Copies only the parameters of the selected project, no recorded signals will be copied.

Rename

Renames the selected project.

Delete

Deletes the selected project.

Clear Data

Deletes the signal in the selected project, all record's parameters are kept.

Notes

Adds a note to the selected project. The [Notes](#) dialog has been already introduced in the [Route](#) module.

Export

Exports the selected project to [VA5_DISC](#).

Attention! The maximum record size that can be exported is 4 GB which represents 80 minutes of 4 channel recording with 65536 Hz sampling frequency. When you want to export bigger record, then the error "Not enough space" appears. You need to split a large record to several smaller records. See the [Record Preview](#) chapter.

Export to wav

Exports the selected project as a wav data format. The wav files are saved to a *wav* folder on *VA5_DISC*. You may choose the 24 bit or 16 bit encoding of the wav file using [MENU / SETTINGS / Global Settings / Wav Encoding](#). Additional settings can be done using the [Export to wav Settings](#).

Export to wav Settings

Opens an [Export to wav Settings](#) menu.

Export to csv

Exports the selected project as a csv file. The csv files are saved to a csv folder on *VA5_DISC*.

On first line of the csv, there is a record's sampling frequency in Hz in format:
fs:65536;

Next line contains used channels and their physical units
AC1[g];AC2[g];TRIG;

Then, the values of all signals and eventually trigger are stored by columns.
0.499992;0;1;
0.499992;0.00238538;0;
0.499975;0.00478721;0;
0.499942;0.00718904;0;
 ...

Record Settings

The *Record Settings* menu opens automatically when you open a project without data. You can also open the menu by **Recorder** button when a record is opened. You don't lose any measured data by editing the settings.



Sampling Frequency

The sampling frequency used by recording. The available frequency range of the recorded signal is in the note under the value.

AC1 – AC4, DC1 – DC4, TRIG

Switch to **on** all channels you want to record.

Time

Defines the length of record in minutes or **manually stopped**.

Start of Rec

freerun

The recording is started immediately after the measurement's preparation.

external

The recording is started when a signal on TRIG input exceeds a threshold level which is defined in [MENU / SETTINGS / Trigger Settings / External Trig Level \[V\]](#)t. Such signal may be generated for example when the machine starts to work. This type of signal is usually created in the control system.

amplitude

The recording is started when the signal level on **Ampl Trig Channel** exceeds the **Ampl Trig Level**. The **Ampl Trig** parameters are available only if the **amplitude** is chosen.

Start of Rec	amplitude
Ampl Trig Channel	1
Ampl Trig Level [g]	1
Pretrig[minutes]	0

Pretrig

When the [Start of Rec](#) event occurs the recording is started. But you are able to save a signal before the event by defining the *Pretrig* length.

Recording

Remember to setup all sensors properties before recording. Use the [Sensors](#) menu. When the sensors and record parameters are set, use the *Enter* button to start the recording.

If the record already contains data you will be warned and you can cancel the measurement.

Record contains data.
Data will be rewritten.

During the recording all recorded input signals are displayed on the screen.

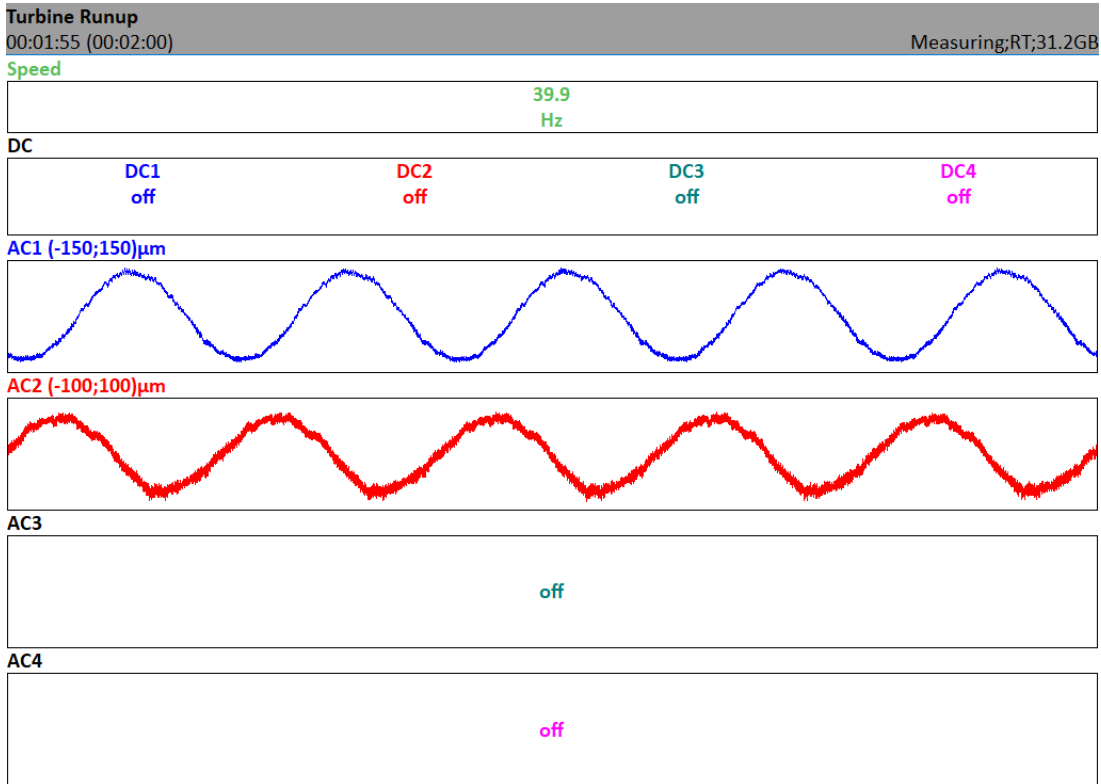

Elapsed and demanded time is displayed in the status bar bottom left corner. The available memory is in the bottom right corner.

The recording is finished when

- the time is over,
- manually, by *Escape* button,
- the memory is full.

Record Preview

After the record is taken the preview of recorded signals is displayed.

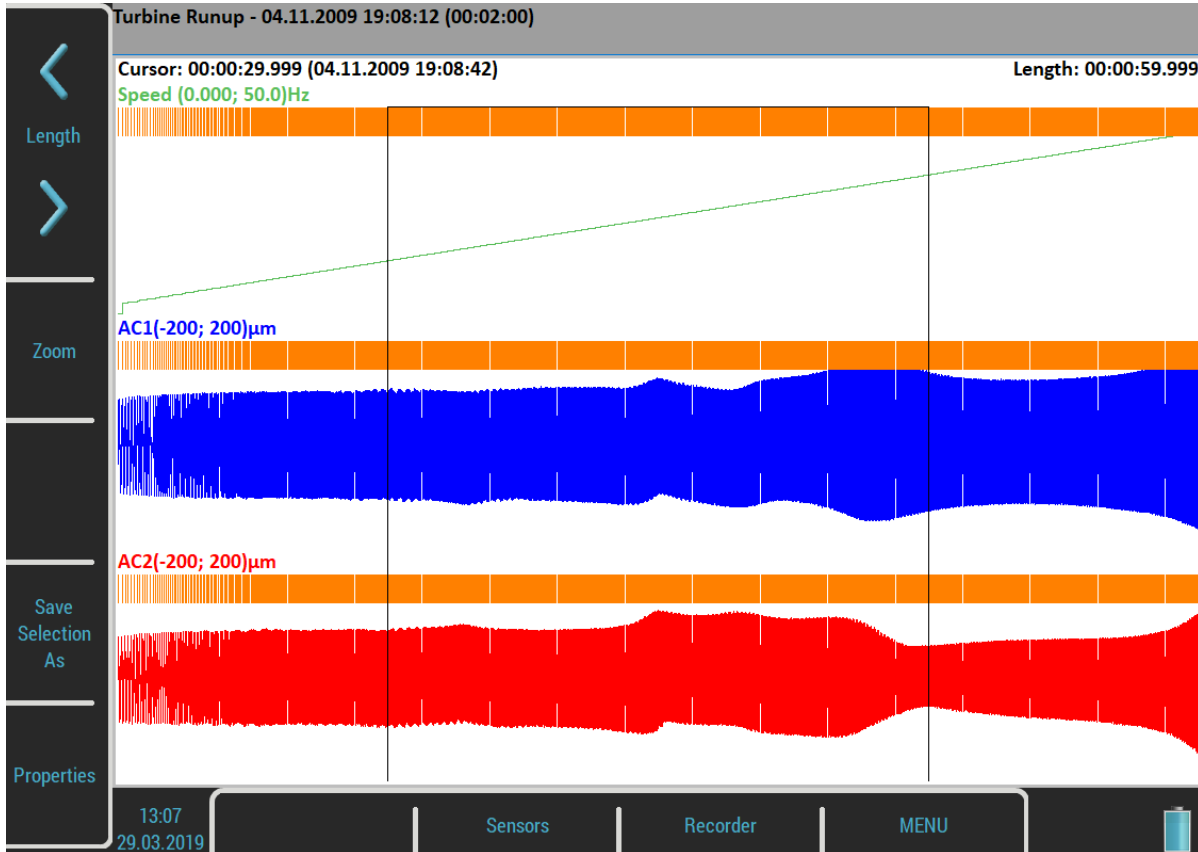

The record date, time and length are displayed behind the record's name in the status bar.

The selection cursor is displayed over the signals. The **Cursor** label shows the beginning of the selection, relatively according to the beginning of the record and also absolutely. You can move the cursor with *Left* and *Right* buttons. The **Length** of the selection can be changed with the **Length** arrows. You can also use touch screen gestures.

You can zoom the record using the **Zoom** button. Zoom X is done to the selection area.

The **Tab** button switches the side buttons meaning between the *Zoom* and initial mode. The *Backspace* button returns the initial mode.

When the record contains longer data then you need for analyzing you can select any part and save it as new record. The **Save Selection As** does it. The *Cursor* defines the beginning of new record. The *Length* defines the length of new record.

The **Properties** button opens a window with information about the record.

The **Enter** button starts a new recording if you want to rewrite the signals. You will be warned before the data erasing.

The **Escape** button closes the preview and skips back to the [Project List](#).

Export to wav Settings

This menu can be opened by **Project** button when the [Project List](#) is on screen.

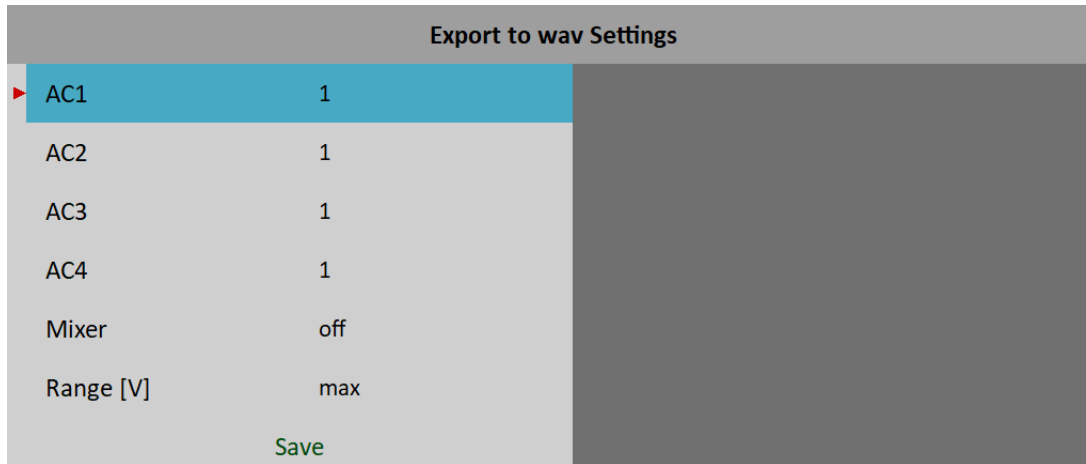

AC1 – AC4

All channels can be mixed to one channel into wav file (like in music studio). The gain factor can be defined for each channel. When the zero is used, then this channel will not be used for mixing.

Mixer

on, off

Select **on** when you want mix all channels to one channel wav file. If the **off** is used, then multichannel wav file will be created. The gain factors are used in both options.

Range [V]

The full AC range of the instrument is +/- 13.8 V (even if a value above 12 V is considered an overload). This range is also used for wav export, i.e. a sample with 13.8 V will be saved as maximum in wav. But it is usually too much, because the real voltage level is much lower, e.g. hundreds of milivolts with an accelerometer 100mV/g. The wav file is then very quiet. The *Range* option enables to apply better wav range and better hearing from headphones.

1.5

This range should be generally acceptable in most of cases.

max

The value of 13.8 V is saved as maximum in wav. The range of wav is 13.8 V.

auto

The reached maximum value in signal is used as wav range.

user

You may enter any value.

Attention! If you need to compare two signals in headphones (for example the noise of old and new bearing) then the same range must be used.

Attention! When the range value is lower than the range of signal, then the warning "**Wav overload**" appears after the export.

Temporary record

Records can be stored in the DDS database. For record analysis, the DDS copies one record into the list of records in the Virtual Unit and runs the Virtual Unit. We call this record as temporary. It will be deleted once you will close the Virtual Unit.

Balancer

The balancing process is based on standard measurements of amplitude and phase on the speed frequency. If you are not familiar with field balancing method, please see any special literature.

Planes and Points

We would like to explain the difference between words 'plane' and 'point'. The sensor is mounted to the point or points (dual channel reading). The trial mass and final masses are mounted to the plane or planes. Some people talk about measuring on planes, but this is not correct. In case of overhanging rotor there is no direct relationship between points and planes.

We use the labels A and B for points and 1 and 2 for planes.

Project

The Project is the base structure in balancer. It corresponds to one balancing job. You can use the same Project for repeated jobs on the same machine. The measured data will be rewritten.

The Project contains all measured or entered data, which were used during the job.

The typical scheme looks like next list of steps:

- Create new project.
- Enter balancing parameters (type of machine, number of planes etc.).
- Initial measurement of vibration amplitude and phase on required measurement points.
- Put trial weight on the rotor. Step by step to all planes.
- Trial weight response measurement. Step by step to all planes.
- Put correction weights on all planes.
- Check of effect (success).
- Trim measurements for additional weights and better results.

Every step is displayed in one screen. The movement between screens is provided by **Up / Down** arrows.

Attention! When you return back in the job screens and you take a repeated measurement or enter a new value, then the measured data will be erased in all screens after actual screen. The reason is simple. The implications are derived from every screen to the next screens. When you repeat the measurement, you change the parameters for those implications. That is why all next screen implications must be removed and you have to make all necessary measurements again.

Project List

The list of saved projects opens when you enter the Balancer module. The list is empty if you have no saved projects yet. The modification time stamp of the selected project is displayed in the status bar in the bottom right corner.

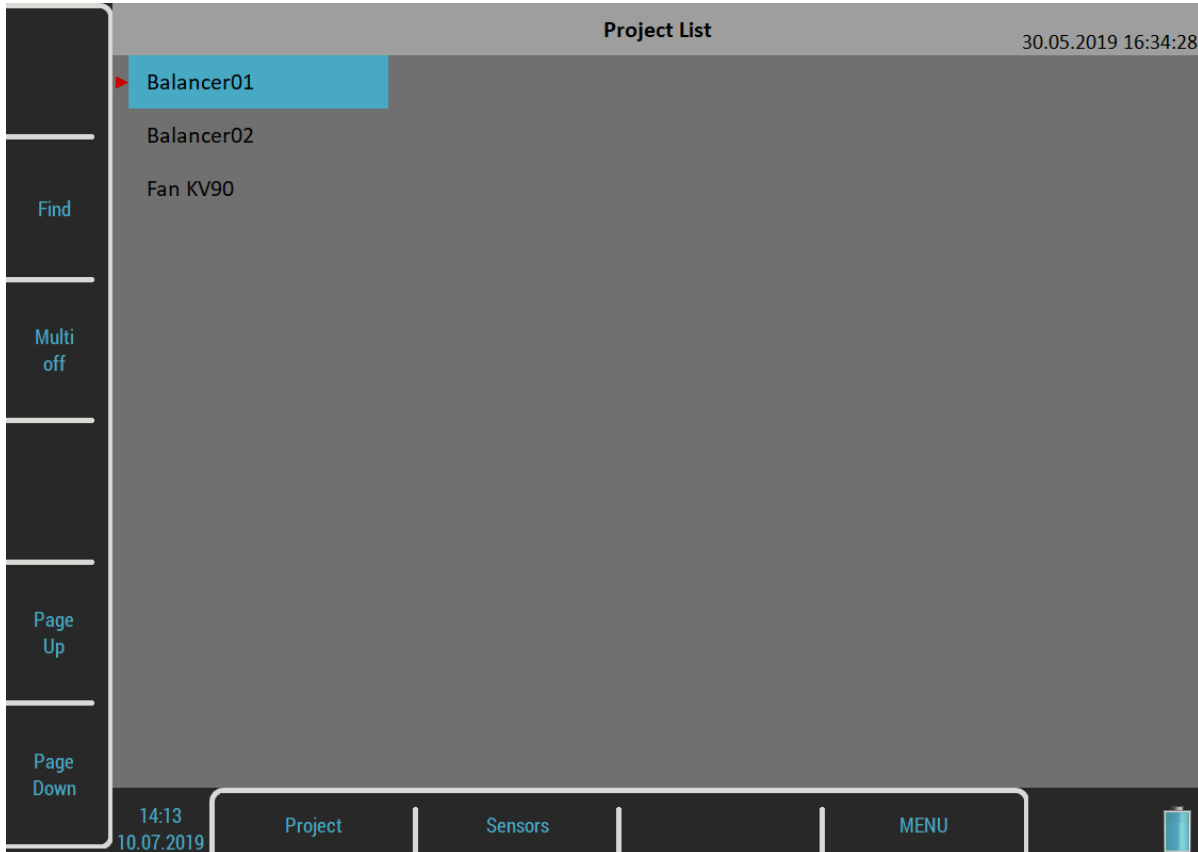

Project Menu



New

Creates a new project with default properties.

Copy

Creates a new project as the copy of selected project. Only the header data are saved. No measured data are saved.

Rename

Renames the selected project. The project with old name does not exist anymore.

Delete

Deletes selected project.

Clear Data

Erases all measured data, only the project header remains.

Export

Exports selected project to *VA5_DISC*.

Note! The Balancer projects are automatically exported during closing. You don't need to export them manually. The *Export* item can be used in case you delete the project from *VA5_DISC* and want to export it again.

Balancer Settings

A [Basic Settings](#) menu automatically opens when you open a project which has no data yet. Later, you may open the menu using the **Balancer Settings** button. There are three separate menus under this button, [Basic Settings](#), [Units Settings](#) and [Rotor Settings](#).

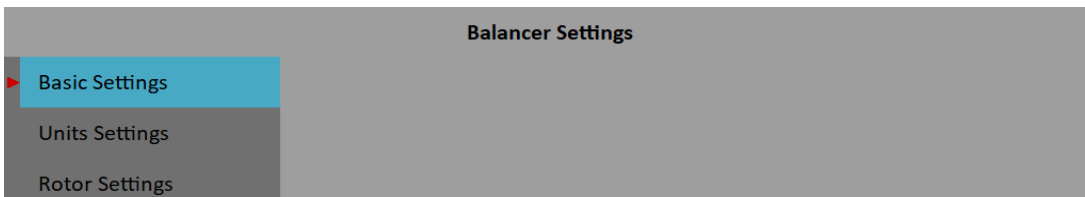

Basic Settings

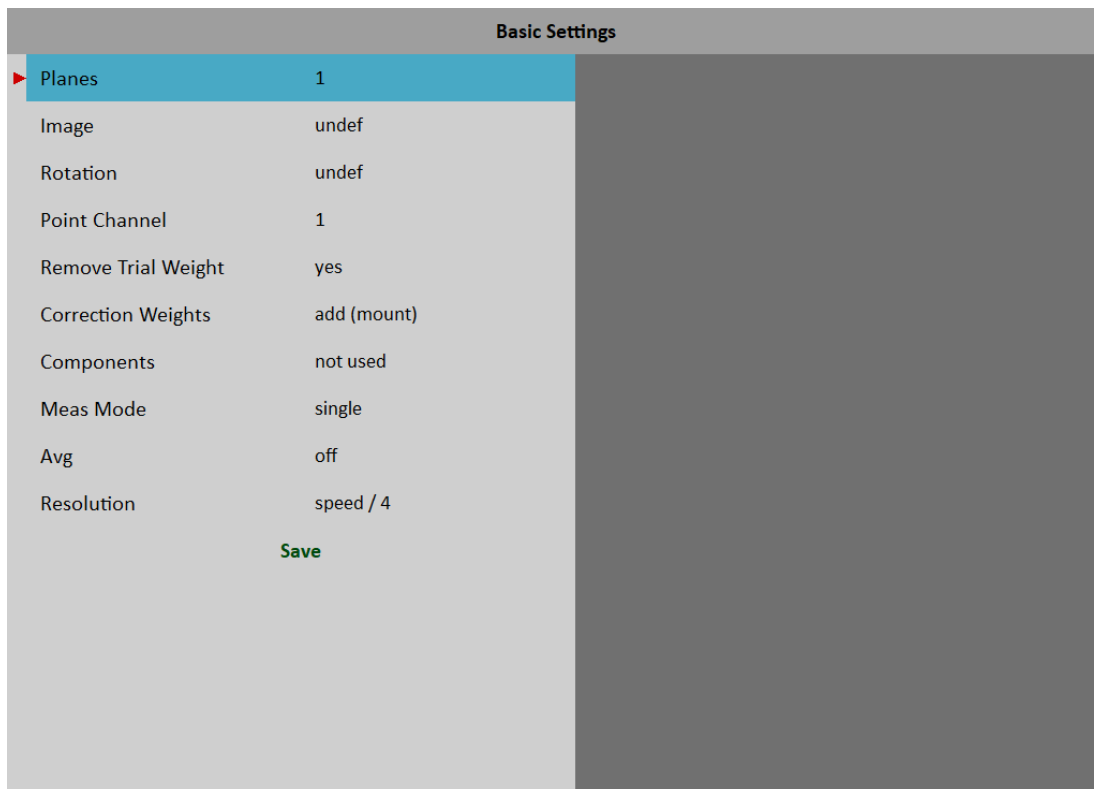

Planes

1, 2

Number of balancing planes.

Image

Selection of machine image, different images are available for 1 or 2 plane balancing

Look

left, right

View direction. Available only if Image has been defined. Moreover, not all images enable the look.

Image	overhung rotor
Look	right

Right:

Left:



Rotation

CW, CCW

Clockwise or counterclockwise

Point Channel

The number of AC input, which will be used for sensor mounted on measurement point, for 1 plane balancing

Point A Channel, Point B Channel

Numbers of AC inputs, which will be used for sensors mounted on measurement points, for 2 planes balancing

Note! You can enter the same AC channel number for both A and B point. In this case, the measurement with one sensor is expected and readings for both points are not taken together. First, you take the measurement on one point. Then, you remount the sensor to the other point and take next reading. The point, which is currently measured is selected by Left / Right button (see later).

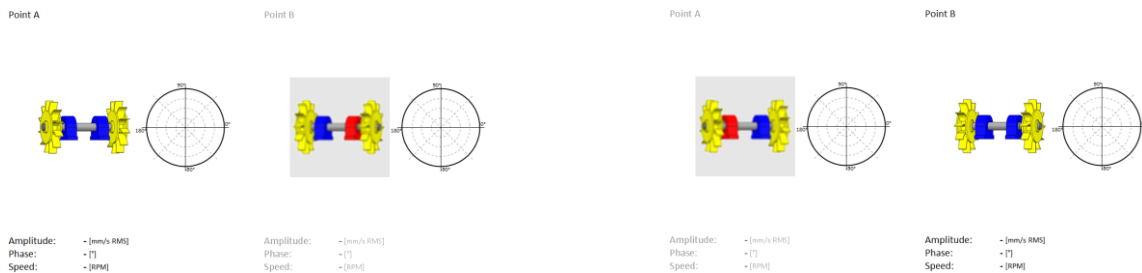

Note! The measurement points marking A and B has only the symbolic sense. It has no relation to the balancing planes 1, 2 and to the balancing computational procedure. You can mark any point as A and the second as B.

Remove Trial Weight

yes, no

The trial mass can be left on the rotor or can be removed from the rotor after trial run.

Remove Trial Weight (Plane 1)

yes, no

For 2 planes balancing, you may remove or keep trial on each plane individually.

Remove Trial Weight (Plane 2)

yes, no

For 2 planes balancing, you may remove or keep trial on each plane individually.

Correction Weights

add (mount), remove (drill)

Components

Number of components. This parameter is used in job requiring the split of the correction weight into components (blades for example).

Meas Mode

single, online meter

When you start a measurement process by pushing *Enter*, then only one value can be taken (**single**) or the continual measurement values could be displayed (**online meter**). In **online meter** mode, you may look at more values and to evaluate the changing of them in time. You need to stop the measurement by pushing *Escape/Stop*, when is displayed the value, which you want to use.

Avg

The averaging of more than one measured value is available

Resolution

It's the aps measurement resolution described in [Analyzer](#) / [Edit Measurement](#) / [Resolution](#).

Units Settings

Set the units for current project.

Units Settings	
Amplitude	mm/s
Detect Type	RMS
Speed	RPM
Mass	g
Rotor Mass	kg
Correction Radius	mm
Unbalance	g-m
Save	

Amplitude

Selection from available vibration units.

Detect Type

RMS, 0-P, P-P

Detect type for amplitude value

Note! This value is same as global value defined in [MENU / SETTINGS / Spectrum Settings / Detect Type](#) until you change it here. That means, if you change the global value, it will be changed here also. This will stop after the first time you enter a value here.

Speed, Mass, ...

Selection from available units for particular quantity.

Rotor Settings

Rotor Settings	
▶ Operating Speed [RPM]	same as balancing speed
Rotor Mass [kg]	-
Correction Radius [mm]	-
Quality Grade	-
Save	

All parameters are optional. It enables to calculate unbalance and balancing quality factor according to *ISO1940*.

Operating Speed

One of the parameters used for Quality Grade calculation is the speed of the rotor. By default, the Quality Grade calculation uses the speed detected during the balancing process. However, sometimes the real operating speed differs from the balancing speed. In this case, you can enter the operating speed here and this speed will be used for Quality Grade calculation.

Rotor Mass

Rotor mass

Correction Radius

Radius to which the correction weight will be mounted (could be different for each plane)

Quality Grade

Required quality grade according to *ISO 1940*. If this value is entered, the recommended trial weight can be offered.

Initial Run

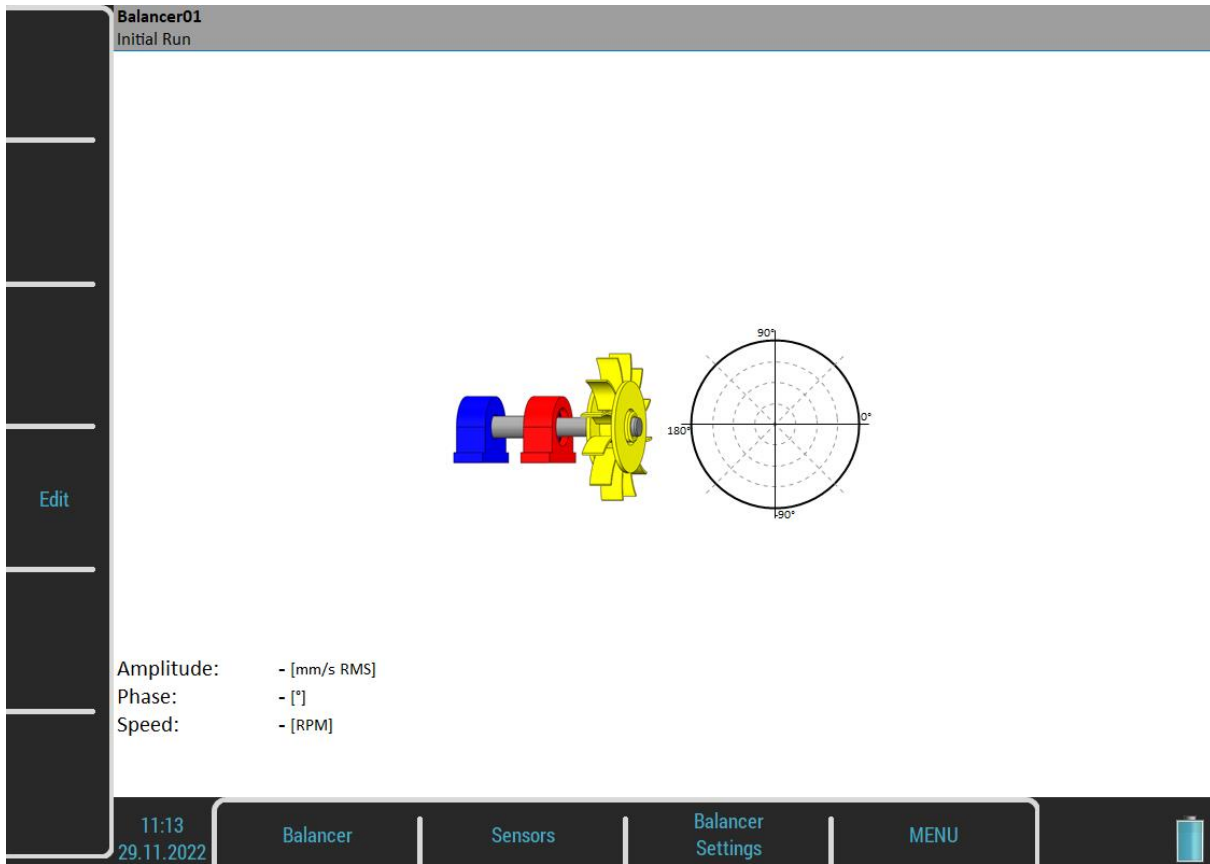

The red bearing house is the recommended point for sensor mounting. But you can use any other place, which is suitable for measurements. The polar graph is prepared to display measured values. Push **Enter/Start** button to start the measurement process. Alternatively, you may press the **Edit** button and enter all values manually (balancing calculator function).

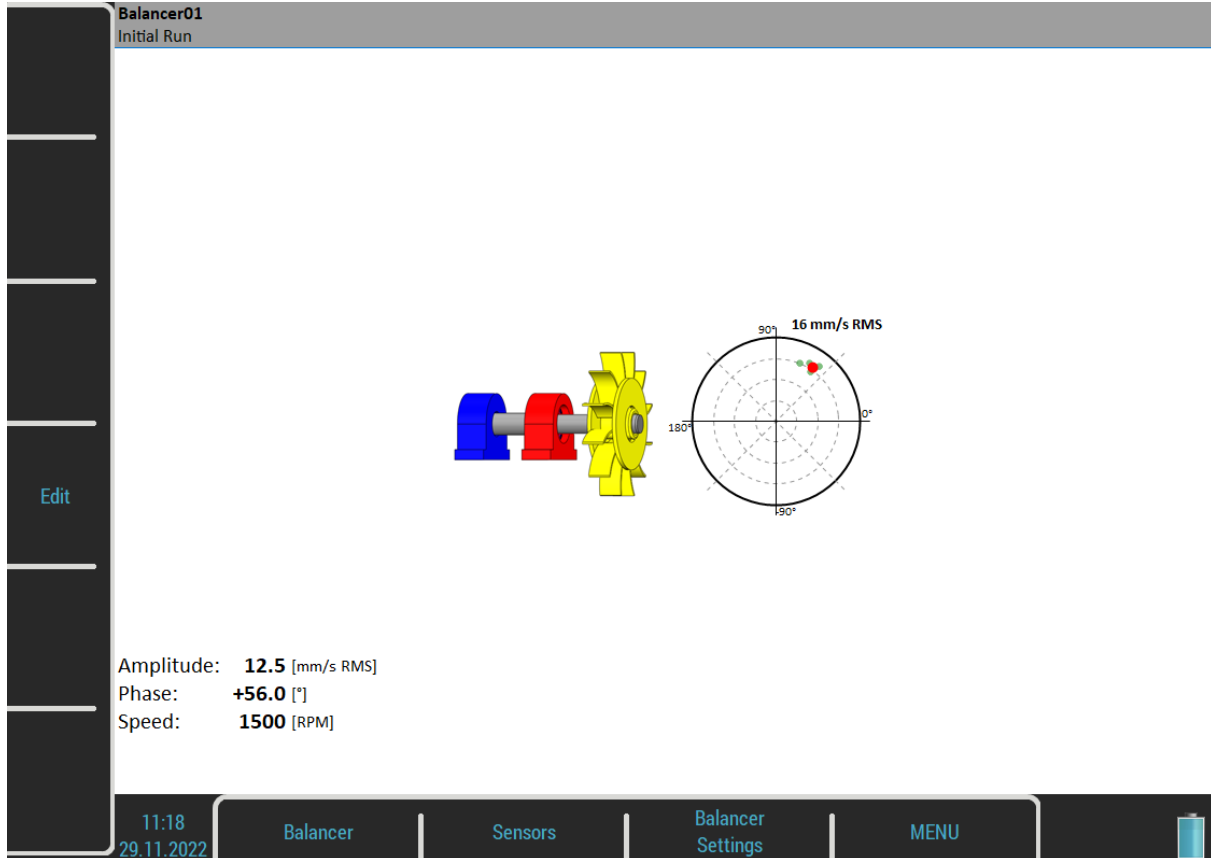

The red dot on the polar graph shows the current amplitude and phase in the complex plane. Smaller green dots show all values during measurement process when the [Meas Mode](#) is set as **online meter**. Press the **Down** arrow to move to the next screen.

Trial Run

The trial weight response is measured in this run.

Balancer01
Trial Run

Trial Weight
Mass: - [g] Recommended: 64.2 [g]
Angle: **+0.0** [°]

Enter Trial Weight

Enter DF

Edit

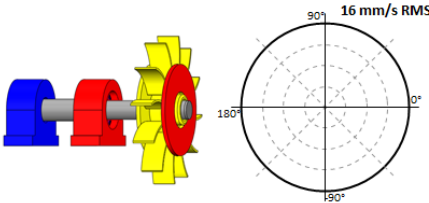

Amplitude: - [mm/s RMS]
Phase: - [°]
Speed: - [RPM]
DFA -
DFP - [°]

11:36
29.11.2022

Balancer Sensors Balancer Settings MENU

Push the **Enter Trial Weight** button and enter the mass and angle of the trial weight. Usually, the trial weight is placed at zero angle and serves as a zero mark. However, you can set the zero mark wherever and set the trial weight angle from the zero mark. The angle of the trial weight must keep the [Global Settings / Angles Counting](#) setup. This means, if you use **with rotation** angles counting, the angle is positive when you put the trial weight before the zero mark in the direction of rotation and negative when you put the trial weight behind the zero mark (or when the trial goes first and zero mark goes second the trial weight angle is positive). For **against rotation** angles counting, it is the opposite.

If the [Components](#) have been defined, the trial weight position is entered as the number of the component. The angles counting must be kept as well. The component number grows in the direction of rotation if with rotation is set and vice versa.

The mass can be negative, it represents removing of the weight (for example dismounting of old correction weight).

The recommended weight value is displayed only if the [Rotor Settings](#) parameters are entered.

Don't forget to mount the trial weight to the balancing plane.

Balancer01
Trial Run

Trial Weight
Mass: **70** [g] Recommended: 64.2 [g]
Angle: **+0.0** [°]

Enter Trial Weight
Enter DF
Edit

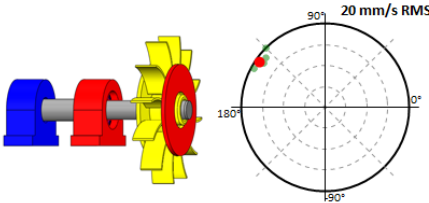

Amplitude: **19** [mm/s RMS]
Phase: **+145.0** [°]
Speed: **1500** [RPM]
DFA **322**
DFP **+178.6** [°]

11:54 29.11.2022 Balancer Sensors Balancer Settings MENU

After the trial run measurement, the **dynamic factor** of the machine is displayed. The **DFA** and **DFP** (amplitude and phase) values are the response values of standardized trial mass on the correction radius. If you will balance the same machine again after some time, then you do not need to measure the trial weight response again. Instead, you may just enter the **DFA**, **DFP** values on this screen. Use **Enter DF** button for that.

Result

Balancer01
Mass and position of correction weight

Init. Unbalance: **7.75** [g·m] max: 1.6 [g·m]
Init. Quality: **30.4** max: 6.3

▼: Trial Weight Position

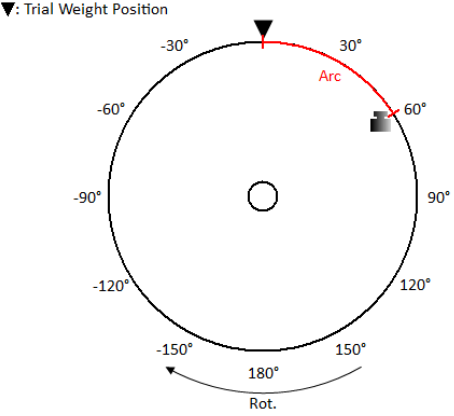

Correction Weight 1
Trial weight removed

Mass: **38.8** [g]
Angle: **+57.4** [°]
Arc: **200** [mm]

13:06 29.11.2022 Balancer Sensors Balancer Settings MENU

According to the [Basic Settings](#) / [Remove Trial Weight](#), the information window appears.

Remove trial weight!

or

Keep trial weight!

Don't forget to remove the trial weight if it is set. However, you can use it as zero mark first and remove it after correction weight mounting.

If you have entered [Correction Radius](#) and [Rotor Mass](#) values in the [Rotor Settings](#) menu, the **Initial Unbalance** and **Balancer Quality** values according to *ISO 1940* are displayed. In case the values are satisfactory, you don't need to continue with the balancing job.

Note! The initial means that trial weight is not taking account, even if it is kept.

The mass and angle (position) of the correction weight are displayed.

The angles are calculated from the zero mark. The direction of the angle depends on the [MENU / SETTINGS / Global Settings / Angles Counting](#) value. If it is set as **with rotation**, the angle direction is same as the direction of rotation and positive values are in the direction of rotation (in the picture above it is +57° in the direction of rotation). If the Angles Counting value is set as **against rotation**, the angles have opposite values.

With rotation:

Init. Unbalance: **7.75** [g·m] max: 1.6 [g·m]
 Init. Quality: **30.4** max: 6.3

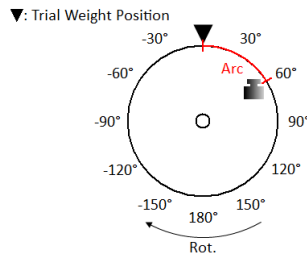

Correction Weight 1
 Trial weight removed

Mass: **38.7** [g]
 Angle: **+57.4** [°]
 Arc: **200** [mm]

Against rotation:

Init. Unbalance: **7.75** [g·m] max: 1.6 [g·m]
 Init. Quality: **30.5** max: 6.3

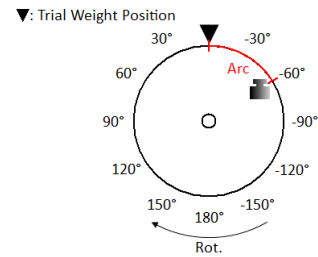

Correction Weight 1
 Trial weight removed

Mass: **38.8** [g]
 Angle: **-57.4** [°]
 Arc: **200** [mm]

Warning! If you haven't defined the direction of rotation, the result is displayed in default direction with angles increasing counter clock wise. The angle has still the same value (+57° with rotation or -57° against rotation). However, the picture may not correspond the reality. You need to determine the right position yourself.

With rotation:

Init. Unbalance: **7.76** [g·m] max: 1.6 [g·m]
 Init. Quality: **30.5** max: 6.3

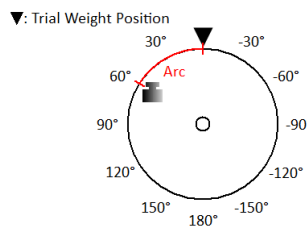

Correction Weight 1
 Trial weight removed

Mass: **38.8** [g]
 Angle: **+57.4** [°]
 Arc: **200** [mm]

Against rotation:

Init. Unbalance: **7.75** [g·m] max: 1.6 [g·m]
 Init. Quality: **30.5** max: 6.3

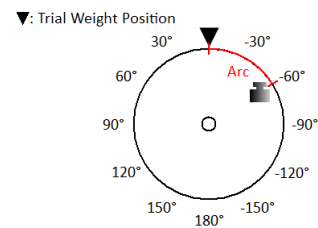

Correction Weight 1
 Trial weight removed

Mass: **38.8** [g]
 Angle: **-57.4** [°]
 Arc: **200** [mm]

Note! You cannot change the Angles Counting value during a balancer job. If the value is changed, the error message appears.

Balancing Error

Angles counting in project is different from settings in instrument.
Change the value in menu Global Settings / Angles Counting or create new project.

In case you have entered the [Correction Radius](#) value, the **Arc** value shows a circumferential distance of the correction weight from zero mark.

You can split correction mass into two arbitrary angles (in case if it is not possible to place the correction mass into calculated position). Use menu **Balancer / Split correction weight**

Enter the value of the first angle.

Enter first angle [°]

30

Then enter the value of the second angle.

Enter second angle [°]

60

The balancing mass will be recalculated (split) into two required angles.

Init. Unbalance: **7.76** [g·m] max: 1.6 [g·m]

Init. Quality: **30.5** max: 6.3

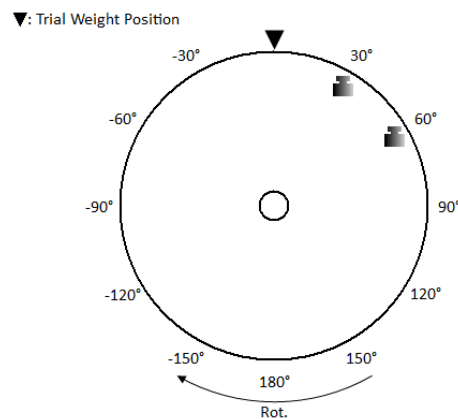

Correction Weight 1

Trial weight removed

Mass 1: **3.55** [g]

Angle 1: **+30.0** [°]

Mass 2: **35.7** [g]

Angle 2: **+60.0** [°]

Use **Balancer / Set Default Angle** to return back to the original calculation.

If the [Components](#) have been defined, the correction weight is divided between two nearest components. The component number is counted from the zero mark, which is the component number one. The component numbers keep the angles counting parameter. The component number grows in the direction of rotation if with rotation is set and vice versa.

Init. Unbalance: **7.76** [g·m] max: 1.6 [g·m]
 Init. Quality: **30.5** max: 6.3

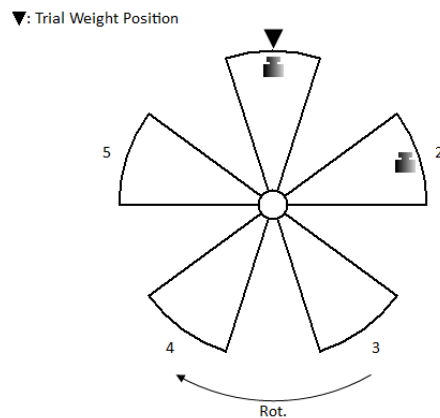

Correction Weight 1

Trial weight removed

Mass 1: **10.3** [g]
 Component 1: **1**
 Mass 2: **34.3** [g]
 Component 2: **2**

You can select other components in case when you cannot mount weight to the nearest components. Select **Balancer / Change Components** menu item.

Enter the number of the first component.

Enter first component (1 - 5)

Then enter the number of the second component.

Enter second component (1 - 5)

New correction weights will be displayed.

Init. Unbalance: **7.76** [g·m] max: 1.6 [g·m]
 Init. Quality: **30.5** max: 6.3

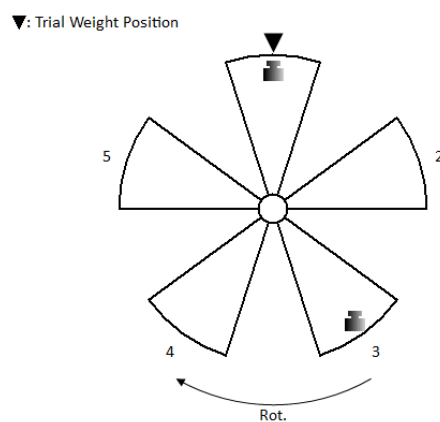

Correction Weight 1

Trial weight removed

Mass 1: **65.9** [g]
 Component 1: **1**
 Mass 2: **55.6** [g]
 Component 2: **3**

Select **Balancer / Set Default Components** menu item to return to the original weights.

Mount the recommended correction weight to the machine.

Correction Run

When the weight is mounted you want to check the job.

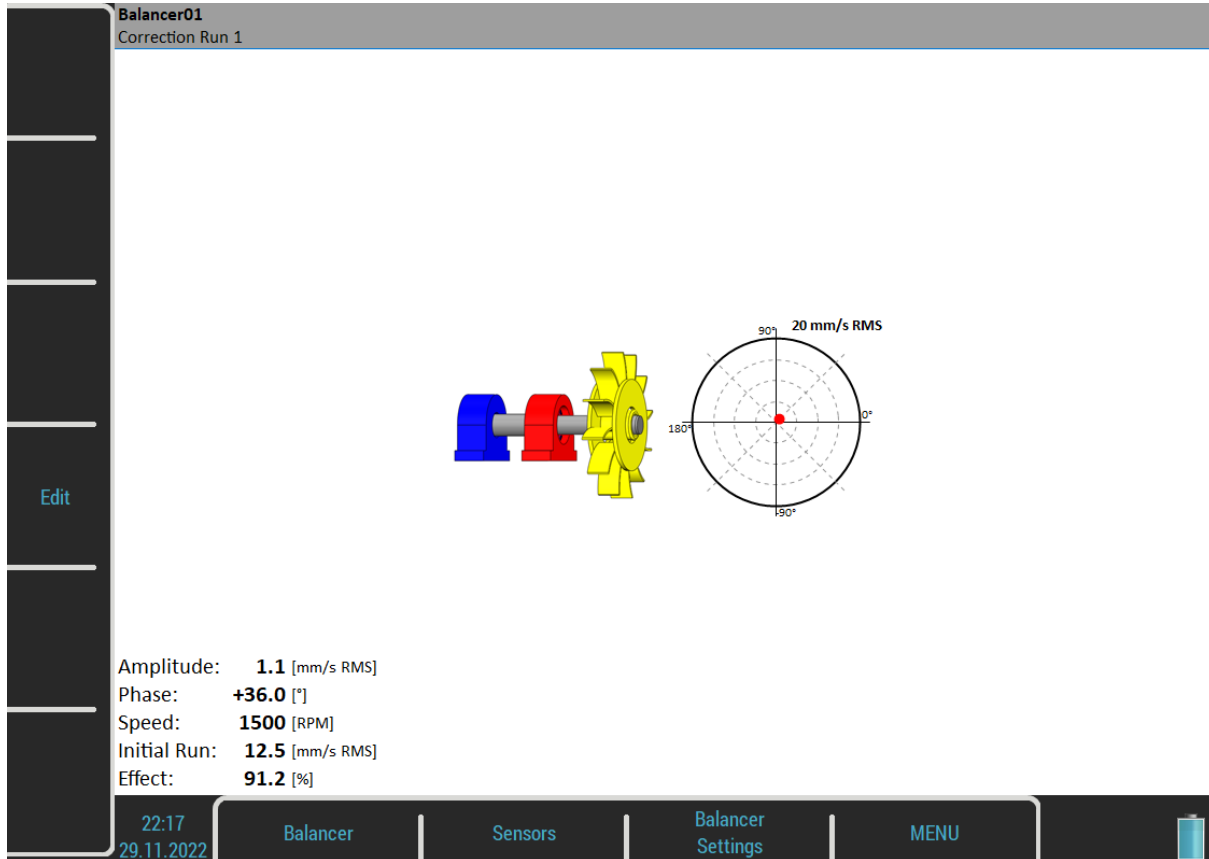

- **Initial Run**
amplitude of Initial Run
- **Effect**
is the reduction of balancing in %
 $Effect = (1 - A2 / A1) * 100\%$
(the 1.1mm/s is the 8.8% of 12.5 mm/s)

Residual unbalance and quality are available on next screen together with next correction weight suggestion.

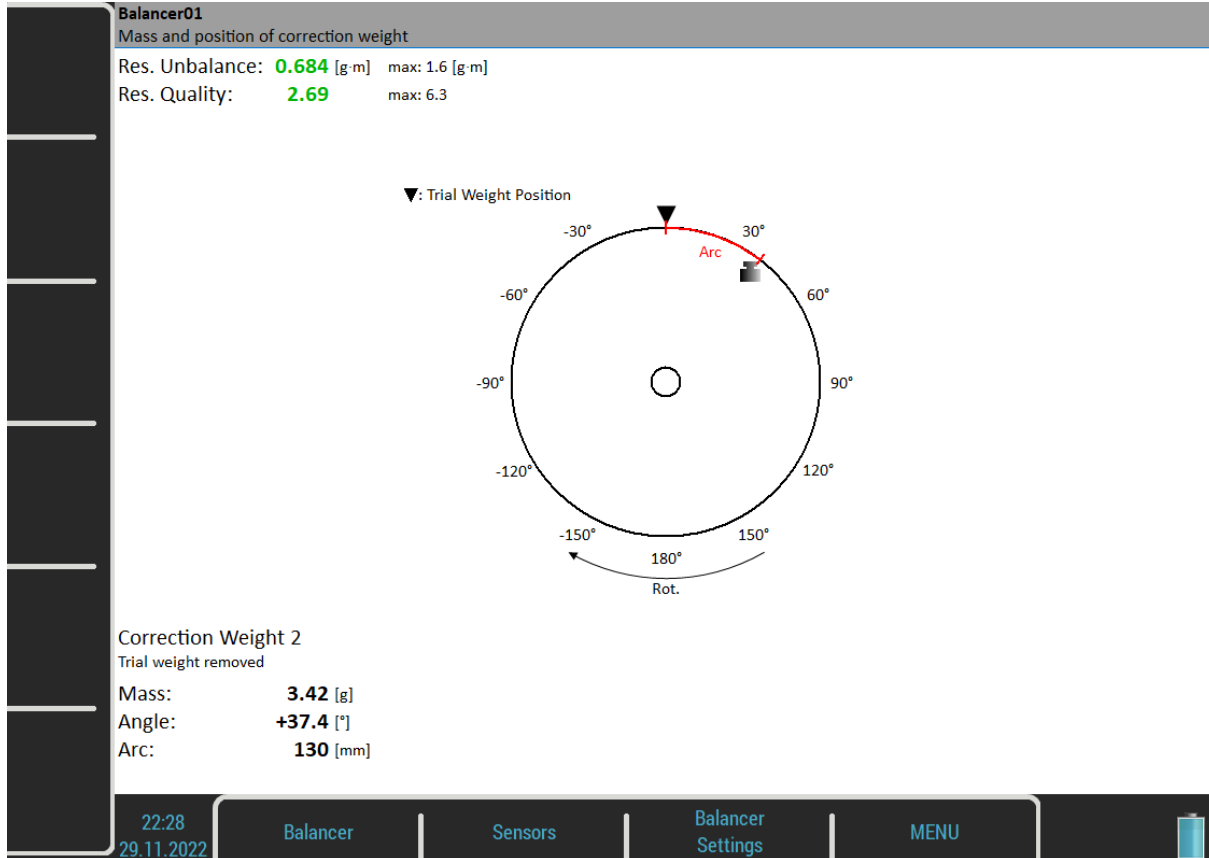

You can continue with the job until you are satisfied with the results. These next steps do not require trial weight measurement already. After each measurement the next correction weight is recommended. However, when the result is not better (or even is worse) the next correction runs have no sense.

Dual Plane Balancing

Initial Run

The screen is divided into two parts. The left part corresponds to point A measurements and plane 1 results, the right part corresponds to point B measurements and plane 2 results.

If you use only one sensor ([Point A Channel](#), [Point B Channel](#) are same), then only one part is active. The non-active part is grey and contains un-sharpened image. Mount the sensor to the active plane point and start the measurement. Use the **Right / Left** arrow button to move the active focus.

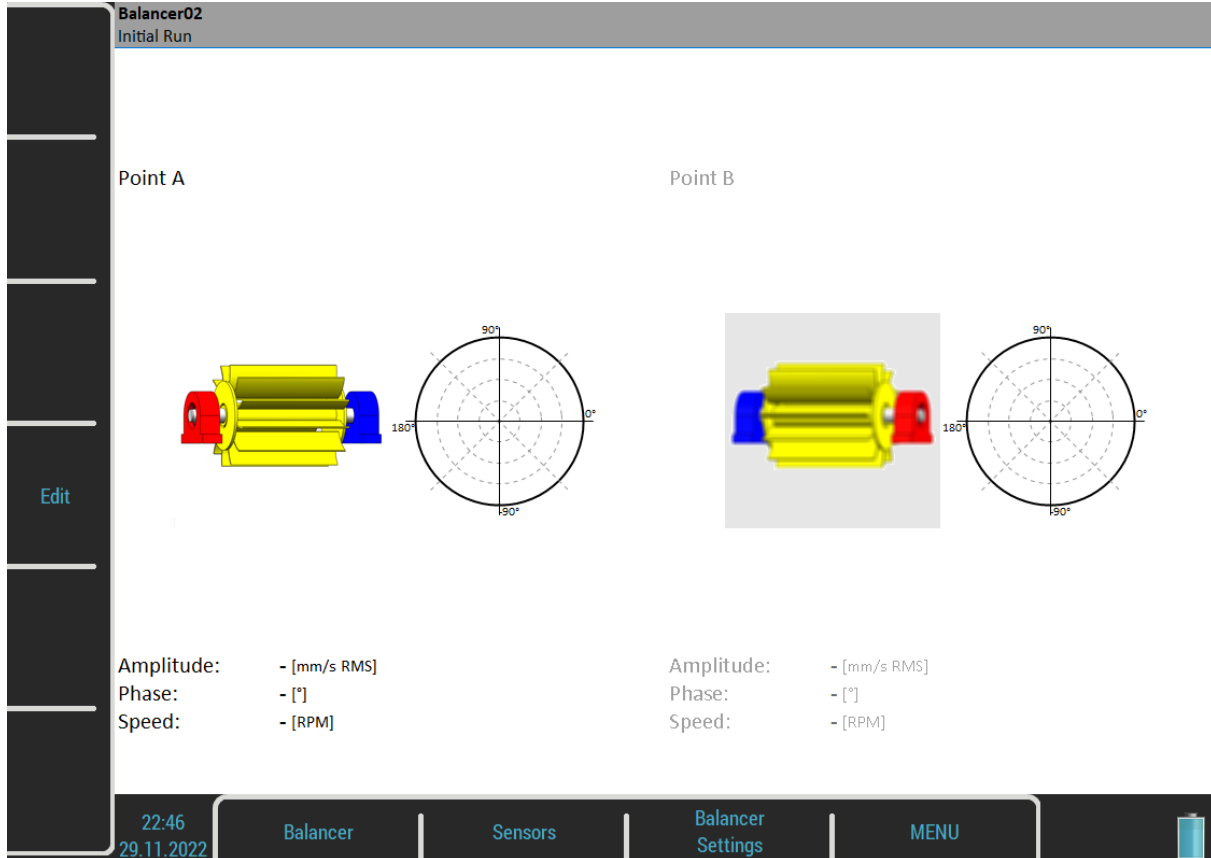

You can make both points measurements together at once with two sensors (set the [Point A Channel](#), [Point B Channel](#) to different values). Then the screen should look like next picture.

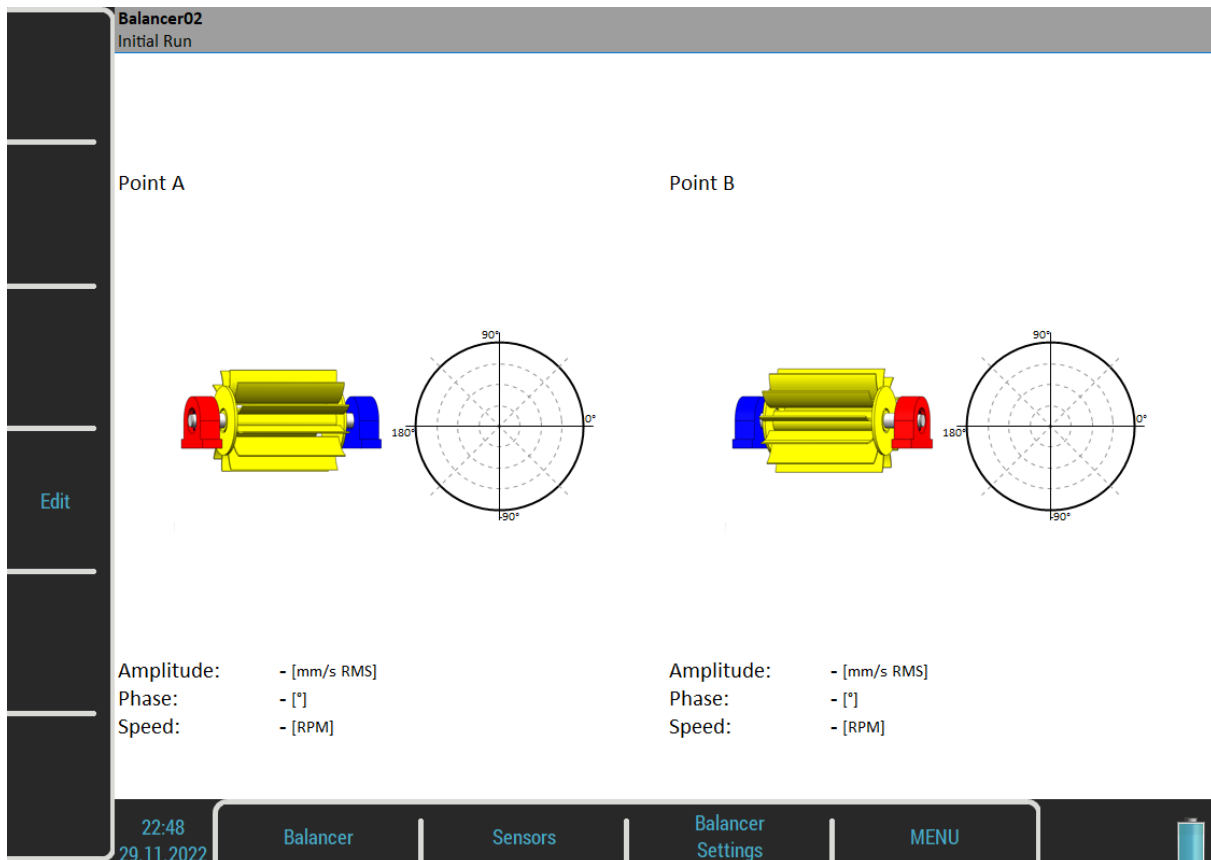

The red bearing house is the recommended point for sensor mounting. But you can use any other place, which is suitable for measurements. The polar graph is prepared to display measured values. Push **Enter/Start** button and measurement will be taken. Alternatively, you may press the **Edit** button and enter all values manually (balancing calculator function).

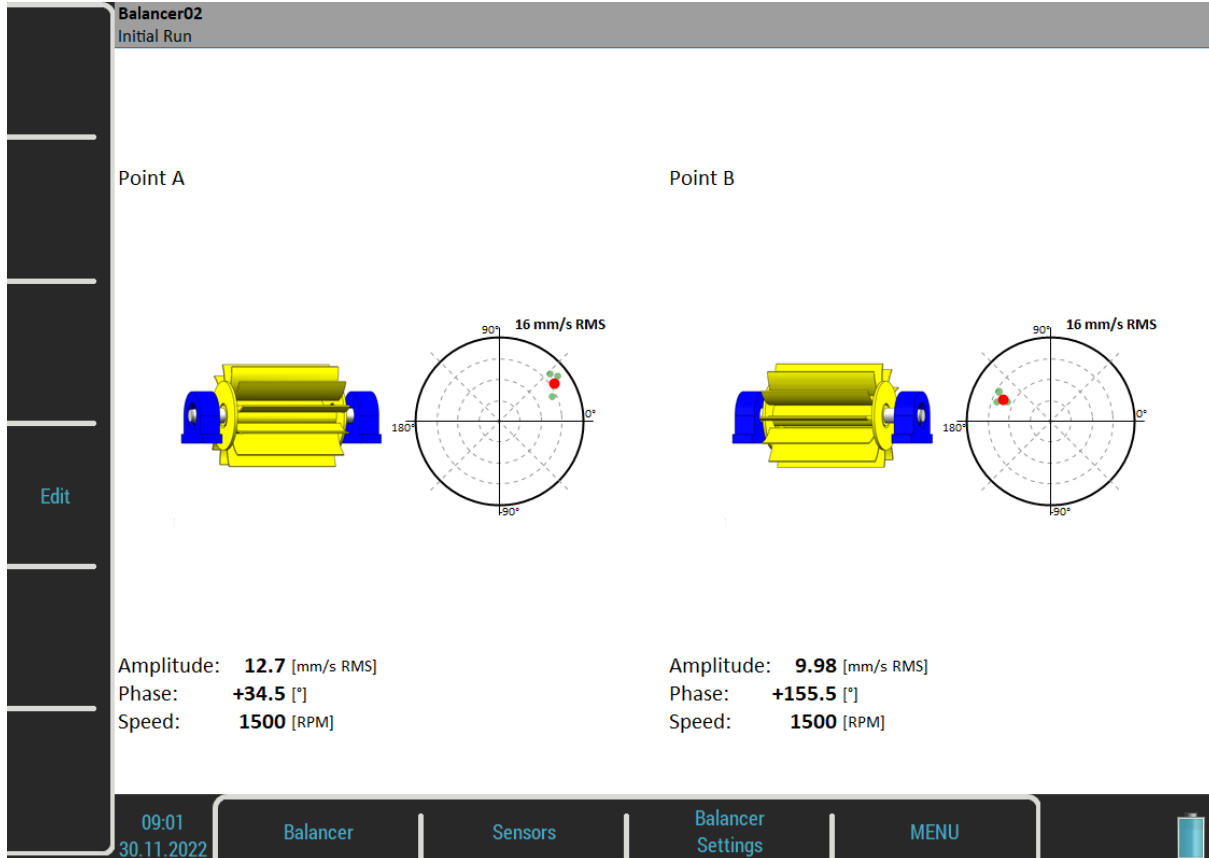

The red dot in the polar graph shows the current amplitude and phase in the complex plane. Smaller green dots show all values during measurement process when the [Meas Mode](#) is set as **online meter**. Press the **Down** arrow to move to the next screen.

Trial Run 1

It is similar like single plane balancing, only two trial weights must be subsequently mounted to two planes. If you know the *dynamic factor*, then you can enter all 4 values manually and you do not need to measure trial runs. See more details about dynamic factor in [Single Plane Balancing / Trial Run](#).

Balancer02
Trial Run 1

Trial Weight in Plane 1
Mass: - [g] Recommended: 32.1 [g]
Angle: **+0.0** [°]

Point A Point B

Enter Trial Weight

Enter DF

Edit

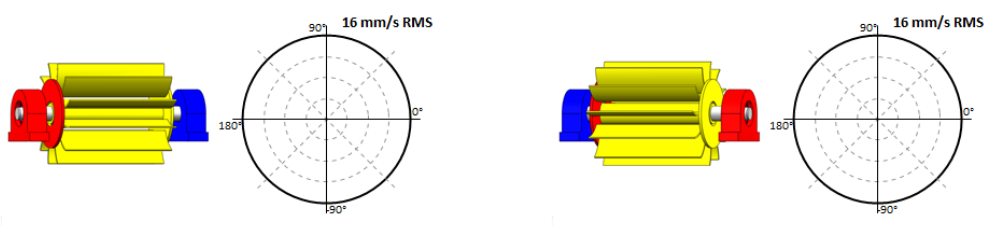

Amplitude:	- [mm/s RMS]	Amplitude:	- [mm/s RMS]
Phase:	- [°]	Phase:	- [°]
Speed:	- [RPM]	Speed:	- [RPM]
DFA11:	-	DFA12:	-
DFP11:	- [°]	DFP12:	- [°]

09:05
30.11.2022

Balancer Sensors Balancer Settings MENU

The corresponding plane for trial weight mounting is highlighted by the red disc. See the [Single Plane Balancing / Trial Run](#) for more details about trial weight mounting.

Put the trial weight to the plane 1 and take the measurements for both points.

After both points measurements are taken, you should resolve the trial weight according to the [Basic Settings / Remove Trial Weight \(Plane 1\)](#).

In case of Remove Trial Weight is set as **yes**, next question will appear:

Temporarily keep trial weight in plane 1 also during measurement with trial weight in plane 2?

If you answer *No*, then you must remove the trial weight as expected. However, you can answer *Yes* and keep the trial weight on plane 1 also during measurement with trial weight in plane 2. This can be useful, when you want to use the trial weight as the zero mark for correction weights mounting.

In case of Remove Trial Weight is set as **no**, next notification will appear.

Keep trial weight in plane 1!

After confirming a message, you can check the measured values on the Trial Run 1 screen.

Balancer02
Trial Run 1

Trial Weight in Plane 1
 Mass: **40** [g] Recommended: 32.1 [g]
 Angle: **+0.0** [°]

Point A Point B

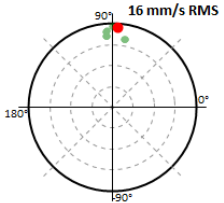
Amplitude: 15.3 [mm/s RMS] Phase: +86.5 [°] Speed: 1500 [RPM] DFA11: 312 DFP11: +140.0 [°]	Amplitude: 9.1 [mm/s RMS] Phase: +67.5 [°] Speed: 1500 [RPM] DFA12: 332 DFP12: +18.7 [°]
---	---

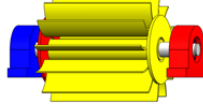
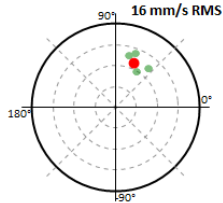
09:43 30.11.2022 Balancer Sensors Balancer Settings MENU

Trial Run 2

Balancer02
Trial Run 2

Trial Weight in Plane 2
 Mass: - [g] Recommended: 32.1 [g]
 Angle: **+0.0** [°]

Point A Point B

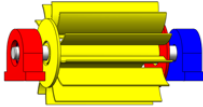
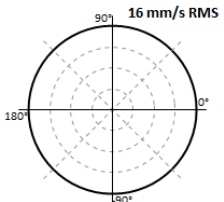
Amplitude: - [mm/s RMS] Phase: - [°] Speed: - [RPM] DFA21: - DFP21: - [°]	Amplitude: - [mm/s RMS] Phase: - [°] Speed: - [RPM] DFA22: - DFP22: - [°]
---	---

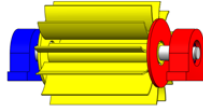
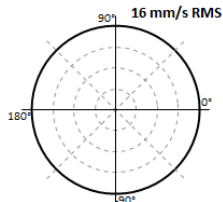
09:51 30.11.2022 Balancer Sensors Balancer Settings MENU

The same two measurements we have to take with trial weight in plane 2. The screen for those measurement looks similarly like previous screen. Only the red disc is in the plane 2. Enter the trial weight values and put the trial weight into the plane 2. Take the measurement on both points.

Balancer02
Mass and position of correction weight

Init. Unbalance: **20.5** [g·m] max: 1.6 [g·m]
Init. Quality: **80.5** max: 6.3

Plane 1

▼: Trial Weight Position

Rot.

Correction Weight 1
Trial weight removed

Mass: **45.4** [g]
Angle: **-24.3** [°]
Arc: **85** [mm]

Plane 2

▼: Trial Weight Position

Rot.

Correction Weight 1
Trial weight removed

Mass: **57.1** [g]
Angle: **+8.3** [°]
Arc: **29** [mm]

10:18 30.11.2022 Balancer Sensors Balancer Settings MENU

Correction Run

See [Single Plane Balancing](#) / [Correction Run](#) for more details.

Balancer02
Correction Run 1

Point A

Amplitude: **0.5** [mm/s RMS]
Phase: **+11.0** [°]
Speed: **1500** [RPM]
Initial Run: **12.7** [mm/s RMS]
Effect: **96.1** [%]

Point B

Amplitude: **0.3** [mm/s RMS]
Phase: **+59.0** [°]
Speed: **1500** [RPM]
Initial Run: **9.98** [mm/s RMS]
Effect: **97** [%]

10:28 30.11.2022 Balancer Sensors Balancer Settings MENU

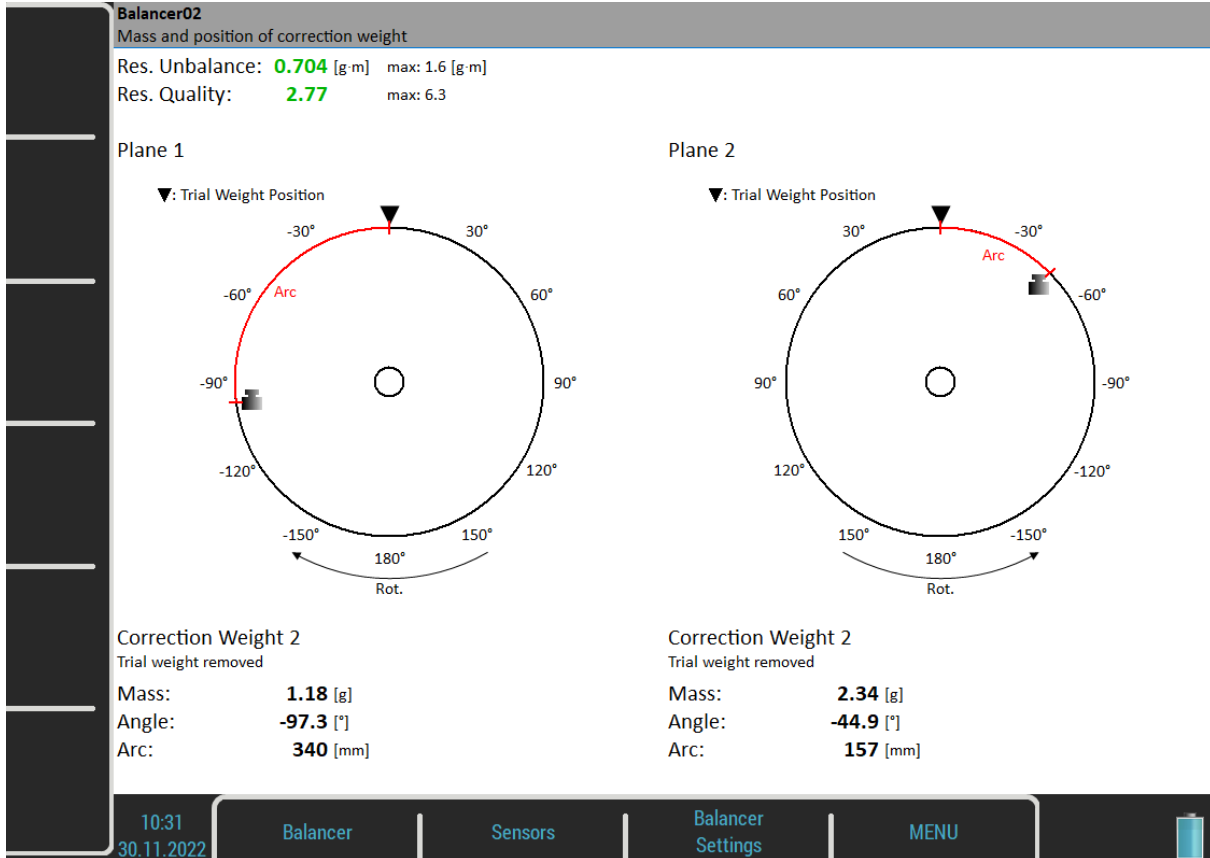

Balancing Errors

Balancing errors and warnings can occur during the job.

The effect of trial weight is low

This message informs you that the effect of the trial weight is low.

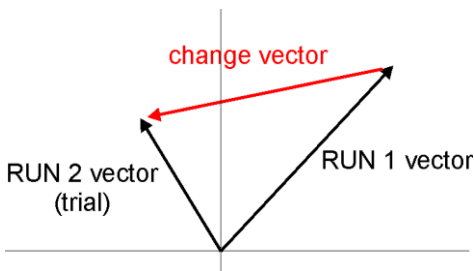

The percentual value is derived from ratio (amplitude of change vector/ amplitude of Run1 vector).

A warning is displayed when the change is less than 20% but bigger than 1%. You can continue with balancing after this warning and use these values.

An error is displayed when the change is less than 1%. You cannot continue with balancing after this error, because such a small change is not acceptable. You could get incorrect results.

Unacceptable speed change

The balancing procedure must be executed on constant speed during all runs. The balancing speed is checked and when it changes more than 5% the error occurs.

Unstable phase

The phase stability can be checked only if the averaging is used ([Basic Settings / Avg](#)). If the phase during averaging changes, this probably means the unbalance is not the main problem of the machine. Thus, the error is indicated and the balancing procedure stops.

Balancer Menu

Next functions are available for opened project. Push the **Balancer** button and the menu with additional functions appears.

Balancing Report

Create balancing report in rtf format and save it to *VA5_DISC* to a *VA4balancer_protocol* folder.

Balancing Vectors

Create a drawing of amplitude / phase vector development during the balancing process. The drawing is also included to the balancing report.

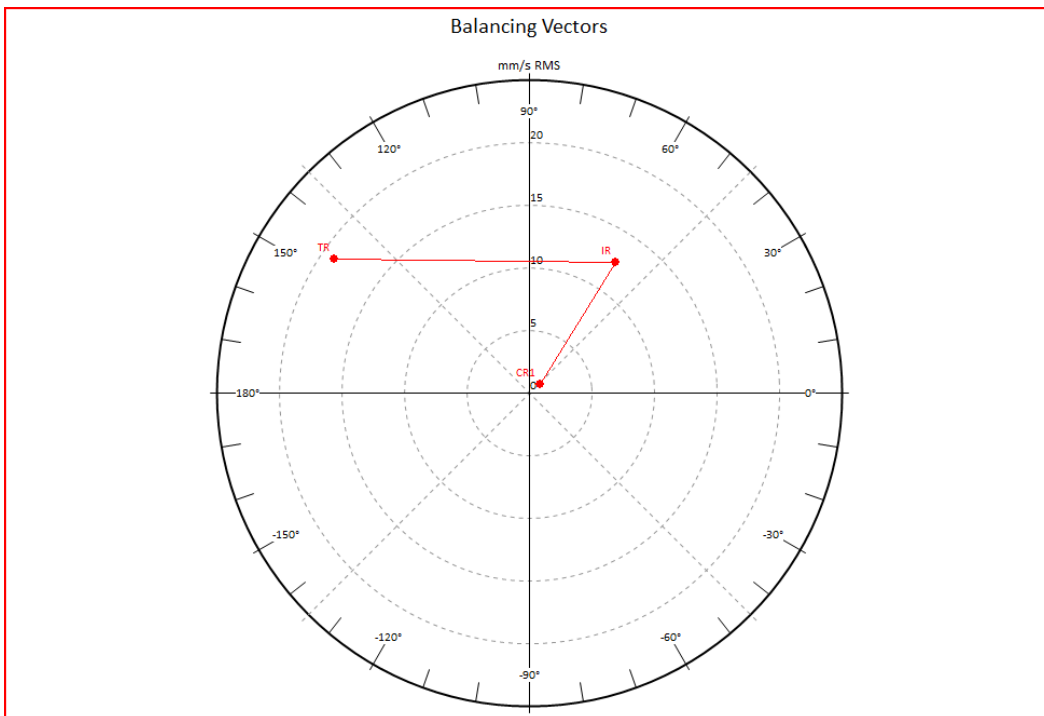

IR Initial Run
TR Trial Run
CR Correction Run

Total Mass

Displays the total balancing mass. It is a vector sum of all masses mounted to the rotor (all correction weights and kept trial weights).

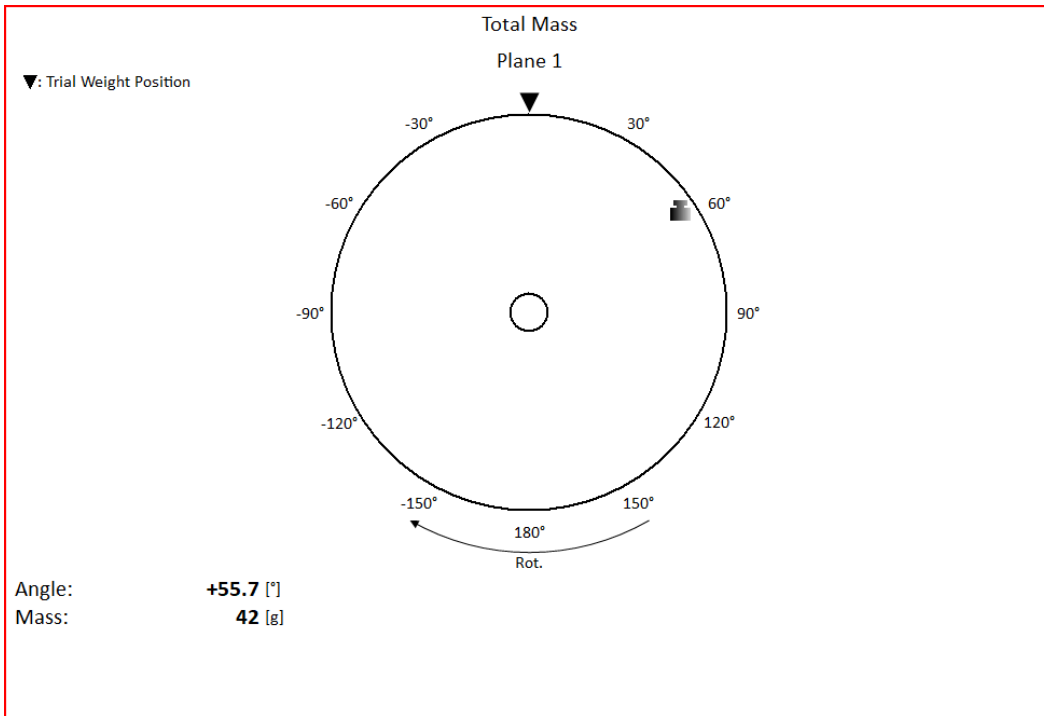

Advanced Balancer

This module supports advanced balancing process. It enables balancing on up to eight planes. Moreover, it enables the number of measurement points to be greater than number of planes. This is useful in situations when not all planes are accessible for trial mass mounting.

Project

Like in the previous [Balancer](#) module, the balancing job is organized as a project. The project contains all entered parameters of the balancing procedure and all measured or entered data.

The typical balancing job scheme looks similar like in the [Balancer](#) module:

- Create new project.
- Enter balancing parameters (type of machine, number of planes etc.).
- Initial measurement of vibration amplitude and phase on required measurement points.
- Put trial weight on the rotor. Step by step to all planes.
- Trial weight response measurement. Step by step to all planes.
- Put correction weights on all planes.
- Check of effect (success).
- Trim measurements for additional weights and better results.

Every step is displayed in one screen. The movement between screens is provided by **Up / Down** arrows.

Attention! When you return back in the job screens and you take a repeated measurement or enter a new value, then the measured data will be erased in all screens after actual screen. The reason is simple. The implications are derived from every screen to the next screens. When you repeat the measurement, you change the parameters for those implications. That is why all next screen implications must be removed and you have to make all necessary measurements again.

Project List

The list of saved projects opens when you enter the module. The list is empty if you have no saved projects yet. The modification time stamp of the selected project is displayed in the status bar in the bottom right corner.

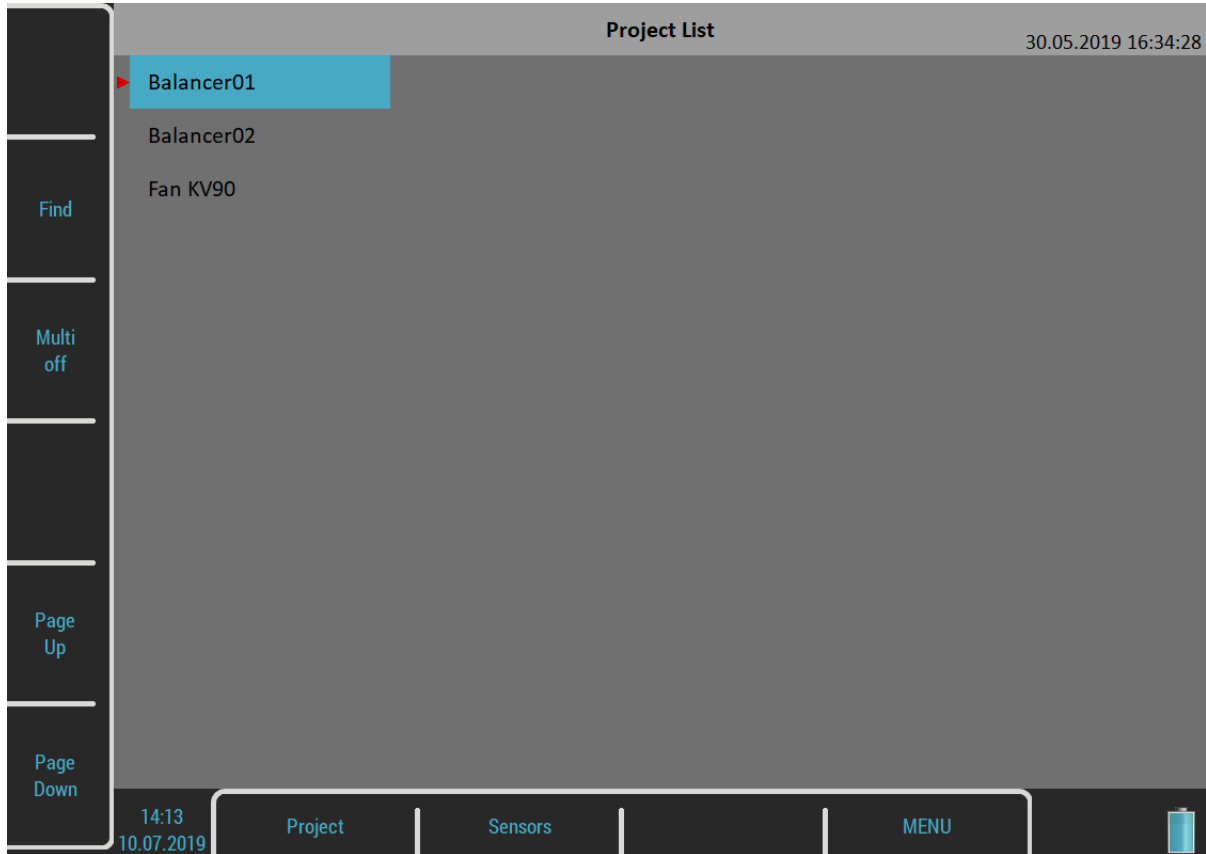

Project Menu



New

Creates a new project with default properties.

Copy

Creates a new project as the copy of selected project. Only the header data are saved. No measured data are saved.

Rename

Renames the selected project. The project with old name does not exist anymore.

Delete

Deletes selected project.

Clear Data

Erase all measured data, only the project header remains.

Export

Exports selected project to *VA5_DISC*.

Balancer Settings

Settings menus automatically open when you open a project which has no data yet. Later, you may open the menus using the **Balancer Settings** button. There are two separate menus under this button, [Basic Settings](#) and [Units Settings](#).

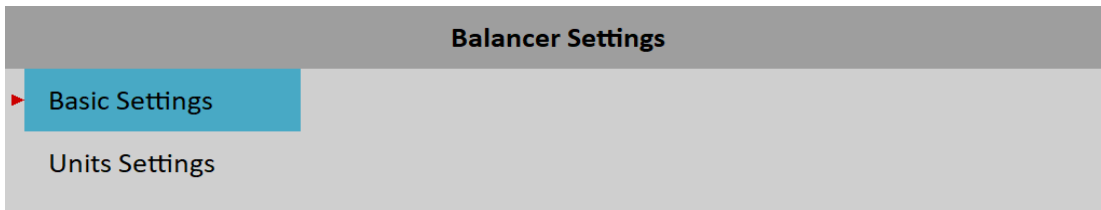
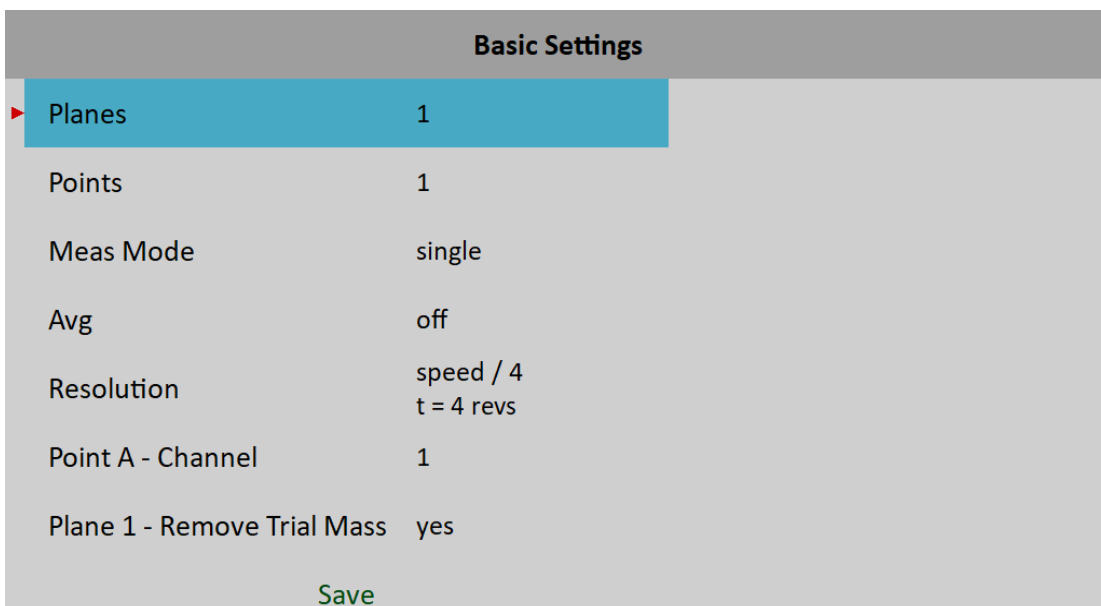
**Basic Settings****Planes**

Number of balancing planes.

Note! Planes are marked with numbers, Plane 1, Plane 2 etc.

Points

Number of measurement points. Must be greater or equal to number of balancing planes.

Note! Points are marked with letter, Point A, Point B etc.

Meas Mode**single, online meter**

When you start a measurement process by pushing *Enter*, then only one value can be taken (**single**) or the continual measurement values could be displayed (**online meter**). In **online meter** mode you can look at more

values and to evaluate the changing of them in time. You need to stop the measurement by pushing *Escape*, when is displayed the value, which you want to use.

Avg

The averaging of more than one measured value is available

Resolution

It's the aps measurement resolution described in [Analyzer](#) / [Edit Measurement](#) / [Resolution](#).

Point A - Channel, Point B - Channel, ...

The AC input for each point.

Note! The measurement points marking A and B has only the symbolic sense. It has no relation to the balancing planes 1, 2 and to the balancing computational procedure. You can mark any point as A any other as B and so on.

Since it is possible to use up to eight measurement points and the instrument contains only four AC inputs or you can use even less sensors, you may sometimes need to use one AC input for more points. You can setup same channel repeatedly for more points. Then, the points are divided into groups such as no AC input is used twice during one measurement process. A point where the channel is already used in previous group is a beginning of a new group.

E.g. You want to use six measurement points and you have only two sensors connected to AC1 and AC2. You enter:

- Point A - Channel: 1
- Point B - Channel: 2
- Point C - Channel: 1
- Point D - Channel: 2
- Point E - Channel: 1
- Point F - Channel: 2

And the points will be grouped as A with B as first group, C with D as next group and E with F as last group.

In a run screen which will be explained later the group of points which is going to be measured is marked by asterisk *. Points A and B on next picture are to be measured after you push *Enter* button.

Point	A*	B*	C	D	E	F
Channel	1	2	1	2	1	2
Amplitude [mm/s 0-P]						
Phase [°]						

The marked group is automatically switched after the measurement is completed. Or you can switch it manually by pressing a **Shift (*)** button.

	Point	A	B	C*	D*	E	F
Channel		1	2	1	2	1	2
Amplitude [mm/s 0-P]							
Phase [°]							

Edit

Shift
(*)

Note! You can change the channel numbers anytime during balancing procedure by tapping the channel display. You don't need to open the menu.

Note! The number of channel can be set as **off**. Then, this point is not included to any group and therefore is not measured.

Plane 1 – Remove Trial Mass, Plane 2 – Remove Trial Mass, ...

yes, no

You can enter if you remove or not a trial mass on each plane.

Units Settings

Units Settings	
▶ Amplitude	mm/s
Detect Type	RMS
Speed	RPM
Mass	g
Save	

Amplitude

Selection from available units for used sensor

Detect Type

RMS, 0-P, P-P

Detect type for amplitude value

Note! This value is same as global value defined in [MENU / SETTINGS / Spectrum Settings / Detect Type](#) until you change it here. That means, if you change the global value it will be changed here also. This will stop after the first time you enter a value here.

Speed

Selection from available units for speed

Mass

Selection of unit for mass

Balancing Procedure

Let's describe the balancing procedure on example of two planes and four points which should clarify the procedure in general for any possible combination of number of planes and points.

Create a new project using menu [Project / New](#). Enter the name, e.g. **Bal2x4**.

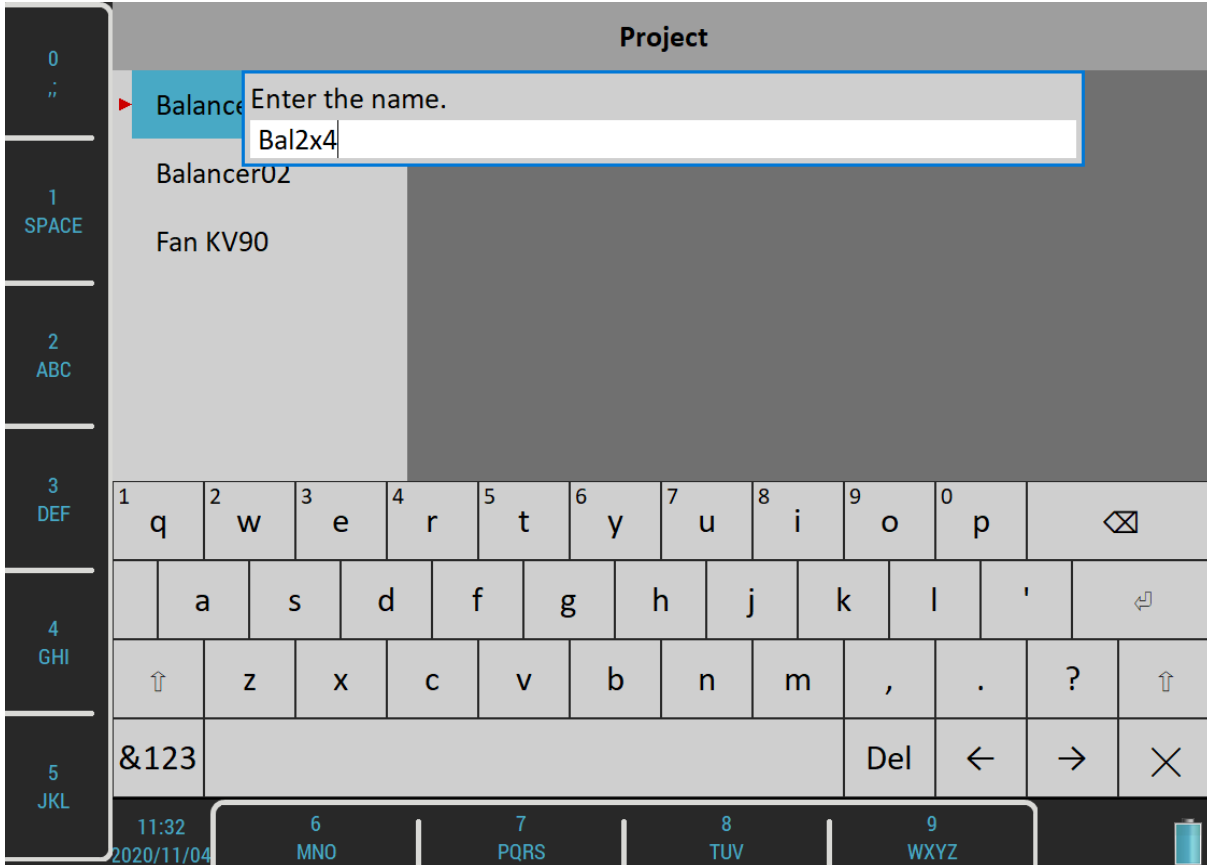

Open the project. Since the project has no data yet, the [Basic Settings](#) menu appears. In the menu, enter [Planes](#) value as 2 and [Points](#) value as 4. Let's suppose we are using two AC sensors mounted on inputs AC1 and AC2. Therefore, enter the points channels as 1 for Point A and Point C and as 2 for Point B and Point D. Other values can stay on defaults.

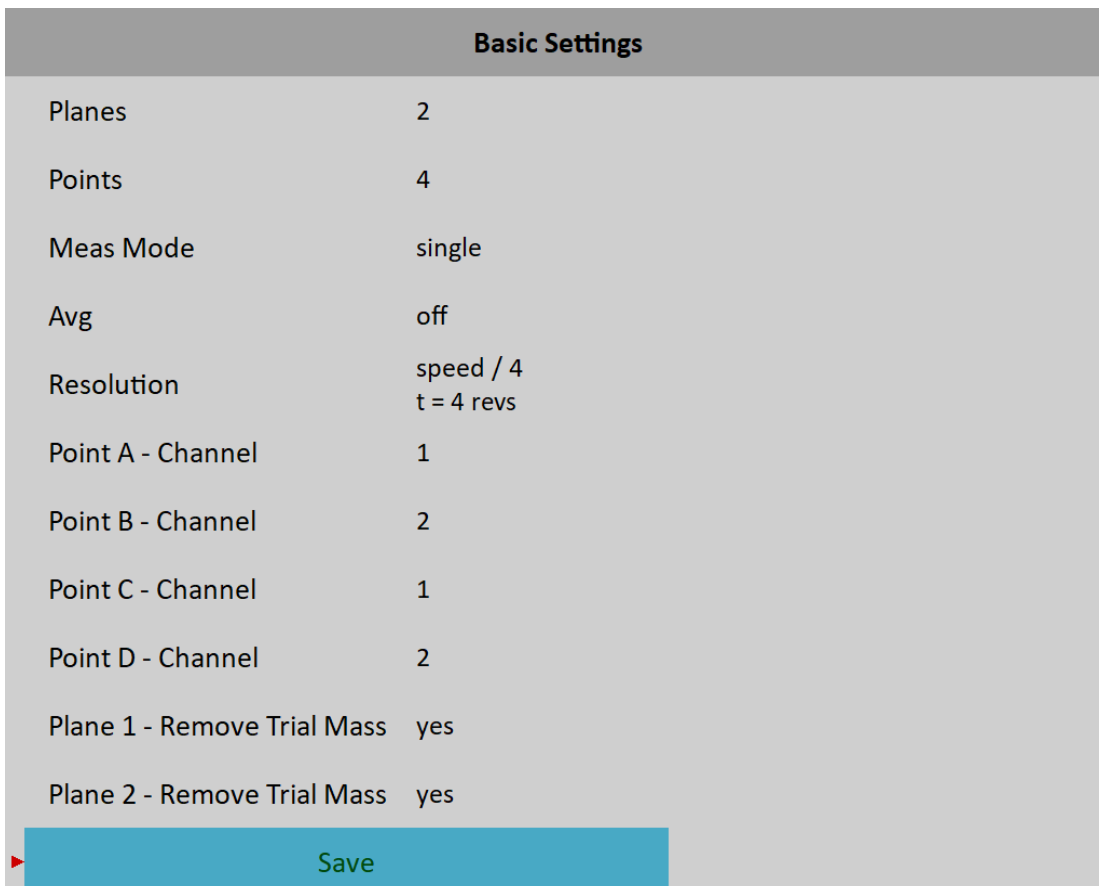

Confirm the [Basic Settings](#) menu. The [Units Settings](#) menu appears. Let's confirm the default values.

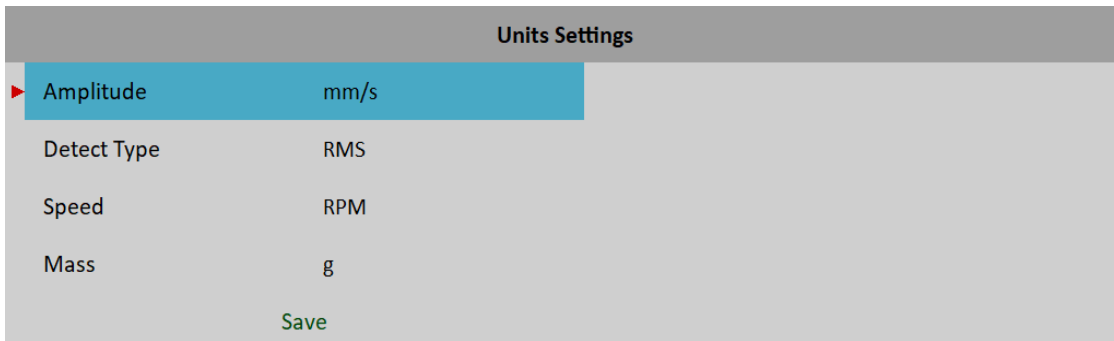

Initial Run

After we have entered and confirmed all parameters, the **Initial Run** screen appears.

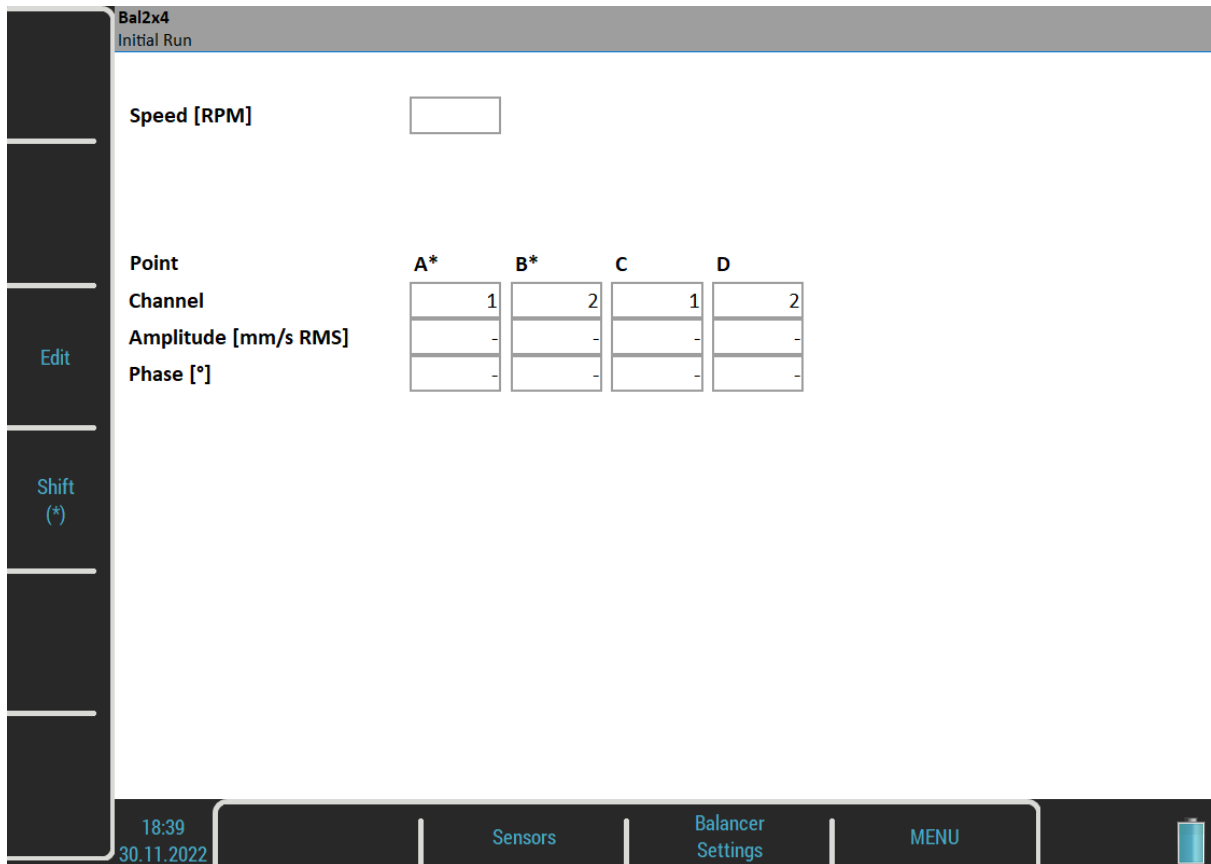

Now you need to make **Initial measurement**. Points A and B are marked to be measured as has been described in the [Basic Settings](#) / [Point A - Channel, Point B - Channel, ...](#). Remember to mount sensors to correct measurement points on the machine. Start measurement process on marked channels by pressing **Enter/Start** button.

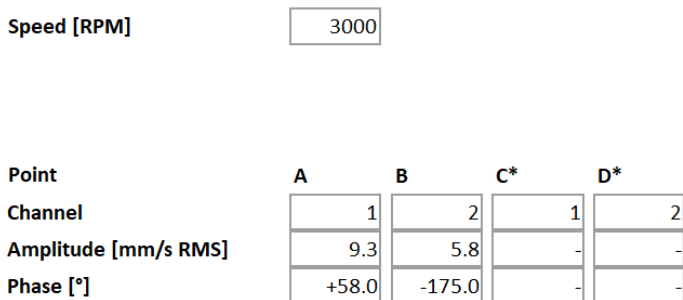

After you have finished the measurement on marked points, marks automatically shift to next points. Remount sensors and start the measurement again.

Speed [RPM]

Point	A	B	C*	D*
Channel	1	2	1	2
Amplitude [mm/s RMS]	9.3	5.8	5	3.9
Phase [°]	+58.0	-175.0	-104.0	+12.0

Now, all measurements of Initial Run are completed. Marked points stay as they are so as you can continue without sensor remounting on next run. You can still change the marked points anytime using the **Shift (*)** button.

Note! The speed value is displayed only on first screen. However, the speed is checked during all measurements and when it differs the balancing procedure is stopped.

Note! The values don't need to be measured. You can push the **Edit** button and enter all values manually (balancing calculator function). You can start the value editing also by tapping on any value display. Entries continue automatically on other displays until the last value is entered or the *Esc* key is pressed.

Note! You can change the channel numbers anytime during balancing procedure by tapping the channel display.

Press **Down** button to continue to next run.

Trial Runs

Bal2x4
Trial Run 1

Trial Weight in Plane 1

Mass [g]

Angle [°]

Remove Trial Weight

Point	A	B	C*	D*
Channel	1	2	1	2
Amplitude [mm/s RMS]	-	-	-	-
Phase [°]	-	-	-	-

18:49
30.11.2022

Sensors Balancer Settings MENU

The procedure continues with measurements with trial mass on all planes. First, enter the trial weight mass and angle by pushing the **Enter Trial Weight** button or tapping the *Trial Mass* display. See [Balancer / Single Plane Balancing / Trial Run](#) for more details about trial weight mounting.

Remember to mount the weight to appropriate plane. By default, you don't need to remount sensors because marked points have stayed as you used them in the end of previous run. However, you can remount them and push the *Shift (*)* button if you need. Take all measurements gradually same way as on [Initial Run](#).

Note! You may also change the *Remove Trial Mass* value by tapping the display. You must do it before the measurement.

Trial Weight in Plane 1

Mass [g]	100
Angle [°]	+0.0
Remove Trial Weight	yes

Point	A*	B*	C	D
Channel	1	2	1	2
Amplitude [mm/s RMS]	3.1	1.5	3	7.8
Phase [°]	+59.0	-162.0	+54.6	+15.3

After all points measurements are taken, you should resolve the trial weight according to the **Remove Trial Weight** setup.

In case of *Remove Trial Weight* is set as **yes**, next question will appear:

Temporarily keep trial weight in plane 1 also during measurements with trial weight in next planes?

If you answer *No*, then you must remove the trial weight as expected. However, you can answer *Yes* and keep the trial weight on plane 1 also during measurements with trial weight in next planes. This can be useful, when you want to use the trial weight as the zero mark for correction weights mounting.

In case of *Remove Trial Weight* is set as **no**, next notification will appear.

Keep trial weight in plane 1!

Push the *Down* button. Repeat same steps for all planes (one more times in our case of two planes).

Trial Weight in Plane 2

Mass [g]	100
Angle [°]	+0.0
Remove Trial Weight	yes

Point	A*	B*	C	D
Channel	1	2	1	2
Amplitude [mm/s RMS]	3.1	4.3	1.3	4.1
Phase [°]	-162.0	+11.6	+55.6	-64.0

Now, you have done all needed measurements for correction weight calculation.

Result Screen (Option: number of points is greater than number of planes)

After entering the result screen, you will be notified to keep or remove the trial weight from the last trial plane according to its *Remove Trial Weight* setup. In case you temporarily kept a trial weight on any of previous planes, you'll be also notified to remove it now.

Remove trial weight from plane 1!
Remove trial weight from plane 2!

Don't forget to remove the trial weights if needed. However, you can use them as zero mark first and remove them after correction weights mounting.

Bal2x4 Mass and position of correction weight				
Plane	1	2		
Mass L2 [g]	74.7	70.7		
Angle L2 [°]	+14.0	-13.7		
Mass L ∞ [g]	77	70		
Angle L ∞ [°]	+16.3	-13.0		
Residual Vibrations [mm/s RMS]				
Point	A	B	C	D
L2	1.79	1.49	1.32	1.51
L2 5%	2.23	1.86	1.68	1.94
L2 10%	2.67	2.23	2.03	2.38
L2 20%	3.54	2.96	2.74	3.24
L ∞	1.56	1.56	1.56	1.56
L ∞ 5%	2	1.93	1.92	1.99
L ∞ 10%	2.44	2.3	2.28	2.42
L ∞ 20%	3.32	3.04	3.01	3.29

19:51
30.11.2022

Sensors Balancer Settings MENU

In case the number of points is greater than number of planes, there remain some residual vibrations on each point. You are not able to get zero on all points. There could be many ways how to optimize these residual vibrations. However, there are two ways which are meaningful. You can minimize the L2 or L ∞ norm of vector of residual vibrations.

Let's write the vector of residual vibrations as:

$$\text{res} = (\text{res}_1, \text{res}_2, \dots, \text{res}_{\text{number of points}}),$$

then the L2 norm of vector of residual vibrations is defined as:

$$\|\text{res}\|_2 = \sqrt{\text{res}_1^2 + \text{res}_2^2 + \dots + \text{res}_{\text{number of points}}^2}$$

and the L ∞ norm of vector of residual vibrations is defined as:

$$\|\text{res}\|_\infty = \max(|\text{res}_1|, |\text{res}_2|, \dots, |\text{res}_{\text{number of points}}|)$$

Then, minimizing the L2 norm means you want the sum of squares of residual vibrations to be as low as possible. In other words, this is the least squares method. Minimizing the L ∞ norm means you want the maximum amplitude of all residual vibrations to be as low as possible.

The instrument offers you both result with smallest L2 and L ∞ norm. You can choose which is more convenient to you. The weights and positions of the resulting correction weights for both norms for each plane are displayed in the upper part of the screen.

Plane	1	2
Mass L2 [g]	74.7	70.7
Angle L2 [°]	+14.0	-13.7
Mass L ∞ [g]	77	70
Angle L ∞ [°]	+16.3	-13.0

The residual vibrations for both norms for each point are displayed in the lower part of the screen.

Residual Vibrations [mm/s RMS]

Point	A	B	C	D
L2	1.79	1.49	1.32	1.51
L2 5%	2.23	1.86	1.68	1.94
L2 10%	2.67	2.23	2.03	2.38
L2 20%	3.54	2.96	2.74	3.24
L ∞	1.56	1.56	1.56	1.56
L ∞ 5%	2	1.93	1.92	1.99
L ∞ 10%	2.44	2.3	2.28	2.42
L ∞ 20%	3.32	3.04	3.01	3.29

The L2 line shows you residual vibrations of the L2 result. The L ∞ line shows you residual vibrations for the L ∞ result.

Moreover, there are three more lines for each norm. They represent residual vibrations in case you mount the balancing mass with 5%, 10% or 20% inaccuracy. This gives you the information about the sensitivity of the residual vibrations to the mounting position. If the values increase a lot on next lines, you can say that the system is very sensitive to the balancing mass position and you should be careful while mounting it.

Note! See [Global Settings / Angles Counting](#) and [Balancer / Single Plane Balancing / Result](#) for more details about correction weight angles.

Result Screen (Option: number of points equals number of planes)

Bal2x2
Mass and position of correction weight

Plane	1	2
Mass [g]	98.2	102
Angle [°]	-1.2	+4.0

Residual Vibrations [mm/s RMS]

Point	A	B
5%	2.84	1.12
10%	5.68	2.24
20%	11.4	4.48

19:57
30.11.2022

Sensors Balancer Settings MENU

In case the number of points equals number of planes, there are of course no residual vibrations. You don't need to minimize them because they all are zero. Therefore, there is just one result. However, it still makes sense to show the residual vibrations representing the sensitivity to the balancing mass position.

Correction Run

When the mass or masses are mounted to the planes you should take one more measurement where you check the effect of the balancing mass. Push the *Down* button and perform the measurement in a known manner.

Bal2x4
Correction Run 1

Point	A*	B*	C	D
Channel	1	2	1	2
Amplitude [mm/s RMS]	2.1	1.7	1.5	1
Phase [°]	+60.0	+125.0	+59.0	+99.0

19:59
30.11.2022

Sensors

Balancer Settings

MENU

You can continue (push *Down* button) with the job when you are not satisfied with the results. These next steps do not require trial mass measurements already. After each measurement the next correction weights are recommended. However, when the result is not better (or even is worse) the next correction runs have no sense.

Balancing Errors

Errors and warnings can occur during the balancing job as described in the [Balancing Errors](#) chapter in [Balancer](#) module.

Balancer Menu

Next functions are available for opened project. Push the **Balancer** button and the menu with additional functions appears.

Balancing Report

Create balancing report in txt format and save it to *VA5_DISC* to a *VA4balancer_protocol* folder.

FASIT

The FASIT means the **FA**ult **S**ource **I**dentification **T**ool. This mode should help beginners to determine the machine condition or bearing faults.

Adash Vibration Limits

Because there are a lot of different types of machines it is impossible to determine the critical limits of vibrations for wide range of machines. Its reliability would be low then. It could happen, you will repair machine, which do not require it. The standards should be rather determined for a narrow range of machines.

The instrument uses the Adash limit values. These limits are not rewritten from any existing standard. It's a result of many years of Adash engineering team experiences. It's difficult to invent critical value definition which would be simple (that means not many parameters such as speed, power, bearing type, machine type and so on) and reliable.

On the figures below is clear how we derived limit values. Three levels of machine condition are defined: GOOD, WARNING (Machines lays in this range are not acceptable for a long period operation, they could be operated till time when could be repaired) and DANGER (Vibration values in this range are considered as very dangerous and they can cause a damage of the machine). The corresponding colors are taken from traffic semaphore - green, amber and red.

All limit values are related to the speed value. The low-speed machine should generate lower vibration then higher-speed machine.

In the graphs area you found three particular areas. The GOOD condition is the space bellow the yellow line that means operation without restriction. The space above yellow but under red line is an WARNING condition. Possible to operate the machine but have to be more checked. It's necessary to determine the source of worse condition and plan repair (for instance change the bearing) or maintenance (balancing, alignment). The space above red line is a DANGER condition and the machine should not be operated.

First figure contains the values for overall machine condition and you search unbalance, misalignment, and mechanical looseness above all. They are called "overall" because we can measure them on most of the measuring points. Second figure contains the limit values of a roller bearing condition. This condition is local and can be measured only on appropriate bearing house.

Work with figures is simple. It's necessary to know the speed. Instrument determines it automatically or user can enter it manually. On the bottom horizontal axis, you should find the point which corresponds with speed. Above this point you will find an intersection with yellow and red line. Projections to the vertical axis will determine limit values for yellow or red state. If the measured value is lower than yellow the condition is GOOD – green. If the value is above yellow but under red then the condition is WARNING – yellow. If the value is higher than red line then the condition is DANGER – red.

Machine Limits

The machine limits are used for velocity RMS value in 10-1000Hz frequency range. This value helps to define the complete health of machine.

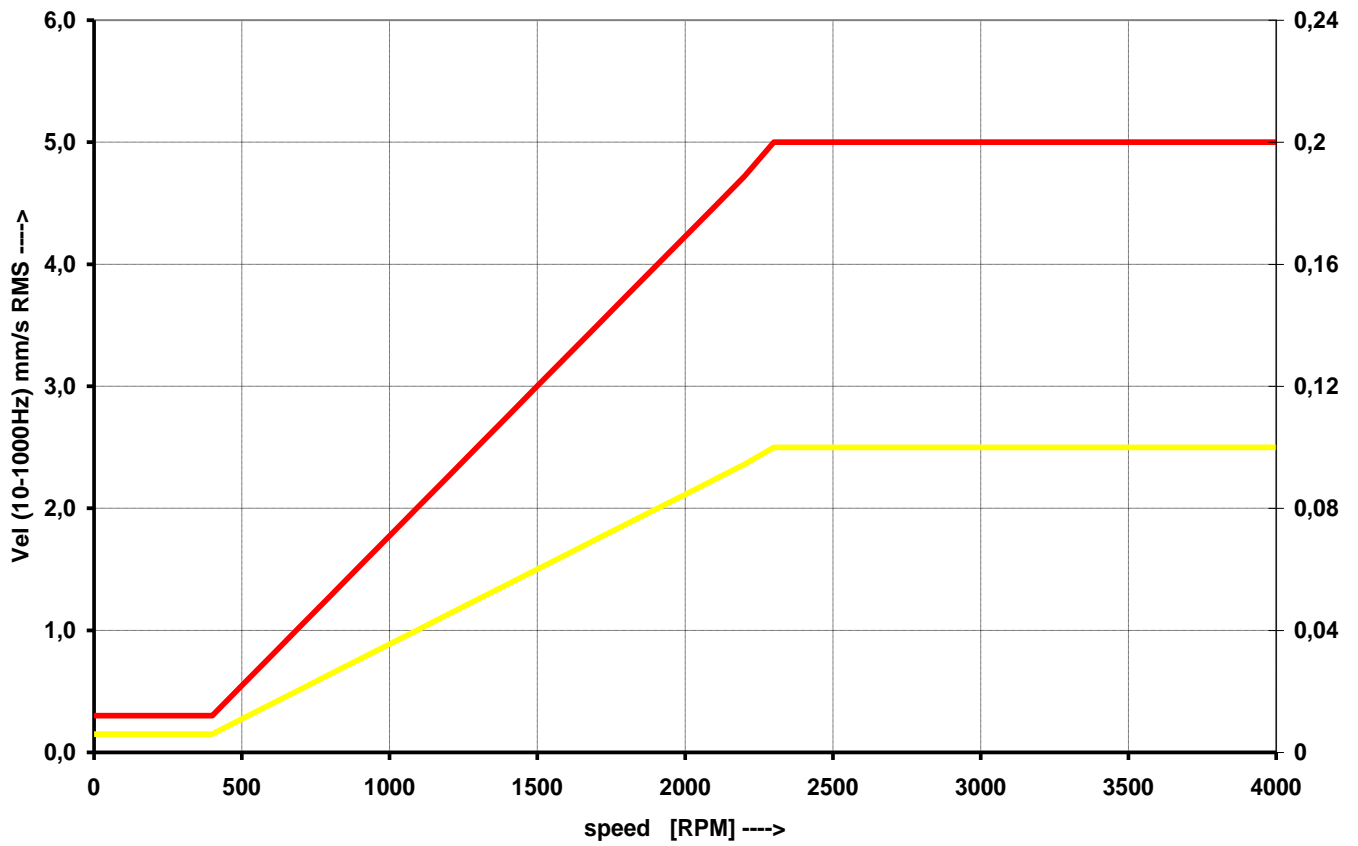

Bearing Limits

The roller bearing limits are used for acceleration RMS value in 500-25600Hz frequency range.

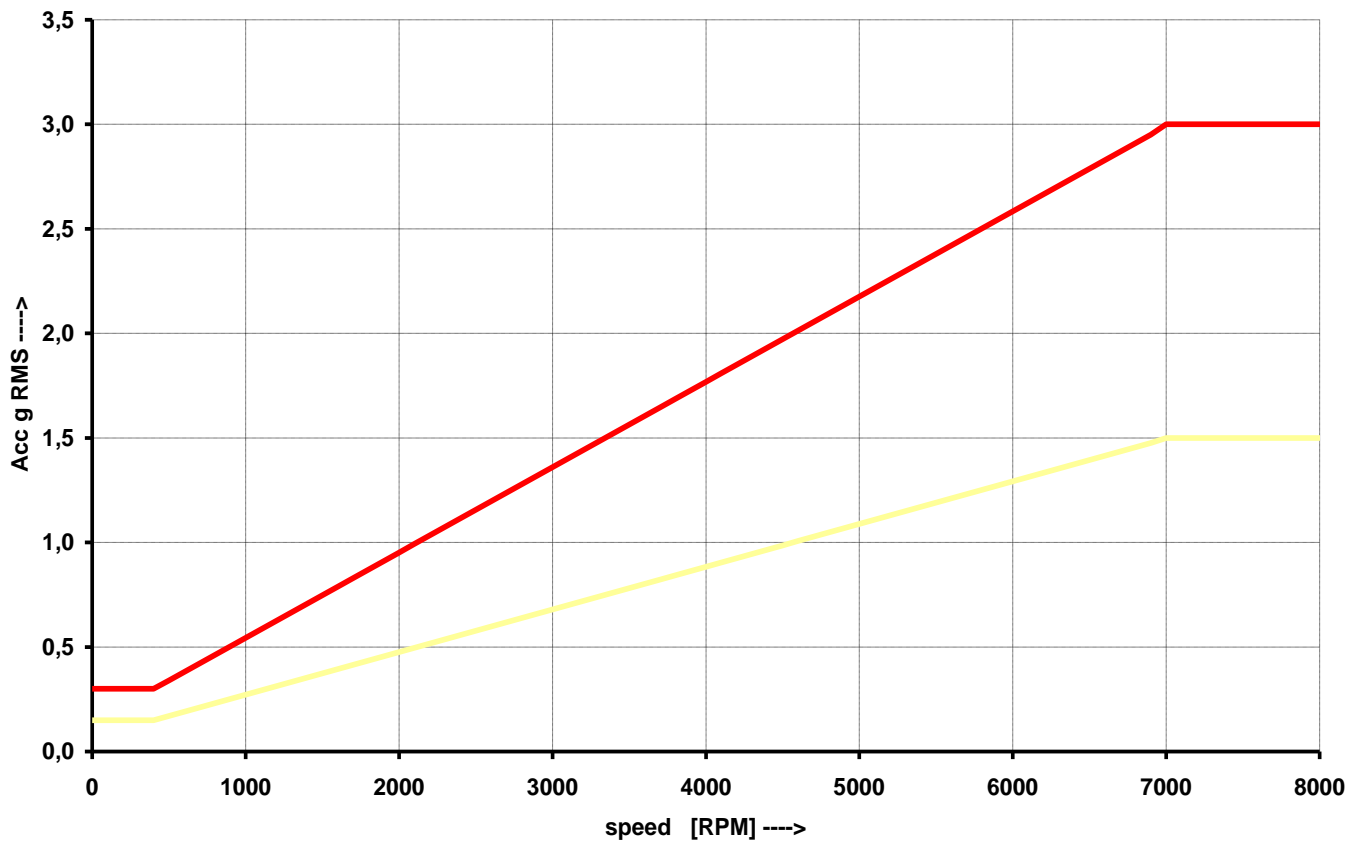

FASIT Settings

The menu automatically opens after you enter the FASIT module. The menu can be repeatedly opened by the **FASIT Settings** button.

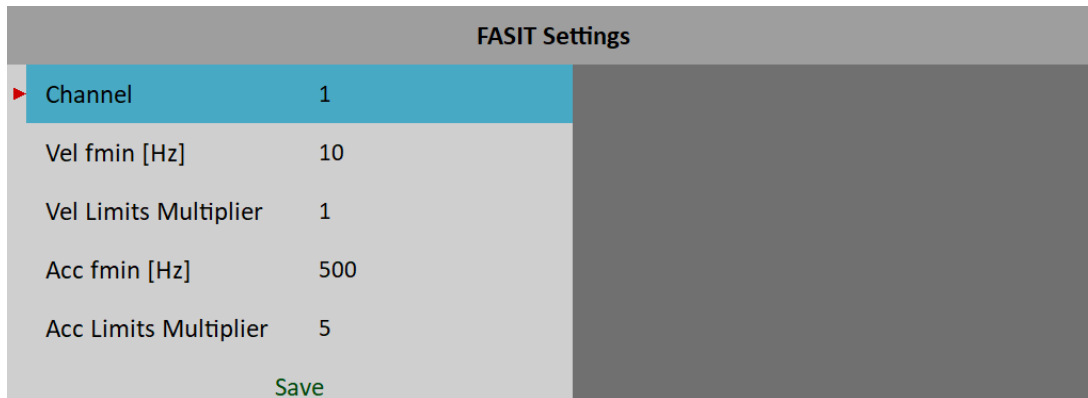

Channel

The number of the input channel

Vel fmin [Hz]

By default, the velocity measurement is taken in 10 – 1000 Hz range to detect the overall machine condition. This range is not convenient for low-speed machines (below 10 Hz = 600 RPM). Therefore, you can setup lower value of fmin.

Vel Limits Multiplier

FASIT uses [Adash Vibration Limits](#), according to which alarms are displayed. The factory [Machine Limits](#) may be too or too little strict for some machines. Therefore, for velocity measurements, you can adjust them using the *Vel Limits Multiplier*. Values greater than one increase the limits values and values less than one decrease them. A value of one means the limit remains as shown in the machine limits graph.

On following figures, you can see the effect of the multiplier. The first machine condition bar shows an alarm when the multiplier is set to 1. The second bar shows the same measurement, however this time the multiplier is set to 2, which means the limit value is twice as high as before. This means that FASIT is less strict and the alarm level is twice lower. The third case shows the situation with the multiplier set to 0.5.

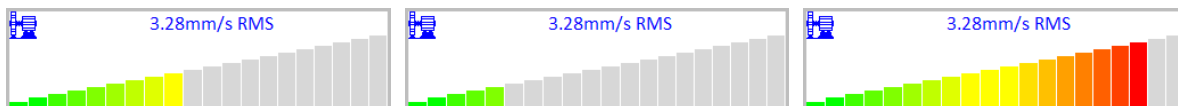

Acc fmin [Hz]

By default, the acceleration measurement is taken in 500 – 25600 Hz range to detect bearing faults. Using the Acc fmin you can change the minimum frequency of the filter. E.g., in some cases, there may be vibrations above 500 Hz which are not caused by bearing faults and you know it. Then, you can set the Acc fmin value to 5000 Hz to filter these vibrations out.

Acc Limits Multiplier

Same as [Vel Limits Multiplier](#) but used for [Bearing Limits](#).

Sensor Settings

In the [Sensors](#) menu, set the parameters of the used sensor. FASIT measures acceleration and velocity from one channel. If you will use a velocity sensor, the bearing condition is not detected. For bearing condition detection the acceleration measurement is necessary.

Units

Vibration values are displayed in units according to [Global Settings / Units](#).

metric

- acceleration – g
- velocity – mm/s

imperial

- acceleration – g,
- velocity – ips

Measurement

Push the *Enter* button to start the measurement. The speed needs to be known for the processing. The speed detection is described in the [Speed detection](#) chapter.

FASIT screen

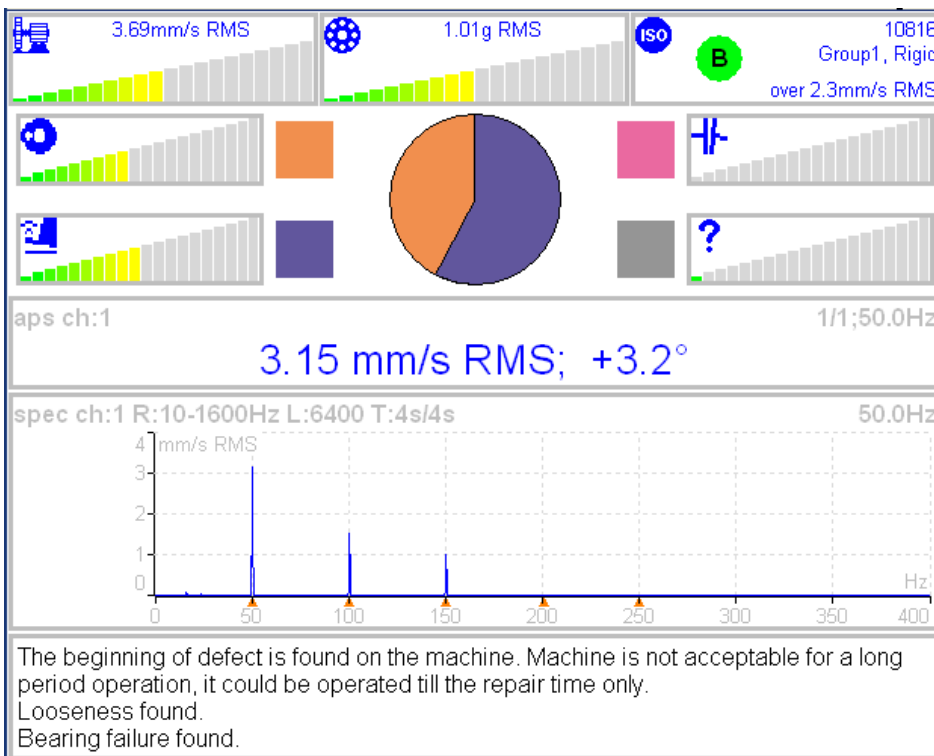

Each horizontal bar displays the severity of individual item. It starts from green color on the left to the red on the right.



The machine condition bar, see the Machine limits description above.



The bearing condition bar, see the Bearings limits description above.



The Unbalance severity level.



The Looseness severity level.



The Misalignment severity level,



The severity level of a different type of a fault.

 ISO 10816 limits (see the ISO overall measurements), the color of circle is related to the machine condition class A, B, C, D (the green for A or B, the orange for C and the red for D). Also, the information about machine group and foundation are displayed. The limit which is exceeding is also displayed at the bottom.

The pie chart displays the percentages of severity of individual faults. The colors in pie chart correspond to the colors of the rectangle next to the individual graphs.

The 1x amp+phase value and velocity spectrum with speed and harmonics (marked by red triangles) are displayed in the middle of screen.

Note! the 1x amp+phase value is displayed only when the speed is measured by a tachometer probe.

The condition report and advises are in the bottom.

Stethoscope

This module enables listening of vibrations. Use the standard headphones and connect them to the audio output on top panel.

Enter the Stethoscope module. Four displays appear. Push *Enter*. Each input signal level will be displayed.

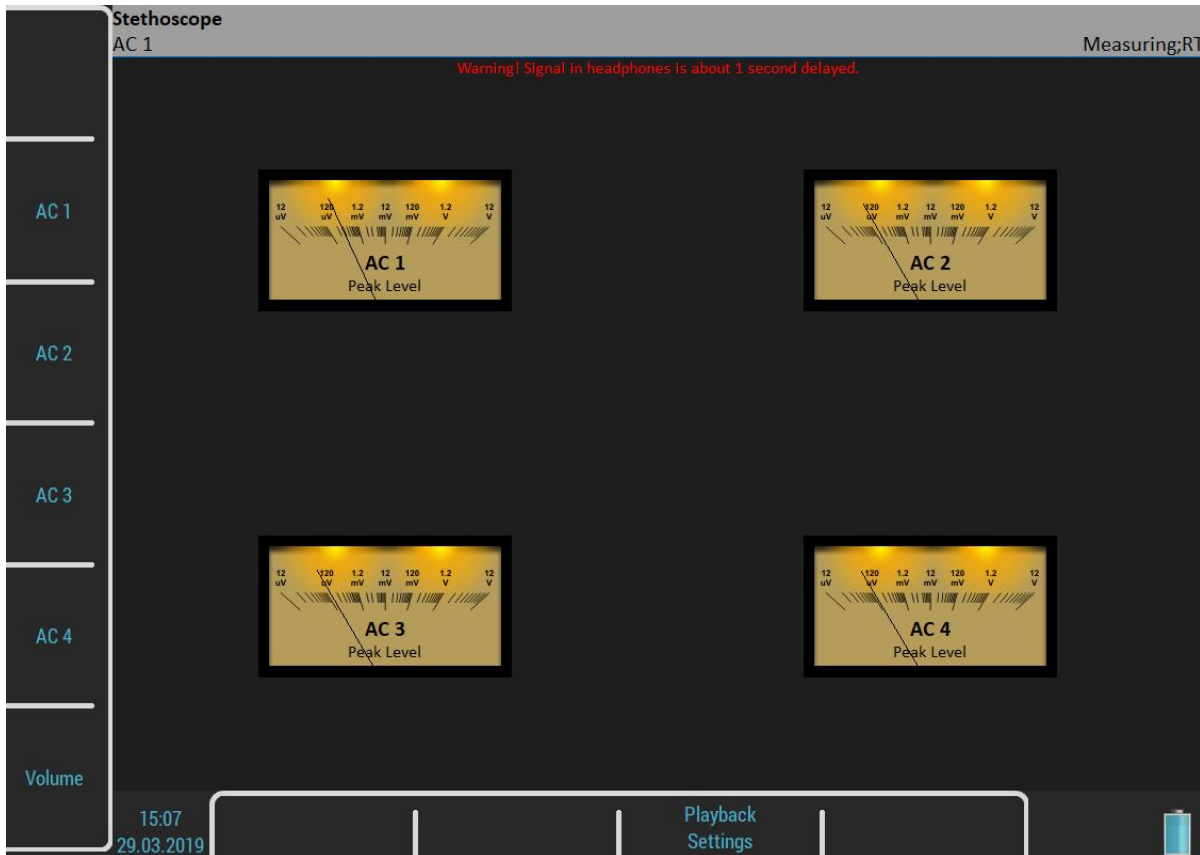

The **TRUE PEAK** level is displayed. By buttons on the left side you choose the channel for listening. The selected channel is written in the status bar.

The **Volume** button changes the buttons mode to volume regulation.

The delay of audio output

Because all signal conditioning is digitally arranged, the delay of signal appears. Typically the delay is 1 second. You can clearly test to knock to the sensor and you will hear this knock after the delay time.

Playback Settings

For playback settings push **Playback Settings** button.

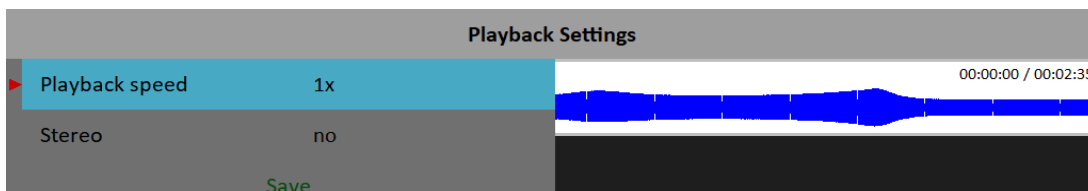

Playback speed

This function is available only when a record is listened. It speeds up (bigger than 1) or slows down (lesser than 1) the playback speed.

Stereo

yes, no

It enables to define two channels for playback, one channel for the left headphone and second for the right one. The current setting of left/right output is displayed on status line on the left top (**L: AC 1, R: AC 2**). The **Left** note in the bottom left corner says that you setup the left channel in this moment. Push the **AC1 – AC4** to change the number of the left channel. Push the **Left/Right** button and the **Left** note changes to **Right**. Then the **AC1 – AC4** buttons enable to setup the number of the right channel.

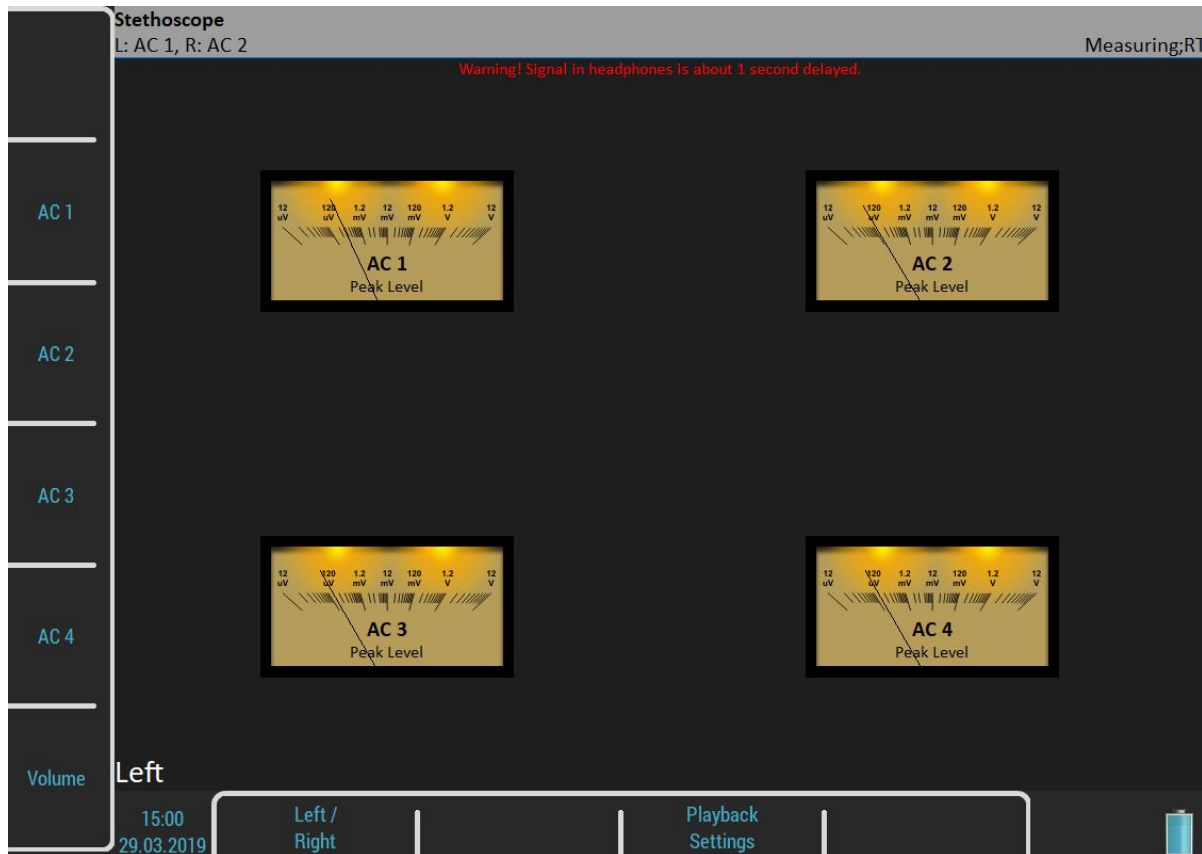

Lubri - the greasing control

There is an increasing demand for an instrument which is able to simply check lubrication of rolling bearings and also the condition of these bearings.

Every machine does have in its specifications how much lubricant every one of its bearings uses in a specific amount of operational hours. A task of each technician or engineer is to regularly check all the lubricated points and maintain lubricant at sufficient levels. Either state, lack or excess of lubricant are harmful for a rolling element bearing. The result is always excessive stress on the bearing and consequently excessive wear. Every lubricating point has a lubrication time interval (in hours of service) and also an amount of lubricant that needs to be replenished. This manner of lubrication control has a significant disadvantage.

The amount of lubricant that any bearing actually needs for proper operation changes during its lifetime. Longer lubricating intervals in the case of a new machine are usually not sufficient for a machine after several years of operation.

It is clear that it would be useful to be able to determine a state of a bearing somehow and replenish only as much lubricant as is actually needed. Controlled lubrication increases bearing service life and lowers costs for lubrication and repairs.

The main use of this Lubri module is in the lubrication replenishment process. During this process the instrument measures the actual lubrication condition of a bearing and tells the operator when the amount of lubricant is ideal. This way it is ensured that we do not under or over lubricate. This module exactly determines the ideal amount of lubricant needed.

As a result, your machines will be maintained in their best lubrication condition. The Lubri module enables you to make the whole lubricating process simpler and it normally reduces the consumption of very expensive lubricants.

You can find more detailed information about lubrication in the A4910 – Lubri manual.

Two Ways How to Mount a Sensor

A standard accelerometer mounted on a bearing housing is used to measure lubrication.

You have two possibilities how to do this:

1. ***The sensor is mounted on a lubrication head.***
This option enables a quick service since the lubrication head is transferred together with the sensor. The disadvantage is a partial loss of sensitivity, since the lubrication head attenuates the measured signal.
2. ***The sensor is mounted next to lubrication point on a bearing housing (measurement pad recommended).***
This option enables a perfect measurement. The disadvantage is a longer preparation, since the lubrication head and sensor must be mounted separately.

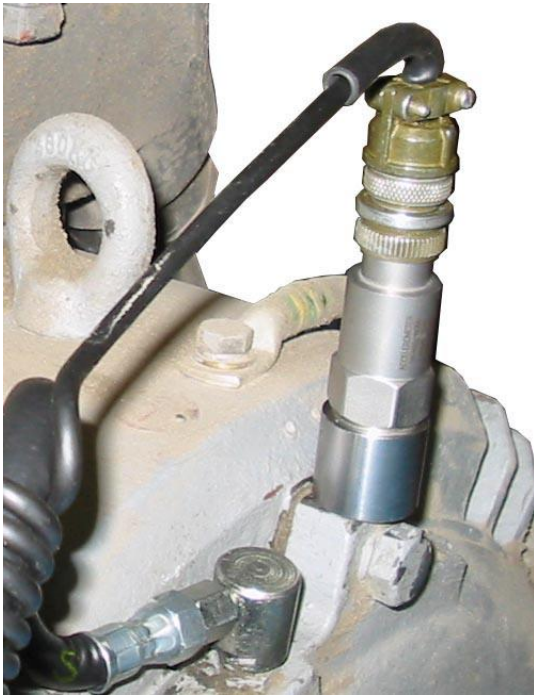

Sensor mounted near to lubrication point

If vibration diagnostic measurements are performed on a machine, then a measurement pad is already mounted. This pad can be used also for lubrication measurements.

Procedure

Mount the sensor near to the bearing. Prepare the greasing gun for use.

Open the Lubri module and select the input channel, which will be used for measurement. Push the *Enter* button to start the measurement. Then, the instrument will measure an actual lubrication state.

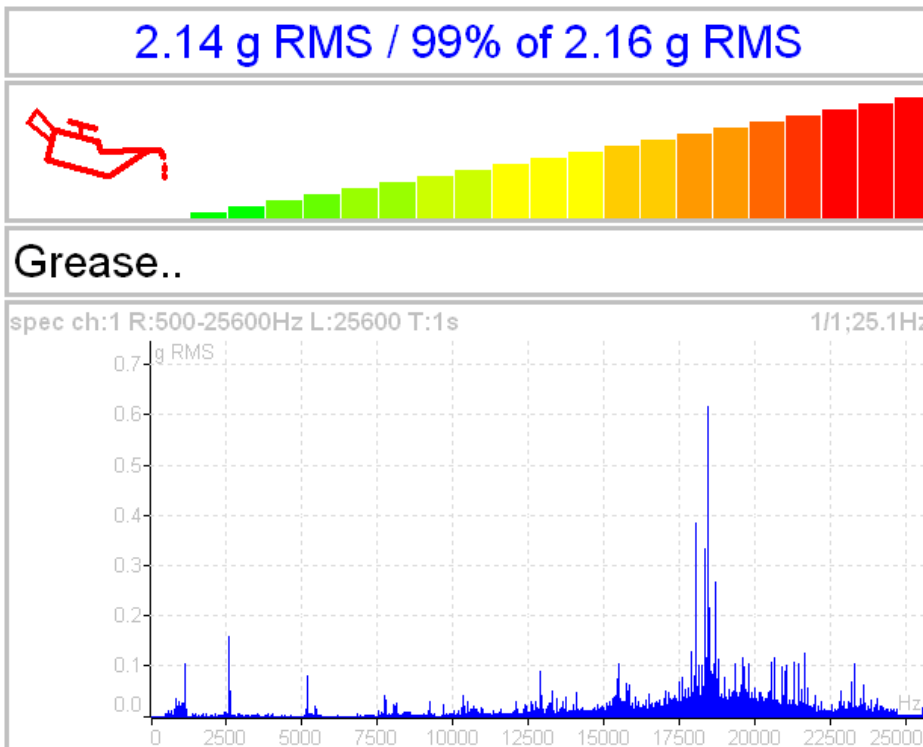

The instrument continually takes a g RMS value in the frequency band 500 - 25600 Hz and compares it to the initial value. The first line contains the actual g RMS value and the proportion to initial value in %.

Below first line is horizontal bar, which indicates actual lubrication state. Its level always reaches a maximum after a procedure start.

The recommendations are also displayed below the bar. The acceleration spectrum is displayed in the bottom. You can look at the spectrum changes during the procedure.

You need to slowly start adding lubricant, while monitoring the height of the column on the display. Usually there is not much going on in the beginning, which means that the lubricant is pushed toward the bearing, however it is not there yet. At the moment when the lubricant reaches the bearing, the column decreases (usually its red part disappears and only the green part remains). You need to add a little more lubricant, and if there is no further decrease, you end the lubrication process.

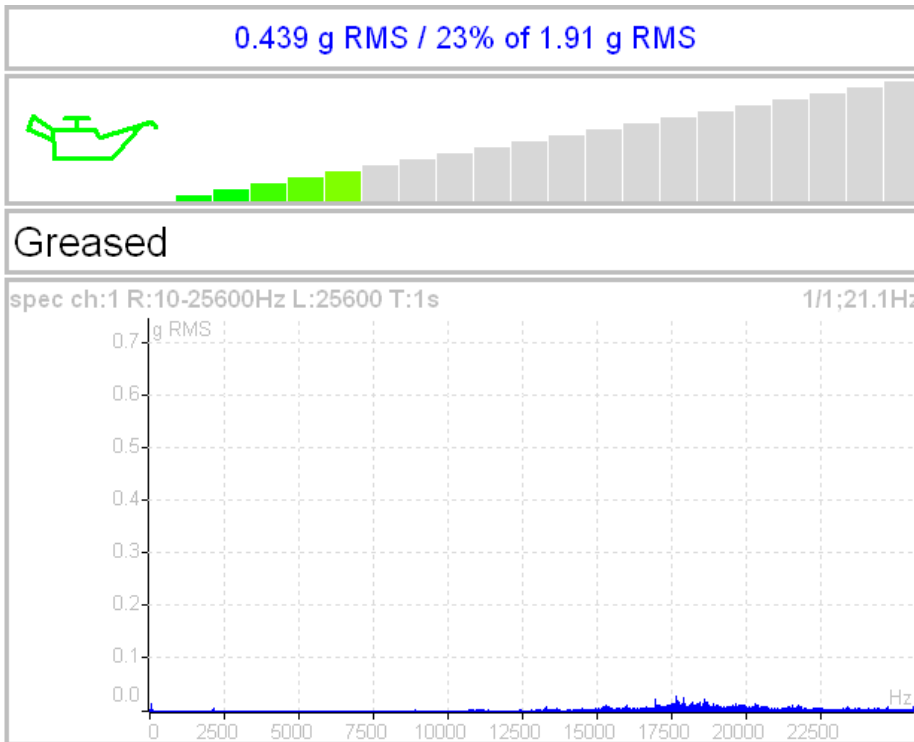

Note! If, at the beginning of measurement, value of vibrations is low and oilcan is green, then we have either new or a very well greased bearing.

Octave Analysis

The Octave Analysis module is designed for sound measurements. It works same as the [Analyzer](#) module. It enables exponential averaging.

Measurement Settings

Edit Measurement	
Type	octave spectrum freerun, retrigger
All Channels	no
Channel	1
Unit	Pa
Resolution	1/1
Frequency Range[Hz]	16-16000
Frequency Weighting	none
Averaging	linear
Avg	off total t = 0.125 s
Save	

Type

octave spectrum

sound level

The sound pressure level in dB is defined as $20\log_{10}(p_{RMS}/p_0)$, $p_0=0,00002$ Pa (p is sound pressure)

equivalent sound level

When during time interval the sound level changes, then the equivalent sound level is the average sound level of the whole interval.

Channel

1 - 4

Unit

The unit of measurement (has to be compatible with sensor settings)

Resolution

1/1, 1/3, 1/12, 1/24

Frequency Range

1-63 Hz, ..., 16-16000 Hz

The central frequencies of the lowest and highest octave.

Frequency Weighting

none, A, B, C, D

The human ear has the subjective characteristics known as the loudness. It is the function of sound intensity and frequency. For example the 20Hz pure tone with sound level 20dB would be clearly audible. The 100Hz with the same level would not be heard, it lies below the threshold of hearing. The unit of loudness is **phon**. The loudness level in phons of any sound is defined as being numerically equal to the intensity level in dB of a 1000Hz tone. The purpose of weighting is to make the readings correspond as closely as possible to the loudness level. Historically four weighting were defined:

- A used for loudness levels below 55 phons.
- B used for loudness levels between 55 and 85 phons.
- C used for loudness levels over 85 phons.
- D used especially for aircraft noise.

However today is A-weighting frequently specified for measurements irrespective of level.

Averaging

linear

The standard arithmetic mean for every line

peak hold

The maximum value during the measurement for every line

exponential

The continuous measurement where the older spectra have less weighting than the newer

Avg

off or number of values in an average

Measurement

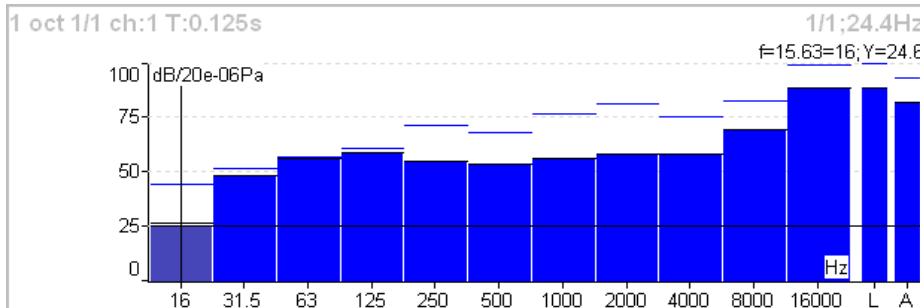

Each spectrum is combined with two bars at the right side. The total sound level **L** and the used weighting level **A – D** are displayed. The line over each line is the maximum peak reached during the measurement.

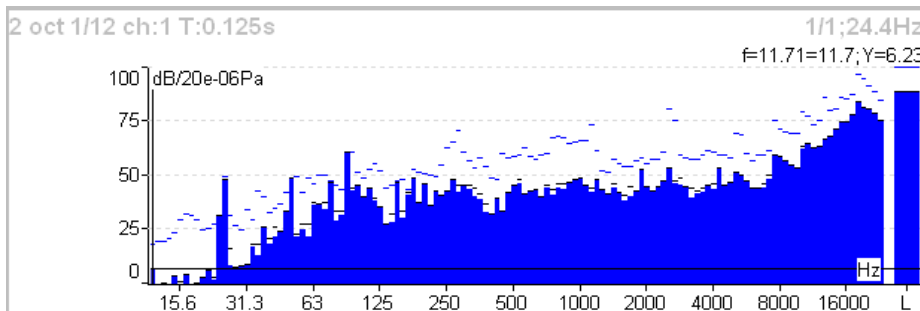

Octave Analysis Algorithm

Octave analysis uses set of digital filters. Each filter has designated a center frequency and bandwidth. Filters are designed according to ANSI S1.11:2004 and IEC1260:1995.

Bump Test

It enables to find the resonance frequency of machine's body.

Test contains two parts. The level of amplitude trigger is found in the first part. The response spectrum is developed in the second part.

Settings

The *Settings* menu opens after you enter the Bump Test module. You can open it later using **New Test** button.

Settings	
▶ Channel	1
Hits	4
Range[Hz]	400
Unit	mm/s
Neg. Averaging	no
Save	

Channel

Input channel number

Hits

Number of hits. It's same as number of signals for averaging in spectrum.

Range

Frequency range (maximum frequency) of the analysis.

Unit

Measurement unit. Integration of signal is also possible.

Negative Averaging

See [MENU / SETTINGS / Trigger Settings / Negative Averaging](#)

Amplitude Trigger

In the first part of test we need to detect the correct value for triggering. The system set it automatically. Start the test by the *Enter* button. Make the hit and look the moving of the hand on display. Make all hits with approximately the same force. More than one hit is recommended (3-4). Push *Escape* to finish the first part. The second part begins automatically.

Attention! Make all hits with approximately the same force throughout the whole test.



Response Spectrum

In part 2 continue with hits. The spectrum with resonance frequencies is displayed after first hit and the averaging is used for next hits. Look at the top right corner and make the hit when the message "Waiting for trigger" is displayed. The test is stopped after reaching the specified number of hits or you can stop it anytime by *Escape* button.

Note! You don't need to wait for the "Waiting for trigger" message. The hit can be performed immediately after the spectrum on the screen is updated.

Note! A 10 Hz high pass filter is used during signal processing. Frequencies below this value are removed.

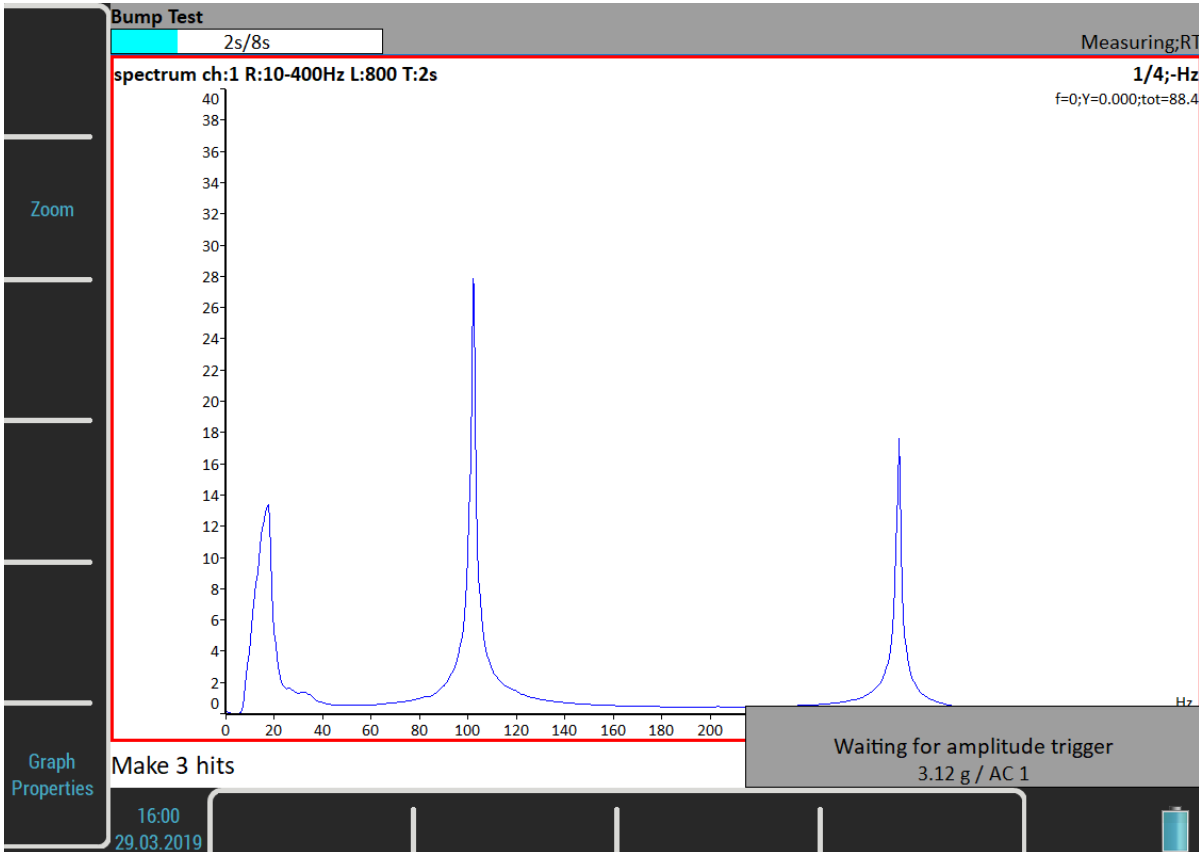

Analysis

Spectrum graph has the same properties like in the Analyzer mode. Using of the [Graph Properties/ Peaks List](#) helps you to detect required frequencies.

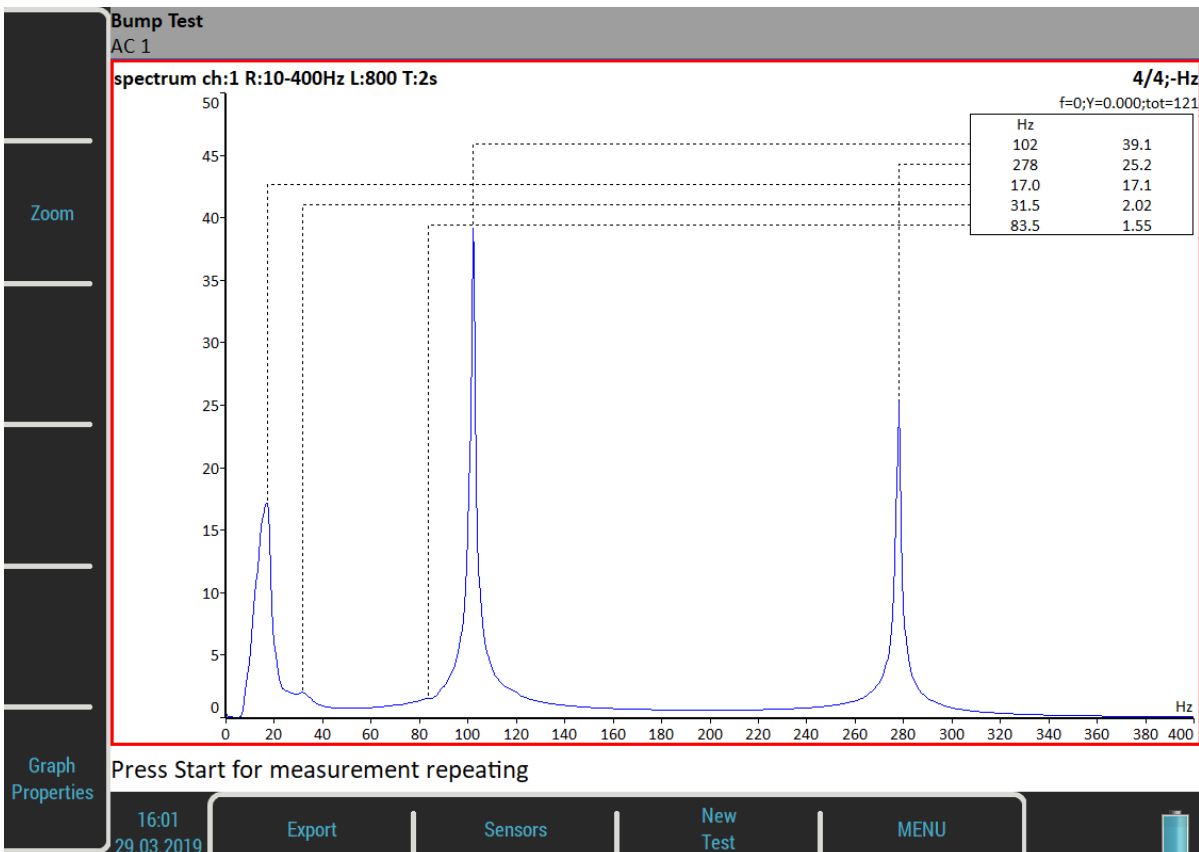

Buttons***Enter***

Repeats the second part with the same trigger level.

New test

Starts new test including the trigger level initialization.

Export

Exports spectrum from bumptest to Analyzer or to *VA5_DISC* as an Analyzer project. This project can be imported to DDS.

ADS

The ADS (Adash Deflection Shapes) module enables to measure operating deflection shapes of the machine.

ADS project

The project must be created on the computer. The ADS software enables to create the geometry of the machine (points, lines and directions).

Project Import to VA5

On PC, copy the project file (ads extension) to *VA5_DISC* either to the root or to *VA4ads* folder. The project will be moved to the instrument memory after entering the ADS module. The file on the *VA5_DISC* will be deleted.

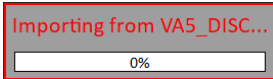

Rewriting of geometry

Usually the user creates the simple geometry firstly and takes the measurements. After that first test he changes the geometry (adds next points, lines and directions). When the project is imported to the instrument again then only the geometry file will be rewritten. The already taken data will not be deleted.

Project List

The project list opens after entering the module.

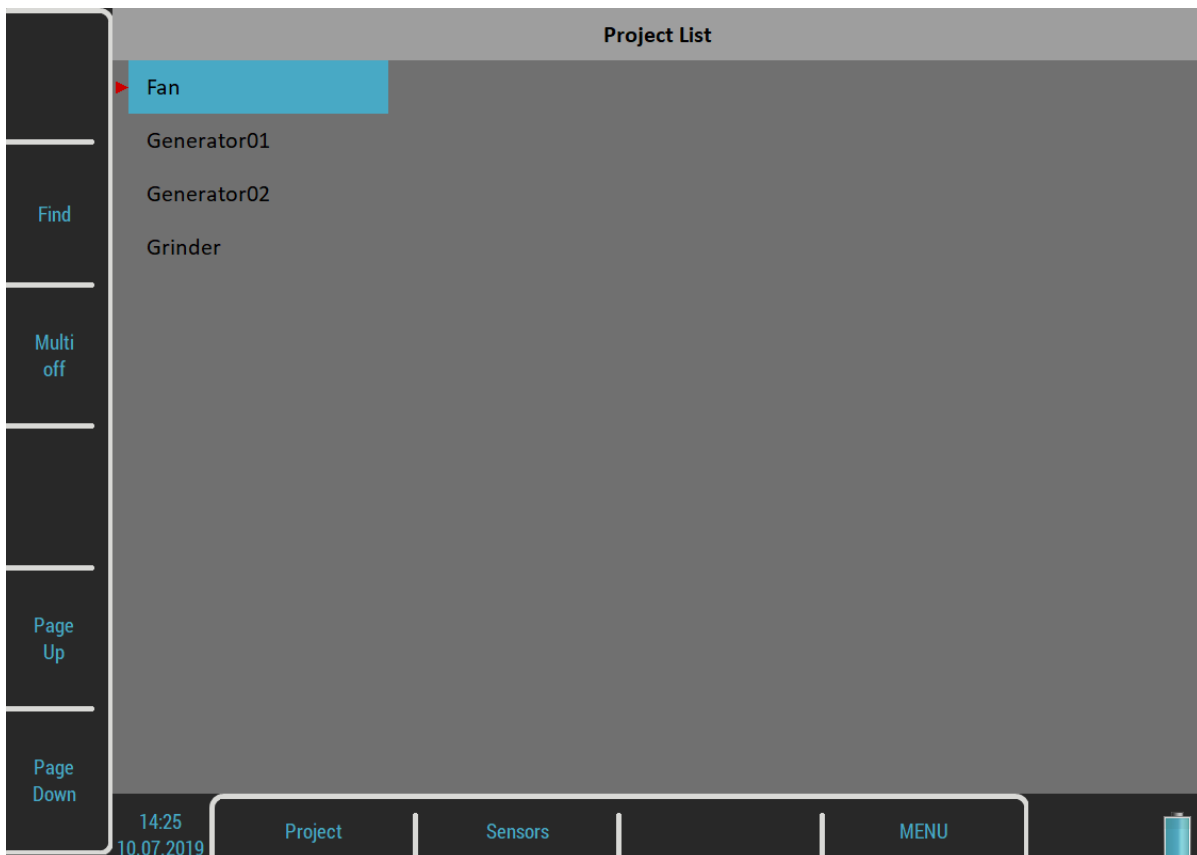

Project Menu

Push the **Project** button to open the menu. A **Create** item misses here. You can create an ADS project only by importing geometry from computer (see above).

Copy

Copies selected project to new project without measured data.

Rename

Renames selected project.

Delete

Deletes selected project(s).

Clear Data

Deletes all readings in selected project(s).

Export Data

Exports readings to *VA5_DISC*. File with "**name**".**dsd** will be saved to *VA4ads* folder. It is prepared for import in the ADS application.

Export Project

Exports the whole project, both readings and geometry, to *VA5_DISC*. This project can be then used in Virtual Unit application.

ADS Settings

Select required project in the project list and open it. The settings of measurement parameters are required when the project is opened first time. You can change the settings any time later using the **ADS Settings** button.

ADS Settings

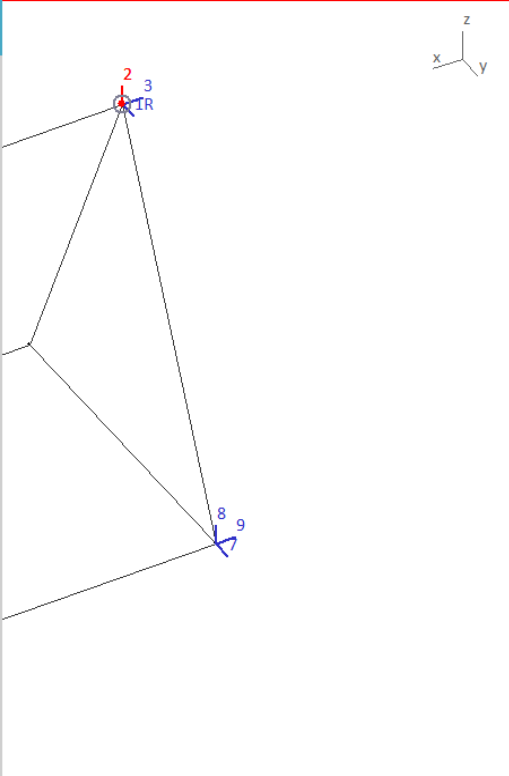
Type	frf freerun, single	
Input	1	
Window	hanning	
Output	2	
Window	hanning	
Result Type	H1	
Range[Hz]	800 fs = 2048 Hz	
Lines	800 t = 1 s, df = 1 Hz	
Avg	4 total t = 4 s	
Overlap	0%	
Reference Direction	1	
Frequency for Animation [Hz]	50	
Vibration Scale	0.5	
Save		

Measurement Definition

The [amp+phase](#), [Orders](#) or [Frf](#) are available measurement types for ADS. All parameters are same as in [Analyzer](#) / [Edit Measurement](#).

Attention! The change of measurement parameters requires deleting of all saved readings when they are not compatible with the new definition. The only parameter you can change without losing readings is the channel number.

Reference Direction

This parameter is available only for **frf** measurement type. One reference sensor is mounted to one point (one direction) on the machine and is on that place all the time. The second sensor is moved sequentially to all other directions.

Attention! The change of *Reference Direction* number requires deleting all saved readings, because they are not compatible with new reference direction number.

Frequency for Animation

Specifies which frequency of frf will be used for animation on VA5 screen. This setup is available only for frf measurement. In case of amp+phase or orders, the speed frequency (1X) will be used for animation.

Vibration Scale

<0, 1>

Scales amplitudes of vibrations in animation.

Views

Three types of screen view are available. Use the **View** button to switch it.

Machine View

The geometry is displayed. Directions contain numbers. The reference direction is marked as **R**. Just selected point contains a small circle. Just selected direction is drawn by different color.

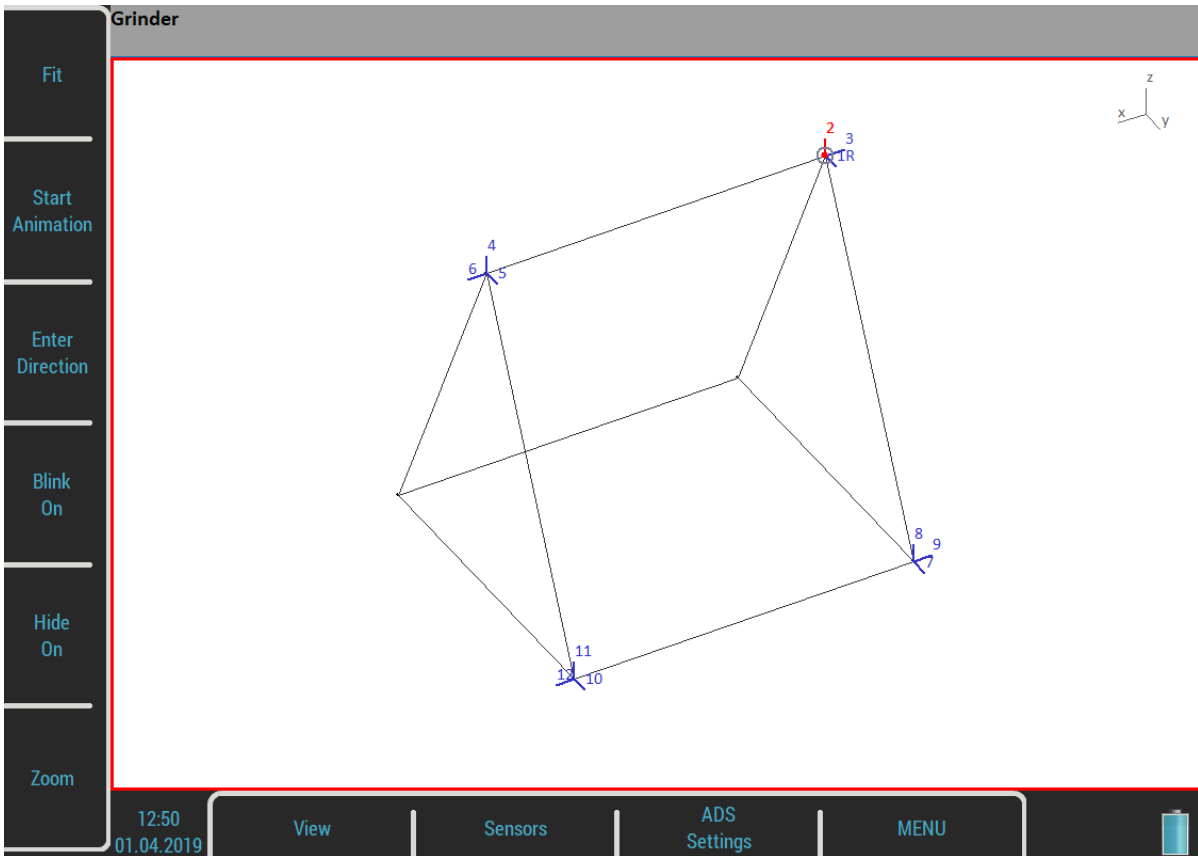

Measurement View

A standard graph with measurement is displayed. The number of selected direction is displayed in front of measurement type (2 frf)



Machine+Measurement View

Both previous screens are displayed together. The user can select one of them to have a focus (the red border) with the **View** button and to work with it.

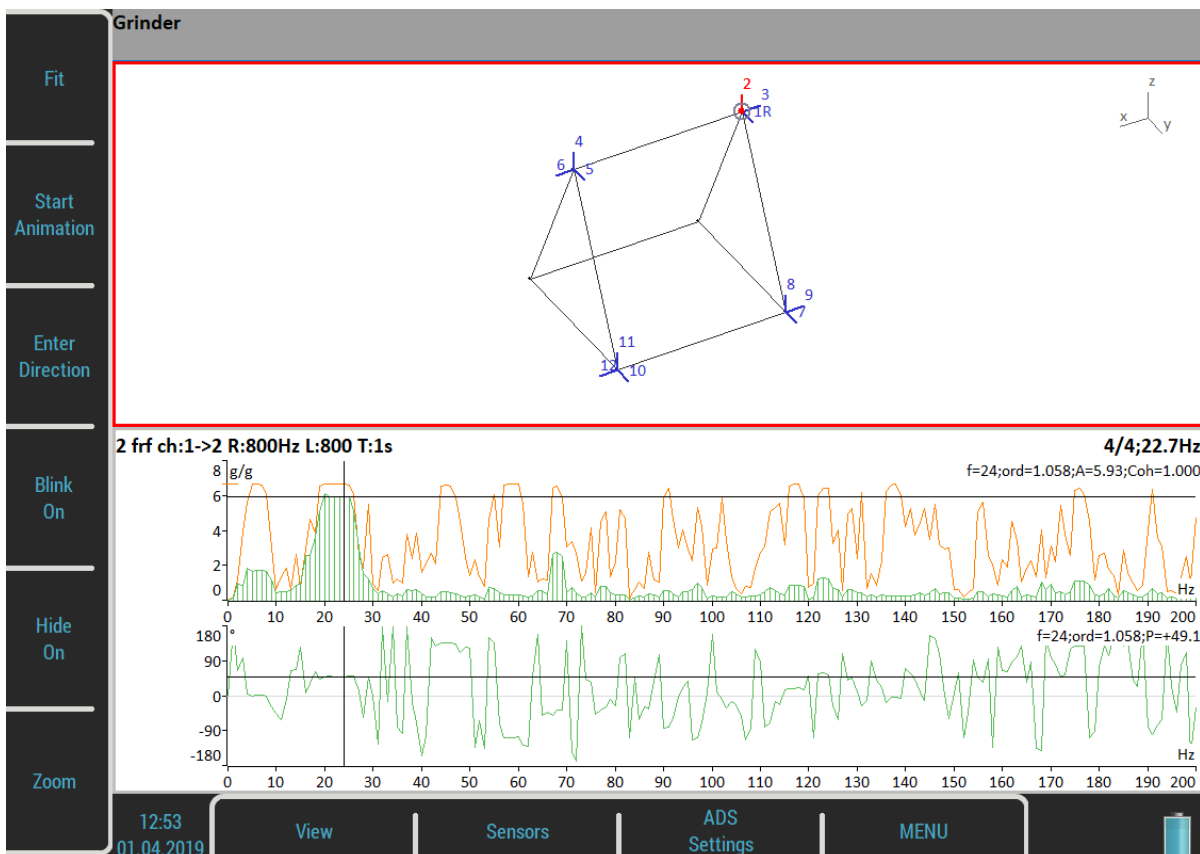

Automatic change of view

When the measurement starts, the machine view is replaced by measurement view.

Buttons for Machine View

Fit

Auto-zoom of machine in window

Start/Stop Animation

Runs or stops the animation.

Enter Direction

Opens a dialog to manually enter the direction number.

Blink on/Blink off

The directions, which have not been measured yet, can blink.

Hide on/Hide off

The directions, which have been measured yet, can be hidden.

Zoom

Switches buttons to the ***Zoom / Move / Rotate***. Push the *Tab* or *Backspace* button to return the initial mode. Zoom and move functions are also available by touch screen.

Left / Right Arrow - Direction

Changes the direction number on the selected point. The new direction can be also entered by the [Enter Direction](#) button.

Up / Down Arrow - Point

Moves the point selection (blinking circle). When the new selection is confirmed by ***Enter***, then the selected direction is also moved to that point.

Enter

Starts a new measurement on active direction.

Buttons for Measurement View

Zoom

Switches buttons to the ***Zoom***. Push the *Tab* or *Backspace* button to return the initial mode.

Graph Properties

Open the ***Graph Properties*** dialog which is described in the ***Analyzer*** module.

180° on/180° off

Sometimes it is not possible to mount the sensor to direction which is defined in geometry. Usually in such case it is possible to mount the sensor in opposite direction. Then use this button and change the phase about 180 degrees.

Save

Saves the reading.

The saved readings are displayed in graph while selecting a directions in a model. Directions already measured are color coded in the model. When you select a measured direction, its signal is displayed in the graph. Direction number, amplitude, phase and frequency for animation are displayed in the status bar for the selected direction.

Grinder

2: A = 5.69 g 0-P, P = +45.0°, f = 50 Hz

Ultrasound

We would like to explain a few terms in the beginning of this chapter.

Higher frequency energy above 20 kHz is best detected with an ultrasonic sensor. Most useful information is found between 30 and 50 kHz. The ultrasonic module enables monitoring ultrasonic energy.

Ultrasound utilizes a solid, liquid or gas to transmit (will not exist in a vacuum), and is a very directional and short waveform. It has several things in common with the vibration, for instance the ability to detect the ultrasound energy requires the sensor to be focused in the direction of the waveforms.

Field applications for airborne ultrasound detection:

- Consider the wave energy is easily reflected and attenuated.
- When looking to detect airborne ultrasound energy a rule of half distance twice amplitude is a good thing to consider, this is called the "inverse rule".
- Remember airborne ultrasound is easily reflected, when detecting a leak, you should turn in the other direction to determine if the sound is coming from behind you.
- Use shields such as cardboard or to isolate the potential defect from other sources.

For airborne ultrasound the instrument microphone attachment will detect:

- Air leaks
- Vacuum leaks
- Electrical Arcing
- Electrical Corona
- Tightness testing where a signal generator is located within a sealed unit, then by scanning the sealed areas from the outside leaks can be detected.

The probe attachment that enables direct transmission ultrasound will detect:

- Early signs of poor lubrication in anti-friction roller bearings
- Impacting noise from defects in roller bearings including bearings with shaft speeds under 100 rpm.
- Steam trap leakage and failures
- Gearbox defects
- Valve leakage
- Actuator malfunctions

Sensor Setting

The ultrasound measurement is available only on AC1 which has the specific powering for the ultrasound microphone (see [Input Channels](#) / [IN1 Socket](#)). When you enter the module, the sensor is automatically changed to Pascal sensor.

Used Sensor
on AC1: 200 mV / Pa, ICP off

Use the [Sensors](#) / [AC1](#) to change the sensitivity if needed. The new setting is saved and used in next run.

Note! The original sensor is set, when you leave the module.

Settings

You can set the scale of the displayed bar graph. Open the menu by the **Ultrasound Settings** button.

Ultrasound Settings	
Scale - minimum	0
Scale - maximum	120
Save	

Scale – minimum

The minimum value on bar graph.

Scale – maximum

The maximum value on bar graph.

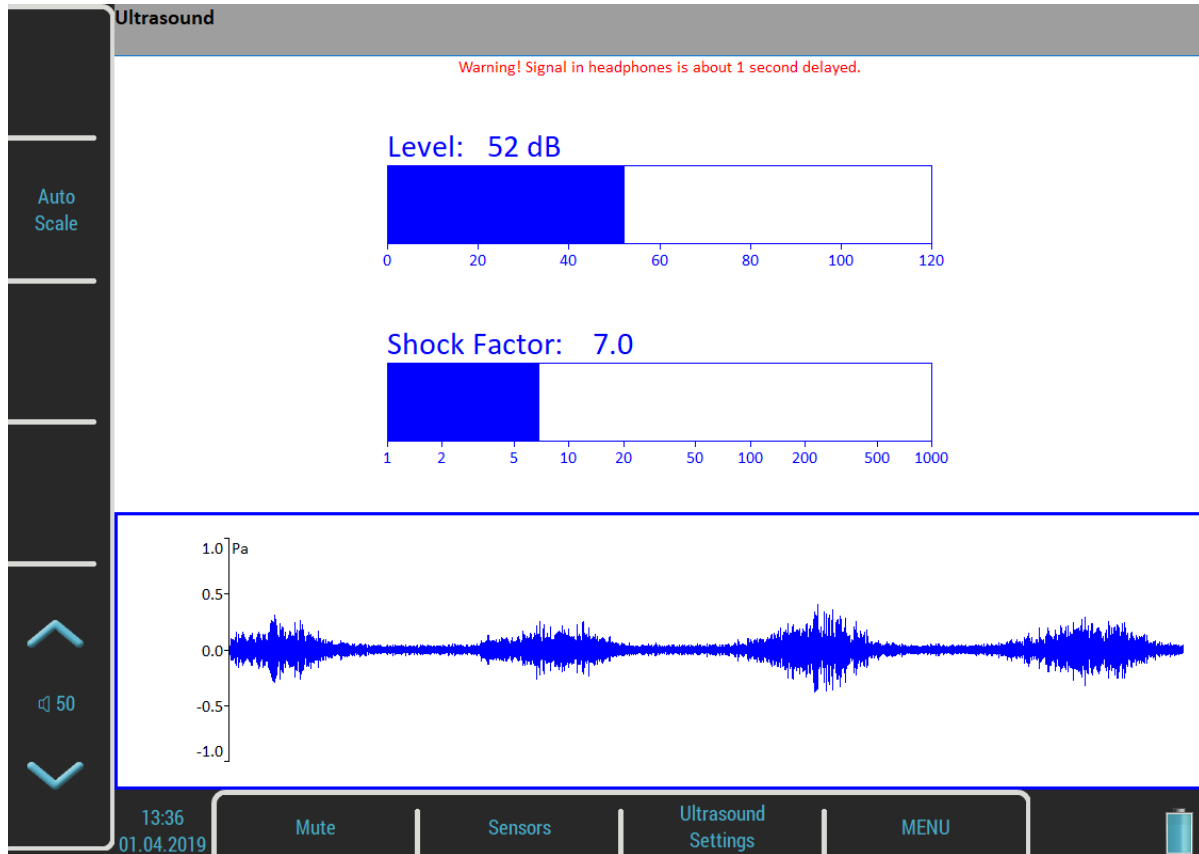
Measurement

Push the *Enter* button. Two values are displayed, the **Level** of sound in dB and **Shock Factor**. The **Shock Factor** is defined as Peak value divided by RMS value. It means value 1.4 for pure sine. Higher value means that transient shock events are in the sound signal. The time waveform is displayed at the bottom of the screen. Use **Auto Scale** button to fit the scale of the graph. The ultrasound is demodulated to the frequencies around 1kHz and you can hear it in headphones. Use the volume buttons to set the correct level. Push *Escape* to stop the reading.

Attention! The signal in headphones is about 1 second delayed. It is because of digital processing, which takes this time.

Camera

The VA5 instrument is equipped with the optical camera. The picture from the camera is automatically on the screen a few seconds after opening the module.



Buttons

Pause / Run

Freezes a picture from the camera and then runs it again.

Capture

Takes a picture. All images are saved to the **images** folder on the **VA5_DISC**.

Gallery

Open a [Gallery](#) so as you can watch taken pictures.

IR Camera

The IR camera can be connected to the micro USB slot on the instrument's top panel. The IR camera is not a part of the standard VA5 instrument set. You can order it at your vendor.

Operation

- 1/ Plug the supported IR camera into the micro USB slot.
- 2/ Run the **IR Camera** module.
- 3/ Wait a few seconds until the camera initializes.

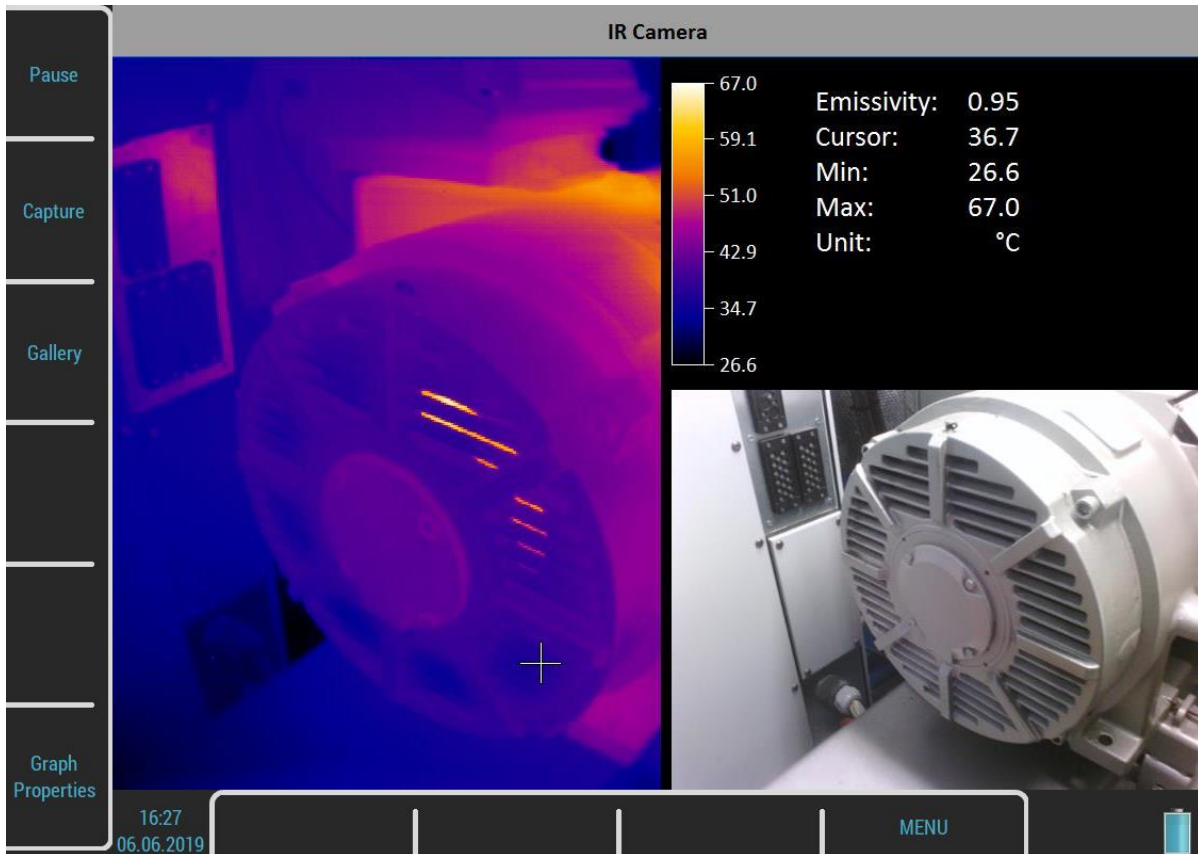

The image from IR camera takes place in the left half of the screen. The image of nearly same scene from the optical camera is in the bottom right corner. The information panel is in the top right corner. You can see the minimum and maximum temperature and the temperature of the point under the cursor. Use arrows or tap the touch screen to change the cursor position.

Focus

The supported IR camera uses manual focus. You may adjust the focus (refocus) by turning the lens to sharpen the focus for the distance of the target.

Warming Up

The IR camera needs some time to warm up after connection. During warm-up, you may notice a slow decreasing of temperature. It is in units of percent. This typically takes about five minutes.

Cursor

Use arrow buttons or tap the IR image to move the cursor cross. The temperature of the point under the cursor is written in the table.

Pause / Run

Pauses and then runs again the scene.

Capture

Takes the image of the scene. Two files will be stored in the **images** folder on *VA5_DISC*. One file stores the raw temperatures from the IR camera in the special thm format. You can work with this file in the DDS software. Second file is the png picture of the screen. You can watch the picture but you are not able to make further analysis.

Gallery

Opens a [Gallery](#) so as you can watch taken pictures.

Calibration

Opens a menu where you can choose one of two possible types of calibration.

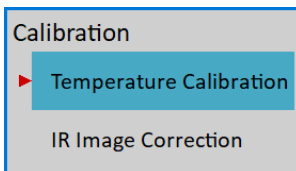

Attention! For both types of calibration, calibration constants are stored in the instrument and not in the camera itself. Thus, you need to perform the calibration procedure again when you connect another camera. Similarly you need to perform the new calibration procedure when you connect the camera into another instrument.

Temperature Calibration

Aging of cameras electronics can cause inaccurate temperature measurement. For this case you can use this IR camera calibration tool.

In calibration process you will be asked for making IR pictures of two objects with different temperature and entering their real temperatures into device. These two objects should be made from the same material with the same color and surface structure if possible. Another option is to cover the surface of calibration objects with black adhesive tape. For calibration you have to know the real temperature of these objects.

Take two captures (the **Capture** button changes into **Capture 1** and later into **Capture 2**) and enter the temperature value at cursor position for each.

The calibration procedure automatically ends after entering the second temperature. New calibration constants are calculated and used. The procedure can be terminated by the *Escape* button. The **Reset Calibration** button erases calibration constants from the instrument.

If you are not able to measure the real temperature of objects, there is a solution for you. Set the Emissivity to 0.96 and take IR picture of boiling water surface and assign temperature 100°C (212°F). As a second calibration picture capture the surface of water from melting ice and assign temperature 0°C (32°F).

IR Image Correction

Sometimes you may notice a corona effect or bad pixels on the IR image. The IR Camera Correction function should solve this problem.

ADASH

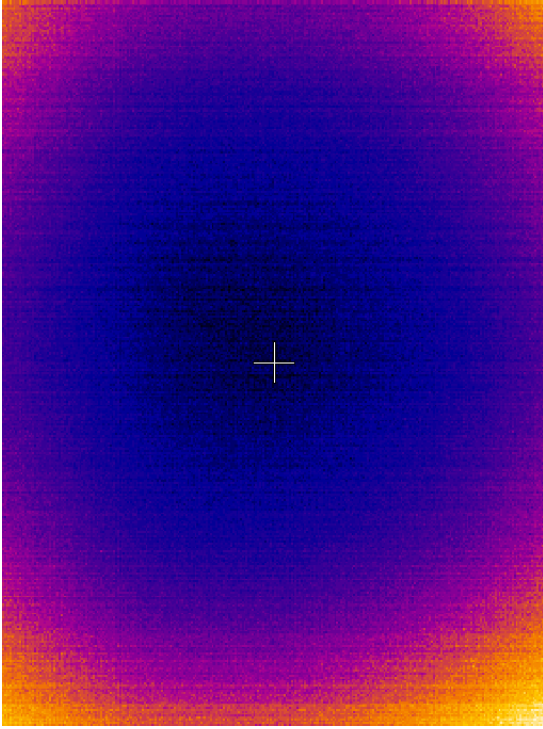

VA5 Pro

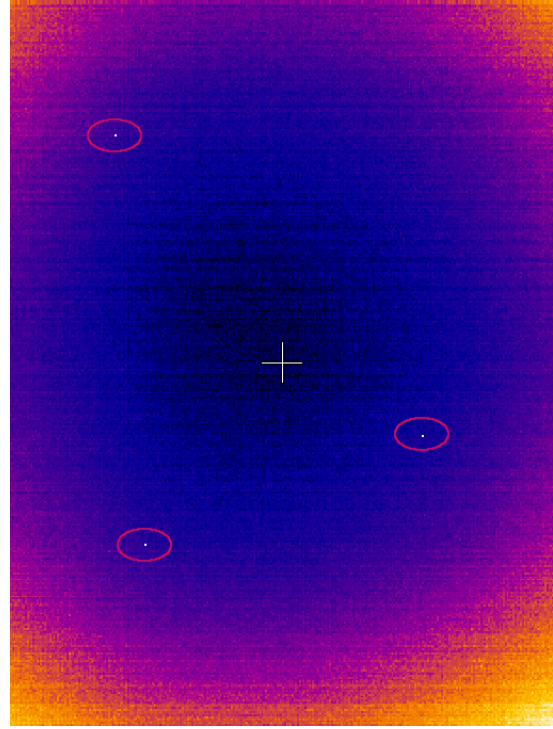

During this procedure, simply set the IR camera to see uniform scene (eg. the wall). Then press **Calibrate** and the image should be repaired. The uniform scene should then look like this:

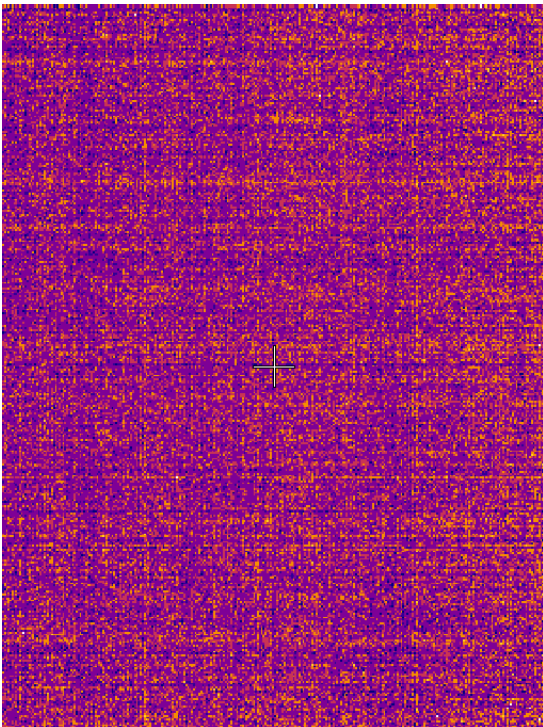

Attention! IR image distortion may be caused by insufficient warm-up of the IR camera. After connecting the IR camera, wait at least 5 minutes before running the IR Image Correction.

Graph Properties

Unit

Choose the temperature unit.

Emissivity

The emissivity value of the observed place is needed to calculate the right temperature.

Color spectrum

Choose the colors of the images, **colored** or **black and white**.

Scale

auto, **user**

The **auto** scale ensures highest possible contrast of the picture. With the **user** scale, you have fixed color for each temperature.

Gallery

The images from the camera, IR camera and also all screenshots ([MENU / RUN / Screenshot](#)) can be watched in the Gallery. You can watch the images as icons or one image on screen. Use the *Enter* button or double tap an image to maximize it. Then use an *Escape* button to restore the icons mode.

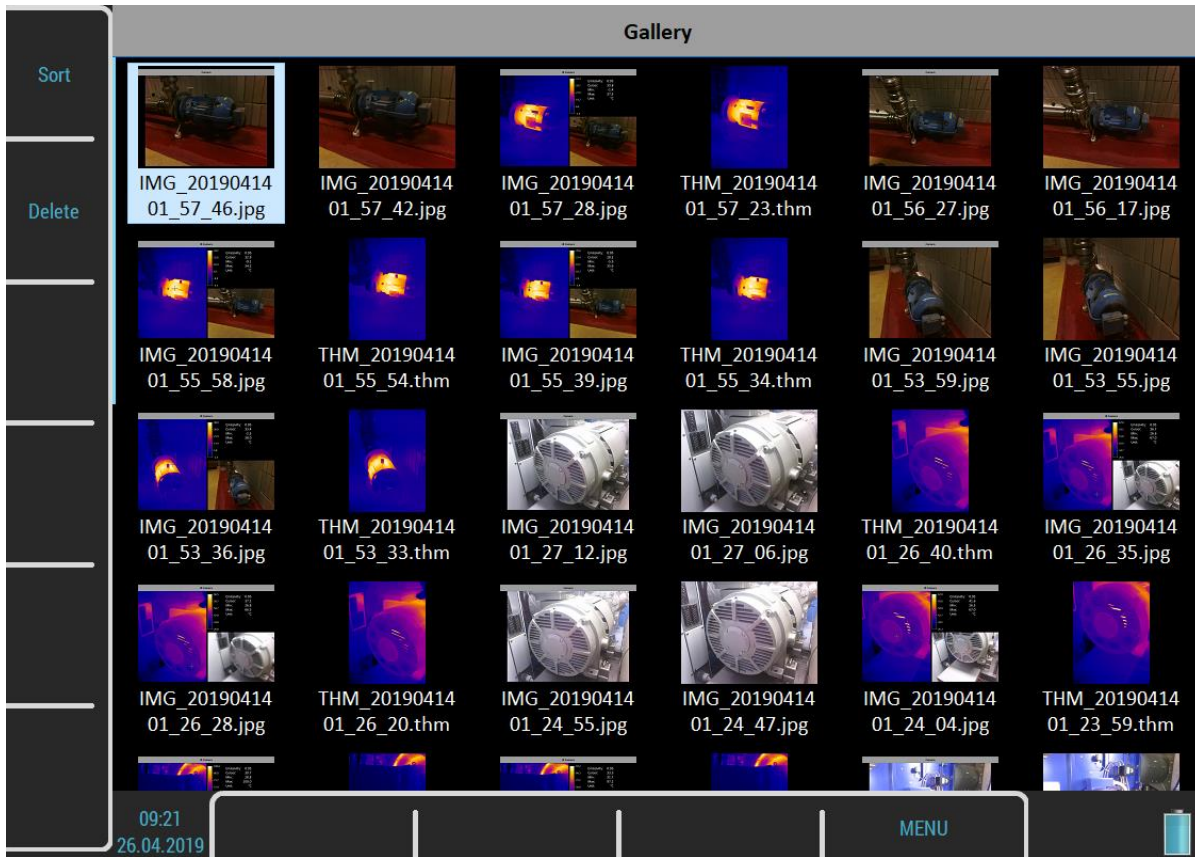

Buttons

Sort

You can sort the images by name or by time, in ascending or descending order.



Delete

Delete the selected image.

Buttons for maximized IR Camera picture

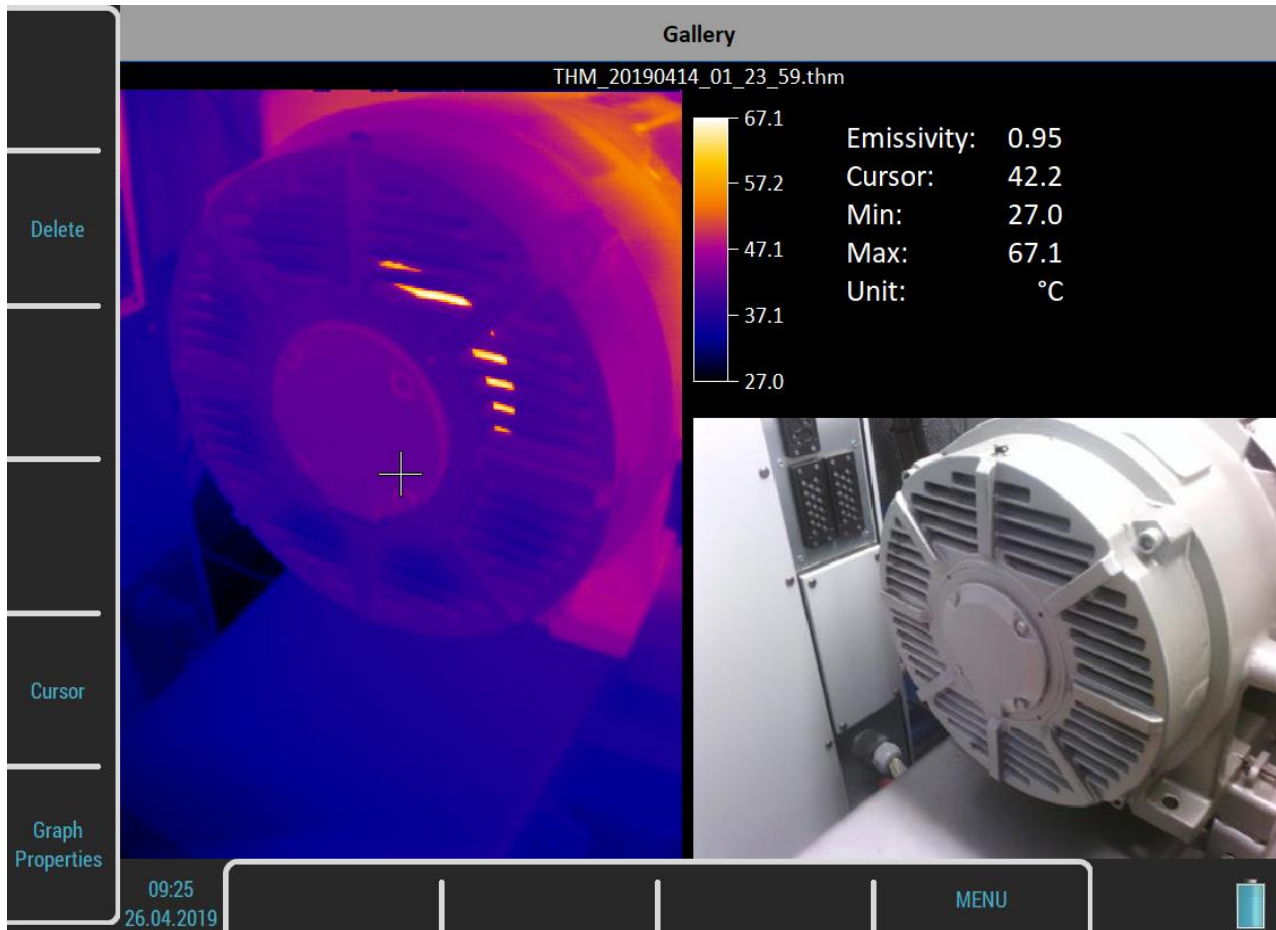

Cursor

When a picture from [IR Camera](#) is maximized you can also move the cursor. Push the **Cursor** button to switch arrows into a cursor mode. Then press the same button, now named as **Gallery**, to return. You can also switch the mode by tapping the screen. Tap to the IR camera picture to switch into a *Cursor* mode or tap outside the picture to switch into a *Gallery* mode.

Graph Properties

Opens a [Graph Properties](#) menu like in the [IR Camera](#) module.

MCSA

The MCSA (Motor Current Signature Analysis) module is used to determine induction motor faults by analyzing stator currents. You need three phases measurement for whole analysis but most can be performed with only single current measurement. Current clamps are used for the current measurements.

The module evaluates broken rotor bars or cracked rotor rings, shorted turns in stator windings, air-gap eccentricity and power quality.

Sensors Settings

The MCSA module is based on current measurements, therefore you need to define suitable current sensors. When you enter the module from main screen, predefined sensors will be automatically set. A "**Used Sensors**" message box informs you about it.

Note! The acceleration sensor on AC4 has not any purpose for now. It may be used in future.

Used Sensors
 on AC1: 10 mV / A, ICP off
 on AC2: 10 mV / A, ICP off
 on AC3: 10 mV / A, ICP off
 on AC4: 100 mV / g, ICP on

If you want to use different sensors you can setup them in the menu.

Note! The sensors menu is not available immediately after confirming the message box, because the [MCSA Settings](#) menu appears first.

Note! Once you have changed the sensors, your new setup will be saved and used as predefined sensors for next time.

Note! Any sensors setup in the MCSA module applies just in this module. When you leave the module back to main screen, the previous sensors will be restored to a state before entering the module. Therefore, if you want to make some further analysis in other modules you need to setup the sensors in the [Sensors](#) menu while not having opened the MCSA module.

MCSA Settings

The *MCSA Settings* menu automatically appears after confirming used sensors. Enter a few parameters which are needed in MCSA algorithm. This menu can be opened also later by pressing *MCSA Settings* button.

MCSA Settings	
3 Phases	yes
Phase 1	1
Phase 2	2
Phase 3	3
Poles	2
Rotor Bars	undef
Line Frequency [Hz]	detect from AC 1
Speed Frequency [Hz]	tacho
Save	

3 Phases

yes, no

If you want to use all three phases to perform complete MCSA analysis then select **yes**. One phase measurement doesn't enable to check phase shifts and amplitude differences among phases. Thus, it doesn't enable to evaluate stator faults.

Phase 1 – 3

1, 2, 3, 4

Select channel number for each phase.

An "**Improper sensor**" note appears if there's not current sensor defined on this channel.

Phase 1	1 Improper sensor
---------	----------------------

Poles

2, 4, 6, 8, 10, 12, 14, 16, 18, 20, user

Number of poles of analyzed motor

The number must be dividable by two.

Rotor Bars

undef, user

Number of rotor bars of analyzed motor

This catalog information may not be always available. If you leave this parameter undefined the measurement can normally continue but the eccentricity cannot be evaluated.

Line Frequency

detect, user

Enter the value of line (power grid) input frequency. If you don't know the value then **detect** choice can help you.

Signal for the detection is taken from *Phase 1* input channel. A note "**from AC 1**" informs you about it (the number in the note is always same as *Phase 1* value).

Line Frequency [Hz]	detect from AC 1
---------------------	---------------------

The **Line Frequency Detection** is similar to [Speed detection](#) which is described in stand alone chapter.

An "**Improper sensor**" note appears if there's not current sensor defined on *Phase 1* channel.

Line Frequency [Hz]	detect Improper sensor
---------------------	---------------------------

The line frequency detection runs before MCSA measurement.

Speed Frequency

tacho, user

Enter the value of speed frequency (rotor speed). If you don't know the value then use tacho probe.

Speed from tacho probe is detected before MCSA measurement.

Measurement

Push *Enter* button to start the measurement. The line frequency and / or speed detection runs first if needed.

The duration of one reading can vary from about one second to a few tens of seconds. It depends on measured motor properties. A count down bar is displayed in status bar for longer measurements.

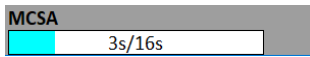

The measurement is automatically stopped when finished or you can interrupt it by pushing the *Escape* button.

MCSA Screen

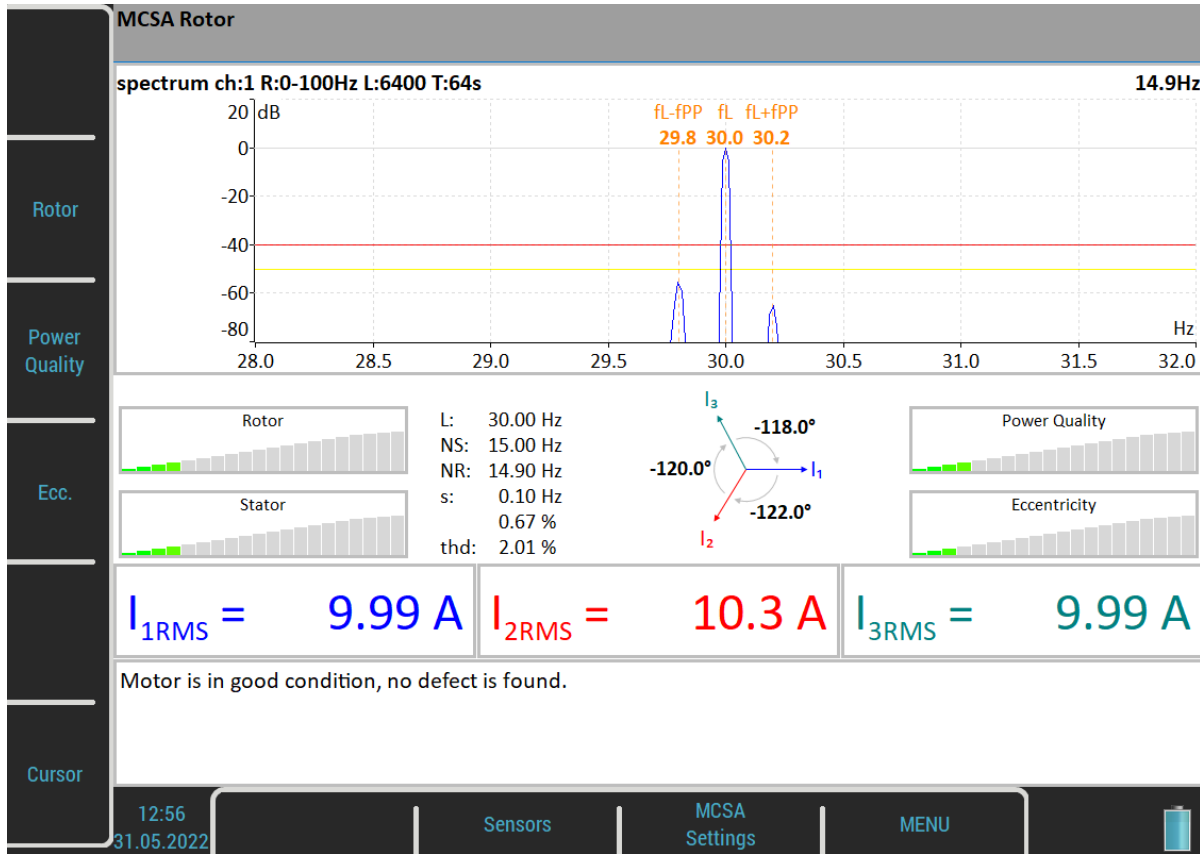

You can switch displayed spectrum by pressing **Rotor**, **Power Quality** or **Ecc.** button. Actual choice is written to the status bar as “**MCSA Rotor**” and so on.

By pressing the **Cursor** button, you may turn a cursor in spectra on or off. You can use the cursor to explore the spectrum like in analyzer module.

The **Sensors** button opens the [Sensors](#) menu. This is the default shortcut which can be changed.

The **MCSA Settings** buttons opens the MCSA menu.

The **MENU** button opens the global main menu.

The screen contains several indicators. Let's discuss them.

Rotor spectrum

It's displayed by default. Push the **Rotor** button to display it again when another spectrum had been chosen.

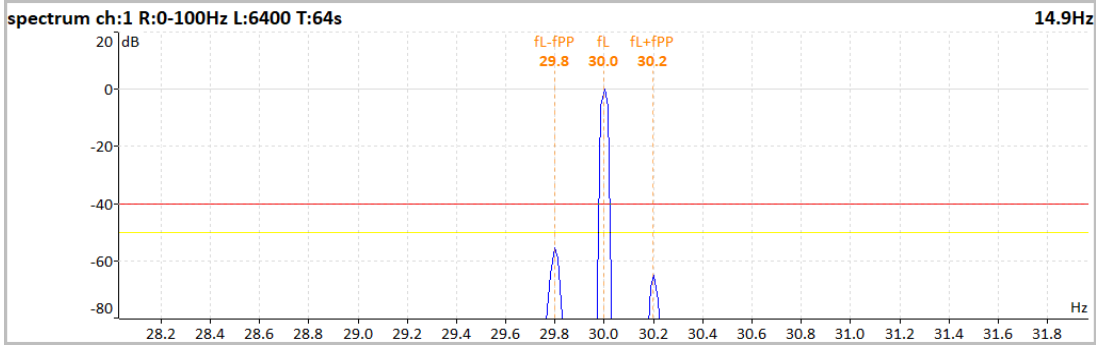

It is a frequency spectrum around line frequency. The spectrum is displayed in dB with line frequency as reference value.

Three frequencies are marked:

fL means line frequency.

fL +/- fPP means pole pass sideband around line frequency.

Two limits are marked:

- -50 dB for warning
- -40 dB for danger

There is a simple rule. If the difference between the main and sideband components is greater than 50dB rotor has no faults, when difference is in range between 40 and 50 dB there is probably one bar broken and with difference greater than 50 dB there are several broken bars or broken end ring (as mentioned in **Brief Review of Motor Current Signature Analysis** statement by Dubravko Miljković, Croatia).

Power quality spectrum

Push the **Power Quality** button to display it.

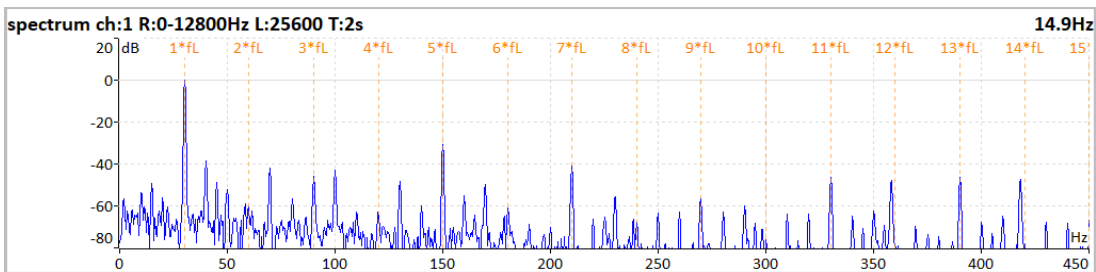

Line frequency harmonics are marked in this spectrum.

Eccentricity spectrum

Push the **Ecc.** button to display it.

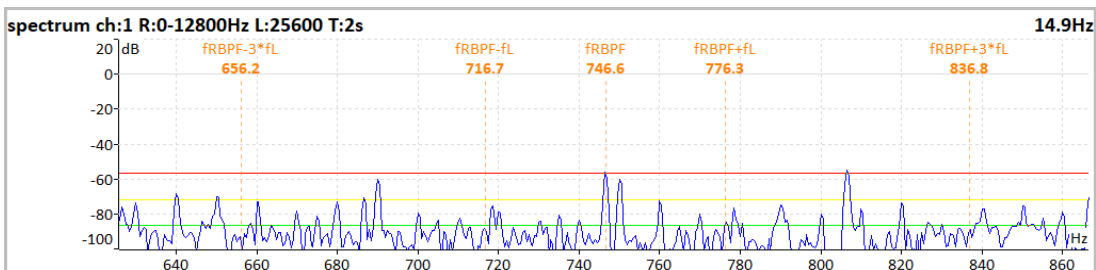

Eccentricity characteristic frequencies are marked in this spectrum. That means **rotor bar pass frequency (f_{RBPF})** and its odd sidebands (**f_{RBPF} +/- f_L** and **f_{RBPF} +/- 3f_L**). Limits for eccentricity detection are also marked.

f_{RBPF} = speed frequency * number of rotor bars

Severity bars

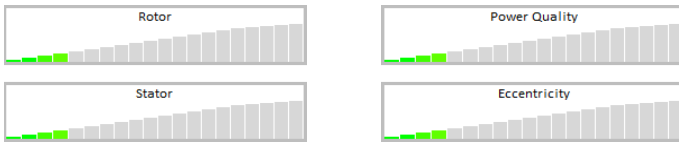

Each horizontal bar displays the severity of individual item. It starts from green color on the left to the red on the right.

Rotor severity is detected from the values on pole pass sidebands.

Stator severity is detected from difference of 3 current values.

Power Quality is detected from total harmonic distortion of current signal.

Eccentricity is detected from values on Eccentricity characteristic frequencies.

Phasor diagram

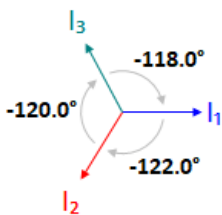

You can check phase shifts among phases. Furthermore, direction of arrows in the phasor diagram corresponds to direction of rotation of motor, whether it is clockwise or counter clockwise.

Frequency table and thd

L: 30.00 Hz
 NS: 15.00 Hz
 NR: 14.90 Hz
 s: 0.10 Hz
 0.67 %
 thd: 2.01 %

- **L** line frequency
- **NS** synchronous speed
- **NR** rotor speed
- **s** slip
- **thd** total harmonic distortion of power supply signal

Current values



Information window

Motor is in good condition, no defect is found.

All detected faults are summarized here in text form. The displayed message describes severity bars states and brings some additional information.

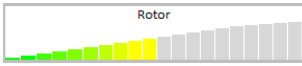

Attention! There is probably a resistance change in the rotor winding. Rotor bars or rings could be broken.

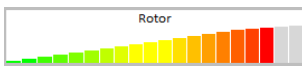

Danger! Rotor bars are broken.

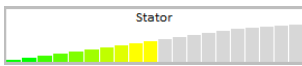

Attention! A stator winding has probably current imbalance. This fault could be caused by change of winding resistance.

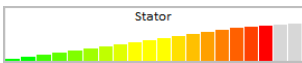

Danger! In the stator winding are probably shorted turns. Another short circuit is possible.

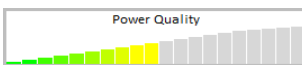

Attention! Phase currents include harmonics. They are probably caused by drive influencing or electromagnetic unbalance in motor.

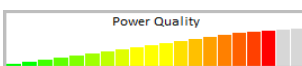

Danger! Phase currents include harmonics. They are probably caused by drive influencing or electromagnetic unbalance in motor.

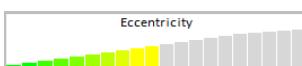

Attention! A motor air gap could be variable. It is caused by eccentric rotor.

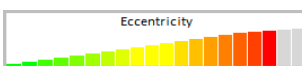

Danger! A motor air gap is variable. It is caused by eccentric rotor.

Errors and warnings

Unstable line frequency or speed

The MCSA analysis may be influenced by unstable line frequency or speed. If one of these values varies, you'll be informed by notification text above right severity bar.



In addition, a message box appears after the measurement completes.

Unstable line frequency

Unstable speed

High speed

When the speed is too close to synchronous speed, that means slip approaches zero the “**High Speed**” error is thrown. In this case rotor faults cannot be detected.

One phase measurement

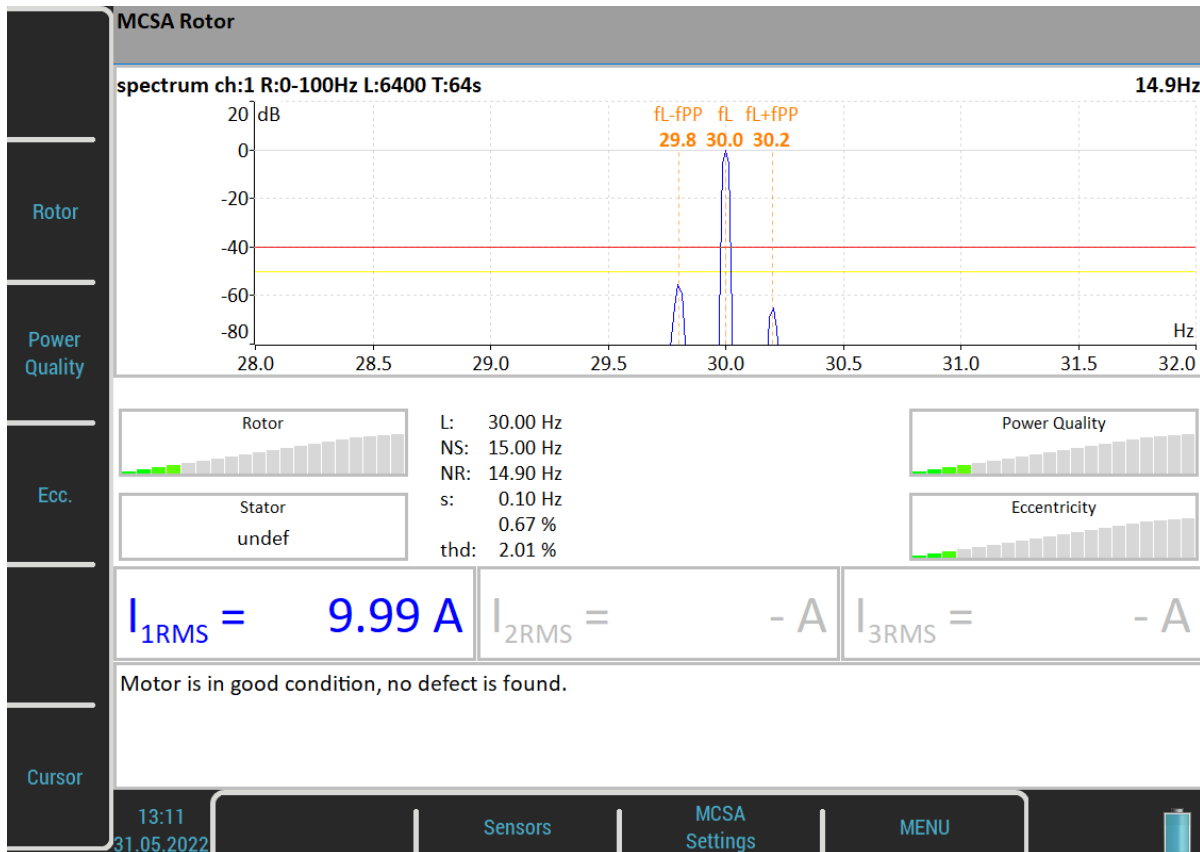

In case you use one phase measurement some indicators are not available. The stator severity is not defined. Of course, phasor diagram and current values are missing.

A4404 – SAB and Virtual Unit

Virtual Unit is the same software used in **VA5** vibration analyzer. You can use the Virtual Unit in demo mode and see the VA5 instrument working environment. In other words, you can download and install the Virtual Unit free of charge and see all the measurement capabilities of the instrument.

You can also use the Virtual Unit to post process your records from real instrument.

Furthermore, the Virtual Unit is designed for measurement with the **A4404 – SAB**.

Installation

A4404 – SAB Drivers Installation

Connect the SAB to computer via USB cable which is a part of SAB accessories. The drivers should be installed automatically from internet. In case you have no internet connection or some problem occurs, follow these instructions:

1. Download a driver file from <https://adash.com/downloads/third-parties-software> or from the supplied SAB installation flash drive.
2. Uncompress the file anywhere on your computer (for example C:\A4404).
3. Connect the A4404 – SAB to your PC via USB cable.
4. The “*Add Hardware Wizard*” window should open when drivers are not found on your PC. Follow the wizard instructions.
5. Select “*Install from a list or specific location*” and click the *Next* button.
6. Check “*Include this location in the search*”.
7. Click the *Browse* button and select the folder, where you uncompressed the driver.
8. Click the *Next* button and wait for installation completing.
9. You may delete the downloaded file and folder with uncompressed driver (not required).

Virtual Unit Installation

Download the Virtual Unit from Adash website <http://www.adash.com/downloads/adash-software> or from SAB installation flash drive. Run the file and follow the installation wizard instructions. You’ll be asked to enter installation destination path (default value is *C:\Program Files (x86)\Adash\Virtual Unit*) and path for working folder where all data of the application will be stored (default value is *C:\ProgramData\Virtual Unit*). In this folder, two subfolders will be created after first run, **data** and **VA5_DISC**. The data folder is equivalent of instrument’s internal disk and the **VA5_DISC** folder is equivalent of instrument’s flash drive (see [General Information / Connection to the computer](#)).

Note! You don’t need to export routes nor other projects to **VA5_DISC** in the Virtual Unit. DDS can find them directly in the data folder.

License file

Each A4404 – SAB device is supplied with a unique license file. The Virtual Unit needs the license file **adashx123456.a44** in order to control the A4404 – SAB (the 123456 is the serial number of A4404). Copy this file from supplied flash drive into the working folder into **data\VA4licence** folder.

Update

To update the software just run the installation file with the newer version. The old version will be replaced. The application data will not be lost.

Operation

If you want to use the A4404 – SAB, plug it before you launch the Virtual Unit application. Computer with the connected SAB and running Virtual Unit then behaves as VA5 instrument.

Live signal is measured only with the A4404 – SAB. Without this device it's possible to post process records. Virtual Unit installation contains one record (*Default Rec*) for demonstration. You can download more Records here <http://adash.com/download/Records.zip>. You can also post process your own records from the instrument.

VA5 Virtual unit and VA5 Pro connection

How to share projects between the instrument and the Virtual Unit will be described in this chapter. Connect the instrument to the computer via USB cable. The instrument will be found as *VA5_DISC* (removable disk) on your system. It's possible to copy the data between Virtual Unit's working folder and instrument's *VA5_DISC*.

Copying projects into the instrument

Copy the *data\VA4analyser\ProjectName* project folder from Virtual Unit's working folder into *VA4analyser* folder on instrument's *VA5_DISC*. Attention! *VA5_DISC* is the real removable storage device here, NOT the Virtual Unit's folder!. You have to create **empty file** with the name **script.dds** in the project folder on the instrument's *VA5_DISC*. This ensures importing the project into instrument's internal disk after entering Analyzer module. Same file is created by DDS.

Runup (*VA4runup* folder), Route (*VA4route* folder) and Octave Analysis (*VA4octave* folder) projects are copied the same way.

Example:

You've got a route called *Power Station* in Virtual Unit and you want to have it in real instrument as well.

1. Connect the instrument with the computer via USB cable. The instrument must be turned off or on main screen.
2. New USB drive called *VA5_DISC* appears among computer's disks.
3. Open *VA4route* folder on *VA5_DISC*.
4. Open *data\Va4route* folder in Virtual Unit's working folder. Find *Power Station* folder in this folder.
5. Copy *Power Station* folder to *VA4route* folder on *VA5_DISC*.
6. Create the empty file **script.dds** in *VA4route\Power Station* on *VA5_DISC*.
7. Enter the Route module in the instrument.
8. The *Power station* route will be automatically imported and shown in project list.

Projects and records copy from the instrument

Attention! Projects have to be exported to the *VA5_DISC* first, same as export for DDS.

Copy *VA4analyser\ProjectName* folder from instrument's *VA5_DISC* folder into Virtual Unit's working folder. In this case you don't need to create *script.dds* file as in the copying into instrument. Runup (*VA4runup* folder), Route (*VA4route* folder), Octave Analysis (*VA4octave* folder), Balancer (*VA4balancer* folder) and Recorder (*VA4recorder* folder) are copied the same way.

Example:

You've got a route called *Power Station* in the instrument and you want to have it in Virtual Unit as well.

1. Open *data\Va4route* folder in Virtual Unit's working folder.
2. Open Route module in the instrument.
3. Select the *Power Station* route.
4. Export the route to *VA5_DISC* using *Route / Export* menu item.
5. Connect the instrument with the computer via USB cable.
6. New USB drive called *VA5_DISC* appears among computer's disks.
7. Open *VA4route* folder on *VA5_DISC*. Find *Power Station* folder in this folder.
8. Copy the *Power Station* folder from into *data\Va4route* folder in the Virtual Unit's working folder.
9. Open Route module in the Virtual Unit. The *Power Station* route is in the list with other routes.

Appendix A: Technical Specification

Inputs

Dynamic Channels (AC)

Number of synchronous parallel channels (AC): 4 AC
 Frequency range (-3dB): 0.35 - max 90000 Hz
 (196 kHz sampling frequency)
 Input range: +/- 12V (only one range, no gains)
 Measurement timing: fully synchronous
 A/D Resolution: 24 bit input, 64 bit double floating point internal precision
 (no gain procedures used!)
 Dynamic range: 120 dB
 Channel configuration: voltage or ICP (individually for every channel)
 Input protection: up to 30 V
 Input impedance: 100 kOhm
 Input type: acceleration, velocity, displacement, any non-vibration AC voltage
 Integration: single, double fully digital integration
 2D Processing: axis rotation according sensor mounting
 Accuracy: < 0.5 %
 ICP drive: 18 V, 3.8 mA
 User HP filtering: 0.35Hz - 12800 Hz
 User LP filtering: 25Hz - 90000 Hz
 Connector: ODU

Tacho Channel

Number: 1 independent tacho input
 Speed range: 0.01Hz - 1000 Hz
 Input impedance: 80 kOhm
 Input type: voltage
 Input range: + 10V (only one range, no gains)
 or +/-30V (tacho signal + DC) with optional tacho signal converter
 Accuracy: <0.5 %
 Trigger level: 0.1 -9.9 V, user defined
 Input protection: up to 48 V
 Connector: ODU

Static Channels (DC or 4-20mA)

Number: 4 DC or 4-20mA (has to be specified in order)
 Input range: +/- 24 V or 4-20mA
 Input impedance: 100kOhm (V-DC), 250 Ohm (4-20mA-DC)
 A/D Resolution: 12 bit input
 Accuracy: 0.1% fsd
 Input protection: up to 30 V

Measurement Functions

Data Analysis Speed: 0.1 sec for 25600 lines FFT spectrum
 Amplitude Units: Metric, Imperial (English) or user programmable
 Frequency Units: Hz, CPS, RPM, CPM, Orders
 Amplitude scale: Acceleration, Velocity, Displacement, User defined
 Scaling: Linear or Log, both X and Y axes
 Cursor: Single, Harmonics, Sidebands
 Triggering: free run
 tacho
 amplitude (positive or negative)

external (voltage)

Signal Range: full, No Auto ranging

Data acquisition: TRUE RMS, TRUE PEAK, TRUE PEAK-PEAK overall or band values

user defined high, low and band pass filters for band measurement

time waveforms (8 388 608 samples max)

real-time FFT

3D graphs (waterfall, cascade)

order analysis

Amplitude + phase values on speed frequency

speed measurement

process static DC or 4-20mA values

Envelope demodulation

ACMT procedure for low speed machines bearings

Time waveform samples: 256 – 8 388 608

Waveform (ACMT) length: max 131 072 sec (36 hours)

Spectrum ranges: 25 – 90 000 Hz

Spectrum lines: 100 – 3 276 800

Spectrum Peaks listing: yes

Spectrum units: RMS, 0-P and P-P

Windows: Rectangular, Hanning, Exponential, Transient

Order analysis parameters: 1/2 - 10th order

Averaging: 1-255

Overlap: yes

Smax, Gap and Centerline displays for proximity sensors: yes

Recording:

Sampling frequency: user defined in range 64Hz - 196 kHz

Record length example: 3 GB for 1 hour record with 64kHz sampling (4ch AC+4ch DC+1ch tacho signal)

(100GB memory enables over 30 hours of full 64kHz recording,
lower sampling frequency enables much longer record))

Balancing:

Planes: 1 or 2

Speed range: 0,5 Hz - 1000 Hz

Balancing Advisor for automatic fault detection: yes

Balancing Quality factor according ISO1940: yes

Balancing vector graph for balancing process reporting: yes

Balancing Report: yes

Trim function: yes

Vector split (for example to blades positions): yes

Manual entry: yes

Intuitive graphic user interface: yes

Trial mass: get out or leave in

General:

Processor: Atom 1.9 GHz

RAM: 2 GB

Display: LCD color 191 x 134 mm (9.1" diagonal), 1140x800 resolution

Memory (Internal SSD): 64 GB

Memory (VA5_DISC flash): 16 GB

Interface: USB

Powering: Li-Ion long life battery pack (more then 8 hours of measurement)

Operating temperature: -10 °C - +50 °C, 15°F-120°F

EMC: CE tested

Dimensions: 280 x 205 x 55 mm

Weight: 2.2 kg

Camera:

Resolution: 5 mpx, 2592 x 1944 px
Focus: auto

IR camera:

Array format: 384 x 288 px
Temperature Range: -10°C ~ 250°C (-10°C ~ 150°C)
Lens: 6.8mm F 1.3
NETD: < 50mK

Appendix B : Phase measurement conventions

Single channel measurement with tachometer

Let's assume the time signal defined as $y = \cos(\omega t)$. We use the cosine function because FFT uses it too. It simplifies the calculations and understanding.

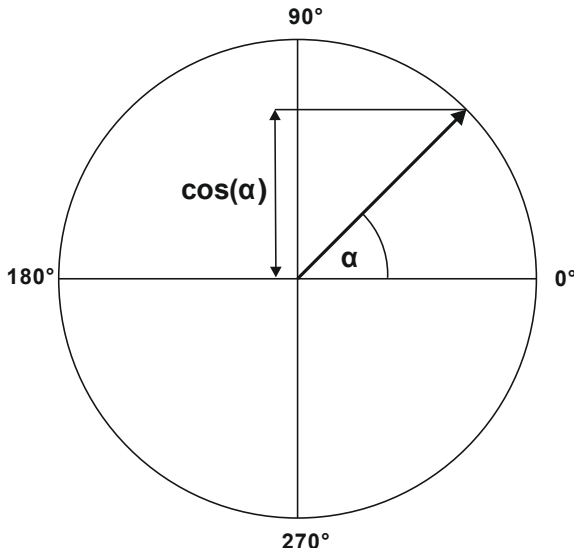

Our starting position of rotating vector V will be 90° , we will mark it as T_0 .

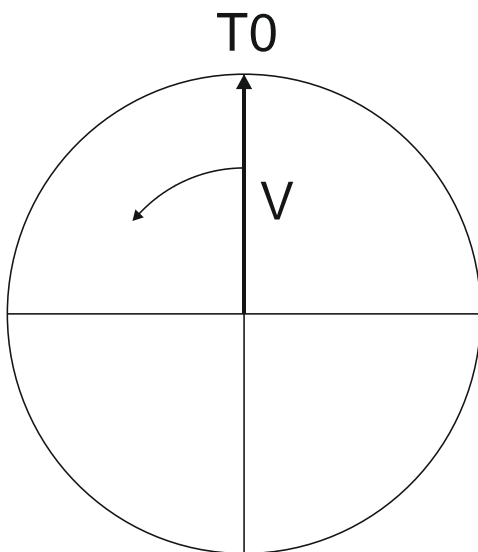

When the vector V rotates for example 3 times, then we get the time signal as follows.

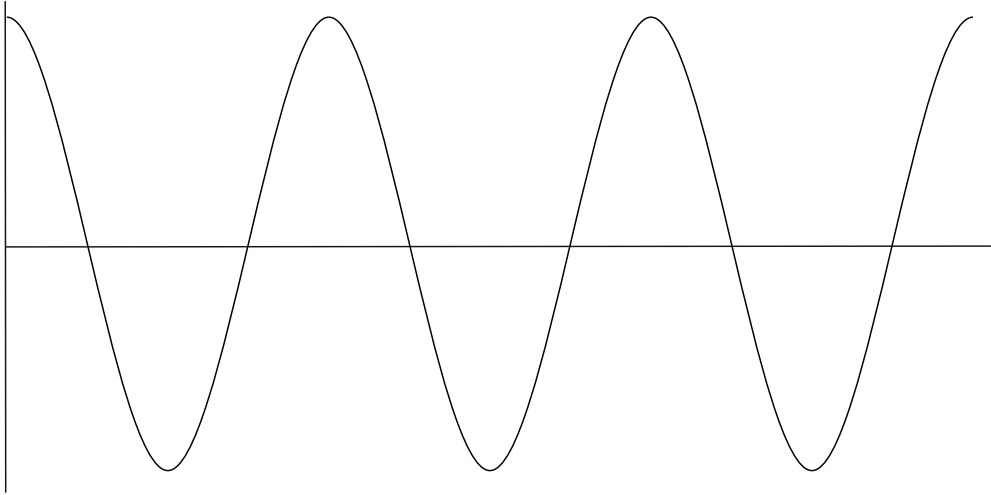

Now we assume the tacho signal. The tacho pulse we put to the T0 position.

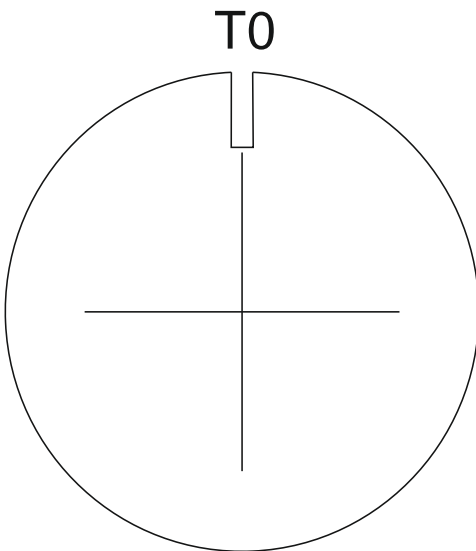

Corresponding time signal with tacho pulses is on the following picture.

Now we begin to assume the phase shift (marked as φ) of time signal vs. tacho signal. The signal formula changes to $y = \cos(\omega t + \varphi)$. The previous picture corresponds with $\varphi = 0^\circ$. And this value is displayed on the instrument screen. When the tacho pulses are in the maximum time signal positions, then phase value is equal to zero.

Now assume the $\varphi = 45^\circ$. We use the degrees unit to make it simple for all readers. The radians have to be used in exact math formula.

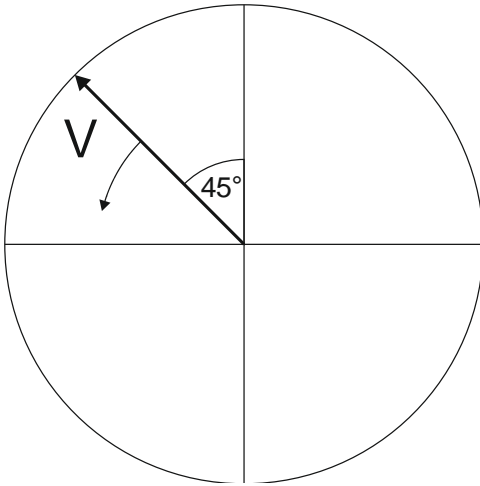

On the next picture is the corresponding time signal with tacho pulses.

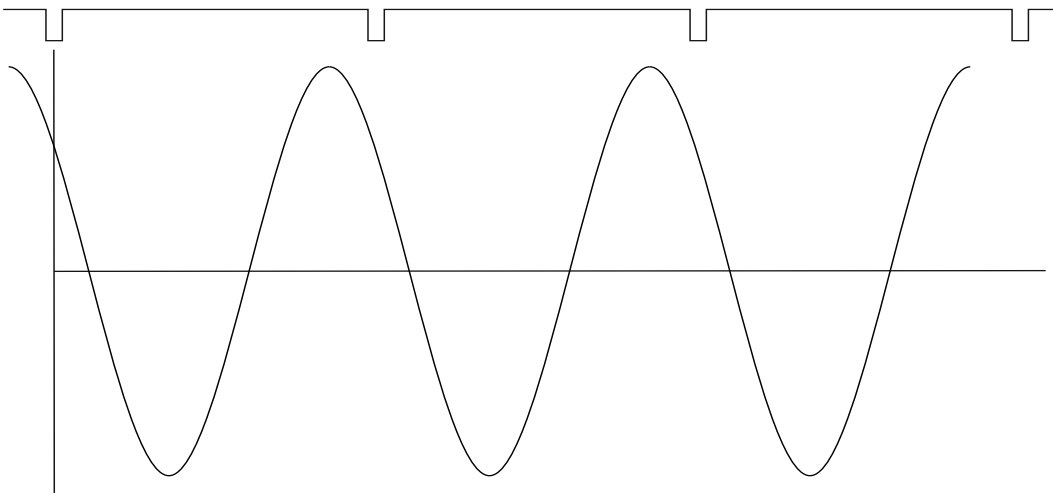

The time signal foreruns (gets ahead of) the tacho signal of the 45° . The 45° appears on instrument screen in this case.

Now we assume the $\varphi = -45^\circ$.

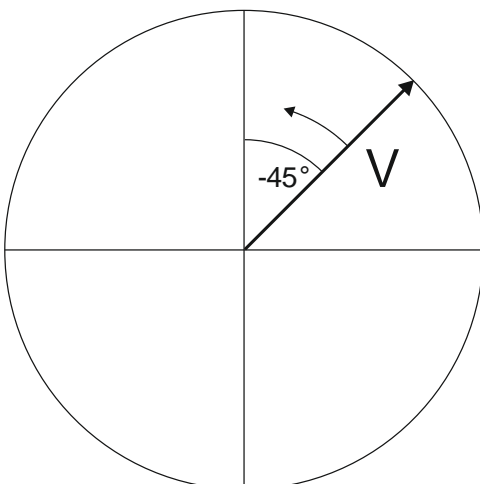

On the next picture is the corresponding time signal.

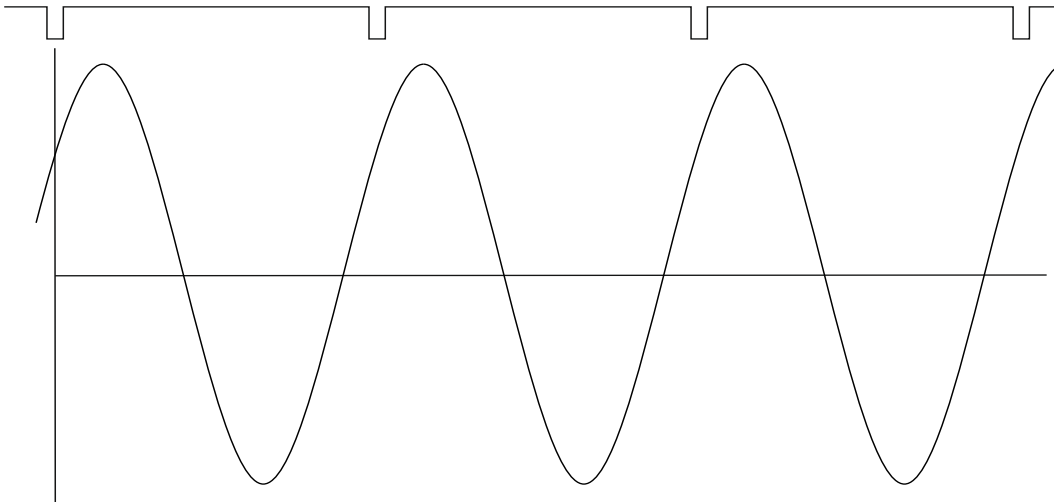

The time signal is delayed. The -45° appears on instrument screen in this case.

This approach is used for single channel measurement as amp+phase and orders.

Dual channel measurement

We must always define the channels of A and B. For example we use channel 1 as A and channel 2 as B. You have to always assign the channel numbers of A and B. The A represents the input channel and B the output channel. You can imagine it as black box and you need to measure the phase response of that.

You see on the display for example this:

$\Phi_B - \Phi_A: +59.9^\circ$

The logic is the same as for single channel measurement. The A has the same function as tacho signal. This 60° means that B is ahead (foreruns) the A of 60° .

This approach is used for double channel measurements as phase shift and frf.

Last reminder

We talk about time signals and their positions in time in this chapter. We have used a words such as “signal is ahead”, “foreruns” and on the other side that signal is delayed.

You should always keep in mind:

To be ahead of for example 60° is the same as to be delayed of 300° . Don't forget that we are working with periodic pure cosine time waveform.

Appendix C: Symbols and Abbreviations

Inputs

AC1 – AC4	alternating current signal, channel 1 – 4
DC1 – DC4	direct current signal, channel 1 – 4

Abbreviations in Graphs

ch	channel, input
NS	number of samples
R	number of revolutions
L	number of lines
B	frequency band
R	frequency range
FS, fs	sampling frequency
Y	y value on cursor's position
t	cursor position on time axe
f	cursor position on frequency axe
df	frequency resolution (delta)
A	A value on cursor's position (orbit, center line)
B	B value on cursor's position (orbit, center line)
A	amplitude value on cursor's position (spectrum, frf)
P	phase value on cursor's position
Coh	coherence value on cursor's position
Re	real value on cursor's position
Im	imag value on cursor's position
X	value calculated from signals A and B to axe X (orbit, center line)
Y	value calculated from signals A and B to axe Y (orbit, center line)
S	speed value
D	difference value
d	delta cursor length
b	value of the band bounded by delta cursor in spectrum
tot	value of the whole band in spectrum
RMS, 0P	rms and 0P value in the time signal bounded by delta cursor
totRMS, tot0P	rms and 0P value in the whole time signal
HYPERLINK \l "_toc2720"	