



Technical Specifications *

- Accuracy: < 2% of FS range under constant conditions
- Analysis: 0-10, 0-100, 0-1000 PPM, 0-1%, 0-25% (CAL) FS
Auto-ranging or manual lock on a single range
- Application: Oxygen analysis in inert, hydrocarbon, helium, hydrogen, mixed and acid (CO₂) gas streams
- Approvals: Certified for use in hazardous areas - see lower right
UL: United States: UL 1203, UL 913, UL 508
Canada: CAN/CSA C22.2 No. 30-M1986,
CAN/CSA C22.2 No. 157-92,
CAN/CSA C22.2 No. 14-10
ATEX: Directive 94/9/EC
- Area Classification: Certified for use in hazardous areas - see lower right
- Alarms: Two user configurable alarms: magnetic coil relays rated 3A at 100 VAC, programmable alarm delays, alarm bypass for calibration and system fail alarm
- Calibration: Max interval—3 months. Use certified span gas with O₂ content (balance N₂) approximating 80% of full scale for fast 20-30 minute recovery to online use. Alternatively, air calibrate with clean source of compressed or ambient (20.9% O₂) air on 0-25% range and allow 60 minutes on zero gas to recover to 10 ppm. For optimum accuracy, calibrate one range higher than the range of interest.
- Compensation: Barometric pressure and temperature (ATEX); Temperature (cUL)
- Connections: 1/8" compression tube fittings
- Controls: Water resistant keypad; menu driven range selection, calibration and system functions
- Display: **Graphical LCD 2.75" x 1.375"; resolution 0.01 PPM;** displays real time ambient temperature and pressure
- Enclosure: NEMA Type 3R suitable for rain in outdoor applications (UL); NEMA 4X (ATEX)
- Flow: Not flow sensitive; recommended flow rate 1-2 SCFH
- Linearity: ±2% of full scale
- Pressure: Inlet - regulate to 5-30 psig to deliver 1-2 SCFH flow; vent - atmospheric
- Power: 12-28 VDC (ULc and ATEX Certified)
110-220 VAC (ATEX Certified)
- Response Time: 90% of final reading in 10 seconds
- Sample System: Sample flow meter; options available, see other side
- Sensitivity: < 0.5% of FS range
- Sensor Model: XLT-12-333 for gases containing > 0.5% CO₂
- Sensor Life: 24 months in < 1000 PPM O₂ at 25°C and 1 atm
- Signal Output: 4-20mA or 1-5V; optional Modbus RTU communication
- Operating Range: 5°C to 45°C (GPR sensor); -10° to 45°C (XLT sensor)
- Warranty: 12 months analyzer; 12 months sensor
- Wetted Parts: Stainless steel

Optional Equipment

- Sample conditioning systems (see back page) - Contact factory
- GPR-12-333 sensor for non-acid (CO₂) gas streams

* Specifications subject to change without notice

ULc & ATEX Certified for Hazardous Areas



GPR-1800 AIS PPM Oxygen Analyzer

Full Featured PPM Oxygen Analyzer with Optional Modbus RTU Communication and Modular Natural Gas Sample Systems

Exia
CLASSIFIED
UL US
UL Certified
File E343386
Class I, Division 1, Groups C and D
T4 T_{amb} -20°C to +50°C

ATEX Certified - Directive 94/9/EC
Examination Cert: INERIS 08ATEX0036
II 2 G
Ex d ib IIB T4 Gb
T_{amb} -20°C to +50°C
CE
0080

ISO 9001:2008 Certified
INTERTEK Certificate No. 485
INTERTEK
ISO 9001:2008

GPR-1800 AIS PPM OXYGEN ANALYZER



Shown with optional Sampling System

Owner's Manual

Revised May, 2014

Table of Contents

Introduction		1
Quality Control Certification		2
Safety		3
Features & Specifications		4
Operation		5
Maintenance		6
Spare Parts		7
Troubleshooting		8
Warranty		9
Material Safety Data Sheets		10
Drawings		A/R
Explosion Proofing Electrical Connections	Appendix	A
Correlating readings – LCD display to 4-20mA signal output	Appendix	B
H2S Scrubber, Sample System, Media MSDS	Appendix	F
Maintenance H2S Scrubber & Coalescing Filter	Appendix	G

The appendices referenced above are an integral part of the documentation, installation and maintenance of this analyzer to comply with all applicable directives. It is important that users review these documents before proceeding.

1. Introduction

Your new oxygen analyzer incorporates an advanced electrochemical sensor specific to oxygen along with state-of-the-art digital electronics designed to give you years of reliable precise oxygen measurements in a variety of industrial oxygen applications. More importantly, it has been constructed as explosion proof/intrinsically safe in accordance with Safety Standards: UL 913 Seventh Edition, Referencing UL 60079-0:2005 and UL 60079-11:2009 and CSA C22.2 No. 157-92 Third Edition for use in Class I, Div 1, Groups C and D hazardous locations and the ATEX Directives 94/9/EC for zone 1 Group IIB.

Analytical Industries Inc.
dba Advanced Instruments Inc.
2855 Metropolitan Place, Pomona, CA 91767 USA

GPR-1500 AIS/2500 AIS



Serial No.:

Year of Manufacture:

INERIS 08ATEX0036

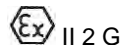

Ex d IIB T4 Gb

T_{amb} -20°C to +50°C



WARNING: POTENTIAL ELECTROSTATIC CHARGING HAZARD – SEE INSTRUCTIONS

Please refer to Appendix A for making electrical connections that maintains the desired level of protection.

To obtain maximum performance from your new oxygen analyzer, please read and follow the guidelines provided in this Owner's Manual.

Every effort has been made to select the most reliable state of the art materials and components, to design the analyzer for superior performance and minimal cost of ownership. This analyzer was tested thoroughly by the manufacturer prior to shipment for best performance.

However, modern electronic devices do require service from time to time. The warranty included herein plus a staff of trained professional technicians to quickly service your transmitter is your assurance that we stand behind every transmitter sold.

The serial number of this analyzer may be found on the inside the analyzer enclosure. You should note the serial number in the space provided and retains this Owner's Manual as a permanent record of your purchase, for future reference and for warranty considerations.

Serial Number: _____

Advanced Instruments Inc. appreciates your business and pledges to make every effort to maintain the highest possible quality standards with respect to product design, manufacturing and service.

3. General Safety & Installation

This section summarizes the essential precautions applicable to the GPR-1500 AIS Oxygen Analyzer. Additional precautions specific to individual transmitter are contained in the following sections of this manual. To operate the transmitter safely and obtain maximum performance follow the basic guidelines outlined in this Owner's Manual.



Caution: This symbol is used throughout the Owner's Manual to Caution and alert the user to recommended safety and/or operating guidelines.



Warning: This symbol is used throughout the Owner's Manual to Warn and alert the user of the presence of electrostatic discharge.



Danger: This symbol is used throughout the Owner's Manual to identify sources of immediate Danger such as the presence of hazardous voltages.

Read Instructions: Before operating the transmitter read the instructions.

Retain Instructions: The safety precautions and operating instructions found in the Owner's Manual should be retained for future reference.

Heed Warnings: Follow all warnings on the transmitter, accessories (if any) and in this Owner's Manual.

Follow Instructions: Observe all precautions and operating instructions. Failure to do so may result in personal injury or damage to the transmitter.

Analyzer label ULc

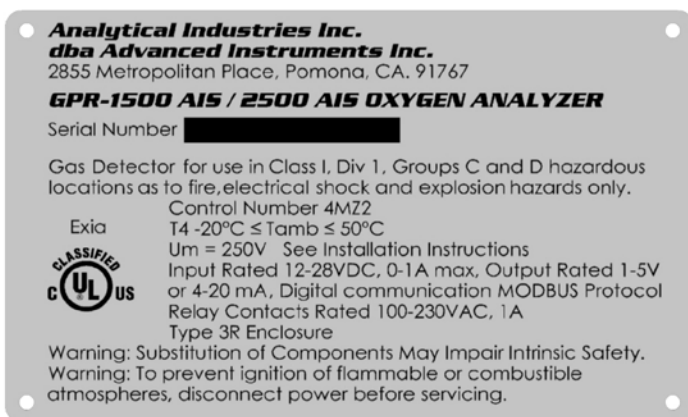

WARNING – Potential Explosion Hazard: The devices are not intended for use in atmospheres or with sample gas streams containing oxygen concentration greater than 21 percent by volume (ambient air) and are only intended for use in gases or gas mixtures classified as Class I, Div 1, Groups C and D hazardous locations or in non-hazardous locations, when used in the United States or Canada.

2. Quality Control Certification

Maintenance

Serviceability: Except for replacing the oxygen sensor, there are no parts inside the analyzer for the operator to service. Only trained personnel with the authorization of their supervisor should conduct maintenance.

WARNING- Substitution of Components May Impair Intrinsic Safety

Oxygen Sensor: DO NOT open the sensor. The sensor contains a corrosive liquid electrolyte that could be harmful if touched or ingested, refer to the Material Safety Data Sheet contained in the Owner's Manual appendix. Avoid contact with any liquid or crystal type powder in or around the sensor or sensor housing, as either could be a form of electrolyte. Leaking sensors should be disposed of in accordance with local regulations.

Troubleshooting: Consult the guidelines in Section 8 for advice on the common operating errors before concluding that your analyzer is faulty. Do not attempt to service the analyzer beyond those means described in this Owner's Manual.

Do not attempt to make repairs by yourself as this will void the warranty as per Section 10 and may result in electrical shock, injury or damage. All other servicing should be referred to qualified service personnel.

Cleaning: The analyzer should be cleaned only as recommended by the manufacturer. Wipe off dust and dirt from the outside of the unit with a soft damp cloth then dry immediately. Do not use solvents or chemicals.

Nonuse Periods: If the analyzer is equipped with a range switch advance the switch to the OFF position and disconnect the power when the transmitter is left unused for a long period of time.

Installation

This analyzer has been constructed in compliance with

EN 60079-0 : 2009

EN 60079-1 : 2007

EN 60079-11 : 2012

For USA and Canada

UL 913, 7th Edition

CSA C22.2 No. 157-92

It must be installed in accordance with

EN 60079-14

For USA - NEC and Canada – CEC Standards

WARNING - Potential Explosion Hazard – See Warning in Section 4 – Features and Specifications

Gas Sample Stream: Ensure the gas stream composition of the application is consistent with the specifications and if in doubt, review the application and consult the factory before initiating the installation. **Note:** In natural gas applications such as extraction and transmission, a low voltage current is applied to the pipeline itself to inhibit corrosion of the pipeline. As a result, electronic devices connected to the pipeline can be affected unless they are adequately grounded.

Contaminant Gases: A gas scrubber and flow indicator with integral metering valve are required upstream of the analyzer to remove any interfering gases such as oxides of sulfur and nitrogen or hydrogen sulfide that can interfere with measurement and cause reduction in the expected life of the sensor. Consult the factory for recommendations concerning the proper selection and installation of components.

Expected Sensor Life: With reference to the publish specification located at the last page of this manual, the expected life of all oxygen sensors is predicated on oxygen concentration (< 1000 ppm for PPM sensor or air for % sensor), temperature (77°F/25°C) and pressure (1 atmosphere) in "normal" applications. Deviations from standard conditions will affect the life of the sensor. As a rule of thumb sensor life is inversely proportional to changes in the pressure and temperature.

Accuracy & Calibration: Refer to section 5 Operation.

Materials: Assemble the necessary zero, sample and span gases and optional components such as valves, coalescing or particulate filters, and pumps as dictated by the application. Stainless steel tubing is essential for maintaining the integrity of the gas stream for low % or PPM O₂ level analysis.



Operating Temperature: The sample must be sufficiently cooled before it enters the analyzer and any optional components. A coiled 10 foot length of ¼" stainless steel tubing is sufficient for cooling sample gases as high as 1,800 °F to ambient. The recommended operating temperature is below 35 °C. However, the analyzer may be operated at temperature up to 45 °C on an intermittent basis but the user is expected to accept a reduction in expected sensor life –as a rule of thumb, for every degree °C increase in temperature (above 25 °C), the sensor life is reduced by approximately 2.5%.

Warning – Sample Stream entering unit must never exceed 50 °C

Heat: Situate and store the analyzer away from direct sources of heat.

Liquid and Object Entry: The analyzer should not be immersed in any liquid. Care should be taken so that liquids are not spilled into and objects do not fall into the inside of the analyzer.

Handling: Do not use force when using the switches, knobs or other mechanical components. Before moving your analyzer be sure to disconnect the wiring/power cord and any cables connected to the output terminals of the analyzer.

Sample Pressure and Flow

All electrochemical oxygen sensors respond to partial pressure changes in oxygen. The sensors are equally capable of analyzing the oxygen content of a flowing sample gas stream or monitoring the oxygen concentration in ambient air (such as a confined space in a control room or an open area around a landfill or bio-pond). The following is applicable to analyzers equipped with fuel cell type oxygen sensors.

Analyzers designed for in-situ ambient or area monitoring has no real sample inlet and vent. The sensor is exposed directly to the sample gas and it is intended to operate at atmospheric pressure. The analyzer has a built-in pressure sensor and the sensor output is automatically compensated for any atmospheric pressure changes.

Inlet Pressure: For the analyzers designed to measure oxygen in a flowing gas stream, the inlet sample pressure must be regulated between 5-30 psig. Although the rating of the SS tubing and tube fittings/valves itself is considerably higher (more than 100 psig), a sample pressure of 5-30 psig is recommended for ease of control of sample flow.

The analyzer equipped with a sample system has designated SAMPLE and VENT ports. Connect SAMPLE gas to SAMPLE and the vent to the VENT ports only.



Caution: If the analyzer is equipped with an optional H₂S scrubber, sample inlet pressure must not exceed 30 psig.

Outlet Pressure: In applications where sample pressure is positive, the sample must be vented to an exhaust pipe at a pressure less than the inlet pressure so that the sample gas can flow through the sensor housing. Ideally, the sample must be vented to atmospheric pressure.

Note: The sensor may be used at a slight positive pressure (e.g., when sample is vented to a common exhaust where the pressure might be higher than 1 atmosphere). However, the pressure at the sensor must be maintained at all times including during the span calibration. This may be accomplished by using a back-pressure regulator at vent line of the analyzer. **Caution:** A sudden change in pressure at the sensor may result in the sensor electrolyte leakage.

Flow rates of 1-5 SCFH cause no appreciable change in the oxygen reading. However, flow rates above 5 SCFH may generate a slight backpressure on the sensor resulting in erroneous oxygen readings.

Caution: Do not place your finger over the vent (it pressurizes the sensor) to test the flow indicator when gas is flowing to the sensor. Removing your finger (the restriction) generates a vacuum on the sensor and may damage the sensor (voiding the sensor warranty).

Application Pressure - Positive: A flow indicator with integral metering valve positioned upstream of the sensor is recommended for controlling the sample flow rate between 1-5 SCFH. If a separate flow control valve and a flow indicator is used, position flow control valve upstream of the sensor and position a flow indicator downstream of the sensor. If necessary, a pressure regulator upstream of the flow control valve should be used to regulate the inlet pressure between 5-30 psig.



Caution: If the analyzer is equipped with a H₂S scrubber as part of an optional sample conditioning system, inlet pressure must not exceed 30 psig.

Application Pressure - Atmospheric or Slightly Negative: For % oxygen measurements, an optional external sample pump may be used upstream of the sensor to push the sample across the sensor and out to

atmosphere. For PPM oxygen measurements, an optional external sampling pump should be positioned downstream of the sensor to draw the sample from the process, by the sensor and out to atmosphere. A flow meter is generally not necessary to obtain the recommended flow rate with most sampling pumps. However, if the sample pump can pull/push more than 5 SCFH, a flow control must be used to control the sample flow. The flow control valve must be positioned in such a way that it does not generate any vacuum on the sensor.



Caution: If the analyzer is equipped with a flow indicator with integral metering valve or a metering flow control valve upstream of the sensor and the pump is installed downstream of sensor- open the metering valve completely before turning the pump ON to avoid drawing a vacuum on the sensor and placing an undue burden on the pump.

If pump loading is a consideration, a second throttle valve on the pump's inlet side may be necessary to provide a bypass path so the sample flow rate is within the above parameters.

Moisture & Particulates: Installation of a suitable coalescing or particulate filter is required to remove condensation, moisture and/or particulates from the sample gas to prevent erroneous analysis readings and damage to the sensor or other optional components. Moisture and/or particulates do not necessarily damage the sensor. However, collection of moisture/particulate on the sensing surface can block or inhibit the diffusion of sample gas into the sensor resulting in a reduction of sensor signal output – and the appearance of a sensor failure. Consult the factory for recommendations concerning the proper selection and installation of optional components.

Moisture and/or particulates generally can be removed from the sensor by opening the sensor housing and either blowing on the sensing surface or gently wiping or brushing the sensing surface with damp cloth. **Caution:** Minimize the exposure of PPM sensors to air during this cleaning process. Air calibration followed by purging with zero or a gas with a low PPM oxygen concentration is recommended after the cleaning process is completed.

Mounting: The analyzer is approved for indoor as well as outdoor use. However, avoid mounting in an area where direct sun might heat up the analyzer beyond the recommended operating temperature range. If possible, install a small hood over the analyzer for rain water drain and to prevent over-heating of analyzer.

Gas Connections: The Inlet and outlet vent gas lines require 1/8" or 1/4" stainless steel compression type tube fittings. The sample inlet tubing must be metallic, preferably SS. The sample vent line may be of SS or hard plastic tubing with low gas permeability.

Power: Supply power to the analyzer only as rated by the specification or markings on the analyzer enclosure. The GPR-1500 AIS is powered by 12-28 VDC supply. The wiring that connects the analyzer to the power source should be installed in accordance with recognized electrical standards. Ensure that the analyzer case is properly grounded and meets the requirements for area classification where the analyzer is installed. Never yank wiring to remove it from a terminal connection.

The maximum power the analyzer consumes is no more than 7 Watts.

4. Features & Specifications



Advanced Instruments Inc.

Technical Specifications *

Accuracy: < 2% of FS range under constant conditions

Analysis: 0-10, 0-100, 0-1000 PPM, 0-1%, 0-25% (CAL) FS
Auto-ranging or manual lock on a single range

Application: Oxygen analysis in inert, hydrocarbon, helium, hydrogen, mixed and acid (CO₂) gas streams

Approvals: Certified for use in hazardous areas - see lower right
 UL: United States: UL 1203, UL 913, UL 508
 Canada: CAN/CSA C22.2 No. 30-M1986,
 CAN/CSA C22.2 No. 157-92,
 CAN/CSA C22.2 No. 14-10
 ATEX: Directive 94/9/EC

Area Classification: Certified for use in hazardous areas - see lower right

Alarms: Two user configurable alarms: magnetic coil relays rated 3A at 100 VAC, programmable alarm delays, alarm bypass for calibration and system fail alarm

Calibration: 3 month interval using certified span gas (preferred for fastest online time) or air with O₂ value approximating 80% of full scale range balance N₂

Compensation: Barometric pressure and temperature

Connections: 1/8" compression tube fittings

Controls: Water resistant keypad; menu driven range selection, calibration and system functions

Display: Graphical LCD 2.75" x 1.375"; resolution 0.01 PPM; displays real time ambient temperature and pressure

Enclosure: NEMA Type 3R suitable for rain in outdoor applications

Flow: Not flow sensitive; recommended flow rate 1-2 SCFH

Linearity: ±2% of full scale

Pressure: Inlet - regulate to 5-30 psig to deliver 1-2 SCFH flow; vent - atmospheric

Power: 12-28 VDC (ULc and ATEX Certified)
110-220 VAC (ATEX Certified)

Response Time: 90% of final reading in 10 seconds

Sample System: Sample flow meter; options available, see other side

Sensitivity: < 0.5% of FS range

Sensor Model: XLT-12-333 for gases containing > 0.5% CO₂

Sensor Life: 24 months in < 1000 PPM O₂ at 25°C and 1 atm

Signal Output: 4-20mA; optional Modbus RTU communication

Operating Range: -20° to 45°C (XLT); -10 °C to 45°C (GPR sensor)

Warranty: 12 months analyzer; 12 months sensor

Wetted Parts: Stainless steel

ULc & ATEX Certified for Hazardous Areas



GPR-1800 AIS
PPM Oxygen Analyzer

Full Featured PPM Oxygen Analyzer with
Optional Modbus RTU Communication and
Modular Natural Gas Sample Systems

Exia



CLASSIFIED
C UL US

UL Certified

File E343386

Class I, Division 1, Groups C and D
T4 T_{amb} -20°C to +50°C

ATEX Certified - Directive 94/9/EC

Examination Cert: INERIS 08ATEX0036



II 2 G
Ex d ib IIB T4 Gb
T_{amb} -20°C to +50°C



0080

ISO 9001:2008 Certified

INTERTEK Certificate No. 485



2855 Metropolitan Place, Pomona, CA 91767 USA ♦ Tel: 909-392-6900, Fax: 909-392-3665, www.aii1.com, e-mail: info@aii1.com Rev 6/12

***WARNING - Potential Explosion Hazard :** The devices are not intended for use in atmosphere or with sample gas streams containing more than 21% oxygen (ambient air) and are only intended for use with or in gases or gas mixtures

classified as Class I, Div 1 Groups C and D hazardous location gases or in non-hazardous locations when used in the United States or Canada.

****NOTE 1:** Optional Sampling system shown is not part of UL/cUL Classification.

5. Operation

Principle of Operation

The GPR-1800 AIS Oxygen Analyzer incorporates a variety of advanced galvanic fuel cell type oxygen sensors. These sensors are very specific to oxygen and generate an electrical signal proportional to the amount of oxygen present in a gas stream. The selection of A particular type of sensor depends on the composition of the sample gas stream. Consult the factory for recommendation.

The analyzer is configured in two sections. The signal processing electronics and sensor are housed in a general purpose NEMA 4X rated enclosure. The terminals for incoming power, signal output and intrinsic safety barriers are mounted on a PCB housed in an explosion proof enclosure.

The two sets of electronics are interconnected using an explosion proof Y-fitting, explosion proof packing fiber and sealing cement – see Appendix A. Once connected, the intrinsic safety barriers limit the amount of power that flows to and from the signal processing electronics effectively preventing an explosive condition. The analyzer design conforms to the ATEX directive for equipment as intrinsically safe and has been approved by an independent body:

The analyzer carries the following area classification



II 2 G

Ex d ib IIB T4 Gb

T_{amb} -20°C to +50°C



WARNING: POTENTIAL ELECTROSTATIC CHARGING HAZARD-SEE INSTRUCTION

For USA and Canada
UL 913, 7th Edition
CSA C22.2 No. 157-92

It must be installed in accordance with
EN 60079-14
For USA - NEC and Canada – CEC Standards

The GPR-1800 AIS also meets the intrinsic safety standards required for use in Class I, Division 1, Groups C, D hazardous areas.

Advanced Galvanic Sensor Technology

All galvanic type sensors function on the same principle and are specific to oxygen. They measure the partial pressure of oxygen from low PPM to 100% levels in inert gases, gaseous hydrocarbons, helium, hydrogen and mixed gases

Design Objectives

- Improve quality and reliability through a proprietary controlled manufacturing process . . .
- Comply with domestic and international quality standards
- Compact disposable dimensions
- No sensor maintenance
- Improve performance over replacement sensors - sensitivity, stability, response, recovery
- Longer operating and shelf life - translate into longer warranty period
- Low cost of ownership

% Oxygen Sensors

- Extend operating life to 10 years in air (20.9% O₂) . . .
24 months in continuous 100% O₂
- Extended operating range to -40° C/F to 50° C
- Excellent stability at elevated pressure . . .
Up to 10 atmospheres in hyperbaric chambers
- Superior compatibility with 0.5 - 100% CO₂ gas streams
24 month operating life in traditional dimensions
- Develop special sensor for fast response and long life
Large cathode with proprietary electrolytes and anodes

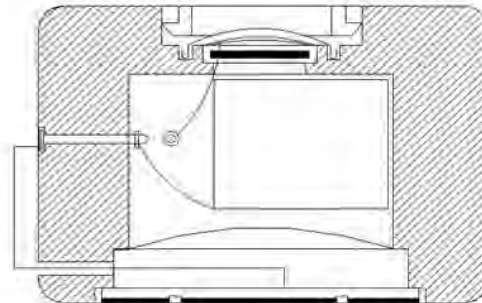

GPR/XLT 11 Series % Oxygen Sensor

s electrochemical transducer, diffusing into the sensor, reacts electrochemically at the sensing electrode to produce an electrical current output proportional to the oxygen concentration in the gas phase. The sensor's signal output is linear over all measuring ranges and remains virtually constant over its useful life. The sensor requires no maintenance and is easily and safely replaced at the end of its useful life.

Proprietary advancements in design and chemistry add significant advantages to this extremely versatile oxygen sensing technology. Sensors for low % analysis recover from air to low % levels in seconds, exhibit longer life and reliable quality. The expected life of our new generation of percentage range sensors now range from 32 months to ten years with faster response times and greater stability. Another significant development involves expanding the operating temperature range for percentage range sensors from -30°C to 50°C. Contact factory for more specific information about your application.

NOTE- Check the product label for safe operating conditions

The PPM sensors recover from an upset condition to low PPM level in a matter of few minutes. These sensors show excellent stability over its useful life.

Electronics

The signal generated by the sensor is processed by state of the art low power micro-processor based digital circuitry. The first stage amplifies the signal. The second stage eliminates the low frequency noise. The third stage employs a high frequency filter and compensates for signal output variations caused by ambient temperature changes. The result is a very stable signal. Sample oxygen is analyzed very accurately. Response time of 90% of full scale is less than 10 seconds (actual experience may vary due to the integrity of sample line connections, dead volume and flow rate selected) on all ranges under ambient monitoring conditions. Sensitivity is typically 0.5% of full scale of the low range. Oxygen readings may be recorded by an external device via the 4-20 mA or 1-5V signal output.

O
x
y
g
e
n
,

t
h
e

f
u
e
l

f
o
r

t
h
i

Sample System

See Section 4, Features and Specification, Note 1 for exclusions.

The standard GPR-1800 AIS is supplied without a sample conditioning system thereby giving users the option of adding their own or purchasing a factory designed sample conditioning system, see section 2 QC Certification for optional equipment ordered. Whatever the choice, the sample must be properly conditioned before introducing it to the sensor to ensure an accurate measurement.

The GPR-1800 AIS is generally supplied with a minimum of a sample flow control valve and a flow meter. Users interested in adding their own sample conditioning system should consult the factory. Advanced Instruments Inc. offers a full range of sample handling, conditioning and expertise to meet your application requirements. Contact us at 909-392-6900 or e-mail us at info@aii1.com.

Calibration & Accuracy Overview

Single Point Calibration: As previously described the galvanic type oxygen sensor generates an electrical current proportional to the oxygen concentration in the sample gas. In the absence of oxygen the sensor exhibits an absolute zero, e.g. the sensor does not generate a current output in the absence of oxygen. Given these linearity and absolute zero properties, single point calibration is possible.

Pressure: Because sensors are sensitive to the partial pressure of oxygen in the sample gas, their output is a function of the number of molecules of oxygen 'per unit volume'. Readouts in percent are permissible only when the total pressure of the sample gas being analyzed remains constant. The pressure of the sample gas and that of the calibration gas must be the same.

Temperature: The rate at which oxygen molecules diffuse into the sensor is controlled by a Teflon membrane otherwise known as an 'oxygen diffusion limiting barrier' and all diffusion processes are temperature sensitive, the fact the sensor's electrical output will vary with temperature is normal. This variation is relatively constant (2.5% per °C). A temperature compensation circuit employing a thermistor and a network of resistors offsets this effect with an accuracy of $\pm 5\%$ or better over a wide operating temperature range e.g., 5-45 °C can be obtained thus the signal output remains virtually independent of ambient temperature. There is extremely low error in measurement if the calibration and sampling are performed at similar temperatures (within ± 5 °C. Conversely, a temperature variation of 10 °C may produce an error of $< 2\%$ of full scale.

Accuracy: In light of the above parameters, the overall accuracy of an analyzer is affected by two types of errors: 1) 'percent of reading errors', illustrated by Graph A below, is contributed by the temperature compensation circuit (tolerance in the thermistor value, variation in temperature coefficient of the thermistor, tolerances in resistors values and the accuracy in the measuring devices, e.g., LCD display and 2) 'percent of full scale errors', illustrated by Graph B, such as 1-2% offset errors in readout and calibration devices. Other errors are 'spanned out' during calibration, especially when analyzer is calibrated close to the top end of the measuring range.

Graph C illustrates these 'worse case' specifications that are typically used to develop an overall accuracy statement of $< 1\%$ of full scale at constant temperature or $< 5\%$ over the operating temperature range. The QC testing error is typically $< 0.5\%$ prior to shipment of analyzer from the factory.

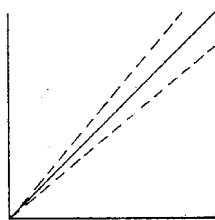
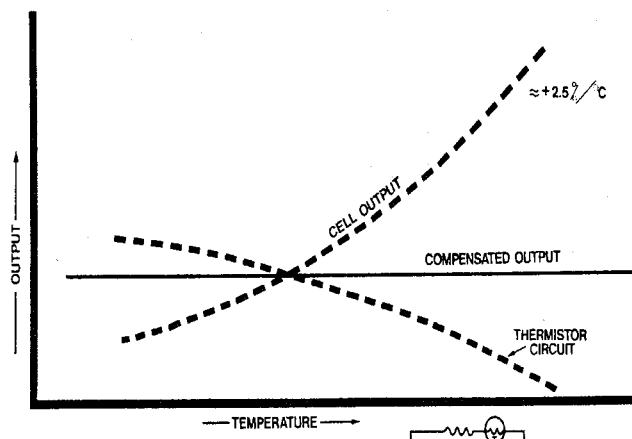

A. PERCENT OF READING ERRORS

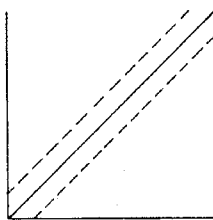

B. PERCENT OF FULL SCALE ERRORS

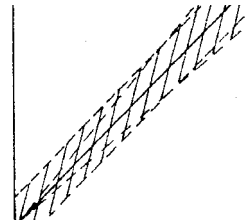

C. OVERALL ACCURACY

Example 1: As illustrated by Graph A, any error during a span adjustment at lower end of the scale, e.g., 20.9% (air) on a 100% full scale range, would be multiplied by a factor of 4.78 ($100/20.9$) when making measurements close to 100% O₂. Conversely, an error during a span adjustment close to the top end of the range, e.g., at 100% is reduced proportionately for measurements of oxygen concentrations near the bottom end of the range.

Graph B represents a constant error over the entire measuring range. This error is generally associated with the measuring e.g., LCD and or calibrating devices, e.g., current simulator or current/voltage measuring devices.

Potential Explosion Hazard – See warning in Section 4 – Features and Specifications

Mounting the Transmitter

The GPR-1800AIS analyzer consists of two interconnected enclosures (without the optional sample conditioning system and panel) and measures 8"H x 15-3/4"W x 7"D. This configuration is designed to be mounted directly to any flat vertical surface, wall or bulkhead plate by using eight (4) of the appropriate screws.

To facilitate servicing the interior of the transmitters, secure the back plate to a vertical surface approximately 5 feet from the floor or a level accessible to service personnel. This requires the user to supply four (4) additional proper size screws and anchors.



Caution: Do not remove or discard the gaskets from either the Ex enclosure or the fiberglass enclosure. Failure to reinstall either of the gaskets will void the NEMA 4, UL Type 3R rating and the immunity to RFI/EMI.

The transmitters design provides immunity from RFI/EMI by maintaining a good conductive contact between the two halves of the enclosures via a conductive gasket (the smaller enclosure containing signal processing electronics) The surfaces contacting the conductive gasket are unpainted. Do not paint these areas. Painting will negate the RFI/EMI protection.

Note: If equipped with the optional H₂S sample conditioning system, the transmitter and sample system are mounted to a back panel 15-3/4"H x 15-3/4"W with four mounting holes. Mount the entire panel to any vertical flat surface.

See Section 4 – Features and Specifications, for exclusions

If the ambient temperature is expected to fall below -18 degree C (0 degree F), install the analyzer in a heated enclosure to prevent sensor from freezing.



Gas Connections

See Section 4 – Features and Specifications, for exclusions

The GPR-1800 AIS with its standard flow through configuration is designed for positive pressure samples and requires connections for incoming sample and outgoing vent lines. Zero and span inlet ports are offered as part of the optional sample systems. The user is responsible for calibration gases and other required components, see below.

Procedure

Caution: Do not change the factory setting until instructed to do in this manual.

1. If analyzer has no marking for sample inlet and sample vent, designate one of the bulkhead tube fittings as the VENT and the other as SAMPLE.
2. Regulate the sample pressure as described in “Pressure and Flow” section above.
3. Connect a 1/8” or ¼” vent line to the compression fitting to be used for venting the sample.
4. Connect a 1/8” or ¼” sample line to the compression fitting to be used to bring SAMPLE gas to the analyzer.
5. If equipped with optional SPAN and/or ZERO ports, connect the SPAN and the ZERO gas lines to the respective SPAN and ZERO ports of the analyzer
6. Set the SAMPLE, SPAN and the ZERO gas pressure between 5-30 psig..
7. Select sample gas and allow it to flow through the transmitters and set the flow rate to 1- 2 SCFH.
8. **Note:** If equipped with the optional H₂S sample conditioning system: Regulate the pressure so that it does not exceed 30 psig.
9. Flow rates of 1-5 SCFH cause no appreciable change in the oxygen reading. However, flow rates above 5 SCFH may generate a backpressure and cause erroneous oxygen readings due to fact that the smaller diameter of the integral sample system tubing cannot vent the sample gas quickly at higher flow rates. If the analyzer is not equipped with an integral flow control valve, a flow control metering valve with a flow indicator upstream of the sensor must be installed to control the flow rate of the sample gas. A flow rate of 1-2 SCFH or 0.5-1 liter per minute is recommended for optimum performance.



Caution: Do not place your finger over the vent (it pressurizes the sensor) to test the flow indicator when gas is flowing to the sensor. Removing your finger (the restriction) generates a sudden vacuum on the sensor and may lead to electrolyte leakage thus causing damage to the sensor (will void sensor warranty).

Electrical Connections



Incoming power, alarm relays, and signal output connections are made to terminal blocks mounted on a PCB located in the explosion proof enclosure.

Do not supply voltage more than specified in this manual and noted near the power input terminal of the analyzer.

The PCB in the explosion proof enclosure contains a power limiting intrinsic safety barrier that limit the total power available at the PCB electronics mounted in the general purpose enclosure.

With proper insulation of the incoming power (see Appendix A), this configuration of the GPR-1800 AIS conforms to the ATEX directives for equipments for use in hazardous area. The analyzer meets the following area classification:



Ex/Explosion proof enclosure for power input, alarms and signal output



II 2 G

Ex d ib IIB T4 Gb

T_{amb} -20°C to +50°C



The GPR-1800 AIS also meets the intrinsic safety standards required for use in Class I, Division 1, Group C, D hazardous areas.

The A-1166 AIS PCB in the Ex enclosure contains five fuses, one plug-in (brown color) rated at 200 mA and the rest mounted on the PCB (after the DC voltage is regulated to lower safe value, these fuse meet barrier network standard EN 50020).



Avoid electrostatic discharge – Clean all surfaces with a damp cloth only.

Analyzer ground terminal must be ground



connected to a

Hazardous Area Installation

The GPR-1800 AIS may be installed in a hazardous area with proper insulation of the incoming power, see Appendix A. A 12-28 VDC power supply with a shielded power cable is recommended. The power cable to the Ex enclosure must be supplied through a conduit approved for use in hazardous area. Secure the wires to the power input terminal block by using the integral screws of the terminal block. Do not substitute terminal screws.



CAUTION: Check the QC for the proper power requirement. Incorrect power will severely damage the analyzer

Output Connections

The analyzer has two adjustable alarms, one power fail alarm and 4-20 mA or 1-5 VDC output connections. **CAUTION:** The 4-20mA IC does not require external power. Supplying external power to the IC can seriously damage the analyzer.

The HI and LOW alarms are user configurable. The relays are rated at 1A at 230 V.

CUTION: Do not exceed the recommended rating of the relays. Excessive power through the relays can severely damage the analyzer and or cause a safety hazard.

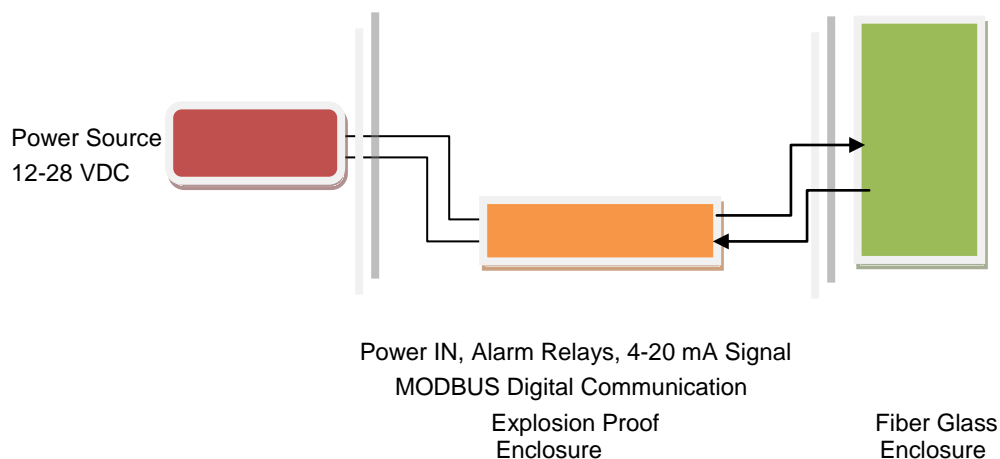

NOTE: There are five interconnecting wires between the explosion proof enclosure and the fiber glass enclosure, for Clarity, only two wires are shown.

Procedure

Power requirements consist of a 12-28 VDC power supply. Check the QC and analyzer cover plate for proper power requirement.

1. Unscrew the cone shaped cover from the lower enclosure.
2. Separate the shielding from the wires of the cable.
3. Ensure the positive and negative terminals of the power supply are connected to the appropriate terminals of the terminal block as marked.
4. Connect the shielding of the cable to the ground screw inside the enclosure.
5. Replace the cover.

Note: The male and female power terminals snap together, making it difficult to detach them when connecting the shield to the ground. However, after connecting the shield, ensure that the male terminal is fully inserted and secured into the female terminal block.

Installing the Oxygen Sensor

The GPR-1800 AIS Oxygen Analyzer is equipped with a SS sensor housing. This housing offers ease of replacement of sensor and at the same time prevents any leakage into the system. The two sections of the sensor are held together by a metal clamp secured in place by easily accessed bolt. The integrity of the sensor housing has been tested at the factory prior to shipment and is fully operational from the shipping container.



Caution: All analyzers must be calibrated once the installation has been completed and periodically thereafter as described below. Following the initial installation and calibration, allow the transmitters to stabilize for 12-24 hours and re-calibrate the transmitter with a certified span gas.



Caution: DO NOT dissect the oxygen sensor. The sensor contains a corrosive liquid electrolyte that could be harmful if touched or ingested, refer to the Material Safety Data Sheet contained in the Owner's Manual appendix. Avoid contact with any liquid or crystal type powder in or around the sensor or sensor housing, as either could be a form of electrolyte. Leaking sensors should be disposed off in a manner similar to that of a common battery in accordance with local regulations.



Avoid electrostatic discharge – Clean all surfaces with a damp cloth only.

Procedure

1. Remove the two (2) clamps securing the right side corners and open the door of the fiber glass enclosure.
2. Loosen the bolt at the bottom of the sensor housing by using 5/16 ranch provided.
3. Twist the upper section of the housing 90 degree and pull it up until it clears the bottom section of the sensor housing.
4. Remove the old sensor (if previously installed) from the sensor housing
5. Remove the oxygen sensor from the bag and remove the two red shorting taps from the two ring gold color contact plate of the sensor.
6. Insert the sensor into the upper section of the sensor housing with gold contact plate facing towards two gold contact pins of the sensor housing
7. By holding the sensor and the upper section of the sensor housing in your hand, allow 2-3 minutes for the analyzer to respond to the new sensor. The analyzer should display oxygen around 21% with factory default span setting (see below)
8. You may perform a quick air calibration to ensure that the analyzer accepts the air calibration confirming that the sensor output is within the recommended limits.
9. Place the sensor in the bottom section of the sensor housing with the two ring gold contact plate facing up. Place the upper section of the sensor housing over the sensor. Slightly push it down and twist 90 degree.
10. By using the 5/16 ranch, tighten the bolt securing the two section together.

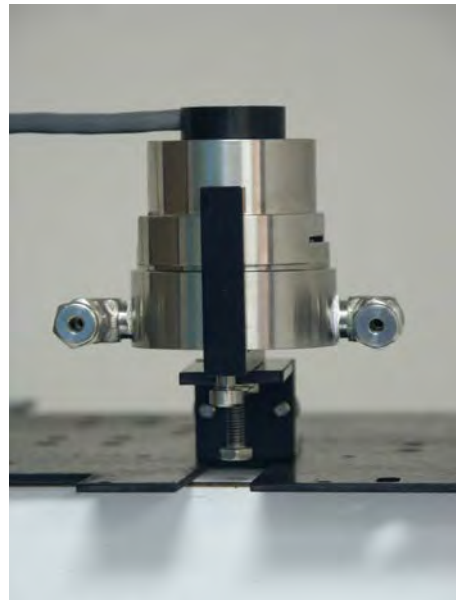

Span Gas Preparation

See Section 4 – Features and Specifications, for exclusions

Note: The GPR-1800 AIS can be calibrated by using ambient air. However, it can also be calibrated by using a certified span gas. Air calibration can be achieved right after installing the sensor in the housing. Subsequent calibration, where the sensor has been exposed to a sample gas, air calibration can be achieved by either removing the sensor from the sensor housing or by pushing the air through the sensor housing.



Caution: Do not contaminate the span gas cylinder when installing the pressure regulator on the span gas cylinder. Further, bleed the air filled regulator and span gas tubing before connecting the span gas to the analyzer and attempting the initial calibration.

Required Components

1. Certified span gas cylinder with an oxygen concentration, balance nitrogen, approximating 80% of the full scale of the measuring range or one range above the intended measuring range.
2. A pressure regulator to set the span gas pressure between 5 and 30 psig.
3. A flow meter to set the flow between 1-5 SCFH,
4. Suitable tube fittings and a 4-6 ft. length of 1/8" dia. metal tubing to connect the regulator to the flow meter inlet
5. Suitable tube fittings and a 4-6 ft. length of 1/8" dia. metal tubing to connect from the flow meter vent to tube fitting designated as SAMPLE IN or SPAN IN at the analyzer.

Procedure

1. With the span gas cylinder valve closed, install the pressure regulator on the cylinder.
2. Open the regulator's exit valve and partially open the pressure regulator's control knob.
3. Open slightly the cylinder valve.
4. Loosen the nut connecting the regulator to the cylinder and bleed the pressure regulator.
5. Retighten the nut connecting the regulator to the cylinder
6. Adjust the regulator exit valve and slowly bleed the pressure regulator.
7. Open the cylinder valve completely.
8. Set the pressure between 5-30 psig using the pressure regulator's control knob.

Caution: Do not exceed the recommended flow rate. Excessive flow rate could cause the backpressure on the sensor and may result in erroneous readings and damage the sensor

Establishing Power to Electronics

Once the two power input wires of the shielded cable are properly connected to the terminals inside the Ex enclosure as described above, connect the other end of the two wires to a suitable 12-24 VDC power supply such as a battery, PLC, DCS, etc.

The digital display responds instantaneously. When power is applied, the transmitter performs several self-diagnostic system status checks termed as "START-UP TEST" as illustrated below:

START-UP TEST

ELECTRONICS – PASS
TEMP SENSOR – PASS
BAROMETRIC SENSOR – PASS

REV.S1010.1.17

After self diagnostic tests, the analyzer turns itself into the sampling mode. And displays oxygen contents the sensor is exposed to, the analysis range, the ambient temperature and pressure and the software rev level.

20.9 %

AUTO SAMPLING
25% RANGE

76 F **100 KPA**

Menu Navigation

The four (4) pushbuttons located on the front of the transmitter control the micro-processor functions:

Blue ENTER (select)

Yellow UP ARROW

Yellow DOWN ARROW

Green MENU (escape)

Main Menu

To access the MAIN MENU, press the MENU (ESC) key and the following screen will appear.

MAIN MENU

SELECT RANGE
CALIBRATION
VIEW HISTORY
SYSTEM OPTIONS

This screen show various option available. You can use the UP and DOWN arrow key to move the cursor and highlight the desired function. After moving the cursor to the desired function, you can press ENTER to get to that function.

Range Selection

The GPR-1800-AIS transmitter is equipped with five (5) standard measuring ranges (see specification) and provides users with a choice of sampling modes. By accessing the MAIN MENU, users may select either the AUTO SAMPLING (ranging) or MANUAL SAMPLING (to lock on a single range) mode.

Note: For calibration purposes, use of the AUTO SAMPLE mode and ambient air (20.9% oxygen on the 0-25% range which meets the 80% of FS recommendation described below) is recommended. However, the user can select the full scale MANUAL SAMPLE RANGE for calibration as dictated by the accuracy of the analysis required – for example, a span gas with an 80 PPP oxygen concentration in nitrogen would dictate the use of the 0-100 PPM full scale range for calibration and a 0-100 PP measuring range.

Auto/ Manual Sampling

Access the MAIN MENU by pressing the MENU key.

Advance the reverse shade cursor using the ARROW keys to highlight SELECT RANGE and press ENTER

The display will show *AUTO and the actual range of analysis. Press the ENTER to select MANUAL RANGE and advance the cursor to the desired RANGE and press ENTER.

The following display appears:

The display returns to the sampling mode:

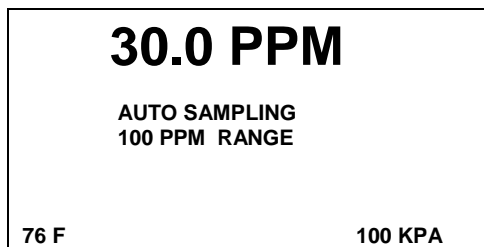
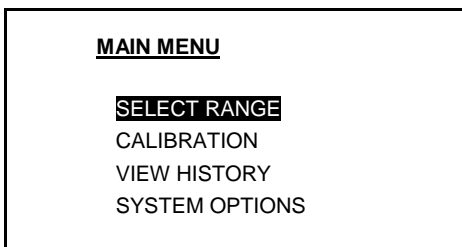

The display will shift to the next higher range when the oxygen reading exceeds 99.9% of the upper limit of the current range. The display will shift to the next lower range when the oxygen reading drops to 85% of the upper limit of the next lower range.

For example, if the transmitter is reading 5 PPM on the 0-10 PPM range and an upset occurs, the display will shift to the 0-100 PPM range when the oxygen reading exceeds 9.99 PPM. Conversely, once the upset condition is corrected, the display will shift back to the 0-10 PPM range when the oxygen reading drops to 8.5 PPM.

Pressing SELECT RANGE and then pressing ENTER will toggle between AUTO and MANUAL sampling

When MANUAL range is selected and If the oxygen value goes above the selected range, display will not shift to the next higher range. Instead, when the oxygen reading exceeds 110% of the upper limit of the current range, an OVER RANGE warning will be displayed.

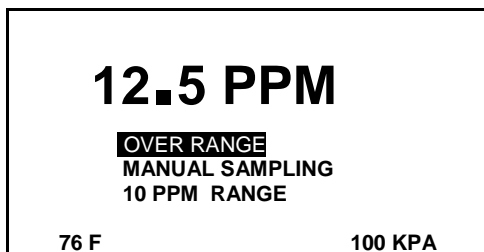

Once the OVER RANGE warning appears the user must advance the transmitter to the next higher range.

NOTE: With oxygen reading above 110% of the selected range, the mA signal output will increase but will freeze at a maximum value of 24 mA. After the oxygen reading falls below the full scale range, the mA signal will become normal.

Analyzer Calibration

The electrochemical oxygen sensors generate an electrical current that is **linear** or proportional to the oxygen concentration in a sample gas. In the absence of oxygen the sensor exhibits an **absolute zero**, i.e., the sensor does not generate a current output in the absence of oxygen. Given the properties of linearity and an absolute zero, a single point calibration is possible.

The analyzer is equipped with “Zero Calibration” feature. However, as described below, zero calibration is recommended only when the application (or user) demands optimum accuracy of below 5% of the most sensitive or lowest range available on the analyzer. For example, if the user requires analysis of a sample gas below 0.05%, zero calibration may be required.

Span calibration, it is necessary to adjust the analyzer sensitivity for accurate measurements of oxygen by using a standardized (certified) oxygen or by using ambient air (20.9%).

Zero Calibration

Ideally, with no oxygen, the sensor should have zero signal but in reality, the analyzer may display oxygen reading with a sample gas containing no oxygen (zero gas). Under such circumstance, it may be necessary to perform a Zero calibration to remove any offset with oxygen free sample gas. The maximum zero offset correction is limited to a maximum of 10% of the lowest (most sensitive) range for positive zero offset and 10% of the lowest range for negative zero offset.

Zero calibration could be carried out before or after the span calibration. Normally, zero calibrations are performed when a new sensor is installed or changes are made in the sample system connections. Allow the ZERO gas to flow through the analyzer and wait until the signal has dropped to a low value and is stable.

Access the MAIN MENU by pressing the MENU key.

Advance the reverse shade cursor using the ARROW keys to highlight CALIBRATION.

Press the ENTER key to select the highlighted menu option.

The following displays appear:

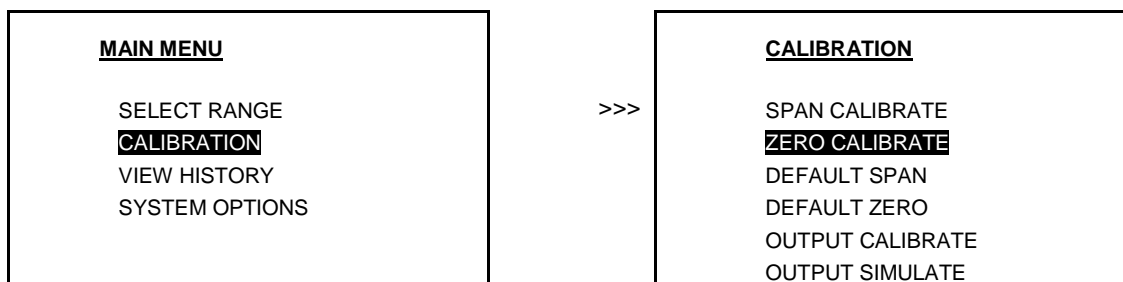

Advance the reverse shade cursor using the ARROW keys to highlight ZERO CALIBRATE.

Press the ENTER key to select the highlighted menu option.

The following displays appear:

0.15 PPM

**ZERO CALIBRATION
WAIT FOR STEADY RDG
ENTER TO CALIBRATE
MENU TO ABORT**

Wait until the analyzer reading stabilizes (depending on the history of the sensor, it may take a few minutes to several hours) and then press the ENTER key to calibrate (or MENU key to abort).

If the offset is less than 10% of the lowest range, by pressing ENTER will pass the calibration and the analyzer will return to the Sample mode. On the other hand, if the offset is above 10%, pressing ENTER will fail calibration and the analyzer will return to Sample mode without completing the Zero calibration.

Both the Zero Calibrate and Span Calibrate functions result in the following displays:

**PASSED
CALIBRATION**

OR

**FAILED
CALIBRATION**

Default Zero

This feature will eliminate any previous zero calibration adjustment and display the actual signal output of the sensor at a specified oxygen concentration. This feature allows the user to ensure that the accumulative zero offset never exceeds 10% of the lowest range limit. To perform Default Zero,

Access the MAIN MENU by pressing the MENU key.

Advance the reverse shade cursor using the ARROW keys to highlight CALIBRATION.

Press the ENTER key to select the highlighted menu option.

The following displays appear:

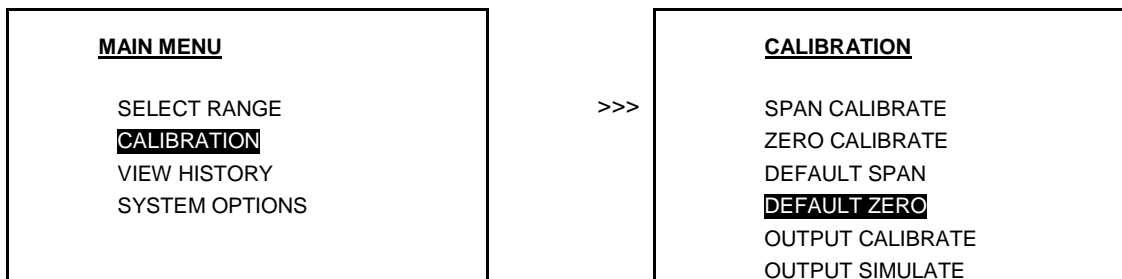

Advance the reverse shade cursor using the ARROW keys to highlight DEFAULT ZERO.

Press the ENTER key to select the highlighted menu option.

The following display appears and after 3 seconds the system returns to the SAMPLING mode:

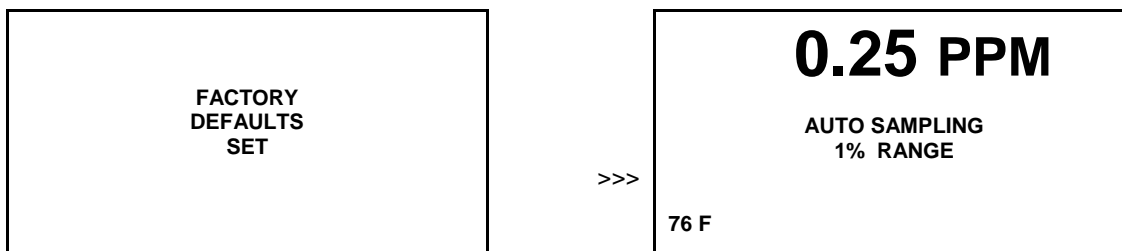

Analyzer Calibration-Span Calibration

Air Calibration

This procedure requires only a source of clean ambient air and removal of the sensor from its flow housing.

Access the interior of the analyzer by removing the 4 clamps securing the door of the analyzer.

Caution: Do not remove the gaskets from the enclosure. Failure to do so will void the NEMA rating.

Remove the sensor from the screw-in sensor housing or push the air through the analyzer SAMPLE IN thus exposing the sensor to ambient air or alternatively, flow a certified span gas through the analyzer.

Advance the cursor on the MAIN MENU to CALIBRATE and press ENTER.

Advance the cursor to SPAN CALIBRATION and press ENTER

The following displays appear:

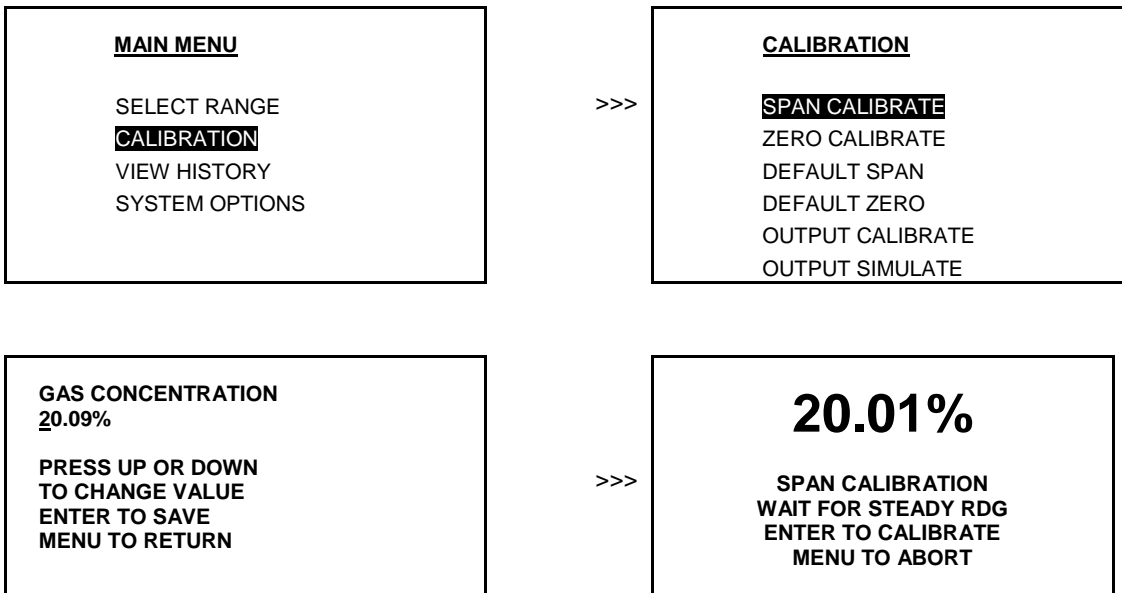

By using the UP or DOWN arrow keys, enter the appropriate digit where the cursor is blinking
 Press the ENTER key to advance the underline cursor right or press the MENU key to advance the underline cursor left to reach to the desired digit of the gas value.
 Repeat until the complete span value has been entered.
 In the example above, a span value of 20.09% has been entered.
 After the span value has been entered, the analyzer will display the actual oxygen reading and prompt to press the ENTER key to accept SPAN CALIBRATION or MENU to escape.

Caution: Allow the analyzer reading to stabilized before accepting calibration.

After successful calibration, the analyzer will display a message “Passed Calibration” and return to the Sample mode.

NOTE: The analyzer is allowed to accept calibration when O2 reading is within the acceptable value. If the O2 reading is outside of this limit, by pressing ENTER to accept calibration will result in “Failed Calibration” and return to the Sample mode without completing Span calibration. After pressing ENTER either of the following two messages will be displayed and the analyzer will return to SAMPLE mode.

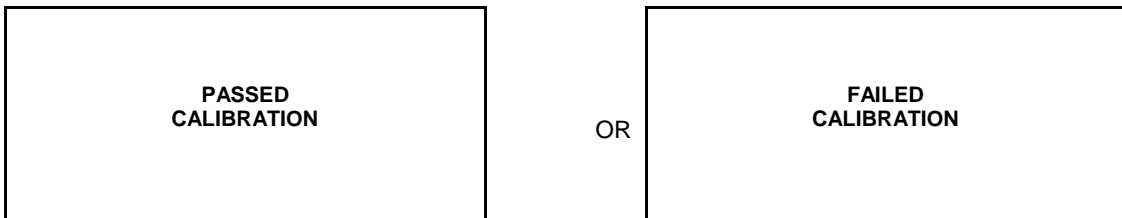

Span Gas Calibration

This procedure assumes a span gas under positive pressure. Connect the span gas to the analyzer Sample input port and set the span gas flow 1-2 SCFH

NOTE: To assure an accurate calibration, the temperature and pressure of the span gas must closely approximate the sample conditions.

For calibration purposes, use of the AUTO SAMPLE mode is recommended.

Access the MAIN MENU by pressing the MENU key.

Advance the reverse shade cursor using the ARROW keys to highlight AUTO SAMPLE.

Press the ENTER key to select the highlighted menu option.

The following displays appear:

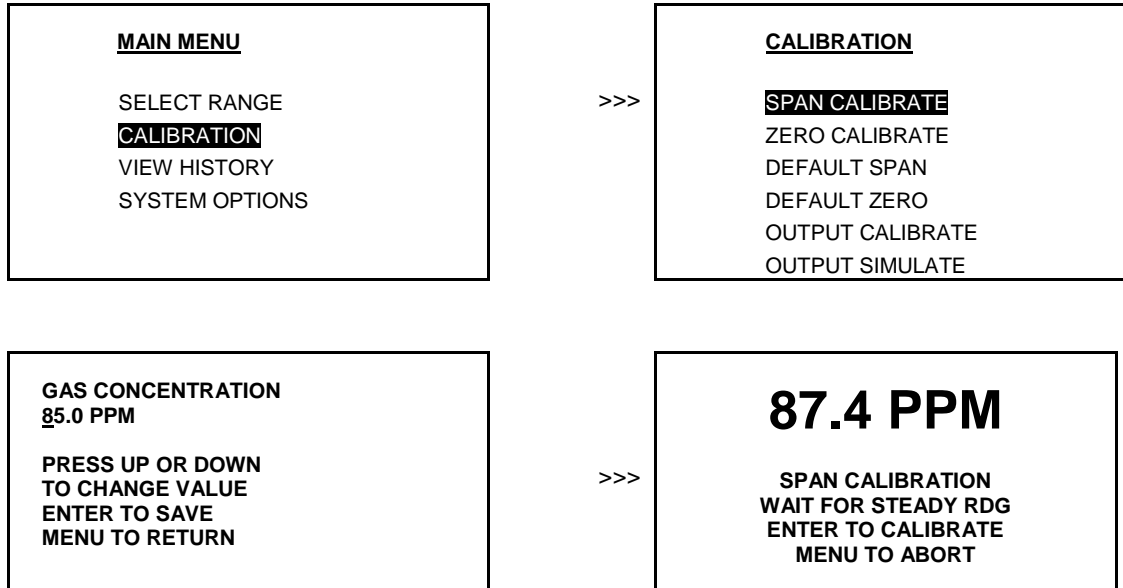

By using the UP or DOWN arrow keys, enter the appropriate digit where the cursor is blinking

Press the ENTER key to advance the underline cursor right or press the MENU key to advance the underline cursor left to reach to the desired digit of the gas value.

Repeat until the complete span value has been entered.

In the example above, a span value of 85.0 PPM has been entered.

After the span value has been entered, the analyzer will display the actual oxygen reading and prompt to press the ENTER key to accept SPAN CALIBRATION or MENU to escape.

Caution: Allow the analyzer reading to stabilize before accepting calibration.

After successful calibration, the analyzer will display a message "Passed Calibration" and return to the Sample mode.

NOTE: The analyzer is allowed to accept calibration when O2 reading is within the acceptable value. If the O2 reading is outside of this limit, by pressing ENTER to accept calibration will result in "Failed Calibration" and return to the Sample mode without completing Span calibration. After pressing ENTER either of the following two messages will be displayed and the analyzer will return to SAMPLE mode.

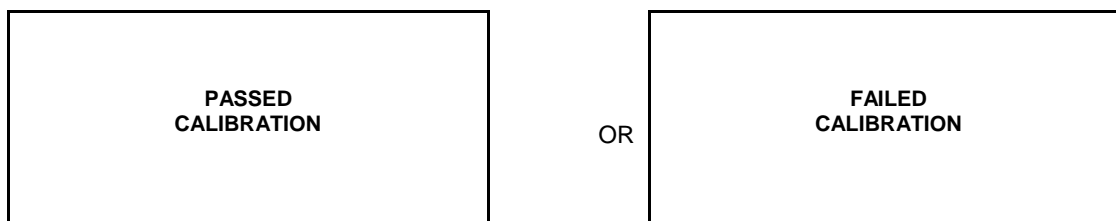

Default Span

The software will set the SPAN adjustment based on the average output of the oxygen at a specific oxygen concentration and erase any previous span calibration data. For example, with factory default settings, when a span gas is introduced, the micro-processor will display oxygen reading within $\pm 30\text{-}50\%$ of the span gas value, indicating that the sensor output is within the specified limits. This feature allows the user to check the sensor's signal output at a specified oxygen concentration without removing it from the sensor housing.

Access the MAIN MENU by pressing the MENU key.

Advance the reverse shade cursor using the ARROW keys to highlight CALIBRATION.

Press the ENTER key to select the highlighted menu option.

The following display appears:

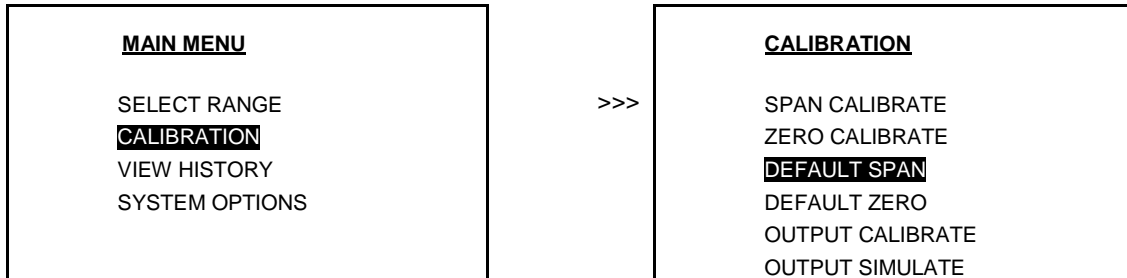

Advance the reverse shade cursor using the ARROW keys to highlight DEFAULT SPAN.

Press the ENTER key to select the highlighted menu option.

The following displays appear and after 3 seconds the system returns to the SAMPLING mode and display the current oxygen reading.

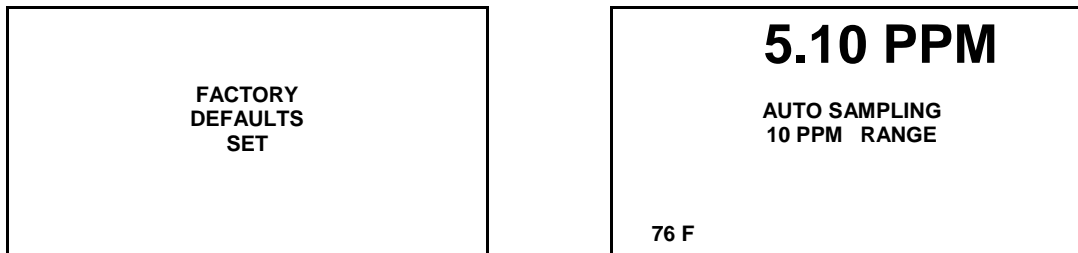

Analog Output Check- Output Simulate

This feature allows the user to simulate the electronics and the signal output. A known current is added to the analyzer electronics internally to generate equivalent analog signal output. This feature allows the user to check all interconnections from the analyzer to the signal output recording device before installation of sensor thus preventing the user from opening the sensor bag before the analyzer installation is complete and satisfactory. To simulate signal output

Access the MAIN MENU by pressing the MENU key.

Advance the reverse shade cursor using the ARROW keys to highlight CALIBRATION and then select OUTPUT SIMULATE.

Press the ENTER key to select the highlighted menu option.

The following displays appear:

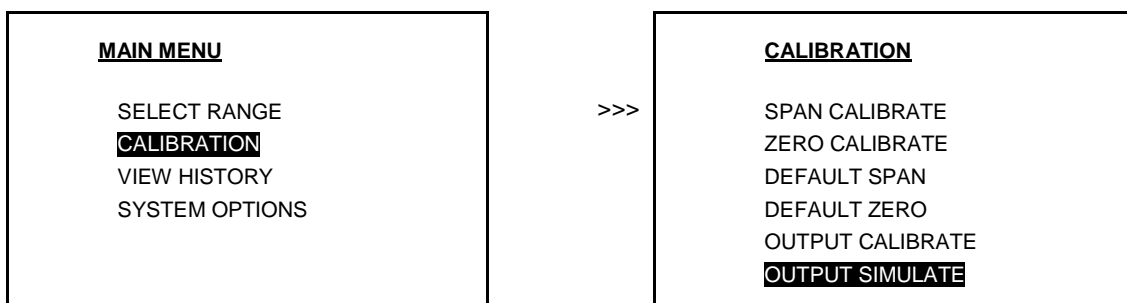

OUTPUT SIMULATE
0% SPAN
4.00 mA
PRESS UP OR DOWN TO ADJUST
OUTPUT ENTER/MENU TO RETURN

Pressing UP or DOWN key will increase or decrease the output by 5% of the full scale signal each time. Check the output on the external recording device or voltmeter/ammeter. The output on the external recording would be the % of the full scale signal selected, for example, 0% will represent 4.00 mA, 25% value will represent 8 mA and 50% span value will represent 12.0 mA of the 4-20 mA full scale. After SIMULATION is complete, press ENTER/MENU key to return to SAMPLE mode.

Note: To perform "Calibrate-Output Simulation", an external recording device must be connected between the negative terminal of the power source and negative terminal of the transmitter.

Analog Output Check- Output Calibrate

In certain cases, the full scale analog may not match with full scale display. This feature allows the user to adjust the electronics so that the full scale display matches with full scale analog signal output. To calibrate full scale signal output

Access the MAIN MENU by pressing the MENU key.

Advance the reverse shade cursor using the ARROW keys to highlight CALIBRATION and then select OUTPUT SIMULATE.

Press the ENTER key to select the highlighted menu option.

The following displays appear:

MAIN MENU
 SELECT RANGE
CALIBRATION
 VIEW HISTORY
 SYSTEM OPTIONS

>>>

CALIBRATION
 SPAN CALIBRATE
 ZERO CALIBRATE
 DEFAULT SPAN
 DEFAULT ZERO
OUTPUT CALIBRATE
 OUTPUT SIMULATE

OUTPUT SPAN
20.0 mA ADJUST
PRESS UP OR DOWN TO ADJUST
OUTPUT ENTER/MENU TO RETURN

Pressing UP or DOWN key will increase or decrease the full scale output signal each time. Check the output on the external recording device or voltmeter/ammeter. Repeat this step until the out equals the full scale analog signal expected, for example 20 mA in the present case. After OUTPUT CALIBRATION is complete, press ENTER/MENU key to return to SAMPLE mode.

Sampling a Gas

GPR-1800 AIS Oxygen Analyzer requires a positive pressure to flow the sample gas across the sensor to measure the oxygen concentration in a sample gas. If a positive sample pressure is not available, install a high quality external sample pump to push the sample through the analyzer; see the option of using a sample pump as described above.

Procedure

Following calibration, the analyzer will return to the SAMPLE mode and ready for sampling the gas.

Select the desired sampling mode - auto or manual – as described above.

Use a suitable tubing to transport the sample gas to the analyzer

The main consideration is to eliminate any air leaks which can affect oxygen measurements.

For sample gases under positive pressure, the user must provide a means of controlling the inlet pressure between 5-30 psig.

For sample gases under atmospheric or slightly negative pressure, an external pump is necessary to push the sample through the sensor housing. Generally, when using a low voltage DC pump, no pressure regulation is necessary but a flow control device is recommended; a flow meter upstream of analyzer is recommended to ensure that the sample flow is adequate and steady.

Assure the sample is adequately vented for optimum response and recovery – and safety.

Allow the oxygen reading to stabilize for approximately 2 minutes at each sample point.

View History

This feature allows the user to view

Maximum PPM O₂

Minimum PPM O₂

Average PPM O₂

Maximum ambient temperature

Number of days the sensor has been in service (at the time of installation and first calibration, the user must enter YES to confirm "new sensor") and

Number of days since the last calibration was done.

System Options

This features allows the user to

1. Set security; password protected operation
2. Define ranges; choose a range between two ranges, for example, 200 PPM full scale instead of 1000 PPM full scale.
3. Display signal below 0.00; Negative signal, YES or NO.
4. Displays MODBUS COMM menu

Security

PASSCODE LOCK- Prevents un-authorized access to the analyzer menu options. Selecting PASSCODE LOCK will put the analyzer in Sample Mode and accessing the menus will require a valid pass-code.

To enter pass code, from SYSTEM OPTIONS menu, select SECURITY, select PASSCODE LOCK and then enter four digit PASS CODE, numeral numbers only and press ENTER. Then select AUTO LOCK option and enter the number of minutes after which access to MENU options will be locked (access allowed only after entering the PASS CODE).

In the vent the PASS CODE is lost, enter the factory default PASS CODE 2855 to access the MENU and then reenter the new PASS CODE.

Choosing the option to display negative number will allow the user to see the display below 0.00 but the output will not go below 3.80 mA.

Configure Alarms

The analyzer is equipped with two programmable alarm relays; ALARM 1 and ALARM 2. The two alarms set points are user adjustable and can be set either as LOW/HIGH, LOW/LOW or HIGH/HIGH.

Alarm Pulsing

Sets the duration of Alarm relay pulses. Setting the duration to 0 seconds disables pulse mode (PULSING=OFF). If the duration is greater than 0, the PULSE MODE is enabled and PULSE MODE will be displayed at the lower-right corner of the sample screen.

Alarm Delay

Alarm delay option allows the user to ignore the alarm should a sudden short spike in the oxygen reading occurs.

Alarm Bypass

The alarms bypass feature allows the user to bypass the alarm during trouble shooting/repair or test run. However, once the alarm bypass is selected, alarm will remain disabled even if the oxygen reading is over/under the alarm set point. The alarm will re-arm itself only after the fault condition has been reverted.

The alarms are automatically disabled during SPAN/ZERO calibration.

The relays are rated at 1A @ 230V.

CAUTION; When using these relays, do not exceed the recommended rating.

Modbus Communication

SLAVE ID: Sets the network ID (address) of the analyzer. A valid ID is between 1 and 247. Each device on the Modbus network must have a unique ID for the network to operate properly.

BAUD: Sets the network communication baud rate: 9600 or 19,200 bites per sec. All devices on the Modbus network must operate at the same baud rate.

PARITY: Sets the communication byte error detection method: NONE, ODD, EVEN. This setting must match with the setting used by the Modbus master.

Standby

The transmitter has no special storage requirements.

The sensor should remain inside of the sensor housing and connected to the electronics during storage periods. Before turning the sample gas OFF, ensure that sample/bypass valve (if analyzer equipped) is at the BYPASS position. This will keep the sensor isolated from ambient air and would be ready to use again when required with very short down time.

NOTE: Under isolated conditions, some oxygen will diffuse into the sample system/sensor housing and the sensor out will slowly climb up but after 2-3 hours, it will reach a Plato, generally less than 400 PPM

Store the transmitter with the power OFF at a safe location and away from a direct heating source.

If storing for an extended period of time, protect the analyzer from dust, heat and moisture.

6. Maintenance

Generally, cleaning the electrical contacts inside of the upper section of the sensor housing or replacing filter element of the coalescing filter is the extent of the maintenance requirements of this transmitter.

Serviceability: Except for replacing the oxygen sensor, there are no parts inside the transmitter for the operator to service. Only trained personnel with the authorization of their supervisor should conduct maintenance.

7. Spare Parts

Recommended spare parts for the GPR-1500 AIS Oxygen Analyzer:

Item No.	Description
GPR-12-333	Oxygen Sensor, for measuring O ₂ in inert gases
XLT-12-333	Oxygen Sensor, for measuring O ₂ in gases containing CO ₂

Other spare parts:

Item No.	Description
B-2762-A-2-14	Sensor Housing Upper Section

The Factory must be consulted for any other questions/maintenance

8. Troubleshooting

Symptom	Possible Cause	Recommended Action
Slow recovery	At installation, defective sensor	Replace sensor if recovery unacceptable or O ₂ reading fails to reach 10% of lowest range
	Air leak in sample system connection(s)	Leak test the entire sample system: Vary the flow rate, if the O ₂ reading changes inversely with the change in flow rate indicates an air leak - correct source of leak
	Abnormality in zero gas	Qualify zero gas (using portable transmitter)
	Damaged in service - prolonged exposure to air, electrolyte leak Sensor nearing end of life	Replace sensor Replace sensor
High O ₂ reading after installing or replacing sensor	Analyzer calibrated before sensor stabilized caused by: 1) Prolonged exposure to ambient air, worse if sensor was un-shorted 2) Air leak in sample system connection(s) 3) Abnormality in zero gas	Allow O ₂ reading to stabilize before making the span/calibration adjustment Continue purge with zero gas
		Leak test the entire sample system (above)
		Qualify zero gas (using portable transmitter)
High O ₂ reading Sampling	Flow rate exceeds limits	Correct pressure and flow rate
	Pressurized sensor Improper sensor selection	Remove restriction on vent line Replace GPR sensor with XLT sensor when CO ₂ or acid gases are present
Response time slow	Air leak, dead legs, distance of sample line, low flow rate, volume of optional filters and scrubbers	Leak test (above), reduce dead volume or increase flow rate
O ₂ reading doesn't agree to expected O ₂ values	Pressure and temperature of the sample is different than span gas Abnormality in gas	Calibrate the transmitter (calibrate at pressure and temperature of sample) Qualify the gas (use a portable analyzer as a second check)
Erratic O ₂ reading	Change in sample pressure	Calibrate the transmitter (calibrate at pressure and temperature of sample)

or
No O₂ reading

Dirty electrical contacts in upper section of sensor housing

Clean contacts with alcohol (minimize exposure time of MS sensor to ambient air to extent possible)

Corroded solder joints on sensor PCB from corrosive sample or electrolyte leakage from sensor

Replace sensor and return sensor to the factory for warranty determination

Corroded spring loaded contact in upper section of sensor housing from liquid in sample or electrolyte leakage from sensor

Upper section of sensor housing: Clean contacts with water, wipe contacts with clean paper towel and flush system and sensor housing with dry gas

Sensor: Replace if leaking and return it to the factory for warranty determination

Liquid covering sensing area

Wipe with lint free towel or flow dry sample or zero gas for 2-3 hours to flush out condensation

Consult factory for recommendation.

Improper sensor selection

Replace sensor and install scrubber

Presence of interference gases

Consult factory.

Unauthorized maintenance

Replace sensor

Sensor nearing end of life

Erratic O₂ reading
or
Negative O₂ reading
or
No O₂ reading accompanied by electrolyte leakage

Pressurizing the sensor by flowing gas to the sensor with the vent restricted or SHUT OFF valve closed and suddenly removing the restriction draws a vacuum on the sensor

Zero the transmitter. If not successful replace the sensor

or

partially opened valves upstream of the analyzer when using a pump downstream of the analyzer to draw sample from a process at atmospheric pressure or under a slight vacuum. Placing a vacuum on the sensor in excess 10" of water column is strongly discouraged.

Avoid drawing a vacuum on the sensor, a pressurized sensor may not leak but still produce negative readings.

A premature adjustment of the ZERO OFFSET is a common problem

From MAIN MENU select DEFAULT ZERO

9. Warranty

The design and manufacture of GPR Series oxygen transmitters/analyzers, monitors and oxygen sensors are performed under a certified Quality Assurance System that conforms to established standards and incorporates state of the art materials and components for superior performance and minimal cost of ownership. Prior to shipment every analyzer is thoroughly tested by the manufacturer and documented in the form of a Quality Control Certification that is included in the Owner's Manual accompanying every analyzer. When operated and maintained in accordance with the Owner's Manual, the units will provide many years of reliable service.

Coverage

Under normal operating conditions, the monitor, analyzers and sensor are warranted to be free of defects in materials and workmanship for the period specified in accordance with the most recent published specifications, said period begins with the date of shipment by the manufacturer. The manufacturer information and serial number of this analyzer are located on the rear of the analyzer. Advanced Instruments Inc. reserves the right in its sole discretion to invalidate this warranty if the serial number does not appear on the analyzer.

If your Advanced Instruments Inc. monitor, analyzer and/or oxygen sensor is determined to be defective with respect to material and/or workmanship, we will repair it or, at our option, replace it at no charge to you. If we choose to repair your purchase, we may use new or reconditioned replacement parts. If we choose to replace your Advanced Instruments Inc. analyzer, we may replace it with a new or reconditioned one of the same or upgraded design. This warranty applies to all monitors, analyzers and sensors purchased worldwide. It is the only one we will give and it sets forth all our responsibilities. There are no other express warranties. This warranty is limited to the first customer who submits a claim for a given serial number and/or the above warranty period. Under no circumstances will the warranty extend to more than one customer or beyond the warranty period.

Limitations

Advanced Instruments Inc. will not pay for: loss of time; inconvenience; loss of use of your Advanced Instruments Inc. analyzer or property damage caused by your Advanced Instruments Inc. analyzer or its failure to work; any special, incidental or consequential damages; or any damage resulting from alterations, misuse or abuse; lack of proper maintenance; unauthorized repair or modification of the analyzer; affixing of any attachment not provided with the analyzer or other failure to follow the Owner's Manual. Some states and provinces do not allow limitations on how an implied warranty lasts or the exclusion of incidental or consequential damages, these exclusions may not apply.

Exclusions

This warranty does not cover installation; defects resulting from accidents; damage while in transit to our service location; damage resulting from alterations, misuse or abuse; lack of proper maintenance; unauthorized repair or modification of the analyzer; affixing of any label or attachment not provided with the analyzer; fire, flood, or acts of God; or other failure to follow the Owner's Manual.

Service

Call Advanced Instruments Inc. at 909-392-6900 (or e-mail info@aii1.com) between 7:30 AM and 5:00 PM Pacific Time Monday thru Thursday or 8:00 AM to 12:00 pm on Friday. Trained technicians will assist you in diagnosing the problem and arrange to supply you with the required parts. You may obtain warranty service by returning you analyzer, postage prepaid to:

Advanced Instruments Inc.
2855 Metropolitan Place
Pomona, Ca 91767 USA
Tel: +1 909 392 6900

Be sure to pack the analyzer securely. Include your name, address, telephone number, and a description of the operating problem. After repairing or, at our option, replacing your Advanced Instruments Inc. analyzer, we will ship it to you at no cost for parts and labor.

10. MSDS – Material Safety Data Sheet

Product Identification

Product Name	Oxygen Sensor Series - PSR, GPR, All, XLT
Synonyms	Electrochemical Sensor, Galvanic Fuel Cell
Manufacturer	Advanced Instruments Inc., 2855 Metropolitan Place, Pomona, CA 91767 USA
Emergency Phone Number	909-392-6900
Preparation / Revision Date	January 1, 1995
Notes	Oxygen sensors are sealed, contain protective coverings and in normal conditions do not present a health hazard. Information applies to electrolyte unless otherwise noted.

Specific Generic Ingredients

Carcinogens at levels > 0.1%	None
Others at levels > 1.0%	Potassium Hydroxide or Acetic Acid, Lead
CAS Number	Potassium Hydroxide = KOH 1310-58-3 or Acetic Acid = 64-19-7, Lead = Pb 7439-92-1
Chemical (Synonym) and Family	Potassium Hydroxide (KOH) – Base or Acetic Acid (CH ₃ CO ₂ H) – Acid, Lead (Pb) – Metal

General Requirements

Use	Potassium Hydroxide or Acetic Acid - electrolyte, Lead - anode
Handling	Rubber or latex gloves, safety glasses
Storage	Indefinitely

Physical Properties

Boiling Point Range	KOH = 100 to 115° C or Acetic Acid = 100 to 117° C
Melting Point Range	KOH -10 to 0° C or Acetic Acid – NA, Lead 327° C
Freezing Point	KOH = -40 to -10° C or Acetic Acid = -40 to -10° C
Molecular Weight	KOH = 56 or Acetic Acid – NA, Lead = 207
Specific Gravity	KOH = 1.09 @ 20° C, Acetic Acid = 1.05 @ 20° C
Vapor Pressure	KOH = NA or Acetic Acid = 11.4 @ 20° C
Vapor Density	KOH – NA or Acetic Acid = 2.07
pH	KOH > 14 or Acetic Acid = 2-3
Solubility in H ₂ O	Complete
% Volatiles by Volume	None
Evaporation Rate	Similar to water
Appearance and Odor	Aqueous solutions: KOH = Colorless, odorless or Acetic Acid = Colorless, vinegar-like odor

Fire and Explosion Data

Flash and Fire Points	Not applicable
Flammable Limits	Not flammable
Extinguishing Method	Not applicable
Special Fire Fighting Procedures	Not applicable

Unusual Fire and Explosion Hazards

Not applicable

Reactivity Data

Stability

Stable

Conditions Contributing to Instability

None

Incompatibility

KOH = Avoid contact with strong acids or Acetic Acid = Avoid contact with strong bases

Hazardous Decomposition Products

KOH = None or Acetic Acid = Emits toxic fumes when heated

Conditions to Avoid

KOH = None or Acetic Acid = Heat

Spill or Leak

Steps if material is released

Sensor is packaged in a sealed plastic bag, check the sensor inside for electrolyte leakage. If the sensor leaks inside the plastic bag or inside an analyzer sensor housing do not remove it without rubber or latex gloves and safety glasses and a source of water. Flush or wipe all surfaces repeatedly with water or wet paper towel (fresh each time).

Disposal

In accordance with federal, state and local regulations.

Health Hazard Information

Primary Route(s) of Entry

Ingestion, eye and skin contact

Exposure Limits

Potassium Hydroxide - ACGIH TLV 2 mg/cubic meter or Acetic Acid - ACGIH TLV / OSHA PEL 10 % (TWA), Lead - OSHA PEL .05 mg/cubic meter

Ingestion

Electrolyte could be harmful or fatal if swallowed. KOH = Oral LD50 (RAT) = 2433 mg/kg or Acetic Acid = Oral LD50 (RAT) = 6620 mg/kg

Eye

Electrolyte is corrosive and eye contact could result in permanent loss of vision.

Skin

Electrolyte is corrosive and skin contact could result in a chemical burn.

Inhalation

Liquid inhalation is unlikely.

Symptoms

Eye contact - burning sensation. Skin contact - soapy slick feeling.

Medical Conditions Aggravated

None

Carcinogenic Reference Data

KOH and Acetic Acid = NTP Annual Report on Carcinogens - not listed; LARC Monographs - not listed; OSHA - not listed

Other

Lead is listed as a chemical known to the State of California to cause birth defects or other reproductive harm.

Special Protection Information

Ventilation Requirements

None

Eye

Safety glasses

Hand

Rubber or latex gloves

Respirator Type

Not applicable

Other Special Protection

None

Special Precautions

Precautions

Do not remove the sensor's protective Teflon and PCB coverings. Do not probe the sensor with sharp objects. Wash hands thoroughly after handling. Avoid contact with eyes, skin and clothing.

Empty sensor body may contain hazardous residue.

Transportation

Not applicable

Appendix A

Electrical connections require an approved explosion proof sealing fitting and packing around wires and cables (for incoming power for the analyzer electronics and 4-20mA signal output) coming into and out of the explosion proof enclosure that houses the power supply/signal output PCB.

Full compliance with hazardous area electrical code requires the user to supply glands, fittings and/or conduit commensurate with the level of protection or classification desired. To maintain the ATEX certification of this unit, the user must install ATEX approved components according to ATEX directives. To meet US and Canada requirements for use in Class I, Division 1, Groups C, D hazardous areas, the user must install the appropriate components according to the NEC standards (US) or CEC standards (Canada).

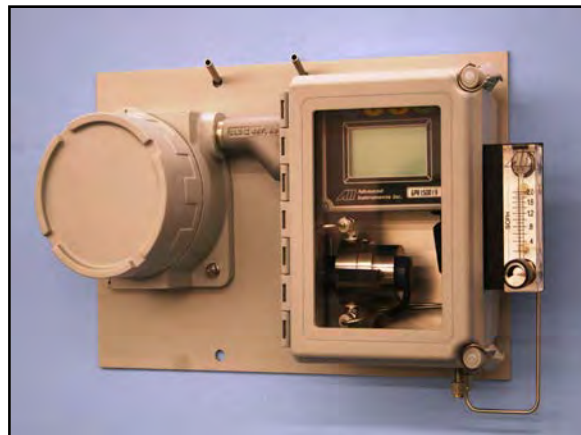

Note: The following instruction is supplied from information and data supplied by a reputable enclosure manufacturer which we believe is reliable and is given in good faith. Since the methods of application and conditions under which our products are put to use are beyond our control, we are not able to guarantee the application and/or use of same. The user assumes all risks and liability in connection with the application and use of our products.

Directions for use of Explosion Proof Packing Fiber (non-asbestos)

For use as packing at the hub of sealing fittings, tamp packing fiber between and around conductors where they enter fitting to prevent leakage of the liquid cement. Leave enough space in the fitting for length equivalent to the inside diameter of the conduit but, not less than 5/8".



Caution: Avoid getting in eyes or breathing dust
Use barrier cream, gloves and long sleeve shirts if dust or fiber is irritating.
Prolonged contact may cause lung, eye or skin irritation. Directions for use

Explosion Proof Sealing Cement: Tamp packing fiber between and around conductors where they enter the sealing fitting to prevent leakage of liquid cement. Make sure conductors are not in contact with each other or with the wall of fitting. Leave space in the fitting for a sealing length equivalent to the thread size of the conduit seal but not less than 5/8"



Fill the marked shipping container with clean cold water to the "water line" [35 ml to be precise].

Caution: Do not exceed the required amount of water.



Gradually pour cement from the plastic bag into the water and stir thoroughly for proper mixture. Fill fitting completely within five (5) minutes after mixing, then tamp with blunt stick to expel any air bubbles. Close up any opening in the fitting to insure integrity of the seal. Fittings requiring more than 10 oz. of cement must be filled from a single mixture of cement and water. **DO NOT POUR IN STAGES.** Allow cement at least 72 hours to cure. Water-mix sealing compound should not be poured or installed at temperature below 40F (4C). Maintain temperature at or above 40F for at least 72 hours after pouring. CSA certified when used with any CSA certified sealing fitting. Adaco No. 1 sealing cement must be used as a part of any Adalet UL listed fitting.

Caution: At least five threads must engage on all fill plugs.

Caution: Prolonged breathing or ingestion may cause internal obstruction, seek medical care.

Do not get into eyes or on skin – if cement touches eyes or skin, flush with water for 15 minutes.

Large amounts on skin when hardening may cause skin burn.

Use adequate ventilation.

To reorder sealing cement kit, specify P/N ENCL-1071-KIT

Appendix B

Matching - LCD Display with 4-20mA Output

In rare instances the 4-20mA signal output may not agree with the reading displayed on the LCD. The Output Zero and Output Span features enable the user to adjust the 4mA and 20 mA signal output matching with the reading displayed by the LCD.

For optimum accuracy make two separate adjustments as follows:

1. OUTPUT ZERO feature: To adjust the 4mA signal output and requires zero gas.
2. OUTPUT SPAN feature: To adjust the 20mA signal output and requires span gas near full range.

Note: In the field or in the absence of the preferred gases, use the OUTPUT SPAN feature and adjust the 20mA signal output using the span gas available.

Procedure – regardless of type of adjustment:

1. When you select OUTPUT ZERO OR OUTPUT SPAN, the microprocessor defaults to 100% to start.
2. The “actual” 4-20mA signal output will be adjusted to the “theoretical” value of the LCD display.
3. Adjustment general rule:
 - a) If the actual 4-20mA value < the theoretical LCD value, the adjustment value will be > 100%.
 - b) If the actual 4-20mA value > the theoretical LCD value, the adjustment value will be < 100%.
4. Convert the “actual” reading of the LCD display to the “theoretical” 4-20mA as follows:
 - a) Divide the “actual” (% or percent) LCD reading by the value of the span gas available.
 - b) Multiply 16mA (20mA – 4mA) times the “result of a.”
 - c) Add 4mA plus the “result of b.” to obtain the “theoretical” 4-20mA signal output value.
5. Adjustment value: Divide the theoretical by the actual 4-20mA values and multiply by 100.
6. Enter the adjustment value via OUTPUT ZERO or OUTPUT SPAN routines described below.

Example: Analyzer reading is 60 PPM (on 100 PPM range) with 84 PPM span gas, 4-20mA signal output at PLC is 24mA

Solution:

1. Use OUTPUT SPAN feature to make the adjustment.
2. Adjustment will be < 100% (default value of OUTPUT SPAN feature).
3. 13.6 mA is the “theoretical” 4-20mA converted from the “actual” reading of the LCD.
 - 60 PPM divided by 84 PPM = 0.71 or 71% of the range
 - 16mA multiplied by 0.71 = 11.36mA
 - 4mA plus 11.36mA = 15.36mA “theoretical” 4-20mA signal output value
 - 15.36mA divided by 24mA the “actual” 4-20mA value = 64.0 adjustment value
4. Enter 64.0 via OUTPUT SPAN procedure below.

Adjust 4 mA with Zero O₂

1. Access the MAIN MENU by pressing the MENU key.
2. Advance the reverse shade cursor using the ARROW keys to highlight CALIBRATION.
3. Press the ENTER key to select the highlighted menu option.

The following displays appear:

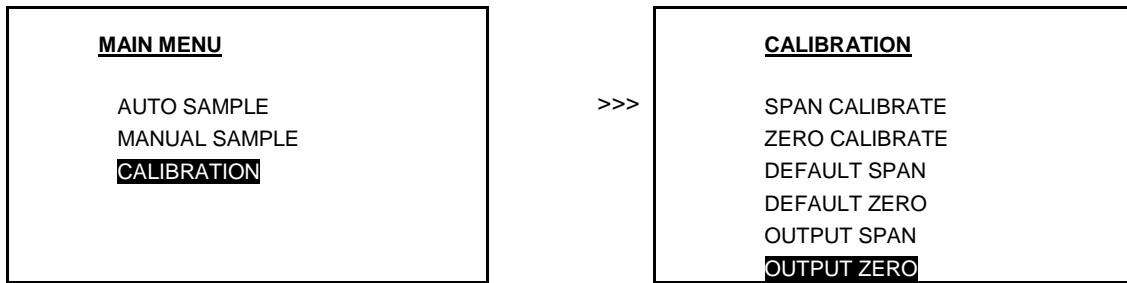

4. Advance the reverse shade cursor using the ARROW keys to highlight DEFAULT ZERO.
5. Press the ENTER key to select the highlighted menu option.

The following display appears:

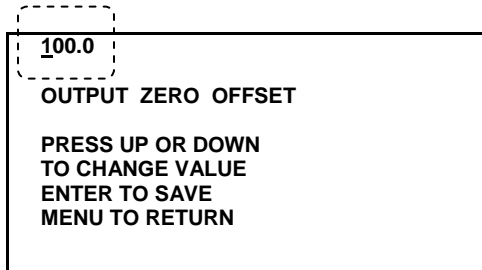

6. Enter the calculated adjustment value

NOTE: Once the initial adjustment is made and checked at the PLC it may be necessary to fine tune the initial adjustment by repeating. Any additional percent error must be added or subtracted from the initial adjustment value

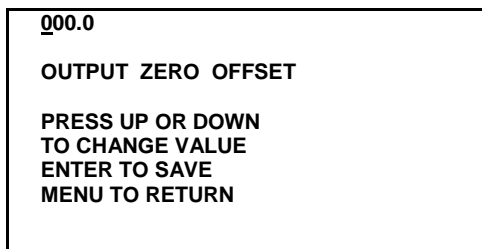

7. Press the ENTER key to advance the underline cursor right or press the MENU key to advance the underline cursor left to reach to the desired digit of the adjustment OUTPUT ZERO OFFSET value.
8. Press the ARROW keys to enter each the numerical value of each digit of the adjustment OUTPUT ZERO OFFSET value.
9. Repeat until the complete OUTPUT ZERO OFFSET value has been entered.

Save the adjustment value by pressing the ENTER key or abort by pressing the MENU key.

The system returns to the SAMPLING mode.

Adjust 20 mA at known O₂

1. Access the MAIN MENU by pressing the MENU key.
2. Advance the reverse shade cursor using the ARROW keys to highlight CALIBRATION.
3. Press the ENTER key to select the highlighted menu option.

The following displays appear:

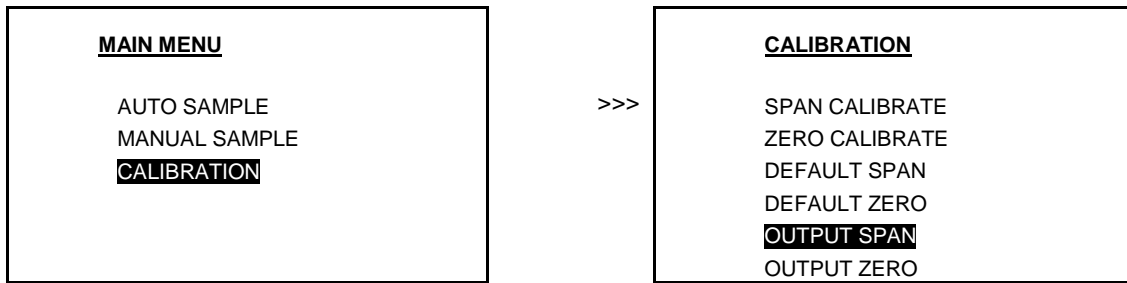

4. Advance the reverse shade cursor using the ARROW keys to highlight OUTPUT SPAN.
5. Press the ENTER key to select the highlighted menu option.

The following display appears:

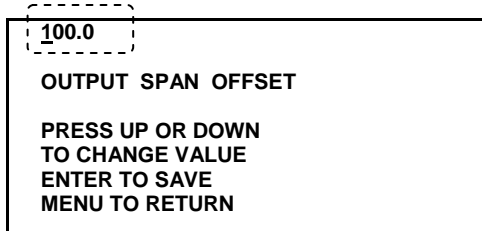

6. Enter the calculated adjustment value, refer to example described above.

Note: Once the initial adjustment is made and checked at the PLC it may be necessary to fine tune the initial adjustment by repeating. Any additional percent error must be added or subtracted from the initial adjustment value

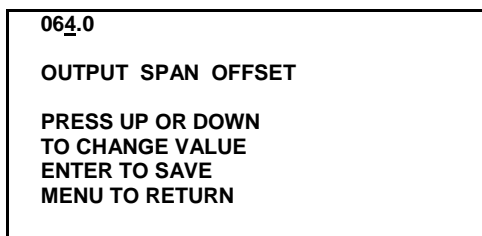

7. Press the ENTER key to advance the underline cursor right or press the MENU key to advance the underline cursor left to reach to the desired digit of the adjustment OUTPUT SPAN OFFSET value.
8. Press the ARROW keys to enter the numerical value of each digit of the OUTPUT SPAN OFFSET value.
9. Repeat until the complete OUTPUT SPAN OFFSET value has been entered.

Save the adjustment value by pressing the ENTER key or abort by pressing the MENU key.

The system returns to the SAMPLING mode.

Appendix F

H₂S Scrubbers & Sample Systems



B-2734-6 1x6"
 B-2734 1.5x12"
 B-3247 2.5x6"



B-3251 H₂S Scrubber System



GPR-1500 AIS with
 B-3247 H₂S Scrubber
 A-3393 H₂S Scrubber System

Advanced Instruments Inc. offers a complete line of efficient hydrogen sulfide (H₂S) scrubbers and sample conditioning systems for:

- Preparing a gas stream containing H₂S for oxygen analysis
- Zero gas generation for H₂S transmitters

The scrubber media selectively removes H₂S and other oxidizing gases from the gas stream that can interfere with the oxygen measurement. As an indication the scrubber is nearing the end of its useful life the media changes color from purple to orange to brown to white as it is consumed.

The information included herein is based on data sheets published by the manufacturer of the scrubbing media as follow: the media not only adsorbs gases but also chemically transforms them into harmless end products that remain trapped in the media. Unlike adsorption, chemisorption is an instantaneous and irreversible process that permanently removes unwanted gases from the environment. The potassium permanganate (KMnO₄), the purple colored media inside the scrubber, turns into manganese oxide and elemental sulfur salt which are stable non-leachable solids.

Scrubbers are available in refillable:

- 1.0" x 6" (P/N B-2734-6) plexi-glass container with SS connections
- 1.5" x 12" (P/N B-2734) plexi-glass container with SS connections
- 2.0" x 24" (P/N A-2839) stainless steel container with SS connections
- 2.5" x 6" (P/N B-3247) plexi-glass container with SS connections
- 2.5" x 24" (P/N B-3247-24) plexi-glass container with SS connections

They can be installed in-line or as part of a complete scrubber sample conditioning system. More elaborate custom designed scrubber sample conditioning systems can include dual scrubbers and valve system that can eliminate downtime. Operators simply switch the gas flow to the fresh scrubber while servicing the other one.

Specifications:

Inlet connections: 1/4" SS tube fitting (refill port)
 Outlet connections: 1/4" SS tube fitting
 Pressure rating: 30 psig maximum
 Temperature: -20°C to 45°C (-4°F to 113°F)
 Application conditions: Free of moisture (may require coalescing filter)
 Materials of construction: Clear acrylic and/or stainless steel
 Scrubber life: Varies with flow rate, media volume, H₂S concentration

Dimensions Part No.	H ₂ S Concentration	Flow Rate	Service Life - Days
1.5" x 12" (P/N B-2734)	1.0% (10,000 ppm)	1/3 SCFH (150 sccm)	3.6
	0.1% (1,000 ppm)	same	36.8
	0.01% (100 ppm)	same	368.2
2.5" x 6" (P/N B-3247)	1.0% (10,000 ppm)	1/3 SCFH (150 sccm)	6.0
	0.1% (1,000 ppm)	same	59.6
	0.01% (100 ppm)	same	596.4

- D. OPEN VALVE TO 3 SCFH ON FLOW METER
- E. OPEN VALVE TO 1.5 SCFH ON FLOW METER
- F. SET VALVE ON FLOW METER TO 2 SCFH FOR SPAN GAS, AFTER SPAN, OPEN VALVE FOR SAMPLE

4/11/07 REV. 1 - CHANGE STANDARD CONNECTIONS, AS SHOWN

Advanced Instruments Inc.

THIS DRAWING IS THE PROPERTY OF ADVANCED INSTRUMENTS INC. AND CONTAINS CONFIDENTIAL INFORMATION. IT IS TO BE REPRODUCED OR USED IN ANY MANNER WITHOUT WRITTEN PERMISSION.

TOLERANCES UNLESS OTHERWISE SPECIFIED: FRACTION 1/16", DECIMAL .005", ANGULAR 1/2°
 DATE 2/20/04 SCALE NONE DRAWER BJD ENGINEER APPROVAL ERS REV LEVEL
 MATERIAL ITEM NO. DESCRIPTION SEE LIST

DESCRIPTION: DRAWING NO.
GPR-1500 AIS/IS SAMPLE SYSTEM A-3393

Material Safety Data Sheet		U.S. Department of Labor		
May be used to comply with OSHA's Hazard Communication Standard, CFR 1910.1200. Standard must be consulted for specific requirements.		Occupational Safety and Health Administration (Non-Mandatory Form) Form Approved OBM No. 1218-0072		
IDENTITY (As used on Label and List) UNISORB MARK 2		Note: Blank spaces are not permitted. If any item is not applicable, or no information is available, the space must be marked to indicate that.		
Section I				
Manufacturer's Name UNISORB CORPORATION		Emergency Telephone Number (713) 943-3753		
Address (Number, Street, City, State, and ZIP Code) 1310 GENOA STREET SOUTH HOUSTON, TX 77587		Telephone Number for Information (713) 943-3753 Date Prepared JANUARY 7, 2002 Signature of Preparer (Optional)		
Section II - Hazardous Ingredients/Identity Information				
Hazardous Components (Specific Chemical Identity: Common Name(s))	OSHA PEL	ACGIH TLV	Other Limits Recommended	% (Optional)
Aluminum Oxide: Activated Alumina	15mg/m ³ (TWA)	10mg/m ³ (TWA)	None	
Potassium Permanganate: Potassium Salt	5mg/m ³ (TWA or Mn)	5mg/m ³ (TWA or Mn)	None	
Aluminum Oxide: CAS - 1344-28-1				
Potassium Permanganate: CAS - 7722-64-7				
Section III - Physical/Chemical Characteristics				
Boiling Point	N/A	Specific Gravity	3.2	
Vapor Pressure (mm Hg.)	N/A	Melting Point	2050 °C	
Vapor Density (Air = 1)	N/A	Evaporation Rate	N/A	
Solubility in Water Insoluble				
Appearance and Odor Purple Spheres, No Odor				
Section IV - Fire and Explosion Hazard Data				
Flash Point (Method Used) Not Flammable	Flammable Limits None		LEL N/A	UEL N/A
Extinguishing Media Foam, Carbon Dioxide, or Dry Chemical				
Special Fire Fighting Procedures Use Respiratory Protection				
Unusual Fire and Explosion Hazards None				

Appendix G

Maintenance – H2S Scrubber

Servicing any of the H2S scrubbers will depend on several factors as illustrated in Appendix F and include: the (average) H2S concentration, volume of scrubber media and flow rate through the scrubber (often times maximizing the service life means longer system response time) see Appendix F.

Required equipment:

1. 2x 7/16" open end wrenches
2. 1x 9/16" open end wrench
3. 1x 1" open end or adjustable wrench

Procedure:

Separate the top connection to the scrubber using a 7/16" and the 9/16" open end wrenches on the two top nuts.

Hold the second nut with the 9/16" open end wrench.

With one of the 7/16" open end wrenches turn the top nut counter clockwise until the fitting disengages.

Separate the bottom connection to the scrubber using both 7/16" open end wrenches.

Hold the nut at the bottom of the scrubber with a 7/16" open end wrench.

With the other 7/16" open end wrench turn the nut below counter clockwise until the fitting disengages.

Carefully, remove the stainless tubing from the top and bottom of the scrubber.

Carefully pull the scrubber from its mounting clip which is attached to the back panel.

Once the scrubber is free, hold the scrubber with one hand and using the 1" open end or adjustable wrench with the other hand, turn the 1" nut counter clockwise and remove the 1" nut from the scrubber.

There is no need to remove the 7/16" fitting at the bottom of the scrubber.

With the 1" nut removed, empty the spent media through the opening.

Fill the scrubber with fresh media (should be rich purple in color).

Reverse the above steps to re-assemble and install the scrubber.

Maintenance – Coalescing Filter

Servicing the coalescing filter (P/N FLTR-1002-2) depends on the cleanliness and moisture content of the sample and maintenance intervals.

Required equipment:

Channel locks

Damp rag

Lubricant (a thin coat applied to the o-ring after cleaning helps ensure a tight seal and extend o-ring life)

Procedure:

Unscrew the clear polycarbonate bowl by turning it counter clockwise.

Note: It is probably stuck tight – use a damp rag to grip if removing by hand or to prevent damage to the bowl if using the channel locks.

The bowl seals to the head section with an o-ring, do not lose the o-ring.

The filter element screws into the head section, carefully turn it counter clockwise and remove it from the head.

Using the damp cloth, clean the inside of the bowl and the o-ring before reassembling – apply a very thin coat of lubricant to the o-ring.

Reverse the above steps to re-assemble the filter.