

- AC/DC CURRENT OSCILLOSCOPE PROBE

SL261

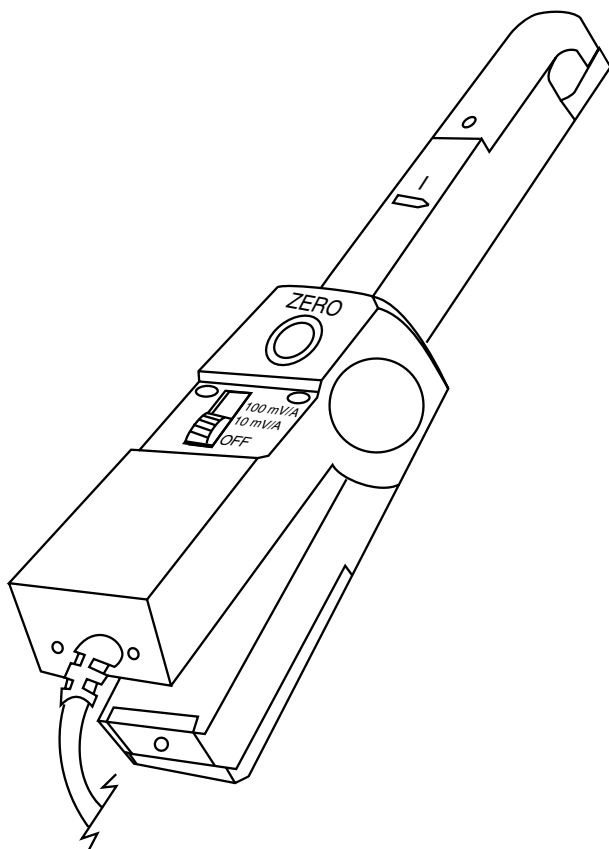

Statement of Compliance

Chauvin Arnoux®, Inc. d.b.a. AEMC® Instruments certifies that this instrument has been calibrated using standards and instruments traceable to international standards.

We guarantee that at the time of shipping your instrument has met its published specifications.

An NIST traceable certificate may be requested at the time of purchase, or obtained by returning the instrument to our repair and calibration facility, for a nominal charge.

The recommended calibration interval for this instrument is 12 months and begins on the date of receipt by the customer. For recalibration, please use our calibration services. Refer to our repair and calibration section at www.aemc.com.

Serial #: _____

Catalog #: 1201.51

Model #: SL261

Please fill in the appropriate date as indicated:

Date Received: _____

Date Calibration Due: _____



AEMC®
INSTRUMENTS

Chauvin Arnoux®, Inc.
d.b.a AEMC® Instruments
www.aemc.com

Table of Contents

1. INTRODUCTION.....	2
1.1 International Electrical Symbols.....	3
1.2 Definition of Measurement Categories	3
1.3 Receiving Your Shipment.....	3
1.4 Ordering Information.....	4
1.4.1 Accessories and Replacement Parts	4
2. PRODUCT FEATURES	5
2.1 Description.....	5
2.2 Compatibility	5
2.3 Features.....	6
3. SPECIFICATIONS.....	7
3.1 Electrical Specifications	7
3.2 Mechanical Specifications	8
3.3 Environmental Specifications.....	9
3.4 Safety Specifications	9
3.5 Typical Response Curves	10
4. OPERATION	12
4.1 Zero Adjustment.....	12
4.2 Current Measurement.....	12
4.3 Battery Indication (Green LED).....	13
4.4 Peak Overload (OL) Indication (Red LED)	13
5. MAINTENANCE	14
5.1 Maintenance	14
5.2 Cleaning.....	14
5.3 Replacing the Batteries.....	15
Repair and Calibration.....	16
Technical and Sales Assistance	16
Limited Warranty	17
Warranty Repairs.....	17







INTRODUCTION



The safety warnings are provided to ensure the safety of personnel and proper operation of the instrument. Read the instruction completely.

- Use caution on any circuit: potentially high voltages and currents may be present and may pose a shock hazard.
- Do not use the probe if damaged. Always connect the current probe to the measuring device before it is connected around the conductor
- Do not use on non insulated conductor with a potential to ground greater than 600V CAT III pollution 2. Use extreme caution when clamping around bare conductors or bus bars.
- Before each use, inspect the probe; look for cracks in housing or output cable insulation.
- Do not use clamp in wet environment or in locations that hazardous gases exist.
- Do not use the probe anywhere beyond the tactile barrier.

1.1 International Electrical Symbols

	This symbol signifies that the instrument is protected by double or reinforced insulation.
	This symbol on the instrument indicates a WARNING and that the operator must refer to the user manual for instructions before operating the instrument. In this manual, the symbol preceding instructions indicates that if the instructions are not followed, bodily injury, installation/sample and product damage may result.
	Risk of electric shock. The voltage at the parts marked with this symbol may be dangerous.
	This symbol refers to a type A current sensor. This symbol signifies that application around and removal from HAZARDOUS LIVE conductors is permitted.
	Probe fitted with an electronic output limiter providing protection against voltage surges caused by the accidental opening of the probe secondary circuit to 30V max. peak.
	In conformity with WEEE 2002/96/EC.

1.2 Definition of Measurement Categories

- CAT I:** For measurements on circuits not directly connected to the AC supply wall outlet such as protected secondaries, signal level, and limited energy circuits.
- CAT II:** For measurements performed on circuits directly connected to the electrical distribution system. Examples are measurements on household appliances or portable tools.
- CAT III:** For measurements performed in the building installation at the distribution level such as on hardwired equipment in fixed installation and circuit breakers.
- CAT IV:** For measurements performed at the primary electrical supply (<1000V) such as on primary overcurrent protection devices, ripple control units, or meters.

1.3 Receiving Your Shipment

Upon receiving your shipment, make sure that the contents are consistent with the packing list. Notify your distributor of any missing items. If the equipment appears to be damaged, file a claim immediately with the carrier and notify your distributor at once, giving a detailed description of any damage. Save the damaged packing container to substantiate your claim.

1.4 Ordering Information

AC/DC Current Probe Model SL261
(10A-100mV/A, 100A-10mV/A, BNC)..... **Cat. #1201.51**
Includes a user manual and a product warranty and registration card.

1.4.1 Accessories and Replacement Parts

Adapter - BNC Adapter for use with AC/DC Current Probe
Model SL261 & Meters 8220 & 8335..... **Cat. #2140.40**

PRODUCT FEATURES

2.1 Description

The SL261 AC/DC Current Oscilloscope Probe expands oscilloscope applications in industrial, automotive or power environments, and is ideal for analysis and measurement of distorted current waveforms and harmonics. The probe permits accurate display and measurement of currents from 100mA to 100Arms, DC to 100kHz without breaking into the circuit. The probe uses Hall effect technology to measure AC and DC signals. The probe connects directly to an oscilloscope through a 2 meter coaxial cable with an insulated BNC.

2.2 Compatibility

The Model SL261 is compatible with any analog or digital oscilloscope or other voltage-measuring instrument which has the following features:

- BNC input connector
- Range capable of displaying 0.2 to 0.5V per division
- Minimum input impedance of 1M Ω

2.3 Features

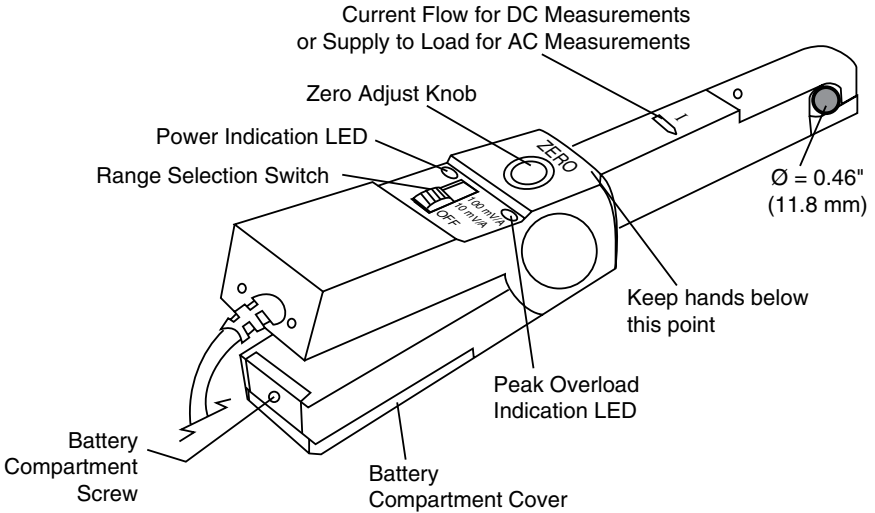

WARNING: Always keep hand on the handle part of the probe.

SPECIFICATIONS

3.1 Electrical Specifications

*Reference conditions: 23°C ± 5°C, 20 to 75% RH, DC to 1kHz, probe zeroed, 1 minute warmup, batteries at 9V ± 0.1V, external magnetic field < 40 A/m, no DC component, no external current carrying conductor, 1MΩ/100pF load, conductor centered in jaw.

Current Range:

100mV/A: 100mA to 10A peak

10mV/A: 1 to 100A peak

Output Signal: 1000mV peak max

AC Current Accuracy:

After calibration and for one year

(zero probe before making measurement)

Range	Accuracy	Phase Shift
100mV/A (50mA to 10A peak)	3% of reading ± 50mA	< 1.5° from DC to 65Hz
10mV/A (500mA to 40A peak)	4% of reading ± 50mA	< 1° from DC to 65Hz
10mV/A (40A to 100A peak)	15% max at 100A	

Frequency Range: DC to 100kHz (-3dB with current derating)

Noise:

Range 10mV/A: 480μV

Range 100mV/A: 3mV

Slew Rate:

Range 10mV/A: 20mV/μs

Range 100mV/A: 0.3V/μs

Load Impedance: > 1MΩ/100pF

Insertion Impedance (50/60 Hz): 100mV/A: 3μs

10mV/A: 0.01Ω

Rise or Fall Time: Range 100mV/A: 3 μ s
Range 10mV/A: 4 μ s

Working Voltage: 600Vrms max

Common Mode Voltage: 600Vrms max

Influence of Adjacent Conductor: < 0.2mA/A AC

Influence of Conductor Position in Jaw: 0.5% of reading at kHz

Battery: 9V alkaline (NEDA 1604A, IEC 6LR61)

Low Battery: Green LED when $\geq 6.5V$

Overload Indication:

Red LED indicates input greater than the selected range

Typical Consumption: 8.6mA

Battery Life: 55 hours typical

3.2 Mechanical Specifications

Zero Adjustment: 20 turn potentiometer

Maximum Cable Diameter: 0.46" (11.8 mm)

Case Protection: IP20 per IEC 529

Drop Test:

1.0m on 38mm of oak on concrete; test according to IEC 1010

Mechanical Shock: 100G; test per IEC 68-2-27

Vibration:

Test per IEC 68-2-6, frequency range 10 Hz to 55 Hz, amplitude 0.15mm

Handle: Lexan[®] 920A, UL 94 V2

Dimensions: 9.09 x 1.42 x 2.64" (231 x 36 x 67mm)

Weight: 11.6 oz (330g) with battery

Color: Light gray

Output Lead: Insulated coaxial cable with insulated BNC connector

Cable Length: 6.5 foot (2m)

3.3 Environmental Specifications

Operating Temperature: 0° to 50°C (32° to 122°F)

Storage Temperature: -30° to 80°C (-22° to 176°F)

Operating Relative Humidity:

10° to 30° C: 85 ± 5% RH (without condensation)

40° to 50° C: 45 ± 5% RH (without condensation)

Influence of Temperature: < 0.2% per °C

Altitude: Non-operating: 0 to 12,000m

Operating: 0 to 2000m

3.4 Safety Specifications



Electrical: Double insulation or reinforced insulation between the primary or secondary and the outer case of the handle per EN 61010-2-032.

600V, CAT III, Pollution Degree: 2

Electromagnetic Compatibility:

EN 50081-1 Class B

EN 50082-2 Electrostatic discharge IEC 1000-4-2

Radiated Field IEC 1000-4-3

Fast Transients IEC 1000-4-4

Magnetic Field at 50/60 Hz IEC 1000-4-8

**Specifications are subject to change without notice*

3.5 Typical Response Curves

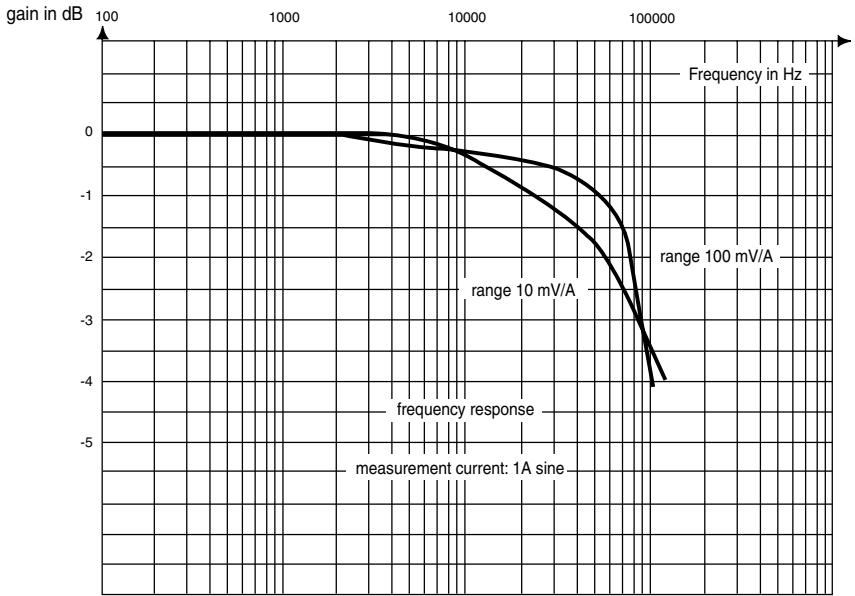

Frequency

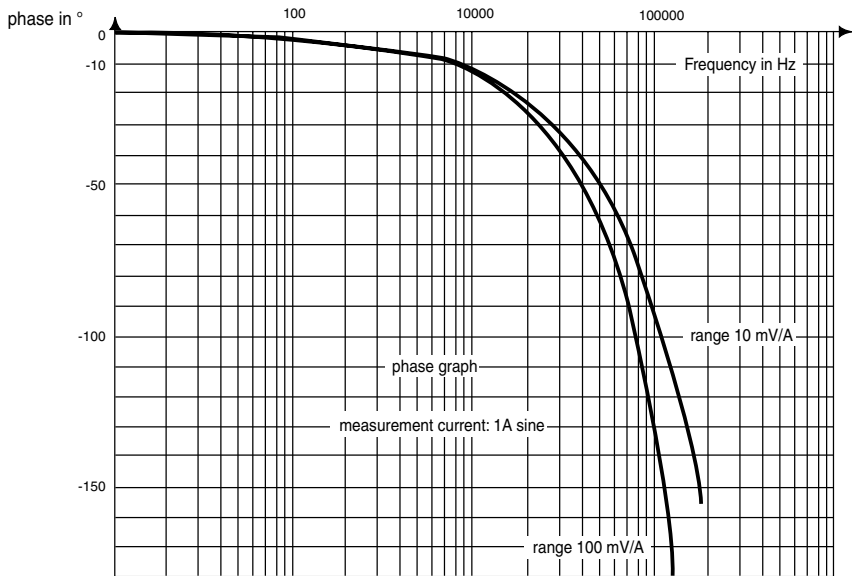

Phase Shift

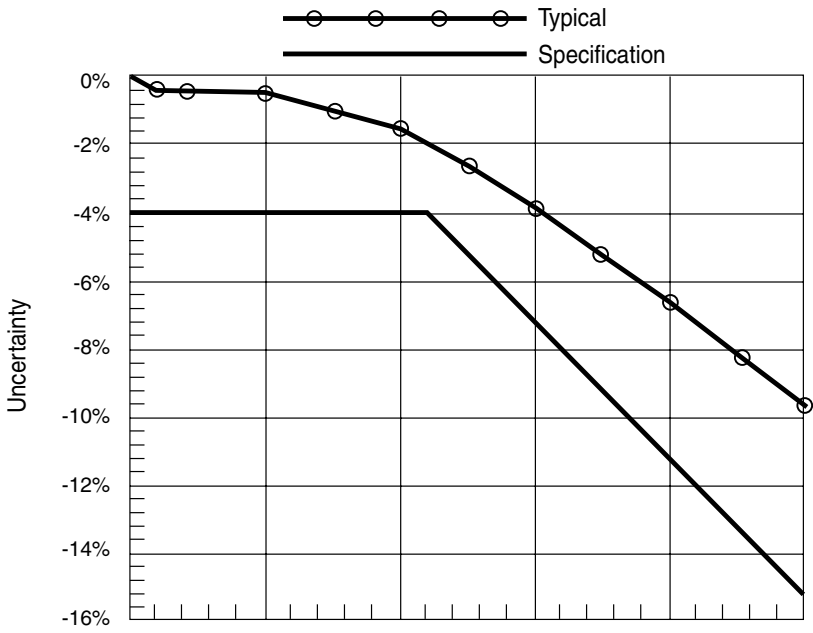

OPERATION

4.1 Zero Adjustment

The probe has a zero adjustment that should be adjusted before measurement. Alternatively, you may “zero” with the oscilloscope instead.

4.2 Current Measurement



WARNING: Always connect the probe to the instrument before clamping onto the circuit under test.

- Connect the Model SL261 to the proper input channel on the oscilloscope.
- Begin with the least sensitive range on the current probe (10mV/A)
- Select the 0.5V/Division range on the oscilloscope.
- Clamp the probe on the conductor to be measured and read the current flowing directly on your oscilloscope.

(Remember to unclamp the probe from the conductor before disconnecting it from your meter or instrument.)

You may also use your oscilloscope to amplify the signal while using the 100mV/A probe range (which offers the best accuracy and least phase shift).



NOTE: It is possible to change the range on the current probe without removing the probe from the current carrying conductor, but it is important to remember not to exceed the permissible peak ratings of 1000mV peak or 2000mV peak to peak maximum. The peak ratings by range are: 10A peak on the 100mV/A range, 100A peak on the 10mV/A range.

4.3 Battery Indication (Green LED)

The probe has a battery condition LED. To ensure proper readings with your current probe, be sure that the green LED is lit during measurement. If not, replace the 9V battery.

4.4 Peak Overload (OL) Indication (Red LED)

The SL261 offers an overload indicator. If the red LED illuminates during measurement, this indicates that the peak value exceeds the instrument response level and that the output is distorted. Switch the probe to a higher range if possible.

MAINTENANCE

5.1 Maintenance



WARNING

- To ensure optimum performance, it is important to keep the probe jaw mating surfaces clean at all times. Failure to do so may result in error in readings.
- For maintenance use only specified factory replacement parts.
- To avoid electrical shock, do not attempt to perform any servicing unless you are qualified to do so.
- To avoid electrical shock and/or damage to the instrument, do not allow water or other foreign substances into the case.
- Disconnect the unit from all circuits and test cables before opening the case.

5.2 Cleaning

- To clean the probe body, use a soft cloth dampened in a solution of mild detergent and water. To clean the core, open the jaw and clean the exposed core surfaces with a cotton swab dampened with isopropyl alcohol (isopropanol) or ethyl alcohol (fotocol or ethanol). Lubricate the jaws mating surfaces with a light oil.
- Do not use chemicals containing benzene, benzene, toluene, xylene, acetone, or similar solvents.
- Do not immerse the probe in liquids or use abrasive cleaners.

5.3 Replacing the Batteries



CAUTION: Risk of electric shock. Disconnect all input(s) from the unit or remove the probe from any conductor before opening the battery cover to change the batteries.

If the green battery indication LED does not light up when the probe is turned on, the batteries will need to be replaced.

Do not replace the battery while probe is in use.

To replace the battery:

- Disconnect the probe from the circuit and the oscilloscope.
- Turn the probe “OFF”.
- Unscrew the battery compartment screw and pull out the battery compartment cover.
- Replace the battery and put the cover back on.

Repair and Calibration

To ensure that your instrument meets factory specifications, we recommend that it be scheduled back to our factory Service Center at one-year intervals for recalibration, or as required by other standards or internal procedures.

For instrument repair and calibration:

You must contact our Service Center for a Customer Service Authorization Number (CSA#). This will ensure that when your instrument arrives, it will be tracked and processed promptly. Please write the CSA# on the outside of the shipping container. If the instrument is returned for calibration, we need to know if you want a standard calibration, or a calibration traceable to N.I.S.T. (Includes calibration certificate plus recorded calibration data).

Ship To: Chauvin Arnoux®, Inc. d.b.a. AEMC® Instruments
15 Faraday Drive
Dover, NH 03820 USA
Phone: (800) 945-2362 (Ext. 360)
(603) 749-6434 (Ext. 360)
Fax: (603) 742-2346 or (603) 749-6309
E-mail: repair@aemc.com

(Or contact your authorized distributor)

Costs for repair, standard calibration, and calibration traceable to N.I.S.T. are available.

NOTE: You must obtain a CSA# before returning any instrument.

Technical and Sales Assistance

If you are experiencing any technical problems, or require any assistance with the proper operation or application of your instrument, please call, mail, fax or e-mail our technical support team:

Chauvin Arnoux®, Inc. d.b.a. AEMC® Instruments
200 Foxborough Boulevard
Foxborough, MA 02035 USA
Phone: (800) 343-1391
(508) 698-2115
Fax: (508) 698-2118
E-mail: techsupport@aemc.com
www.aemc.com

NOTE: Do not ship Instruments to our Foxborough, MA address.

Limited Warranty

The AC/DC Current Oscilloscope Probe Model SL261 is warranted to the owner for a period of one year from the date of original purchase against defects in manufacture. This limited warranty is given by AEMC® Instruments, not by the distributor from whom it was purchased. This warranty is void if the unit has been tampered with, abused or if the defect is related to service not performed by AEMC® Instruments.

For full and detailed warranty coverage, please read the Warranty Coverage Information, which is attached to the Warranty Registration Card (if enclosed) or is available at www.aemc.com. Please keep the Warranty Coverage Information with your records.

What AEMC® Instruments will do:

If a malfunction occurs within the one-year period, you may return the instrument to us for repair, provided we have your warranty registration information on file or a proof of purchase. AEMC® Instruments will, at its option, repair or replace the faulty material.

**REGISTER ONLINE AT:
www.aemc.com**

Warranty Repairs

What you must do to return an Instrument for Warranty Repair:

First, request a Customer Service Authorization Number (CSA#) by phone or by fax from our Service Department (see address below), then return the instrument along with the signed CSA Form. Please write the CSA# on the outside of the shipping container. Return the instrument, postage or shipment pre-paid to:

Ship To: Chauvin Arnoux®, Inc. d.b.a. AEMC® Instruments
15 Faraday Drive • Dover, NH 03820 USA
Phone: (800) 945-2362 (Ext. 360)
(603) 749-6434 (Ext. 360)
Fax: (603) 742-2346 or (603) 749-6309
E-mail: repair@aemc.com

Caution: To protect yourself against in-transit loss, we recommend you insure your returned material.

NOTE: You must obtain a CSA# before returning any instrument.



05/11

99-MAN 100042 v10