

OX^{III} SERIES

Portable Oscilloscopes

100MHz 2-channel OX 7102^{III}
100MHz 4-channel OX 7104^{III}
200MHz 2-channel OX 7202^{III}
200MHz 4-channel OX 7204^{III}

(Firmware v4.17)

[User Manual](#)



AEMC[®] Instruments d.b.a. Chauvin Arnoux[®], Inc.
15 Faraday Drive • Dover, NH 03820
Tel. (603) 749-6434 • Fax: (603) 742-2346

Contents

General instructions		Chapter I
General.....	4	
Software updating.....	7	
Description of the instrument		Chapter II
Presentation	9	
Views	10	
Terminal Boards.....	11	
Activation.....	16	
Battery.....	17	
Using the menus	19	
Network.....	19	
Micro SD Card	23	
Description of Accessories		Chapter III
PROBIX	29	
HX0030	30	
HX0031	31	
HX0032	32	
HX0033	33	
HX0034	34	
HX0035	35	
HX0036	36	
HX0072	37	
HX0073	38	
Recommendations for use.....	40	
Oscilloscope Mode		Chapter IV
Keys.....	42	
Display	47	
Menus		
"Vertical" menu	54	
"Trigger" menu	66	
"Horizontal" menu	77	
"Display" menu	82	
"Measurement" menu	84	
"Memory" menu	89	
"Utilities" menu	92	
"Help" menu	99	
Multimeter Mode		Chapter V
Keys.....	102	
Display	104	
Menus	107	
"Vertical" menu	108	
"Trigger" menu	110	
"Horizontal" menu	111	
"Display" menu	111	
"Measurement" menu	113	
"Memory" menu	116	
"Utilities" menu	116	
"Help" menu	116	

Harmonic Analysis Mode		Chapter VI
Display	118
Menus		
	"Vertical" menu	122
	"Horizontal" menu	124
	"Display" menu	125
	"Measure" menu	125
	"Memory" menu	126
	"Utilities" menu	126
	"Help" menu	126
Recorder Mode		Chapter VII
Keys	128
Display	131
Menus		
	"Vertical" menu	139
	"Trigger" menu	140
	"Horizontal" menu	145
	"Display" menu	146
	"Measurement" menu	147
	"Memory" menu	149
	" Utilities" menu	152
	"Help" menu	154
HTTP and FTP Server		Chapitre VIII
General	156
ScopeNet	157
ScopeAdmin	167
PolicyTool	169
FTP Server	170
Applications		Chapter IX
Display of the calibration signal	171
Automatic measurements	173
Cursor measurements	174
Phase offset measurement with cursor	174
Automatic phase measurement	174
Manual phase measurement	175
Videosignal display	175
Examination of a specific TV line	177
Automatic measurement in "Harmonic Analysis" Mode	178
"ROLL" Mode display of slow phenomena	180
Min/Max Acquisition	181
Measurement in "Multimeter" Mode	183
Measurement in "Recorder" Mode	184
ETHERNET network application examples	188
File transfer	188
Hard copy on network printer	189
Installation of a FTP server	190
"Virtual Printers"	194
Technical Characteristics		Chapter X
Specifications	200 to 217
General & Mechanical Specifications		Chapter XI
Specifications	218
Supply		Chapter XII
Supply	219
Index		

General Instructions

Introduction



Congratulations ! You have just purchased a portable digital **oscilloscope**.

Thank you for your trust in the quality of our products.

Here is the family of instruments to which it belongs:

OX 7102^{III}	color	2-channel	100 MHz	2.5 GS/s sample
OX 7104^{III}	color	4-channel	100 MHz	2.5 GS/s sample
OX 7202^{III}	color	2-channel	200 MHz	2.5 GS/s sample
OX 7204^{III}	color	4-channel	200 MHz	2.5 GS/s sample



All instruments in this range are equipped with Micro SD card.

This oscilloscope also offers the following modes:

- **FFT Analyzer**
- **Multimeter/Wattmeter**
- **Harmonic Analyzer**
- **Recorder**

It complies with safety standard NF EN 61010-1 (2001), double insulation, relative to electronic measuring instruments.

For optimum service, read this manual carefully and comply with the operating precautions.

Non-compliance with the warnings and/or operating instructions might damage the instrument and/or its components and could prove dangerous for the user.

Precautions and safety measures



- This instrument has been designed for use:
 - indoors
 - in an environment with pollution level 2
 - at an altitude of less than 2000 m
 - at a temperature between 0°C and 40°C
 - with relative humidity of less than 80% up to 31°C.
- The safety of any system integrating the apparatus concerns the responsibility of the assembler of the system.
- It can be used for measurements on circuits 600V CAT III, 1000V CAT II in relation to earth and can be powered by a 98 to 264V mains network, with an external power supply. However, some accessories can lead you to use this instrument on circuits of lower voltage and category. Conform the given values when connecting the accessory.

General Instructions (cont'd)

Precautions and safety measures (cont'd)

before use

- Comply with environmental and storage conditions.
- External power supply must be connected to the instrument and to the mains network (from 98 to 264 VAC). Make sure that it is in good working conditions.

during use

- Read carefully all the notes preceded by the symbol .
- The instrument power supply is equipped with an electronic protection system which is reset automatically when the fault is eliminated.
- Be sure not to obstruct the ventilation holes.
- As a safety measure, use only suitable cords and accessories supplied with the instrument or approved by the manufacturer.

Definition of measurement categories

CAT I : CAT I circuits are circuits protected by low level transient over-voltage limiters
Example: protected electronic circuits

CAT II : CAT II circuits are household or similar appliance power circuits, which may carry medium-level transient over-voltage.
Example: household appliance and portable tool power supplies

CAT III : CAT III circuits are high-power appliance power circuits, which may carry high-level transient over-voltage.
Example: industrial machinery or instrument power supplies

CAT IV : CAT IV circuits are circuits which can carry very substantial transient over-voltage.
Example: power feeders

Symbols used on the instrument



Warning: Risk of danger.
Refer to the operating manual to find out the nature of the potential hazards and the action necessary to avoid such hazards.



Earth



Dual insulation



Selective sorting of waste for recycling electric and electronic materials.
In accordance with the WEEE 2002/96/EC directive: must not be treated as household waste.



Application or withdrawal not authorized for non-insulated conductors carrying dangerous voltage levels

General Instructions (cont'd)

Warranty



This equipment is guaranteed for **3 years** against any defect in materials or workmanship, in accordance with the general terms and conditions of sale.

During this period, the equipment can only be repaired by the manufacturer. The manufacturer reserves the right to carry out repair or replacement of all or part of the equipment. If the equipment is returned to the manufacturer, initial transport costs shall be borne by the customer.

The **warranty** does not apply following:

- unsuitable use of the equipment or use with other incompatible equipment
- modification of the equipment without explicit authorization from the manufacturer's technical services
- repair carried out by a person not certified by the manufacturer
- adaptation to a specific application, not provided for in the definition of the equipment or by the operating manual
- an impact, a fall or a flooding.

Maintenance and metrological verification



Before the equipment is opened, it must be disconnected from the mains supply and the measurement circuits, and the operator must not become charged with any static electricity. This could cause the destruction of internal parts.

Any adjustment, servicing or repair of the unit *under power* must be undertaken only by qualified personnel, after reading the instructions in this manual.

A **qualified person** is a person who is familiar with the installation, its construction, its use and the hazards that exist. They are authorized to activate and deactivate the installation and equipment, in compliance with the safety instructions.

As for all surveying equipment, yearly metrological checks are necessary. These checks can also be done as part of preventative maintenance.

Information and contact details : contact your nearest distributor.

Unpacking - Repacking



All the equipment was verified mechanically and electrically before shipping.

When you receive it, carry out a quick check to detect any damage that may have occurred during transport. If necessary, contact our sales department immediately and register any legal reservations with the carrier.

In the event of reshipping, it is preferable to use the original package. Indicate the reasons for the return as clearly as possible in a note attached to the equipment.

Repair

For all repairs before or after expiration of warranty, please return the device to your distributor.

General instructions (cont'd)

Cleaning



- Turn the instrument off.
 - Clean it with a damp cloth and soap.
 - Never use abrasive products or solvents.
 - Allow to dry before any further use.
-

Update the instrument's internal software



- Go to the www.aemc.com website.
- In the "Tech Info" section, select "[Software & Firmware Updates](#)".
- Download the "firmware" corresponding to your instrument.
- Also download the installation instructions for this firmware.
- Refer to these instructions to update your instrument.

Description of the instrument

Note: The color of the housing may vary in images between the manual and the actual unit.



This manual describes the operation of an **OX^{III}** oscilloscope.

OX 7xx4 : the adjustment of the 4 channels is accessible by the opposite keys.



OX7xx2 : the adjustment of the 2 channels is accessible by the opposite keys.

Presentation

This instrument is part of our range of portable oscilloscopes.

Its special feature is that it groups **4 instruments** into one:

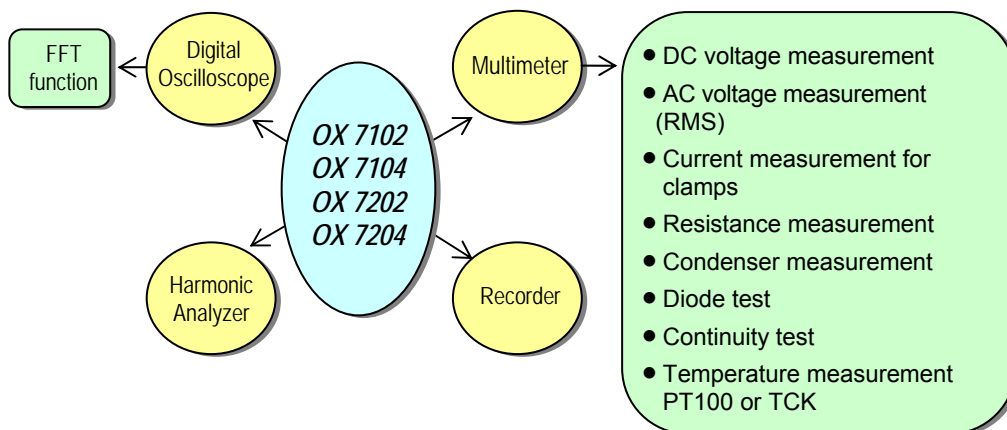

- a digital **oscilloscope** for laboratory use, intended for the analysis of the signals encountered in electronics and electrical engineering
- an 8,000-count **multimeter**
- a "**harmonic**" analyzer, for breaking down 4 signals (or 2) (option)
- a **recorder**, designed to capture single or slow signals (option)



All the channels are insulated from one another for measurements on 600V CAT III, 1000V CAT II installations with appropriated PROBIX accessories while complying with the standard IEC 61010-1 (2001).

The instrument works with a constant acquisition depth of 2500 counts.

Memory management is organized using a "Windows[®]"-type file system.

A large **LCD screen** is used to view the signals applied, along with all the settings.

The main control functions are directly accessible using the keys on the front panel and can be modified using a **touch-sensitive pad** with the **stylus** supplied.

A graphical interface similar to a PC's is used to:

- select the advanced functions by means of drop-down menus and the touch-sensitive pad
- act directly on the objects (curves, cursors, etc.) displayed on the screen.

This means that the settings can be modified.

This instrument is completed by :

USB via HX0084 adapter

ETHERNET

CENTRONICS (option)

RS232 via HX0042 cable (option)

Description of the instrument (cont'd)

OX 7202^{III}

Front Panel



Rear Panel

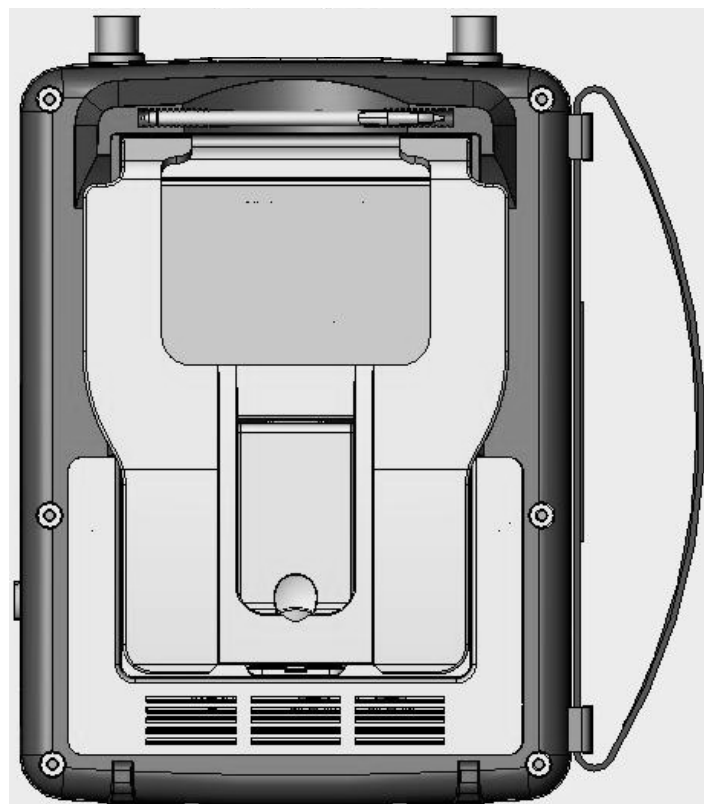

Description of the instrument (cont'd)

OX 7204^{III}

Front Panel



Rear Panel

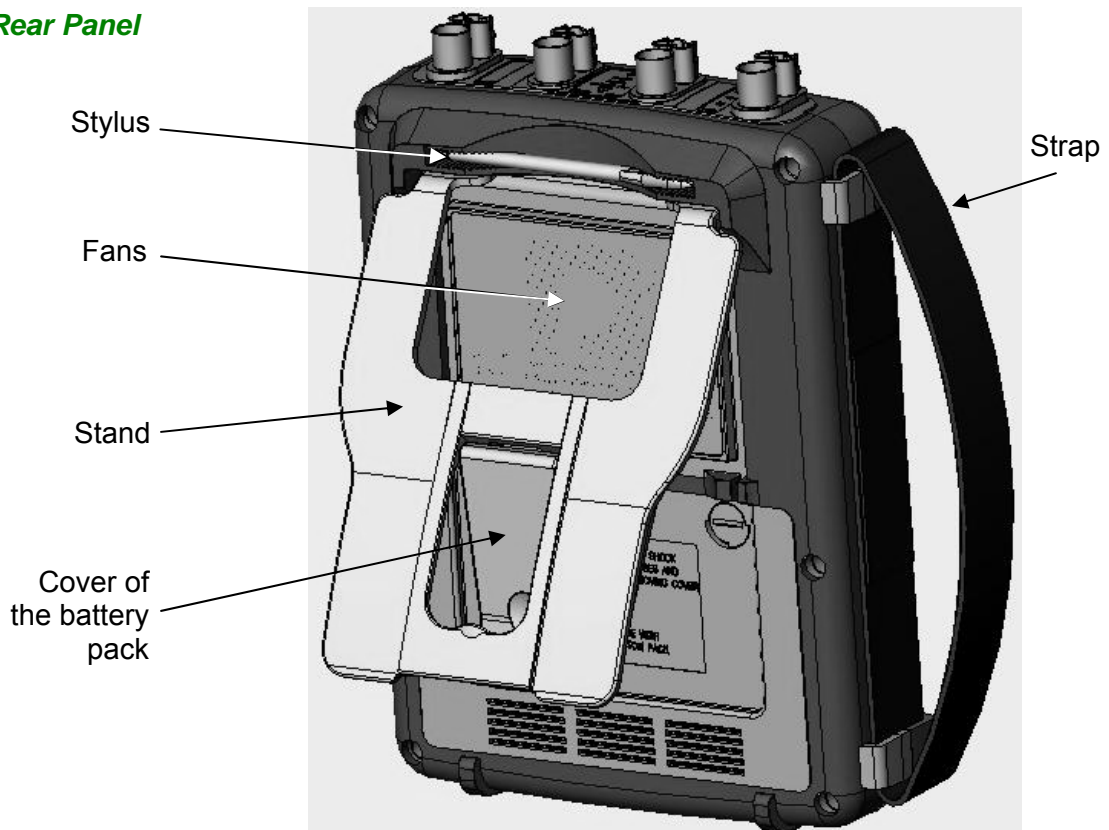

Using the stand The oscilloscope is equipped with a tilt-stand, allowing easy viewing while placed on a benchtop.

Description of the instrument (cont'd)

Markings on rear panel

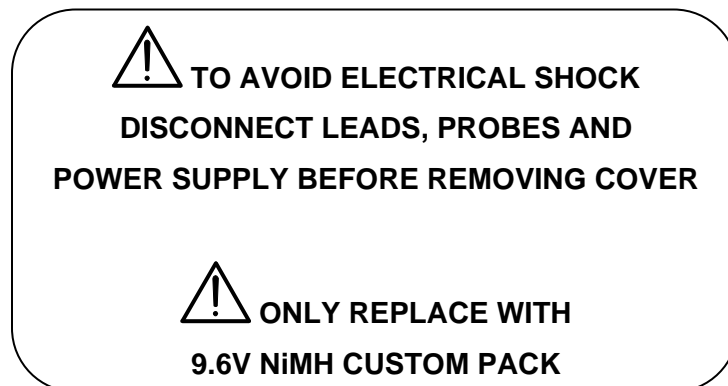
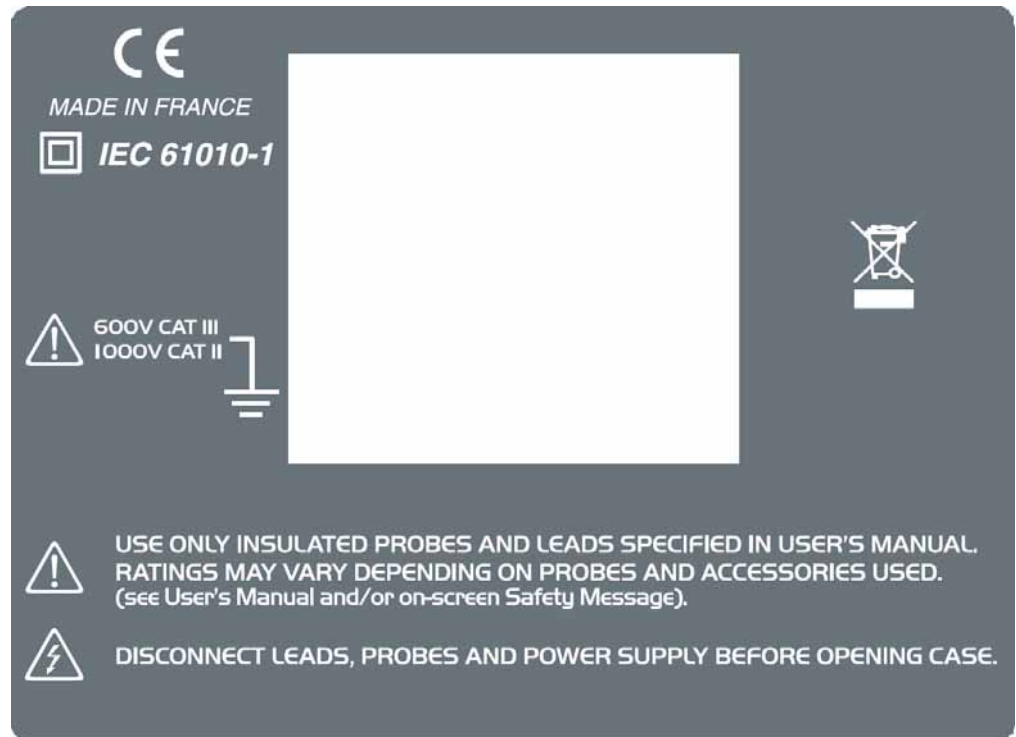

Description of the instrument (cont'd)

Side view



Marking

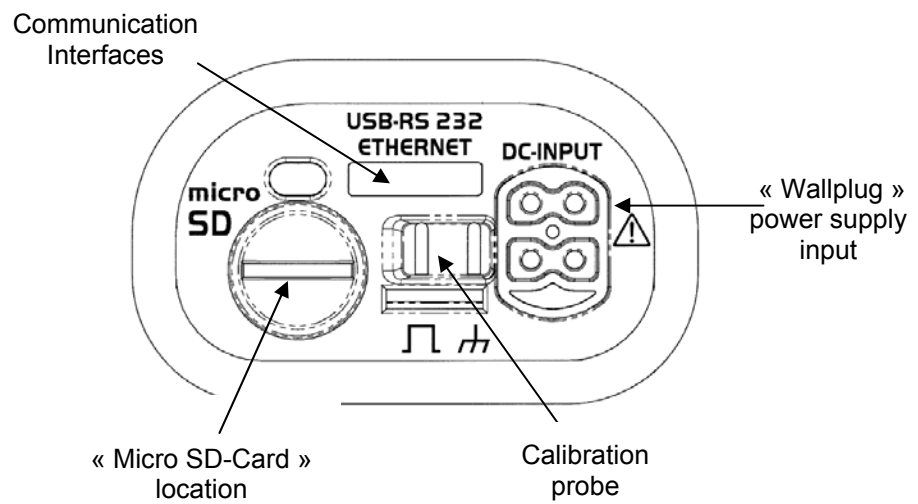

Description of the instrument (cont'd)

Measurement terminal block

OX 7202^{III}



Marking

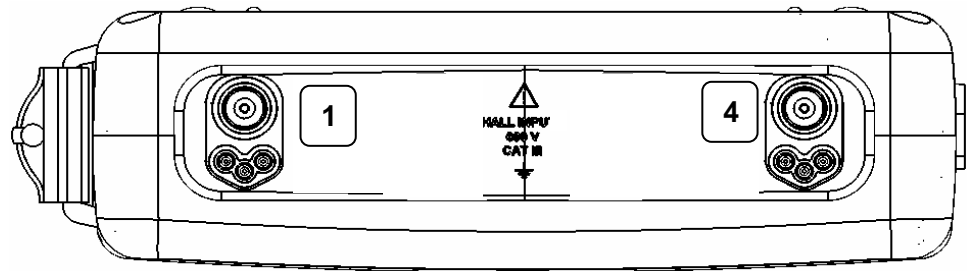

OX 7204^{III}



Marking

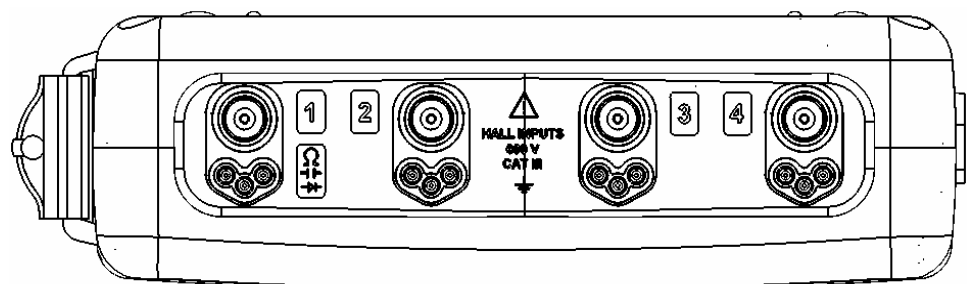

Description of the instrument (cont'd)

Front (description)

The main functions of the instrument are accessible on the front panel and can be modified using the touch-sensitive pad (with its stylus) or the menu bar.

1 On/Standby/Off key



- power on by a short press
- switch the instrument to standby (yellow LED flashing inside the key) by one short press. A second press on the key reactivates the instrument.
- power off by a long press (> 3 s):
 - the recording time of the files and configuration is < 15 s.
 - In certain cases, the standby of the instrument is effective 45 s. after a long press on this key.



If the instrument is not equipped with a battery, never disconnect the instrument from the mains while the message "System shut down : Please wait before switch off power" is displayed on the screen. Otherwise, the current file and all the files previously saved will be lost.

1 touch-sensitive pad and stylus

These can be used for:

selection of menus,
validation of functions,
movement of symbols appearing on the LCD screen.

- The **menus** at the top of the screen and the submenu selected by the pointer open and are validated with the stylus.
- The **menus** in the curve display area, the command area, the status area can be opened with the stylus.
- The **stylus** can move the symbols displayed in:
 1. the main display area:
 - trigger position
 - position of cursors
 - reference of the traces displayed
 2. the bargraph:
 - trigger position
 - position of cursors
 - position of zoomed area in the acquisition memory

Place the pointer on the symbol to be moved and keep the stylus pressing down while you move it to the required position.

- It is possible to use the stylus to **zoom** in the display area: drag to create a rectangle.

4 "operating mode" keys



You can select the operating mode of the instrument by pressing one of these 4 keys:

"oscilloscope"
"multimeter"
"harmonic analyzer"
"recorder"

28 keys only active when pressed

Shortcut access to the most common functions: see chapter on "The Keys" for the "Oscilloscope", "Multimeter", "Harmonic Analyzer" and "Recorder" modes.

Description of the instrument (cont'd)

Initial operation of the oscilloscope

The portable oscilloscopes in this range are designed to operate on a power source delivering 98 to 264 V (ACrms) or in stand-alone mode with a battery.

The instruments are delivered with a mains adapter, an external power supply (battery charger) and an Ni-MH battery (9.6V, 3.5Ah).

Fuse



Type: time delay, 2.5 A, 250 V, 5 x 20 mm

The external power supply is equipped with a protection fuse that must only be replaced with an identical model.

Replacement must only be performed by qualified personnel.

Contact your nearest service centre.

Starting up

- Connect the 4-point lead of the external power supply to the "DC-Input" socket located on the side of the oscilloscope.

 **Do not insert any metal objects into this lead.**

- Connect the mains lead from the external power supply to the external power supply.

The **POWER** LED on the adapter lights up, indicating that it is live.

The **CHARGE** LED flashes, indicating:

- the absence of the battery or
- slow charging of the battery, if it is present in the oscilloscope.

Press the instrument's ON switch: it lights on and then a clock is displayed on the screen during the start-up sequence.

The message "Instrument start-up" is displayed.

The oscilloscope is then ready for use.



By default, the "Advanced" mode is not active (see page 98).



The symbol  in the display area for the current value means that the instrument is connected to the mains supply.

Description of the instrument (cont'd)

 **To prevent any electric shocks, remove the Probix adapters and the external power supply lead before installing or replacing the battery.**

- Using a coin or a screwdriver, turn by a quarter turn (counter-clockwise) the 2 plastic screws located on the cover of the battery compartment located at the rear of the instrument
- Lift the cover of the battery compartment by inserting the coin under the slot at the top of the cover.
- Then connect the 4-point battery connector to the connector located inside the battery compartment of the oscilloscope, taking care to respect the failsafe systems.
- Position the battery inside the oscilloscope compartment (battery wires at the bottom of the oscilloscope's battery compartment).
- Close the cover of the battery compartment and lock it by turning the 2 plastic screws by one quarter turn (clockwise).

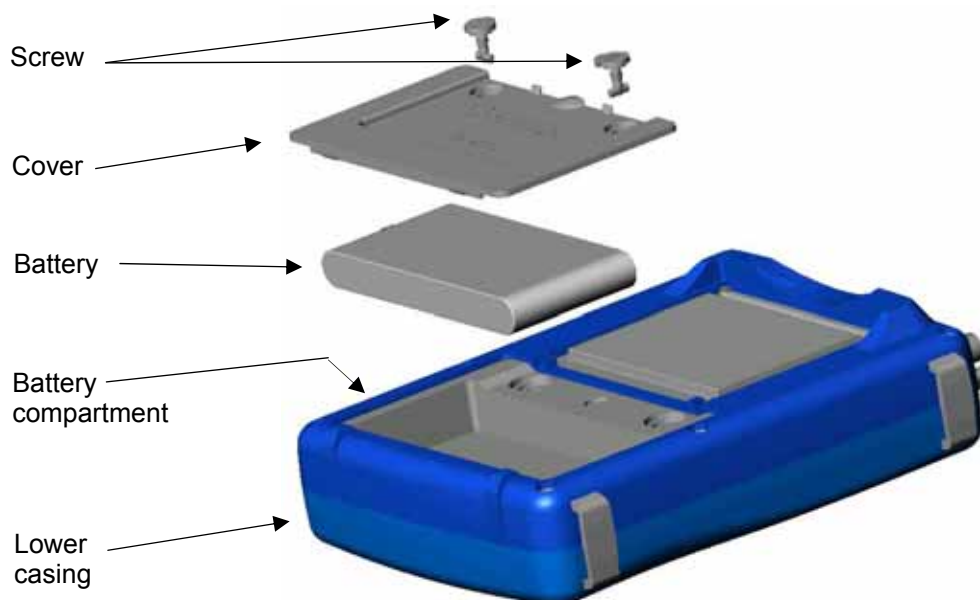

Changing the battery

Follow the same procedure and make sure that the replacement battery model is identical to the original one.

The oscilloscope contains a Ni-MH battery. The flat battery must be handed over to a recycling firm or a company specialized in the treatment of dangerous waste materials. **Never dispose of the battery with other solid waste.**

For further information, contact your nearest service centre.



When the oscilloscope is delivered, the battery may be discharged and require a complete recharge. Full charging of the battery will then take about two and a half hours, with the oscilloscope switched off.

Description of the instrument (cont'd)

Charging the battery

Once the battery is located in its compartment, follow the external power supply start-up instructions.

- To speed up recharging of the battery, switch off the power to the oscilloscope by a long press on the ON/OFF button.
- Battery fully discharged: during the first 10 minutes, the **CHARGE** LED of the external power supply flashes, indicating that the battery is slow-charging. The **CHARGE** LED then lights up when it switches to fast-charging.



During the loading of the battery (after 15 min), the startup of the oscilloscope causes the premature stop of the load. It is possible to re-start the loading while disconnecting, then reconnecting the charger.

The LED goes out when the battery is fully charged (approx. 2h30).

Charging the battery while using the oscilloscope

When the oscilloscope is connected to the mains via the external power supply, it is possible to perform slow-charging of the battery.

The **CHARGE** LED of the external power supply lights up. Full recharging of a totally discharged battery then takes approx. five hours and a half. The LED goes out when the battery is fully charged.



Frequently recharging a battery when it is not fully discharged reduces its life span.

Powering the instrument with the battery

When the oscilloscope is powered by a battery, a charge status indicator is included in the display area of the current value:



the battery is 100% charged



the battery is 80% charged



the battery is 60% charged, etc.



this symbol indicates that there are only a few minutes more, so you are advised to recharge it or switch to the mains supply.



The battery is totally flat and the screen is about to be deactivated. You must either recharge the battery or connect the instrument to the external power supply.

If you change battery, a complete battery charge and discharge cycle (until the instrument is automatically deactivated when discharging has finished) is essential to calibrate this indicator.



To maintain the battery in good condition, use the oscilloscope at least until the level  before recharging.

Description of the instrument (cont'd)

Using the menus

The various instrument parameters can be accessed via menus.

The rules for using, selecting and modifying an option are identical to those defined by Microsoft Windows.

To input a numerical value (time base, alignment, etc.), a double click on the numerical field brings up a virtual keyboard:

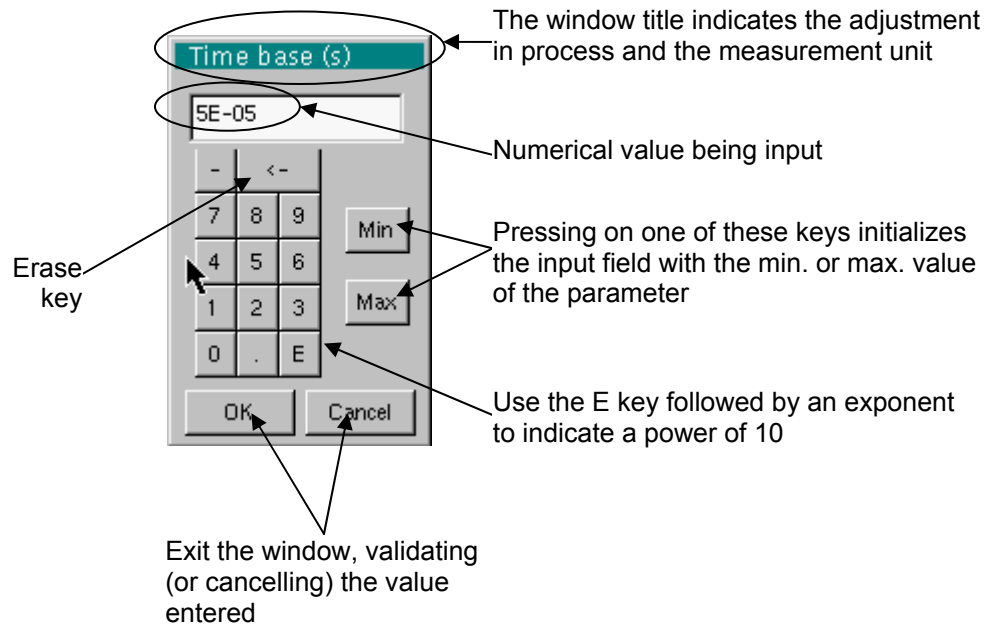

Network

Configuration of the "Network" interface (ETHERNET).

This interface uses the same connector (USB/RS232/ETHERNET), located on the right-hand side of the instrument, and requires a specific ETHERNET / RJ 45 cable.

General principles of the ETHERNET network

ETHERNET and TCP/IP (Transmission Protocol/Internet Protocol) are used to communicate on a company's network.

Addressing

Each piece of equipment under TCP/IP has a physical address (ETHERNET) and an Internet address (IP).

ETHERNET physical addresses

A physical or ETHERNET address, stored in ROM or PAL, identifies each item of equipment on the network. The physical address enables the equipment to determine the source of data "packet" transmission. The physical address is a number coded over 6 bytes represented in hexadecimal form. Hardware manufacturers procure physical addresses and allocate them incrementally when the product is manufactured. The physical addresses cannot be modified.

Description of the instrument (cont'd)

IP addresses

An IP address is coded over 4 bytes, displayed in decimal format.

(🔗 *Example:* 132.147.250.10). Each field may be coded between 0 and 255 and is separated by a decimal point.

Unlike the physical address, the IP address can be modified by the user.



You must ensure that the IP address is unique on your network. If an address is duplicated, network operation becomes random.

The IP address is made up of two parts:

- the network identifier (Network ID) identifying a given physical network
- the host identifier (Host ID) identifying a specific item of equipment on the same network.

There are 5 addressing classes. Only classes A, B and C are used to identify the equipment.

See below:

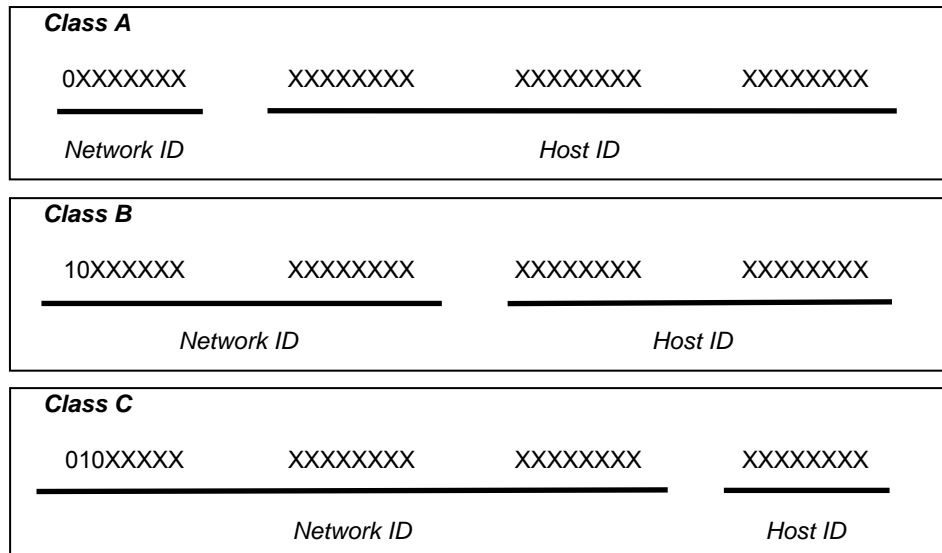

Description of the instrument (cont'd)

SUBNET mask and GATEWAY

If the result of the operation ' ET LOGIQUE' between IP address of the recipient of the message and the value of subnet mask is different from the address of the recipient of the message, this message is sent to the gateway which will be given the responsibility to forward it to destination.

The programming of the mask and the address of the gateway is possible on the instrument, in the Advanced mode.

DHCP Protocol

This protocol is used to automatically assign an IP address to the instrument when it connects up to the network.

A **DHCP** (Dynamic Host Configuration protocol) server must be accessible on this network (contact your network administrator to make sure that this server is present).

FTP protocol

A file can be transferred quickly between a PC and the instrument using FTP (File Transfer Protocol).

To use the "FTP Server" function, open your favourite browser on the PC (Firefox, Explorer 7, Chrome, ...) and type in the URL field:

"ftp://192.168.3.1/RAM:" to access the internal file system of instrument IP address 192.168.3.1

"ftp://192.168.3.1/CARD:" to access the file system of instrument SDCARD IP address 192.168.3.1

The oscilloscope is can also be used as an **FTP client**.

See §. Applications p. 190.

HTTP protocol

The instrument integrating the 'HTTP server' protocol functions like a WEB server and can be accessed from a PC using a standard browser (EXPLORER, NETSCAPE, FIREBOX ...). You can then reach the most current adjustments and visualize traces on your PC.

To use it, open the browser on the PC and, in the **URL field**, type the IP address of the instrument, preceded by "**http:**"

 *Example: http://192.168.3.1*

See §. Applications p. 156.



To be able to display the traces, you must install on your PC the Java Virtual Machine JVM SUN 1.4.1 (or higher). This JVM can be downloaded from the site <http://java.sun.com>

LPD protocol

This protocol (Line Printer Daemon) is used by most of the printers connected to an ETHERNET network, but also by the printing server units which handle conversion between ETHERNET and CENTRONICS.

( *Example: Jet Admin*) and UNIX and LINUX workstations.

An **LPD** server can also be installed on a PC (available as an option with WINDOWS 2000 or XP).

In all cases, the instrument is an **LPD** client which has to be configured to indicate to it the IP address of the **LPD** server (the workstation PC or directly the printer) and the logical name of the printer managed by the server. "Virtual Printers" can also be used for this purpose.

See §. Applications p. 189.

Micro SD Memory Card

Introduction

The internal memory of the oscilloscope (2MB) may be extended by using an SD Card (128MB - 2GB).

The oscilloscope accepts the Micro-SD format (but not Micro-SDHC).



FAT32 format is not compatible with the oscilloscope.

Installation

Location

The SD Card compartment is located on the right-hand side of the oscilloscope near the communications interface connector.

Insertion/Extraction

- Insert the SD Card, in the card compartment, printed surface facing up.
- Push to the click → the card is in position.
- To remove the card, press slightly on the card itself and support it while removing.

Operation

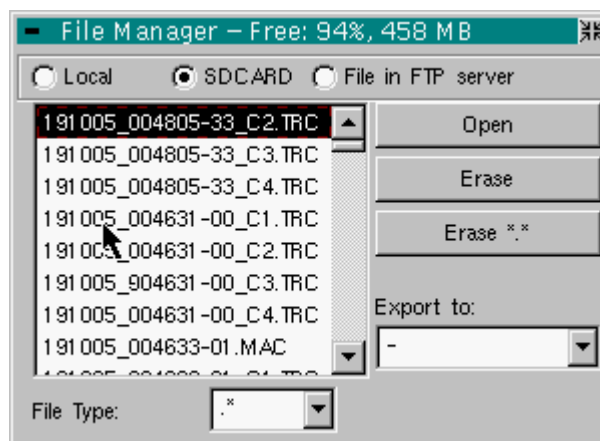

Recording a file



- The filename is limited to a maximum of 20 characters + extension. If this rule is not observed, the message: 'Filename too long' is displayed.
- If the name already exists or is incompatible, an error message 'Impossible! File already exists' will be displayed.
- By moving the pointer  onto the names of the files, you will see their characteristics displayed (date and time saved and size).

Micro SD Memory Card (cont'd)

Special folder

A specific folder on the SD Card, called "metrix", is used for recording files by the oscilloscope.

From within the oscilloscope, the user can only act in this folder:

- File creation,
- File saving,
- File deletion.

If, at the moment of file saving, the "metrix" folder does not exist, it is automatically created.

"Hot Plugging"

It is possible to insert or remove an SD Card from its compartment, even when the oscilloscope is running. Never remove a card while a file is being written on it. Doing so can cause the file save operation to fail, and even damage the memory card.

If a window displaying the memory was open during card insertion/removal, it is recommended to close it, then to open it again to update the display.

Formatting the SD Card

The SD Card is formatted using a PC. It cannot be formatted via the oscilloscope.

Two options:

- either using Windows software directly
- or using a specialized software application.

See next page.

Micro SD Memory Card (cont'd)

Formatting with Windows

(French Windows XP example shown)

1. Insert the SD Card into the SD Card slot of your PC, or using the special USB adapter.
2. Access the workstation window by clicking on:

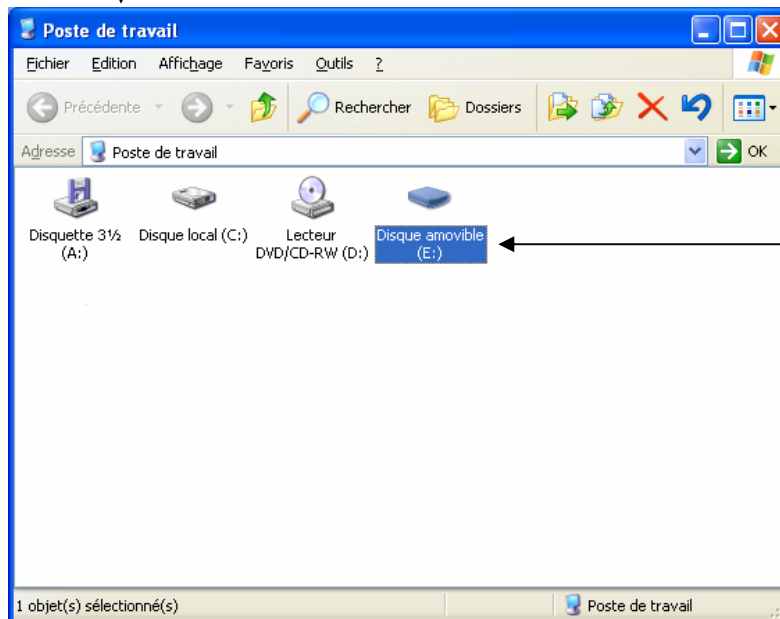

Here, the SD Card is represented by disk "E:"

3. By a right click on the disk, representing the SD Card, select the option "Format..."

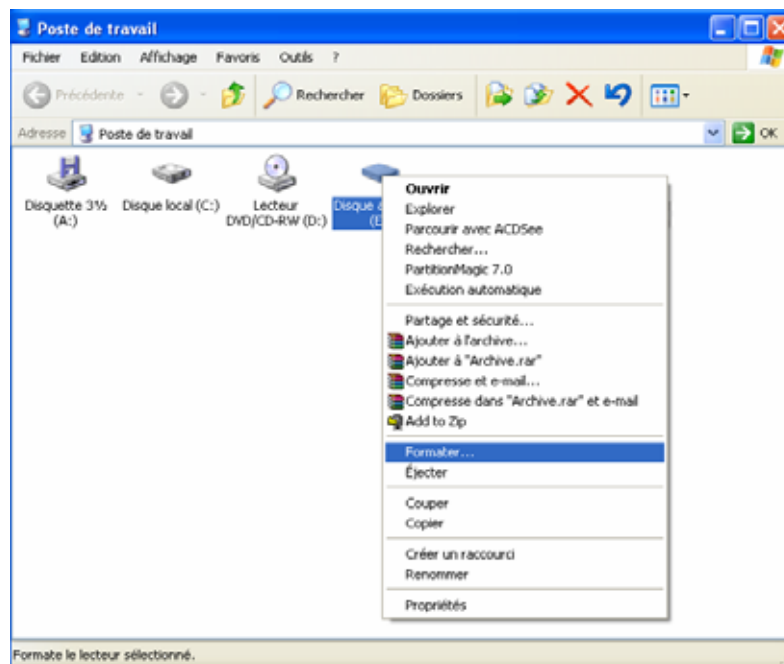

Micro SD Memory Card (cont'd)

The "Format disk..." window appears:

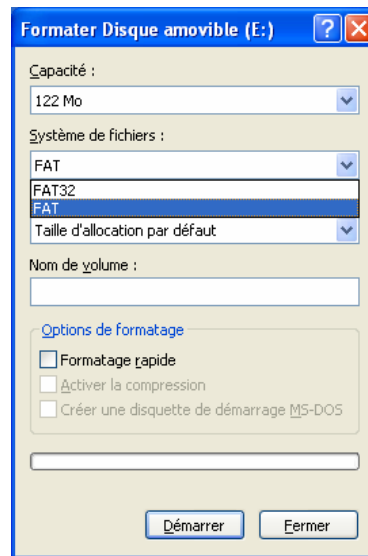

4. In the "File System" block, select option FAT (not FAT32, which is not compatible with the oscilloscope).
Click on: "Start".
5. A message appears, warning that the formatting will delete all data memorized on the SD Card.
If you really wish to continue, click on "OK". Formatting will begin.

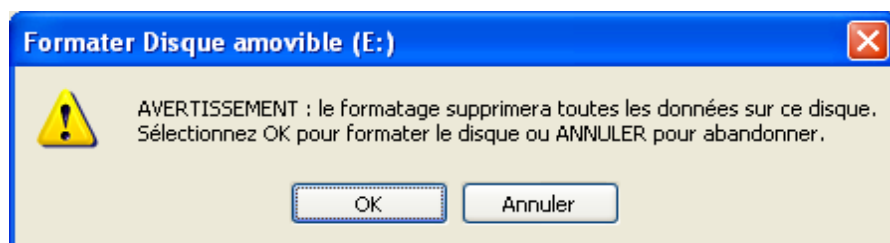

Formatting using specialized software

It is possible to download a free software called "SDFormatter" on this website: www.sdcard.org.

This software is specifically designed to format SD Cards.

Its use is very simple.

FAT16 format, compatible with the oscilloscope, is selected by default.

NOTES:

Description of Accessories



Concept The portable oscilloscopes in this range use **ProbiX intelligent probes and adapters**, offering users active safety.

When connected to an oscilloscope input, a safety message in English concerning the probe or adapter used indicates:

- its maximum input voltage according to the category
- its maximum voltage in relation to the earth, according to the category
- its maximum voltage between channels, according to the category
- its type
- its basic specifications
- the use of suitable safety leads.

 *For user and instrument safety, this information must be respected.*

Some probes are equipped with buttons whose assignment can be programmed.

The color of the signal measured with a particular accessory is parameterized in the "Green" → "chX" → "ProbiX" menu. An interchangeable elastic band or plastic ID markers can be used to match the probe color to the curve color.

The scaling and the units are managed automatically by the ProbiX system, thus allowing fast measurements and without risk of error.

The oscilloscope provides the power supply for the probes and adapters.



Recommendations for use: see p. 39.

Description of Accessories (cont'd)

HX0030

(Cat. #2124.73)

Probix 1/10 probe

The HX0030 accessory is a 1/10 probe equipped with a LED and pushbuttons (A and B), the action of which can be programmed via the menu: "Green" → "chX" → "PROBIX".

This adapter is a PLUG and PLAY element. Its internal electronics are powered by the oscilloscope.

The measurement output is totally insulated.

When the HX0030 probe is connected to the OSCILLOSCOPE, the following information is displayed.

This information may be different if other PROBIX probes are connected.

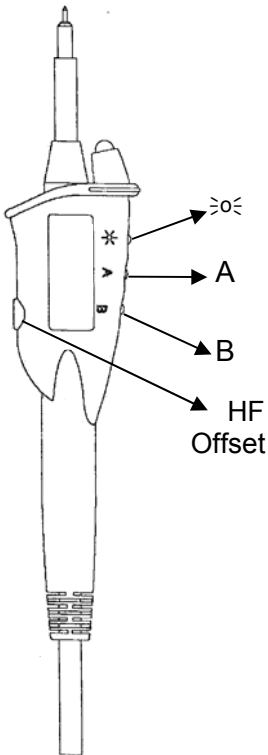

ch1: PROBIX event			
! HX30 - 1/10 Probe 250MHz Bandwidth, +/- 1%(DCV)			
	Input:	Floating:	Between Channel:
Ch1	1000V CAT II	600V CAT III	600V CAT III
HX30	600V CAT III		
Ch2	-	600V CAT III	600V CAT III
-	-		
Ch3	-	600V CAT III	600V CAT III
-	-		
Ch4	-	600V CAT III	600V CAT III
-	-		

☞ The positive input is indicated by a + sign.

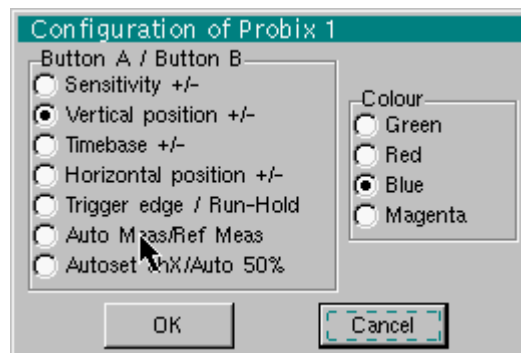

The " ⚡ " button controls the lighting of the area measured.

Description of Accessories (cont'd)

HX0031

(Cat. #2124.74)

Probix BNC adapter

The HX0031 accessory is a BNC adapter, connected via a BNC lead to a measuring signal.

This adapter is a PLUG and PLAY element. Its internal electronics are powered by the oscilloscope.

The measurement output is totally insulated.

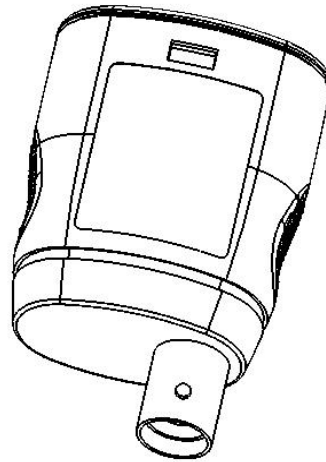

When the HX0031 probe is connected to the OSCILLOSCOPE, the following information is displayed.

This information may be different if other PROBIX probes are connected.

- ch1: PROBIX event			
 HX31 - BNC Adapter >30V CAT I, Use isolated rated BNC leads			
	Input:	Floating:	Between Channel:
Ch1	600V CAT III	600V CAT III	600V CAT III
HX31			
Ch2	-	600V CAT III	600V CAT III
-	-		
Ch3	-	600V CAT III	600V CAT III
-	-		
Ch4	-	600V CAT III	600V CAT III
-	-		

Description of Accessories (cont'd)

HX0032 (Cat. #2124.75)

Probix BNC 50Ω adapter

The HX0032 accessory is an adapter with a 50Ω load, connected via a BNC lead to a measuring signal.

This adapter is a PLUG and PLAY element. Its internal electronics are powered by the oscilloscope.

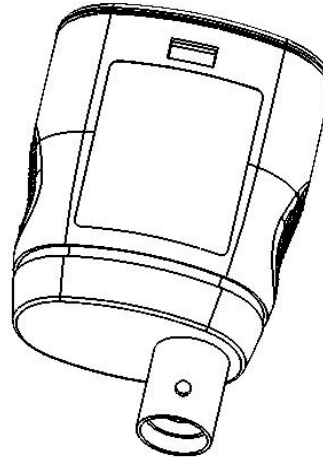

To distinguish between this adapter and the HX0031, the measuring signal unit via an HX0032 adapter is "VΩ"; this unit can be modified via the menu: "Green" → "chX" → "Vertical scale".

 **The maximum input voltage to the HX0032 is 10Vrms.**

When the HX0032 probe is connected to the OSCILLOSCOPE, the following information is displayed.

This information may be different if other PROBIX probes are connected.

ch1: PROBIX event			
 HX32 - 50Ω BNC Adapter 2Wmax >30V CAT I, Use safety rated leads			
	Input:	Floating:	Between Channel:
Ch1	10Vrms MAX	600V CAT III	600V CAT III
HX32			
Ch2	-	600V CAT III	600V CAT III
-	-		
Ch3	-	600V CAT III	600V CAT III
-	-		
Ch4	-	600V CAT III	600V CAT III
-	-		

Description of Accessories (cont'd)

HX0033 (Cat. #2124.76)

*Probix banana
adapter
Ø4 mm:*

The HX0033 accessory is an adapter used to connect leads with banana plugs.

This adapter is a PLUG and PLAY element. Its internal electronics are powered by the oscilloscope.

The measurement output is totally insulated.

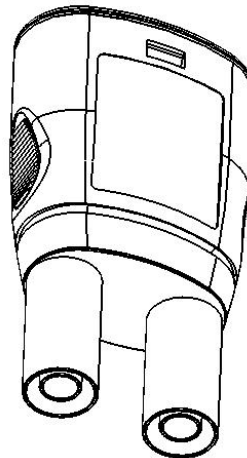

When the HX0033 probe is connected to the OSCILLOSCOPE, the following information is displayed.

This information may be different if other PROBIX probes are connected.

- ch1: PROBIX event			
 DERATING -20dB/decade from 100kHz Use safety leads			
	Input:	Floating:	Between Channel:
Ch1	600V CAT III	600V CAT III	600V CAT III
HX33			
Ch2	-	600V CAT III	600V CAT III
-			
Ch3	-	600V CAT III	600V CAT III
-	-		
Ch4	-	600V CAT III	600V CAT III
-	-		

Description of Accessories (cont'd)

HX0034

(Cat. #2124.77)

Probix current clamp adapter

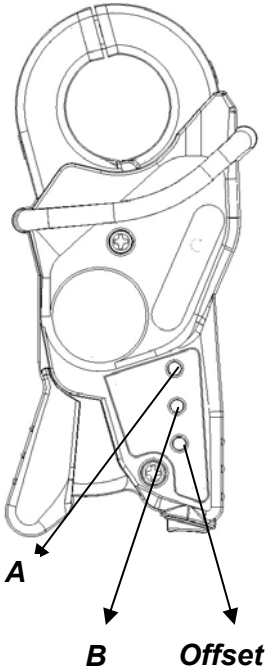

The HX0034 accessory is a current clamp using a Hall-effect cell to measure DC or AC currents up to 80A peak, without any intervention on the electrical installation (cutting off the current to be measured).

A voltage output transducer, this clamp is a "PLUG and PLAY" element. Its internal electronics are powered by the oscilloscope.

The action generated by the pushbuttons (A and B) can be programmed via the menu "Green" → "chX" → "Probix". Use the third push-button (Offset) to adjust the residual offset (see below).

The measurement output is totally insulated.

Utilization

1. Connect the clamp to the oscilloscope: it is recognized by the instrument and the measurement unit is displayed in A/div. on screen.
2. Adjust the offset by pressing the "Offset" button.
The offset can only be adjusted when no current is present. However, the presence of a DC current is permitted. In this case, the offset will be obtained in relation to this initial current.
3. Use the trigger to open the jaws of the clip and then insert the conductor, respecting the current direction.
4. Close the clamp. Make sure that it is properly closed and centered on the conductor for optimum measurement accuracy.

When the HX0034 probe is connected to the OSCILLOSCOPE, the following information is displayed.

This information may be different if other PROBIX probes are connected.

	Input:	Floating:	Between Channel:
Ch1	-	600V CAT II	600V CAT II
HX34	-	600V CAT III	600V CAT II
Ch2	-	600V CAT III	600V CAT II
-	-	-	-
Ch3	-	600V CAT III	600V CAT II
-	-	-	-
Ch4	-	600V CAT III	600V CAT II
-	-	-	-

Description of Accessories (cont'd)

HX0035 (Cat. #2124.78)

**Probix
K Thermocouple
adapter**

The HX0035 accessory is an adapter used to linearize temperature measurements from a K-type thermocouple.

This adapter is a PLUG and PLAY element. Its internal electronics are powered by the oscilloscope.

Thermocouple and earth are electrically insulated.

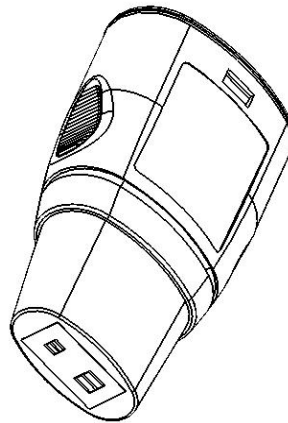

The signal unit measured via an HX0035 is "°C".

When the HX0035 probe is connected to the OSCILLOSCOPE, the following information is displayed.

This information may be different if other PROBIX probes are connected.

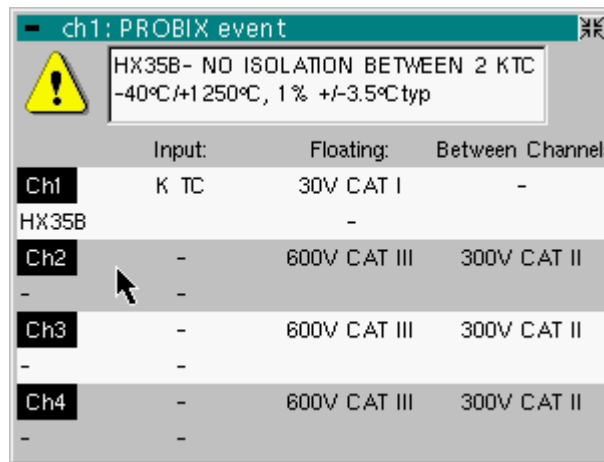

Measurements are available 30 sec. after connection of the HX0035, after a calibration phase.

During this phase, the following message is displayed:

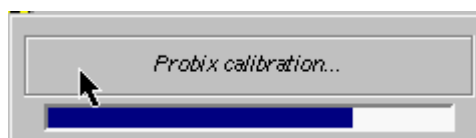

Description of Accessories (cont'd)

HX0036

(Cat. #2124.98)

Probix RTD100 (PT100) adapter

The HX0036 accessory is an adapter used to linearize temperature measurements from an RTD100.

This adapter is a PLUG and PLAY element. Its internal electronics are powered by the oscilloscope.

RTD100 and earth are electrically insulated.

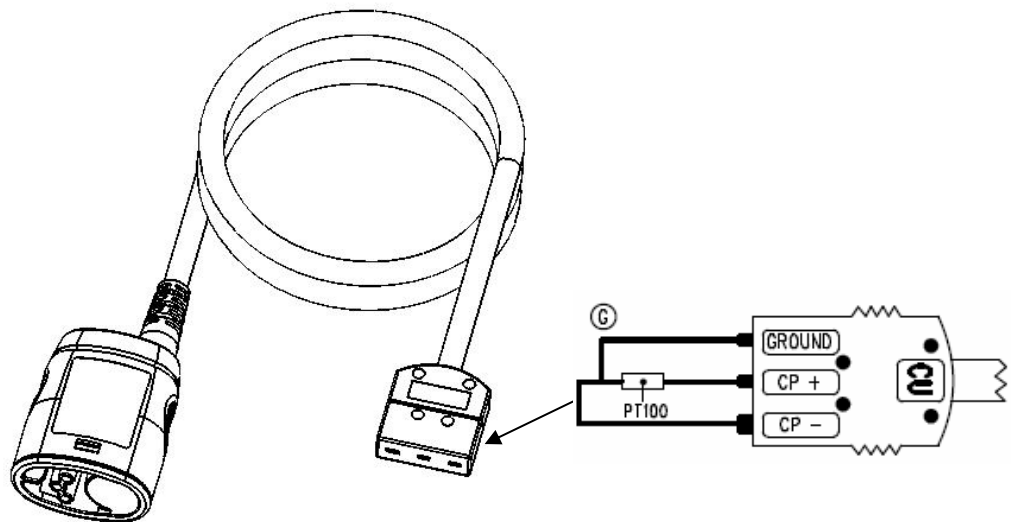

The signal unit measured via an HX0036 is "°C".

When the HX0036 probe is connected to the OSCILLOSCOPE, the following information is displayed.

This information may be different if other PROBIX probes are connected.

ch1: PROBIX event

! HX36 -NO ISOLATION BETWEEN 2 PT100
-100°C/+500°C, 1%+/-1.5°C_{typ}

	Input:	Floating:	Between Channel:
Ch1	PT100	30V CAT I	-
HX36		-	
Ch2	-	600V CAT III	300V CAT II
-	-	-	-
Ch3	-	600V CAT III	300V CAT II
-	-	-	-
Ch4	-	600V CAT III	300V CAT II
-	-	-	-

Measurements are available 30 sec. after connection of the HX0036, after a calibration phase.

During this phase, the following message is displayed:

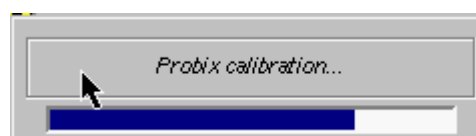

Description of Accessories (cont'd)

HX0072 (Cat. #2124.91)

Probix
AmpFlex® probe

HX0072 is an AmpFlex® **Probix** probe, to be used to measure AC currents of up to 3000ARMS.

This adapter is a PLUG and PLAY element. Its internal electronics are powered by the oscilloscope.

3000A~
1000V CAT III
600V CAT IV

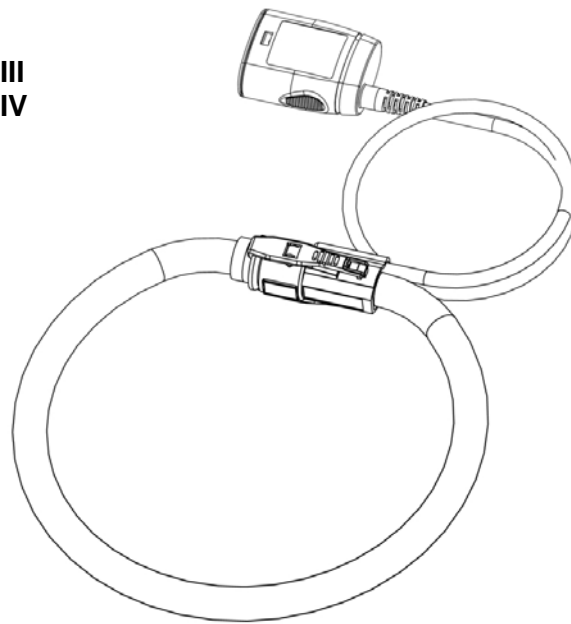

When connecting the HX0072 probe to the **OSCILLOSCOPE**, safety information is displayed.

This information may be different if other **Probix** accessories are connected.

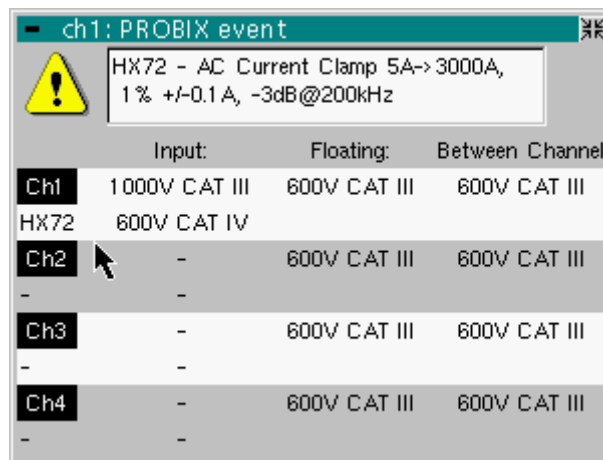

The range of use for weak currents is wider than that indicated in the information window, which corresponds to the specified measuring field.

Description of Accessories (cont'd)

HX0073 (Cat. #2124.92)

Probix
MiniFlex®
probe

HX0073 is an MiniFlex® **Probix** probe, to be used to measure AC currents of up to 300ARMS.

This adapter is a PLUG and PLAY element. Its internal electronics are powered by the oscilloscope.

300 A ~
1000 V CAT III
600 V CAT IV

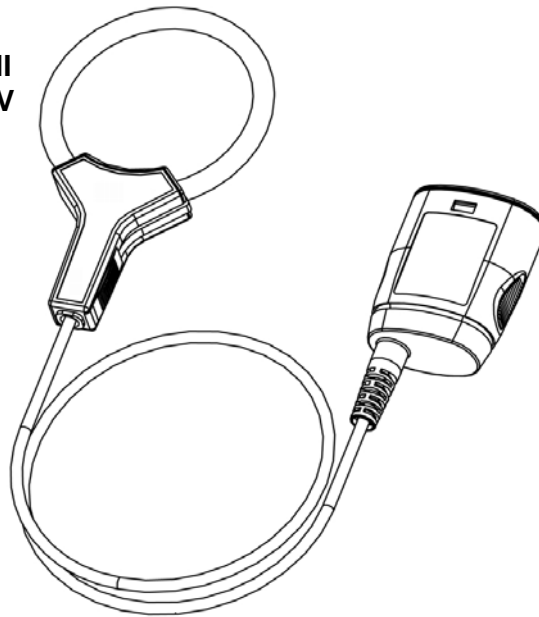

When connecting the HX0073 probe to the **OSCILLOSCOPE**, safety information is displayed.

This information may be different if other **Probix** accessories are connected.

- ch1: PROBIX event			
 HX73 - AC Current Clamp 1A->300A, 1% +/-20mA, -3dB@3MHz			
	Input:	Floating:	Between Channel:
Ch1	1000V CAT III	600V CAT III	600V CAT III
HX73	600V CAT IV		
Ch2	-	600V CAT III	600V CAT III
-	-		
Ch3	-	600V CAT III	600V CAT III
-	-		
Ch4	-	600V CAT III	600V CAT III
-	-		

The range of use for weak currents is wider than that indicated in the information window, which corresponds to the specified measuring field.

Description of Accessories (cont'd)

Connection Disconnection

A window indicating the safety conditions is displayed when you connect or disconnect a **Probitx** to/from one of the instrument channels:

General characteristics of the last adapter connected

	Input:	Floating:	Between Channel:
Ch1 HX31	600V CAT III	600V CAT III	300V CAT II
Ch2 HX30	1000V CAT II	600V CAT III	300V CAT II
Ch3 HX32	10Vrms MAX	600V CAT III	300V CAT II
Ch4 HX35B	K TC	30V CAT I	-

Input:
Maximum voltage of the signal measured by the **Probitx adapter**

Floating input:
Maximum voltage permitted on each **Probitx** terminal in relation to the earth

Between channels:
Maximum admissible voltage between channels (this voltage depends on the combination of **Probitx** adapters connected)

Description of Accessories (cont'd)

Recommendations for use

Connection of reference conductors for the 1/10 Probix HX0030 probe

Distribution of stray capacitances:

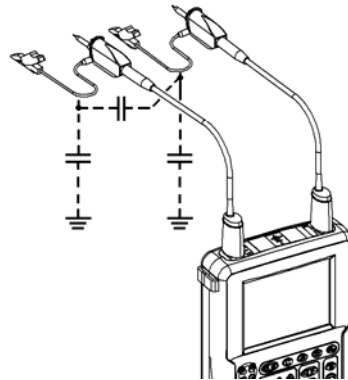

It is essential, given the stray capacitances, to connect properly the reference conductors for each probe. These conductors should preferably be connected to the cold points, to prevent the transmission of noise by the stray capacitance between modes.

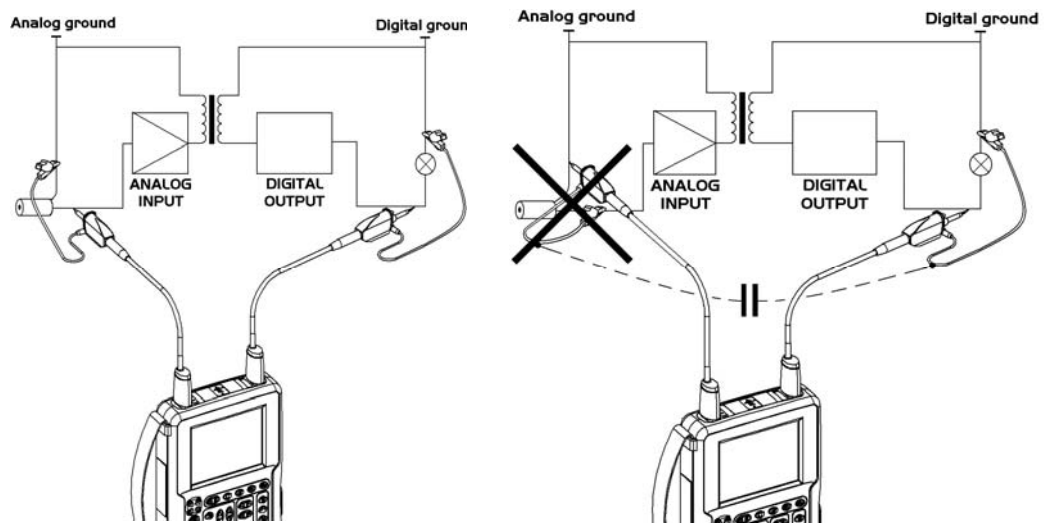

The noise of the digital earth is transmitted to the analog input by the stray capacitance.



To prevent electric shocks or possible fire, never use the "earthing spring" accessory of the 1/10 probe for voltages > 30Vrms in relation to ground.

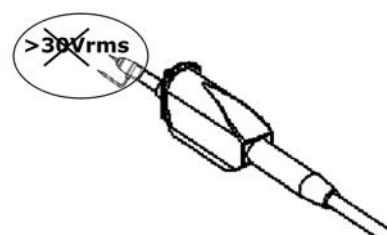

Oscilloscope Mode

The Keys



By pressing this key, you can select the "**oscilloscope**" mode.

5 "UTILITY" keys or key pad



Direct access to LCD **light** adjustment.



When this key is pressed, the display mode switches from normal to "**full screen**" display (and vice versa).

The screen is organized in such a way as to leave an optimum trace plotting surface area, removal of:

the menu bar,
the parameters of the traces of the time base,
the bargraph.

Only the permanent settings and the measurements will remain.



The controls on the front panel remain active.



Triggers a **hardcopy** in accordance with the configuration chosen in the "Util" and "Hardcopy" menus.

A second press before the end of the process will interrupt the current printout.

If printing is impossible, a "Printing error" message will be sent.

The "  " symbol is displayed in front of the settings display zone when printing is in progress.



The first press will **freeze** the traces on the screen. They will be displayed in a lighter colour as a reference to be compared with another acquisition.

A second press will **erase** them: they will then be lost.



- *Traces will be saved only through the "Memory → Trace → Save" menu.*
- *The reference memories will be accompanied by their reference number.*

1 "AUTOSET" key



Automatic optimum adjustment by **Autoset** on the channels where the signal is applied.

This affects parameters: coupling, vertical sensitivity, time base, trigger type and slope and trace positioning.

The lowest frequency signal is used as the trigger source.

If no trace is detected on the inputs, the autoset will be aborted.

Selective "AUTOSET"



When pressed at the same time as a **CHx key** (CH1 to CH4), this defines the corresponding channel as the trigger source. It initiates an autoset which will take this selection into account. Channel CHx then becomes active for adjustment using the keys:



Oscilloscope Mode (cont'd)



4 "Trigger" keys



Sets the trigger **level** to the average value of the signal (50%) without modifying the trigger coupling.

When pressed in combination with a **CHx** key, this activates the same the same function, after first selecting the corresponding channel as the trigger source.



Selects the trigger **slope** (up  or down ) by successive presses. The slope is indicated in the status area.



Successive presses can be used select one of the following **acquisition modes**:

Single shot	(Mono) = SINGLE
Triggered	Trig
Automatic	(Auto) = REFRESH

- **"SINGLE" mode:**

In Single Shot mode, a single acquisition is armed by pressing the RUN HOLD key. After receiving a trigger, the waveform is displayed and the instruments returns to HOLD mode. For any further acquisition, the acquisition must be rearmed by pressing the RUN HOLD key.

If the time base is less than 100 ms/div → SINGLE mode can be accessed via the "Mono (< 100 ms/div)" option.

If not, Single mode can be accessed via the "Roll Mono (> 50ms/div.)" option and ROLL mode is automatically activated.

- **"TRIGGERED" mode:**

The screen's content is only refreshed when there is a trigger event linked to the signals present on the oscilloscope's inputs (CH1, CH2, CH3, CH4).

If there is no trigger event linked to the signals present on the inputs (or if there is no signal on the inputs), the trace is not refreshed.

- **"AUTOMATIC" mode:**

The screen's content is refreshed even if the trigger level is not detected on the signals present on the inputs.

When there is a trigger event, screen refreshing is managed as in the "Triggered" mode.



- allows acquisition to be started and stopped in "TRIGGERED" and "AUTOMATIC" modes.

- rearms the trigger circuit in "SINGLE" mode.

Acquisition is initiated according to the conditions defined by the acquisition mode (**SGLE REFR** key).

The acquisition status is indicated in the status area:

RUN	= started
STOP	= stopped
PRETRIG	= acquisition

Oscilloscope Mode (cont'd)

3 "MEASURE" keys



Displays or hides a window for the 19 automatic measurements on the reference trace.

When pressed in combination with a **CHx** key, it displays the measurements concerning the corresponding channel.



By means of successive presses, this selects one of the displayed traces as the **reference trace** for the automatic and manual measurements.

It appears in the "Measure" menu → Reference.



Activates or deactivates the **cursor** display for manual measurements.

The cursors can be moved directly on the touch-sensitive pad using the stylus.

- The "**dt**" measurements (time difference between the two cursors) and "**dv**" measurements (voltage difference between the 2 cursors) are indicated in the status area.
- The absolute value of the cursor selected is indicated in the "Current Settings" area.

3 "HORIZONTAL" keys or key pads



Adjustment of the **time base coefficient** (T/DIV).



After a Zoom, the "Z-Pos." setting modifies the **position** of the screen in the acquisition memory.



Activates or deactivates the "**Zoom**" function.

By default, the zoom is performed around the samples located in the middle of the screen.

A zone can be zoomed by tracing a rectangle around the area to be enlarged using the stylus on the touch-sensitive pad. The sensitivity, time base and horizontal and vertical alignment values are recalculated automatically.

Oscilloscope Mode (cont'd)

Definition of terms used

- Validated channel:** Display enabled, trace displayed after RUN
- Displayed channel:** Channel validated, trace present on the screen
- Selected channel:** The parameters of this channel can be set with the keys:



5 "VERTICAL" keys or key pads

OX 7204^{III}

Step 1	Step 2	Step 3
Before pressing one of the following keys :	Press	After pressing one of the preceding keys:
The channel concerned is not displayed.		The channel is displayed and selected.
The channel concerned is displayed, but not selected.		The vertical sensitivity and vertical position are assigned to the channel selected.
The channel concerned is displayed and selected.		The channel is selected.
		The channel is cancelled by double-pressing.

OX 7202^{III}

Step 1	Step 2	Step 3
Before pressing one of the following keys :	Press	After pressing one of the preceding keys:
The channel concerned is not displayed.		The channel is displayed and selected.
The channel concerned is displayed, but not selected.		On CH1 and CH4, the vertical sensitivity and the vertical position are assigned to the channel selected.
The channel concerned is displayed and selected.		The channel is selected.
		The channel is cancelled by double-pressing.



A long press on one of the keys **CHx** causes a **vertical autoselect**:

- This modifies the sensitivity and vertical positioning of the channel in question.
- It optimizes the display on the screen by activating and selecting the channel.

The channel is displayed and selected.

Oscilloscope Mode (cont'd)



Activates or deactivates **horizontal splitting** of the display zone.

When activated, the "Full Trace" function is indicated by:

- the presence of a continuous horizontal line in the middle of the display area
- horizontal splitting of the graticule.

After activation of the function:

- traces 1 and 3 are assigned to the upper part of the display,
- traces 2 and 4 are assigned to the lower part in order to prevent overlays.

The traces can then be moved vertically in the two zones.





This function can also be used in "full screen" mode.



Successive presses allow selection of the **input coupling** (AC, DC or GND) for the last channel selected.

The coupling is indicated in the channel parameters area:

AC : 

DC : 

GND : 



Adjustment of the vertical **sensitivity** of the last channel selected:



increases the vertical sensitivity, while



reduces it.



Adjustment of the vertical **position** of the last channel selected:



moves it downwards, while



moves it upwards.

Oscilloscope Mode (cont'd)

Display

Display

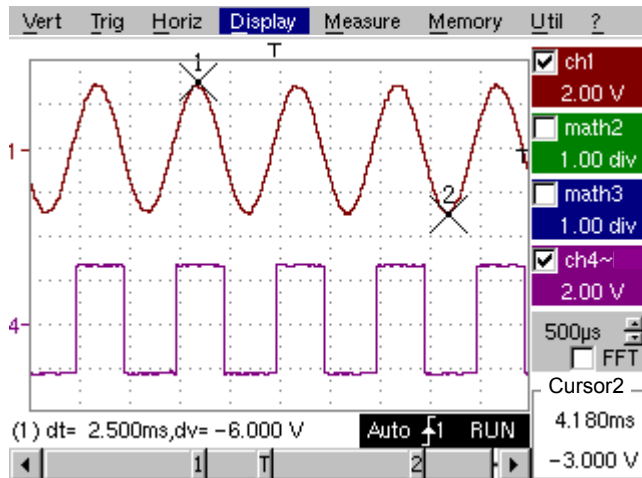

Composition The oscilloscope display is divided into 4 functional zones.

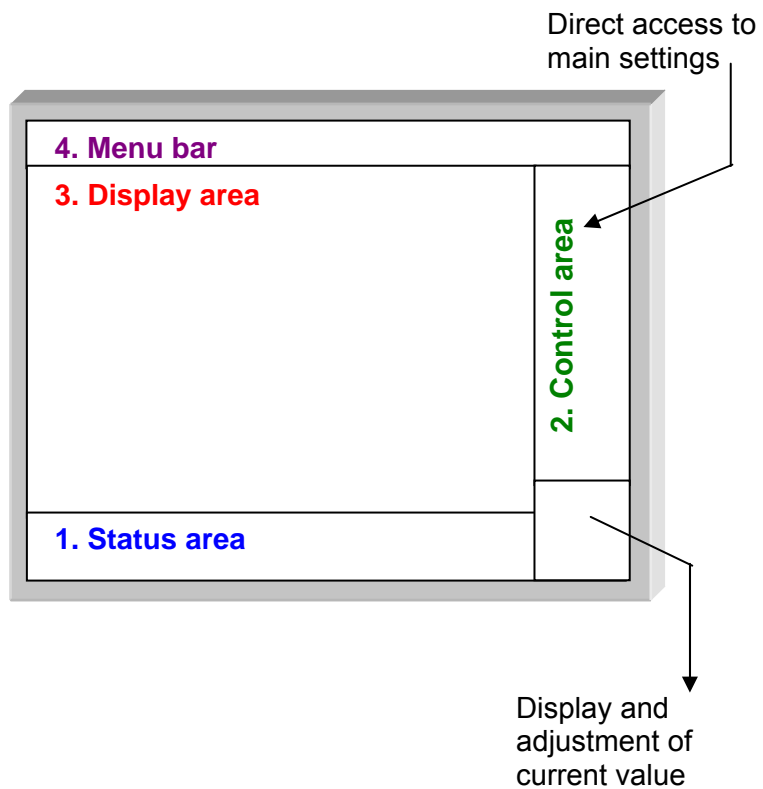

Oscilloscope Mode (cont'd)

1. **Status area** Three types of general information appear in this area:

- The **bargraph** representing the screen position, the trigger and the cursors in the acquisition memory.
- The instrument permanent **settings**.
- The **measurements**, when the cursors are present on the screen.

Bargraph

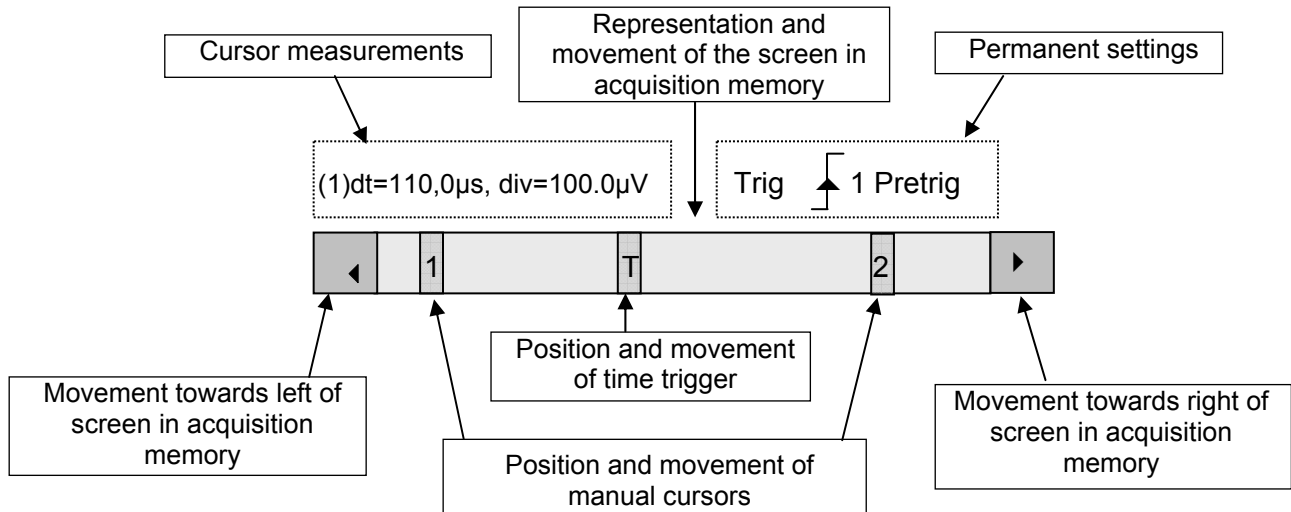

☞ Each element in the bargraph can be moved with the stylus.

Permanent settings

This zone refers to the trigger status (mode, edge, source, current status).

☞ Example: AUTO  1 STOP

☞ When the stylus is placed on this information, the "Trigger Parameters" menu can be opened by pressing twice.

Cursor measurements

This zone refers either to:

- the horizontal (dt) and vertical (dv) differences between 2 cursors in the case of manual measurements

☞ Example: (1) dt = 110.0 µs, div = 100.0 µV

- phase measurement in the case of manual phase measurement (Ph).

☞ Example: (1) Ph = 200.0°

- the automatic measurements selected using the "Automatic Measurements" or "Phase measurement" menus

☞ Example: (2) F = 1.0000 kHz, Vpp = 7500 V

Oscilloscope Mode (cont'd)

- 2. Control area** The parameters displayed in this area are:
- The parameters of each channel and trace: display, sensitivity, coupling, bandwidth limitation, vertical scale, function, Zoom.
 - The time base value, the presence of a Zoom and a change in the signal representation domain (FFT).
 - Active adjustment of the last selected element:
 - trigger level
 - trigger time position
 - channel offset value
 - X & Y position of cursor
 - *Time display, if no measurement has been selected.*
 - *Display of the battery status.*
 - *A mains socket if the instrument is connected to the Wall Plug.*

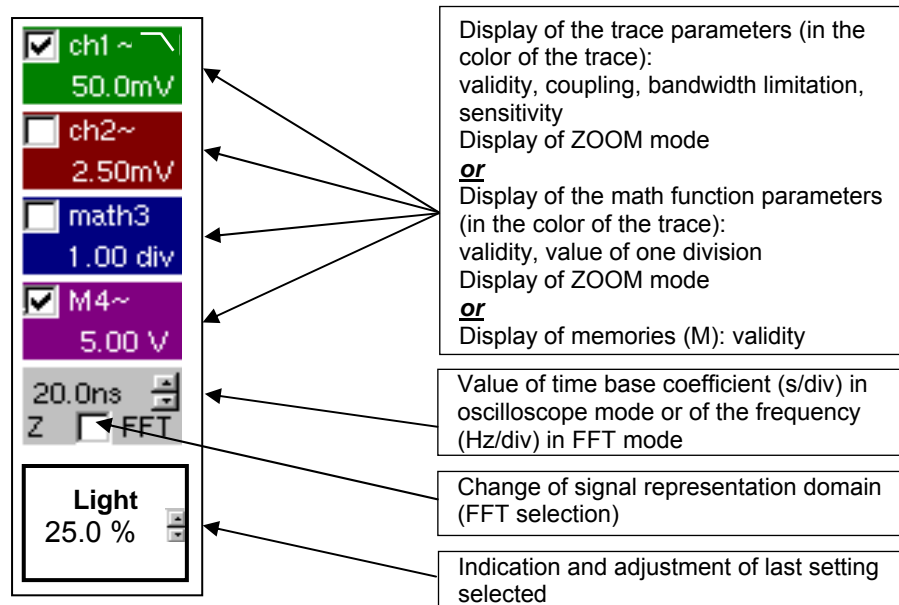

- *The channels and functions can be validated using the stylus or the keys.*
- *The "✓" symbol indicates whether a channel or function is selected, or whether FFT mode is selected.*
- *The settings of the time base (or the frequency) and the value of the active parameter can be modified using the UP/DOWN button next to the display of the current value.*
- *After modification of the time base, the corresponding sampling frequency is indicated in the settings area.*
- *A double press on the parameters or a channel or on the value of the time base directly opens the associated menus:*
 - *Sensitivity/Coupling and Vertical Scale, for the channels*
 - *Vertical scale for the functions*
 - *Source, trigger mode and RUN/STOP, for the time base.*

Oscilloscope Mode (cont'd)



The grouped "Source" and "Trigger Mode" menus can be opened by a double press with the stylus on the time base area.

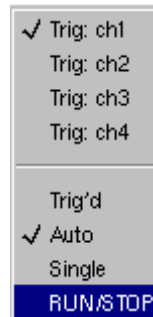

RUN/STOP starts and stops acquisition from this menu. The acquisition status is indicated in the status area on the screen.



The symbol "✓" indicates the source and trigger mode selected.

3. Display area

The graphic elements displayed associated with the traces in this area are:

- a trigger time position indicator
- a trigger level indicator
- a trace number identifier
- a vertical position indicator for the reference level of each trace
- cursor position indicators linked to the trace for the automatic automatic measurements
- position indicators regarding the cursors linked or not to the trace for manual measurements
- selection of a zoom zone

Oscilloscope Mode (cont'd)

Display elements

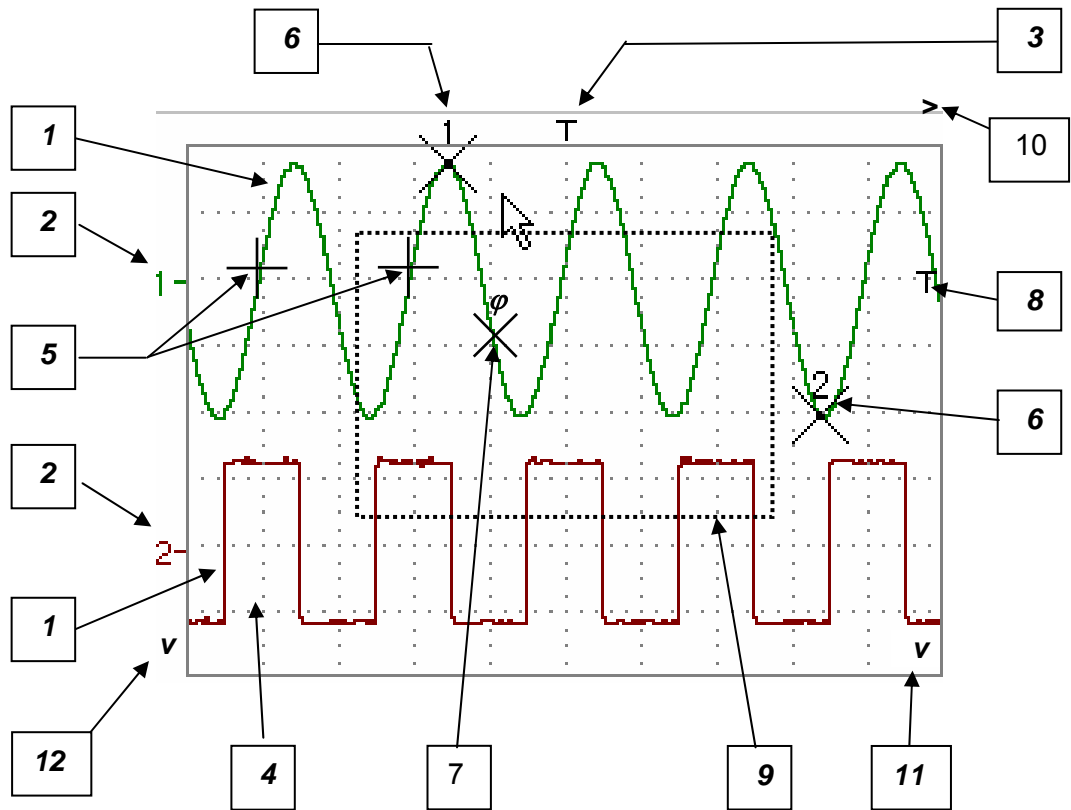

Definition of display

Refs.	Elements selectable using the touch-sensitive pad
1	Trace displayed
2	Vertical position indicator of the reference level of the trace displayed and identification of the trace number
3	Indication of Trigger time position
4	Division of graticule
5	Position indicator of the cursors for the first automatic measurement
6	Manual measurement cursor position indicator
7	Phase measurement cursor position indicator
8	Trigger level and coupling on the trigger position indicator
9	Selection of a zoom zone
10	Indicator of trigger time position overshoot outside the display window
11	Indicator of trigger level position overshoot outside the display window.
12	Indicator of channel level overshoot outside the display window.

Oscilloscope Mode (cont'd)

*Menu accessible
from display area*

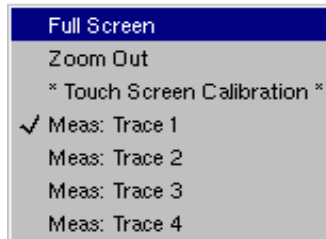

By double tapping with the stylus in the display area, the menu concerning the display can be opened directly.

The "Full Screen" and "Zoom Out" options are directly accessible (see §. Display Menu). The same applies to the selection of the automatic and manual measurement reference signal (see §. Measure Menu).

It is possible to use the stylus to **zoom** in the display area by pulling a rectangle.

After zooming in on part of the screen, the sensitivities of the traces and the time base are recalculated.

- The symbol "**Z**" appears in the signal and time base parameters display.
- The zoomed section is represented in the bargraph.
- The "Zoom Out" menu (see §. Display Menu) or the Zoom key can be used to return to the original display.
- The value of the horizontal zoom is adjusted to assign a calibrated value to the horizontal scale (zoom factor: x 5 max.)
- If the vertical selection of the zoom is greater than 6 divisions, no vertical zoom is performed (zoom factor: x 16 max.).

All the symbols present in the display area:

- trigger indicators,
- trace position indicator,
- manual cursor position indicator,
- etc.

can be moved using the stylus.



The new modified symbol value is indicated in the current settings display area.

Calibration of the touch-screen

To optimize selection of the different elements present in the display area using the stylus, calibration of the touch-sensitive screen may prove necessary.

Select the "Touch Screen Calibration" option proposed in the display area menu or in the Util menu.

By double tapping on the curves zone, you can also access touch-screen calibration.

Oscilloscope Mode (cont'd)

Calibration of the touch-sensitive screen (cont'd)

Follow the instructions on the screen.

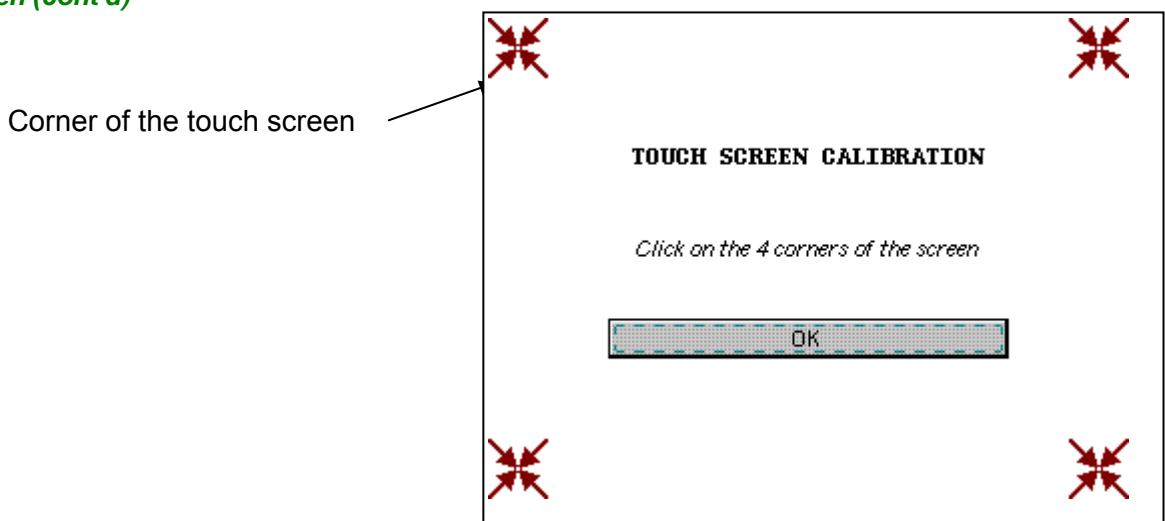

Use the stylus to point at the centre of the 4 patterns displayed on the screen.

Validation of the input is indicated by modification of the pattern.



The pointing order is not important.

Once the 4 inputs have been recorded, validate the calibration with **OK**.

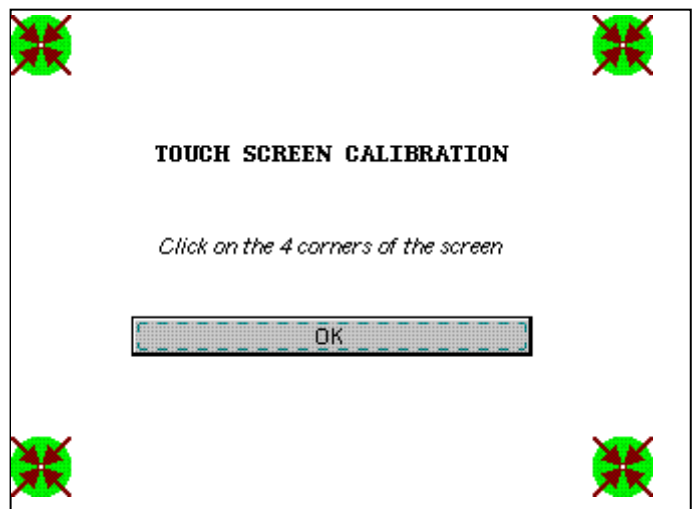

The touch-sensitive screen is calibrated and the display returns to normal mode.

4. Menu bar



All the oscilloscope functions can be accessed via the main menus.

Oscilloscope Mode (cont'd)

The "Vert" Menu

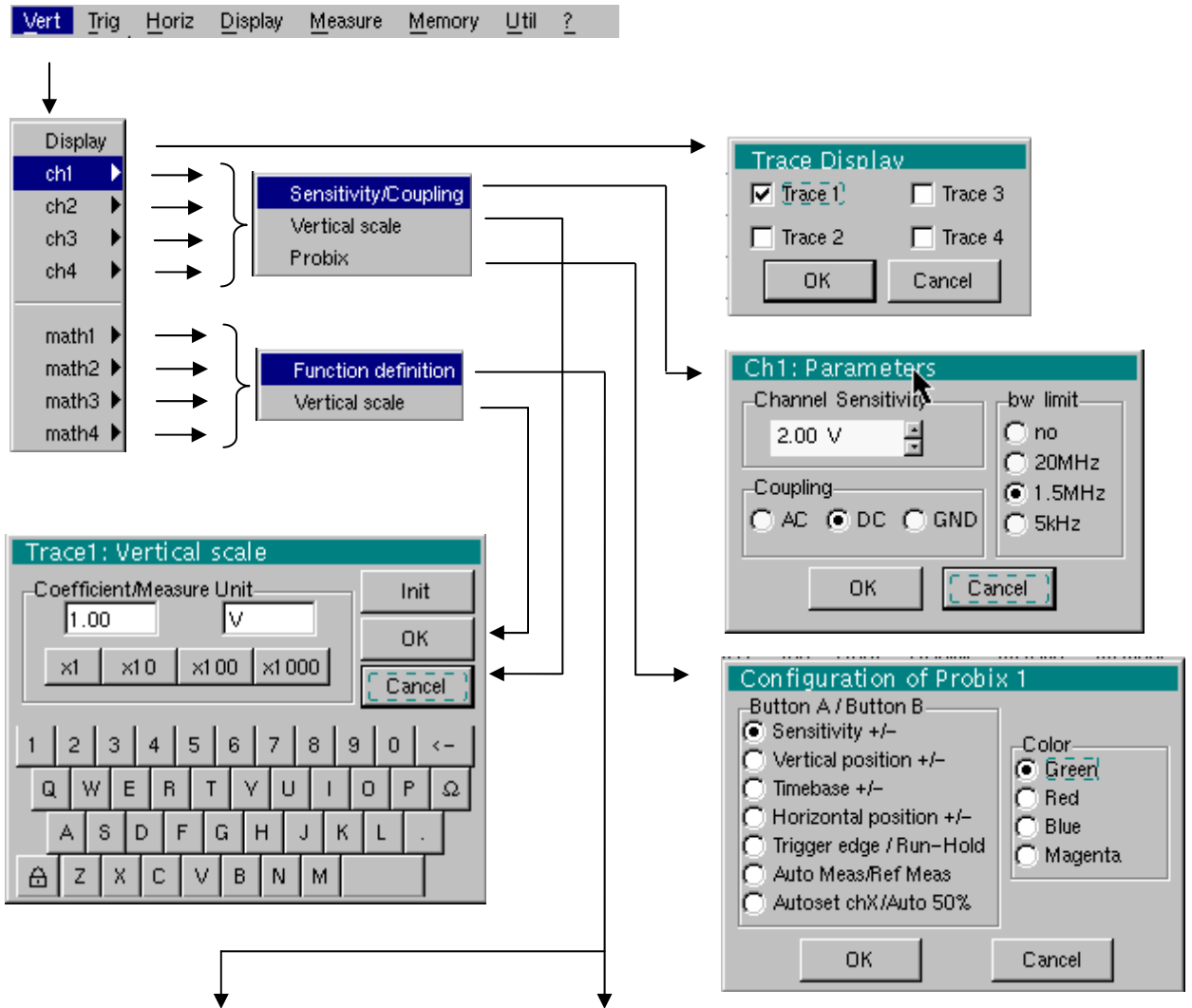

≠ Advanced mode

Advanced mode

Math2: definition

-ch1 ch4 - ch1
 -ch4 ch1 * ch4
 ch1 + ch4 ch1 / ch4
 ch1 - ch4 ch4 / ch1

amplitude

/5 /2 x1 x2 x5

OK Cancel RESET

Math1: definition

$(\sin(\pi^*t/\text{divh}(2))+\sin(3^*\pi^*t/\text{divh}(2)))/3+\sin(5^*\pi^*t/\text{divh}(2))/5+\sin(7^*\pi^*t/\text{divh}(2))/7)^* \text{divv}(4)$

Files

C1MULC2.FCT
SQUARE.FCT

Functions

divh(

OK Cancel Save RESET

divh(
 divv(
 step(
 sin(
 cos(
 exp(
 log(
 sqrt(
)

Oscilloscope Mode (cont'd)

Display

Opens the "Trace display" menu for validating or devalidating the traces.

Validation of the selections by "**OK**". Exit from the menu without modification by "**Cancel**".

The "✓" symbol in front of a trace indicates that it has been validated.



The traces can be validated or devalidated from the control area by using the stylus.

ch1 ch2 ch3 ch4

Modify the parameters of channels ch1, ch2, ch3 and ch4 independently, as well as the vertical scale of the trace selected.

Sensitivity / Coupling

Modifies the parameters of the selected channel.

Channel Sensitivity

Modification of the channel's sensitivity using the stylus on the scrollbar, adjustable by sequence: from 2.5 mV to 200 V/div.



The sensitivity is indicated in the channel parameter display area. It takes into consideration the parameters of the "Vertical scale" menu.

Coupling

Modification of **AC - DC - GND** coupling

AC: blocks the DC component of the input signal and attenuates the signals below 10 Hz

DC: transmits AC and DC components of the input signal

GND: internally, the instrument links the input of the channel selected to a 0 V reference level.



The "⊙" symbol indicates the coupling selected. Coupling is indicated in the modified channel's parameter display area.

bw limit

Limits the bandwidth of the channel and its trigger circuit to reduce display noise and false triggering.



The bandwidth of each channel can be limited to 5 kHz, 1.5 MHz or 20 MHz. The bandwidth limit of a channel is indicated in the control area by following symbols :

 20 MHz

 1.5 MHz

 5 kHz



This menu can also be called up by double-tapping with the stylus on the required channel parameter display area.

Vertical scale

Defines the vertical scale of the channel selected on the basis of the current settings. Readings of the direct measurements of the value analyzed and its unit are provided.

Coefficient

Assignment of a multiplication coefficient to the selected channel's sensitivity.

This can be modified with the stylus, using the table of usable numbers, after selecting the "Coefficient" zone.

The  key deletes the character preceding the cursor in this area.

The predefined values (x1, x10, x100, x1000) correspond to standard probe coefficients and can be assigned directly.



The sensitivity value indicated in the channel parameter display will be modified according to this coefficient.

Oscilloscope Mode (cont'd)

Measurement unit

Modification of the selected channel's vertical scale unit.

The modification is performed by means of the stylus, using the table of usable characters after selecting the "measure unit" zone.

The  key deletes the character preceding the cursor in this area.



The vertical scale unit will be indicated in the modified channel's parameter display.

Init

Reinitializes the multiplication coefficient to 1.00 and returns to the V measurement unit.

Validation of the selections by "OK". Exit from the menu without modification by "Cancel".



This menu can also be called up by double-pressing with the stylus on the required channel's parameter display area (CH1, CH2, CH3 or CH4).

Probix

When selected, this opens the "Probe Configuration" menu.

When a **Probix** HX0030 (or HX0034) probe is connected to one of the oscilloscope's inputs, this menu becomes active.



LED button

Can be used to switch the LED on or off.

Buttons A and B

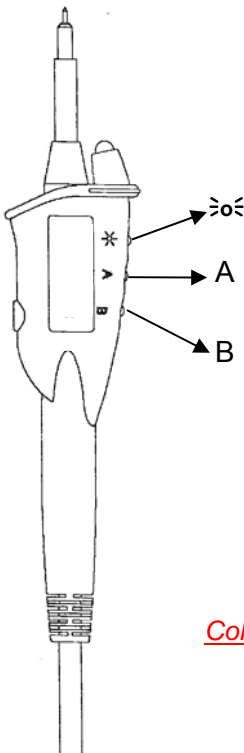
Can be assigned to different settings (see table below).



	Button A	Button B
Sensitivity	Higher sensitivity	Lower sensitivity
Vertical/horizontal alignment	Alignment on higher division	Alignment on lower division
Time base	Higher time base	Lower time base
Trig. edge / Run-Hold	 	RUN HOLD
Auto Meas. Ref. Meas.	AUTO MEAS. CHx	REF MEAS.
Autoset CHx / Auto 50 %	Auto CHx	AUTO 50 % CHx

- See the chapter on "The Keys" for further details on the function provided.
- The modified parameters are updated in the control area.
- The "⊙" symbol indicates the parameters elected and assigned to the probe.

Color

modifies the color that you want to assign to the trace.

- The "⊙" symbol indicates the color selected.
- These parameters will be memorized in the probe, even after disconnection of the oscilloscope.



When using Probix adapters, the choice of the color remains possible.

Oscilloscope Mode (cont'd)

math1 math2
math3 math4

For each trace, definition of a mathematical function and the vertical scale.

If "Advanced" mode is not activated, simple functions (Inversion, Addition, Subtraction, Multiplication and Division of curves) can be selected and linked to the curves 1 or 2.

Function definition

In "Advanced" mode, mathematical functions can be defined literally. The mathematical function can be defined on 2 lines.



- The mathematical function can be defined on 2 lines.
- *mathx* cannot be used in the definition of a function.

The key deletes the character preceding the cursor in the window.

Functions

8 predefined mathematical functions can be linked to the traces:

divh(("horizontal division")
divv(("vertical division")
step(("step") using "t" (*)
sin(("sine")
cos(("cosine")
exp(("exponential")
log(("logarithmic")
sqrt(("square root")

(*) t = abscissa of the sample in the acquisition memory.



divh(1) is equivalent to 250 samples (counts) = 1 horizontal division (or 5000 samples if the EXTENDED ACQUISITION MEMORY option is installed).

Validation of the selections by "OK". Exit from the menu without modification by "Cancel".

If ...	then ...
... the dynamic calculation of the vertical scale is impossible	... a message indicates that the measuring unit on this function will be vertical division (div).
... the dynamic calculation of the vertical scale is possible	... it takes into account of the sensitivities of the channel sources.



Particular cases: Value of the measuring unit

CHx + CHy Sensitivity and measuring unit used on CHx

CHx - CHy Sensitivity and measuring unit used on CHx

In each cases, the measuring unit can be re-defined and a coefficient can be applied to the measurement results (refer to §. Vertical scale).

Oscilloscope Mode (cont'd)

Examples

Use of predefined mathematical functions

- Predefined divv() function used on its own: $\text{math3} = \text{divv}(3)$.

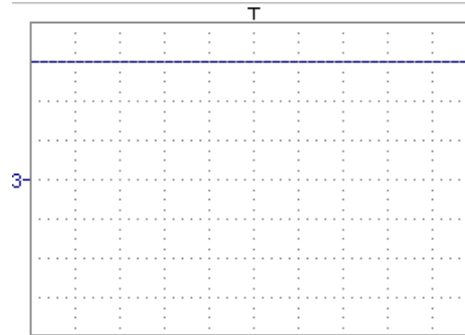

The trace is equal to 3 vertical divisions.

- Predefined step() function associated with a trace:

- $\text{math2} = \text{ch1} * \text{step}(t - \text{divh}(4))$

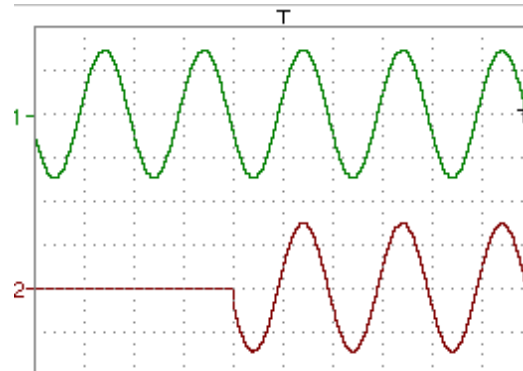

The result of math2 is 0 vertical divisions as long as t is less than four horizontal divisions ($t - \text{divh}(4) < 0$).

The result of math2 is equal to ch1 when t becomes greater than four horizontal divisions ($t - \text{divh}(4) > 0$).

- $\text{math2} = \text{ch1} * \text{step}(\text{divh}(4) - t)$

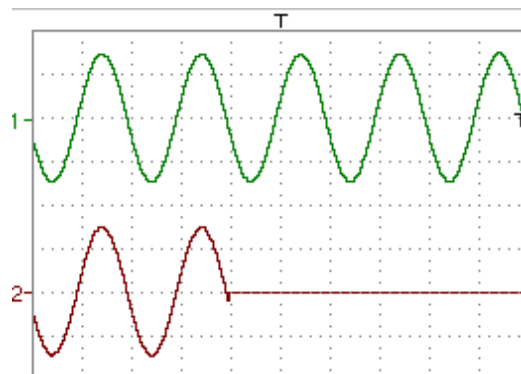

The result of math2 is equal to ch1 as long as t is less than four horizontal divisions ($t - \text{divh}(4) > 0$).

the result of math2 is at 0 vertical divisions when t becomes greater than four horizontal divisions ($t - \text{divh}(4) < 0$).

Oscilloscope Mode (cont'd)

Example 1
Addition of two traces

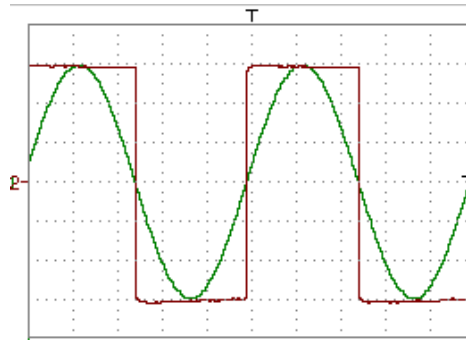

Vhigh

Vpp(ch1) = Vpp(ch2) = 6 V
 Sensitivity (ch1) = 1 V/div
 Sensitivity (ch2) = 1 V/div

Traces ch1 and ch2 are optimized on 6 vertical divisions.

Vamp ch1 = 6 vertical divisions
 Vamp ch2 = 6 vertical divisions

- math3 = ch1+ch2

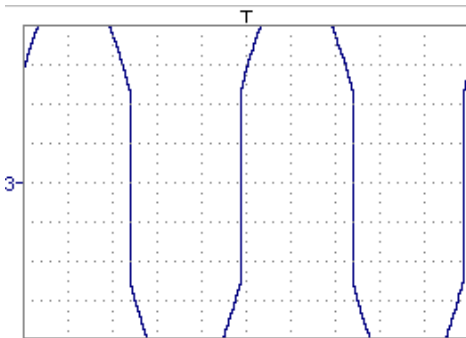

Vertical scale math3 = 2.00 div
 Vpp math3 = 12.00 div
 Vhigh math3 = 6.00 div

There is a high and low overshoot, so division by 2 is necessary to optimize display of the result.

- math3 = (ch1+ch2) / 2

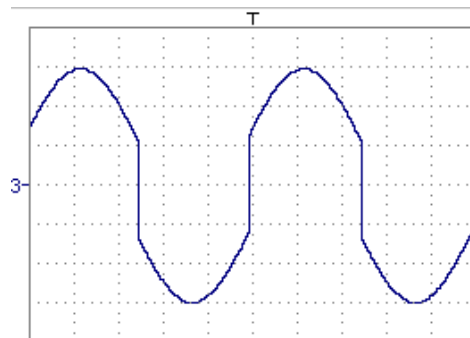

Vertical scale math3 = 2.00 div
 Vpp math3 = 12.00 div
 Vhigh math3 = 6.00 div

Division by two adjusts the addition to the dynamics of the screen.

Vamp math3 = 6 vertical divisions

The measuring unit and the sensitivity of ch1 are used during the display of measurements.

You can then open the menu "Vertical Scale" of math3 (see §. Opening from math3, math4) to assign a coefficient to the result and to modify the measuring unit.

Oscilloscope Mode (cont'd)

Example 2 Multiplication of two traces

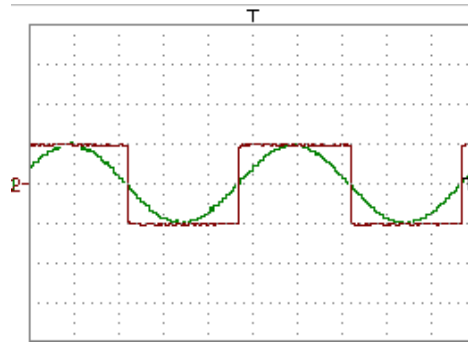

Sensitivity(ch1) = 5 V/div
Sensitivity(ch2) = 5 V/div
Vamp(ch1) = Vamp(ch2) = 10 V

Vamp ch1 = 2 vertical divisions
Vamp ch2 = 2 vertical divisions

- math3 = ch1*ch2

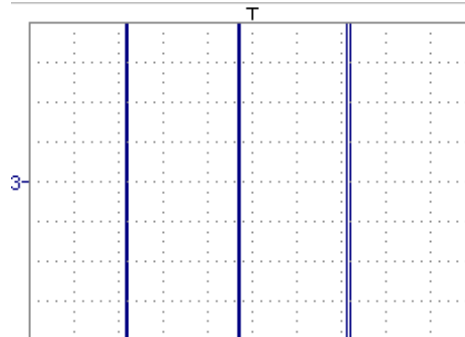

As for the addition of traces, there is an even more significant high and low overshoot.

The overshoot is due to the increased dynamics of the numbers after a multiplication; to avoid this and standardize the result, use the divv () function.

Example: If Amplitude on CH1 = 2 divv and Amplitude on CH2 = 2 divv, the following function is used to get an amplitude of 1 divv :

math3 = (ch1 * ch2) / divv (1)

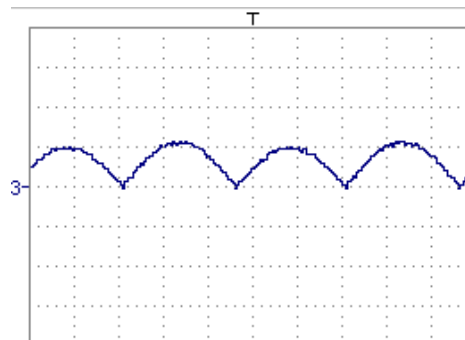

The result of the multiplication is translated into divisions on the screen.

- ☞ - If Vamp ch1 = 8 div and Vamp ch2 = 8 div, the result must be divided by divv(4) to obtain Vamp math3 = 4 div.
- When mathematical functions associated with traces are used, the dynamics of the result obtained must be verified.

Correction of the result of the operations by mathematical functions (divv(), divh(), / ...) is recommended to optimize the screen display.

Oscilloscope Mode (cont'd)

You can then open the menu "Vertical Scale" of math3 (see §. Opening from math3, math4) to assign a coefficient to the result and to modify the measuring unit.

In our example:

- Then select math3 as the reference for the automatic and manual measurements (see §. "MEASURE" Menu).
- Then display the table of 19 measurements made on the math3 trace math3 (see §. "MEASURE" Menu).

The measurements displayed are the exact result of the multiplication of the two traces ch1 and ch2 in the unit (V).

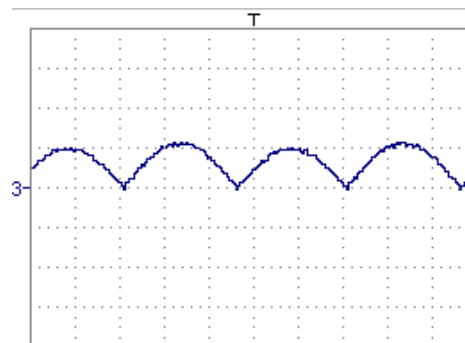

Sensitivity(math3) = 25 VV
Vpp (math3) = 25 VV

Oscilloscope Mode (cont'd)

Example 3

Association of predefined functions

- math3 = divv(3)*sin (2*pi*t/500) (*)

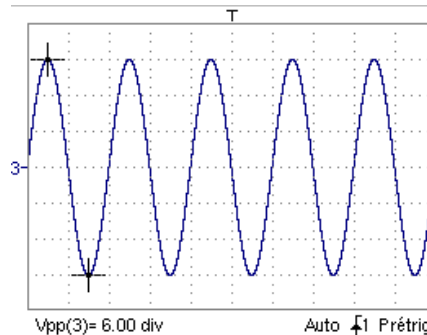

The trace obtained is a sine-curve produced using the predefined function "sin()".

The amplitude is 6 divisions.

The period equal to 500 samples (**) (2 horizontal divisions) depends on the time base.

- Same trace produced with the predefined divh() function:

math3 = divv(3)*sin(2*pi*t/divh(2))

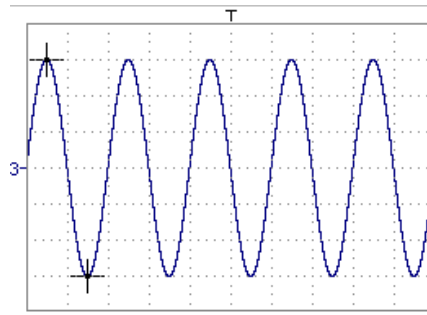

In this example, divh(2) is equivalent to 500 samples (**).

The period divh(2), equal to 500 samples (**) (2 horizontal divisions), depends on the time base.

- Production of a sine wave by the predefined cos() function:

math3 = divv(3)*cos(2*pi*t/divh(2))

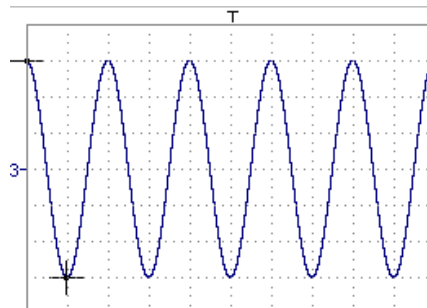

The trace obtained with the predefined cos() function is offset by 90°.

(*) math3 = div(3) **sin** (2pi*t / 10,000) if EXTENDED ACQUISITION MEMORY option is installed.

(**) 10,000 samples with EXTENDED ACQUISITION MEMORY option

Oscilloscope Mode (cont'd)

Production of an attenuated sine wave using predefined functions

$$\text{math1} = \sin(\pi * t / \text{divh}(1)) * \exp(-t / \text{divh}(6)) * \text{divv}(4)$$

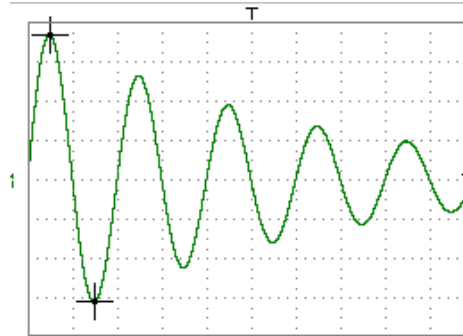

"sin (pi*t/divh(1))" can be used to modify the number of periods.
"exp (-t/divh(6))" can be used to modify the level of attenuation.

Oscilloscope Mode (cont'd)

Function definition (cont'd)

Files

Contains the list of the functions (.FCT) saved by the user, along with two predefined files.

By selecting the name of the function with the stylus (function name in blue), you can transfer the definition of the function into the 2 lines provided for that purpose.

The scroll bar can be used to scroll through the list of memorized functions.

The function can be modified with the table of usable characters, associating the ch1 and ch2 traces.

This menu also contains two predefined functions.

C1MULC2.FCT and SQUARE.FCT

C1MULC2 .FCT Product of 2 traces with scaling:

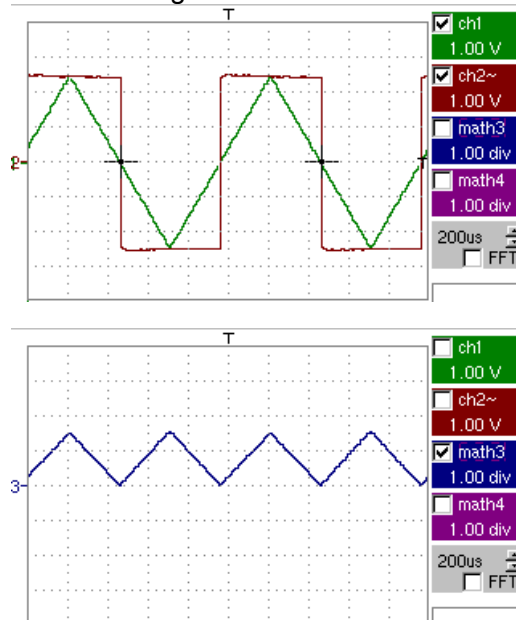

$$\text{math3} = \text{ch1} * \text{ch2} / \text{divv}(4) = \text{C1MULC2.FCT}$$



The factor $\text{divv}(4)$ is used to optimize the display as long as the source signals have sufficient dynamics (> 6 divisions) and no overshooting.

SQUARE .FCT

Definition of a square signal using the first 4 harmonics of a Fourier series development.

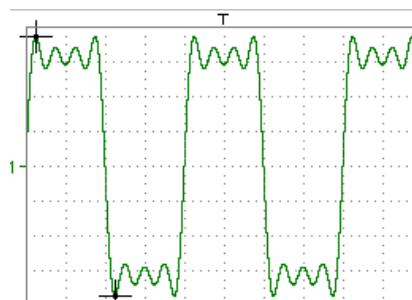

$$\text{math3} = \text{SQUARE.FCT}$$

$$\text{math3} = (\sin(\pi * t / \text{divh}(2)) + \sin(3 * \pi * t / \text{divh}(2)) / 3 + \sin(5 * \pi * t / \text{divh}(2)) / 5 + \sin(7 * \pi * t / \text{divh}(2)) / 7) * \text{divv}(4)$$

Oscilloscope Mode (cont'd)

Save Saves the definition of the function using the "File Copy" menu (see §. Memory Menu). The file is assigned the suffix .FCT and appears in the list of saved files.

Reset Completely resets the function definition.



After assigning a function to the ch1 (math1), ch2 (math2), ch3 (math3) or ch4 (math4) channels, "mathx" appears in the corresponding channel's parameter display area.

Vertical scale



Definition of the vertical scale for the selected trace

Calling this menu from math1 to math4 is identical to calling ch1 to ch4 as long as the functions have not been defined.

Opening of the menu from:

math1 math2
math3 math4

Coefficient

Modifies the value of a division (div) in the selected trace.

This can be modified with the stylus, using the table of usable numbers, after selecting the "Coefficient" zone.

The  key deletes the character preceding the cursor in this area.

The predefined values (x1, x10, x100, x1000) correspond to standard probe coefficients and can be assigned directly.



The value of a division will be entered into the display of the modified trace parameters.

Measurement unit

Modification of the unit of the vertical scale (div) for the selected trace.

This can be modified with the stylus, using the table of usable numbers, after selecting the measurement unit zone.

The  key deletes the character preceding the cursor in this area.

The "🔑" key can be used to switch between upper case and lower-case characters.



The vertical scale unit will be entered into the modified trace's parameter display (3 characters max).

Init

Reinitialization of the multiplication coefficient to 1.000 and return to the V measurement unit.

Validation of the selections by "OK". Exit from the menu without modification by "Cancel".



The "Vertical scale" menu can also be called up by double pressing with the stylus in the parameter display of the required trace (math1 to math4).

Oscilloscope Mode (cont'd)

The "Trig" Menu

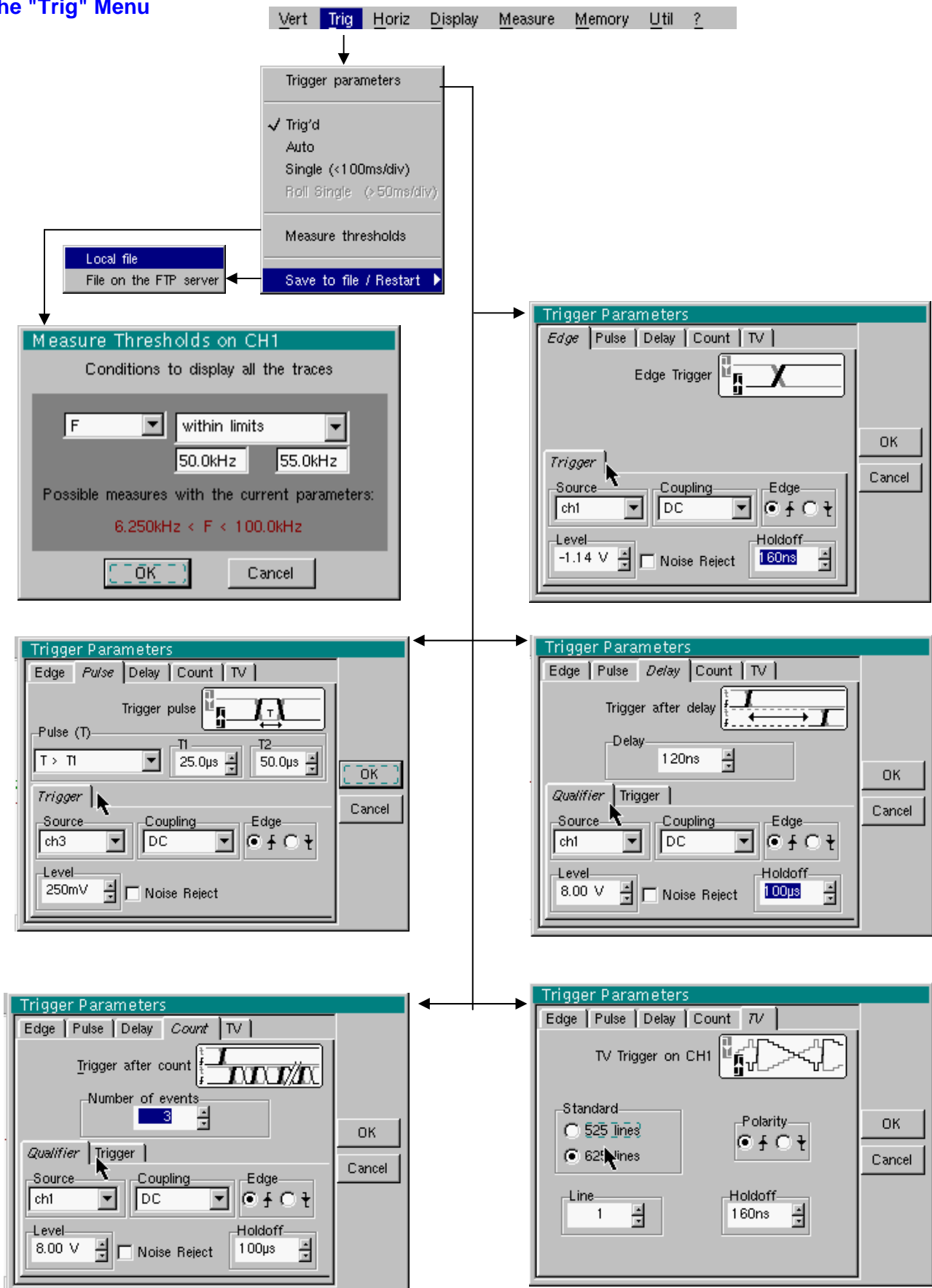

Oscilloscope Mode (cont'd)

Definition

This range of portable oscilloscopes is equipped with "advanced triggers".

- The "**Delay**" and "**Count**" trigger modes require parameterization of a second "auxiliary" trigger source. The auxiliary source may be the same as the main source.

The trigger choice is validated by exiting from the menu.

If ...	then ...
... the user exits from the " Main " tab,	... " Main " triggering is used.
... the user exits from the " Pulse " tab,	... " Pulse " triggering is used.
etc.	etc.



- *There is only one Holdoff, although it can be programmed from the "Main", "Delay", "Count" or "TV" tabs. When you use "Delay" or "Count", the Holdoff applies to the auxiliary source, i.e. the source of the count pulses or delay trigger pulses. In the other cases, Holdoff applies to the main trigger source.*
- *Each trigger source has its own specific attributes: Coupling, Level, Edge, Noise Reject, Filter.*

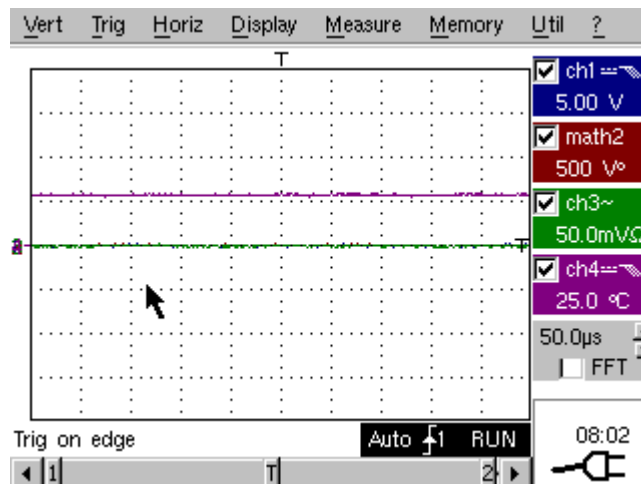

You can also choose the trigger channel by double-tapping with the stylus in the time base display area.

You can also choose the trigger parameters by double-tapping with the stylus in the display area of the trigger parameters.

Oscilloscope Mode (cont'd)

Parameters

Selection of the "Trigger Parameters".

Main Trigger on edge

Source selects a channel as a trigger source.

Coupling Selection of the **filter** for the main trigger source:

AC AC coupling (10 Hz to 200 MHz):
blocks the DC component of the signal

DC DC coupling (0 to 200 MHz):
allows the entire signal through

LF Reject Rejection of source signal frequencies < 10 kHz:
facilitates observation of signals with a DC
component or an unwanted low frequency

HF Reject Rejection of source signal frequencies > 10 kHz:
facilitates observation of signals with high-frequency
noise.

The symbol used to indicate the curve trigger level on the curve also indicates the coupling:

	DC
	AC
	LF Reject
	HF Reject

Edge Selection of the trigger gradient:

+ ascending trigger edge 

- descending trigger edge 

The selected trigger edge is indicated in the status area.

Level 2.04V Adjustment of the trigger level with the stylus on the scroll bar.



The trigger level is entered into the current value display area after modification. Fine adjustment is possible.

Noise reject **No:** hysteresis \approx 0.5 div.

Yes: introduces a hysteresis of \approx 1.5 div.

Holdoff 108 μ s allows:

- disabling of the trigger for a predefined period
- stabilization of the trigger on pulse trains.

Double-tapping in this field displays a virtual numeric keypad which can be used to directly input the value.

Oscilloscope Mode (cont'd)

 **Example** Signal injected on CH1: a train of three 6 VDC pulses at a frequency of 20 kHz with a 500 mVDC component, separated by 500 μ s.

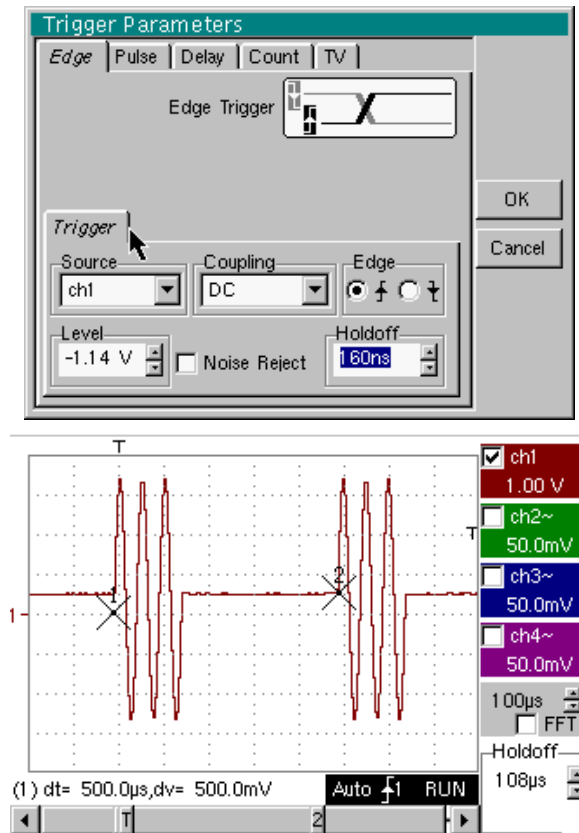

The trigger is regulated with channel 1 as a source, level at 2.04 V, on a rising edge.

The Holdoff stabilizes the signal by inhibiting the trigger during 108 μ s.

The DC coupling of the trigger lets the whole signal through.

In this example, the signal is not being disturbed and the option of noise reject is not necessary.

The DC coupling of ch1 reveals the continuous component of the signal.

Oscilloscope Mode (cont'd)



Pulse







Trigger selection on pulse width.

In all cases the effective triggering occurs on the end of pulse edge.

- $t > T1$ triggers if pulse duration is greater than specified value $T1$
- $t < T2$ triggers if pulse duration is less than specified value $T1$
- $t > T1$ and $t < T2$ triggers if pulse duration is within interval specified by values $T1$ and $T2$
- $t < T1$ or $t > T2$ triggers if pulse duration is outside interval specified by values $T1$ and $T2$



The choice of the  or  edge in the "Main" tab defines the limits of the analysis:

- edge  defines a pulse between  and 
- edge  defines a pulse between  and 

Example

Signal injected on CH1: 1 pulse of 50 μ s (repetitive or not)

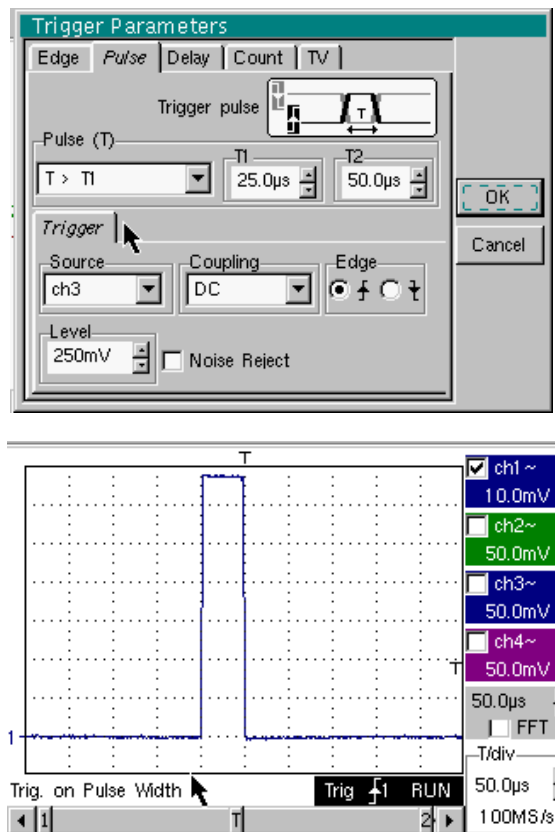

The oscilloscope triggers when it sees a pulse whose duration is greater than specified value (25.0 μ s + tolerance). The trigger occurs on the trailing edge of the pulse.

The trigger occurs on the ascending edge of the pulse, but is effective on the trailing edge.

Oscilloscope Mode (cont'd)

Delay Selection of edge trigger with delay.
The delay is triggered by the auxiliary source.
Effective triggering occurs after the end of the delay on the next event from the main source.

Trigger delay Adjustment with the stylus using the setting scroll bar to choose the required delay value.

Double-tapping in this field displays a virtual numeric keypad which can be used to directly input the value.

Holdoff Adjustment with the stylus using the setting scroll bar, allows disabling of the trigger for a predefined period and, among other things, stabilization of the trigger on pulse trains.

Double-tapping in this field displays a virtual numeric keypad which can be used to directly input the value.

Qualifier selects the settings on the qualifier source.

Trigger selects the settings on the trigger source.

Coupling selects the filter for the auxiliary trigger source:

AC AC coupling (10 Hz to 200 MHz):
blocks the DC component of the signal

DC DC coupling (0 to 200 MHz):
allows the entire signal through

LF Reject Rejection of source signal frequencies < 10 kHz:
facilitates observation of signals with a DC component or an unwanted low frequency

HF Reject Rejection of source signal frequencies > 10 kHz:
facilitates observation of signals with high-frequency noise

Level Adjustment of the trigger level with the stylus on the scroll bar.

Edge selects the edge for the auxiliary trigger source:

+ rising trigger edge 

- falling trigger edge 

Noise reject **No:** hysteresis \approx 0.5 div.

Yes: introduces a hysteresis of \approx 1.5 div.

Oscilloscope Mode (cont'd)

 **Example** Signal injected on CH1: a train of three 6 VDC pulses at a frequency of 20 kHz separated by 500 μ s.

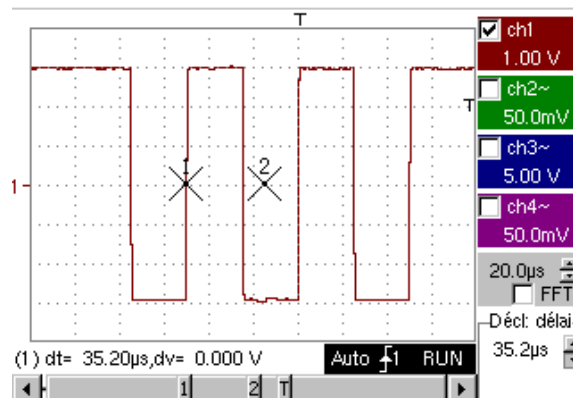
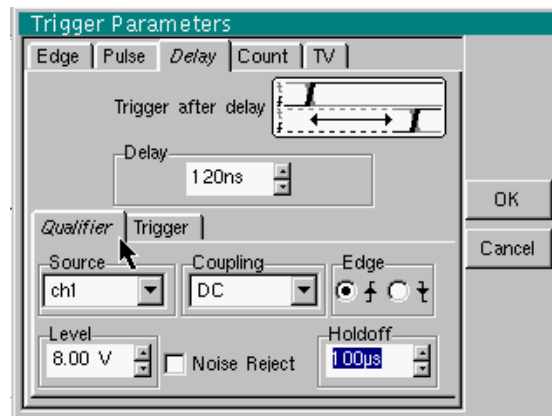

 The trigger is active after the end of the delay (35.2 μ s) on the first ascending edge.

The Holdoff stabilizes the signal by disabling the trigger for 108 μ s.

Oscilloscope Mode (cont'd)

Count Selects the edge trigger with counting of events.
The count is triggered by the auxiliary source. The main source serves as a clock for the count.
Effective triggering occurs after the end of the count on the next event from the main source.

Trigger delay Adjustment with the stylus using the setting scroll bar to choose the number of events required.

Double-tapping in this field displays a virtual numeric keypad which can be used to directly input the value.

Holdoff Adjustment with the stylus using the setting scroll bar, disabling of the trigger for a predefined period and, among other things, stabilization of the trigger on pulse trains.

Double-tapping in this field displays a virtual numeric keypad which can be used to directly input the value.

Qualifier selects the settings on the qualifier source.

Trigger selects the settings on the trigger source.

Coupling Selection of the filter for the auxiliary trigger source:

AC AC coupling (10 Hz to 200 MHz):
blocks the DC component of the signal

DC DC coupling (0 to 200 MHz):
allows the entire signal through

LF Reject Reject of source signal frequencies < 10 kHz
facilitates observation of signals with a DC component

HF Reject Rejection of source signal frequencies > 10 kHz:
facilitates observation of signals with high-frequency noise

Edge Selection of the trigger slope :

+ trigger on rising edge 

- trigger on falling edge 

The selected trigger slope is indicated the status area.

Level Adjustment of the trigger level with the stylus on the scroll bar.

- Noise reject**
- **No:** hysteresis \approx 0.5 div.
 - **Yes:** introduces a hysteresis of \approx 1.5 div.

Oscilloscope Mode (cont'd)

 *Example* Signal injected on CH1: a train of five 6 VDC pulses at a frequency of 20 kHz separated by 500 μ s.

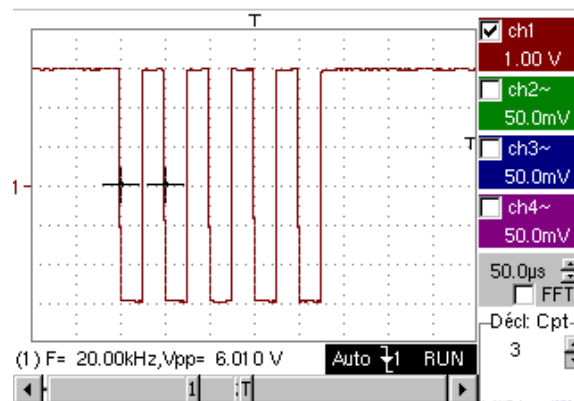
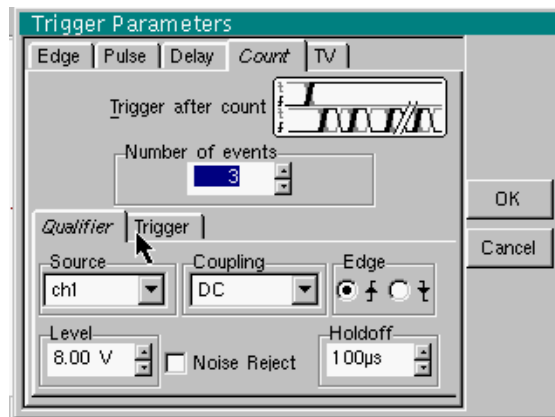

-  *The trigger is set on the descending edge.*
- The first edge activates the trigger. It is not included in the count.*
- The trigger is triggered on the third descending edge of the pulse train.*
- The Holdoff stabilizes the signal by disabling the trigger for 232 μ s.*

Oscilloscope Mode (cont'd)

TV Trigger on a TV signal
 See Chapter VI - Applications: §. Video signal display.
 This menu is only applicable to the CH1 input.

Standard Trigger on a specific line number. The trigger starts on the front edge of the line synchronization signal.

- 625 lines (SECAM) or
- 525 lines (PAL)

Polarity + Direct video
 - Reverse video

Holdoff Adjusted by scrolling with the stylus. Triggering impossible for a pre-defined time.

Double-tapping in this field displays a virtual numeric keypad which can be used to directly input the value.

Line 25 Adjustment of the no. with the stylus using the scroll bar.

Double-tapping in this field displays a virtual numeric keypad which can be used to directly input the value.

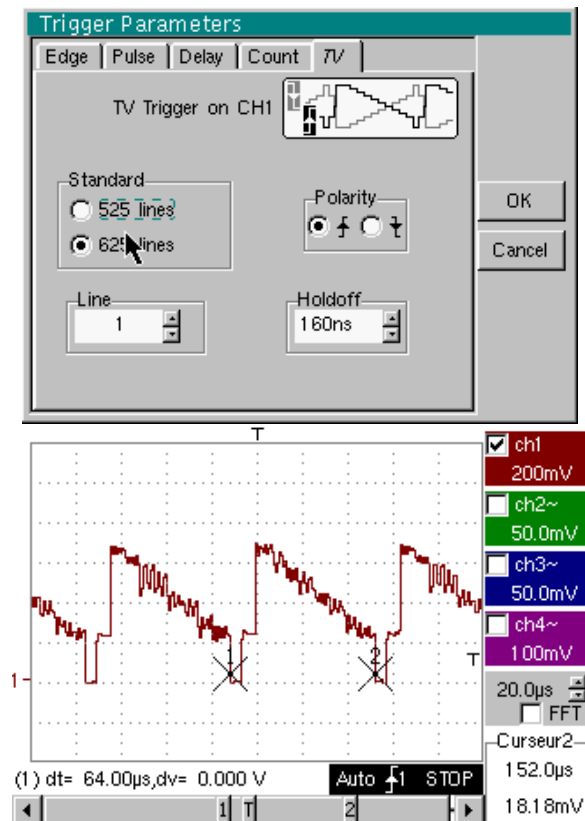

The "0" and "✓" symbols indicate the selected parameters.

Validation of the selections by "OK".



The "Trigger Parameters" menu can also be called up by double-pointing with the stylus in the trigger settings display area.

Oscilloscope Mode (cont'd)

Triggered mode

Acquisitions and refreshment of the screen at each trigger event.

Automatic mode

Acquisition and automatic refreshing of screen even when there is no trigger event.
Visible traces, even when there is no trigger event.

Single mode and Roll mode



Acquisition of signal and refreshing of the screen on the first trigger occurring after a trigger reset by pressing the key *opposite* (or via the time base menu).

In single-sweep mode, if the time base is over 50 ms/div, new samples are displayed as soon as they are acquired and ROLL mode is activated as soon as the acquisition memory is full (scrolling of the trace from the right to the left of the screen).

The ROLL mode is not possible if the trigger on automatic measurement threshold is active.



- The "✓" symbol indicates the selected trigger mode.
- The selected trigger mode is indicated in the status area (Trig'd, Auto, Single).
- The acquisition status is indicated in the status area: PRETRIG, RUN, STOP, POSTRIG, READY, ...



This selection can also be called up by double-pointing with the stylus on the time base display area.

Triggering on thresholds

Triggering on thresholds consists of:

1. acquisition implemented according to the conditions defined in the various menus,
2. analysing the trigger signal after classic acquisition,
3. searching for a condition on an automatic measurement,
4. if this condition is met, displaying the validated signals.

If "measurement on thresholds" is activated, the status zone at the foot of the screen indicates it.

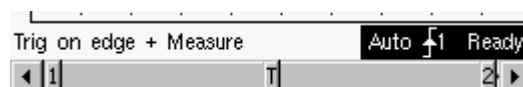

When threshold values are input, the instrument displays an error message if the measurement of a threshold value is impossible.

Save / Restart

If this option is activated, all the traces acquired are saved to .TRC and .MAC files after each acquisition.

As a result, you can save several rare events to the file system and analyse them later.

The channels are saved in files, the name of which is determined according to the date and time they are saved.

They can be saved on an FTP server or in the local file system if the FTP server parameters have been configured (menu: "UTIL" → "Config I/O Ports" → "Network")

Oscilloscope Mode (cont'd)

The "Horiz" Menu

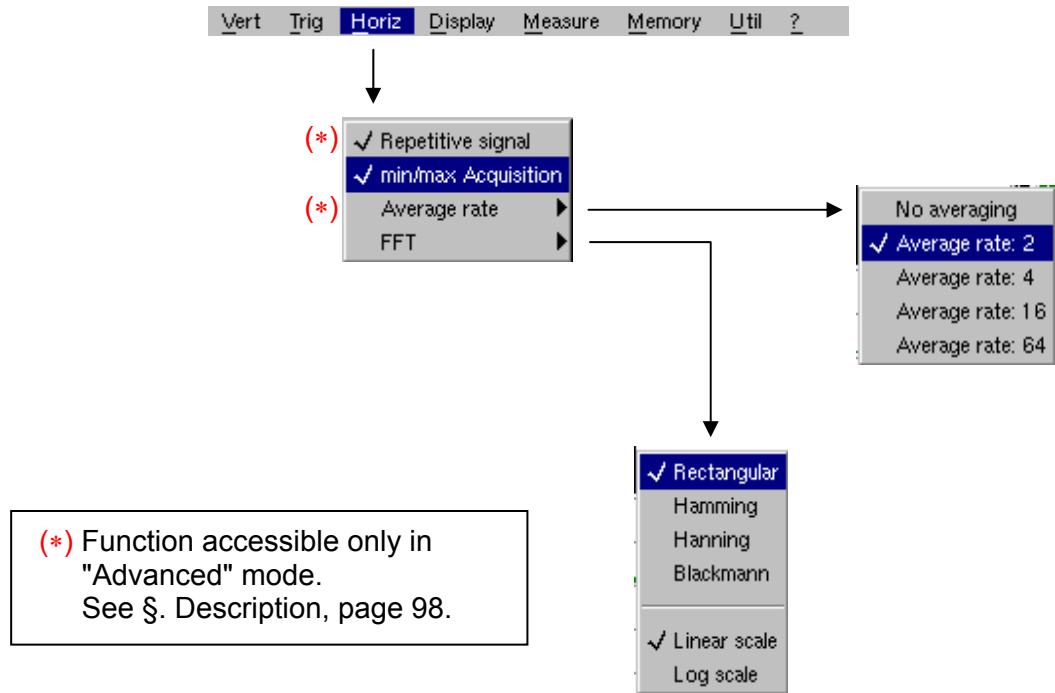

Repetitive Signal

Increase in the time definition of a trace for a periodic signal. If this option is valid, the signal can be averaged (see below).

Example: measurement on a microprocessor bus.

- For time bases of less than 100 $\mu\text{s}/\text{div}$. (without mode zoom active), the signal displayed is reconstituted on the basis of several acquisitions. The time resolution can reach 20 μs .
- If the signal is not repetitive, do not use this option. The time resolution will then be $\pm 1 \text{ ns}$.

Menu present only in "Advanced" mode (see §. "Util" Menu).

Also refer to §. "EXTENDED ACQUISITION MEMORY" option operation p. 100.

If this option is selected, rebuilding a full coherent signal may take some time.

The following settings will also affect the time significantly:

- time base,
- trigger recurrence frequency
- averaging function activity.

The signal settings (amplitude, frequency, form) must remain stable during running.

To speed up the rebuilding following a change in signal, stop acquisition and restart: Stop \rightarrow Run.

The "✓" symbol indicates that the "Repetitive Signal" option has been selected.

Oscilloscope Mode (cont'd)

Min/Max Acquisition

Use this mode to view the extreme values of the signal acquired between 2 acquisition memory samples.

This mode:

- detects wrong representation due to under-sampling
- displays short-term events (Glitch, ≥ 2 ns).

Whatever time base is used and the corresponding sampling speed, short-term events (Glitch, ≥ 2 ns) are displayed.



The "✓" symbol indicates that the "Min/Max Acquisition" mode is active.

Averaging

*No averaging
Average rate 2
Average rate 4
Average rate 16
Average rate 64*

Selection of a coefficient to calculate an average for the displayed samples.

For instance, this is a way of attenuating random noise observed in a signal.

For the averaging coefficient to be taken into account for representation of the signal, the "Repetitive signal" option must be selected.

The calculation is performed using the following formula:

$\text{Pixel}_N = \text{Sample} * 1 / \text{Average rate} + \text{Pixel}_{N-1} (1 - 1 / \text{Average rate})$

with:

Sample Value of new sample acquired at abscissa t

Pixel N Ordinate of pixel with abscissa t on the screen, at moment N

Pixel N-1 Ordinate of pixel with abscissa t on screen, at moment N-1



The "✓" symbol indicates the averaging coefficient selected.

FFT

(Fast Fourier Transform)

The Fast Fourier Transform (FFT) is used for calculating the discrete representation of a signal in a frequency domain from its discrete representation in the time domain.

FFT can be used in the following applications:

- measurement of the different harmonics and the distortion of a signal,
- analysis of a pulse response,
- search for noise source in logic circuits.

The FFT is calculated over 2500 points.



The Fast Fourier Transform is selected by the FFT icon in the control area.

When the trace is zoomed, the FFT applies to the zoomed part of the trace (next to the time base adjustment).

Description

The Fast Fourier Transform is calculated using the equation:

$$X(k) = \frac{1}{N} * \sum_{n=-\frac{N}{2}}^{\frac{N}{2}-1} x(n) * \exp\left(-j \frac{2\pi nk}{N}\right) \text{ for } k \in [0 (N-1)]$$

with: x (n): a sample in the time domain

X (k): a sample in the frequency domain

N: resolution of the FFT

n: time index

k: frequency index

The displayed trace represents the amplitude in V or dB of the various signal frequency components according to the scale selected (linear or logarithmic).

The DC component of the signal is removed by software.

Oscilloscope Mode (cont'd)

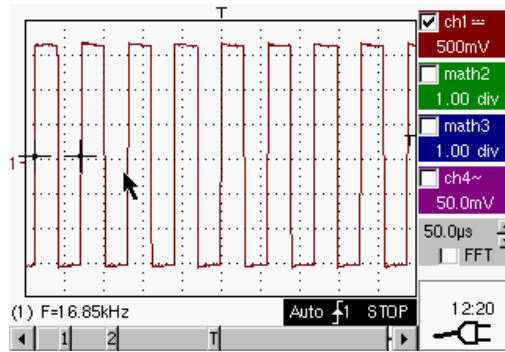

Square signal

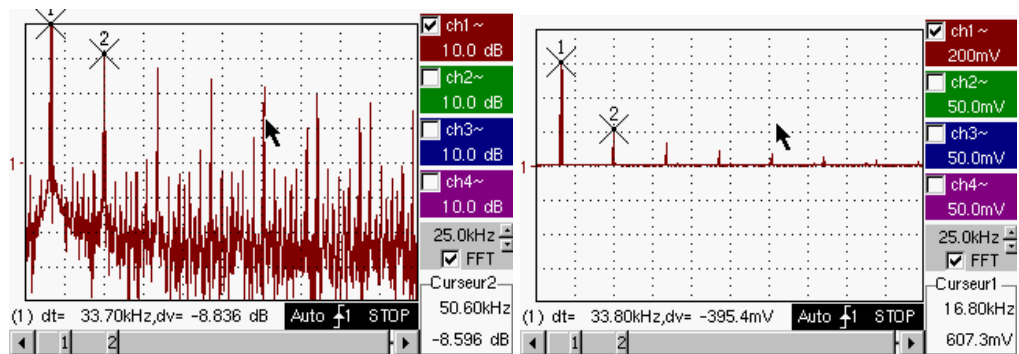

FFT with a Hanning window and a log scale

FFT with a rectangular window and a linear scale

Horizontal unit

This is indicated instead of the time base and is calculated according to the scanning coefficient:

$$\text{Unit (in Hz/div.)} = \frac{12.5}{\text{scanning coefficient}}$$

Vertical unit

Two possibilities are offered by the sub-menus:

a) Linear scale: by selecting the FFT menu and then the linear scale unit of the signal in its time representation (V/div.)

• in V/div. = $\frac{\text{unit of the signal in its time representation (V/div.)}}{2}$

b) Logarithmic scale: by selecting the FFT menu and then log scale (logarithmic)

• in dB/div. = by assigning 0 dB to a signal with an effective amplitude of 1 in the time representation

The vertical position indicator of the representation is at -40 dB.

Graphic representation

The FFT representation indicates symmetry in relation to the frequency origin; only positive frequencies are displayed.

Oscilloscope Mode (cont'd)

The sub-menus select a type of window.

Rectangular

Hamming

Hanning

Blackman

Before calculating the FFT, the oscilloscope weighs the signal to be analyzed by means of a window acting as a band-pass filter. The choice of window type is essential to distinguish between the various lines of a signal and to make accurate measurements.

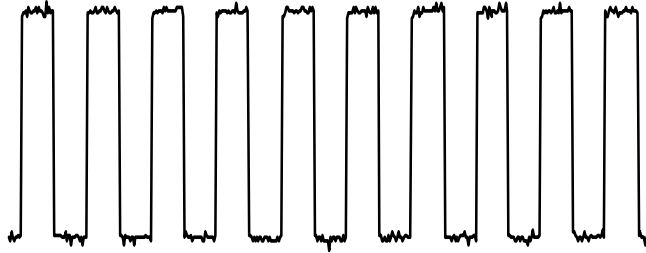

Time representation
of signal to be
analyzed



Weighting window

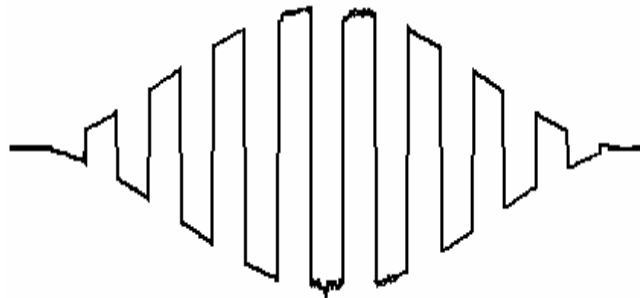

Weighted signal

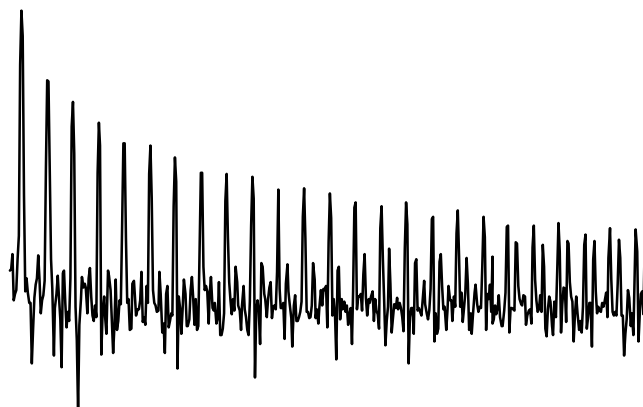

Frequency
representation of
signal calculated by
FFT

Oscilloscope Mode (cont'd)

The finite duration of the study interval results in a convolution in the signal frequency domain with a function sinc/x .

This convolution modifies the graphic representation of the FFT because of the lateral lobes characteristic of the sinc/x function (unless the study interval contains an whole number of periods).

Four types of window selections are available: the menus appear directly on selection of the FFT menu.

Type of window	Width of main lobe	Max. amplitude of secondary lobe (compared with main lobe)
Rectangular window	- 13 dB	$4 \pi/N$
Hanning window	- 32 dB	$8 \pi/N$
Hamming window	- 43 dB	$8 \pi/N$
Blackman window	- 94 dB	$12 \pi/N$

Effects of under-sampling on frequency representation:

If the sampling frequency is not correctly adjusted (less than or twice the maximum frequency of the signal to be measured), the high-frequency components will be under-sampled and appear in the graphic representation of the FFT by symmetry (aliasing).

- The "Autoset" function is active. This prevents the phenomenon above and adapts the horizontal scale: the representation is more legible.
- The "Zoom" function is active.

The "✓" symbol in front of one of the options indicates the function selected.

"EXTENDED ACQUISITION MEMORY" option operation

If the "EXTENDED ACQUISITION MEMORY" option is installed (see §. Menu " ? " → "Options"):

- The acquisition memory is extended from 2,500 samples to 50,000 samples.
- On the time base range [1 ns, 5 ms], the signal image is obtained by the aggregate of several acquisitions and reconstruction. Deactivate the "HORIZ " → "Repetitive Signal" option if the signal observed is not periodical, acquired and synchronous with the trigger.
- On the time base range [10 ms, 200 s], 50,000 samples are obtained in one acquisition.

Oscilloscope Mode (cont'd)

The "Display" Menu

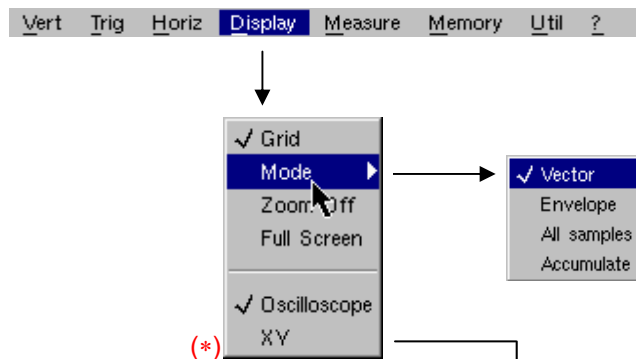

(*) Function only accessible in "Advanced" mode. See §. Description, page xx.

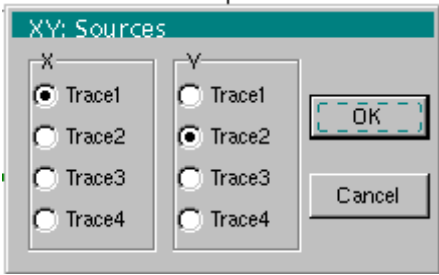

Grid

Display / Removal of graticule.

Display modes

Vector

A vector is plotted between each sample.

Envelope

The minimum and maximum observed on each horizontal position of the screen are displayed. This mode is used, for example, to view a time or amplitude variation or a modulation.



The "✓" symbol indicates the active display mode.

All samples

The entire acquisition (2,500 or 50,000 samples depending on the instrument) is displayed on the screen and a vector traced between each sample.

Use this mode to view all acquisition details. This function can be used for a memory or curve already acquired.

Accumulate

Accumulation of the different acquisitions on the screen.

The most recent acquisition is displayed using a highlighted colour.

Zoom off



Returns to the original screen size after zooming in on part of the screen.

- This function is inactive unless the screen is in zoom mode.
- If the Zoom mode is active, the letter "Z" is displayed in the trace and time-base parameter display area.



This menu can also be called up by double-pointing with the stylus inside the trace display area.

Oscilloscope Mode (cont'd)

Full screen

Switches from the normal display mode to the "full screen" display mode and vice versa.

The display is organized so as to leave the biggest surface area possible for trace plotting: only the permanent settings and the automatic or manual measurements remain.



- This function has the same effect as the  key.
- The "✓" symbol indicates that the full screen mode is active.



This function can also be called up by double-pointing with the stylus on the trace display area.

The settings defined on the front panel remain active.



The following sub-menus can be used to switch from oscilloscope to XY mode.

The "✓" symbol indicates the active mode.

Oscilloscope

This is the basic operating mode.

XY

The "XY source" menu is used for assigning the desired traces to the X axis (horizontal) and Y axis (vertical).

Validation of the selections by "OK". Exit from the menu without modification by "Cancel".



- Each axis is graduated into 8 divisions.
- The selected traces are identified by a figure corresponding to their axis.
- The "⊙" symbol indicates the trace selected for each axis.

Example

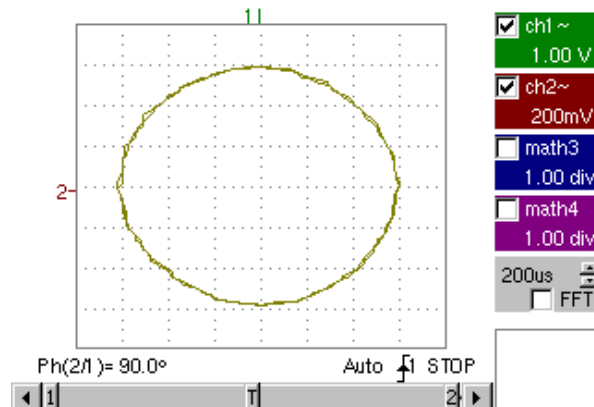

Two sinusoidal signals assigned to the X and Y axis with an offset of $\pi/2$ are then represented by a circle.

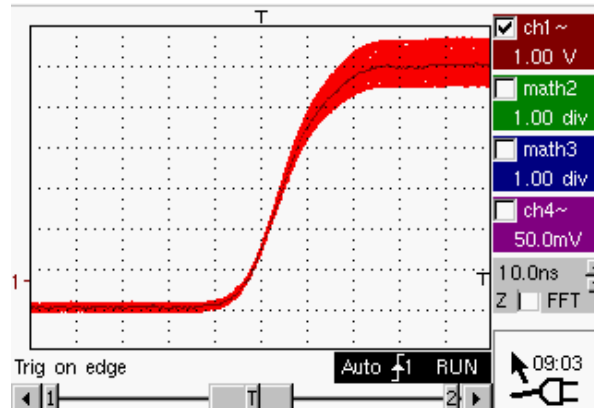

Example of

Accumulate mode



In Accumulate mode the Reference memory , the Full screen  and the ROLL mode are not active.

Oscilloscope Mode (cont'd)

The "Measure" Menu

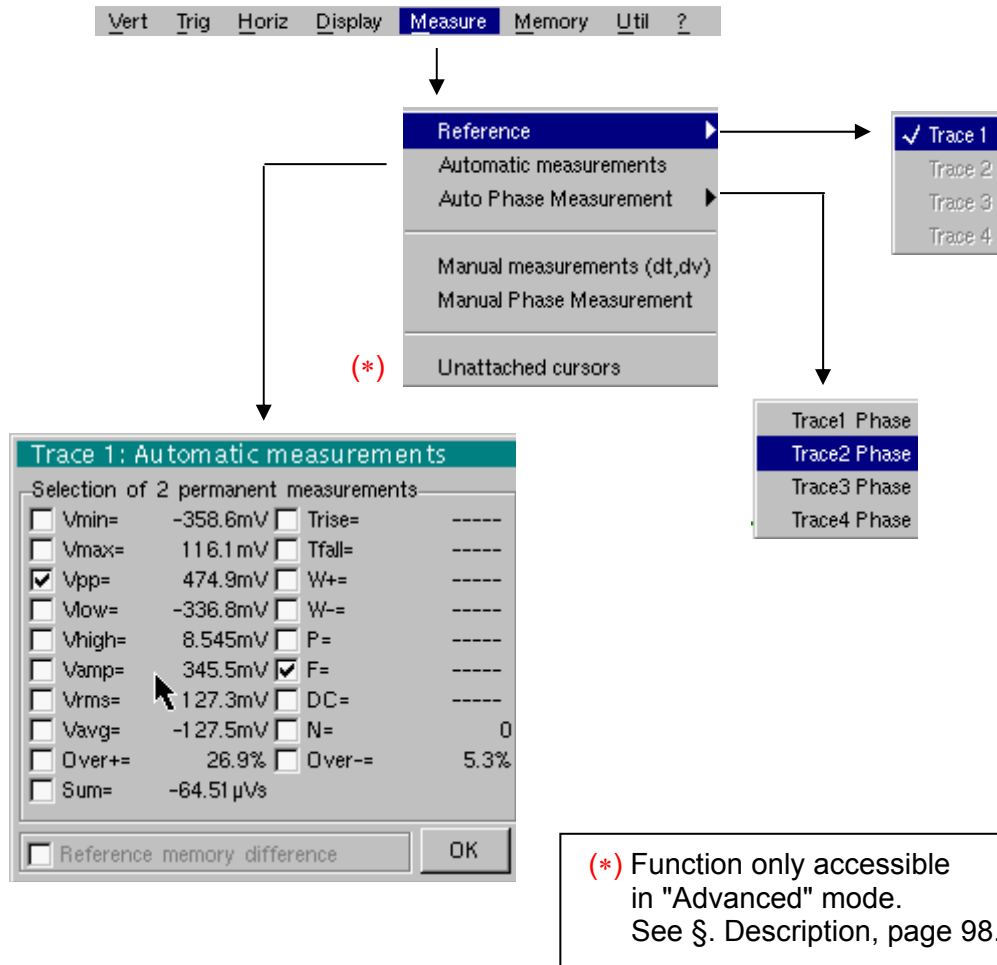

Reference

- Trace 1
- Trace 2
- Trace 3
- Trace 4



Selection of the trace on which the automatic or manual measurements will be performed.

Only the active traces can be selected. Inactive traces are displayed in a lighter colour.

The "✓" symbol indicates the reference trace.

Automatic measurements

Opens the "Automatic measurements" menu window.

The measurements are performed and refreshed on the selected reference trace. All the measurements that can be performed on this trace are displayed.

(- . - -) is displayed for measurements that cannot be performed.

The window can be validated and closed by pointing to **OK** with the stylus.

The selected measurement(s) will be displayed in the status area.

Oscilloscope Mode (cont'd)



- It is possible to select two permanent measurements.
- The "✓" symbol indicates the measurement(s) that will be indicated in the status area.
- Activation of the automatic measurements causes two markers (+) to appear on the curve, if at least one period is visible on the screen.
- The display order corresponds to the chronological order of the selection and the markers are assigned to the first measurement selected.

Automatic measurements in the status area can be deleted by means of this menu, by erasing the selected measurements (no "✓" symbol in the automatic measurements table).

Reference memory difference

Activation of the "Reference memory difference" option is a way of calculating the deviations, for all the automatic measurements, between the selected trace and the memorized reference trace (see §. Memory Menu).

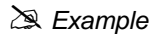

Example

Calculation performed and displayed on one of the 20 automatic measurements:

$$V_{pp} (\text{Ref. memory difference}) = V_{pp} (\text{Trace 1}) - V_{pp} (\text{Trace 1} \rightarrow \text{Ref 1})$$

The calculation is performed in the same way for all the measurements.



- This option is only active if a reference trace is present. It must correspond to the trace on which you wish to perform automatic measurements (Example: Trace 1 and Trace 1 → Ref. 1).
- Condition: the reference trace must have the same characteristics as the associated trace (sensitivity and time base)

20 automatic measurements

Vmin	minimum peak voltage
Vmax	maximum peak voltage
Vpp	peak-to-peak voltage
Vlow	established low voltage
Vhigh	established high voltage
Vamp	amplitude
Vrms	rms voltage
Vrms_c	Rms voltage performed on an integer number of cycles
Vavg	average voltage
Over+	positive overshoot
Trise	rise time
Tfall	fall time
W+	positive pulse width (at 50 % of Vamp)
W-	negative pulse width (at 50 % of Vamp)
P	period
F	frequency
DC	cyclic ratio
N	number of pulses
Over-	negative overshoot
Sum	summon of instantaneous values of the signal

Oscilloscope Mode (cont'd)

Measurement conditions

- The measurements are performed on the displayed part of the trace.
- Any change to the signal will lead to updating of the measurements. They are refreshed in step with acquisition.
- To perform automatic measurements on specific portions of the signal, frame the required measurement area with the manual cursors so that the markers show the new location of the automatic measurement.
- Measurement precision is optimum if two complete signal periods are displayed.

Automatic measurement presentation

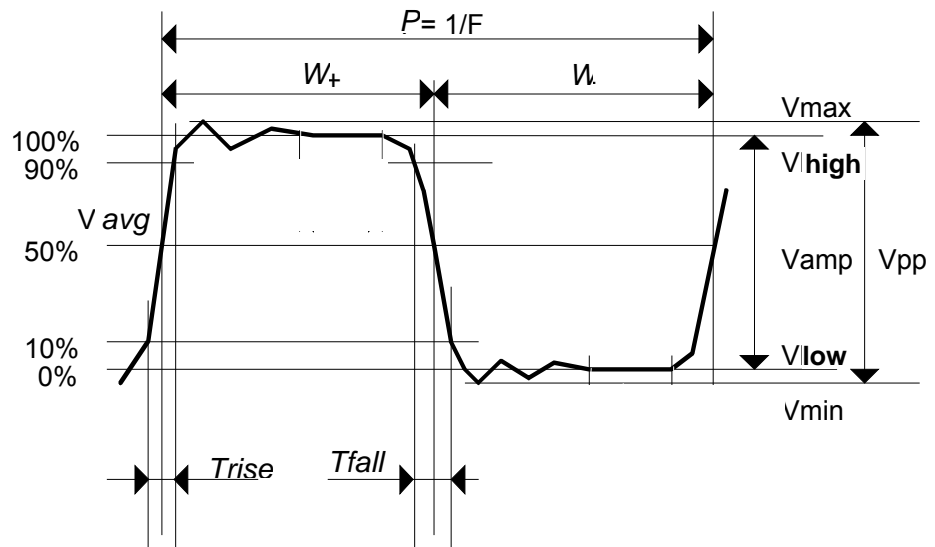

- Positive overshoot = $[100 * (V_{max} - V_{high})] / V_{amp}$
- Negative overshoot = $[100 * (V_{min} - V_{low})] / V_{amp}$

- $V_{rms} = \left[\frac{1}{n} \sum_{i=0}^{i=n} (y_i - y_{GND})^2 \right]^{1/2}$

- $V_{avg} = \frac{1}{n} \sum_{i=0}^{i=n} (y_i - y_{GND})$

- $V_{sum} = \sum_{i=0}^{i=n} (y_i \times \delta t)$

Y_{GND} = value of the point representing zero volt

Oscilloscope Mode (cont'd)

Phase measurement

Trace1 Phase

Trace2 Phase

Trace3 Phase

Trace4 Phase



Automatic measurement of a trace's phase compared with a reference trace (See §. Reference Measurement).

This menu selects the trace on which phase measurements are to be performed.

To deactivate phase measurement, deselect the selected phase measurement using the same menu.

- The "✓" symbol indicates the trace selected for phase measurement.
- Activation of the phase measurement, if it is possible, will cause display of 3 markers:
 - 2 markers for the reference trace period
 - 1 marker indicated as φ on the trace for which the phase measurements will be performed.
 These 3 markers are positioned automatically; they cannot be moved.
- The phase measurement (in $^\circ$) of the trace selected compared with the reference trace is indicated in the measurement display status area
 - Example: (1)Ph (2) = 180.0 $^\circ$
- If the measurement cannot be performed, " - . - ." is displayed.

Manual measurements (dt, dv)

Cursor measurements on the reference signal.

The measurement cursors (1 and 2) are displayed as soon as the menu is activated.

The two measurements made are:

- dt** (time difference between the two cursors),
- dv** (voltage difference between the two cursors).

The measurements performed and the displayed cursors are linked to the selected reference trace (see §. Reference Measurement).



- The "✓" symbol indicates that the manual measurements (dt, dv) are active.
- The measurement cursors can be moved directly with the stylus. They can also be moved with the stylus by selecting the 1 (cursor 1) or 2 (cursor 2) in the bargraph.
- If the free cursor option is not active (see §. "Unattached Cursors" Measurement), the cursors will remain linked to the reference trace during movements. If the option is active, the cursors can be moved anywhere on the screen.
- The dt and dv measurements in relation to the selected reference are indicated in the measurement display status area.
 - Example: (1)dt = 500.0 μ s, dv = 1.000 V

Manual phase measurement



Phase measurements using 3 cursors:

- Use cursors 1 and 2 to indicate the period of the reference signal.
- Use the φ cursor to measure the phase.

- The "✓" symbol indicates that manual phase measurement is active.
- When this menu is active, the 3 cursors are present if at least one signal is active.
- The cursor marked φ can be moved freely, even if the "Unattached cursors" menu is not active.
- The phase measurement (in $^\circ$) between the cursors is indicated in the measurement display status area.

Example: (1)Ph = 120.0 $^\circ$

Oscilloscope Mode (cont'd)

Unattached manual cursors

Used for linking or not linking the manual measurement cursors (1 and 2) to the reference trace.

When the "Unattached cursors" menu is selected, cursors 1 and 2 can be moved freely over the whole screen.



- The "✓" symbol indicates that the "Unattached cursors" menu is active.
- To deactivate this menu, deselect it by pointing with the stylus.



In the case of "Automatic measurements" and manual measurement activation:

If ...	then ...
... the manual cursors and the automatic markers are displayed together,	... the automatic measurements are performed on the portion of the trace defined between the manual cursors.
... the portion defined between the manual cursors is too small [in this case, the fixed markers (+) will not be displayed],	... the automatic measurements selected are impossible, so "-.--" is indicated in the measurement display area.



Deselect the automatic measurements to validate the manual measurements (dt, dv).

Oscilloscope Mode (cont'd)

The "Memory" Menu

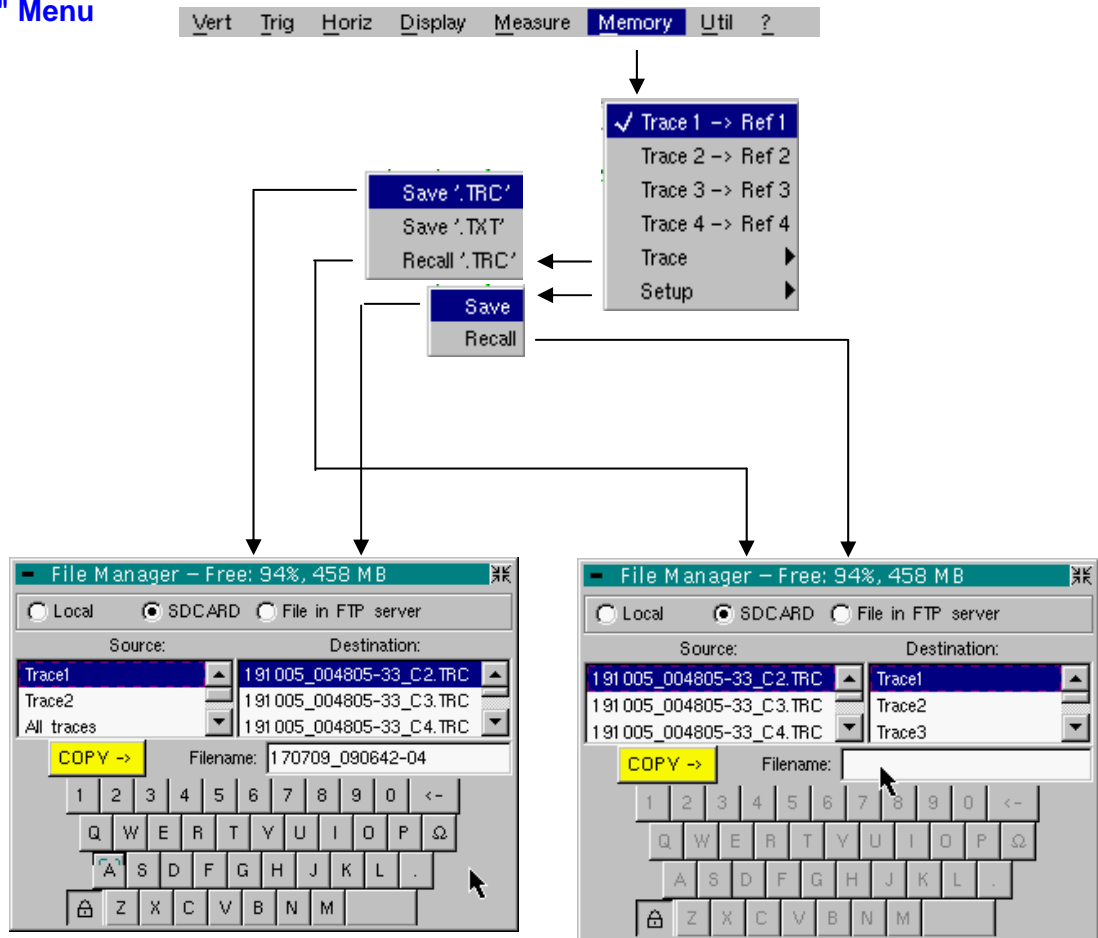

- Trace 1 → Ref. 1
- Trace 2 → Ref. 2
- Trace 3 → Ref. 3
- Trace 4 → Ref. 4

Storage of the selected trace in its reference memory
(~~E.g.~~ E.g.: Trace 1 in Ref. 1).

The 4 traces have their reference memory.



A reference memory is volatile, which means that it is lost when the instrument is switched off.



- For optimum use, the reference trace must have the same characteristics as the associated trace (sensitivity and time base).
- A trace can only be saved in its reference memory if it is present on the screen
- The memorized traces are displayed in a light color, accompanied by their reference number.
- The "✓" symbol in the menu means that the corresponding trace has been saved in the reference memory and that it is present on the screen.
- A reference trace cannot be moved.
- A reference memory can be deactivated by deselecting it in the menu.

Oscilloscope Mode (cont'd)

Trace

Saving (to the non-volatile memory) or recall of a trace or a reference memory. The back-up can be saved in two formats: ".TRC" or ".TXT". The "File copy" menu is adapted to the type of format selected.

Save .TRC

Saving of the files for subsequent recall on the oscilloscope screen
The back-up files will take the suffix .TRC; they can be recalled in the "Trace → Recall" menu.

Save.TXT

Saving of files for export to another application

The saved files have the suffix .TXT; they cannot be recalled by the "Trace → Recall" menu for screen display. However, they can be exported in a standard format for use in other software (spreadsheet - e.g. Microsoft EXCEL) using the menu "Util → Files → Export".



The selection made opens a "File Copy" menu.

- * Then in the "Source" drop-down menu, select the trace or the reference memory to be recorded.
- * All the channels can be saved in one operation:
 - A .TRC file is created for each channel displayed
 - A .MAC file is created: this file contains the commands needed to restore all the channels saved.

The trace or reference memory to be saved will appear in grey. The stylus is used for selection.



- *Only traces and reference memories present on the screen are indicated in the "Source" list (selectable).*
- *Use the scrollbar on the right of the list to view all the elements.*

-
- * A default backup file name is proposed above the keyboard. A file is generated from the date and current time. It can be modified using the virtual keyboard with the stylus.
The  key deletes the character preceding the cursor in this area.
 - * Once the name has been written, the  key records it by entering it into the destination menu and closes the menu. The backup file takes the extension .TRC (internal format) or .TXT (text format), depending on the previous selection.



Saving of the file is triggered with this key.

You can exit from this menu without saving by tapping with the stylus on the icon in the top right-hand corner of the window.



- *By moving the pointer  onto the names of the files, you will see their characteristics displayed (date and time saved and size).*
- *If the name already exists or is incompatible, an error message 'Impossible! File already exists' will be displayed.*
- *The filename is limited to a maximum of 20 characters + extension. If this rule is not observed, the message: 'Filename too long' is displayed.*

Oscilloscope Mode (cont'd)

Recall .TRC

When selected, this opens a "File Copy" menu.

In the "Source" list, the .TRC files previously saved (via the menu "Trace → Save .TRC") are displayed.

Select the file to be called up from the list displayed.

- * Choose the destination from the "Destination" list.
- * The destination trace selected is called up in the input zone.
- * This key triggers call-up of the trace.



The menu can be exited without recalling by tapping the icon in the top right-hand corner with the stylus.



- *If you wish to recall in one action all the traces memorized jointly, open corresponding ".MAC" file via menu "UTIL" → "Fichier" (File).*
- *If the destination trace selected is already present on the screen, it will be overwritten by the trace called up.*
- *When a trace is recalled, Mx appears in the destination trace parameters.*
- *The virtual keyboard cannot be used in this menu.*

Configuration

Saving or recall of an instrument configuration.

Save

When selected, this opens the "File copy" menu.

- * The "Configuration" object is automatically selected in the "Source" list.
- * A back-up file name is proposed above the Qwerty keyboard.
The  key deletes the character preceding the cursor in this area.
- * A default save filename is proposed above the keyboard, generated from the date and current time. It can be modified via the virtual keyboard using the stylus.

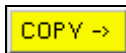

The ← key deletes the character preceding the cursor in this area.

You can exit from this menu without saving by tapping with the stylus on the icon in the top right-hand corner of the window.



- *The filename is limited to a maximum of 20 characters + extension. If this rule is not observed, the message: 'Filename too long' is displayed.*
- *If the name already exists or is incompatible, an error message will appear*
- *By moving the pointer  onto the names of the files, you will see their characteristics displayed (date and time saved and size).*

Recall

When selected, this opens the "File Copy" menu.

In the "Source" list, the .CFG files saved (via the menu "Configuration → Save") are displayed.

A particular file that is always present called "Default Config" contains the instrument's default configuration.

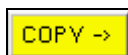

Select the file to be called up from the "Source" list.

This key triggers callup of the configuration.



The virtual keyboard cannot be used in this menu.

Oscilloscope Mode (cont'd)

The "Util" Menu

Vert Trig Horiz Display Measure Memory **Util** ?

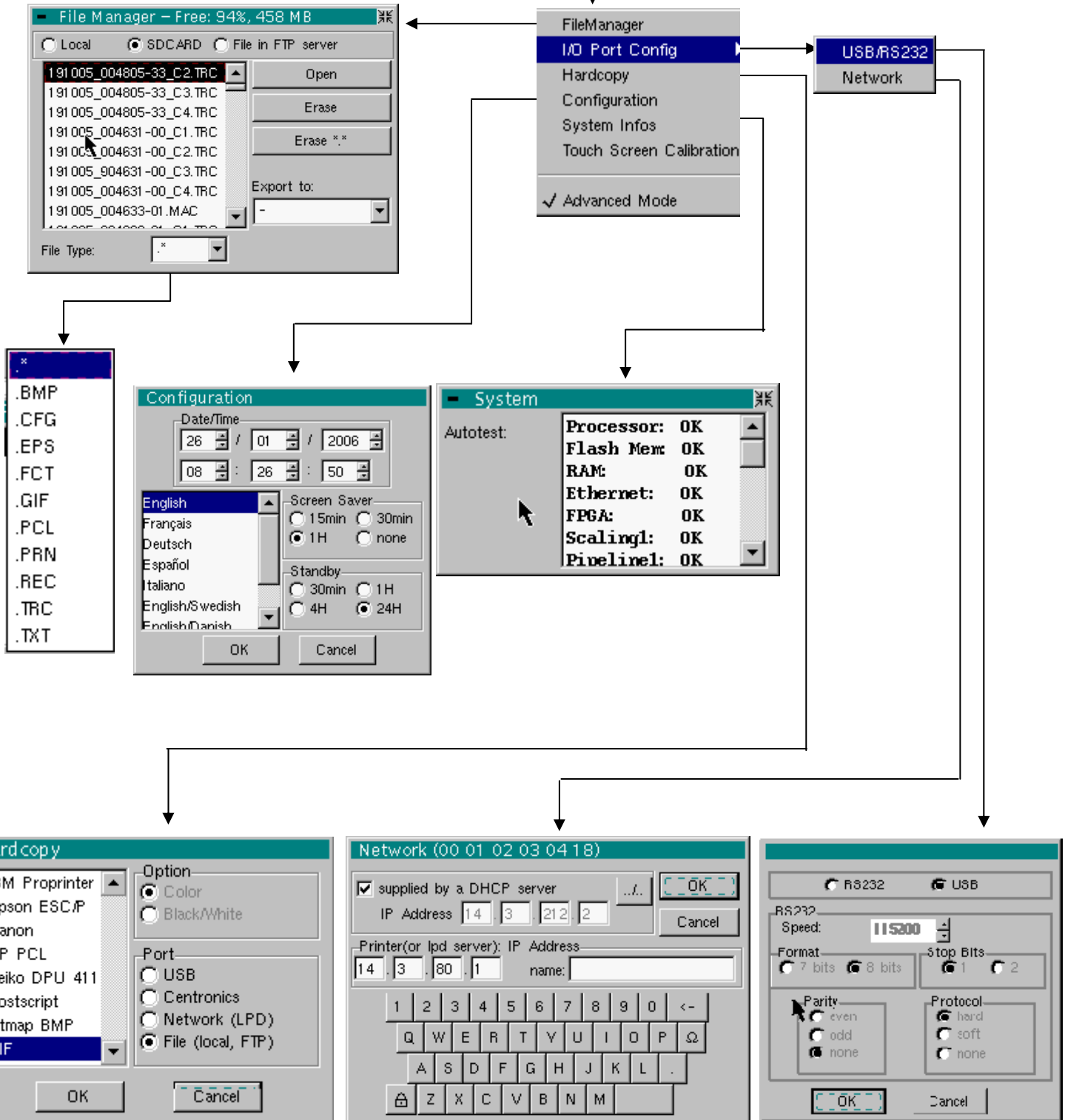

Oscilloscope Mode (cont'd)

Files



Selection of the "File Management" menu. It contains the files which have been:

- saved in previous sessions
- created since the last instrument startup.
- The storage capacity of the file system is 2 Mbytes.

These files will be saved in the FLASH memory when the instrument is switched off with the button opposite: they will then be available for the next session.

By moving the pointer  onto the names of the files, you will see their characteristics displayed (date and time saved and size).

The selected file appears in grey.

Use the scrollbar to the right of the list to scroll through the entire file system.

File type

File name extension:

- .CFG: Configuration
- .TRC: Trace in OSCILLOSCOPE mode,
- .MAC: SCPI commands (e.g.: to restore several traces),
- .REC: Traces in RECORDER mode,
- .TXT: Text format file,
- .FCT: Function in OSCILLOSCOPE and RECORDER mode,
- .PRN, .PCL, .EPS, .BMP, GIF: Print file
- .* : All files

Internal file on the FTP server

Choose the file system to be viewed.

The internal file system is used by default when the window is opened.

File system selection can be accessed on the FTP server if the FTP server parameters have been configured in the menu:

"UTIL" → "CONFIG PORT D'E/S" → "Network" in 'advanced' mode.

Open

Opens the selected file, the resulting action depends on the file extension:

- .CFG: Configuration restoration
- .TRC: Restoration of a trace in OSCILLOSCOPE mode
- .MAC: Execution of the SCPI commands contained in the file
- .REC: Restoration of traces in RECORDER mode
- .FCT: Restoration of a function

The other types cannot be opened on the instrument.

Erase

Deletes the selected file.

Erase *.*

Deletes all the files, the extension of which is selected in the 'File type'.

Export

Writing of the file selected from the list to an interface.

- RS232
- Centronics
- Network (FTP)
- Network (LPD)
- Internal file
- SD CARD

You can exit from this menu by pointing with the stylus on the icon in the top right-hand corner of the window.

Oscilloscope Mode (cont'd)

I/O port config

USB In the "USB / RS232" window, check the **USB Cable** button.

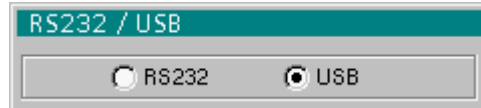

This interface uses the (USB / RS232 / ETHERNET) connector on the right side of the equipment. The **HX0084** cable must be used.

The **HX0084** cable converts the RS232 format output from the instrument to the USB protocol. After installation of the driver supplied on the CD on the host PC, communications with the instrument can be made using a "Virtual Com Port" (VCP).

Take care to configure the Virtual Com Port on the host PC as follows:

<i>Bits per second</i>	460800
<i>Data Bits</i>	8 bits
<i>Parity</i>	None
<i>Stop Bits</i>	1
<i>Flow control</i>	Hardware

RS232 In the "USB / RS232" window, do not check the **USB Cable** button.

This interface uses the (USB / RS232 / ETHERNET) connector on the right side of the equipment. The USB / RS 232 adapter (**HX0084**) or **HX0042** RS232 / SUBD9 cable must be used.

Speed Transmission speed: 300 to 115,200 Bauds.

Format Word length: 7 or 8 bits.

Parity Parity: even, odd or no parity (none).

Stop bits Number of stop bits: 1 or 2 stop bits

Protocol Serial link management mode:

Hard Hardware: the protocol is provided by the RTS and CTS lines of the RS232 link.

Soft Software: use of the XON and XOFF characters to synchronize transmission and reception of the messages (reduced "3-wire" link)

None No protocol checking



- The «  » symbol indicates the selected option.
- The option can be modified using the stylus.

Oscilloscope Mode (cont'd)

Network Configuration of the ETHERNET parameters

provided by a DHCP server

If this box is checked, the instrument makes a request to the network DHCP server to automatically obtain:

- an IP address
- a subnet mask
- the gateway address
- possibly a network printer IP address



When powering up, if you activated this protocol during a previous session, a confirmation is requested before sending the DHCP request via ETHERNET.

If the instrument is no longer connected to the network, answer "no" to the question, otherwise it will wait several minutes for an answer from the DHCP server, before becoming functional.

Physical address Oscilloscope address on the ETHERNET network.

This address cannot be modified (it is specific to the instrument)

Example: 00-01-02-03-04-63

IP address Oscilloscope IP address on the ETHERNET network.

This address can be input automatically or manually with the keyboard, after selecting the zone to be modified.

The ← key can be used to delete the value preceding the cursor in the zone to be modified.

An IP address can be assigned automatically by a DHCP server, if the server is accessible, by ticking the box "provided by a DHCP server".

Example: 132.147.200.74

After modification, the IP address is displayed for 30' at the bottom right of the screen.

**Printer (or lpd server):
IP address**

IP address of the printer or a PC where the printer is connected. In this case, an "LPD Server" programme must be installed on the PC.

This address must be input manually with the keyboard, after selecting the zone to be modified.

The ← key can be used to delete the value preceding the cursor in the zone to be modified.

Example: 132.147.240.1

Oscilloscope Mode (cont'd)

Name Name of the printer as it appears in the printing server (or PC).
If the printer is connected directly to the network, do not enter anything here.



This key can only be accessed in Advanced mode.

Use this function to manually configure:

- The subnet mask (SUBNET MASK)
- The IP address of a gateway (GATEWAY)

If you press this key twice you will access:

- The IP address of an FTP server
- The user name and password to access the FTP server.

Validation of the selections by "OK". Exit from the menu without modification by "Cancel".

Oscilloscope Mode (cont'd)

Hardcopy

The print format, the type of printer and the communication port are chosen from this menu.

The print format should be selected from the list using the stylus. Use the scrollbar to the right of the list to view all the printer languages available.

Option Choice of color or black/white printing.

Port Selection of the interface used for print data transfer:

USB or RS232 :	USB link interface or serial (acc. to selection in USB/RS232 window)
Centronics :	parallel interface via HX0041option
Network (LPD) :	network printer or an LPD client
File (internal, FTP) :	internal file or on an FTP server



- If the RS232C interface is selected, the parameters (speed, format, parity, stop bit, protocol) must be configured in the "Config I/O Ports" menu. Check that the configuration matches the configuration of the peripheral device connected to the instrument.
- If the "Network" option is selected, the parameters must be configured in the "Config I/O Ports → Network" menu).
- The "File" option is a way of recording the hardcopy in a file. ".bmp" and ".gif" image formats can be used directly in the Windows applications (word processing, presentations, etc.) As soon as the print request is launched, the "File copy" menu is opened and you should input the name of the file generated (see "Trace" menu → "Save").



A hard copy of the screen can be printed by pressing this key. The copy is printed using the parameters defined in the "Hardcopy" menu.

Configuration

Date/time Updating of the date (day, month, year) and the time (hour, minute, second). You can select the required parameter by using the stylus and the scrollbars located on either side of the parameters to be adjusted.



The clock starts when the menu is closed.

Langue (Language) Selection of the language in which the menus are written. Options available: **French, English, German, Italian, Spanish, etc.**

Screen saver Sets the screen to standby after a defined period of time to minimize the consumption of the equipment and screen ageing. 4 options are available: **15mins, 30mins, 1hr, no standby mode.**



The screen can be reactivated by pressing any key on the front panel.

Standby Shutdown of the instrument after a predefined period, in order to limit its energy consumption.

In this case, the equipment configuration is saved before the shutdown.

4 options are available: **30mins, 1hr, 4hrs, 24hrs**



The equipment is reactivated using the key shown *opposite* or using a key on the front panel, which will not be taken into account.



- The "⏻" symbol indicates the selected option.
- The option can be modified using the stylus.

Oscilloscope Mode (cont'd)

System info

Display of data concerning the operation of the instrument since it was first used.

Autotest

This list displays the result of the self-test activated when the instrument is switched on.



For verification of the instrument, see §. Maintenance p. 6.

Touch screen calibration

The touch screen needs to be calibrated if the position of the mouse pointer  is offset from the stylus impact point on the touch screen or if access to x different objects on the screen is difficult.

This calibration process is described on p. 52, 53.

"Advanced" mode

The "Advanced" mode gives access to certain additional functions. By default the "Advanced" mode is not activated in order to simplify the use of the equipment.

Functions available in "Advanced" mode only

Function	Accessed from the menu	Selection in advanced mode	State in non advanced mode (default configuration)
math1, math2, math3, math4	"Vert"	Complex mathematical functions applicable to the 4 traces	Simple mathematical functions applicable only to traces 2 and 3
Repetitive signal	"Horiz"	Choice between repetitive and non repetitive mode	Non repetitive mode
Average	"Horiz"	No averaging., x2, x4, x16, x64	No averaging
XY	"Display"	Choice between Oscilloscope (YT) and XY	Oscilloscope (YT)
Free manual cursors	"Measure"	Manual cursors whether related or not to the reference trace	Cursors 1 and 2 related to the reference trace
Access to FTP server	"Memory"	Option that can be selected	Option that cannot be selected (grayed)

- The "✓" symbol indicates that "Advanced" mode is enabled.
- The stylus can be used to modify this.
- By default, "Advanced" mode is not enabled.
- In "Advanced" mode, the instrument starts in the configuration where it stopped; otherwise it starts in its default configuration (always the same one).

Oscilloscope Mode (cont'd)

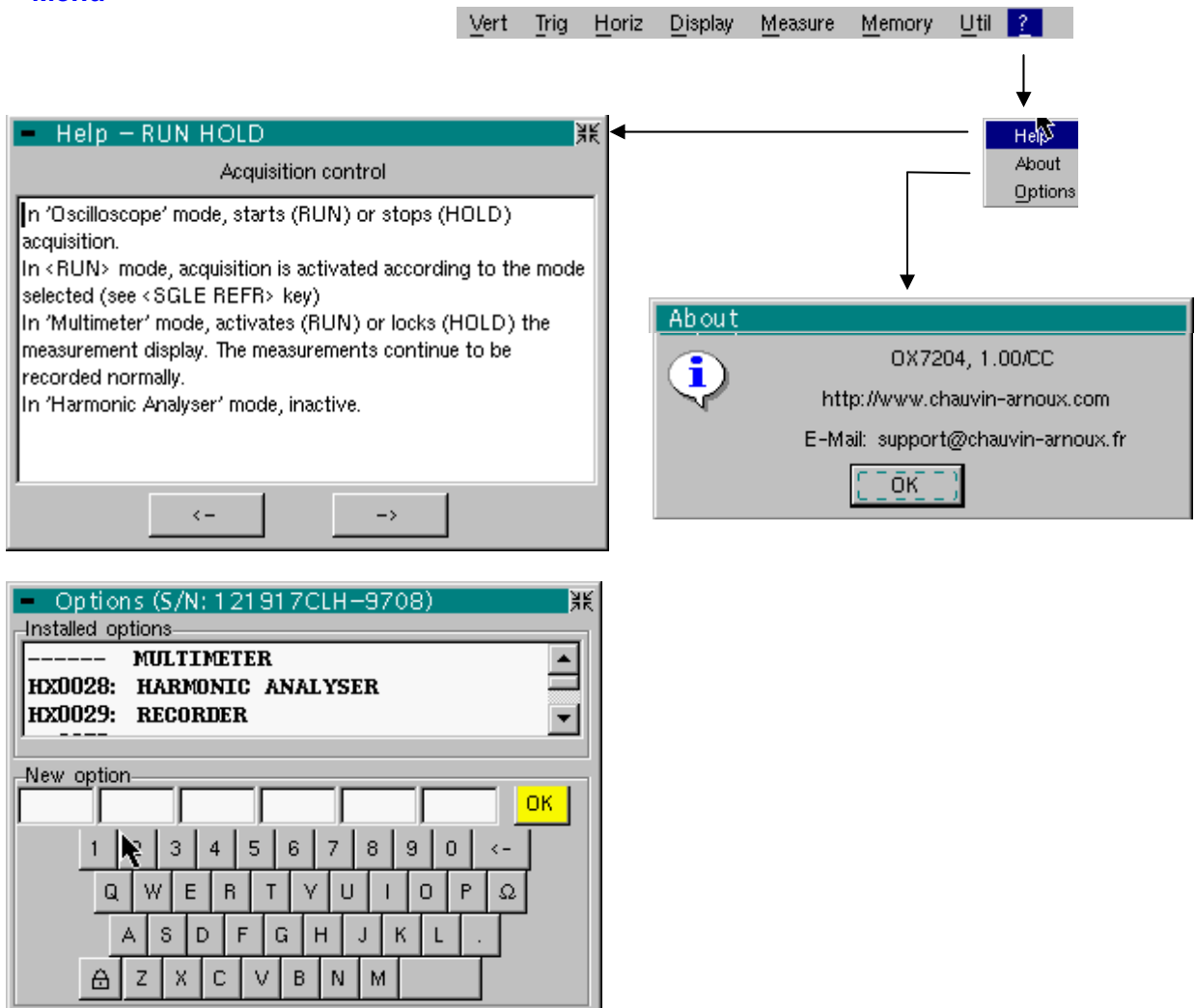

The « ? » Menu



Help

When selected with the stylus, this opens the "Help" menu.

The online help concerns the instrument's keyboard.

Use the  and  keys to scroll through the description of the keys on the front panel.

Whenever a keyboard key is pressed, online help will be displayed regarding the key pressed.

The functions associated with the keys will not be activated.

The key name is indicated above the explanation.

You can exit from this menu by pointing with the stylus in the top right-hand corner of the window.

Oscilloscope Mode (cont'd)

About

This submenu provides information:

- On the name of the instrument, the software version and the version of the hardware
- The WEB site to visit to find new products in the range for METRIX instruments.
- The email address of the customer service that can answer your questions on the instrument.

You can exit from this menu by choosing **OK**.

Options

Installation of the various instrument options.

An option is installed by entering a 24-character code and clicking on the OK key.

This is a unique code for the option acquired and for your instrument (it cannot be installed on another instrument)

When an option is acquired, you must specify the serial number and key of the instrument in your order and CHAUVIN-ARNOUX will supply you with this code.

The serial number and key are indicated in the "Options" window title bar.

 : 123456ABC-2997

The list of options installed is also displayed in this window.

Options available:

- MULTIMETER
- HARMONIC ANALYSER
- RECORDER
- EXTENDED ACQUISITION MEMORY
- POWER MEASUREMENTS



The installation of a new option is integrated after the instrument is restarted.

Multimeter Mode

The Keys



Press the key *opposite* to select the "**Multimeter**" mode.

4 "UTILITY" keys or key pads



Direct access to LCD **light** adjustment.



No action.



Triggers a **hardcopy** in accordance with the configuration chosen in the "Util" and "Hardcopy" menus.

A second press before the end of the process will interrupt the current printout. If printing is impossible, a "Printing error" message will be sent.

The "  " symbol is displayed in front of the settings display zone when printing is in progress.



No action.

1 "AUTOSET" key



No action.

Selective "AUTOSET"



+



No action.

4 "TRIGGER" keys



No action.



No action.



No action.



To lock / unlock the display of the measurements. Plotting of the traces never stops.

Multimeter Mode (cont'd)

3 "MEASURE" keys



No action.



For changing the reference trace to which the cursor refers (successive presses).



No action.

3 "HORIZONTAL" keys or key pads



Duration of the recording in the display window: > **5', 15', 30', 1h, 6h, 12h, 24h, week, month.**



No action.



- If the instrument is equipped with the "EXTENDED ACQUISITION MEMORY" option:
pressing on this key will display the last 2,700 measurements on the curve and pressing again will display the 27,000 acquisition memory measurements.
- If not, this key will not have any effect.

5 "VERTICAL" keys or key pads

The instrument contains as many independent multimeters as there are channels in "Oscilloscope" mode (2 or 4).

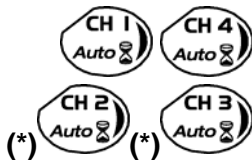

Same function as in "Oscilloscope" mode.

A long press enables or disables the autorange on the channel concerned.

The channel is displayed and selected.

(*) only OX 7204



No action.



If a channel is activated and selected, this key can be used to change the input coupling of the channel. By successive presses, the coupling can be changed from AC to DC to AC+DC.

The coupling is indicated in the multimeter window of the channel concerned.

When selected for ohmmeter, continuity or capacimeter measurements, component testing or temperature measurements on channel 1, the key has no effect, as the input coupling in these functions cannot be adjusted.



Manual modification of the measurement range



If the autorange mode is activated, the manual adjustment has no effect: the autorange will automatically reset the instrument to the measurement range best suited to the input signal.



No action.



Multimeter Mode (cont'd)

Display

Display

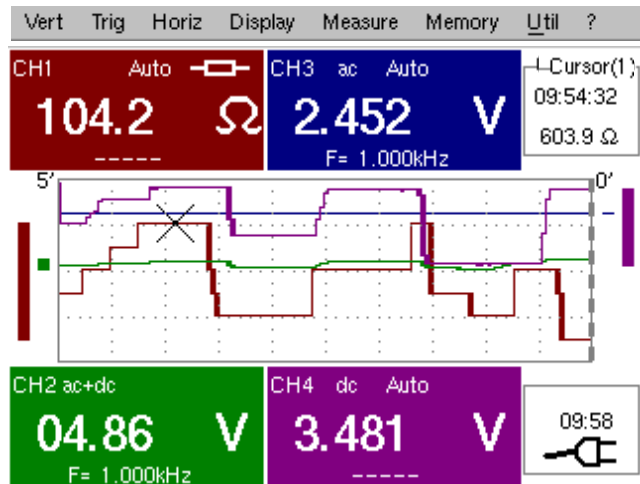

Composition

The multimeter display is divided into 6 functional areas:

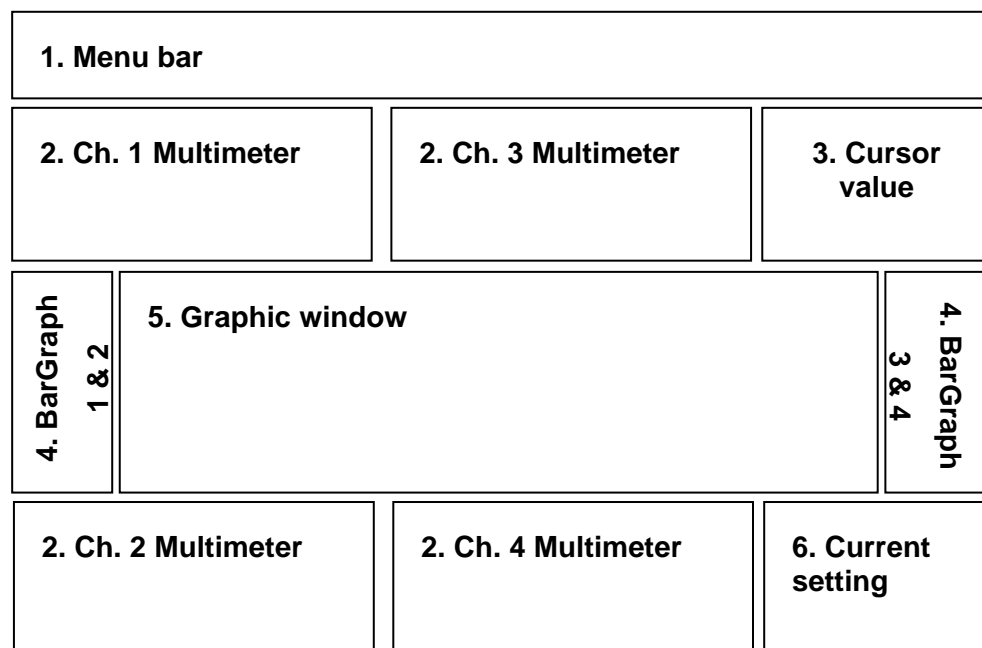

1. Menu bar



The tool bar gives access to the different menus of the "Multimeter" function.

Multimeter Mode (cont'd)

2. Channel (x) multimeter)

There is a display area reserved for each of the instrument's channels. In each of these, the following information is indicated:

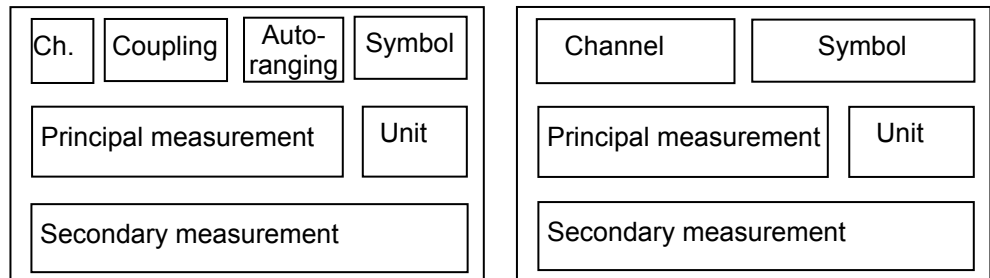

Channel CH1, CH2, CH3 or CH4

Coupling The input coupling selected (see §. Vert. Menu) is indicated in this field. For the Ohmmeter, Capacimeter, Continuity, Component Test, Wattmeter, the coupling is not shown.

Autorange Indicates whether range changing is automatic.

Symbols A symbol is displayed corresponding to the type of selected measurement :

□	Ohmmeter,
	Capacimeter,
≡	Continuity
→	Component test
PT100	Temperature measurement

Main measurement If the channel is activated, the measurement result is displayed. Otherwise, the message '– X –' fills the unused space.

Unit Contains the measurement unit associated with the current measurement range.

Secondary measurement Selected through the "Display" menu.

☞ *If no display is selected or if the display is not possible (e.g. frequency measurement for a continuous signal, etc.), the character string '----' is displayed.*

If the channel is not selected, '– X –' is displayed.

3. Cursor value

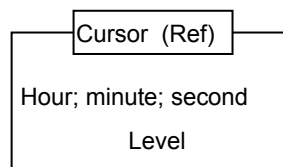

Display of the absolute position of the cursor on the measurement reference channel.

Time position: hour, minute, second

Level position: depending on the type of measurement.

If your instrument is equipped with the "EXTENDED ACQUISITION MEMORY" option, an indication of the zoom status is also displayed (Zoom ON / Zoom OFF) in this zone.

Multimeter Mode (cont'd)

4. Bargraph

These graphs show the min. and max. values measured on the channels in the range during the observation period.

The bargraph is shown with the color of the channel.

The zero level of the bargraph and the scale are adapted to suit the type of measurement and the range.



If the range is changed, the bargraph is reinitialized and the curve showing the evolution of the measurement is erased.

5. Graphic window

This window shows the evolution of the measurements as a function of time. The most recent measurement points are those on the right-hand side of the screen.

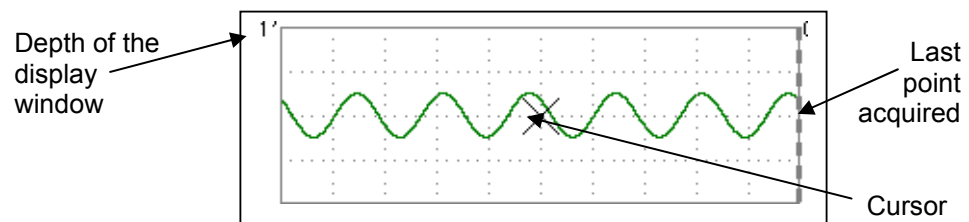

The depth of the window, which represents the observation period, can be programmed using the keys *opposite*.

Adjustments possible: 5', 15', 30', 1hr, 6hrs, 12hrs, 24hrs, 1 week, 1 month.

If ROLL mode is activated (see §. "HORIZ" menu), the curves are constantly updated; if the acquisition memory is full, the oldest measurements disappear and are replaced by recent measurements.

6. Current settings

Identical to OSCILLOSCOPE mode: indication and adjustment of the value of the latest parameter modified.

Multimeter Mode (cont'd)

The Menus

Presentation

- Screen display when measurements are possible on all the channels:

Examples:

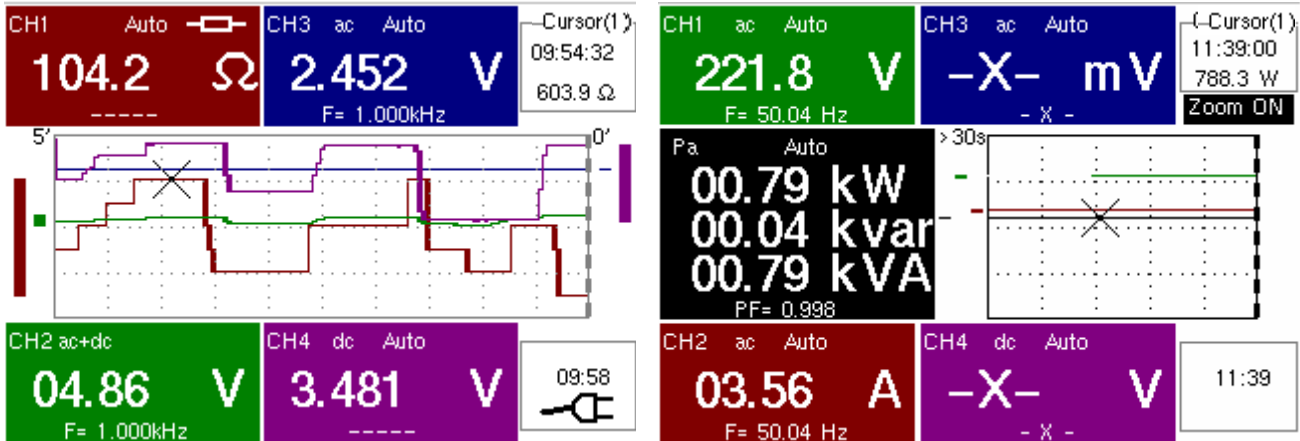

Resistance measurement on CH1 channel and amplitude measurement on other channels

Monophased power measurement (if HX0075 option is installed)

- Screen display when measurements are possible on CH1 only:

Example: CH1 is configured for a Component Test

The display is identical when CH1 is configured for capacitance or continuity measurement.

Measurements on channels 2, 3 and 4 are impossible.

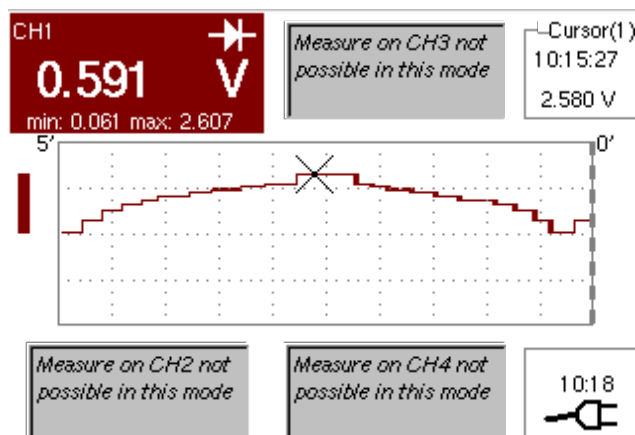

Multimeter Mode (cont'd)

The "Vert" Menu

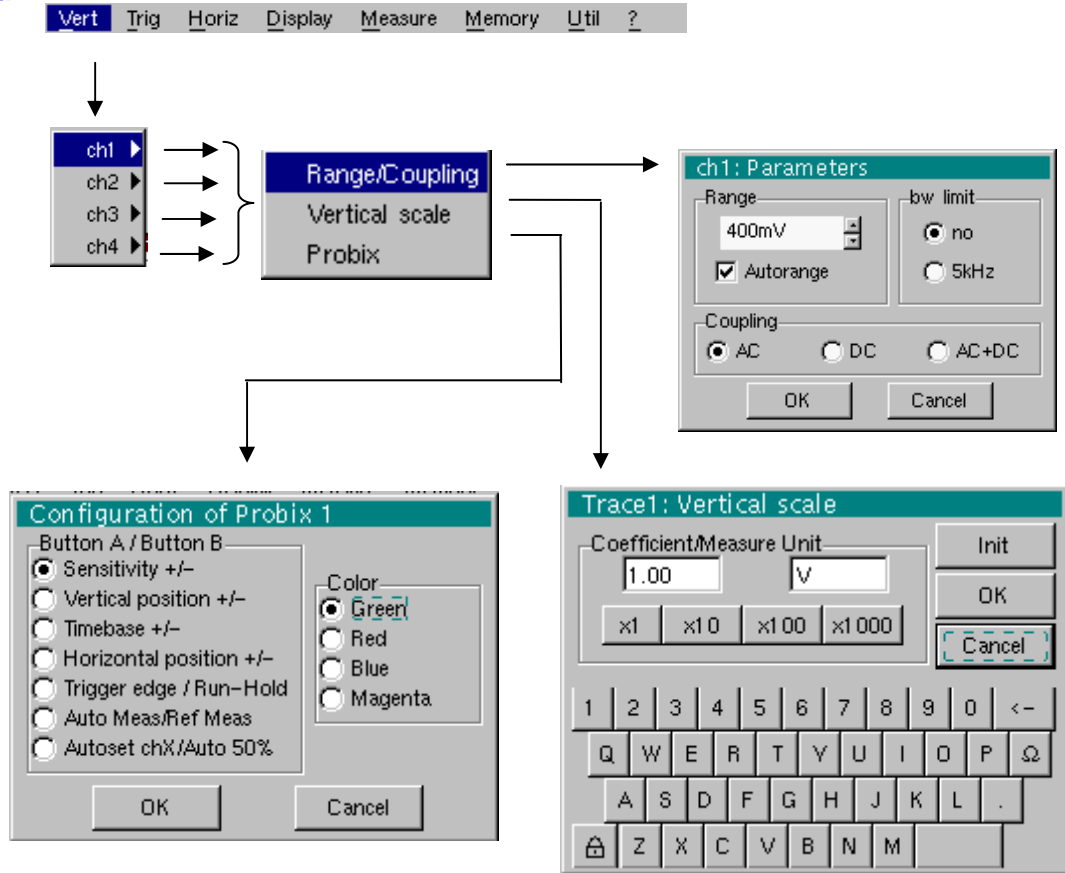

ch1 ch2
ch3 ch4

Modification of:

- the parameters of channels **ch1**, **ch2**, **ch3** and **ch4**, independently
- the vertical scale of the selected trace
- the parameters of the **Probig** probe connected.

Sensitivity/Coupling

Modifies the parameters of the selected channel.

Each measurement display zone on the main screen indicates the coupling and bandwidth limitation parameters used on each channel.

Range

Choice of the measurement range. The unit displayed depends on:

- the type of measurement selected: amplitude (available on all channels), ohmmeter, continuity, capacimeter, PT100 temperature probe (available only on channel 1, see §. Measure Menu),
- the **Probig** probe connected to the input,
- the parameters of the "Vertical Scale" menu (if they have been modified since connection of the **Probig** probe).



For the ranges available for each type of measurement, refer to the technical specifications of the "Multimeter" function.

The Range / Coupling menu is displayed in light grey when the range is not modifiable (single range).

Multimeter Mode (cont'd)

Autorange When this option is selected, the measurement range changes automatically.

 The "✓" symbol shows that it is active.



If the option is disabled, the range can be modified manually, using the keys *opposite* or the "Range" menu, depending on the type of measurement being performed.

Coupling Modification of the AC, DC or AC+DC coupling for amplitude measurement.

AC: AC voltage measurement

DC: DC voltage measurement

AC + DC: Measurement of AC voltage with a DC component

 For AC and AC+DC measurements, the menu "Display → Frequency" can be used to display the frequency of the signal in the secondary display field.

The "⊙" symbol indicates the type of coupling selected.

The coupling is updated in the modified channel parameter display zone.

Bandwidth limit If the channel measures an AC or AC+DC voltage (see **Coupling**), it is possible to filter the signal with a low-pass analogical filter whose cut-off frequency is 5 kHz.

The other proposed filter is a digital filter to 625Hz, if this filter is selected, the analog filter at 5kHz is also activated.

The digital filter characteristics are:

Low-pass filter

Cutoff frequency 625Hz

Order94

Passband ripple..... 0.5dB

Transition band.....0.02

Stopband attenuation 50.0dB

Multimeter Mode (cont'd)

The "Trig" Menu

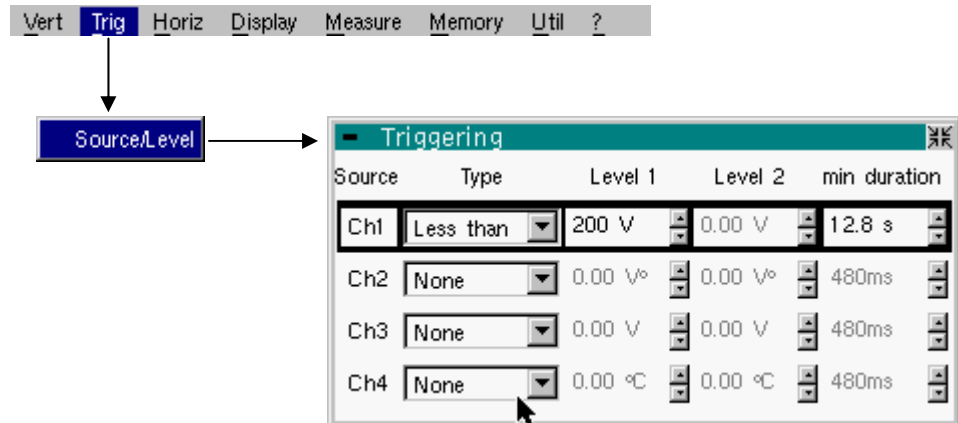

Source/Level

Selection of trigger type and level on each channel. Triggering takes place if a condition described by a line of the "Trigger" table is verified.

The trigger level should be defined in the channel measurement dynamic.

Trigger leads to the logging of the instant and trigger characteristics.

The events logged can be accessed from the "Disp." → "Defaults" menu.

Source The channel number.

Type The type of trigger for each channel.

There are several possible types:

- None (no triggering)
- Lower than
- Higher than
- Lower/Higher
- Exterior

In "Multimeter" mode, several conditions are monitored simultaneously.

Level 1 Adjustment of the main trigger level using the stylus.

Level 2 Adjustment of the auxiliary trigger level using the stylus.
This tab is enabled only if the "External" trigger type is selected.

min duration > The fault will be evidenced if the fault condition defined by the type and levels is present for a parameterisable period from 480 ms to 670 ks according to the selected recording duration (48 ms to 670 ks if your instrument is equipped with the EXTENDED ACQUISITION MEMORY option).

Multimeter Mode (contd.)

The "Horiz" Menu

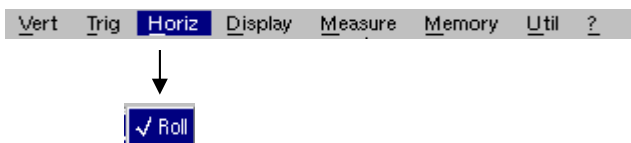

- Roll**
- If this mode is activated (presence of "✓" symbol), the measurement history curve is constructed continuously. The oldest points disappear on the left-hand side of the screen, while the most recent ones appear on the right.
 - If this mode is deactivated, the point display stops as soon as the first point acquired reaches the left-hand edge of the window. However, the measurements continue and are still refreshed in the area 'Multimeter Channel'x'.

The "Disp" Menu

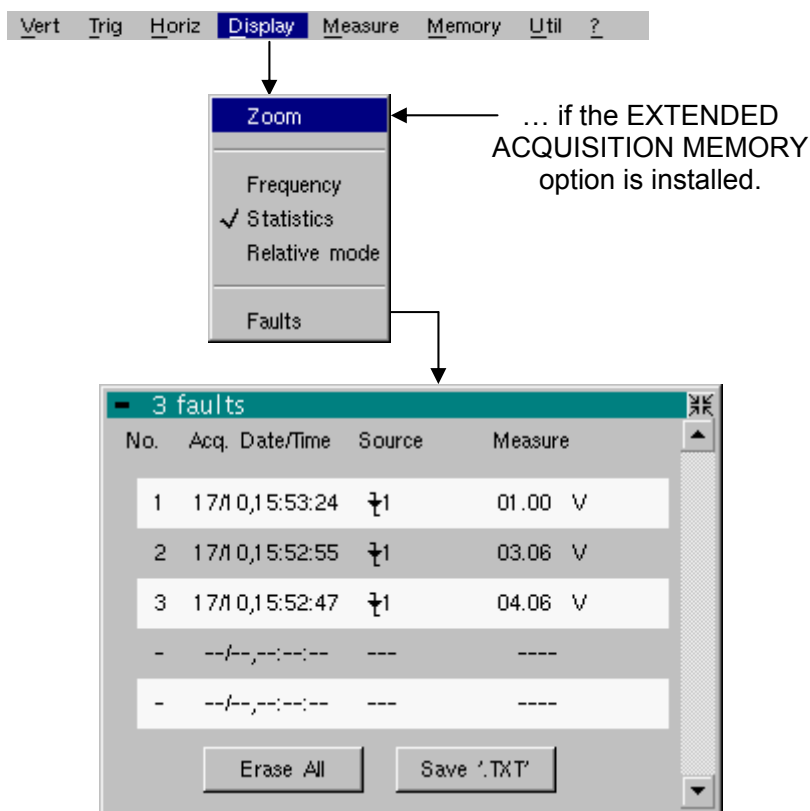

Zoom

If ...	then ...
If your instrument is equipped with the "EXTENDED ACQUISITION MEMORY" option,	display of the last 2700 measurements <u>OR</u> display of the entire acquisition memory (27000 measurements)
If your instrument is not equipped with this option,	the ZOOM entry does not exist on the menu.

Multimeter Mode (contd.)

Frequency In the event of alternative amplitude, display of the frequency of the signal measured (if possible and coherent) as a secondary measurement on each channel.

Statistics Display of the Min and Max values of the measurements taken as secondary measurements on each channel.

Relative mode Display of variance as secondary measurement on each channel.
The variance displayed is the difference between the value measured and the value displayed when this option was selected.



The "✓" symbol indicates the secondary function selected.

Faults Display of the characteristics of all faults (maximum of 100) acquired:

- Fault detection instant,
- Fault type,
- Measurement that triggered a fault.

Faults are defined in the "Trigger" menu.

Use the "Erase" button to reinitialize this list.

Use the "Save '.TXT'" button to save all the faults on this table to a .TXT format file. A dialogue window is displayed to request the name of the file to be generated.

Multimeter Mode (cont'd)

The "Measure" Menu

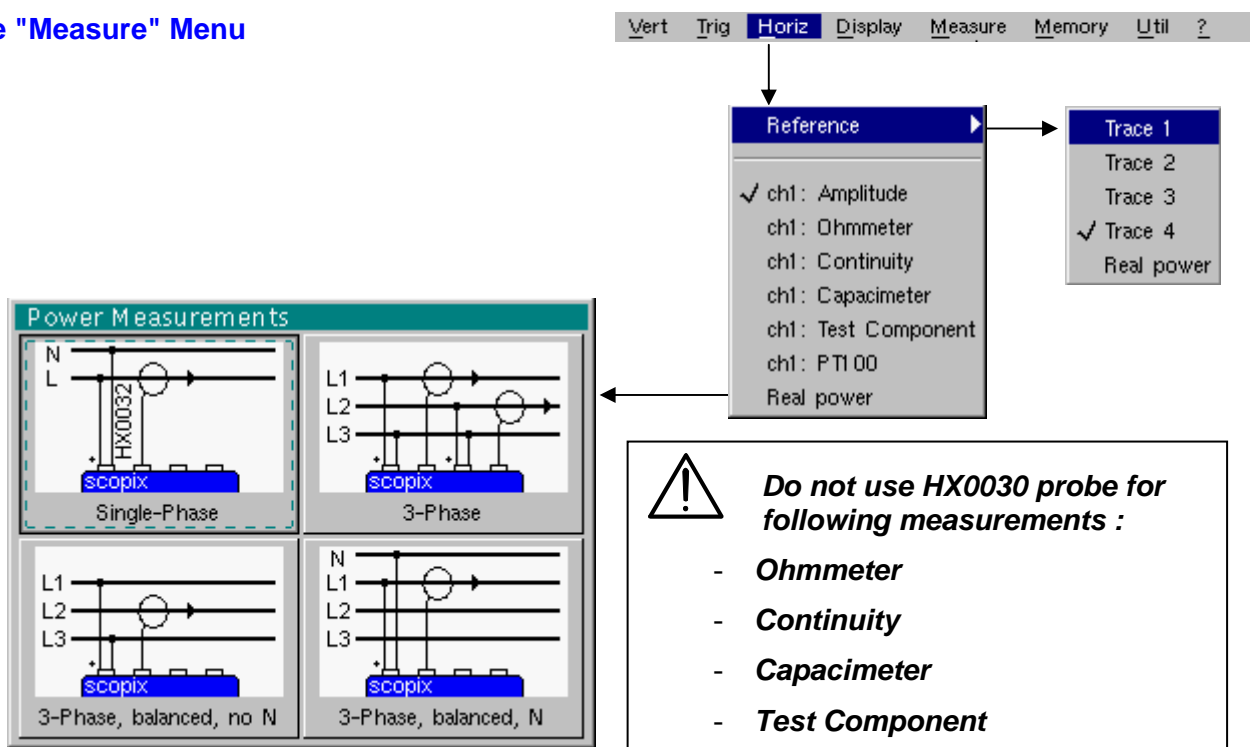

Reference

The reference is used to select the measurement trace on which the cursor is positioned. The cursor value is therefore relative to the measurement on this channel.

It is only possible to choose the reference on activated channels: channels that are not activated are displayed in a lighter colour in the sub-menu.

 The " ✓" symbol indicates the reference selected.

ch1: Amplitude

Channel CH1 is used as a voltmeter and therefore measures the amplitude of the signal present on the input of this channel.

ch1: Ohmmeter

Channel CH1 is used as an ohmmeter and therefore measures the resistance of the dipole wired to the input.

ch1: Continuity

Channel CH1 is used as a continuity tester: there is a beep if the input resistance is less than ≈ 30 Ohms.

 In this mode, measurements are impossible on the other channels.

ch1: Capacimeter

Channel CH1 is used as a capacitance meter and therefore measures the capacitance of the dipole wired to the channel's input.

 In this mode, measurements are impossible on the other channels.

ch1: Component Test

Channel CH1 is used as a component tester. This mode measures the threshold of the diode wired to the input.

 In this mode, measurements are impossible on the other channels.

ch1: PT100

These configurations measure a temperature using a 100Ω (PT100) resistive sensor.

Multimeter Mode (cont'd)

*Display of
power values*

shows that the trace
represents the evolution
of active power

Active power

Reactive power

Apparent power



Power factor or
extreme values
of active power

Multimeter Mode (cont'd)

With the POWER MEASUREMENTS option, the following measurements are possible :

Single phase output

Display of the active output calculation result measured using CH1 to measure voltage and CH2 to measure current.

Three-phase output on balanced network, without a neutral

The displayed value shows the three-phase active output calculated from the selected wiring.

Three-phase output on balanced network, with a neutral

The displayed value is equal to 3 times the active power measured on a phase.

Three-phase output 3 wires

Display of the three-phase active output calculation result measured by the method using two wattmeters on a installation without a neutral.

Diagram equivalent to measurement

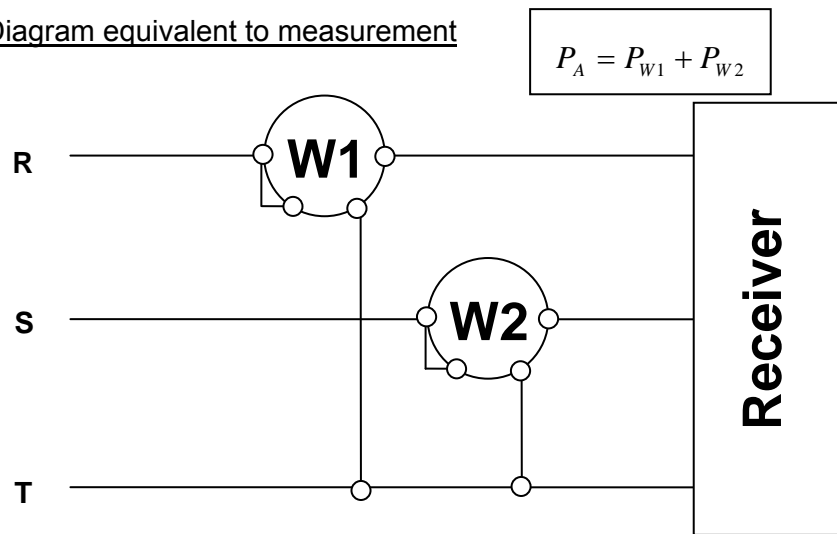

Measurement carried out with SCOPIX

Current measurements can be made with PROBIX HX0034 clamps and voltage measurement with PROBIX HX0033.

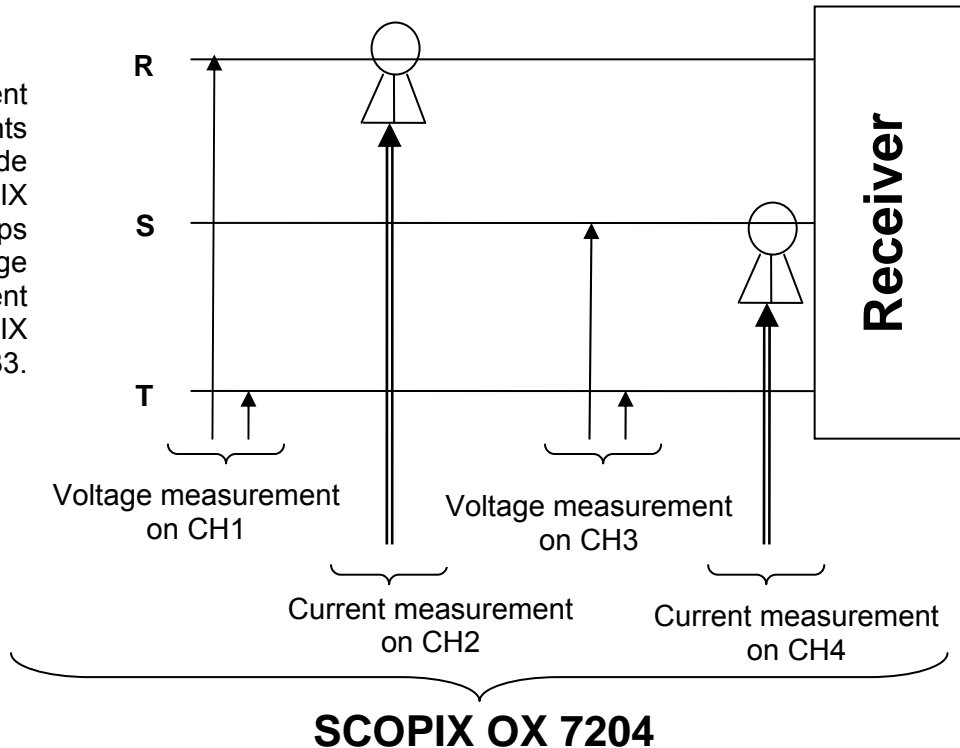

Multimeter Mode (cont'd)

The "Memory" Menu

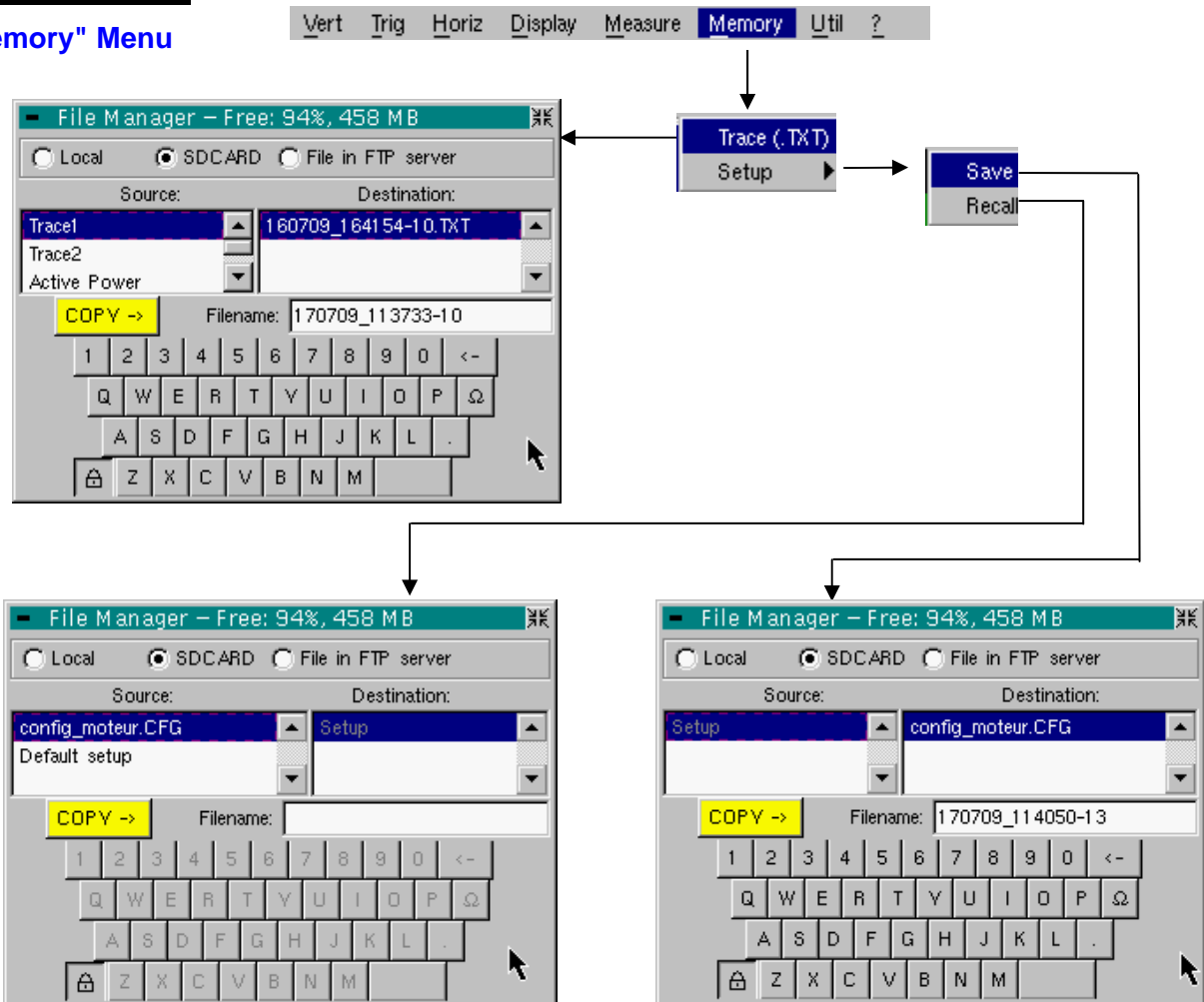

Trace (.TXT) In "Multimeter" mode, it is only possible to save a trace in non-volatile memory in .TXT format.

Files saved with the suffix .TXT can be exported onto a PC (see §. Util Menu → Files) for processing with other software (spreadsheet, etc.).

Configuration This function is identical to the one in "Oscilloscope" mode.

The "Util" Menu

This menu is identical to the one in "Oscilloscope" mode, except :

Configuration

Screen saver

- If the recording time is equal or over 15 minutes, the screen saver will never be activated.
- If the recording time is minimal (5 min. 24 sec.), the screen saver and settings operate as in "Oscilloscope" mode.

Standby

- If the recording time is equal or over 15 minutes, standby will never be activated.
- If the recording time is minimal (5 min. 24 sec.), standby and settings operate as in "Oscilloscope" mode.

The "?" Menu

This function is identical to the one in "Oscilloscope" mode.

Harmonic Analysis Mode

Display

Presentation

The harmonic analysis function displays the fundamental and the 15 harmonic ranks up to the 31st.

In this mode, the time base is therefore adaptive and is not manually adjustable.

This analysis is reserved for signals whose fundamental frequency is between 40 and 450Hz.

All the conventional settings of the oscilloscope (except for the time base and trigger) remain active in this mode (Sensitivity/Coupling, Vertical Scale).

Only the channels (not the functions or the memories) can be the subject of harmonic analysis.

Harmonic analysis of 2 (**OX 7xx2**) or 4 (**OX 7xx4**) signals can therefore be displayed simultaneously.

If the "POWER MEASUREMENTS" option is installed, the harmonic analysis of output (single-phase) can be displayed.

On the front, use the ZOOM key to modify the vertical display scale. The vertical scale is modified each time the key is pressed.

Various possibilities are offered:

- 0 to 100%: The vertical display dynamic is adapted to the amplitude of the fundamental.
- 0 to 50%: The vertical display dynamic is adapted to 50% of the amplitude of the fundamental.
- 0 to 25%: The vertical display dynamic is adapted to 25% of the amplitude of the fundamental.
- 0 to 10%: The vertical display dynamic is adapted to 10% of the amplitude of the fundamental.

Double tapping on the bar chart zone triggers access to touch screen calibration.

Double tapping on the adjustment zone of a channel triggers access to these adjustments.

Harmonic Analysis Mode (cont'd)

Display Measurement of the harmonics on channels 1 and 2:

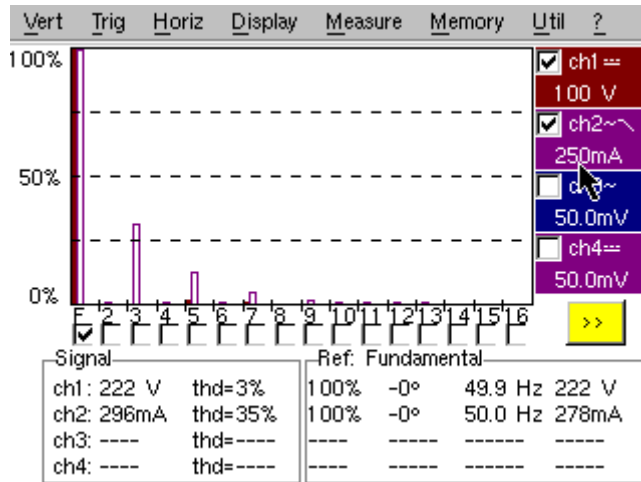

Measurement of the output harmonics:

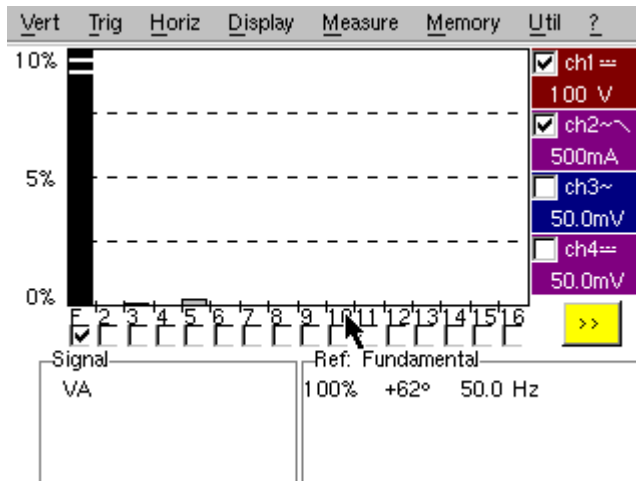

The representation of output harmonics is signed.

A black color harmonic indicates a harmonic received (positive by convention).

A light color harmonic indicates a harmonic emitted (negative by convention).

The phase value is measured between the voltage value and current value for a given harmonic.

Harmonic Analysis Mode (cont'd)

Composition

In this mode, the display is divided into 4 functional areas:

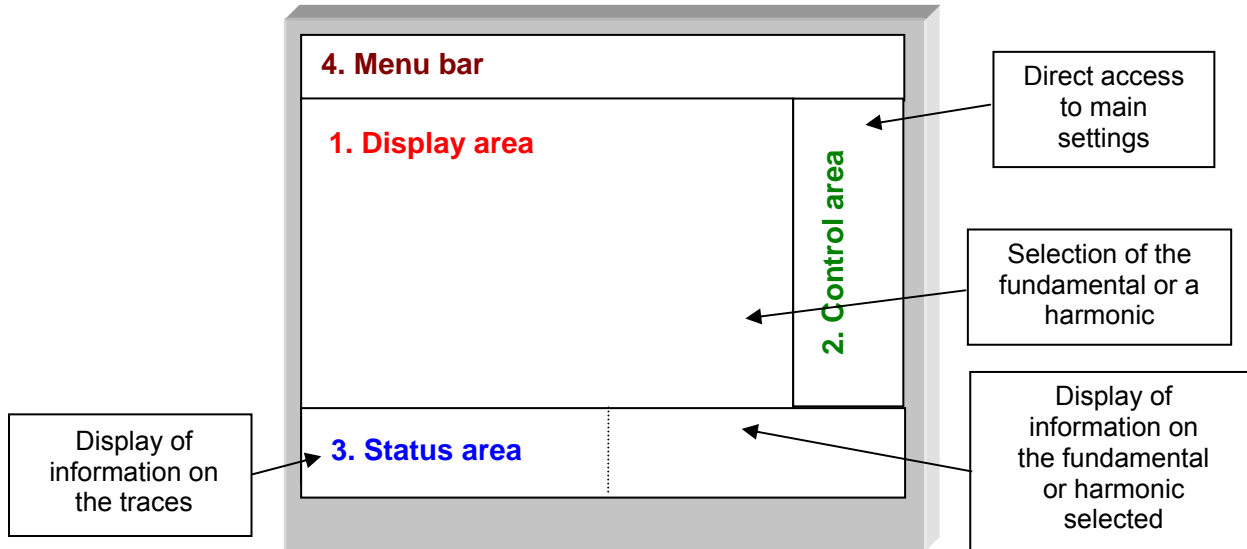

1. Display area

Displays the result of harmonic analysis of the selected traces.

The harmonic analysis of the **ch1** and **ch3** trace is shown in a darker color, while the trace of **ch2** and **ch4** are displayed in a lighter color (or the same color as the trace).

The display appears as a bar chart, with its vertical axis graduated in terms of the percentage of the fundamental amplitude (from 0% to 100% every 25%).

The horizontal axis represents the harmonics, i.e.:

- the fundamental (F) and the first 15 consecutive harmonics
- the fundamental (F) and the even harmonics from 2 to 30
- the fundamental (F) and the odd harmonics from 3 to 31



Use this button to display another series of harmonics:

Consecutive harmonic ranges

- from 2 to 16,
- from 17 to 31,
- from 32 to 46,
- from 46 to 61

Even harmonic ranges

- from 2 to 30,
- from 32 to 60

Odd harmonic ranges

- from 3 to 31,
- from 33 to 61

With this breakdown of the harmonics, the stylus can be used to select the fundamental (F) or one of the harmonics ( Example: Ref. Harmonic 5) to perform automatic measurements on the selected element.

- The "✓" symbol indicates the harmonic selected.
- See §. "Display" Menu for selection of the harmonics.

Harmonic Analysis Mode (cont'd)

2. Control area

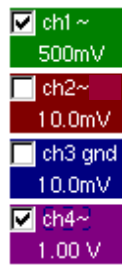

Using the stylus, display of:
the parameters of the traces in the same color as the trace: validity, coupling, bandwidth limit, sensitivity



- When the pointer is placed on one of a channel's parameters, it directly opens the associated "Sensitivity/Coupling" and "Vertical Scale" menus.
- The pointer validates the channels.
- The "✓" symbol indicates whether the channel is selected.

3. Status area

The status area indicates the automatic measurements performed on the signals and the selected harmonic.

Signal		Ref. Harmonic 3			
ch1:	1.24 V thd=0%	0%	+19°	2.40kHz	1.73mV
ch2:	---- thd=----	----	----	----	----
ch3:	---- thd=----	----	----	----	----
ch4:	2.47 V thd=47%	33%	-1°	2.25kHz	745mV

Display of information on the traces

Display of information on the fundamental or the harmonic selected

The "SIGNAL" area

This indicates:

- the active channel(s): **ch1** to **ch4**, (- - -) when the channel is not active
- the RMS voltage of the signal in V
- the harmonic distortion rate (THD) in %

$$THD = \frac{\sqrt{V_{RMS}^2 - V_f^2}}{V_f}$$

The "Ref.: Fundamental » or "Harmonic X" area

This indicates, for the fundamental or the selected harmonic, (Example: Ref. Harmonic 3):

- its value as a % of the harmonic of the strongest amplitude
- its phase in ° in relation to the fundamental
- its frequency in Hz
- its RMS voltage in V

4. Menu bar



The same menu toolbar is used as in "Oscilloscope" mode; some menus are adapted to the "Harmonic Analysis" mode and the others are not active.

Harmonic Analysis Mode (cont'd)

The "Vert" Menu

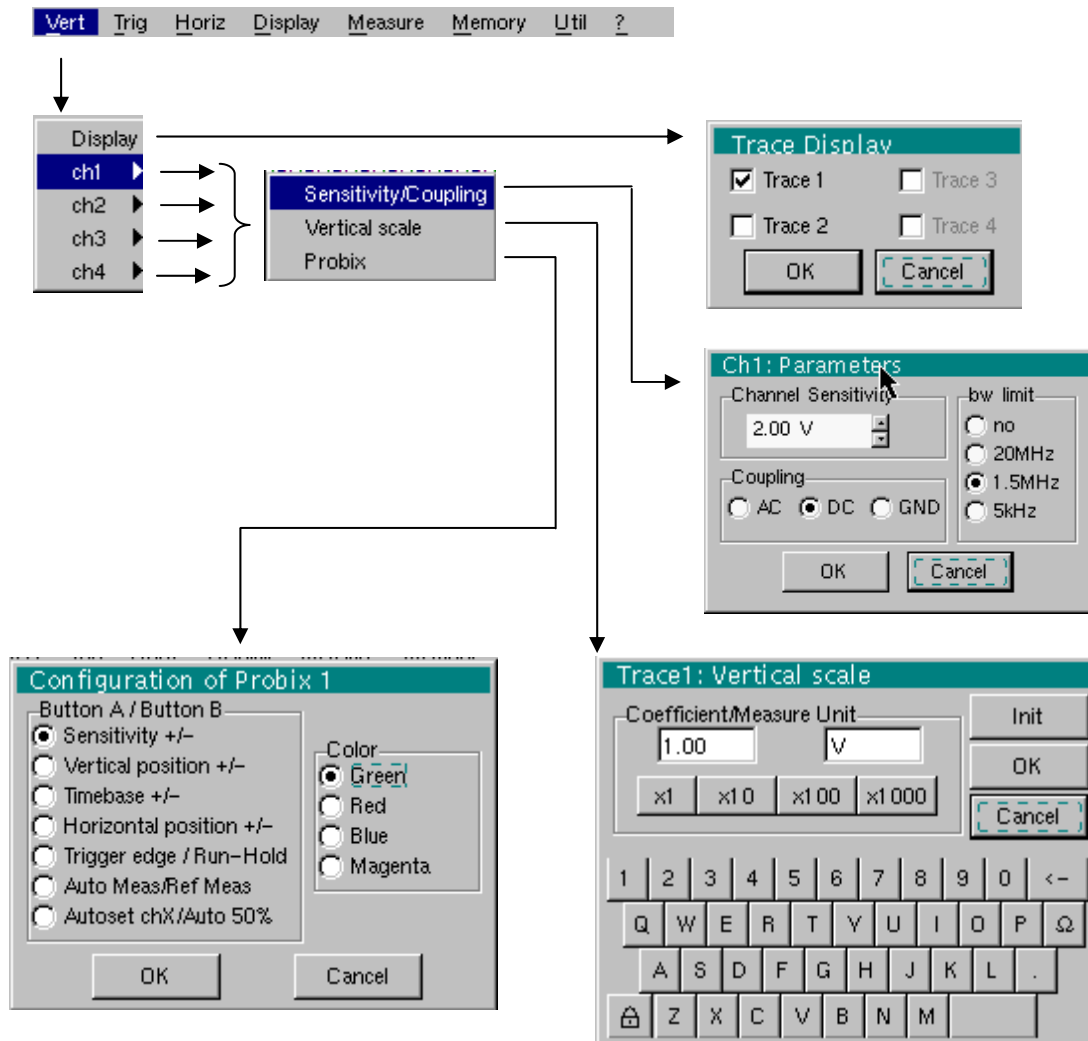

Display

When selected, this opens the "Trace display" menu for validating or invalidating the traces.

Validation of the selections by "OK". Exit from the menu without modification by "Cancel".



- The "✓" symbol in front of a trace indicates that it has been validated.
- The harmonic analysis of the signal on channel **ch1** and **ch3** is shown in a dark color, while the signal of channel **ch2** and **ch4** is lighter.
- In Harmonic Analysis mode, only the channels (and not the functions) can be the subject of harmonic analysis.

Harmonic Analysis Mode (cont'd)

ch1
ch3

ch2
ch4

Modification of the parameters of **ch1**, **ch2**, **ch3** or **ch4**, independently.

Sensitivity/Coupling

Channel Sensitivity

Modification of the channel's sensitivity using the stylus on the scrollbar: from 2.5 mV to 200 V/div.



The sensitivity is indicated in the channel parameter display area. It takes into consideration the parameters of the "Vertical scale" menu.

Coupling

Modification of **AC - DC - GND** coupling

AC: blocks the DC component of the input signal and attenuates the signals below 10 Hz

DC: transmits AC and DC components of the input signal

GND: the instrument connects the selected channel input to a 0 V ref. level.





The "⊙" symbol indicates the coupling selected. It is shown in the modified channel parameter display area.

bw limit

Bandwidth limit for the channel and its trigger circuit, to reduce display noise and false triggering.



The bandwidth limit of each channel can be limited to 5 kHz, 1.5 MHz or 20 MHz. The bandwidth limit of a channel is displayed in the control area by the following symbols :

 20 MHz  1.5 MHz  5 kHz



This menu can also be called up by double-pointing with the stylus on the required channel parameter display area (ch1, ch2, ch3 or ch4).

Vertical scale

Defines the vertical scale of the selected channel on the basis of the current settings.

Coefficient

Assignment of a multiplication coefficient to the selected channel's sensitivity. This can be modified with the stylus, using the table of usable numbers, after selecting the "Coefficient" area.

The  key deletes the character preceding the cursor in this area.

Predefined values (x1, x10, x100, x1000), corresponding to standard probe coefficients, can be assigned directly.



The sensitivity value indicated in the channel parameters display will be modified in accordance with the coefficient.

Measurement unit

Modification of the selected channel's vertical scale unit.

This modification is performed using the mouse and the table of usable characters, after selecting the "Measure Unit" zone.

The  key can be used to delete the value preceding the cursor in the zone to be modified.



The vertical scale unit will be indicated in the modified channel's parameter display.

Init

Reinitializes the multiplication coefficient to 1.00 and returns to the V measurement unit.



This menu can also be called up by double-pointing with the stylus on the required channel parameter display area (ch1, ch2, ch3 or ch4).

Probix

This menu is identical to the one in "Oscilloscope" mode.

With the **Probix** HX0030 probe (1/10 probe), some functions are inactive in "Harmonic Analysis" mode.

Harmonic Analysis Mode (cont'd)

The "Horiz" Menu



Fundamental freq: AUTO
Fundamental freq: ~50Hz
Fundamental freq: ~60Hz
Fundamental freq: ~400Hz

In "Automatic fundamental frequency search" mode, the instrument analysis the signal on the range [40Hz 1kHz].

If this search is not successful, you can indicate one of three frequencies proposed to the instrument. The instrument will then search for the fundamental based on this central frequency.



In particular, the manual indication (approximate) of the signal frequency, allows the analysis of its harmonic composition, for which the fundamental one is not the highest row of amplitude (e.g.: systems of control of engine by variations of frequency).

No averaging
Averaging coeff.: 2
Averaging coeff.: 4
Averaging coeff.: 16
Averaging coeff.: 64

An averaging coefficient can be used to improve the display.

When this coefficient is selected, it attenuates the random noise observed on a signal.

The calculation is performed using the following formula:

$$\text{Pixel}_N = \text{Sample} * 1/\text{Averaging Coeff.} + \text{Pixel}_{N-1} (1-1/\text{Averaging Coeff.})$$

with:

- Sample: value of new sample acquired at abscissa t
- Pixel N: ordinate of the pixel with abscissa t on the screen at instant N
- Pixel N-1: ordinate of the pixel with abscissa t on the screen at instant N-1



The "✓" symbol indicates the averaging coefficient selected.

Harmonic Analysis Mode (cont'd)

The "Display" Menu

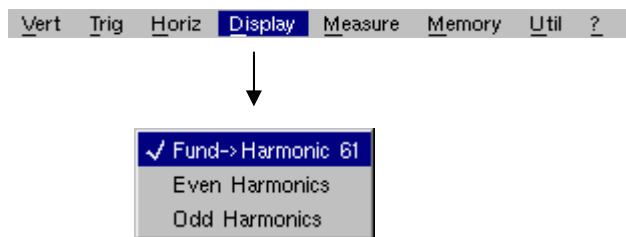

These menus allow you to view the harmonic composition of one or more selected signals, according to 3 groups.

Fund->Harmonic 16 Display of the fundamental and the first 15 consecutive harmonics.

Even harmonics Display of the fundamental and the even harmonics from 2 to 30.

Odd harmonics Display of the fundamental and the odd harmonics from 3 to 31.

The selection appears under the composition display.

- The “✓” symbol, present on the fundamental (F) or one of the harmonics, indicates the one selected.
- *The selection is kept when the display changes.*

The "Measurement" Menu

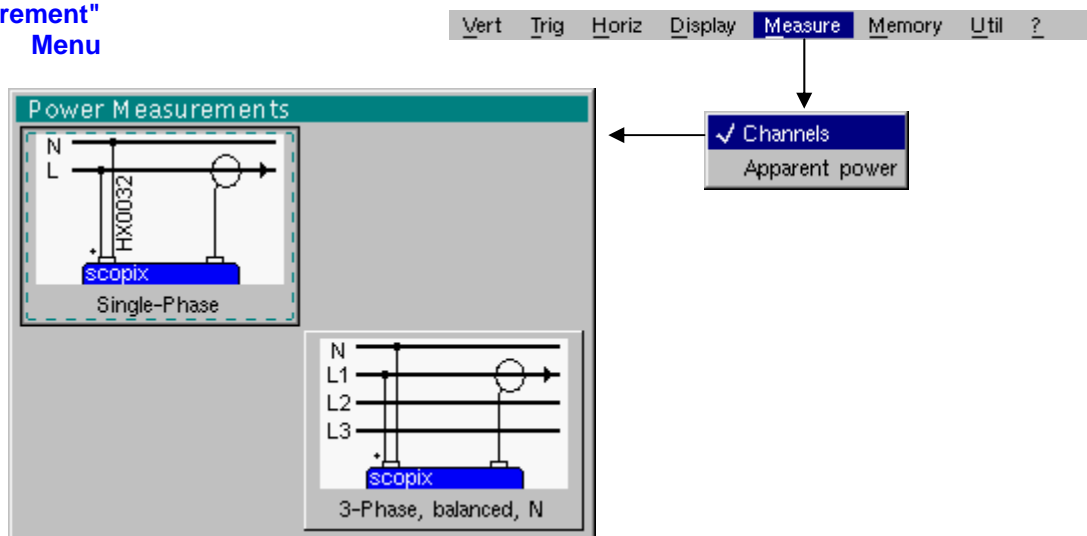

Channels The harmonic representation and associated measurements are made on active channels

Apparent output The harmonic representation and associated measurements are made on output.
By selecting this option, a window is displayed to indicate the channels used for current and voltage measurement in the configuration of desired measurement.

Harmonic Analysis Mode (cont'd)

The "Memory" Menu

See description in "Oscilloscope" mode.
In "Harmonic Analysis" mode, this menu is limited to saving and recalling the instrument configuration.

The "Util" Menu

See description in "Oscilloscope" mode.

The "?" Menu

See description in "Oscilloscope" mode.

Recorder Mode



It is best if the oscilloscope is plugged into the mains to operate in this mode (battery life).

The Keys



This key selects “**Recorder**” mode.

5 “UTILITY” keys (or keypad)



LCD **light** setting (see “Oscilloscope” mode).



Full screen display (see “Oscilloscope” mode).



Take a **screen shot** (see “Oscilloscope” mode).



No action.
(Pressing this key displays the message: “Impossible in this mode!”).

1 “AUTOSET” key



No action.
(Pressing the key displays the message: “Impossible in this mode!”).

Selective “AUTOSET”



No action.
(Pressing the key displays the message: “Impossible in this mode!”).

4 “TRIGGER” keys



No action.
(Pressing the key displays the message: “Impossible in this mode!”).



Successively pressing the key toggles through the different types of **trigger** of the last channel selected (see § Trigger Menu).



No action.
(Pressing the key displays the message: “Impossible in this mode!”).



This key has two functions:

RUN = launches an acquisition

HOLD = stops an acquisition

If the recorder is in memory display (see §. Memory Menu → Recall “.REC”), the message “Impossible in this mode!” appears when this key is pressed.

Recorder Mode (cont'd)

3 "MEASURE" keys



Particular case

The 19 **automatic** measurements of the reference trace are displayed (see "Oscilloscope" mode).

In "fault capture" mode, if the screen shows several faults at once, the "automatic measurement" function is impossible and the message "Impossible in this mode!" is displayed.



Selection, from the traces displayed, of the **reference** trace for automatic and manual measurements (see "Oscilloscope" mode).



No action.

(Pressing the key displays the message: "Impossible in this mode!").

3 "HORIZONTAL" keys (or keypads)



Setting of **recording** time and **sampling** interval.
These two values are correlated.



- Fault capture is **not selected**:

- ↳ After zooming in, the "Z-Pos." setting modifies the position of the screen in the acquisition memory.

- Fault capture is **selected**:

- ↳ If the horizontal zoom is activated, the "Z-Pos." setting allows the user to move through the faults one at a time. The main cursor is positioned on the displayed fault while the auxiliary cursor is on the right of the screen.



- Action identical to that in "Oscilloscope" mode, when fault capture and is **not selected**.

- Fault capture is **selected**:

- ↳ 1st press: "Zoom on" → displays the first acquired fault.

The main cursor is positioned over the trigger, on the magnified fault while the auxiliary cursor is on the right of the screen.

- ↳ 2nd press: "Zoom off" → 10 consecutive faults are displayed on the screen. The cursors are no longer displayed.

Definition of terms used
(id. "Oscilloscope" mode)

Validated channel: Display enabled, trace displayed after RUN

Displayed channel: Channel validated, trace present on the screen

Selected channel:



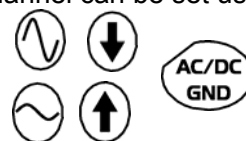

The parameters of this channel can be set using the following keys:





Recorder Mode (cont'd)

5 "VERTICAL" keys (or keypads)

OX 7xx4

Stage 1	Stage 2	Stage 3
Before pressing one of the keys shown opposite:	Press 	After pressing one of these keys:
The signal concerned is not displayed.		The signal is displayed and selected.
The signal concerned is displayed but not selected.		The vertical sensitivity and vertical position are allocated to the selected channel.
The signal concerned is displayed and selected.		The signal is erased by double pressing.
		

OX 7xx2

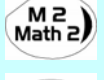
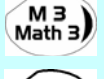
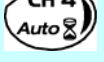
Stage 1	Stage 2	Stage 3
Before pressing one of the keys shown opposite:	Press 	After pressing one of these keys:
The signal concerned is not displayed.		The signal is displayed and is selected.
The signal concerned is displayed, but not selected.		On CH1 and CH4, the vertical sensitivity and vertical position are allocated to the selected channel.
The signal concerned is displayed and selected.		The signal is erased by double pressing.
		



Deselecting the signal: 2 short taps on the key concerned (see opposite).



A long press does not trigger a vertical autoset. After a long press the message: "Impossible in this mode!" appears.



This key enables or disables the **horizontal dividing into 2 parts** of the display area (see "Oscilloscope" mode).



No action.

(Pressing the key displays the message: "Impossible in this mode!").

In "Recorder" mode, the DC input coupling is constant. The DC symbol  is permanently displayed.



To set the vertical **sensitivity** of the last channel selected (see "Oscilloscope" mode).



To set the vertical **position** of the last channel selected (see "Oscilloscope" mode).

Recorder Mode (cont'd)

Display

Normal mode display

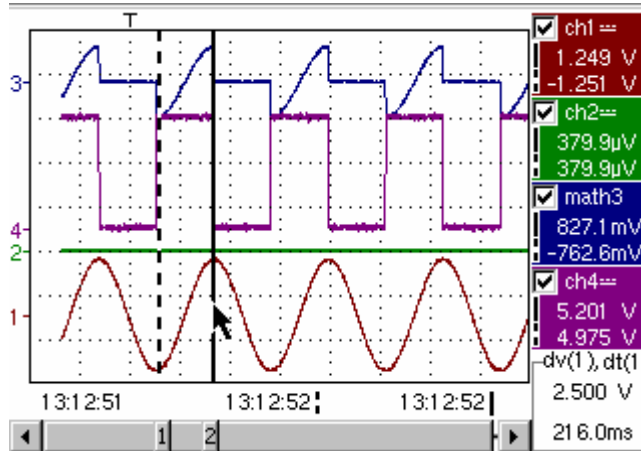

The user views 500 points on the screen (in "MIN/MAX" mode) to eliminate the risk of information loss involving the 50,000 points in the memory.

Display in fault capture mode

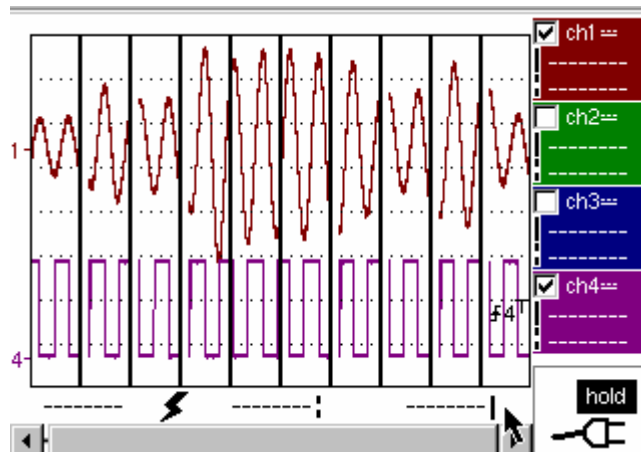

The memory is segmented to enable the acquisition of several defaults (10 defaults in the standard configuration and 100 if the EXTENDED ACQUISITION MEMORY option is installed).

Composition The composition of the "Recorder" mode display is identical to that in "Oscilloscope" mode.

Reminder: The display is divided into 4 functional zones.

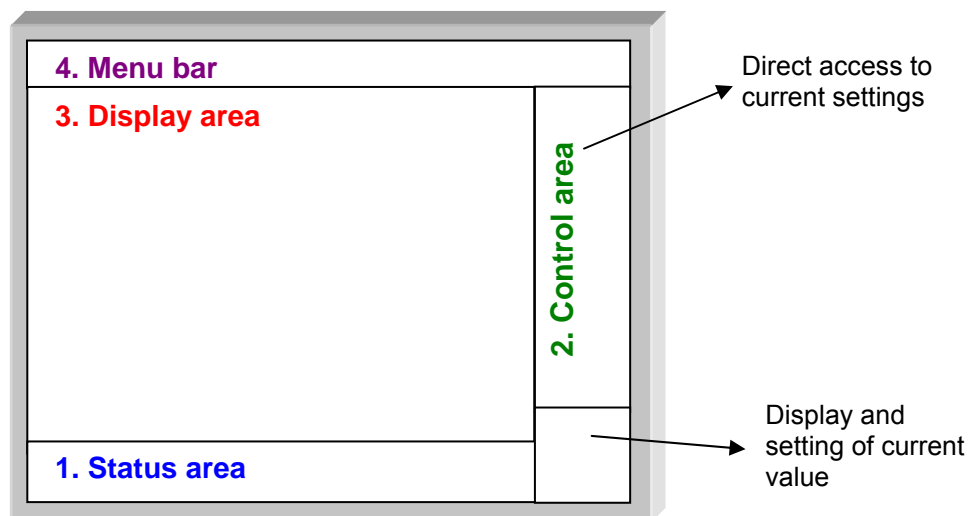

Recorder Mode (cont'd)

1. Status area

Three pieces of general information appear in this area:

- The **bargraph**, representing the screen position and the cursors in the acquisition memory;
- Instrument **settings** (fault capture mode, zoom, etc.);
- **Acquisition times:**
 - of the first sample that can be viewed,
 - of the sample under the main cursor,
 - of the sample under the auxiliary cursor.

Standard configuration

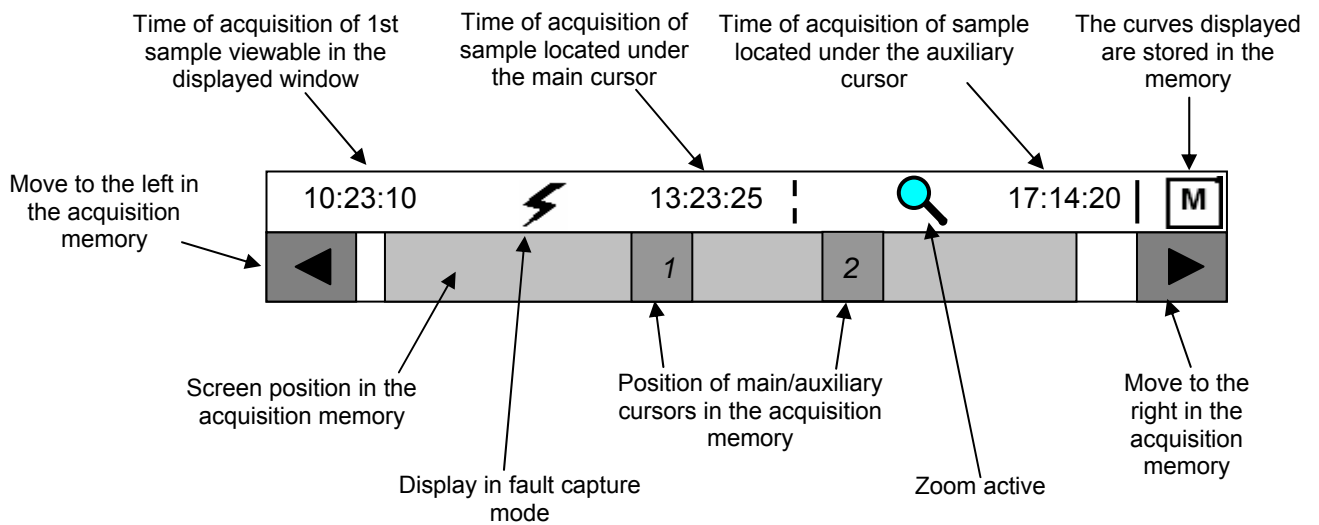

Configuration if delayed start-up is enabled

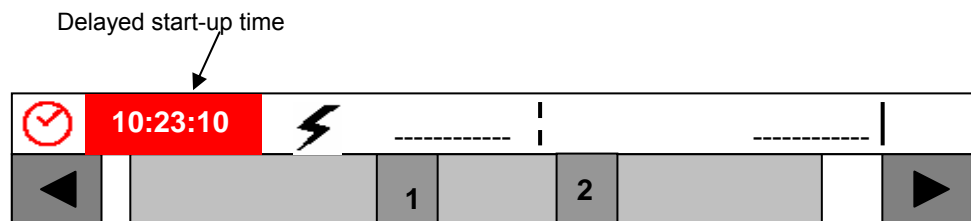

When the acquisition starts, the display returns to its standard configuration.

Recorder Mode (cont'd)

Bargraph

In fault capture mode, the bargraph indicates the position of the screen and cursors in the acquisition memory. The main cursor is positioned on the displayed fault and the auxiliary cursor on the right of the screen.

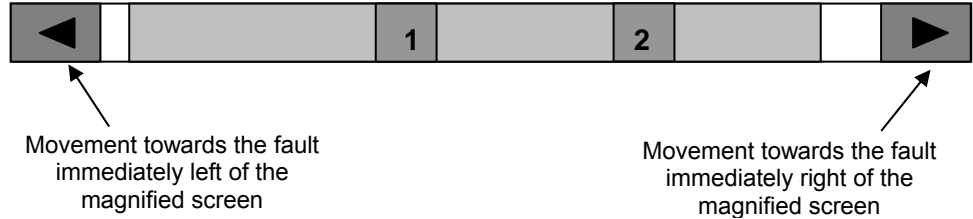

Settings

Signification of symbols appearing on the bargraph:



The recorder is in **fault capture** mode.



The horizontal zoom is active.



The curves displayed are stored in the memory.



Delayed start-up is activated.

10:23:10

This symbol is displayed only when delayed start-up is active. It indicates the time at which recording will commence. Start-up date: see §. Trigger Menu → Delayed start-up.

Acquisition times

These represent the times of: - the first sample viewed;
- the sample located under the main cursor;
- the sample located under the auxiliary cursor.

2. Control area

- Parameters of each channel and trace:
 - display
 - coupling
 - bandwidth limit,
 - zoom function,
 - vertical measurements of samples under the main and auxiliary cursor.
- Active adjustment of the last selected element:
 - trigger level (main and auxiliary),
 - horizontal gap between the time position of the auxiliary cursor and that of the main cursor,
 - vertical gap between the measurement of the auxiliary cursor and the main cursor on the reference trace (see §. Menu → Measurement → Reference),
 - number of faults acquired and number of fault viewed,
 - duration of recording and acquisition interval.



The time position of the trigger is not displayed as it is fixed (20% of the memory). The horizontal scale is not displayed.

- The device indicates if the acquisition is in RUN or HOLD mode.
- The other displays (battery, etc.) are identical to “Oscilloscope” mode.

Recorder Mode (cont'd)

2. Control area (cont.)

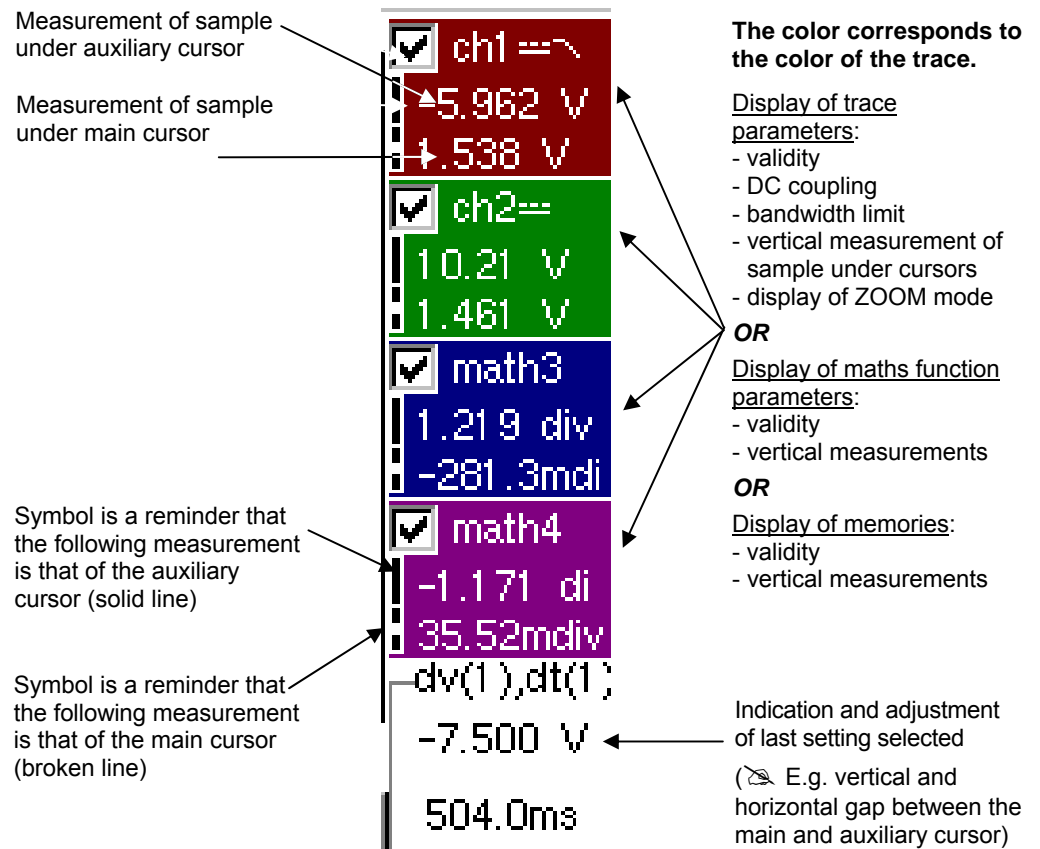

- The use of controls,
- the validation of channels with the stylus,
- the menus relating to the channels and functions are identical in "Recorder" and "Oscilloscope" mode.





It is not possible to mix memorized curves (Mx) and acquired curves in real-time Chx on the display (see § Memory Menu → Trace → Recall ".REC").

Recorder Mode (cont.)

3. Display area Graphic elements displayed associated with the traces in this area:

- Vertical position indicator for the reference level of each trace
- ZOOM area selection.
- Main cursor (permanent, moved using stylus) located at the left of the screen by default.
- Auxiliary cursor (permanent, moved using stylus) located at the right of the screen by default.
- Trigger time position indicator (fixed and located 20% across from the left of the screen).
Its graphical representation is as follows : 

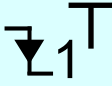
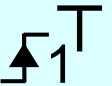
Level indicators representing 5 different triggers:

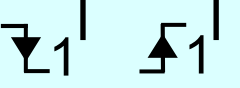
	- “ Lower trigger” option (of the last channel selected).
	- “ Upper trigger” option (of the last channel selected).
	- “ Upper/lower trigger” option (of the last channel selected).
	- “ External window trigger” option (of the last channel selected).
	- No symbol is displayed: no trigger (on the last channel selected).

 **The level indicator figure represents the channel concerned by this indicator:**

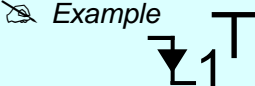
 Example	- Lower trigger option on channel 1. There can be trigger conditions on several channels at the same time: display by selecting the channel concerned.
---	---

 **In fault capture mode, the grid is divided into ten sections; i.e. one section for each fault.**



The cursors are no longer displayed: they reappear when a single fault is displayed on the screen (horizontal zoom enabled: see help for key shown here).

Recorder Mode (cont'd)

Display elements

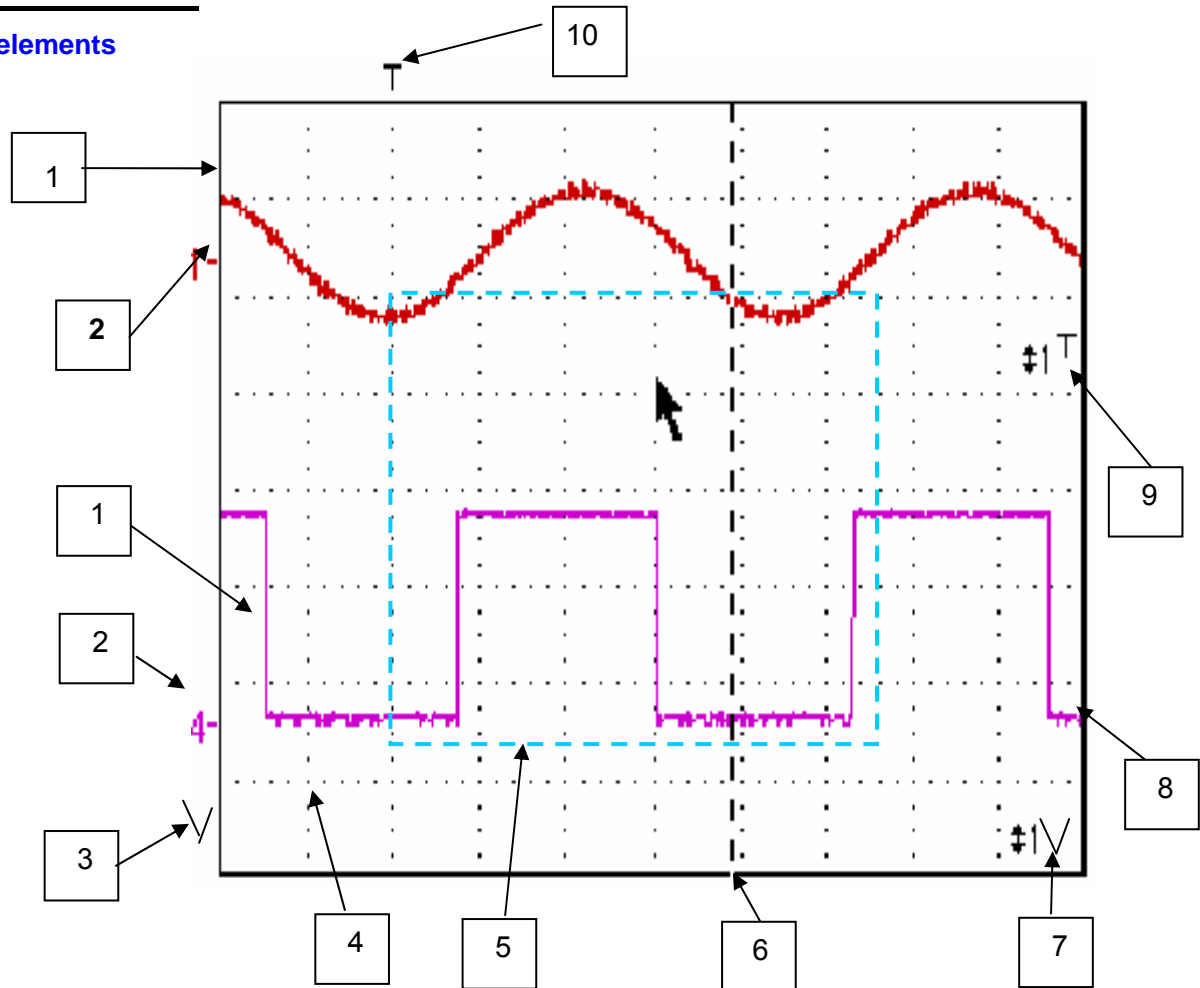

Definition of display

Items	Display elements
1	Trace displayed
2	Indication of vertical position of reference level of the displayed trace and identification of trace number
3	Indicator of trace outside display window
4	Graticule division
5	Zoom area selection
6	Main measuring cursor
7	Trigger level position outside window indicator
8	Auxiliary measuring cursor
9	Trigger level position indicator (<i>here, for example: upper/lower trigger</i>)
10	Trigger time position indicator → fixed at 20%

Recorder Mode (cont'd)

Menu accessible from display area

Like in "Oscilloscope" mode, the menu concerning the display can be opened directly by double-tapping with the stylus in the display area.

This menu, as well as the functions of the proposed options, are identical to those in "Oscilloscope" mode.

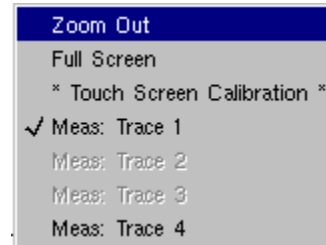

Zoom creation in Fault Capture mode

Case 1 The horizontal zoom is disabled, the screen displays 10 faults:

Draw a rectangle around the part you wish to zoom in on. The screen displays, with a vertical zoom, the fault on which you began the rectangle.

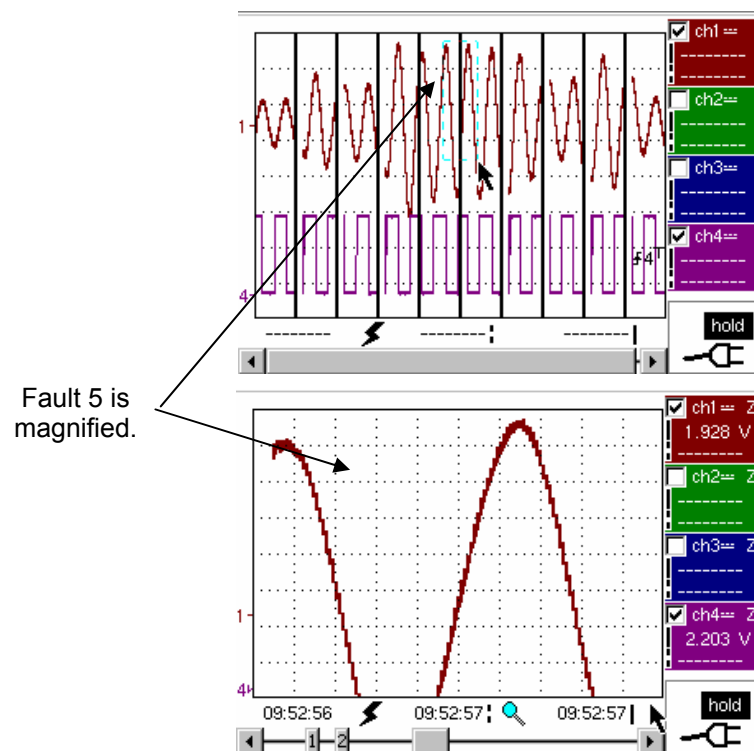

Fault 5 is displayed in full screen mode and has been vertically magnified

To return to a normal display (10 faults displayed on the screen), select "Disable zoom" in the menu,

Disabling the horizontal zoom with the zoom ON/OFF key allows the user to return to a screen with the ten faults displayed, while not disabling the vertical zoom.

Recorder Mode (cont'd)

Case 2 The horizontal zoom is enabled, the screen displays one of the captured faults:

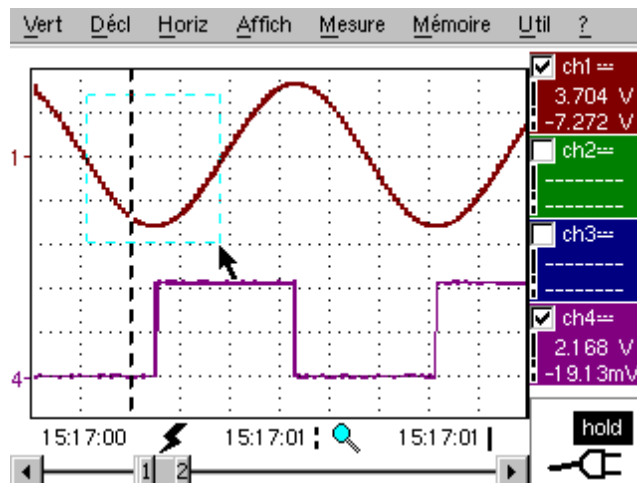

Fault capture mode: the horizontal zoom is enabled. A single fault is displayed on the screen. A zoom frame is drawn.

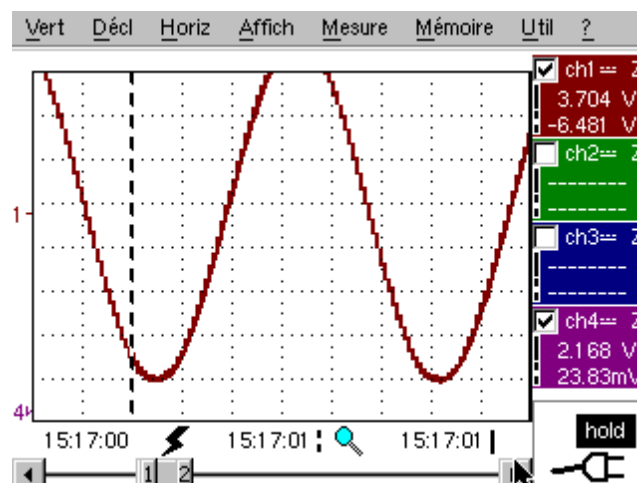

A vertical zoom is applied to the area containing the fault.

As in the first case, select “disable zoom” in the menu above to disable the zoom. The screen returns to the initial “10 faults on the screen” display.



Disabling the horizontal zoom with the zoom ON/OFF key allows the user to return to a screen displaying the ten faults, while the vertical zoom remains enabled.

Recorder Mode (cont'd)

The "Vert" Menu

This menu is identical to that described in "Oscilloscope" mode.

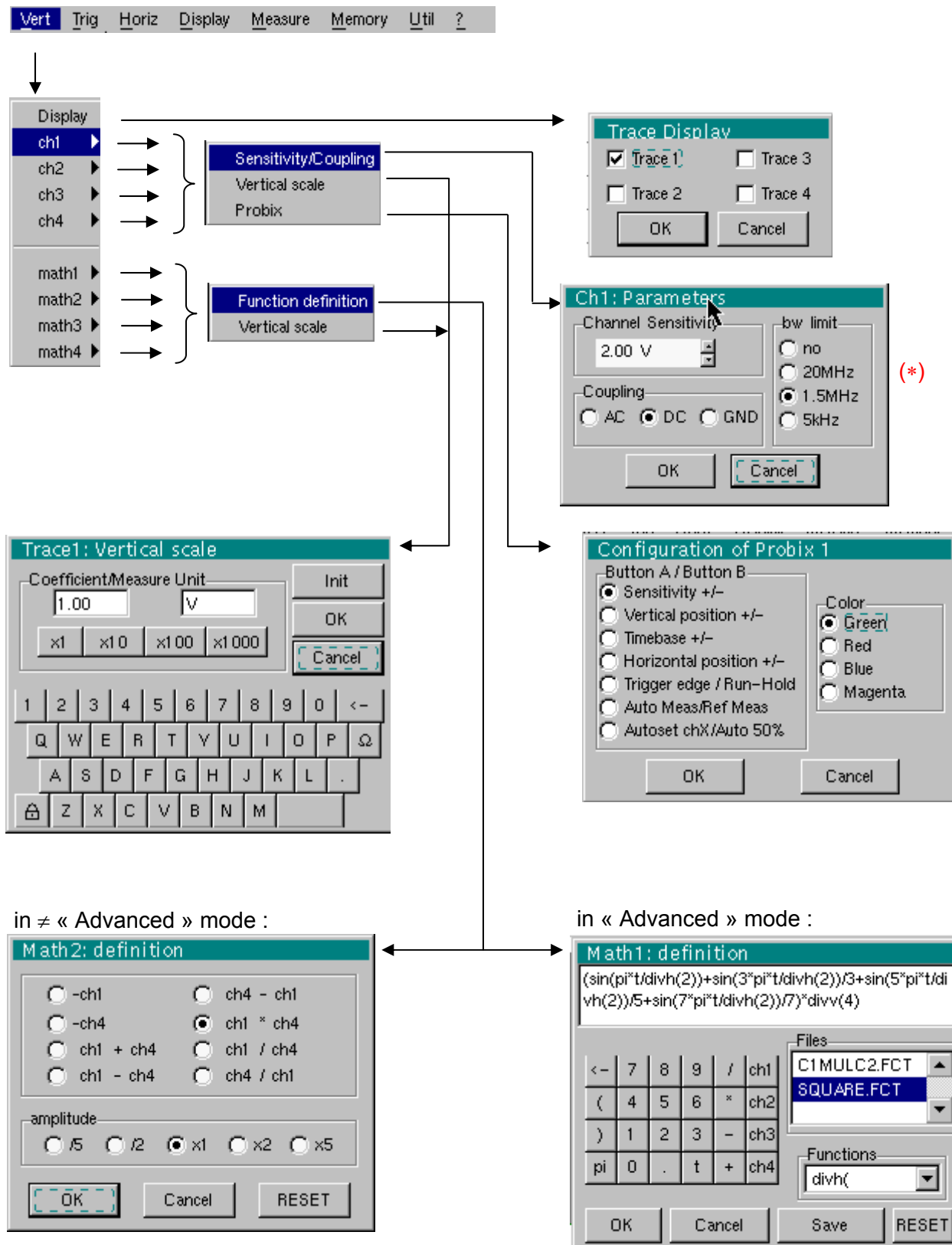

(*) The DC coupling is the only option in "Recorder" mode.

Recorder Mode (cont'd)

The "Trig" Menu

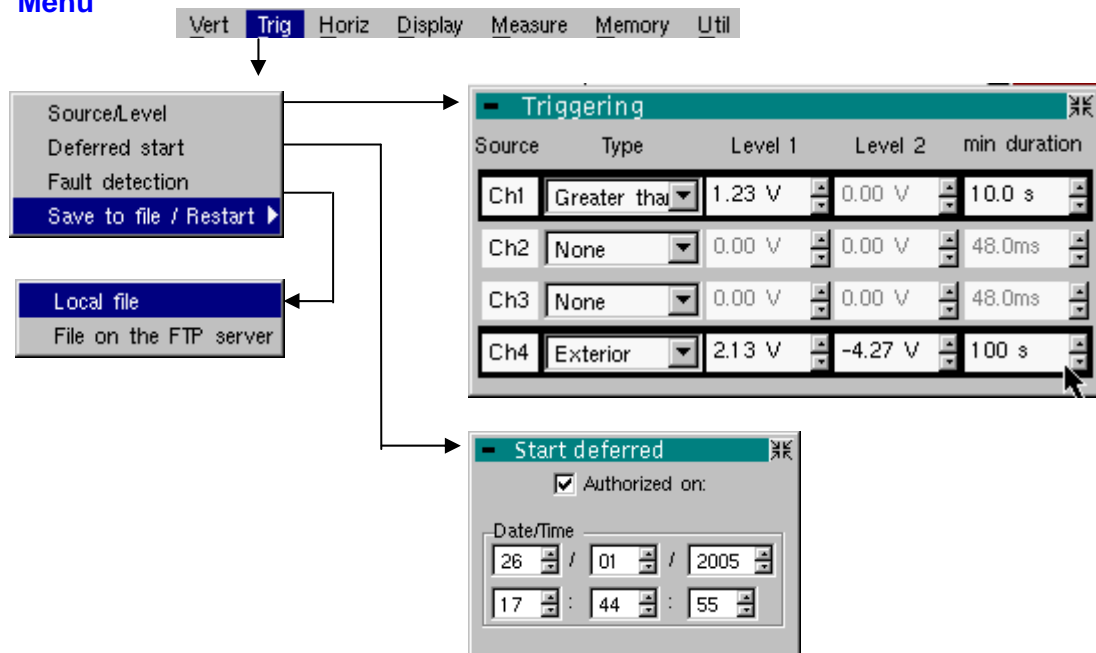

Triggering

Selection of trigger type and level on each channel. Triggering takes place if a condition described by a line of the "Trigger" table is verified. The trigger level should be defined in the channel measurement dynamic.

Source Indicates the channel number.

Type The type of trigger for each channel.

There are several possible types:

- None
- Lower than
- Higher than
- Lower/Higher
- Exterior

In "Recorder" mode, several conditions are monitored simultaneously.

Level 1 The main trigger threshold level can be set using the stylus.

Level 2 The auxiliary trigger threshold level can be set using the stylus. This tab is enabled only if external trigger type is selected.

min duration The fault will be evidenced if the fault condition defined by the type and thresholds is present for a parameterisable period from 3,2 ms to 670 ks according to the used time base (from 160 μ s to 670 ks if the ' EXTENDED ACQUISITION MEMORY option).

 *Trigger levels are entered into the current value display area after modification. Fine adjustment is possible.*

In « **Save to file / Restart** » :

- If no trigger source is enabled, the memory is saved as soon as the acquisition memory is full, then another acquisition is initiated.
- Otherwise: Roll on the memory, the old samples are lost, new ones are registered.

Recorder Mode (cont'd)

The Pretrig is monitored for each type of trigger.

"No trigger": if all the channels are in this mode, the device records indefinitely.

- **"Lower than"**: triggering takes place when the signal drops below the threshold.
- **"Lower/higher than"**: triggering takes place when the signal drops below or rises above the threshold.
- **"Higher than"**: triggering takes place when the signal rises above the threshold.
- **"Outside window"**: triggering takes place when the signal goes outside the window defined by the two thresholds.

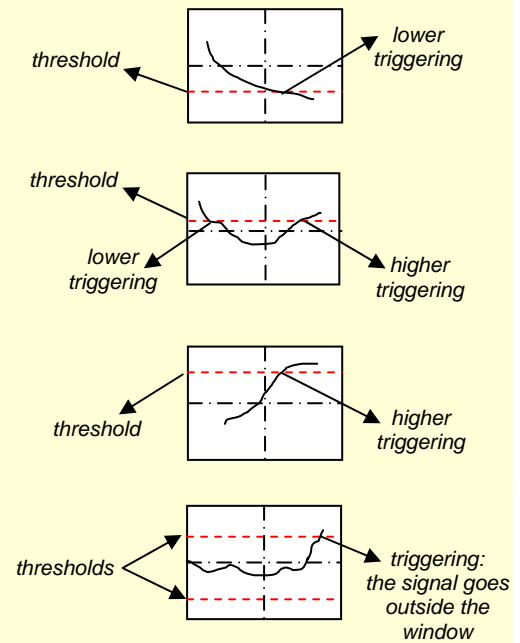

A half-division hysteresis is applied to prevent ill-timed triggers.

Example

- Channel 1 is set with a 1.25V "higher than" trigger.
- Channels 2 and 3 do not wait for a trigger.
- Channel 4 is set with an "outside" type trigger.
- Channel 1 and 4 lines are highlighted: they wait for a trigger.

Source	Level 1	Level 2	Type
Ch1	1.25 V	0.00 V	Less than
Ch2	0.00 V	0.00 V	No triggering
Ch3	0.00 V	0.00 V	No triggering
Ch4	2.13 V	-2.27 V	Exterior

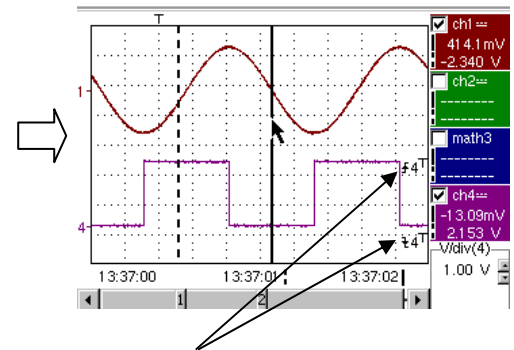

Outside trigger symbol for channel 4



Toggle through the trigger conditions for the different channels using the key shown opposite.

Save to file/Restart

If this option is activated, all the traces acquired are saved to a .REC file as soon as the acquisition memory is full, then acquisition is restarted.

Delayed triggering

Delayed triggering offers the possibility of starting up an acquisition at a date and time chosen by the user.

This option can be related to the previous trigger conditions.

Recorder Mode (cont'd)

Authorised on

This tab allows the user to validate – or not – delayed triggering.

- If the symbol "✓" is displayed, delayed triggering has been validated.
- If there is no symbol, delayed triggering has not been validated.

Use the stylus to validate or unvalidate the tab.



- *When delayed triggering has been validated, the user can no longer make an acquisition in recorder mode. He/she may, however, use the other modes as desired.*

If the user wishes to make an acquisition in recorder mode, he/she must:

- *either unvalidate delayed start-up,*
- *or wait until the delayed start-up acquisition begins.*

- *At the time the acquisition is set to start (delayed triggering time), the instrument must be in operation and the user must have enabled recorder mode.*

Date/Time

Different scroll boxes allow the user to set the date and time he/she wishes the acquisition to commence.

Use the stylus to scroll.

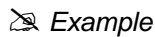

Example

Delayed triggering: the acquisition will commence on January 26, 2005 at 17:44. The red clock symbol shows the user that delayed start-up is enabled.

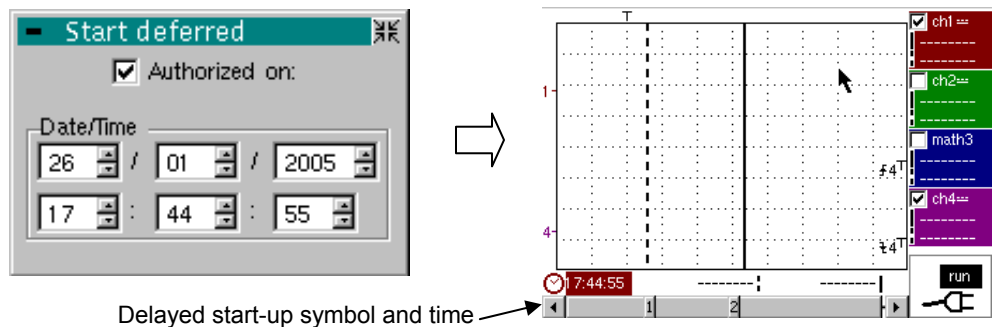

Fault capture

Fault capture mode enables 10 recordings of 250 samples to be made around the trigger point (or 100 recordings of 500 samples around the trigger point if the EXTENDED ACQUISITION MEMORY option is installed).

These 10 recordings will be displayed on the screen. Each recording is separated by a solid vertical line. They are recorded in volatile memory.

Recorder Mode (cont'd)

Fault capture (cont'd)

In 'Fault capture' mode, records are saved to the file as soon as 10 faults (or 100 faults with the EXTENDED ACQUISITION MEMORY) have been acquired. You can therefore save several acquisitions and analyse them later

The channels are saved in files, the name of which is determined according to the date and time they are saved.

They can be saved to an FTP server or in a local file system if the parameters of the FTP server have been configured ("UTIL" → "Config I/O ports" → "Network" menu).

 Example

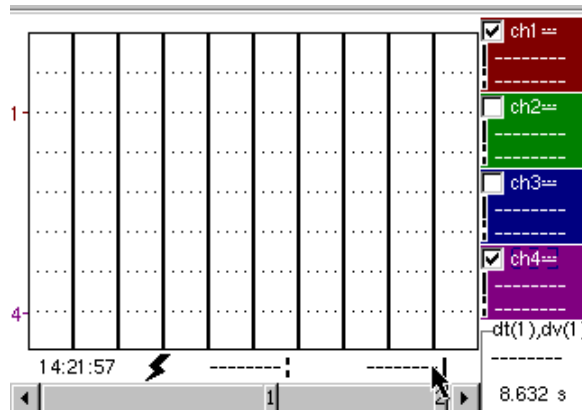
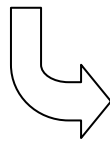
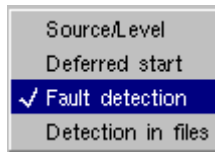

The fault capture mode is selected: the screen is divided into 10 sections.

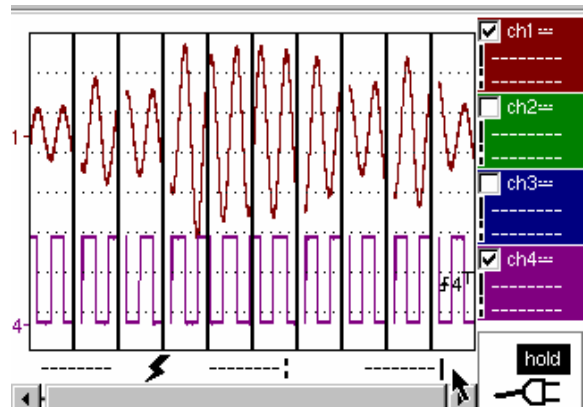

Display after an acquisition in fault capture mode

Recorder Mode (cont'd.)

Display (fault capture, file capture)

Two cases arise:

- the horizontal zoom is enabled,
- the horizontal zoom is disabled.

Horizontal zoom disabled

Modification of display:

- The cursors are no longer displayed.
- The measurements displayed do not have the same significance.
- All the measurements are related to the current recording.

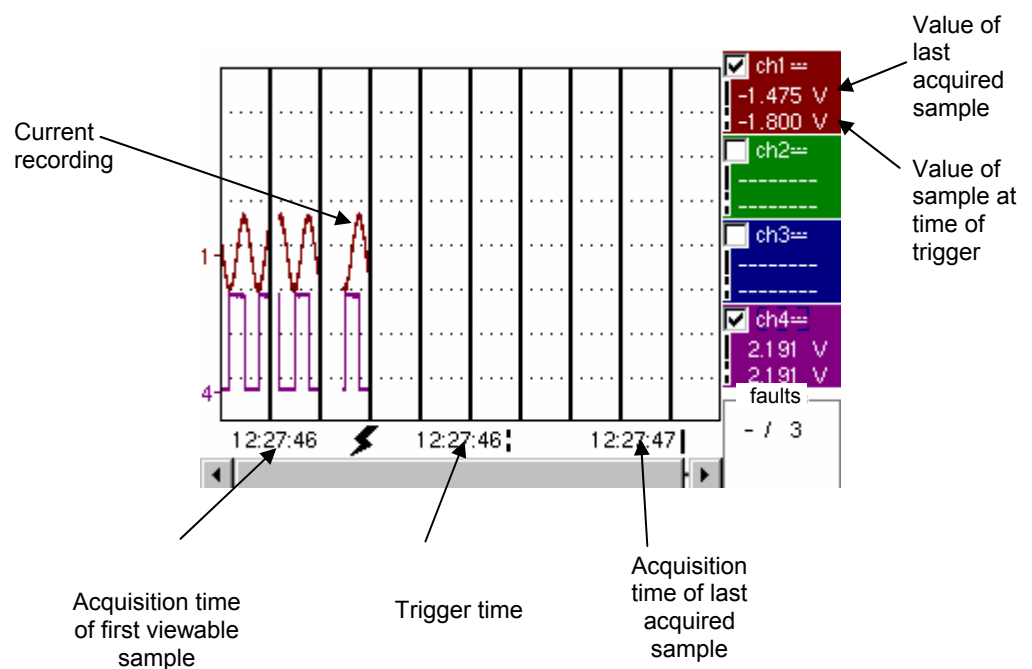

- "Trigger time" and "Sample value at trigger time" measurements are only displayed if the trigger has taken place.
- Maximum and minimum searches cannot be enabled (see §. Display Menu, p. 146).
- The automatic measures cannot be enabled (see §. Measurement Menu, p. 148).

Horizontal zoom enabled

The display is identical to normal mode.

- The measurements displayed have the same significance as in normal mode (see §. Display, p. 146).
- Maximum and minimum searches are possible (see §. Display Menu, p. 146).
- Automatic measurements can be enabled (see §. Measurement Menu, p. 148).

Recorder Mode (cont'd)

The "Horiz" Menu

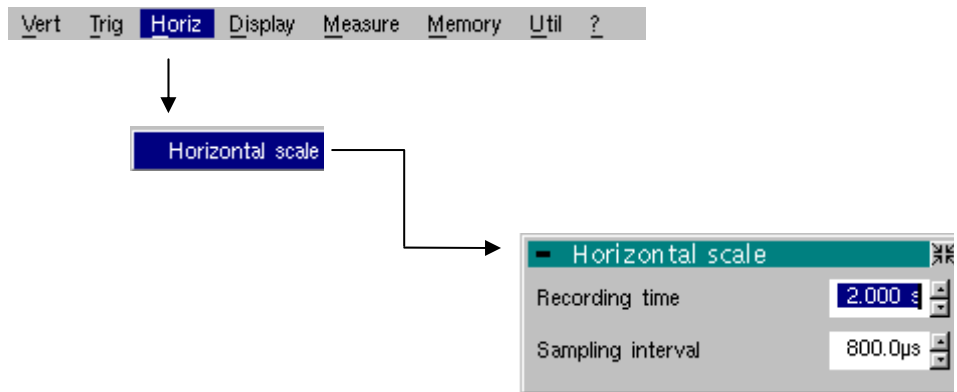

Horizontal scale

This function allows the user to set:

- the recording time,
- the acquisition interval.

These two values are correlated. When the user modifies one, the other is modified.

Adjust the scroll boxes with the stylus to set these values.



Recording time and sampling interval settings are also accessible via these keys.

Example The recording time is 30 seconds and the acquisition interval is 12 mins.

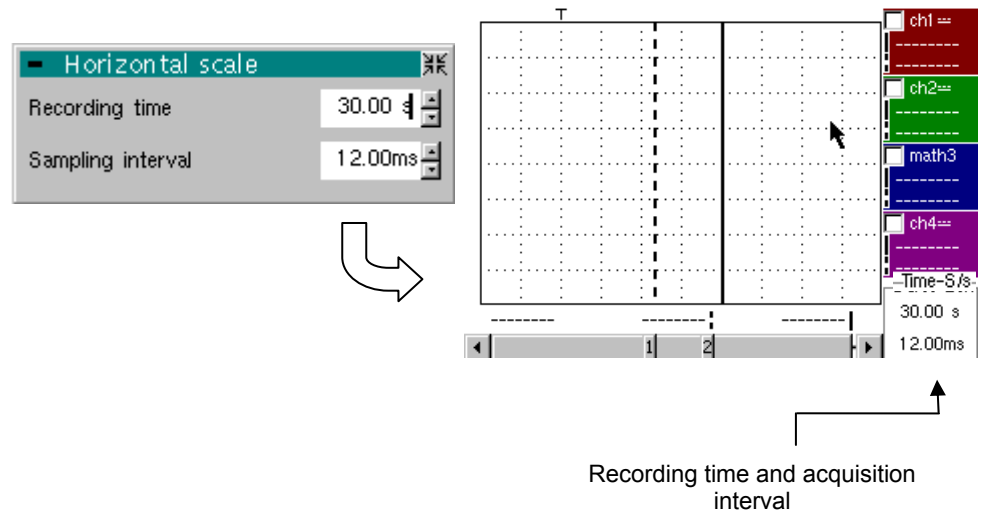

Recorder Mode (cont'd)

The "Display" Menu

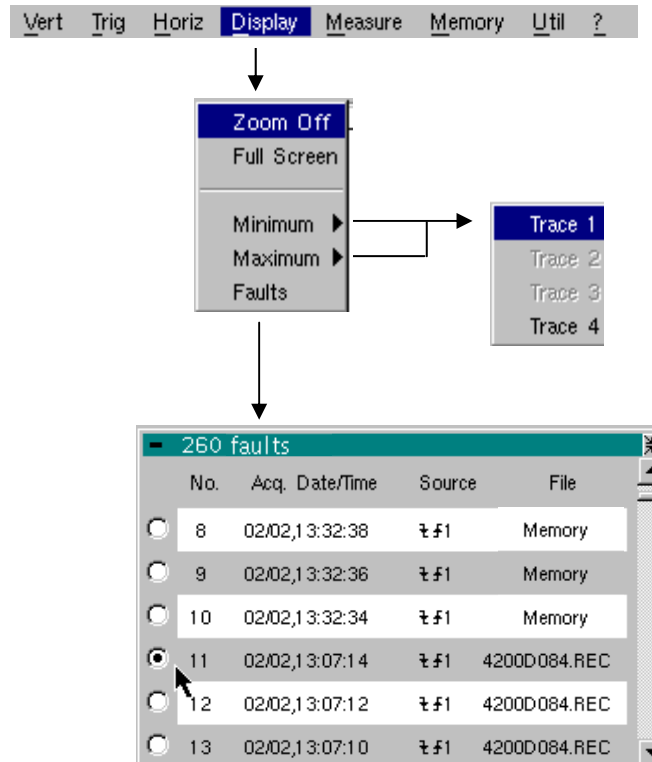

Zoom off



Returns to the original screen size after zooming in on part of the screen.

- This function is disabled unless the screen is in zoom mode.
- If the Zoom mode is active, the letter "Z" is displayed in the trace and time-base parameter display area.



This menu can also be called up by double-tapping with the stylus inside the curve display area.

Maximum/Minimum

The minimum (or maximum) option consists in:

- searching for the min (or max) value of samples on trace X;
- centring, if possible (zoom), the curve on this specific point. The main cursor is now fixed on this sample.

Particular case

Display of 10 faults on the screen when fault capture mode is validated and the horizontal zoom is not enabled: "Minimum/Maximum" functions cannot be used.

They are greyed out in this configuration.

Recorder Mode (cont'd)

Faults

The search for faults enables successive recordings in "fault capture" or "file capture" (memory) mode to be explored (.REC).

All files with a ".REC" extension are analysed and each fault is displayed. When one of these faults is selected, it is displayed on the screen. The main cursor is fixed at the fault's trigger point and the auxiliary cursor is placed at the right of the screen: the window is accessible from: Display → Faults.

Various information is provided in this window:

- **Title:** total number of faults contained in the memory
- **No:** fault number
- **Acq. date/time:** date (day, month) and time of fault acquisition
- **Source:** symbol for type of trigger used for this fault and source
- **File:** name of file in which the fault is recorded



The term "memory" in filenames means that the fault captured is in auxiliary storage. If a file is called anything other than "memory", all the faults in the "memory" file will be lost.

Example Following a file capture, the "Faults" option will allow the different recordings to be analyzed:

Fault n°11 in file selected:
4214ae6e.REC. Its triggering source is outside window. It was captured on 17 February at 14:47:08.

510 faults				
No.	Acq. Date/Time	Source	File	
<input type="radio"/>	8	17/02,15:17:00	f1	Memory
<input type="radio"/>	9	17/02,15:16:58	f1	Memory
<input type="radio"/>	10	17/02,15:16:56	f1	Memory
<input checked="" type="radio"/>	11	17/02,14:47:08	f1	4214ae6e.REC
<input type="radio"/>	12	17/02,14:47:06	f1	4214ae6e.REC
<input type="radio"/>	13	17/02,14:47:04	f1	4214ae6e.REC

Display of fault n°11 with the main cursor on the trigger point and the auxiliary cursor on the last sample acquired. The recorder is in memory display. To return to normal display, deselect Recall '.REC' in the Memory menu.

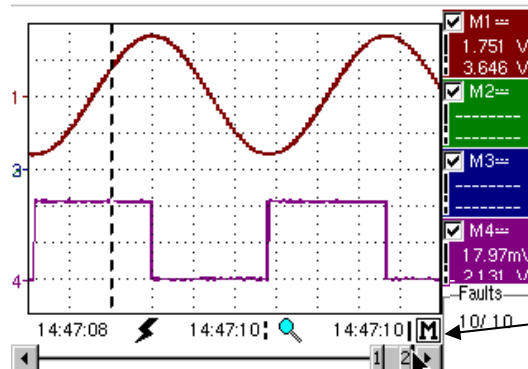

The symbol **M** is a reminder that the recorder is displaying a memory (.REC).

Full screen

Switches from normal display mode to "full screen" display mode and vice versa.

The display is organised so as to leave the biggest surface area possible for curve plotting: only the permanent settings remain, as well as the option to display the automatic measurement window.



- The "full screen" function has the same effect as the key shown opposite.
- The "✓" symbol indicates that the full screen mode is enabled.



This function can also be accessed by double-tapping the trace display area with the stylus.

Recorder Mode (cont'd)

The "Measure" Menu

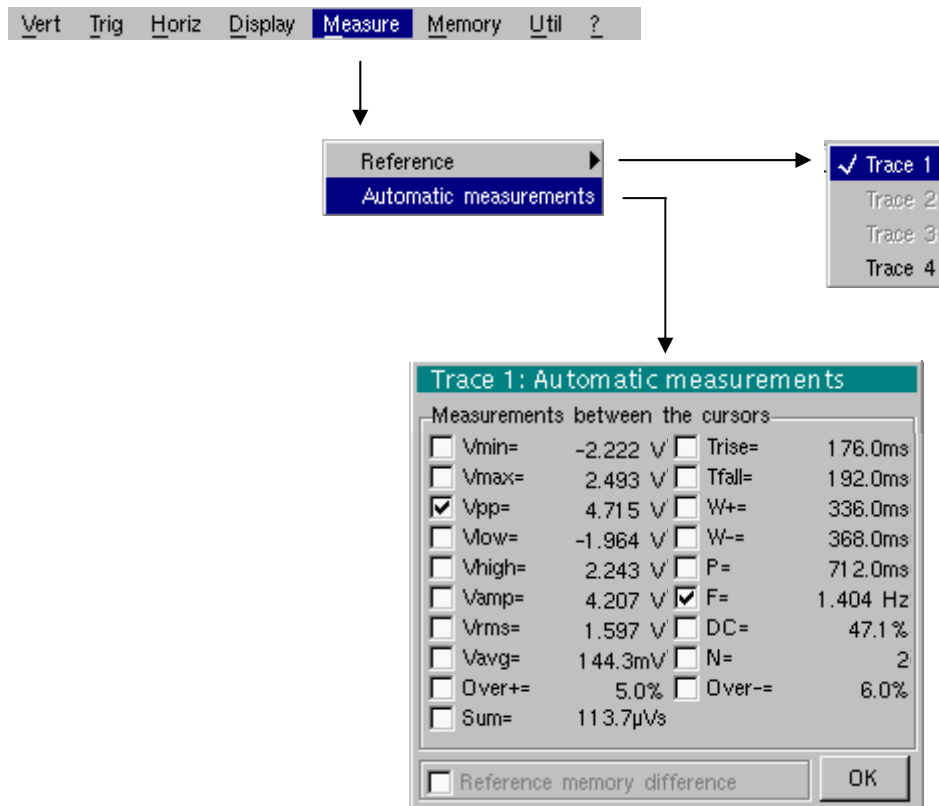

Reference

Trace 1
Trace 2
Trace 3
Trace 4

Identical to "Oscilloscope" mode.

Automatic measurements

This window is nearly identical to the one in "Oscilloscope" mode.

The automatic measurement calculation area is defined by the two cursors.

It is not possible to select measurements in order to display them in the status area.

Particular case

Display of 10 faults on the screen when fault capture mode is validated and the horizontal zoom is not enabled: the "automatic measurements" function cannot be enabled.

It is greyed out in this configuration.

Recorder Mode (cont'd)

The "Memory" Menu

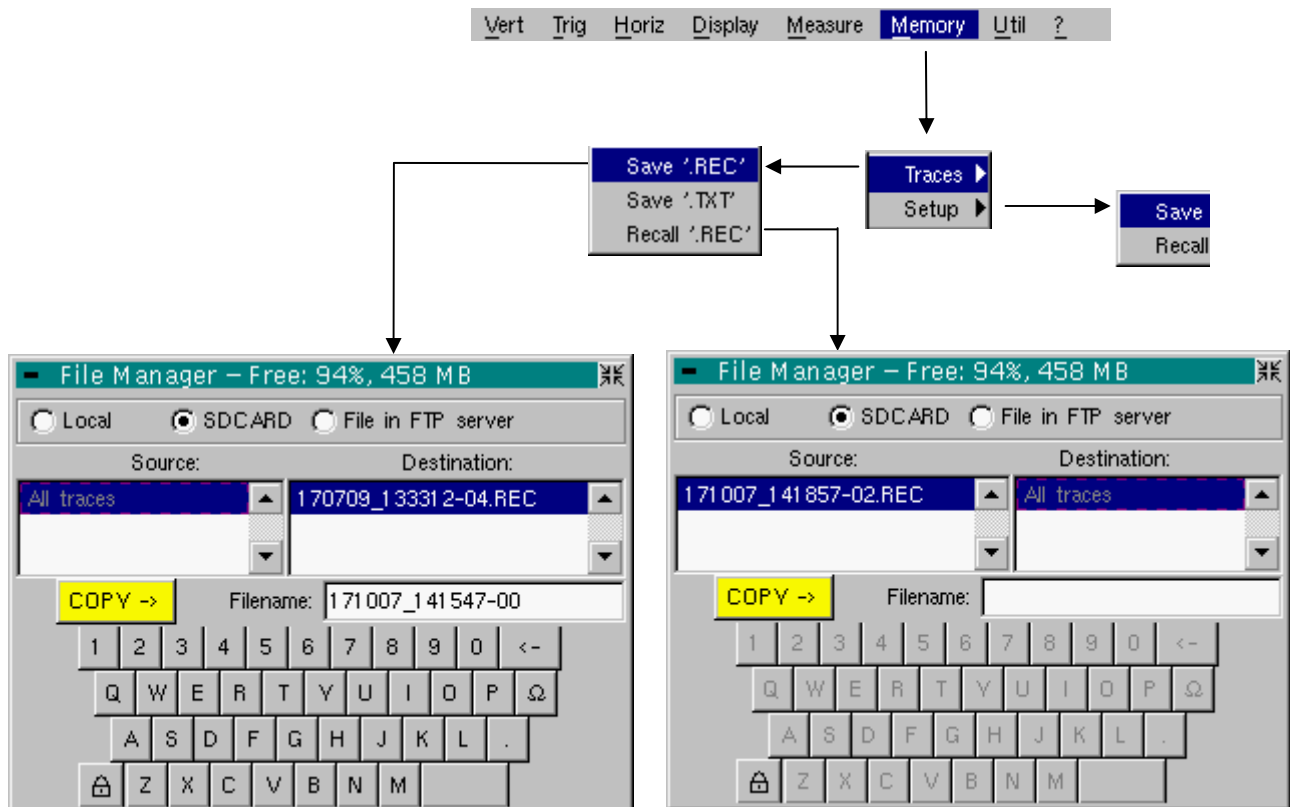

Trace

Save .REC In this mode, all the traces are saved in one file (extension .REC).

The selection opens a "File Copy" menu.

A default backup filename is proposed above the keyboard. It can be modified using the virtual keyboard and stylus. The ← key deletes the character preceding the cursor in this area.

Once the name has been entered, the → key saves the data, puts it into the "destination" list and closes the menu. The backup filename takes the extension .REC (format that can be reread on the instrument). The menu can be exited without backing up by tapping the icon in the top right-hand corner of the window with the stylus.

- *The filename is limited to a maximum of 20 characters + extension. If this format is not observed, the message 'Filename too long' is displayed. When the pointer passes over a destination file, its name, date and time of saving and size are displayed.*
- *If the name already exists or is not compatible, the error message : "Impossible! File already exists" appears.*

Recorder Mode (cont'd)

'.TXT' save Identical to "Oscilloscope" mode (see §. Memory Menu → Trace → Save '.TXT'). In this mode, traces are saved individually.

Recall '.REC' Opens a "File Copy" menu when selected. In the "Source" list, the previously saved .REC files (via the menu "Trace → Save.REC") are displayed.

The file name to recall is highlighted. It is selected using the stylus.

Once it has been selected, the → key opens the file and closes the menu. The menu can be exited without recalling by tapping the icon in the top right-hand corner with the stylus.



- It is impossible to launch an acquisition or deselect a channel while the recorder is in memory display mode.
- It is not possible to switch from a normal acquisition to a fault capture while the recorder is in memory display mode.
- This symbol – which is in the bottom right-hand corner of the screen – is a reminder that the recorder is in memory display mode.
- The "✓" symbol in front of Recall '.REC' in the Memory menu is a reminder that the recorder is in memory display mode.
- When a .REC file is recalled, the symbol "Mx" is displayed in the parameters of all the traces.
- The virtual keyboard cannot be used in this menu.
- To exit memory display mode, deselect Recall '.REC' in the Memory menu by tapping it with the stylus.

M

Example

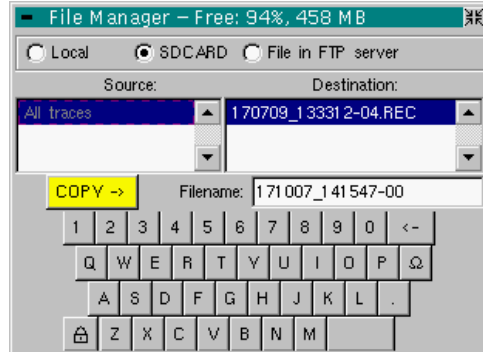

Saving a '.REC' acquisition:
Enter the filename.
Then click on → to validate the save.

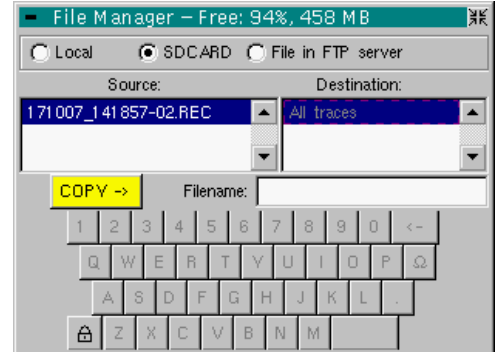

Recall '.REC': Select the file to recall.
Then click on → to validate your choice.

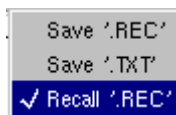

To deactivate the memory display, deselect recall '.REC' with the stylus.

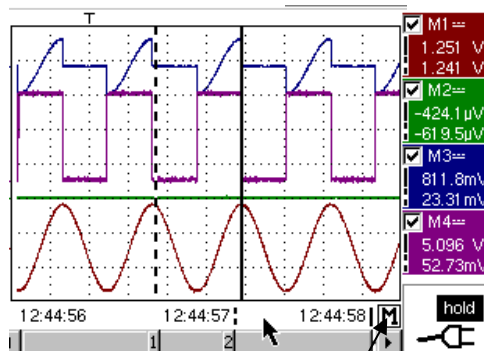

Mx symbol:
all the traces come from the memory.

Acquisition impossible in memory display mode.

The symbol **M** is a reminder that the recorder is in memory display mode.

Recorder Mode (cont'd)

Configuration

Saving or recalling an instrument configuration.

Save

Opens a "File copy" menu when selected.

* There is a file called "Configuration" in the "Source" list. It contains the configuration settings for the device at the time this menu is opened. A backup filename is proposed above the virtual keyboard. The  key deletes the character preceding the cursor in this area.

* Once the source filename has been created, the  key saves the configuration by transferring it into the "destination" list and closes the menu (backup file: extension .CFG).

The menu can be exited without saving by tapping the icon in the top right-hand corner of the window.



- *The filename is limited to 20 characters + extension. For a source file, the name is accompanied by the date and time of saving and the file size when the pointer passes over its name.*
- *If the name already exists or is not compatible, an error message appears.*

Recall

This opens a "File Copy" menu when selected.

* The previously saved files (.CFG) (saved via the Configuration → Save menu) are displayed.

The filename that has been selected for recall is greyed out.

The right-hand scroll bar is used to move down the list.

* Once the source file has been selected, the  key carries out the recall.

* The menu can be exited without saving by tapping the icon in the top right-hand corner of the window.



- *The virtual keyboard cannot be used in this menu.*
- *Use the "default config" file to restore the factory configuration.*

Recorder Mode (cont'd)

The "Util" Menu

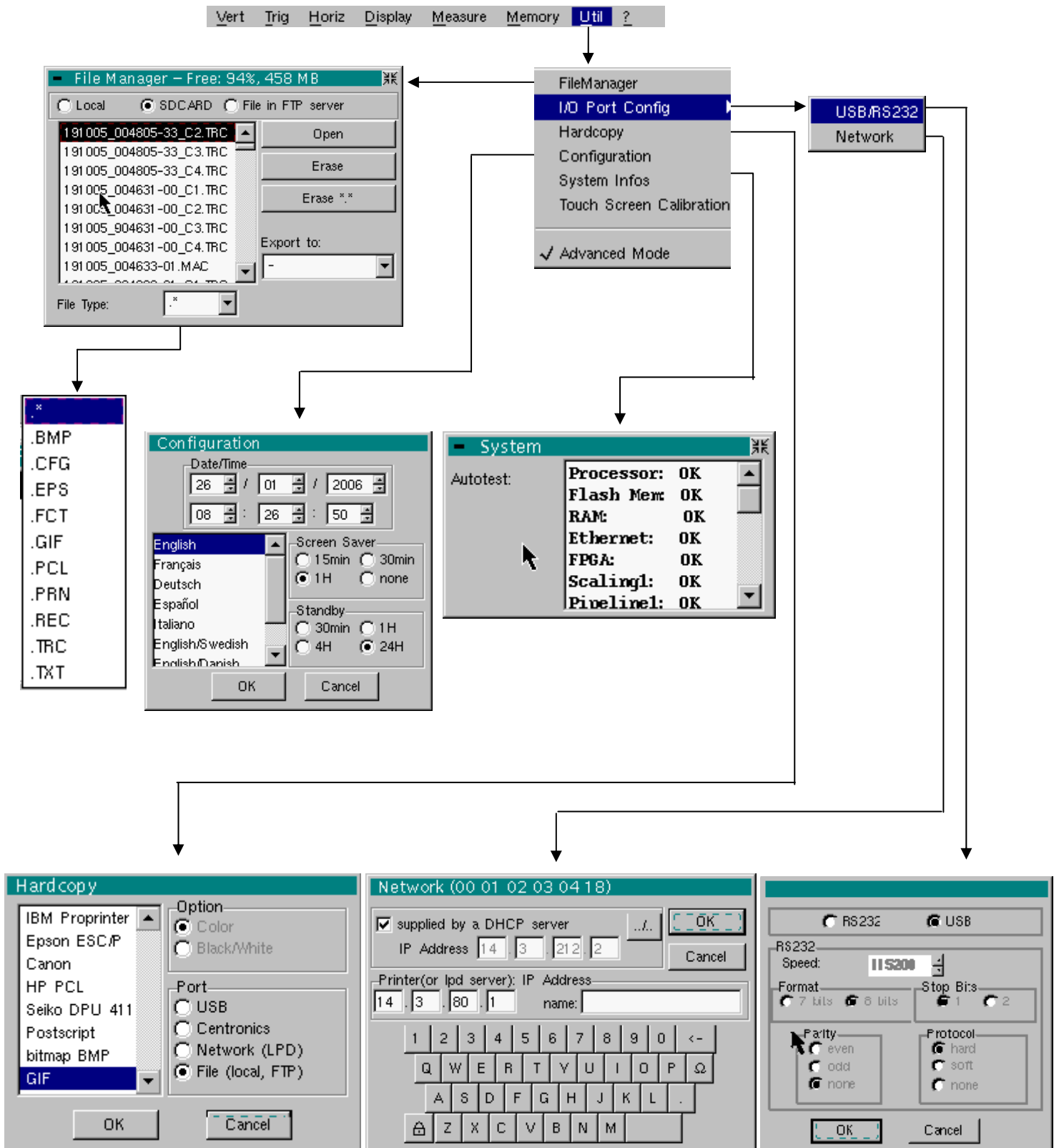

Recorder Mode (cont'd)

File manager

This function is identical to that described in "Oscilloscope" mode.

I/O port config

Identical to "Oscilloscope" mode.

Hardcopy

Identical to "Oscilloscope" mode.

Configuration

Identical to "Oscilloscope" mode.

Screen saver

- If the recording time is over 2 seconds, the screen saver will never be activated.
- If the recording time is equal to 2 seconds, the screen saver and settings operate as in "Oscilloscope" mode.

Standby

- If the recording time is over 2 seconds, standby will never be activated.
- If the recording time is equal to 2 seconds, standby and settings operate as in "Oscilloscope" mode.

System infos

Identical to "Oscilloscope" mode.

"Advanced" mode

When "Advanced" mode is not enabled, certain instrument functions no longer appear in the menus.

Functions available in "Advanced" mode only

math1, math4 → accessible via the "Vert" menu.



- The "✓" symbol indicates that "Advanced" mode is enabled.
- *The stylus can be used to modify this.*
- *By default, "Advanced" mode is not enabled.*
- *In "non-advanced" mode, the instrument's configuration is not saved when it is shut down using the key opposite and the default factory configuration is loaded at start-up.*

Recorder Mode (cont'd)

The "?" Menu

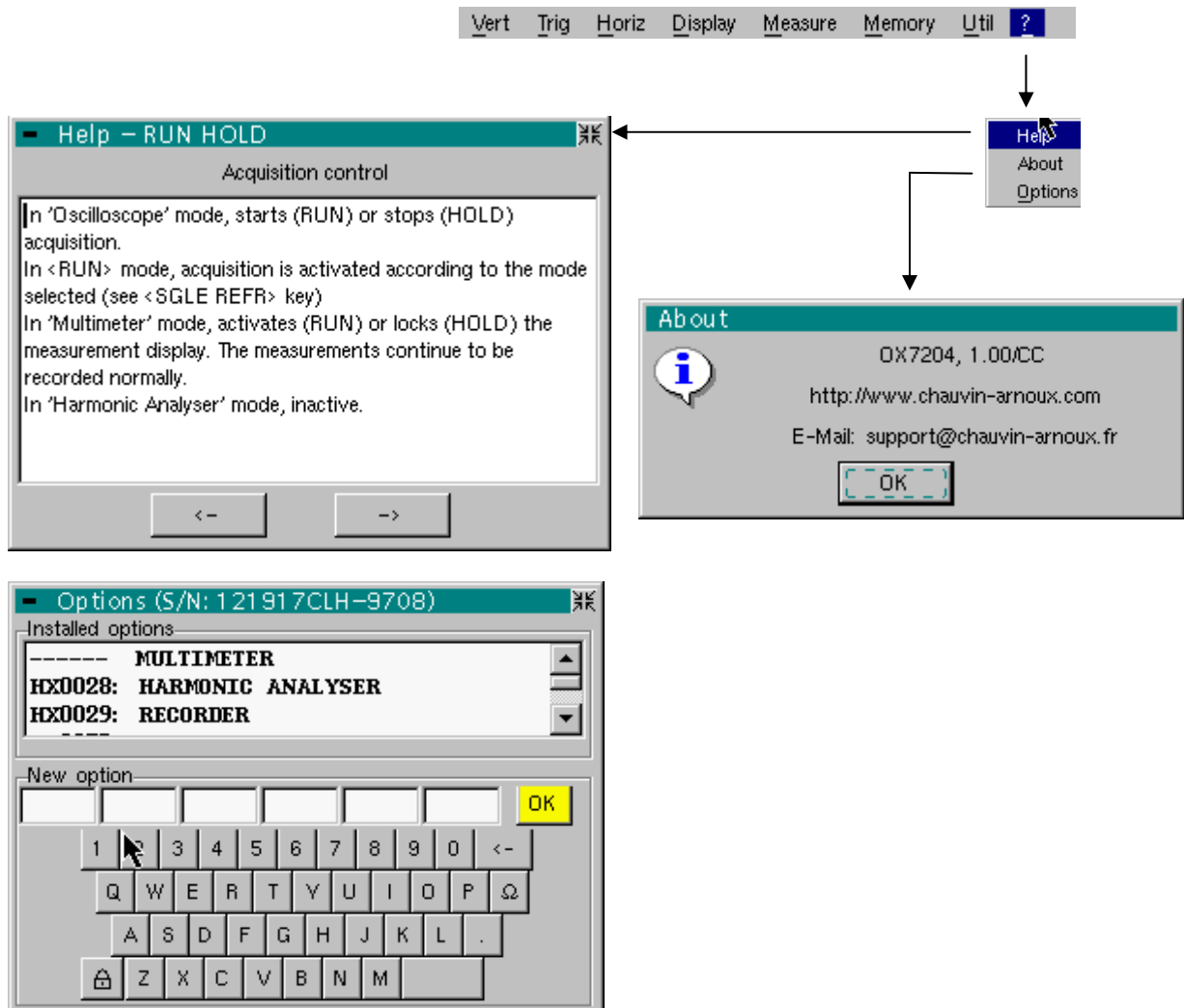

Help Menu identical to "Oscilloscope" mode.

About Menu identical to "Oscilloscope" mode.

Options Menu identical to "Oscilloscope" mode.

HTTP and FTP Server

1 - General

- Minimum PC configuration:** *Pentium 4, 1GHz, RAM: 1 Go.
Screen resolution: > 1152 x 864 pixels
Install JVM SUN J2RE 1.6.0
(or a more recent version)
from the //java.sun.com site*
- Recommended browsers:** *Microsoft Explorer 7
(or a more recent version),
Mozilla Firefox 3
(or a more recent version)
with the optional FireFTP module*

Two applications (applets) are accessible using an Ethernet connection between a client (PC or other) and one or more instruments:

- **ScopeNet** to control all the functions of an instrument.
- **ScopeAdmin** to supervise a set of connected instruments.

Before starting up for the first time we recommend that you de-activate the anti-virus and the firewall if they are installed on your PC. You will be able to reactivate them later optimally.

Vocabulary

HTTP Server	a machine (in our case SCOPIX) connected to the network and accessible from a client using an HTTP communications protocol.
HTTP Client	a machine (in our case a PC) connected to the network accessing a server using an optimal HTTP communications protocol.
FTP Server	a machine (in our case SCOPIX and eventually the PC) that gives access to the content of a directory on the hard drive to an FTP client.
FTP Client	a machine (in our case a PC) that has access to a shared directory on an FTP server.
Applet	a program downloaded from the server to the client and executed on the client machine. The access to all machine settings is made using a JAVA applet on the WEB client.

Specific characteristics

Only English language is supported.

Specific IP ports are used to exchange information between the applets and Scopix:

- **ScopeNet** uses the SCOPIX **UDP 50010 port**.
- **ScopeAdmin** uses the SCOPIX **UDP 50000 port**.

Screen copies obtained from a PC running WINDOWS XP and Firefox will be used to describe the use of **ScopeNet** and **ScopeAdmin**.

To access certain functions (access to an FTP server ...) you must use the "Policy Tool" contained in the JAVA package (see p. 169).

2 - ScopeNet

Presentation

All the instrument settings are accessible from the client PC.

For a detailed explanation of the different settings consult the index and refer to the corresponding chapters.

To access **ScopeNet** using the browser installed on your PC type the following in the address bar: **http://Instrument IP address**. The ScopeNet applet is then downloaded to the PC and runs in the browser.

The instrument IP address is defined in the following menu:

"UTIL" → « Config I/O Ports" → "Network". See p. 95.

Instrument IP address: see p. 20

Access to all scope settings from the menu.

The menus are the same as those on the instrument.

This icon shows the instrument operating mode.

Indication of a channel's settings:

- assignment (chX, mathX or memX)
- coupling,
- type of bandwidth limitation,
- channel sensitivity,
- vertical scale used for display

Indicates time base settings:

- time base,
- FFT display,
- horizontal scale used for display

Autoset

2 - ScopeNet (cont'd)

Client configuration

The ScopeNet operating mode is almost identical to the instrument operating mode. The few ScopeNet specificities are described in this chapter.

Trace colors

In order to avoid incoherency between a PROBIX and trace colors it is not possible to access channel color settings using the WEB client.

Access to an external FTP server

The use of an external FTP server is optional.

The external FTP server can be a PC on which the Filezilla Server software (see p. 190), or equivalent, has been installed; the same PC can be used as an FTP server and a ScopeNet client.

Access to this FTP server is configured from the ScopeNet menu.

If the access to the FTP server has not been configured or if the connection to the FTP server is rejected, the following message is displayed:

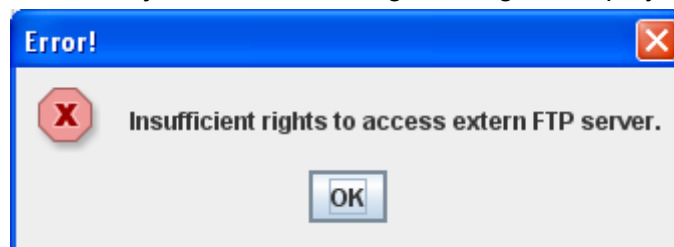

This message only notifies that the access to the external FTP server is not possible, the other ScopeNet functions remain accessible.

Screen Copy

The screen copy initiated from the HTTP client (PC) is a screen copy of the HTTP client, not of the instrument.

It is made on a printer managed by the HTTP client.

2 - ScopeNet (cont'd)

"OSCILLOSCOPE" Mode

Possibilities using this mode:

- Visualization of the curves as they are displayed on the instrument
- Adjustment of all vertical, horizontal settings, ...
- Measures by cursor, relative to a reference curve
- Automatic measurements (using samples located between the cursors)

The screenshot shows the METRIX ScopeNet software interface. The main display area shows four traces: a blue square wave (Trace 1), a red sine wave (Trace 2), a green square wave (Trace 3), and a magenta square wave (Trace 4). Two vertical cursors, labeled 1 and 2, are positioned on the traces. On the left side, a 'Cursors' panel displays measurement results: T1= 772µs, T2= 1.59ms, dT= 822µs, V1= -1.48V, V2= 695.96mV, and dV= 2.18V. On the right side, there are controls for each channel (ch1, math2, math3, ch4) with settings for bandwidth, sensitivity, and coupling. At the bottom, a status bar shows 'Battery: LOADING...' and 'TRIGGER: Edge / CH4 / AUTO / RUN'. The top of the interface has a menu bar with options like 'INSTRUMENT', 'Vertical', 'Trigger', 'Horizontal', 'Display', 'Measurement', 'Memory', and 'Utilities'.

The measurements are displayed by taking into account the scale ratios of the reference curve

Result of the measurements made using cursors 1 and 2

Button giving access to the automatic measurements on the reference channel

Status bar:
 - various messages
 - state of the battery
 - trigger state

Time location of the trigger

The indicators located on the left, on the top and at the right of the screen can be relocated by selecting them with the mouse:

- Use the left hand indicators to remove channel bounds.
- Use the right hand indicators to set the trigger levels.
- Use the top indicator to set the trigger time setting.

Zoom on a part of the screen: use the mouse to select the zone to zoom on, it appears surrounded by a dotted line on the screen.

2 - ScopeNet (cont'd)

Automatic measurements

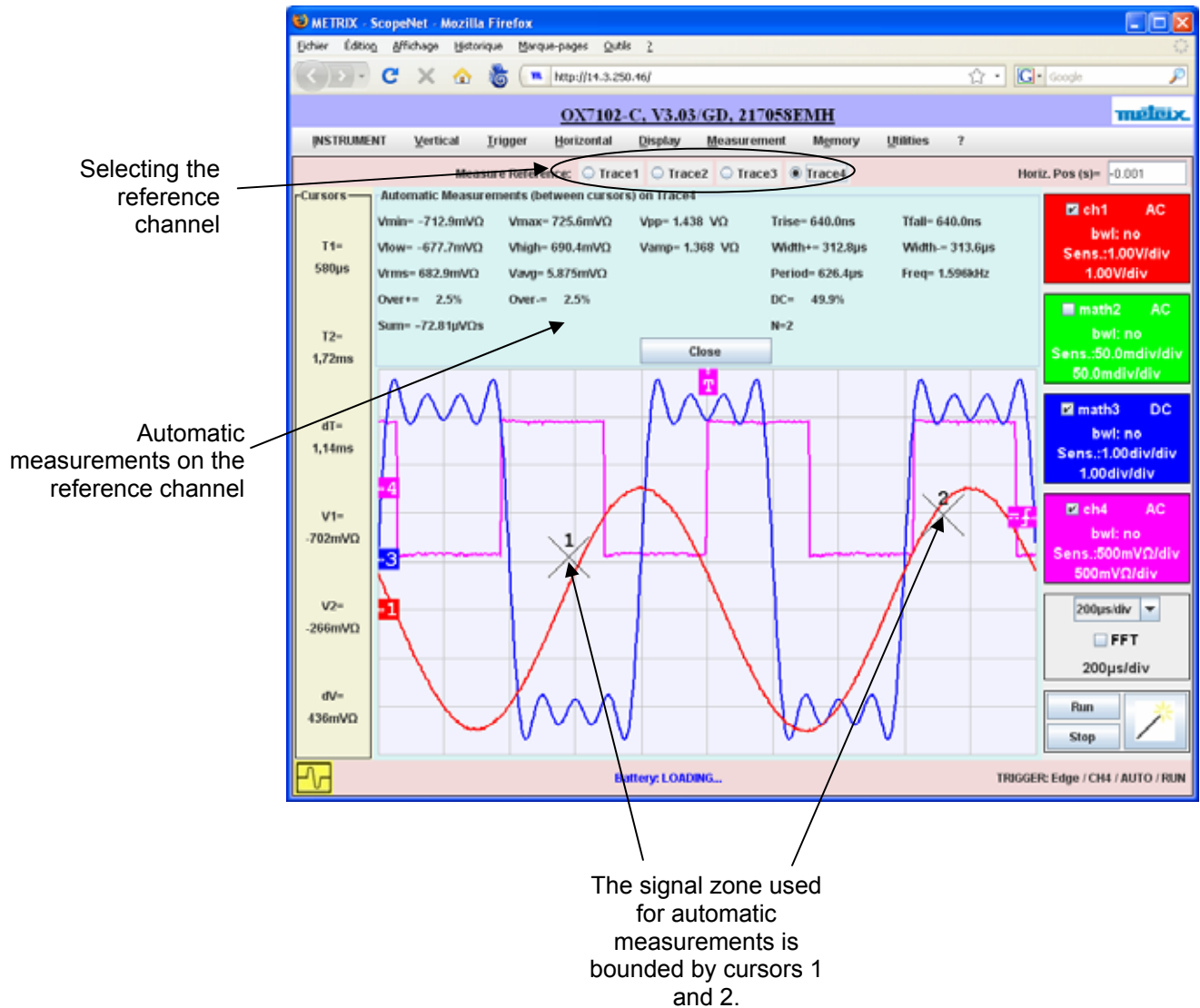

Selecting the reference channel

Automatic measurements on the reference channel

The signal zone used for automatic measurements is bounded by cursors 1 and 2.

2 - ScopeNet (cont'd)

Zoom

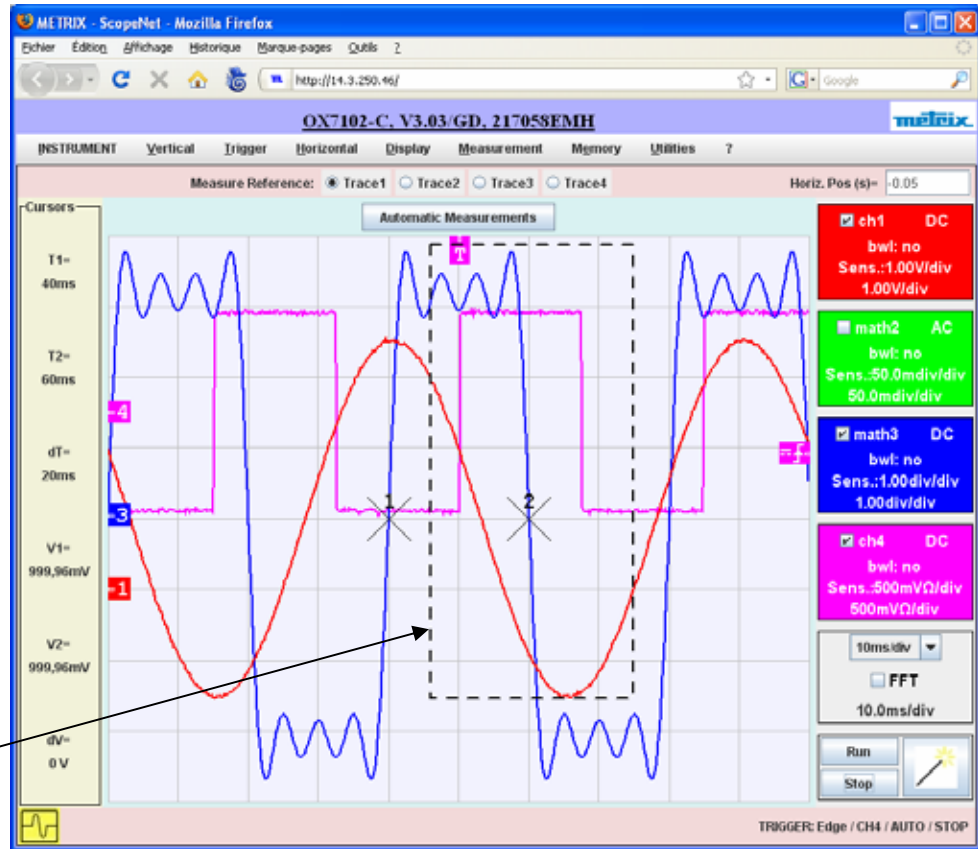

Selection of the zone to zoom on using the mouse

Result of the zoom operation

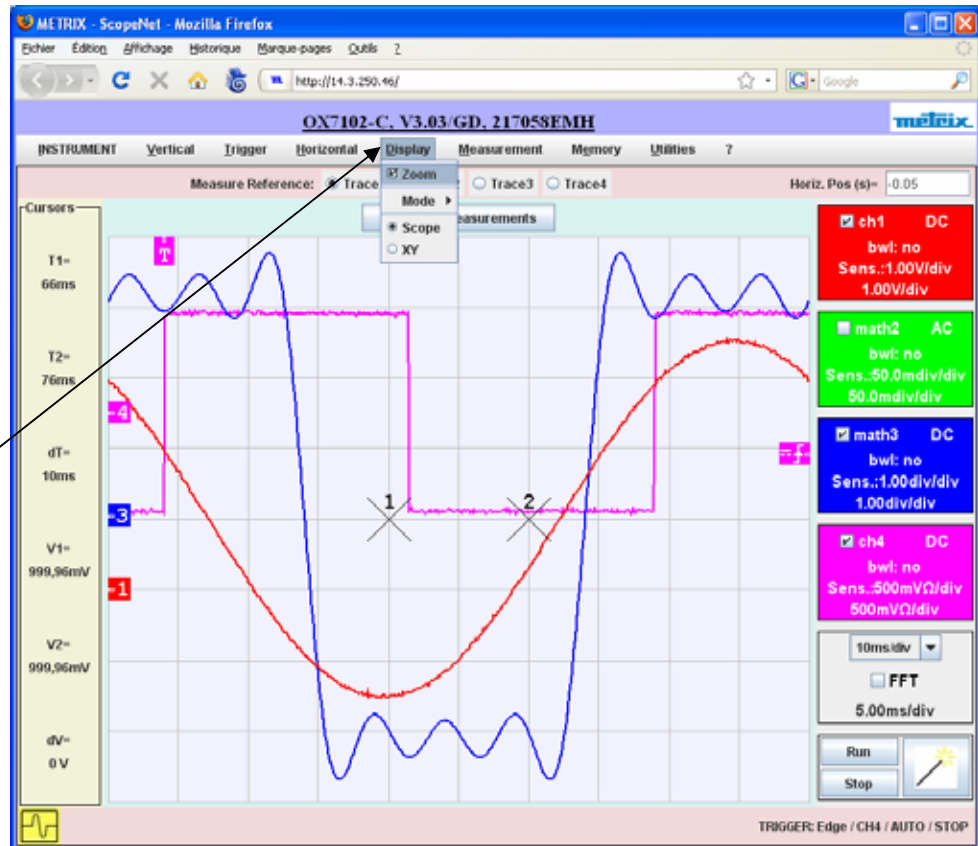

To deactivate the zoom uncheck the 'Zoom' checkbox on the 'Display' menu

2 - ScopeNet (cont'd)

"FFT" Mode

Possibilities using this mode:

- Visualization of the curves as they are displayed on the instrument
- Setting of various parameters
- Measures by cursor, relative to a reference curve

The boundary indicators show -40 dBV

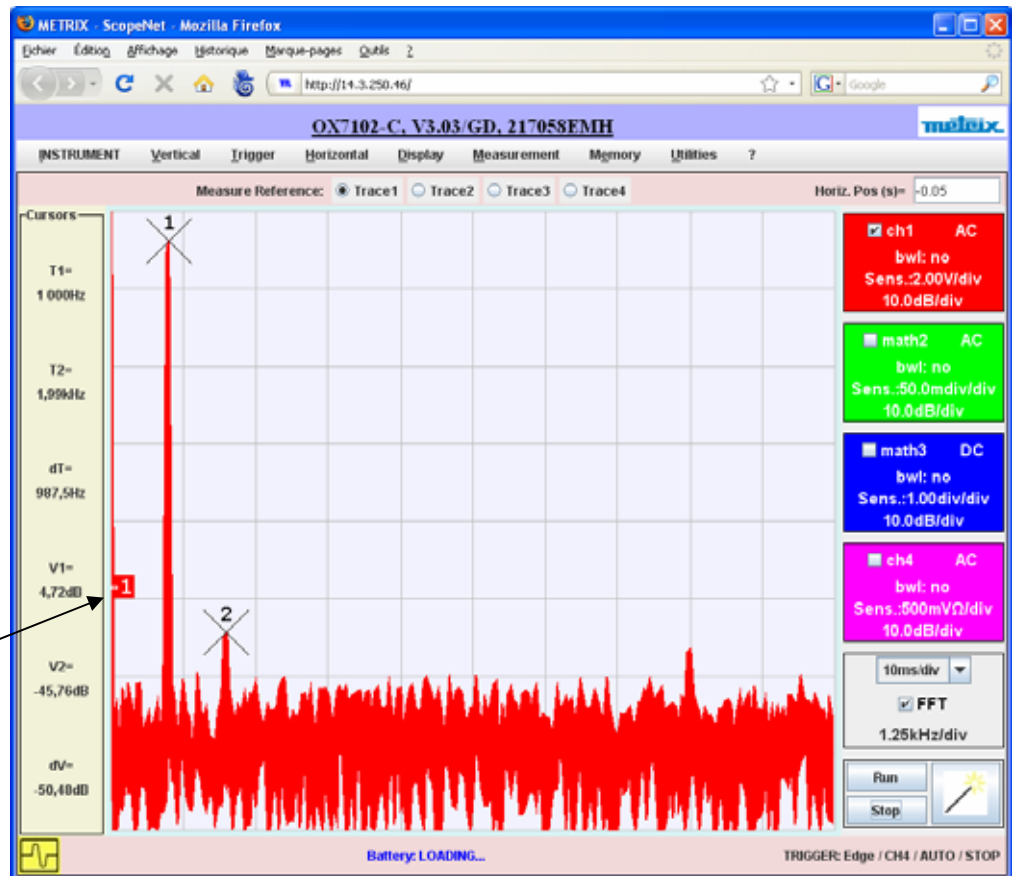

2 - ScopeNet (cont'd)

"MULTIMETER" Mode

Possibilities using this mode:

- Visualization of the curves as they are displayed on the instrument
- Adjustment of all acquisition settings, ...
- Measurements by cursor, relative to a reference curve

Horizontal zoom to view the last 2700 measurements
(if the instrument has the EXTENDED ACQUISITION MEMORY option)

Reference curve used by the cursors

Recording time

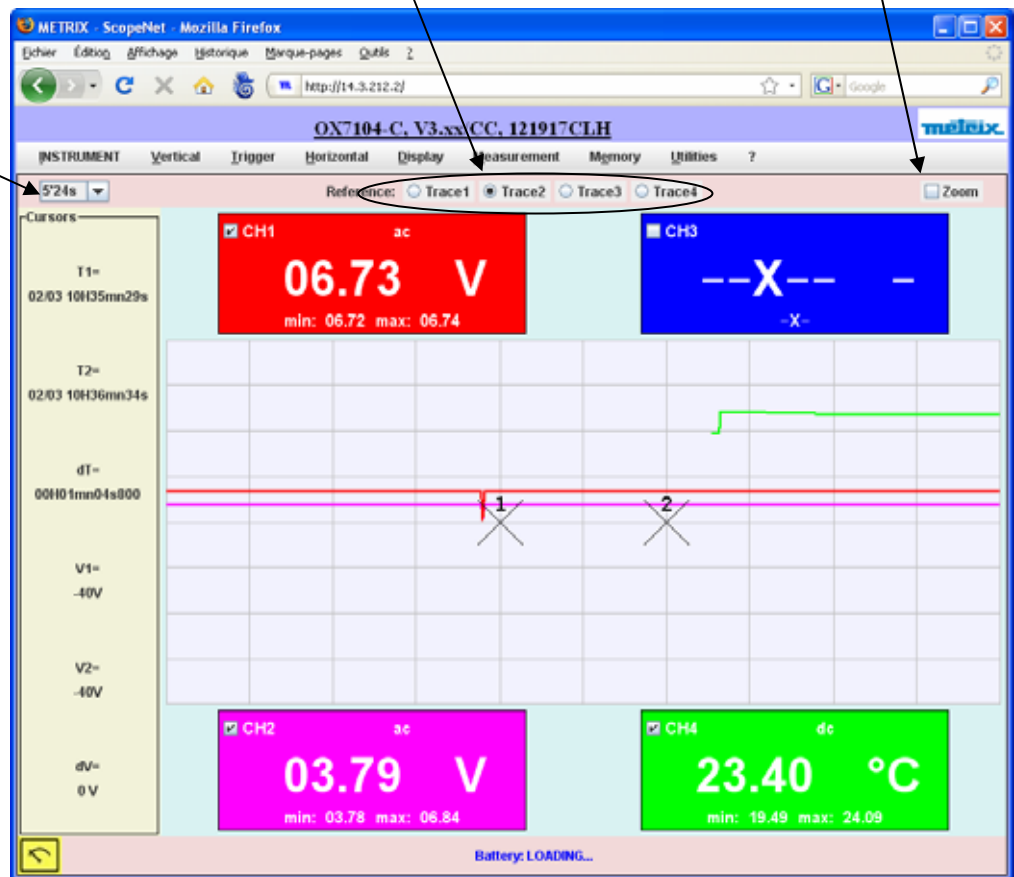

2 - ScopeNet (cont'd)

Power measurement

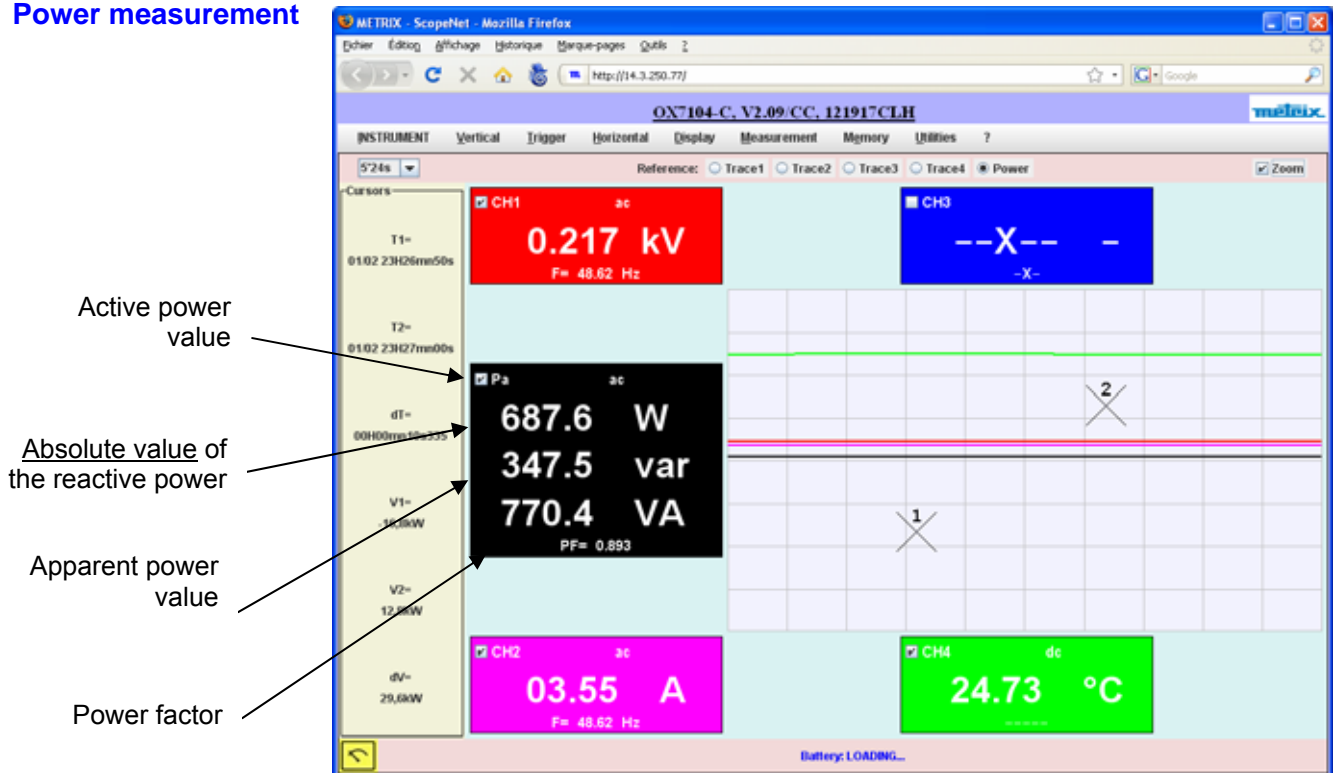

The displayed black curve shows the evolution of the active power measurement.

In the **Display** menu the **Statistic** option gives a display of the min and max active power values in the zone reserved for secondary measurements.

2 - ScopeNet (cont'd)

"RECORDER" Mode Possibilities using this mode:

- Visualization of the curves as they are displayed on the instrument
- Adjustment of all the instrument settings
- Measurements by cursor, relative to a reference curve
- Automatic measurements (using samples located between the cursors)

Reference curve used by the cursors

View/Clearing of the trigger level indicators

Button to deactivate a saved representation

The screenshot displays the METRIX ScopeNet web interface in a Mozilla Firefox browser. The main window shows a waveform with two traces: a red trace and a magenta trace. Two vertical cursors, labeled '1' and '2', are positioned on the traces. A green horizontal line is visible across the plot area. The interface includes a menu bar with options like 'INSTRUMENT', 'Vertical', 'Trigger', 'Horizontal', 'Display', 'Measurements', 'Memory', and 'Utilities'. Below the menu, there are buttons for 'Memory OFF', 'Measure Reference', and 'Automatic Measurements'. On the left, a 'Cursors' panel shows parameters for T1, T2, dT, V1, V2, and dV. On the right, a settings panel lists four channels (ch1 to ch4) with their respective DC settings, bandwidths, and sensitivities. At the bottom, there are buttons for 'Run' and 'Stop', and status indicators for 'Battery: LOADING...' and 'TRIGGER: STOP'.

2 - ScopeNet (cont'd)

"HARMONICS Analysis" mode

Possibilities using this mode:

- Harmonic analysis of the signals connected to the instrument channels
- Calculation of 64 harmonics and View of 32 harmonics (even or odd, or the first or the last)
- Adjustment of all the instrument settings
- Automatic measurements with a selection of the reference harmonic
- Automatic measurements (using samples located between the cursors)

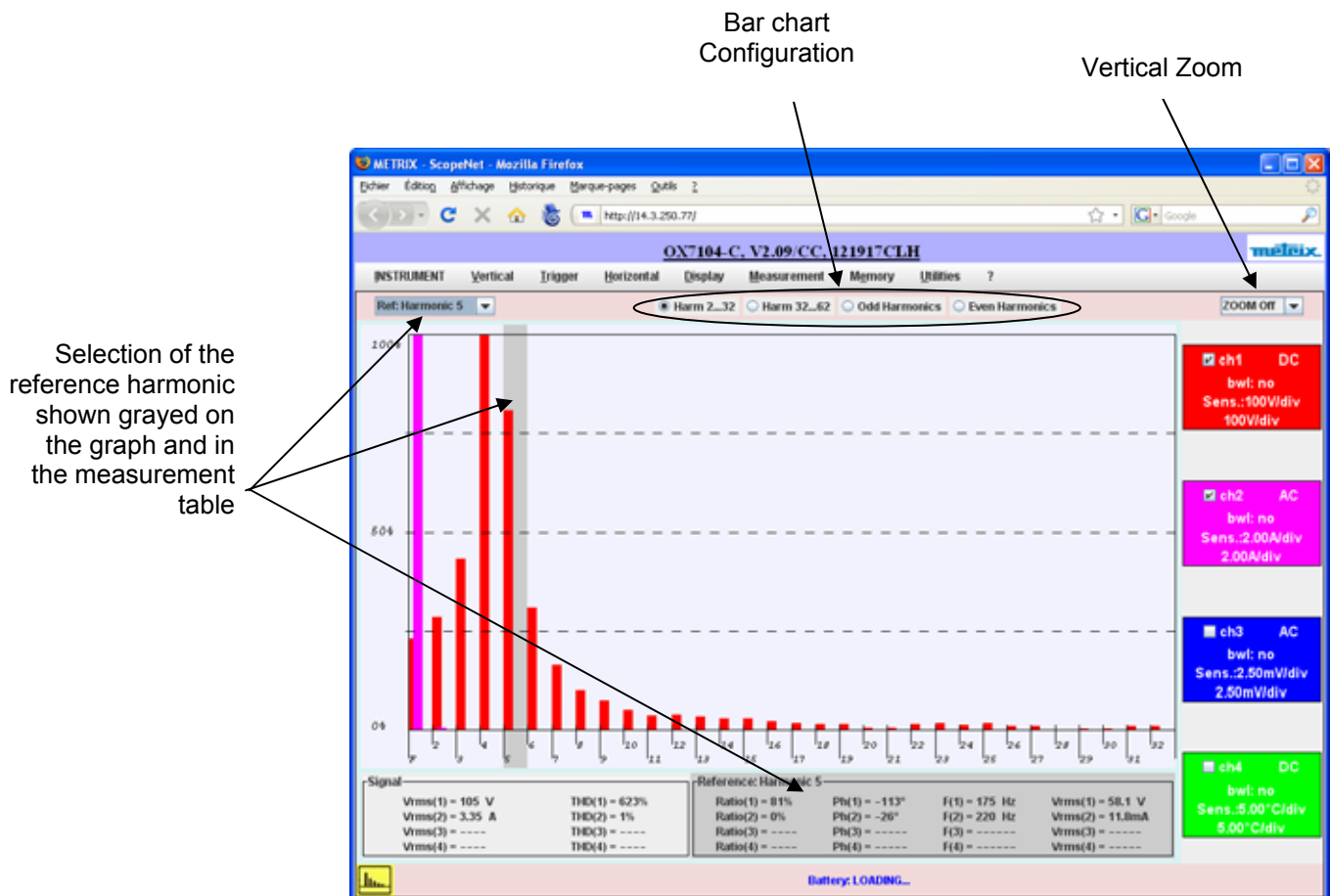

3 - ScopeAdmin

ScopeAdmin

It is a utility for supervising a set of **METRIX** instruments that support a specific communications protocol.

It is an applet that must be run on an instrument server client machine (PC or other).

The only instrument on which the IP address must be predefined is the instrument on which your PC will connect to download the applet. The IP address of the other instruments to be managed can be defined using **ScopeAdmin**.

The supervision consists in adjusting the different machine configuration settings:

- the IP parameters,
- the print settings,
- the configuration settings (language, standby ...).

Using **ScopeAdmin** you can send a message to all connected instruments or to a specific instrument; the message is displayed on the instruments' screen.

You can also prohibit access to the configuration settings using the front face of the instrument and put the connected instruments on standby or stop them.

To access **ScopeAdmin** from the browser installed on your PC type the following in the address bar:

http://Instrument IP address/ScopeAdmin.html.

A username and password are requested:

User: admin
Password: admetri*

The ScopeNet applet is then downloaded to the PC and runs in the browser.

Click on
'Find Instruments'
to explore your
network and display
all connected
instruments that
support ScopeAdmin.

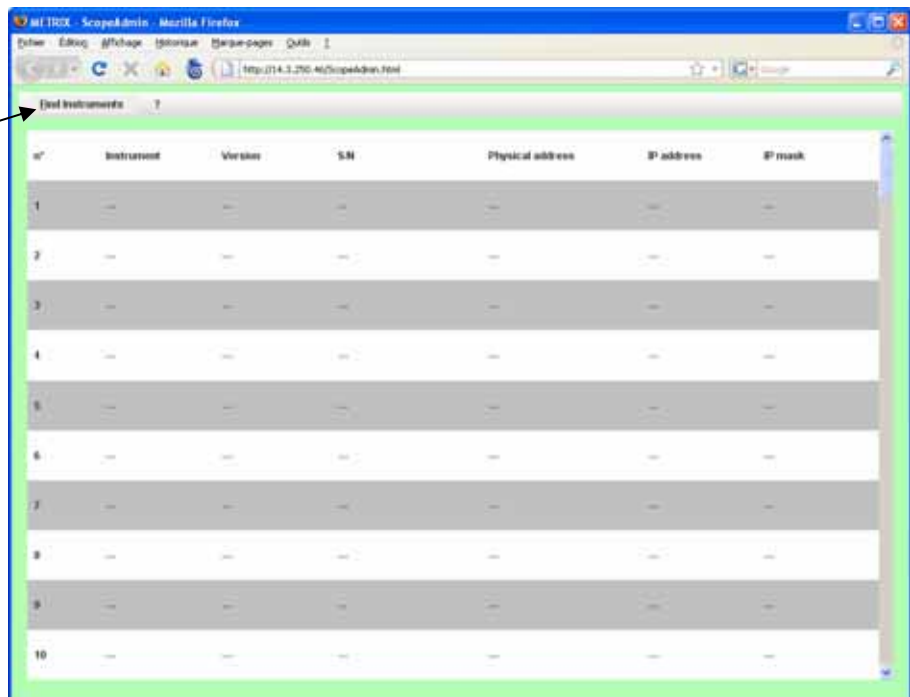

3 - ScopeAdmin (cont'd)

Screen displayed after "Find Instruments" is run

N°	Instrument	Version	S/N	Physical address	IP address	IP mask
1	OX7104-C	V2.00ADC	123456ABC-1000	00-01-02-03-04-30	192.168.10.1	255.255.255.0
2	OX7102-C	V2.00ZZ	123456ABC-4437	00-01-02-03-04-50	14.3.212.29	255.255.0.0
3	OX7104-C	V2.00CC	121917CJH-8708	00-05-04-03-01-02	192.168.10.1	255.255.255.0
4	---	---	---	---	---	---
5	---	---	---	---	---	---
6	---	---	---	---	---	---
7	---	---	---	---	---	---
8	---	---	---	---	---	---
9	---	---	---	---	---	---
10	---	---	---	---	---	---

A right mouse click in the title bar displays a context menu, the actions generated from this menu cover all the instruments in the list.

N°	Instrument	Version	S/N	Physical address	IP address	IP mask
1	OX7104-C	V2.00ADC	123456ABC-1000	00-01-02-03-04-30	14.3.250.00	255.255.0.0
2	OX7102-C	V2.00ZZ	123456ABC-4437	00-01-02-03-04-50	14.3.212.29	255.255.0.0
3	OX7104-C	V2.00CC	121917CJH-8708	00-05-04-03-01-02	192.168.10.1	255.255.255.0
4	---	---	---	---	---	---
5	---	---	---	---	---	---
6	---	---	---	---	---	---
7	---	---	---	---	---	---
8	---	---	---	---	---	---
9	---	---	---	---	---	---
10	---	---	---	---	---	---

A right mouse click in a line for a specific instrument displays the same context menu except that the generated actions only cover the selected instrument.

4 - Policy Tool

Configuration of the client machine (PC)

- **ScopeAdmin** uses the SCOPIX **UDP 50000** port.
- On your PC you can change the applet operation authorization file in order to allow ScopeAdmin to run:

Run the **policytool** utility from the JAVA installation directory (e.g.: C:\Program Files\Java\jre1.6.0_07\bin).

If an authorization file already exists the utility will open it, otherwise you will have to create it.

Under Windows XP this file must be located in **C:\Documents and Settings\your_name** and be called **.java.policy**

The **policytool** documentation is available at the following address <http://java.sun.com/j2se/1.5.0/docs/tooldocs/windows/policytool.html>

You must create a rule granting all rights to the applet.

The image shows two overlapping windows from the Java Policy Tool. The background window is titled 'Policy Tool' and shows the 'Fichier KeyStore' section with the file path 'C:\Documents and Settings\your_name\java.policy'. The foreground window is titled 'Règle' and contains the following elements:

- Base de code :** A text input field.
- Signé par :** A text input field with buttons 'Ajouter un principal', 'Modifier un principal', and 'Supprimer un principal' below it.
- Principaux :** A text input field with buttons 'Ajouter une permission', 'Modifier une permission', and 'Supprimer une permission' below it.
- Permissions list:** A list box containing 'java.security.AllPermission'.
- Buttons:** 'Terminé' and 'Annuler' at the bottom.

Annotations with numbered circles point to various parts of the interface:

- 1** Authorization file name: Points to the file path in the 'Policy Tool' window.
- 2** Add a rule in order to display the following screen: Points to the 'Ajouter une règle' button in the 'Policy Tool' window.
- 3** Add the indicated permissions in order to authorize the applet to operate, leave the other fields blank: Points to the 'Ajouter une permission' button and the 'java.security.AllPermission' entry in the 'Règle' window.
- 4** Window closure: Points to the 'Terminé' button in the 'Règle' window.
- 5** Save the authorization file: Points to the 'Fichier KeyStore' section in the 'Policy Tool' window.

5 - FTP Server

To access the internal files of the instrument, enter the following URL into the address bar of your browser:

<ftp://<instrument IP address>/RAM/>

To access the files in the SD Card of the instrument, enter the following URL into the address bar of your browser:

ftp://<instrument IP address>/CARD:/metrix/

Applications

1. Display of the calibration signal



- Using the key shown *opposite*, select the "Oscilloscope" mode.
- Connect the **Probix** adapter of a 1/10-ratio HX0030 probe to input CH1.
- ☞ *A message indicating the characteristics of the probe is displayed briefly, confirming that it has been detected.*

The **Probix** menu (Vert → CH1 → **Probix**) can be used to configure buttons **A** and **B** of the probe.

- Use this menu to assign button **A** to increasing the sensitivity and button **B** to reducing it by selecting: Sensitivity +/-.

☞ *See the description in the chapter on **Probix** p. 29.*

- The same menu can be used to modify the color of CH1 trace → Red
- Via the probe (with its earth) connect the calibrator output to input CH1 (Probe Adjust: $\approx 3\text{ V}$, $\approx 1\text{ kHz}$) located on the side of the instrument.

☞ **Connect the cold point of the 1/10 probe to the cold point of the calibration output of the probes.**

- Check that the coefficient of the 1/10 probe has been taken into account: Vert Menu → CH1 → Vertical Scale → Coefficient: 10.

☞ *The sensitivity and the measurements take the probe's coefficient into account.*



- Validate the signal:
Vert Menu → Display → Trace 1
or by pressing the CH1 key
or on the display of the CH1 trace parameters.



- Adjust the CH1 sensitivity:
Vert Menu → CH1 → Sensitivity/coupling: 500 mV/div. (1/10 probe)
or by using buttons **A** and **B** of the **HX0030** probe
or the keys *opposite*.



- Adjust the CH1 coupling:
Vert Menu → CH1 → Sensitivity/coupling → AC
or by pressing the AC/DC GND key.



- Adjust the scan speed:
using the scrollbar in the time base window: 500 $\mu\text{s}/\text{div}$
or the keys *opposite*.



- Select the trigger parameters:
Trig. Menu → Parameter → Main → Source: CH1
Coupling: AC
Front: + (or using the key *opposite*).



- Adjust the trigger mode:
Trig. Menu → Automatic mode
or using the SGLE REFR key.



- Use the RUN HOLD key to start acquisition ("RUN" mode)

Applications (cont'd)

If necessary:

- Modify the trigger level using the stylus:
 - by moving the symbol T (Trigger) on the screen. The value of the trigger level is indicated in the bottom right-hand corner of the screen.
 - or through the trigger parameters menu:
Trig. Menu → Parameter → Main → Level
- Modify the vertical positioning of the curve:
 - by using the stylus to move symbol 1, on the left of the screen.
 - or by using the keys *opposite*.



The key opposite is used to make these adjustments automatically.

HX0030 probe compensation

Adjust the low-frequency compensation of the probe so that the signal plateau is horizontal (see figure below).

- Over-compensated probe
- Compensated probe
- Under-compensated probe

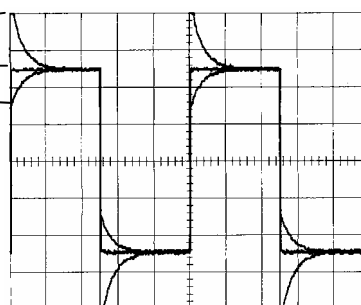

*Adjust the screw on the **Probix HX0030** probe to adjust the compensation.*

Applications (cont'd)

3. Automatic measurement

- Connect the calibrator output (3 V, 1 kHz) in the connection zone to input CH1, using a 1/10 measurement probe.
- For probe adjustments, see the §. Calibration signal display.
- Opt for: 500 mV/div. vertical calibre,
time base coefficient 500 μ s/div.
vertical scale coefficient 10
DC coupling of CH1



Display the table of the automatic signal measurements on channel 1 by: Measure Menu \rightarrow Automatic Measurements (see §. Measure Menu) or using the key *opposite*.

The table of all the measurements made on the trace is displayed:

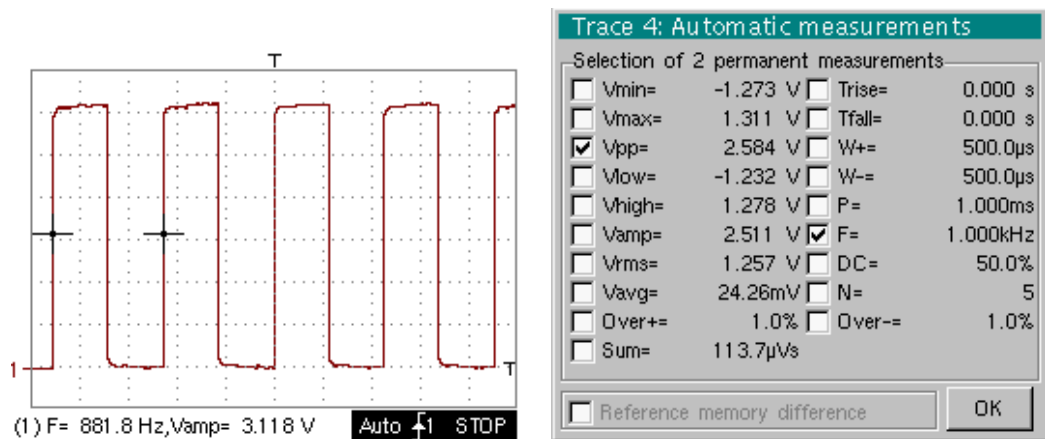

The "✓" symbol indicates the 2 measurements that will be displayed on the trace once the table has been closed.

The automatic measurements beneath the trace are deleted by deleting the last 2 measurements selected.



By validating the "Reference memory difference" option, you can calculate, for the same measurements, the difference between a selected trace and a memorized reference trace (see §. Memory Menu).

Recall

The measurement precision is optimum if 2 complete signal periods are displayed.

When the automatic measurements are activated, 2 cursors appear on the trace at the beginning and end of a period, if at least one period can be viewed on the screen.

Applications (cont'd)

4. Measurement using cursors

- Select measurement by cursors using the menu:
Measure → Manual measurements (dt, dv) (see §. Measure Menu).
 - * Two measurement cursors (1 and 2) are displayed as soon as the menu has been activated.
 - * The 2 measurements indicated under the trace display are **dt** (interval between the 2 cursors as a function of the time base) and **dv** (voltage between the 2 cursors as a function of the vert. sensitivity).
-  *Example:* (1)dt : 2,150 ms, dv = 250.0 mV



Recall

- The two measurement cursors (1 and 2) can be moved directly on the screen by means of the stylus. In the same way, they can also be moved horizontally by means of the stylus, by selecting the 1 (cursor 1) or the 2 (cursor 2) in the bargraph of the status zone.
- If the unattached cursors option is not activated (see §. Measure Menu → Unattached cursors), the cursors remain linked to the trace during the moves.
- If the unattached cursors option is active, the cursors can be moved anywhere on the screen.

5. Phase Offset measurement/cursors

- Initially, there must be 2 out-of-phase signals on 2 channels (ch1 and ch2).

6. Automatic phase measurement

- Select the reference trace in relation to which you want to perform the phase measurements via the menu:
Measure → Reference → Trace 1 to Trace 4 (see §. Reference).
 *Example:* Reference Measurement → Trace 1.
 - Select automatic phase measurement via the menu:
Measure → Phase measurements (see §. Phase measurement).
 *Example:* Phase Measurement → Phase Trace 2.
 - * The 2 cursors (+) of the automatic measurements are displayed on the reference trace. A cursor "φ" is displayed on the trace concerned by the phase measurements.
 - * The phase measurement (in °) is indicated under the display of the curves.
-  *Example:* (1)Ph (2) = 180.0°

Reminder

- The 3 cursors are fixed; they cannot be moved.
- If it is not possible to perform the measurement, "-.-" appears.

Applications (cont'd)

6. Manual measurement of phase

- Select manual phase measurement via the menu: Measure → Manual phase measurement (see §. Measure Menu).
 - * The 2 cursors (1 and 2) of the manual measurements are displayed on the reference trace. A "φ" cursor in relation to which the phase is measured is displayed.
 - * The phase measurement (in °) is indicated under the display of the curve(s).
 - 🔍 *Example:* (1)Ph = 150.0°

Reminder

- The 3 measurement cursors are present if at least one trace is present on the screen.
- The 3 measurement cursors can be moved directly on the screen by using the stylus. They can also be moved using the stylus by selecting 1 (cursor 1) or 2 (cursor 2) in the bargraph in the status zone.
- If the unattached cursors option is not activated (see §. Unattached cursors), the cursors (1 and 2) will remain linked to the trace when moved. If the option is active, these cursors can be moved as required on the screen.

In all cases, the symbol "φ" can be moved freely.

7. Display of a TV video signal

This example illustrates the TV synchronization functions.

- *The parameters in the TV menu (Trigger Parameters menu) for displaying a TV signal only apply to the CH1 input.*

- *it is recommended to use a 75 Ω adapter for observing a video signal.*

- Use a **Probix** HX0031 adapter to inject on CH1 a composite TV signal with the following characteristics:
 - 625 lines
 - positive modulation
 - vertical grey scale stripes

- In the Trigger Parameters menu, select the tab: Trig. Menu → Parameter → TV:

- Set the standard number of lines: 625 lines

- polarity: +
- line: 25 (for a video signal)
- front: + (or using the key *opposite*).



- Adjust the CH1 coupling: Vert Menu → CH1 → Sensitivity/coupling → DC or by pressing the AC/DC GND key.



- Adjust the CH1 sensitivity: Vert Menu → CH1 → Sensitivity/coupling → 200 Mv/div. or using the keys *opposite*.



- Adjust the scan speed: using the scrollbar in the time base window: 20 μs/div. or using the keys *opposite*.

Applications (cont'd)



- Select the trigger mode:
Trig. Menu → Automatic mode
or using the SGLE REFR key.



- Use the RUN HOLD key to start acquisition (RUN mode)
or use the time base menu.

Reminder

The acquisition status (Ready, RUN, STOP) is indicated on the right, under the display of the trace, in the trigger status display zone.

- Optimize the time base speed to observe several complete TV lines.

Example of a video signal

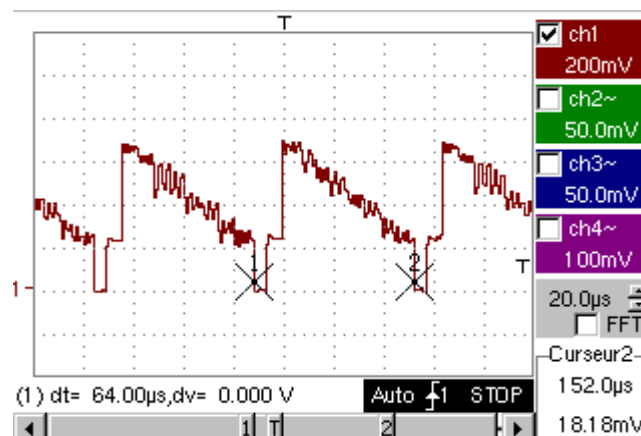

Use the manual cursors to check the duration of a line.



- Display the manual cursors:
Menu → Measure → Manual measurements (dt, dv)
or using the key *opposite*.
- To move the cursors freely, select:
Measure Menu → Unattached cursors.
- Use the stylus to position cursors 1 and 2 on the start and end of the signal, respectively.

The measurements between the 2 cursors are indicated under the curve display.

Example: $dt = 64.00 \mu s = \text{duration of a line}$

Applications (cont'd)

8. Examination of a specific TV line

For more detailed examination of a video line signal, the TV trigger menu can be used to select a line number.

- In the Trigger Parameters menu, select the tab:
Trig. Menu → Parameter → TV:



- Set the standard number of lines: 625 lines

polarity: +
line: 1
front: + (or using the key *opposite*).

- Adjust the ch1 sensitivity:
Vert Menu → CH1 → Sensitivity/coupling → 100 mV/div
or using the keys *opposite*.



- Modify the scan speed:
using the scrollbar in the time base window: 20 μs/div
or using the keys *opposite*.



 Example of video line 1

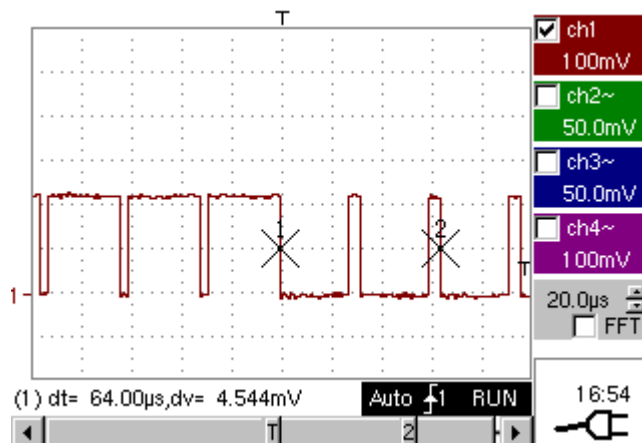

Applications (cont'd)

9. Automatic measurement in Harmonic Analysis mode

Initially, there must be one or two traces on channels CH1 to CH4.

Recall

- Only the channels (and not the functions) can be the subject of harmonic analysis.
- In this mode, the time base is not adjustable.



- Set the traces for channels CH1 to CH4 to the mode "Oscilloscope".
- Using the key *opposite*, select the "Harmonic Analysis" mode.

The traces of channels CH1 and CH4 are shown in a dark color, while the traces of CH2 and CH3 are light (or in the color of the trace).

- Use the "Display" menu (see §. Display) to select the harmonic breakdown required:
 - the fundamental (F) and the first 15 harmonics
 - the even harmonics (2 to 30)
 - the odd harmonics (3 to 31)

The selection chosen appears under the breakdown display.

- The "SIGNAL" table under the breakdown provides information on:
 - the active channel(s) (CH1 to CH4)
 - the RMS voltage of the signal in V
 - harmonic distortion rate (in %) of the signal
- The "✓" symbol, present on the fundamental (F) or one of the harmonics and modifiable using the stylus, means that measurements can be made on the harmonic selected.

Applications (cont'd)

- The Table "Ref.: Harmonic X" indicates, for the harmonic selected:
 - its value as a % of the fundamental
 - its phase in ° with respect to the fundamental
 - its frequency in Hz
 - its RMS voltage in V

 *Example of harmonic breakdown*

- On CH1, inject a rectangular signal with frequency 100 Hz and amplitude 5 V.
- On CH4, inject a triangular signal with frequency 100 Hz and amplitude 5 V.
- Use the key *opposite* to perform automatic optimum adjustment of the channels, the ranges, the time base and the trigger.



"Oscilloscope" Mode

Use the FULL TRACE key to display the 2 traces separately.

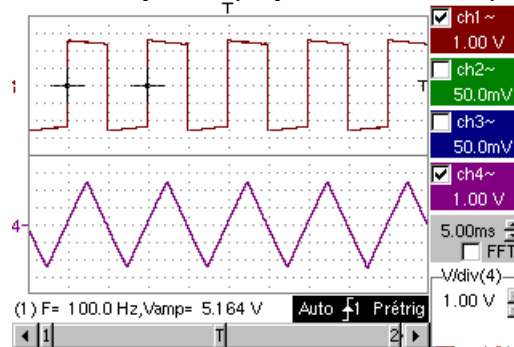

"Harmonic Analysis" Mode



- Press the key *opposite* to activate the "Harmonic Analysis" mode.
- Use the "Display" menu to select the required harmonic breakdown:
 -  *Example: Odd harmonics*
- Use the stylus to select the fundamental (F) or one of the harmonics to perform the measurement:

 *Example: Harmonic 3*

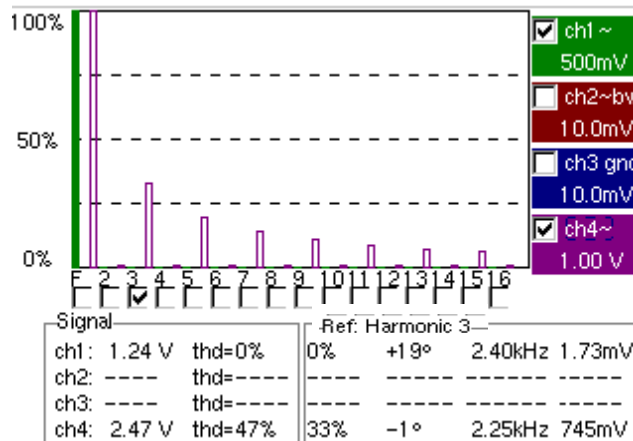

Applications (cont'd)

10. Display of slow phenomena "ROLL" mode

This example examines the analysis of slow phenomena for time bases ranging from 200 ms to 200 s. The samples are displayed constantly, without waiting for the Trigger (ROLL mode).

 Examination of slow phenomena over a significant period of time



- Select "Oscilloscope" mode (key *opposite*).
- Inject on the CH1 input a sinusoidal signal at 1 Hz and 1 Vrms.
- Adjust the scan speed: using the scrollbar in the time base window: 500 ms/div or using the keys *opposite*.



- Validate signal CH 1:
Vert Menu → Display → Trace 1
or by pressing the CH1 key
or on the display of the CH1 trace parameters.



- Adjust the CH1 sensitivity:
Vert Menu → CH1 → Sensitivity/coupling → 500 mV/div (1/10 probe)
or using the keys *opposite*.

- Adjust the CH1 coupling:
Vert Menu → CH1 → Sensitivity/coupling → DC
or by pressing the AC/DC GND key.



- Select the trigger parameters:
Trig. Menu → Parameter → Main → Source → CH1
Coupling: AC
Front: + or using the key *opposite*.



- Adjust the trigger mode:
Trig. Menu → Single mode
or using the SGLE REFR key.

Use the stylus to move the Trigger level symbol up or down in the display area:

Trigger level is < the signal level → the oscilloscope stops data acquisition once it has filled the acquisition memory (STOP mode).

- Trigger level > Signal level → data acquisition no longer stops and the signal is analyzed constantly.



The trigger level may be set precisely, using the trigger parameters menu:
Trig. Menu → Parameter → Main → Level.



- Start acquisition using the RUN/HOLD key (RUN mode).

Examination of the signal

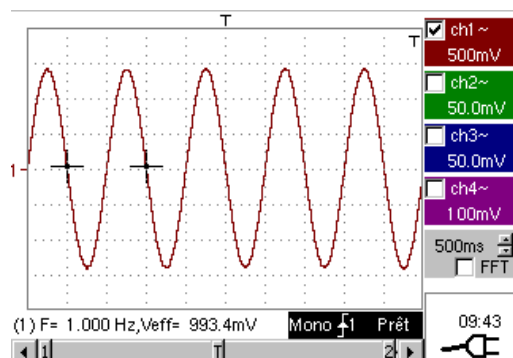

The signal is analyzed constantly (RUN mode).
This trace scroll function allows the form of the signal to be monitored.

 This function is recommended for studying low-frequency signals.

Applications (cont'd)

11. Min / Max Acquisition

Detection of a wrong representation due to under-sampling

 Examination of an amplitude-modulate signal



- Using the key shown *opposite*, select the "Oscilloscope" mode.
- Inject on the CH1 input an amplitude-modulated sinusoidal signal at a frequency of 15Hz.
- Inject on the CH4 input a sinusoidal signal at 300 Hz and 3 VDC. for synchronization of the signal on CH1.



- Adjust the scan speed:
using the scrollbar in the time base window: 1 ms/div
or using the keys *opposite*.
- Validate the CH1 signal: Vert Menu → Display → Trace 1
or using the key *opposite*.
or on the display of the CH1 trace parameters.



- Adjust the CH1 sensitivity:
Vert Menu → CH1 → Sensitivity/coupling: 200 mV/div
or using the keys *opposite*.

- Ditto for CH4 with a sensitivity of: 500 mV/div

- Adjust the trigger parameters:



Trig. Menu → Parameter → Main:
Source: CH4
Coupling: AC
Front: + or using the key *opposite*.



- Adjust the trigger mode:

Trig. Menu → Auto Mode:
or using the SGLE REFR key.



- Start acquisition using the RUN/HOLD key (RUN mode).



- Use the FULL TRACE key to display the 2 traces separately.

 Examination of the signals

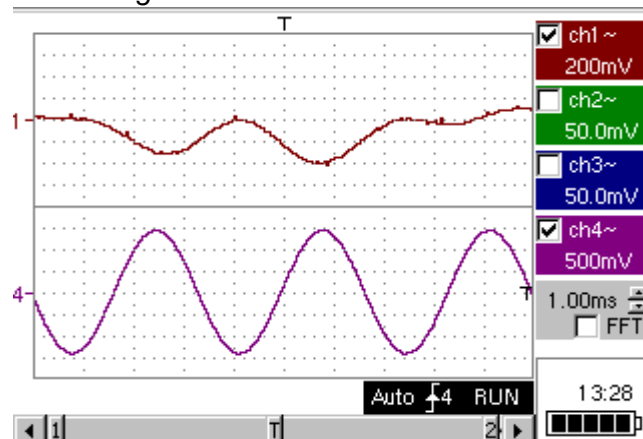

Applications (cont'd)

 The observation of the amplitude-modulated CH1 trace cannot be used (incorrect display).

- Validate the MIN / MAX mode:
Horiz → MIN/MAX Acquisition menu, to view the amplitude modulation of the CH1 signal.

 Examination of the signals

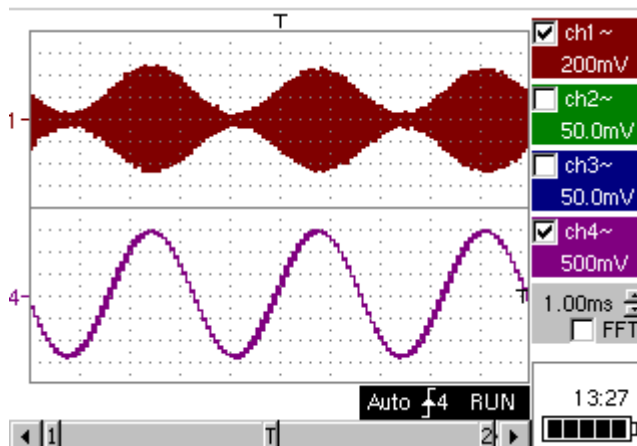

Applications (cont'd)

12. Measurement in multimeter mode



Measurement in Multimeter Mode

- Press the key *opposite* to activate the "Multimeter" mode.
- Connect the **Probix HX0033** adapter on the CH1 input.
- ☞ *A message indicating the characteristics of the probe is displayed briefly, confirming that it has been detected.*

The positive input is indicated by the "+" sign on the adapter for VDC measurements.

- Use the appropriate cables to connect the **Probix** adapter to the test resistor.
- Select input CH1 in Ohmmeter mode:
Menu: Measurement → CH1 → Ohmmeter.
- ☞ *Ohmmeter mode (Ω) is indicated in the display of the parameters for CH1.*



- Validate the measurements on CH1 by pressing the key *opposite* (- X - disappears).

The resistance measured is not known:



- Select the "Autorange" mode.
"Channel 1 Parameters" menu under Vert → CH1 → Range/Coupling or by a long press on the CH1 key.
- ☞ *The autorange mode (auto) is indicated in the display of the parameters for CH1.*

In this case, the instrument constantly seeks the most suitable measurement range.

The resistance measured is known:



- Select the appropriate range:
"Channel 1 Parameters" menu under Vert → CH1 → Range/Coupling or using the keys *opposite*.
- ☞ *See the general characteristics for the ranges available.*
- Select the "Statistics" mode.
Menu: Display → Statistics, to find out the minimum and maximum values when the measurement variations are analyzed.
- ☞ *The MIN and MAX measurements are indicated in the display of the parameters for CH1.*



- Use the keys *opposite* to select the duration of the period (5', 15', 30', 1 h, 6 h, 12 h, 24 h, week, month) for analysis of the measurement variations.
- ☞ *The duration selected is indicated in the top left-hand corner of the graphic window.*
- Deactivate "Roll" mode:
Menu: Horiz → Roll to stop the measurements at the end of the analysis period.

Applications (cont'd)

Example of measurement in Multimeter Mode

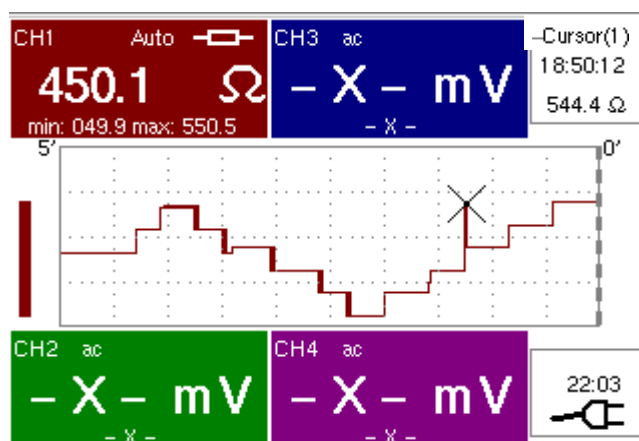

The graphic window records the changes in the measurements during the analysis period (5 minutes).

The bargraph shows the amplitude of the variations.

The minimum value (49.9 ohms) and the maximum value (550.5 Ohms) measured are indicated in the CH1 parameter display.

The cursor linked to the trace indicates the measurement a specific point on the trace, along with the time of the event.

 The value measured which is displayed in the CH1 parameter display remains active after the analysis period has ended.

13. Measurement in "Recorder" mode

Analysis of iron heating



 Example: Monitoring of temperature variation of a soldering iron

Using the key shown *opposite*, select the "Recorder" mode.

Connect the **Probitx** adapter of an **HX0035** K Thermocouple probe to input CH1.

A message showing the characteristics of the probe is displayed briefly → the probe has been detected:

ch1: PROBITX event			
 HX35 - NO ISOLATION BETWEEN 2 KTC -40°C/+1 250°C, 1% +/-3.5°C typ			
	Input:	Floating:	Between Channel:
Ch1	K TC	30V CAT I	-
HX35	-	-	-
Ch2	-	600V CAT III	300V CAT II
-	-	-	-
Ch3	-	600V CAT III	300V CAT II
-	-	-	-
Ch4	-	600V CAT III	300V CAT II
-	-	-	-

Applications (cont'd)

Ch1 is validated automatically.

Ch1 selects automatically the unit "degree Celsius": verification possible in the Vert menu → Ch1 → Vertical scale.

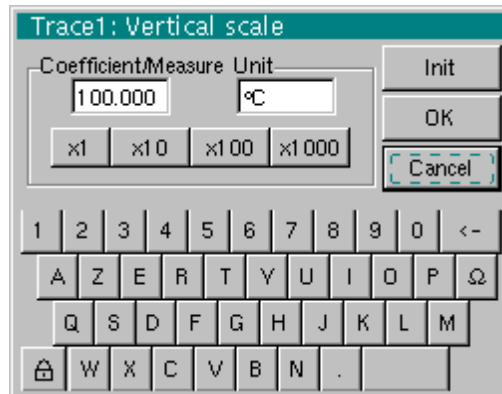

Adjust the vertical sensitivity to 50°C/div. Three options:



- using the keys opposite,
- selecting channel 1 using the key opposite. Adjust the sensitivity, displayed at the bottom right of the screen, using the scroll bar with the stylus,
- with the Vert Menu → CH1 → Sensitivity/Coupling: 50°C

The CH1 coupling was already adjusted in DC automatically by the probe.

The symbol $\overline{=}$ appears in the parameters of the CH1 trace.

Adjust the recording period or the sampling interval (for example: 60 s)



- using the keys *opposite*,
- or in the "Horiz" menu → Horizontal scale

Adjust the trigger parameters: threshold type and level.

Example: High triggering on channel 1 represented by the symbol $\overline{=}$ with a level of 61.3°C. On the other channels: no triggering.

Operation: 2 options



- Press on CH1 and on the key opposite to select the required triggering. Repeat for all channels.
To adjust the level, select the symbol $\overline{=}$ using the stylus and adjust it to the required level.
- Go to the "Trigl" menu → Source/Level and adjust the type and level of triggering required on each channel.

Applications (cont'd)

Triggering after adjustment window

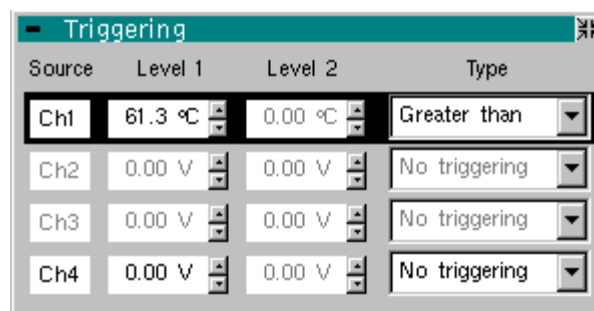

Adjust the position of the vertical position indicator of channel CH1 to -149°C, as follows:



- Press key CH1, then on the keys opposite. The position of the indicator is displayed at the bottom right of the screen.
- Apply the end of the temperature probe to the end of the soldering iron.
- When the end is in position, launch acquisition using the key opposite.
- Connect the soldering iron.

Resulting Curve

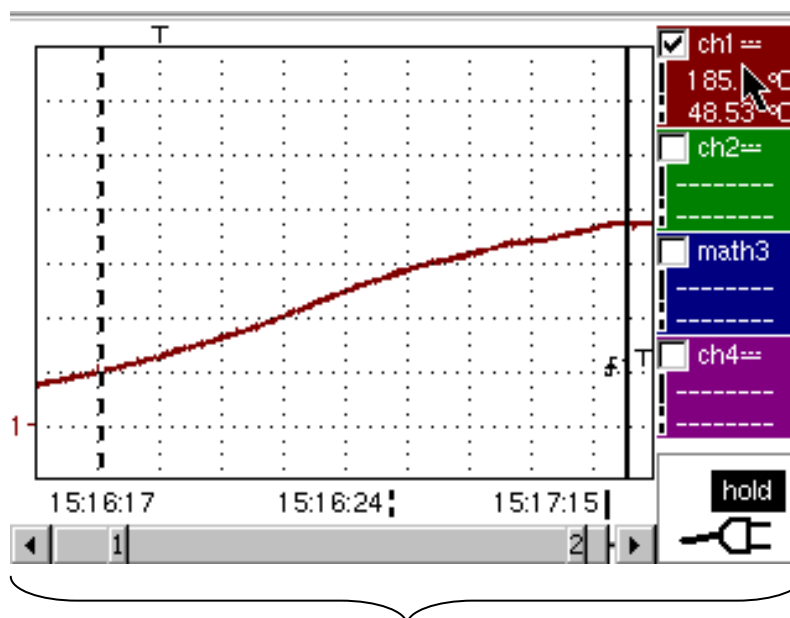

This acquisition shows the heating dynamic of the soldering iron.

Applications (cont'd)

Analysis of soldering iron cooling

The acquisition parameters must be changed.

- Sensitivity: 50°C/division
- Recording period: 10 minutes
- Trigger type: low,
- Trigger level: 140°C,
- Position of ch1 ground indicator: id.

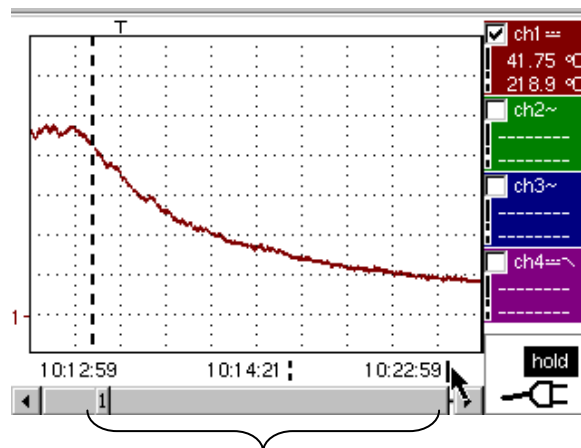

Iron cooling:
a dynamic study is possible using this acquisition.

Overall operation of soldering iron

Last acquisition: the iron heats, operates and cools.

Acquisition parameters:

- Vertical scale, acquisition period, coupling, ground indicator: identical
- No triggering on channels: manual shutdown of acquisition using key opposite.

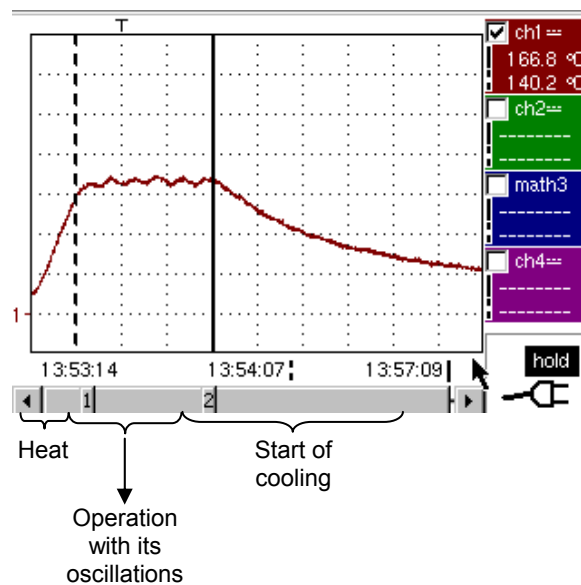

Applications (cont'd)

14. ETHERNET network application examples

a) File transfer from a PC via the network

The files in the oscilloscope's "File Management" menu (see §. "Util" Menu) can be downloaded onto a PC (or uploaded from a PC) via an ETHERNET network.

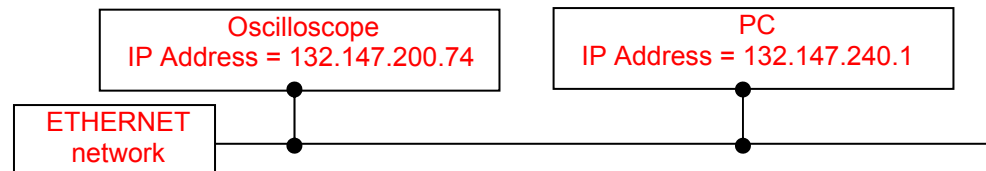

- Use a suitable ETHERNET cable to link the oscilloscope to the network.
- Open the oscilloscope's "Network" menu.
- Enter the IP address manually or automatically using the icon "provided by a DHCP server" (if the server is accessible).
- Then validate the information by choosing **OK**.

 *Example: 132.147.200.74*

- Use a PC connected to this network.
- In your browser, type in the URL zone: ftp://132.147.200.74
A list of the files is then displayed.
- 👉 *If an SD Card is present, the entire memory of the SD Card is displayed on the FTP server and not only the specific "metrix" folder.*
- You can use your browser to:
 - copy files (PC → Scope or Scope → PC),
 - delete files,
 - rename files.

👉 *The SX-METRO software (option) simplifies file transfer via the ETHERNET network.*

Applications (cont'd)

b) Hard copy of the screen on a network printer

Screen copying can be initiated on a network printer.

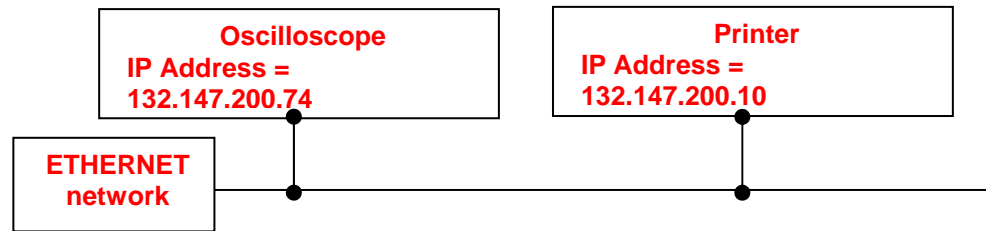

- Use a suitable ETHERNET cable to link the oscilloscope to the network.
- Open the oscilloscope's "Network" menu.
- Enter the IP address manually or automatically using the icon "provided by a DHCP server" (if the server is accessible).
 - ✎ Example: 132.147.200.74
- Enter the IP address of the network printer using the table of usable numbers after selecting the zone to be modified.
 - ✎ Example: 132.147.200.74
- Specify the name of the required printer (✎ Example: LaserJet 4)
 - ☞ To find out the IP address of the server or the name of the printer, contact the network administrator responsible for your IT installation.
- Then validate the information by choosing **OK**.
- Open the "Hardcopy" menu (See §. "Util" Menu) of the oscilloscope.
- According to the printer connected to the network, select the print format or type of printer.
 - ☞ The use of BMP and GIF graphic formats is reserved for printing through a "Virtual Printers" LDP type server (see p. IX - 188).
- Validate the color or black/white option.
- Validate the Network option of the port menu.
- Configure the oscilloscope so that it displays the screen as you wish to print it.



Start the required print operation by pressing the key *opposite*.

Applications (cont'd)

c) Installation of an FTP server on a PC

This application note is designed to make an FTP server function (FileZilla server) in basic mode on your PC. You will find more explanations on the configuration and use of this server on the site ["sourceforge.net/projects/filezilla"](http://sourceforge.net/projects/filezilla).

Why install an FTP server on your PC?

- This can be used to save the files generated on the device directly on the PC's hard drive without having to switch the memory card between the device and the PC.

Equipment required

- A PC connected to the ETHERNET network.
- On the PC, deactivate any firewalls via the control panel.
- Your SCOPIX should also be connected to the ETHERNET.

Installing an FTP fileZilla server

On your PC, log onto the Internet site "sourceforge.net/projects/filezilla"

1. Download the FileZilla server software.
2. Launch the installation of the software by using all the default options.
3. Launch the execution of the application named FileZilla Server Interface.
4. In the window displayed, tick the box "Always connect to this server":

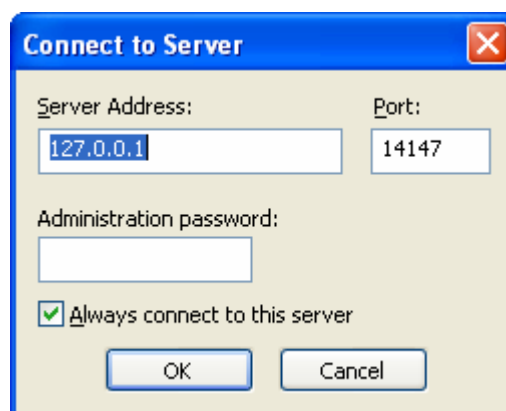

Applications (cont'd)

5. In the Edit menu, click on Users to display the following:

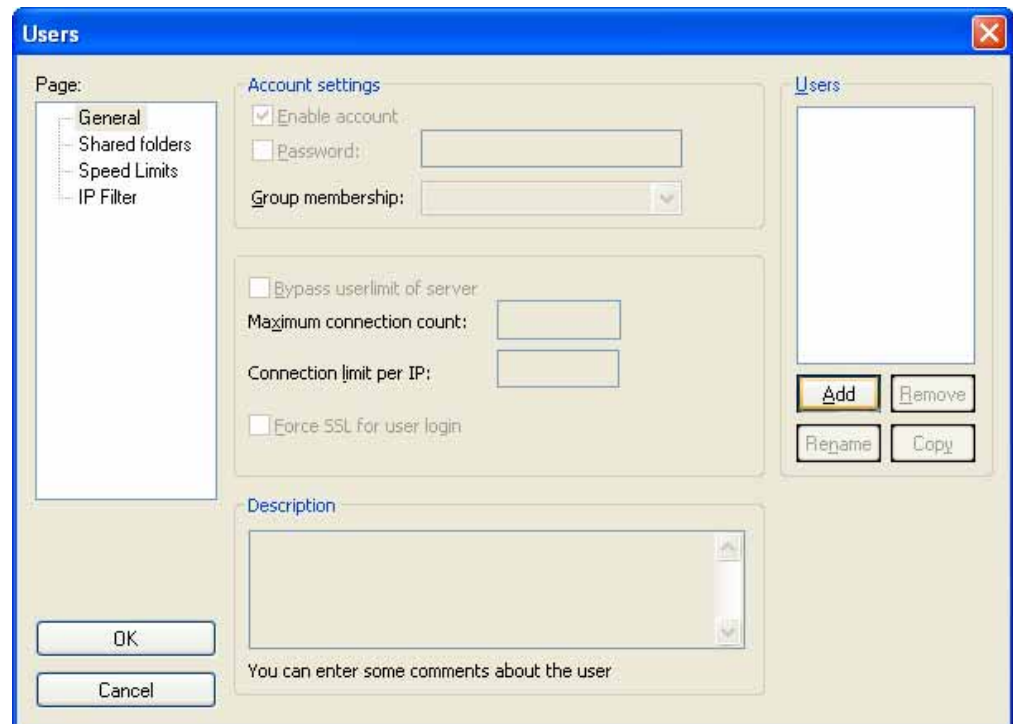

6. Click on "Add", and the window "Add user account" will appear:

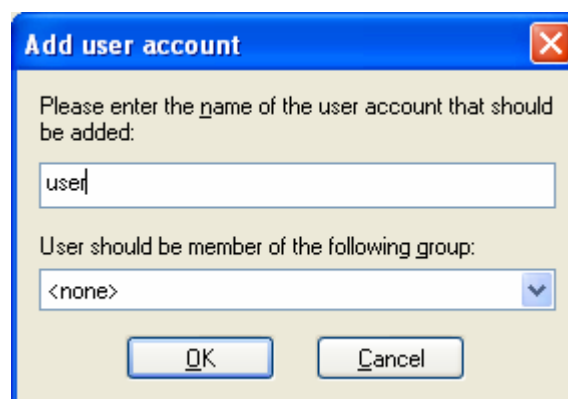

7. Create a user.
8. Click on "OK".

Applications (cont'd)

9. In the “Page” list, click on the option “Shared folders”, in the top left:

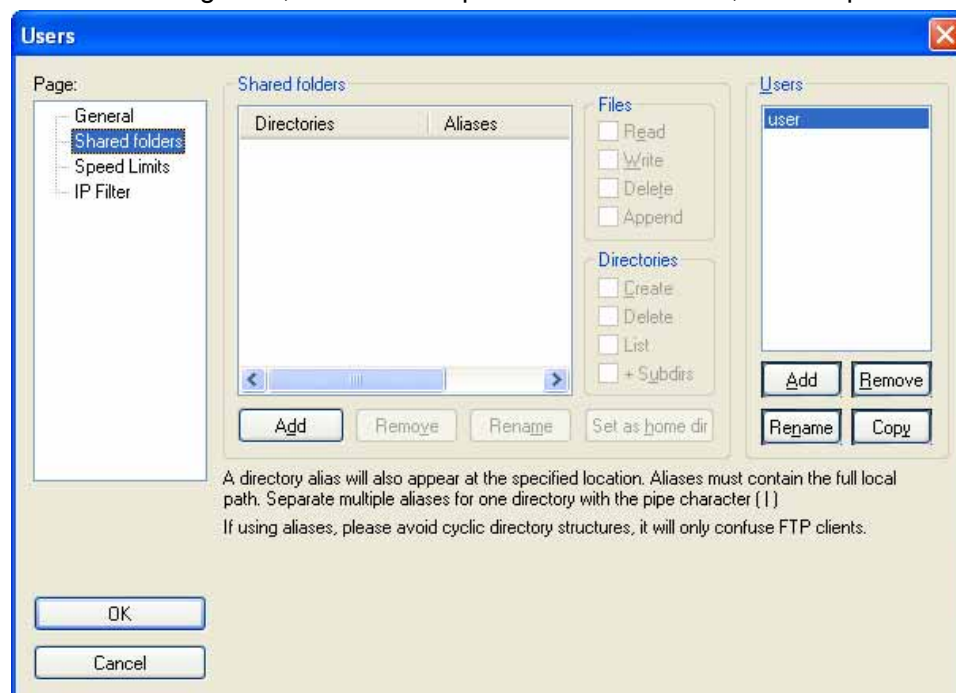

10. Using the "Add" button under the "Shared folders" window, choose a directory on the disk in which the “user” can read and write files from SCOPIX.
11. In the Files list, check the options “Read”, “Write” and “Delete”.
12. In the “Directories” list, check the “List” option.

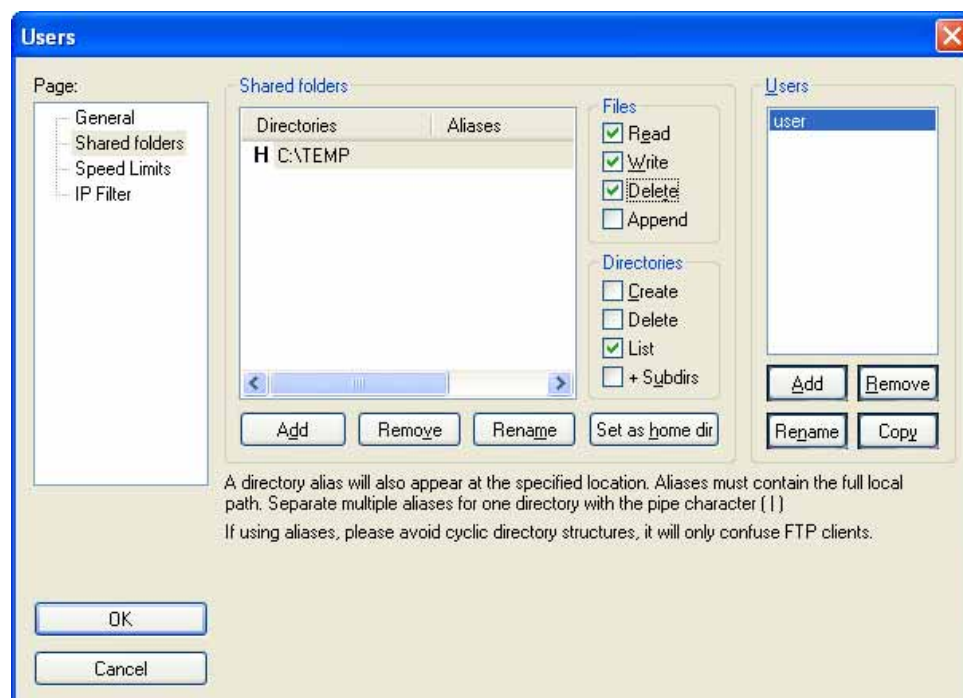

13. Click on OK to validate all options.
14. Your FTP server is now configured; you can close the FileZilla Server Interface application.

Applications (cont'd.)

SCOPIX settings

15. In SCOPIX, go into advanced mode "Util" → "Advanced Mode"
16. Open the menu "Util" → "Config I/O Ports" → "Network"
17. Click twice on the button ".../..."
18. Configure the FTP server (IP address of the PC on which the fileZilla Server was installed, user name and password if it has been defined).
19. Save a trace in the file via the menu "Memory" → "Trace" → "Save.TXT".
Tick the box "on the FTP server".

Validate the save by clicking on .

Applications (cont'd.)

d) Virtual Printers

"**Virtual Printers**" is an application that must be installed on a PC running Windows 2000, XP or Vista.

It manages METRIX oscilloscope printouts via an ETHERNET Connection. Your PC becomes a LPD server and the oscilloscopes are its clients.

This server manages all printing for the clients on the printers that are connected to it.

"**Virtual Printers**" is on the CD delivered with your instrument. It can also be downloaded from the site www.chauvin-arnoux.com.

Advantages

- The PC on which "**Virtual Printers**" is installed centralizes print requests from SCOPIX clients and reroutes them to the printer peripherals.
- SCOPIX uses the BMP / GIF printing format whatever the printer selected.
- Full page, A4 format, landscape or portrait printing.
- Configure printers directly using **Virtual Printers**.

Graphic interface

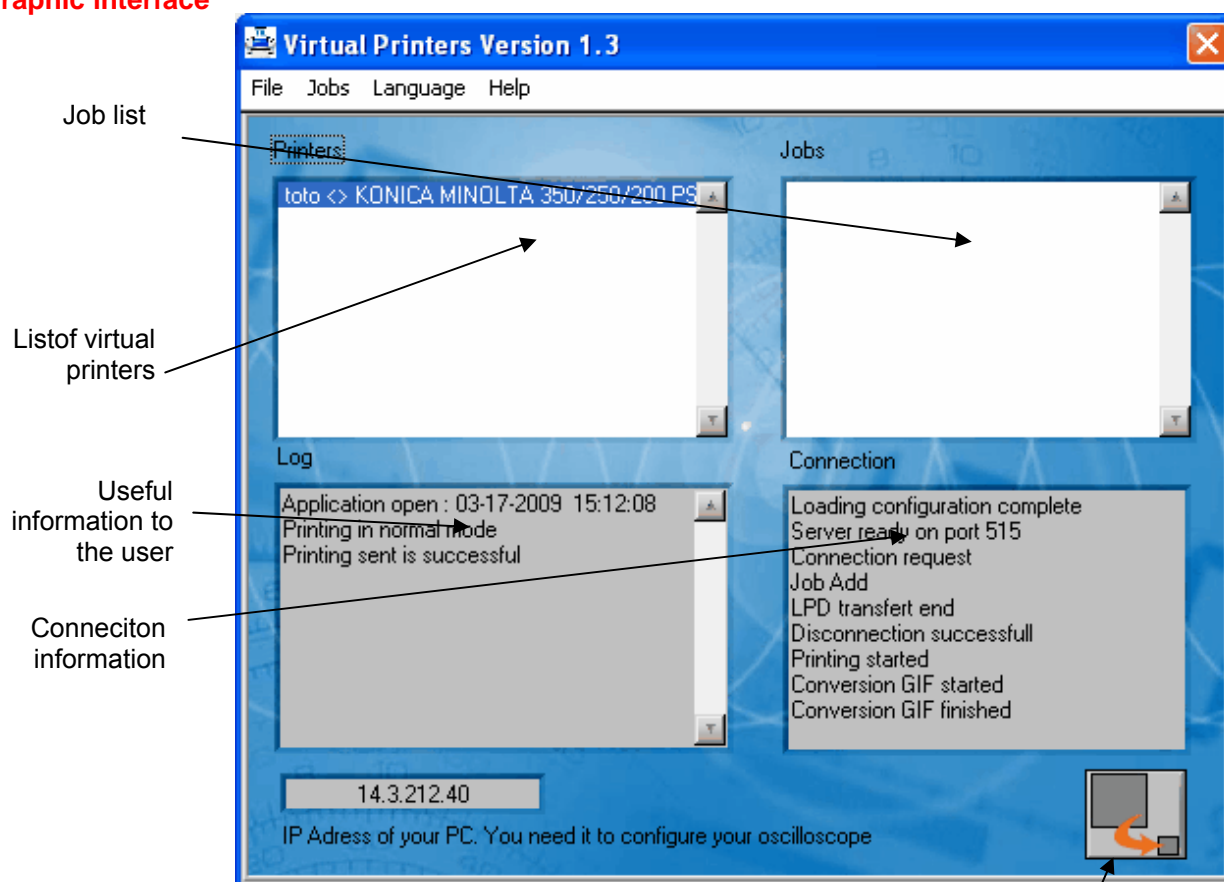

Setting the application icon on the task bar

Applications (cont'd)

Spooler The spooler is a directory used for temporary storage of printing data before it is sent to the printer.

This directory is defined in: File → Spooler.

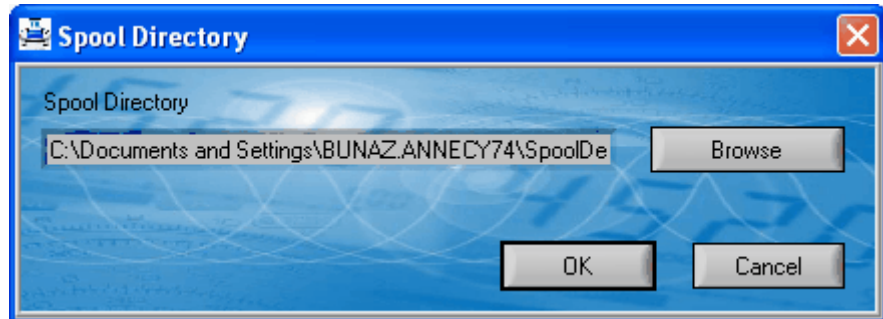

In the example above the temporary data is stored in the following directory:
"c:\Spool"

☞ *In this directory you will also find a file called **"Impression.log"** that contains the data displayed in the software's Log window once it is closed.*

Add printer Creating a virtual printer

LPD Printer name: Printer name defined by the user

Printing modes

- **classical:**
 SCOPIX must transmit GIF or BMP format data.
 The scope image is stored in the spooler. It is then sent to the printer via its print driver.
 This mode is compatible with all printers as long as the printer driver is correctly installed on the station on which the software is run.
- **transparent:**
 The data is sent to the printer without being interpreted by Virtual Printers.
 SCOPIX must therefore transmit the data in a format understandable by the printer (≠ GIF and ≠ BMP).

Available printers: List of printers installed on the PC.

Property: opens the Windows configuration panel.

Applications (cont'd)

Example :

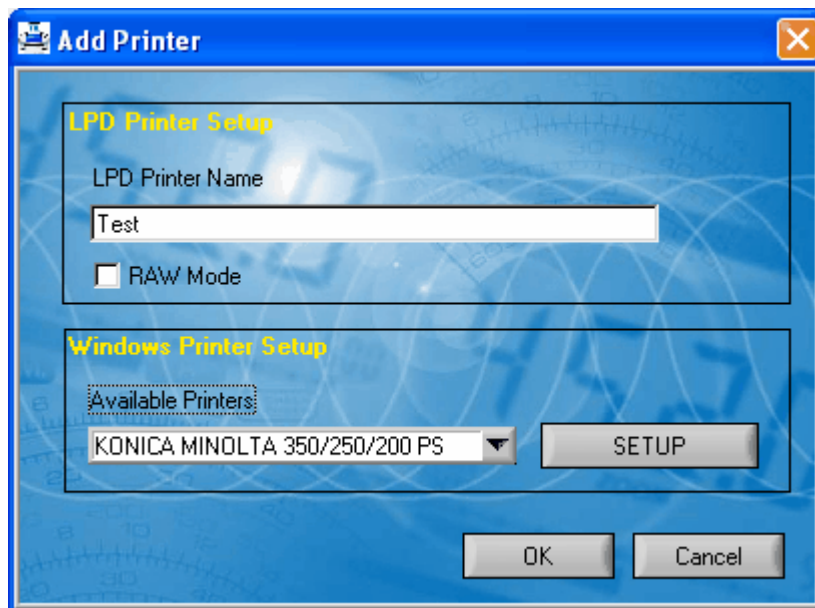

The following window appears :

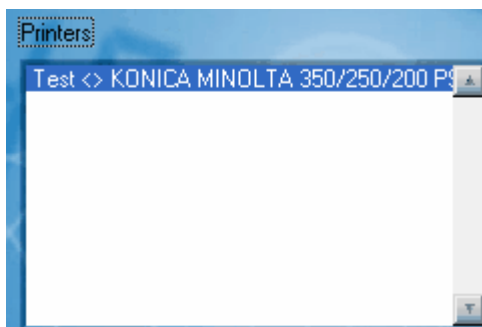

Thus, all the impressions sent by the oscilloscope with the name "Test" will be printed by the printer Konica Minolta.

Application (cont'd)

Print job menu

- Suspend the print queue :
The next requests (Jobs) sent by the oscilloscopes are stored while waiting to be unblocked.
- Unblock the queue : processes the requests held in the queue (See **Suspend the queue**).
- Adds a PC file to the print queue :

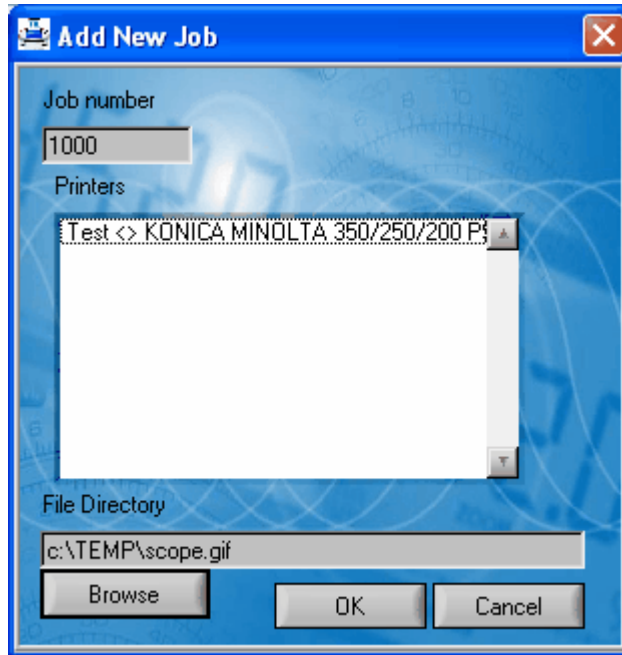

Job Number: contains the identifier generated by Virtual Printers.

Printers: list of virtual printers

File Path: name of the file to be printed

☞ *The file format must be compatible with the selected virtual printer configuration.*

- Delete Job : deletes a job from the queue.

☞ *The job will not be removed from the display until it has been processed.*

- Delete All : deletes all Jobs in the queue

Applications (cont'd)

Oscilloscope Configuration

To configure your oscilloscope correctly you must have the following information available:

- Your PC's IP address, which you can see in the box at the bottom of the software

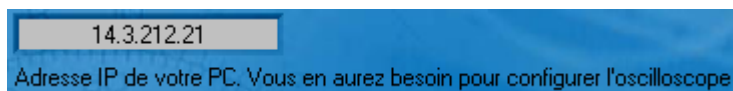

In our example: "14.3.212.21"

- The name of the virtual printer created earlier: "Test"

On SCOPIX, in: Util → I/O Port Config → Network

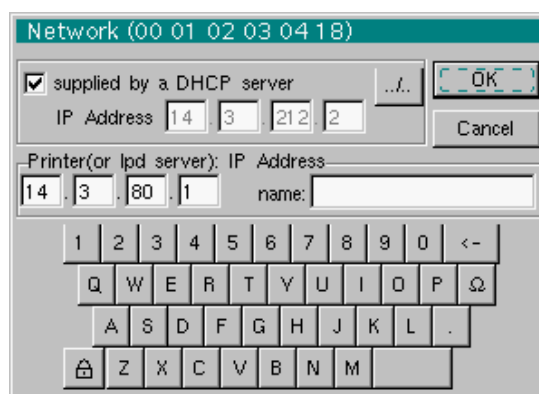

On SCOPIX, in: Util → Hardcopy

- Choose either "bitmap BMP" or "GIF" format.
- Select the "Network (LPD)" port.
- Close the dialogue box using "OK".

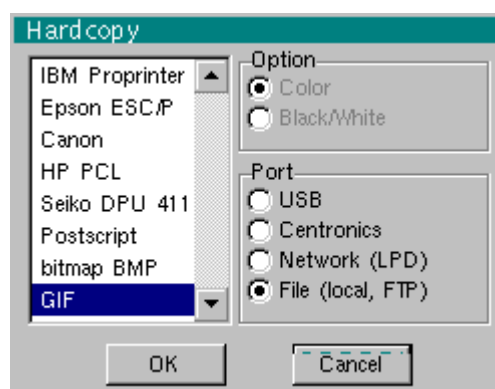

Technical Specifications

« Oscilloscope » Function

Only the values assigned with a tolerance or limits are guaranteed values (after half an hour warming up). Values without a tolerance are for information only.

Vertical deviation

Characteristics	OX 7102 ^{III} OX 7104 ^{III}	OX 7202 ^{III} OX 7204 ^{III}
Number of channels	4 channels : CH1 to CH4 (OX 7x04) 2 channels : CH1 & CH4 (OX 7x02)	
Vertical ranges	2.5 mV to 200 V/div. <i>Variation in steps (no continuous variable coefficient)</i>	
BP ¹ at -3 dB	200 MHz <i>Measured on 50 Ω load with a 6 div. amplitude signal</i>	
Max. input voltage without accessories	600 VDC, 600 Vrms, 850 Vpk (DC + peak AC at 1 kHz) without 1/10 probe 1 kVrms with Probix HX0030 probe derating -20 dB/decade from 100 kHz to 200 MHz	
Input type	Probix safety connector: class 2, insulated inputs	
Vertical offset dynamic	± 10 divisions on all ranges	
Input coupling	AC DC GND	10 Hz to 200 MHz 0 to 200 MHz reference
Bandwidth limit	at ≈ 15 MHz, 1.5 MHz, 5 kHz	
Rise time on all vertical ranges 2.5 mV to 200 V/div.	≈ 3,5 ns	≈ 1,9 ns
Cross-talk between channels	> 70 dB <i>Same sensitivity on both channels</i>	
Response to rectangular signals: 1 kHz and 1 MHz	Positive or negative overshoot Overshoot : ≤ 4 %	
Vertical resolution of the display	± 0.4 % of full scale (without ZOOM) 0.025 % in ZOOM mode (12 bits)	
Peak-to-peak gain accuracy	± 2 % with x4 averaging at 1 kHz	
Accuracy of vertical DC measurements with offset and averaging of 16	± [2,2 % (reading) + 11% (sensitivity) + 250 μV] applies to : Vmin., Vmax., Vhigh, Vlow, Vavg., curs(1), curs(2)	
Accuracy of vertical AC measurements without offset at 1 kHz and averaging of 16	± [2 % (reading) + 1% (sensitivity)] applies to : Vamp, Veff, Over+, Over-	
Resolution of measurements	12 bits	
Accuracy of vertical offset	± [0.2 % (reading) + 10% (sensitivity) + 250 μV]	
Vertical ZOOM function on saved or acquired trace	ZOOM factor : 16 max.	
Electrical safety without accessories	600 V, CAT III, double insulated	
Max. voltages (not for accessories)	floating: 600 V, CAT III, from 50 to 400 Hz between channels : 600 V, CAT III, from 50 to 400 Hz	
Input impedance	1 MΩ ± 0,5 % ca.12 pF	

¹ Beyond 1 V/div. BW is guaranteed by the rise time

Technical Specifications (cont'd)

« Oscilloscope » Function

Horizontal deflection (time base)

Characteristics	OX 7102 ^{III} - OX 7104 ^{III} - OX 7202 ^{III} - OX 7204 ^{III}	
	without the EXTENDED ACQUISITION MEMORY option	with the EXTENDED ACQUISITION MEMORY option
Time base ranges	35 ranges, from 1 ns to 200 s/div.	
Time base accuracy	$\pm [50 \text{ ppm} + \max (500 \text{ ps}, 1 \text{ sample})]$	
Sampling rate	2.5 GS/sec. in real time 50 GS/sec. with repetitive signal	2.5 GS/sec. in real time 100 GS/sec. with repetitive signal
Time measurement accuracy	$\pm [(0.02 \text{ div.}) \times (\text{time/div.}) + 0,01 \times \text{reading} + 1 \text{ ns}]$	
Horizontal ZOOM	Zoom factor : from x 1 to x 5 recording memory capacity : 2,500 samples per channel	Zoom factor : from x 1 to x 100 recording memory capacity : 50,000 samples per channel
	In ZOOM and normal modes : the same sequence of time base range is used. The horizontal resolution of the screen is 500 samples for 10 divisions.	
Mode XY	The bandwidths are identical in X and in Y. (See §. Vertical deflection).	
Phase error	$< 3^\circ$	
Representation	temporal or frequential (FFT)	
Fast Fourier Transform	<ul style="list-style-type: none"> • calculation on the traces present in the screen area • dynamic refreshment as a function of the signal observed in RUN mode • windowing: rectangle, Hamming, Hanning, Blackman • scales: logarithmic or linear • automatic adjustment with autose function 	

Technical Specifications (cont'd)

« Oscilloscope » Function

Acquisition chain

Characteristics	OX 7102 ^{III} - OX 7104 ^{III} - OX 7202 ^{III} - OX 7204 ^{III}	
	not equipped with the EXTENDED ACQUISITION MEMORY option	equipped with the EXTENDED ACQUISITION MEMORY option
ADC resolution	12 bits	
Maximum sampling rate	2.5 GS/s in real time 50 GS/s in repetitive signal (ETS) 1 converter per channel	2.5 GS/s in real time 100 GS/s in repetitive signal (ETS) 1 converter per channel
Transient capture MIN/MAX Mode	Minimum width of detectable glitches ≥ 2 ns	
	1250 MIN/MAX couples	on [1ns 5ms] range: 1250 MIN/MAX couples arranged in acquisition memory of 50 000 count on [20ms 200s] range: 25 000 MIN/MAX couples
Acquisition memory depth	2500 count per channel	50 000 count per channel
PRETRIG	0 - 9,5 div. 0 - 47,5 div. (zoom)	0 - 9,5 div. 0 - 950 div. (zoom)
POSTRIG	0 - 20 div. 0 - 100 div. (zoom)	0 - 20 div. 0 - 2000 div. (zoom)

Technical Specifications (cont'd)

Oscilloscope Mode

Format of the various files

Characteristics	OX 7102 ^{III} - OX 7104 ^{III} - OX 7202 ^{III} - OX 7204 ^{III}	
	not equipped with the EXTENDED ACQUISITION MEMORY option	equipped with the EXTENDED ACQUISITION MEMORY option
Back-up memories	Managed in a file system for storing various objects : <ul style="list-style-type: none"> - traces - text - configurations - mathematical functions - print files - image files - etc. 	
Available memory size for the file system	<ul style="list-style-type: none"> • Instrument internal memory: 2 Mb • with « Micro SD » memory card : 128 Mb to 2 Go, acc. to card type 	
Trace files acquired in SCOPE mode Extension: .TRC	Binary format Size: ≈ 10 kb	Binary format Size: ≈ 200 kb
Trace files acquired in RECORDER mode Extension: .REC	Binary format Size: ≈ 40 kb	Binary format Size: ≈ 800 kb
Configuration files Extension: .CFG	Binary format Size: ≈ 1 kb	
Print files Extension: .EPS .PRN .PCL	The format depends on the print type Size < 200 kb	
Image files Extension: .BMP .GIF	Binary format Size .BMP: ≈ 40 kb .GIF: ≈ 5 kb	
Mathematical function files Extension: .FCT	Text format Size: < 1 kb	
Files containing text Extension: .TXT	Text format .TXT extension files may contain measurements made in the instrument's various acquisition modes	
.TXT file containing a trace acquired in SCOPE mode	Size ≈ 25 kb	Size ≈ 500 kb
.TXT file containing measurements in METER mode	Size ≈ 80 kb	Size ≈ 800 kb
.TXT file containing a trace acquired in RECORDER mode	Size ≈ 25 kb	Size ≈ 500 kb

Technical Specifications (cont'd)

« Oscilloscope » Function

Processing of measurements

Mathematical functions	Equation editor (functions on channels or simulated) Addition, subtraction, multiplication, division and complex functions between channels.	
Automatic measurements	Time measurements rise time fall time positive pulse negative pulse cyclic ratio period frequency phase. counting integral	Level measurements DC voltage rms voltage peak-to-peak voltage amplitude max. voltage min voltage high plateau low plateau overshoot
	Resolution of the measurements	12 bits / display on 4 digits
Measurements by cursors or automatic measurements		
DC vertical measurements accuracy	$\pm [1 \% (\text{reading} - \text{offset}) + \text{vertical offset accuracy} + (0.05 \text{ div.}) + (\text{V/div.})]$	
Accuracy of 2-cursor time measurements	$\pm [0.02 \times (t/\text{div.}) + 0.01 \% (\text{reading}) + 1 \text{ ns}]$	
	The cursors are attached to the trace, but they can be detached to perform a measurement between channel (offset, delay, etc.)	
	In XY mode, the cursors are not attached to the trace.	

Technical Specifications (cont'd)

Oscilloscope Mode



Display

Characteristics	OX 7102 ^{III} - OX 7104 ^{III} OX 7202 ^{III} - OX 7204 ^{III}
Display screen	LCD 5.7" TFT (color display)
	LED back-lighting
Light	Continuous adjustment
Resolution	1/4 VGA, i.e. 320 pixels horizontally x 240 pixels vertically
Screen saver	Delay can be selected in the Util Menu → Configuration 15', 30', 1 hour or none
Display modes	<p>Vector Acquired samples, interpolated samples, averaging, linear interpolation between 2 acquired samples.</p> <p>Envelope Display of min. and max. on each abscissa, acquired in several bursts</p> <p>Averaging Range of factors: none, 2, 4, 16, 64</p> <p>All acquisition Display of all the samples acquired in a burst with linear interpolation</p>
Graticule	Complete or Edges
Indications on screen	<p>Triggering Trigger level position (with coupling and overshoot indicator) Position of the Trigger point on the bargraph and on the top edge of the screen (with overshoot indicators)</p> <p>Traces Trace identifiers, activation of the traces Position, Sensitivity Ground reference High and low overshoot indicators if traces are off screen</p>

Miscellaneous

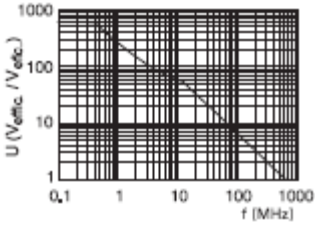

1/10th probe calibration signal	Form: rectangular Amplitude: \approx 0- 3 V Frequency: \approx 1kHz Dual insulation / channels: 600V CAT III, 1000V CAT II ☞ Connect the cold point of the probe to the cold point of the probe calibration output.
Autoset	Search time < 5 s Frequency range > 30 Hz Range of amplitude 15 mVpp to 400 Vpp Cyclic ratio limits from 20 to 80 %

Technical Specifications (cont'd) Accessories

Probix	<i>These specifications apply to following PROBIX and development.</i>	
<p>HX0030 - 1/10 Probe</p> 	<p>1/10 probe equipped with a LED and programmable control buttons</p> <p>Measurement categories 600V CAT III, 1000V CAT II</p> <p>Accuracy $\pm 1\%$ (VDC)</p> <p>Bandwidth DC at 250 MHz</p> <p>Input capacity 15 pF</p> <p>Compensation range 12 pF to 25 pF</p> <p>Rise time 1.2 ns</p> <p>Input impedance 10 MΩ at 1%</p> <p>DERATING see curve opposite</p>	
<p>HX0031 - BNC</p>	<p>Probix for BNC cable connection</p> <p>Measurement category 600V CAT III</p> <p>Accuracy $\pm 1\%$ (VDC)</p> <p>Bandwidth 250 MHz</p>	
<p>HX0032 - BNC 50 Ω</p>	<p>50 Ω Probix for BNC cable connection</p> <p>Measurement category 600V CAT III</p> <p>Max. output 2 W max. (i.e 10 VDC on 50 Ω)</p> <p>Accuracy $\pm 1\%$ (VDC)</p> <p>Bandwidth 250 MHz</p>	
<p>HX0033 - Banana</p>	<p>Probix for connection to 'banana' type cables</p> <p>Measurement category 600V CAT III</p> <p>Accuracy $\pm 1\%$ (VDC)</p> <p>DERATING 20 dB/decade for F >100 kHz</p>	
<p>HX0034 - Current clamp</p>	<p>20 mV/A Current clamp 80 A peak, AC/DC</p> <p>Measurement category 600V, CAT II</p> <p>Accuracy $\pm 1.5\%$ ± 2 mA from 0 to 45 A peak $\pm 4\%$ from 45 to 80 A peak</p> <p>Bandwidth 500 kHz @ -1dB, 1 MHz @ -3dB 8 A max. @ 0.5 MHz (*)</p> <p>Rise time 350 ns from 10% to 90%</p> <p>DERATING 40 A max. @ 100 kHz 4 A max. @ 1 MHz</p> <p>Phase error $\pm 1^\circ$</p> <p>Output voltage for $\leq \pm 0.3$ mVDC i.e. ± 15 mADC</p> <p>(*) $I_p = 0$</p>	
	<p>With the HX0034 current clamp, the service voltage between channels becomes 600V CAT II.</p>	

Technical Specifications (cont'd)

Accessories

<p>HX0035 - K Thermocouple</p> 	<p>Adaptor for K Thermocouple, 2 mV/°C</p> <p>Measurement category 30V CAT I</p> <p>Measuring range -40°C to 1,250°C</p> <p>Accuracy ± 1 % ± 3.5°C typical</p> <p><i>Electric insulation between thermocouple and earth. No electrical insulation between 2 thermocouples, the service voltage between channels becomes 600V CAT II.</i></p>
<p>HX0036 - PT100</p> 	<p>Adaptor for PT100 2 mV/°C</p> <p>Measurement category 30V CAT I</p> <p>Measuring range - 100°C to + 500°C</p> <p>Accuracy ± 1 % ± 1.5°C typical</p> <p><i>Electric insulation between PT100 captor and earth. No electrical insulation between 2 PT100 captors, the service voltage between channels becomes 600V CAT II.</i></p>

Technical Specifications (cont'd)

Accessories

<p>HX0072 - AmpFLEX Probe</p>	<p>Standards applied IEC 61010-2-032 : 2002 EN 61326-1 (07/1997) + A1 (10/1998) + A2 (09/2001)</p> <p>Reference conditions Only one conductor inserted in the flexible toroid Conductor position: centred Clamping : \varnothing 240 mm Temperature : from 18°C to 28°C Relative humidity: from 20 % to 75 % Frequency range: 40 Hz to 400 Hz Start-up before measurement: 1min External DC magnetic field: < 40 A/m No external AC magnetic field No external electric field Sinusoidal signal</p> <p>Use conditions Altitude < 2000 m, indoors</p> <p>Range for use from 1 A to 3500 A_{RMS}</p> <p>Specified range from 5 A to 3000 A_{RMS}</p> <p>Accuracy in the measurement range 1 % \pm 0.5 A</p> <p>50 Hz dephasing 1.3° max. (1° typ.)</p> <p>Residual current at I = 0 A (noise) 1.5 A_{RMS} max. (0.5 A_{RMS} typ.)</p> <p>Bandwidth at -3 dB 10 Hz to 200 kHz</p> <p>Power-up and to-idle time 1.5 μs</p> <p>Residual DC current 20 A max. (invisible with AC coupling)</p> <p>Delay time 1.2 μs max.</p> <p>Frequency derating 3000 A if 10 Hz < Freq. < 10 kHz 50A if Freq. = 200 kHz</p> <p>Electromagnetic immunity at 10 V/m error < 3 % of measurement extent</p> <p>Operating temperature -10°C to +55°C</p>
<p>HX0073 - MiniAmpFLEX Probe</p>	<p>Standards applied IEC 61010-2-032 : 2002 EN 61326-1 (07/1997) + A1 (10/1998) + A2 (09/2001)</p> <p>Reference conditions Only one conductor inserted in the flexible toroid centred Conductor position: centred Clamping : \varnothing 35 mm Temperature : from 18°C to 28°C Relative humidity: from 20 % to 75 % Frequency range: 40 Hz to 400 Hz Start-up before measurement: 1min External DC magnetic field: < 40 A/m No external AC magnetic field No external electric field Sinusoidal signal</p> <p>Use conditions Altitude < 2000 m, indoors</p> <p>Range for use from 0.2 A to 350 A_{RMS}</p> <p>Specified range from 1 A to 300 A_{RMS}</p> <p>Accuracy in the measurement range 1 % \pm 70 mA</p> <p>50 Hz dephasing 1.3° max. (1° typ.)</p> <p>Residual current at I = 0 A (noise) 0.2 A_{RMS} max. (0.1 A_{RMS} typ.)</p> <p>BW min.at -3 dB from 10 Hz to 2.5 MHz (from 10 Hz to 3 MHz typ.)</p> <p>Power-up and to-idle time < 110 ns</p> <p>Residual DC current 2 A max. (invisible with AC coupling)</p> <p>Delay time 600 ns max.</p> <p>Frequency derating 300 A if 10Hz < Freq. < 100 kHz 10 A if Freq. > 1 MHz</p> <p>Electromagnetic immunity at 10 V/m error < 3 % of measurement extent</p> <p>Operating temperature -10°C to +55°C</p>

Technical Specifications

« Multimeter » Function

Only the values assigned with a tolerance or limits are guaranteed values (after half an hour warming up). Values without a tolerance are for information only.

Display	8000 count in voltmeter		
Input impedance	1 MΩ		
Max. input voltage	600 Vrms sinus and 800 VDC, without probe 1000 Vrms and 1400 VDC, with HX0030 probe		
Floating max. voltage	600 Vrms up to 400 Hz CAT III, 1000 V CAT II		
DC measurement			<u>HX0030 probe</u>
Ranges	0.8 V	8 V	80 V 800 V 8 kV
Resolution	0.1 mV	1 mV	10 mV 0.1 V 1 V
Accuracy	0.3% of R ± 15 cts in DC from 10% to 100% of scale		
Common mode rejection	> 70 dB at 50 or 60 or 400 Hz		
AC, AC+DC measurements			<u>HX0030 probe</u>
Ranges	0.6 V	6 V	60 V 600 V 6 kVrms
	0.8 V	8 V	80 V 800 V 8 kVDC
Resolution	0.1 mV	1 mV	10 mV 0.1 V 1 V
Accuracy with AC+DC coupling	1% of R ± 15 cts from DC to 5 kHz from 10% to 100% of scale (to 580 Vrms)		
	2% of R ± 15 cts from 5 to 10 kHz id.		
(R = Reading)	3% of R ± 15 cts from 10 to 200 kHz id.		
AC	1% of R ± 15 cts from 40 Hz to 5 kHz id.		
	2% of R ± 15 cts from 5 to 10 kHz id.		
	3% of R ± 15 cts from 10 to 200 kHz id.		
Common mode rejection	> 70 dB at 50 or 60 or 400 Hz		
Digital filter at 625 Hz	Low-pass filter Cutoff frequency.....625Hz Order..... 94 Passband ripple0.5dB Transition band 0.02 Stopband attenuation..... 50.0dB		
Resistance measurement	On Channel 1		
Ranges (end of scale)	Ohmmeter	Resolution	Measuring current
	80 Ω	0.01 Ω	0.5 mA
	800 Ω	0.1 Ω	0.5 mA
	8 kΩ	1 Ω	5 μA
	80 kΩ	10 Ω	5 μA
	800 kΩ	100 Ω	500 nA
	8 MΩ	1000 Ω	50 nA
	32 MΩ	10 kΩ	50 nA
Accuracy	± 0.5% of R + 25 cts from 10% to 100% of scale		
Open circuit voltage	≈ 3 V		
Continuity measurement	On Channel 1		
Beeper	< 30 Ω ± 5 Ω		
Measuring current	≈ 0.5 mA		
Beeper response	< 10 ms		

Technical Specifications (cont'd)

« Multimeter » Function

Diode test	On Channel 1		
<i>Voltage</i>	in open circuit : $\approx + 3.3 \text{ V}$		
<i>Accuracy</i>	0.5 % + 5 of R		
<i>Measuring current</i>	$\approx 0.6 \text{ mA}$		
Capacitance measurement	On Channel 1		
<i>Ranges</i>	Capacimeter	Resolution	Measuring current
	5 mF	1 μF	500 μA
	500 μF	0.1 μF	500 μA
	50 μF	0.01 μF	500 μA
	5 μF	1 nF	500 μA
	500 nF	100 pF	5 μA
	50 nF	10 pF	5 μA
	5 nF	1 pF	500 nA
<i>Accuracy</i>	- on 5 nF range (measurement with a shielded cord) : from 500 pF to 1 nF : $\pm 6\% + 10 \text{ UR}$ from 1 nF to 2 nF : $\pm 4\% + 10 \text{ UR}$ > 2 nF : $\pm 2\% + 10 \text{ UR}$ - on other ranges : $\pm 2\% + 10 \text{ of R}$ from 10% to 100% of full scale		
	Use cables as short as possible.		
Frequency measurement	20 Hz to 200 kHz on a square, sinus 20 Hz to 20 kHz on a triangle signal Accuracy : 0.2%		
Power measurements			
<i>active</i>	2% $\pm 15 \text{ cts}$ from 40 to 5 kHz		
<i>reactive</i>	4% $\pm 15 \text{ cts}$ from 5 to 10 kHz		
<i>apparent</i>	6% $\pm 15 \text{ cts}$ from 10 to 200 kHz		

Operating modes

Relative mode	Display acc. to basis measurement	Relative, Monitoring and Frequency modes are exclusive.
Monitoring (statistics)	MAX and MIN values for all measurements	
Frequency	Possible display of frequency in AC mode	
Time interval between 2 measurements	adjustable from 1 second to 1 hour	
Record duration	from 5 min 24 sec to one month	
Measurement log	Measurement display = f (time) default window of 4 min (4 measurements per second)	
RUN	Initiation of the measurements	
HOLD	Freezing of the measurement	

Technical specifications (cont'd)

« Multimeter » Function

Display		
	not equipped with the EXTENDED ACQUISITION MEMORY option	Oscilloscope not equipped with the EXTENDED ACQUISITION MEMORY option
In numeric form	Principal measurement → large-size display Secondary measurement → small-size display The touch-sensitive screen allows you to select the secondary measurement via a menu.	
Graphic trace	History of the measurements over time Objective: Presentation of the measurements as an amplitude histogram.	
Number of measurements represented on a trace	2700	27 000
Zoom	no	x1, x10

Trigger		
	Oscilloscope not equipped with the EXTENDED ACQUISITION MEMORY option	Oscilloscope equipped with the EXTENDED ACQUISITION MEMORY option
Trigger type	Triggering search by measurement analysis Recording of the trigger event (default) Triggering if detection of: <ul style="list-style-type: none"> • Measurement above threshold • Measurement below threshold • Measurement below or above threshold • Measurement outside of two defined limits 	
Trigger event period	Trigger if the condition is verified during a parameterizable period:	
<i>Min. value of the period</i>	Recording period / 675	Recording period / 6750
<i>Max. value of the period</i>	Recording period / 4	Recording period / 4

Technical Specifications

Mains « Harmonics » Analysis Mode

Display of "Harmonics"	Selection of the page in the "Display" menu
<i>Even harmonics</i>	2 to 60 + Fundamental on 2 pages
<i>Odd harmonics</i>	3 to 31 + Fundamental on 2 pages
<i>All harmonics</i>	2 to 61 + Fundamental on 4 pages
Fundamental Frequency of the signal analyzed	40 to 450 Hz
Measurement accuracy	
<i>Level of Fundamental</i>	± 2 % ± +10 of Reading
<i>Level of Harmonics</i>	± 3 % ± +10 of Reading
<i>Harmonic Distortion</i>	± 4 %

« Recorder » Mode

	Oscilloscope not equipped with the EXTENDED ACQUISITION MEMORY option	Oscilloscope equipped with the EXTENDED ACQUISITION MEMORY option
Recording period	from 2 seconds to 1 month	
Sampling rate	from 800 µs to 17 mins 51 secs	from 40 µs to 53.5 secs
Fault capture	10 faults in memory up to 500 faults in files	100 faults in memory up to 200 faults in files
Triggering	Triggering search by sample analysis; Trigger if Detection of: <ul style="list-style-type: none"> • Signal above threshold • Signal below threshold • Signal below or above threshold • Signal outside of two defined limits 	
Trigger event period	Trigger if the condition is verified during a parameterizable period:	
<i>Min. value of the period</i>	Recording period / 625	Recording period / 12500
<i>Max. value of the period</i>	Recording period / 4	Recording period / 4
Display	Search for minimum and maximum Fault search	
Vertical, horizontal accuracy	Identical specifications to those in "Oscilloscope" mode	

Technical Specifications (cont'd)

Communication interfaces

<p>USB <i>Interface</i></p>	<p>The oscilloscope can communicate with a computer via USB, using the adapter HX0084.</p>						
<p>RS232C <i>link configuration</i></p>	<p><u>Selection of speed in Bauds</u> 300, 600, 1200, 2400, 4800, 9600, 19200, 38400, 57600, 115200</p> <p><u>Parity selection</u> None, even, odd</p> <p><u>Word length selection</u> 8 bits or 7 bits</p> <p><u>Stop bit number selection</u> 1 or 2 stop bits</p> <p><u>Protocol selection</u> Hard (for RTS and CTS lines) Soft (for XON and XOFF characters) None (no protocol)</p>						
<p>ETHERNET <i>Interface</i></p>	<table border="0"> <tr> <td><u>Type</u></td> <td>10BASE-T (Twisted Pair)</td> </tr> <tr> <td><u>Lead</u></td> <td>Interface scope / RJ45 8 count</td> </tr> <tr> <td><u>Standard</u></td> <td>IEEE 802.3</td> </tr> </table>	<u>Type</u>	10BASE-T (Twisted Pair)	<u>Lead</u>	Interface scope / RJ45 8 count	<u>Standard</u>	IEEE 802.3
<u>Type</u>	10BASE-T (Twisted Pair)						
<u>Lead</u>	Interface scope / RJ45 8 count						
<u>Standard</u>	IEEE 802.3						
<p>RS232C ETHERNET <i>Interface Connector</i></p>	<p>Double insulation 600 V CAT III, 1000 V CAT II / inputs</p> <p>with : 1 USB / RS232C adapter (<i>HX0084</i>) 1 RS232C interface cord (<i>HX0042</i>) 1 ETHERNET crossed interface cord (<i>HX0040</i>)</p>						

Remote programming of the instrument by a PC

<p></p>	<ul style="list-style-type: none"> • Programming of the instrument via the RS232C or ETHERNET interface with SCPI commands • IP protocol available on ETHERNET: FTP client, FTP server, HTTP server, LPD client, DHCP client. • Specific protocol on ETHERNET ScopeAdmin Client <p><i>Refer to the remote programming manual for the list of commands.</i></p>
--	---

Warning !

Error Messages

If one of those codes (or the addition of several codes) is present when getting started : → a default has been detected.

In this case, contact your closest distributor

(See §. Maintenance).

Autotest : Error n° 0001 : Micro Problem

Autotest : Error n° 0002 : Flash Problem

Autotest : Error n° 0004 : RAM Problem

Autotest : Error n° 0008 : FPGA Problem

Autotest : Error n° 0010 : Numerisation problem on channel 1

Autotest : Error n° 0020 : Numerisation problem on channel 2

Autotest : Error n° 0040 : Numerisation problem on channel 3

Autotest : Error n° 0080 : Numerisation problem on channel 4

Autotest : Error n° 0100 : Analog problem on channel 1

Autotest : Error n° 0200 : Analog problem on channel 2

Autotest : Error n° 0400 : Analog problem on channel 3

Autotest : Error n° 0800 : Analog problem on channel 4

Autotest : Error n° 1000 : Problem on ETHERNET link

General specifications

Environment

- Reference temperature 18°C to 28°C
- Operating temperature 0°C to 40°C
- Storage temperature -20°C to +60°C
- Utilization indoors
- Altitude < 2000 m
- Relative humidity < 80% up to 35°C

Power supply

- **Battery** 9.6 V ; 3.5 Ah
 - Type Ni-MH
 - Charge time ≈ 2,30 hours with instrument switched off
≈ 5 hours with instrument operating
 - Charge life **OX 7xx4** (4-channel): approx. 2h
OX 7xx2 (2-channel): approx. 4h
in standby mode: approx. 10h
 - Screen saver (automatic standby mode) adjustable by menu: 15', 30', 1h or none
 - Auto power-off adjustable by menu: 30', 1h, 4h, 24h
- **External power supply (battery charger)**
 - Mains voltage 98 V to 264 V
 - Frequency from 50 to 60 Hz
 - Consumption < 60 VA for fast battery charging



Safety

As per IEC 61010-1 (2001):

- Insulation class 2
- Pollution level 2
- "Measurement" input overvoltage category 600 V CAT III, 1000 V CAT II

EMC

This instrument conforms the EMC NF EN 61326-1, 2006 norm. It has been tested according to an industrial environment (class A). In other environments and under specific conditions, the compatibility might be difficult to achieve.

- Emission class A instrument
- Immunity influence magnitude: 3 div. in the presence of a 10 V/m electromagnetic field.

Mechanical Specifications

Casing

- Dimensions 265 x 195 x 56mm
- Weight 2.1 kg with battery
- Ext. power supply weight 450 g
- Sealing IP 51 with **Probix** probes connected and cap of the side connector closed

Packaging

- Dimensions 345 x 275 x 200mm

Ordering Information

Refer to the Quick Start Guide manual that was included with your instrument for detailed images of packaging.

Portable Oscilloscope Model OX 7102^{III} (2 x 100MHz, Color)..... Cat. #2124.58

Includes: Oscilloscope; two PROBIX PRHX1 1/10 Probes 250MHz, 600V CAT III; two PROBIX 4mm banana plug adapters; one US power adapter (115/230V); one 110V US plug razor power cord; one NiMH 9.6V battery pack; two red and two black 1.5m color-coded leads with needle probe tips; two Ethernet cables (one straight / one crossed); two red and two black grip probes; two stylus; aluminum carrying case, SX-METRO software on CD-ROM; Recorder/Harmonic/Power/50K memory option (installed); user manual on CD-ROM.

Portable Oscilloscope Model OX 7202^{III} (2 x 200MHz, Color)..... Cat. #2124.59

Includes: Oscilloscope; two PROBIX PRHX1 1/10 Probes 250MHz, 600V CAT III; two PROBIX 4mm banana plug adapters; one US power adapter (115/230V); one 110V US plug razor power cord; one NiMH 9.6V battery pack; two red and two black 1.5m color-coded leads with needle probe tips; two Ethernet cables (one straight / one crossed); two red and two black grip probes; two stylus; aluminum carrying case, one 512MB SD memory card, SX-METRO software on CD-ROM; Recorder/Harmonic/Power/50K memory option (installed); user manual on CD-ROM.

Portable Oscilloscope Model OX 7104^{III} (4 x 100MHz, Color)..... Cat. #2124.67

Includes: Oscilloscope; four PROBIX PRHX1 1/10 Probes 250MHz, 600V CAT III; four PROBIX 4mm banana plug adapters; one US power adapter (115/230V); one 110V US plug razor power cord; one NiMH 9.6V battery pack; four red and four black 1.5m color-coded leads with needle probe tips; two Ethernet cables (one straight / one crossed); four red and two black grip probes; two stylus; aluminum carrying case, SX-METRO software on CD-ROM; Recorder/Harmonic/Power/50K memory option (installed); user manual on CD-ROM.

Portable Oscilloscope Model OX 7204^{III} (4 x 200MHz, Color)..... Cat. #2124.68

Includes: Oscilloscope; four PROBIX PRHX1 1/10 Probes 250MHz, 600V CAT III; four PROBIX 4mm banana plug adapters; one US power adapter (115/230V); one 110V US plug razor power cord; one NiMH 9.6V battery pack; four red and four black 1.5m color-coded leads with needle probe tips; two Ethernet cables (one straight / one crossed); four red and two black grip probes; two stylus; aluminum carrying case, one 512MB SD memory card, SX-METRO software on CD-ROM; Recorder/Harmonic/Power/50K memory option (installed); user manual on CD-ROM.

Accessories and Replacement Parts

SX-METRO/P software, data retrieval processing	Cat. #2124.70
PROBIX PRHX1, 1/10 Probe, 250MHz, 1000V CAT II, 600V CAT III (HX0030).....	Cat. #2124.73
PROBIX PRHX4, BNC adapter (HX0031).....	Cat. #2124.74
PROBIX PRHX5, 50Ω adapter (HX0032)	Cat. #2124.75
PROBIX banana plug (4mm) adapter (HX0033).....	Cat. #2124.76
PROBIX current probe, 20mA-20A, 100kHz (HX0034).....	Cat. #2124.77
PROBIX PRHX7 K thermocouple adapter (HX0035).....	Cat. #2124.78
Carrying case, aluminum with foam cut-outs	Cat. #2124.79
Cable – Ethernet cable, straight for use only with OX Oscilloscope Series	Cat. #2124.80
Cable – Ethernet cable, crossed for use only with OX Oscilloscope Series	Cat. #2124.81
Lead - Set of two, color-coded, 1.5m (4mm straight, 4mm right angle) with color-coded alligator clips.....	Cat. #2124.84
Lead – Set of 2, 1.5m, color-coded w/test probes (1000V CAT IV, 15A, UL)	Cat. #2125.97
Grip Probes - Set of two, color-coded (red/black)	Cat. #2124.86
Tip and Clip Accessory (600V) for PROBIX PRHX1 1/20 Probe	Cat. #2124.90
AmpFlex® 0.5A to 3kA, 200kHz (HX0072)	Cat. #2124.91
MiniFlex® 0.5A to 300A, 3MHz (HX0073).....	Cat. #2124.92
Cable – Serial USB.....	Cat. #2124.96
512MB SD Memory Card	Cat. #2124.97
PROBIX RTD100 (PT100) Adapter (HX0036)	Cat. #2124.98
Battery Pack 9.6V, 3.8 Ah NiMH	Cat. #2140.19
Stylus - Replacement, set of five	Cat. #5000.17
Power Adapter 115/230V	Cat. #5000.21
Razor Power Cord 110V US Plug	Cat. #5000.22

Repair and Calibration

To ensure that your instrument meets factory specifications, we recommend that it be submitted to our factory Service Center at one-year intervals for recalibration, or as required by other standards or internal procedures.

For instrument repair and calibration:

You must contact our Service Center for a Customer Service Authorization number (CSA#). This will ensure that when your instrument arrives, it will be tracked and processed promptly. Please write the CSA# on the outside of the shipping container. If the instrument is returned for calibration, we need to know if you want a standard calibration, or a calibration traceable to N.I.S.T. (includes calibration certificate plus recorded calibration data).

Chauvin Arnoux[®], Inc.
d.b.a. AEMC[®] Instruments
15 Faraday Drive
Dover, NH 03820 USA
Tel: (800) 945-2362 (Ext. 360)
(603) 749-6434 (Ext. 360)
Fax: (603) 742-2346 or (603) 749-6309
repair@aemc.com

(Or contact your authorized distributor)

Costs for repair, standard calibration, and calibration traceable to N.I.S.T. are available.

NOTE: All customers must obtain a CSA# before returning any instrument.

Technical and Sales Assistance

If you are experiencing any technical problems, or require any assistance with the proper operation or application of your instrument, please call, mail, fax or e-mail our technical support hotline:

Chauvin Arnoux[®], Inc.
d.b.a. AEMC[®] Instruments
200 Foxborough Boulevard
Foxborough, MA 02035, USA
Phone: (800) 343-1391
(508) 698-2115
Fax: (508) 698-2118
techsupport@aemc.com
www.aemc.com

NOTE: Do not ship Instruments to our Foxborough, MA address

Limited Warranty

The OX Oscilloscopes are warranted to the owner for a period of three years from the date of original purchase against defects in manufacture. This limited warranty is given by AEMC[®] Instruments, not by the distributor from whom it was purchased. This warranty is void if the unit has been tampered with, abused or if the defect is related to service not performed by AEMC[®] Instruments.

Full warranty coverage and product registration is available on our website at www.aemc.com/warranty.html.

Please print the online Warranty Coverage Information for your records.

What AEMC[®] Instruments will do:

If a malfunction occurs within the warranty period, you may return the instrument to us for repair, provided we have your warranty registration information on file or a proof of purchase. AEMC[®] Instruments will, at its option, repair or replace the faulty material.

Warranty Repairs

What you must do to return an Instrument for Warranty Repair:

First, request a Customer Service Authorization Number (CSA#) by phone or by fax from our Service Department (see address below), then return the instrument along with the signed CSA Form. Please write the CSA# on the outside of the shipping container. Return the instrument, postage or shipment pre-paid to:

Ship To: Chauvin Arnoux[®], Inc. d.b.a. AEMC[®] Instruments
15 Faraday Drive • Dover, NH 03820 USA
Phone: (800) 945-2362 (Ext. 360)
(603) 749-6434 (Ext. 360)
Fax: (603) 742-2346 or (603) 749-6309
E-mail: repair@aemc.com

Caution: To protect yourself against in-transit loss, we recommend you insure your returned material.

NOTE: You must obtain a CSA# before returning any instrument

•

INDEX

A		F	
About	100	Faults (research).....	147
AC	46, 68, 71, 109	Fault capture	142
AC + DC	109	FFT	78
Accumulate	82	File (menu)	93
Acquisition (all)	83	File (type)	93
Acquisition (min/max)	78	File	93
Adapter	29	File copy	93
Adjustments (active).....	45, 105, 131	Format (RS232C).....	94
Addressing (IP).....	20, 95	Frequency (multimeter).....	120
Advanced mode	92, 98	FTP (protocol)	21, 96, 188
Automatic (mode)	43, 76	Full screen (key)	42, 102, 128
Automatic meas. (menu).....	84, 148	Full screen	52, 83, 147
Autorange	103, 105, 109	FULL TRACE (key)	46, 130
AUTOSET (key)	42	Fundamental	120, 124
Averaging	78, 124	Fundamental (frequency).....	120
B		Fuse	16
Bandwidth	55, 109, 123	G	
Bargraph	48, 104, 132	Gateway.....	21, 96
Battery	16, 218	GND	46, 123
Button A, B	30, 56	Graticule	82
C		Guarantee	6
Calibration (touch-screen)	52	H	
Calibration signal	142	Hard copy (key)	42, 102, 128
CENTRONICS	97	Hard copy	97
ch1 ch2 ch3 ch4	55	Harmonics	118
Channels.....	45, 95, 105, 130	Help (menu)	91, 116, 126, 154
Load (LED)	16	Holdoff	68, 71, 73, 75
Coefficient	56, 108, 122	Horizontal (keys)	44
Color	56	Horizontal (menu)	77, 111, 124, 145
Configuration	91, 116	horizontal scale	145
Contrast (key)	42, 102, 128	Hour	97
Count	73	HTTP (protocole)	21, 156
Coupling ..42, 68, 71, 73, 103, 109, 123, 130		HX0030	30, 207
Cursors	44	HX0031	31, 207
D		HX0032	32, 207
Date	97	HX0033	33, 207
DC	46, 68, 71, 109	HX0034	34, 207
Delay	71	HX0035	35, 208
DHCP (protocol)	21, 95	HX0036	36, 208
Display (area)	47, 104, 118, 131	HX0061	28, 210
Display (menu)	82, 11, 125, 146	HX0063	28
displayed channel.....	145, 130	HX0072	37, 209
dt, dv	44, 48, 87	HX0073	38, 209
E		I	
Edge	68, 70, 71, 73, 75	Init	56
EMC	218	L	
Envelope	82	Language	97
Environment	4, 218	Level 1, level 2	102, 132
Error messages	216	Limit (bandwidth)	55, 109, 123
ETHERNET	20, 95	Line (TV)	75
Events (number of)	73	LPD (protocol, server).....	21, 95, 194

INDEX

M		RUN HOLD (key)	43, 10, 128
Manual measurements	44, 87, 132		
Math functions	57		
math1, 2, 3, 4	57		
maximum	146		
Measure (keys)	44, 129		
Measure (menu)	84, 113, 125, 148		
Measurement threshold	76		
Memorized functions	65		
Memory (menu)	89, 116, 126, 149		
minimum	146		
Multimeter (mode)	102		
N		S	
Netmask.....	21, 96	Safety	4
Network	19, 95	Sampling	77, 79
Noise reject	68, 70, 71, 73	Save	90, 116, 126, 151
O		Save/recall	76
Oscilloscope (mode)	42	save.rec	150
Options (installation).....	100	save.txt.....	90, 116, 150
P		Scale (linear)	78
Parity (RS232).....	13, 94	Scale (logarithmic)	78
Phase	87, 121	Scale (vertical)	55, 108, 122, 139
Phase measurement	87	ScopeAdmin.....	167
Polarity (TV signal)	75	ScopeNet	157
Policy Tool	169	Screen (touch)	15, 52
Port	94	SD Card	23, 90, 92
Power (apparent).....	114, 115	Screen saver	97, 116, 152
Power (active).....	114, 115	Secondary measurement	105
Power (active).....	114, 115	selected channel	45, 130
POWER (LED)	16	Sensitivity (vertical).....	55, 108, 122, 139 ..
Power off	15	Sensitivity (vertical, keys)	46, 103, 129
Power on	15	Server FTP (installation on PC).....	189
PRETRIG	50	Server LPD (installation on PC).....	194
Principal measurement	107	Service	7
Probix	30, 56	Settings (active)	49, 105, 131
Probix (specs.).....	207	Single (mode)	43, 76
PT100	113	Source (trigger).....	50, 69, 70, 71, 73
Pulse	70	Speed.....	94
Q		Stand	11
Qualifier	71, 73	Standard TV	75
R		Statistics	111
Range	103	STOP	43, 102, 128
Recorder mode (option)	128	Stopbits	94
Recording time	129, 145	Stylus	15
Ref. (memory).....	89	Supply	219
Reference (measurements)44, 84, 103, 113, 120, 148		System infos	98
REFRESH	43, 76	T	
Reject BF	68, 70, 71, 73	Technical specifications	200
Reject HF	68, 70, 71, 73	Temperature	113
Repetitive signal	77	Three-phase.....	113
ROLL	43, 76, 111	Timebase	44
RS232	13, 94	Trigger (edge)	68, 70, 71, 73, 75
		TRIGGER (keys)	43, 102, 128
		Trigger (level).....	68, 70, 71, 73
		Trigger (menu)	66, 110, 140
		Trigger (mode)	50, 66
		Trigger (parameters)	68
		Trigger (source)	68, 70, 71, 73
		Trigger on threshold.....	76
		TV	75
		Types of trigger	66, 110, 141
		U	
		Unattached cursors	56
		Under-samplig	78

INDEX

Unit 56
Util (menu) 92, 116, 126, 152
UTILITY (keys) 42, 102, 128

V

validated channel..... 45, 130
Vector 82
Vertical (keys) 46, 103, 130
Vertical (menu) 54, 108, 122, 139
Vertical position 44, 129
Virtual printers..... 194
Visualisation 47, 104, 118, 131

W

WEB (server) 15, 156

X

XY 83

Z

Zoom (harmoniqcs) 118
Zoom (recorder)..... 137, 146
Zoom (multimeter) 103, 111
Zoom (oscilloscope) 44, 52, 82



05/13

99-MAN 100355 v3

Chauvin Arnoux[®], Inc. d.b.a. AEMC[®] Instruments
15 Faraday Drive • Dover, NH 03820 USA • Phone: (603) 749-6434 • Fax: (603) 742-2346
www.aemc.com