



## Virtual Digital Oscilloscopes

# MTX 1052B(W)

2-channel, 150 MHz, USB, Ethernet, (WiFi option)

# MTX 1054B(W)

4-channel, 150 MHz, USB, Ethernet, (WiFi option)

# MTX 1052C(W)

2-channel, 200 MHz, USB, Ethernet, (WiFi option)

# MTX 1054C(W)

4-channel, 200 MHz, USB, Ethernet, (WiFi option)

### User's Manual



Pôle Test et Mesure de CHAUVIN-ARNOUX  
Parc des Glaisins - 6, avenue du Pré de Challes  
F - 74940 ANNECY-LE-VIEUX

Tél. +33 (0)4.50.64.22.22 - Fax +33 (0)4.50.64.22.00

---

# Contents

---

<b>General Instructions</b>	<b>Chapter I</b>
Introduction .....	4
Precautions and safety measures .....	4
Symbols used .....	5
Warranty .....	5
Maintenance and metrological verification .....	6
Cleaning .....	6

<b>Description of the Instrument</b>	<b>Chapter II</b>
Preparation for use .....	7
Operation .....	9
Views .....	10
ETHERNET network.....	11

<b>Getting started</b>	<b>Chapitre III</b>
Driving software .....	13
First start.....	13
Start of an existing oscilloscope .....	15

<b>"Oscilloscope" Instrument</b>	<b>Chapter IV</b>
Display .....	16
« Oscilloscope Control » window .....	16
Menu bar .....	16
Tool bar .....	16
« Vertical » box .....	17
« Horizontal » box .....	18
« TRIGGER » and advanced trigger .....	18
Control buttons .....	33
« FFT » box .....	34
« Oscilloscope Trace » window .....	41
Menus	
"File" menu .....	42
"Instrument" menu .....	48
"Vertical" menu .....	49
"Horizontal" menu .....	63
"Display" menu .....	65
"Measurement" menu .....	66
"Tools" menu (WiFi ...)	73
"?" Help menu » .....	86

<b>"Oscilloscope with SPO Persistence" instrument</b>	<b>Chapter V</b>
Selection .....	87
Presentation .....	87
Display .....	88
Menus .....	90

<b>"Recorder" Instrument</b>	<b>Chapter VI</b>
Presentation .....	91
Selection .....	91
Display .....	91
Menu	
"File" menu .....	103
"Vertical" menu .....	106
"Trigger" menu .....	107
"Display" menu .....	110
"Measurement" menu .....	111
"Tolls" menu .....	112
"?" Help menu » .....	113

<b>"Harmonics Analyser" Instrument</b>	<b>Chapter VII</b>
Presentation .....	114
Selection .....	114
Display .....	114
Menus	
"File" menu.....	117
"Vertical" menu .....	118
"Horizontal" menu .....	119
The "Memory", "Tools", "Help?" menus » .....	120

<b>Applications</b>	<b>Chapter VIII</b>
Display of the calibration signal .....	121
Probe compensation.....	124
Automatic measurements .....	125
Cursor measurements .....	126
Cursor offset measurements .....	127
Video signal display .....	129
Examination of a specific TV line.....	131
Automatic measurement in "Analyser" mode.....	132
Display of slow events .....	134
Measurement in "Recorder" Mode .....	135
ETHERNET network.....	137
WEB Server .....	138

<b>Technical Specifications</b>	<b>Chapter IX</b>
<b>"Oscilloscope" Mode</b> .....	142
Vertical deviation.....	142
Horizontal deviation (time base) .....	143
Trigger circuit .....	144
Acquisition chain.....	145
Display .....	146
<b>"Harmonic Analyser" Mode</b> .....	147
<b>"Recorder" Mode</b> .....	147
Communication interfaces .....	148
Remote programming.....	148

<b>General Specifications</b>	<b>Chapter X</b>
Environment.....	149
Mains power supply .....	149
Electromagnetic compatibility .....	149

<b>Mechanical Specifications</b>	<b>Chapter X</b>
Casing .....	149
Packaging .....	149

<b>Supply</b>	<b>Chapter XI</b>
Accessories.....	150

**Index**



To update the embedded software, log on to the Internet site:  
[www.chauvin-arnoux.com](http://www.chauvin-arnoux.com)

**Attention ! Before printing this notice, think of the impact on the environment.**

# General Instructions

## Introduction



You have just acquired a virtual digital oscilloscope 150 MHz without display device :

- 4-channel **MTX 1054\_B** (150 MHz) or **\_C** (200 MHz) (**W**, if option WiFi)
- 2-channel **MTX 1052\_B** (150 MHz) or **\_C** (200 MHz) (**W**, if option WiFi)

Congratulations on your choice and thank you for your confidence in the quality of our products. It consists of:

This instrument comes with a data acquisition and pre-processing card and its own mains supply. It is managed by embedded flash software that can be updated from a PC via the [SCOPEin@BOX](#) software.

This software communicates with the "host PC" via an USB, ETHERNET interface or WiFi (optional).

This instrument has the following operating modes:



"**Oscilloscope**" Instrument



"**Harmonics Analyser**" Instrument



"**Recorder**" Instrument



"**SPO**" **Analogue** Persistence display

"**FFT**" Fast Fourier Transform representation

## Precautions and safety measures



This instrument complies with safety standard IEC 61010-1, single insulation, relative to electronic measurement instruments and complies with the EMC standards corresponding to residential and industrial environments.

For optimum service, read this manual carefully and comply with the operating precautions.

Failure to comply with these warnings and/or user instructions is liable to cause damage to the equipment. This could be dangerous to the user.

- It is designed for use:
  - indoors
  - in an environment with pollution level 2
  - at an altitude of less than 2000 m
  - at a temperature between 0°C and 40°C
- with relative humidity of less than 80 % up to 31°C

It can be used for measurements on 300 V CAT II circuits in relation to earth and can be powered by a 240 V, CAT II network

### definition of measurement categories

*Measurement category I corresponds to measurements taken on circuits not directly connected to the network.*

*Example: protected electronic circuits*



*Measurement category II corresponds to measurements taken on circuits directly connected to low-voltage installations.*

*Example: power supply for domestic appliances and portable tools*

*Measurement category III corresponds to measurements on building installations.*

*Example: measurements on distribution panels, cabling, etc.*

*: Measurement category IV corresponds to measurements taken at the source of low-voltage installations.*

*Example: meters and measurement on overvoltage protection devices.*

---

## General instructions (contd.)

---

### before use



- Comply with environmental and storage conditions.
- Ensure the three-wire power lead - phase/neutral/earth – that comes with the instrument is in good condition.  
It complies with standard IEC 61010-1 : it should be connected to the instrument as well as the network (variation from 90 to 264 VAC).

---

### during use



Read carefully all the notes preceded by the symbol .

Connect the instrument to an outlet with a ground pin.

The instrument power supply is equipped with an electronic protection system which is reset automatically when the fault is eliminated.

Be sure not to obstruct the ventilation holes.

As a safety measure, use only suitable leads and accessories supplied with the instrument or approved by the manufacturer.

When the instrument is connected to the measurement circuits, never touch an unused terminal.

---

### Symbols used



Warning: danger hazard, consult the operating instructions.



Selective sorting of waste for recycling electrical and electronic equipment. In compliance with the WEEE 2002/96/CE directive: must not be considered as household waste.



Earth terminal



USB



European compliance

---

### Warranty



This equipment is warranted to be free of defects in materials or workmanship, in accordance with the general terms and conditions of sale.

During this period, the manufacturer only can repair the equipment. The manufacturer reserves the right to carry out repair or replacement of all or part of the equipment.

In the event that the equipment is returned to the manufacturer, initial transport costs shall be borne by the customer.

The warranty does not apply in the event of:

- improper use of the equipment or use in connection with incompatible equipment
- modification of the equipment without explicit authorization from the manufacturer's technical services
- repair carried out by a person not certified by the manufacturer
- adaptation for a specific application, not included in the definition of the equipment or the user's manual
- an impact, a fall or a flooding.

---

## General instructions (contd.)

---

### Maintenance, Metrologic verification



The device includes no part that can be replaced by the operator. All operations must be carried out by competent approved personnel.

For checks and calibrations, contact one of our accredited metrology laboratories (information and contact details available on request), at our Chauvin Arnoux subsidiary or the branch in your country.

---

### Unpacking, re-packing



All the equipment was verified mechanically and electrically before shipping.

When you receive it, carry out a quick check to detect any damage that may have occurred during transport.

If necessary, contact our sales department immediately and register any legal reservations with the carrier.

In the event of reshipping, it is preferable to use the original packaging. Indicate the reasons for the return as clearly as possible in a note attached to the equipment.

---

### Cleaning



- Turn the instrument off.
- Clean it with a damp cloth and soap.
- Never use abrasive products or solvents.
- Allow to dry before any further use.

## Description of the instrument

---

***This is a user manual for the MTX 1052 and MTX 1054.  
Most screen copies are made from an MTX 1054B.***

### Preparation for use

#### **Instructions before activation**

Check the good condition of the power supply cable to be connected, first to the back of the instrument and then to a 50-60Hz power socket with an earth link.

When lit, the LED at the back indicates that the mains voltage is correct for the oscilloscope.

Connect the oscilloscope and the "Host PC" to the "Ethernet Network" or directly to one another via the Ethernet twisted cable.

#### **Mains power supply**

The oscilloscope power supply is designed for:

- a power supply that can vary from 90 to 264 VAC (nominal range of use 100 to 240 VAC)
- a frequency between 47 Hz and 63 Hz.

#### **Fuse**



Type: Time delay  
2.5 A  
250 V  
5 x 20 mm

This protection fuse must only be replaced with an identical model.  
***Replacement must only be performed by qualified personnel.***

Contact your nearest distributor.

#### **Activation**

Connect the oscilloscope to the 50-60 Hz network.

Wait for about one minute before starting the "SCOPEin@BOX" application software. Refer to the "**First Installation**" instructions that come with the instrument.

#### **Reducing consumption**

When you exit the "SCOPEin@BOX" software, the remote virtual oscilloscope switches to reduced consumption mode (except in "Recorder" Instrument mode). Channels are put on standby but the microprocessor remains active.

When a new work session is opened, the oscilloscope is automatically switched to normal consumption.



*To save working parameters correctly, exit the "SCOPEin@BOX" software before disconnecting the instrument from the 50-60 Hz network or Ethernet network.*

---

## Description of the instrument (contd.)

---

### Presentation

This is a **four-in-one** instrument:

- a traditional **Oscilloscope** with the **FFT** function for analysing signals present in electronics and electrotechnical applications
- an **SPO Oscilloscope (Smart Persistence Oscilloscope)** that enables an analogue display to be reproduced and rare phenomena displayed
- a **Harmonics Analyser** to represent the fundamental and the first 31 harmonics of low-frequency signals (50-60 Hz network)
- a **Recorder**, to capture unique or slow signals

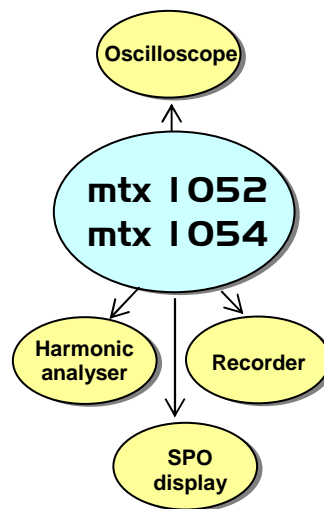

The instrument works with a constant acquisition depth of 50,000 counts.

The principal control functions can be accessed directly on the PC control panel. The adjustment parameters can be modified using the **mouse**.

---

### Interfaces

This instrument comes with two interfaces **ETHERNET, USB ; WiFi** (optional) :

- for remote management of the instrument
- for controlling the instrument using SCPI commands



## Description of the instrument (contd.)

---

### Operation

The instrument can operate in two modes:

**"LOCAL"** The instrument is directly connected to the control PC via an "Ethernet twisted cable" or an USB cable.

**"NETWORK"** The instrument and control PC can be connected to the ETHERNET network with an untwisted Ethernet cable.

The [SCOPEin@BOX](#) software can be activated several times from the PC to control several instruments at a time. By keeping one instrument displayed on the PC screen and putting the other instruments as icons, all the instruments can then be controlled in turn.

 *With the [SCOPEin@BOX](#) software, it is not possible to open an instrument already open.*

**« WiFi »  
(optional)**

Two operating modes are available :

1. **ADHOC** mode :  
the instrument and the PC (with a WiFi card) communicate directly
2. **INFRASTRUCTURE** mode :  
instrument (connected to an Ethernet network access point) and PC communicate via the Ethernet network.

---

### Minimum PC configuration required

- Processor Pentium II or equivalent
- Memory 64 Mb
- Disk space 100 Mb
- Ports USB 1.1
- Ethernet Network Adapter 10BaseT
- Operating systems - Windows 98 - Millennium - 2000 - XP - Vista



*The [SCOPEin@BOX](#) software operates with the NI-VISA V4.40 version: this version is included in the installation programme supplied.*

---

### Installation of [SCOPEin@BOX](#)

Please refer to the "**First Installation**" instructions that come with the instrument.

## Description of the instrument (contd.)

### Views

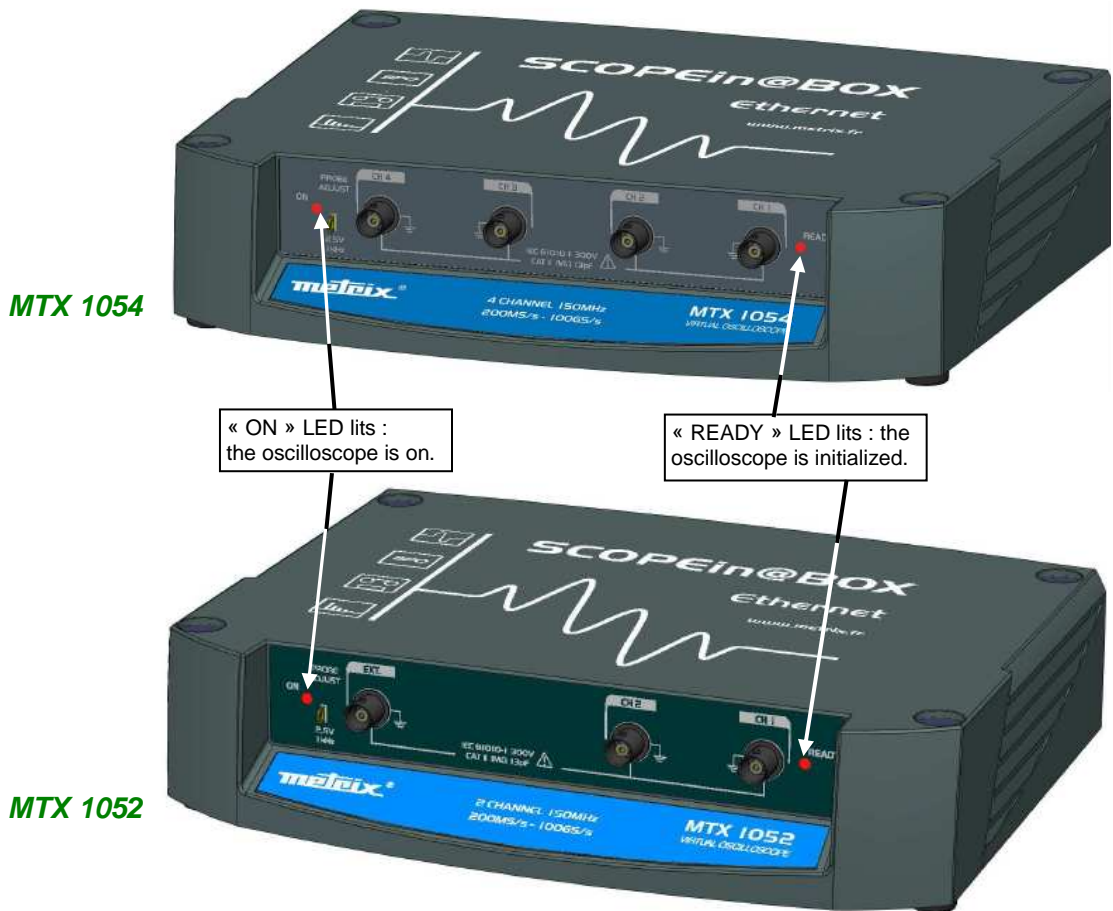

### Connection

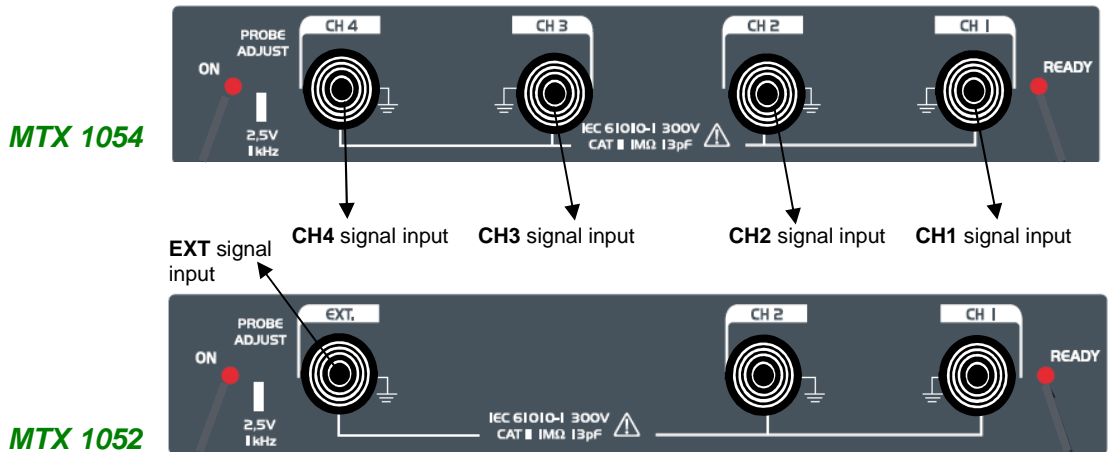

### Rear panel

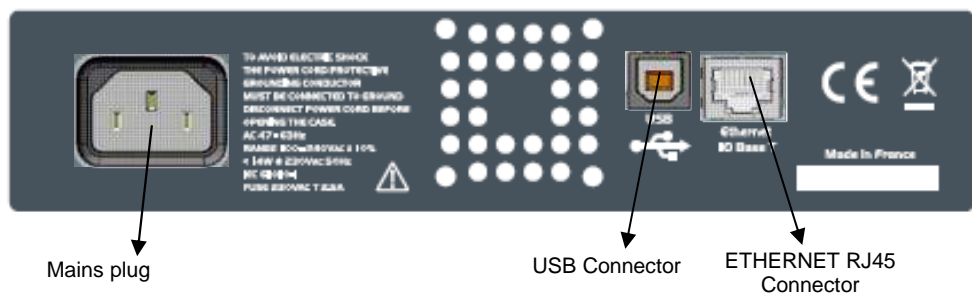

## Description of the instrument (contd.)

### General principles of the ETHERNET network

ETHERNET and TCP/IP (Transmission Control Protocol/Internet Protocol) are used to communicate on a company network.

### Addressing

Each piece of equipment under TCP/IP has a physical address (MAC ADDRESS) and an Internet address (IP).

### ETHERNET physical address

A physical address or MAC ADDRESS, stored in the ROM, identifies each piece of equipment on the network. The physical address enables the equipment to determine the source of data "packet" transmission.

The physical address is a number coded over 6 bytes represented in hexadecimal form.

Equipment manufacturers obtain physical addresses from the IEEE organisation and assign them to the products manufactured in incremental order. Each instrument has a unique MAC ADDRESS that cannot be modified by the user.

### IP address

An IP address is coded over 4 bytes, displayed in decimal format.

(👉 *Example: 132.147.250.10*). Each field may be coded between 0 and 255 and is separated by a decimal point.

Unlike the physical address, the IP address can be modified by the user.



***You must ensure that the IP address assigned to the instrument is unique on your network. If an address is duplicated, network operation becomes random.***

The IP address is made up of two parts:

the network identifier (Network ID) for a given physical network

the host identifier (Host ID) identifying a specific item of equipment on the same network.

There are 5 addressing classes. Only classes A, B and C are used to identify the equipment. See below:



---

## Description of the instrument (contd.)

---

To communicate on the network, the equipment (oscilloscope, PC, printer) must use a compatible IP address (identical Network ID field).

---

### FTP protocol

**FTP** (File Transfer Protocol) is used in the oscilloscope for fast file transfers to or from a PC.

To use it, open the browser on the PC and, in the **URL** field, type the **IP** address of the instrument, preceded by "**ftp:**"

 *Example: ftp://192.168.3.1*

The oscilloscope is an **FTP** server.

---

### HTTP protocol

With this protocol, the instrument can function as a **Web** server. You can access the usual adjustments:  
Display of traces on your PC via a browser (**EXPLORER, NETSCAPE, ...**)

To use it, open the browser on the PC and, in the **URL** field, type the IP address of the instrument, preceded by "**http:**"

 *Example: http://192.168.3.1*

See §. Applications p. 138.



*To be able to display the traces, you must install Java Virtual Machine JVM SUN 1.4.2 (or higher) on your PC. This JVM can be downloaded from the site: <http://java.sun.com/>.*

## Getting started

**Command software** The command software is SCOPEin@BOX :

**Installation** Carefully read the safety instructions shipped with the instrument and insert the CDROM in your PC CD drive.

**Launching** When the oscilloscope's "READY" LED lights, you can launch the SCOPEin@BOX software.

### First start-up

At first start-up the following windows are opened:

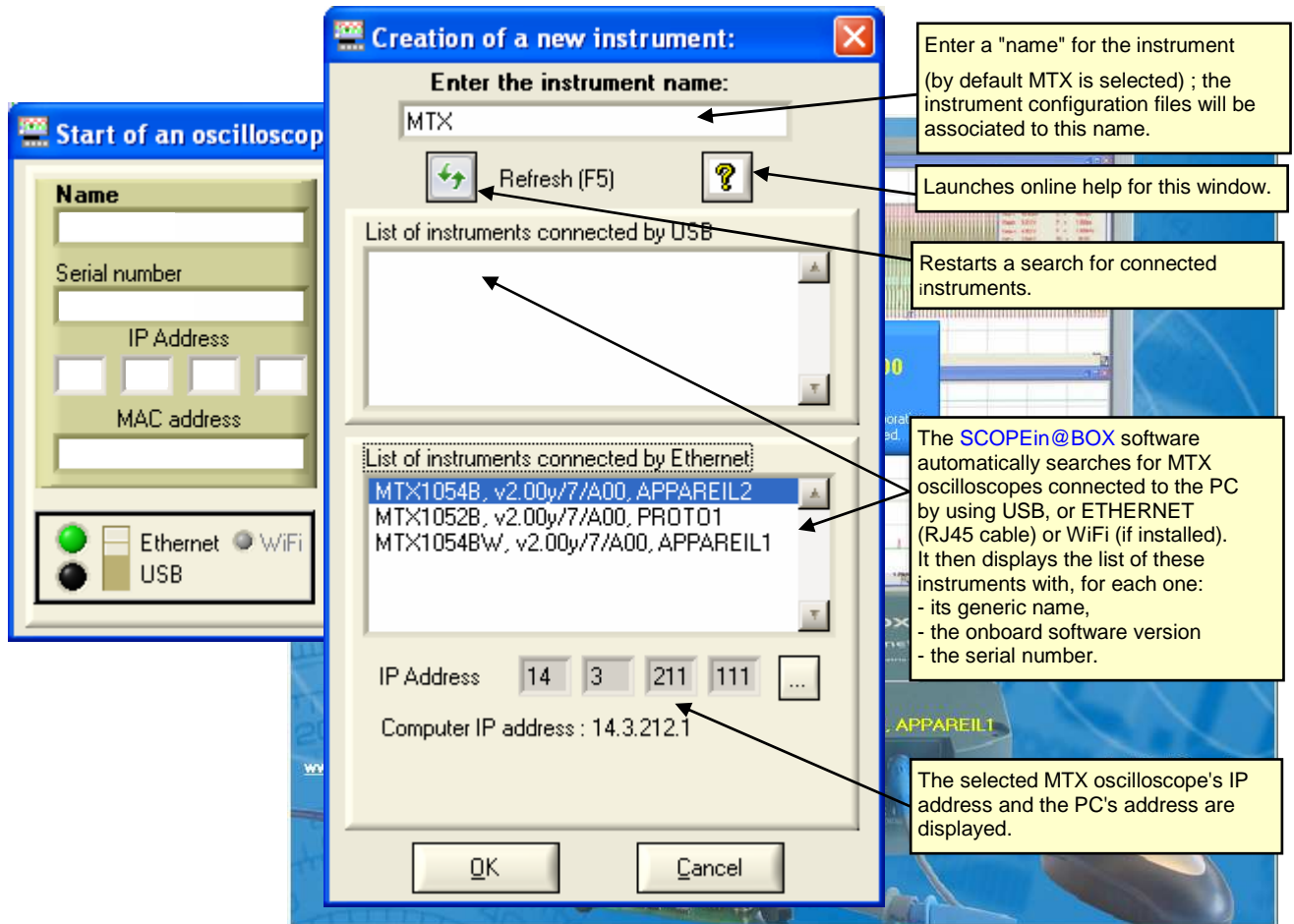

Press the  key to refresh the display if your oscilloscope does not appear in the list of connected instruments. If this fails, check your instrument's connection and/or re-start it by disconnecting and reconnecting it to the power supply.

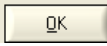
1. Name your instrument.
2. Select one of the instruments connected to the PC (via USB or ETHERNET) from the proposed lists.
3. Click on the  button to create and launch the instrument.

*In our example we are starting up the "MTX" oscilloscope for the first time.*

*By default the instrument's IP address is 14.3.211.111 (with the 255.255.255.0 network mask).*

*The instrument's IP address must therefore be adapted to the network address used by the host-PC (here: 14.3.212.1).*

## Getting started (contd.)

**First start-up (contd.)** The selection of an instrument connected using Ethernet leads to the display of the following window if the IP address, entered by default, is not compatible with the network to which the PC is connected:



**To avoid IP address conflicts on the network you are using, consult your administrator in order to select an available address that is compatible with the network.**

In our example the network mask used is 255.255.0.0; we program our IP address: 14.3.215.215 and validate the entry using the  key.



The IP address is tested on validation to make sure that the entered address is not already used on the network.

If the result is correct the instrument starts up.

---

## Getting started (contd.)

---

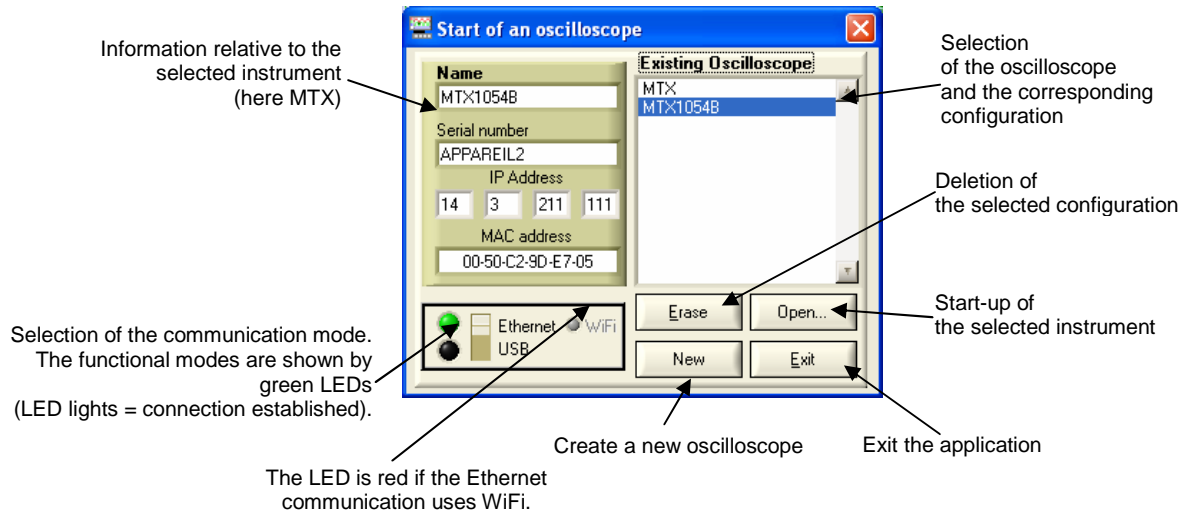

 *The oscilloscope can also be controlled via the USB communication interface by moving the switch selection. The 2 green LEDs lit indicates that the 2 communication interfaces can be selected to control the oscilloscope with the PC.*

# "Oscilloscope" Instrument

## Display of the "Oscilloscope Control" Window

a. Drop-down menus

b. Tool bar

c. « Vertical » setting box see p. 17

d. « Horizontal » setting box see p. 18

e. « Trigger » box see p. 18

f. 6 Control buttons see p. 33

g. « FFT » box see p. 34.

### a. Drop-down menus

File Instrument Vertical Horizontal Display Measure Tools ?

### b. Tool bar

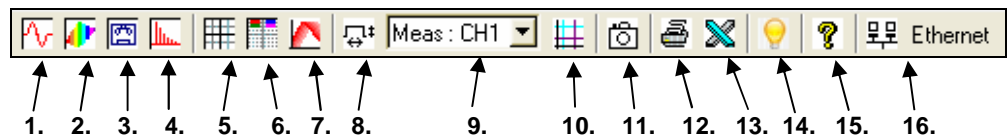

1. Direct access to the **oscilloscope**
2. Direct access to the display in **SPO**
3. Direct access to the **recorder**
4. Direct access to the **harmonics analyser**
5. Display of the grid
6. Vertical unit
7. Signal display persistence
8. Automatic measurements
9. Direct access to FFT representation
10. Choice of the measurement reference
11. Snap-to-point measurements
12. Direct access to the print window
13. Export to EXCEL
14. Keyboard shortcut
15. Direct access to the operating instructions in .pdf format
16. Type of communication [USB, ETHERNET (or WiFi, optional)]



## "Oscilloscope" Instrument (contd.)

### c. « Vertical » setting box

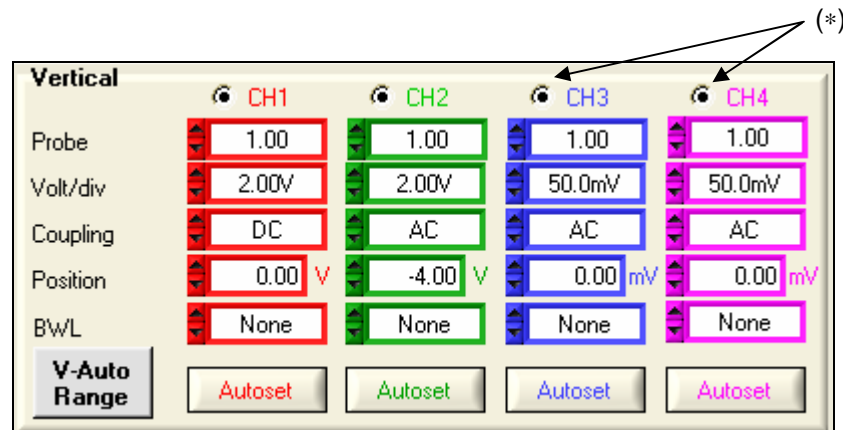

(\*) or MATHx in MTX 1052 version

CHx MATHx MEMx Channel selection

**Probe** Probe coefficient setting :  
The offset multiplying coefficient of the probe assigns a multiplying coefficient to the sensitivity of the channel in question.  
The variation range is: 0 to 100 000.

 *The Volt/div channel vertical scale will be modified by the Probe value. Ensure you reset the Probe coefficient value to 1 by disconnecting the probe from the input.*

**Volt/div.** Selection of vertical sensitivity Vertical sensitivity: 15 calibres ranging from 2.5 mV / div. to 100 V / div.

**Coupling** Selection of input coupling :  
**AC** blocks the DC component input signal and attenuates signals below 10 Hz.  
**DC** transmits the input signal to the DC and AC components.  
**GND** internally, the instrument links the input of the channel selected at the 0 V reference level (with this coupling, the input impedance 1 M $\Omega$  // 13 pF is retained).

**Position** Setting for the trace vertical position  
Variation range :  $\pm 10$  div.

**BWL** Bandwidth limitation selection  
There are 4 possible bandwidth limitations for the vertical channel:  
none, 15 MHz, 1.5 MHz and 5kHz.

BWL limits the bandwidth of the channel and its trigger circuit, attenuates display noise and optimises triggering.

**Autoset** Vertical CHx autoset activation buttons

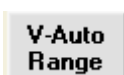

automatically adjusts the vertical sensitivity to the signal present on input validated.

## "Oscilloscope" Instrument (contd.)

### d. "Horizontal" setting box



*T/div* Sweep coefficient or acquisition time base

*H-pos Trigger* Horizontal position of the trigger



The time base can be modified.

### e. "Trigger" setting box

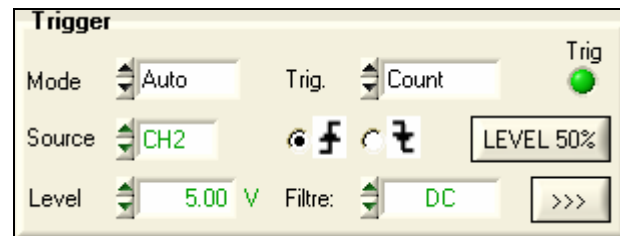

*Mode* **Auto** Automatic acquisition and refreshment, even in the absence of a trigger event  
**Triggered** Acquisition and refreshment of the screen for each trigger event  
**Single shot** Acquisition of the signal and refreshment of the screen on the first trigger after resetting of the trigger  
 by clicking on

*Trigger* **Principal** trigger on edge  
**Pulse** trigger on pulse width  
**Delay** delayed trigger  
**Count** trigger after point  
**TV** trigger on video signal  
**Line** trigger on mains supply

*Source* Selection of the trigger source  
 CH1, CH2, CH3 or CH4 (MTX 1054)  
 CH1, CH2 or EXT (MTX 1052)

*Edge* Selection of the  
 + trigger edge   
 - trigger edge

*Level* Trigger level in mV

*LEVEL 50 %* Automatically adjusts the trigger level to 50 % of the peak-to-peak amplitude of the signal.



Trigger and advanced trigger, see next pages.

# "Oscilloscope" Instrument (contd.)

>>> The oscilloscope has "advanced trigger" capability :

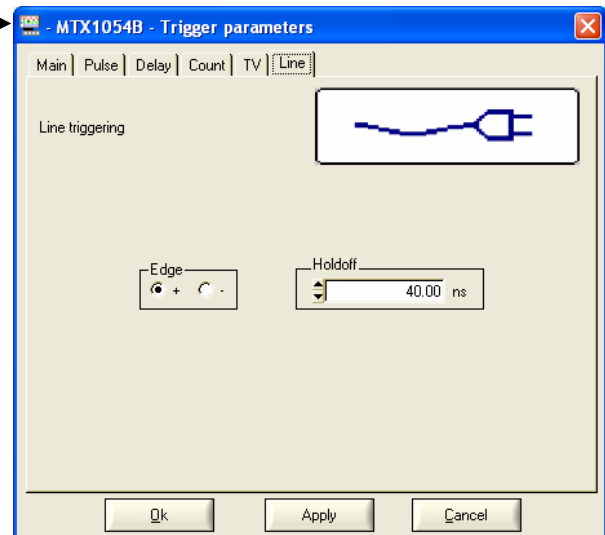
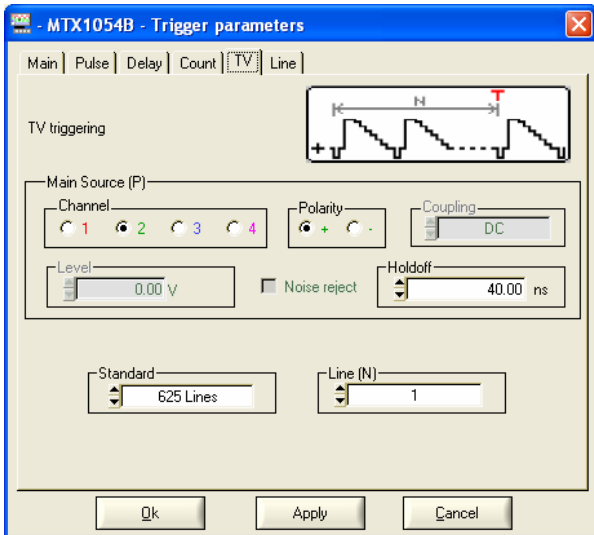
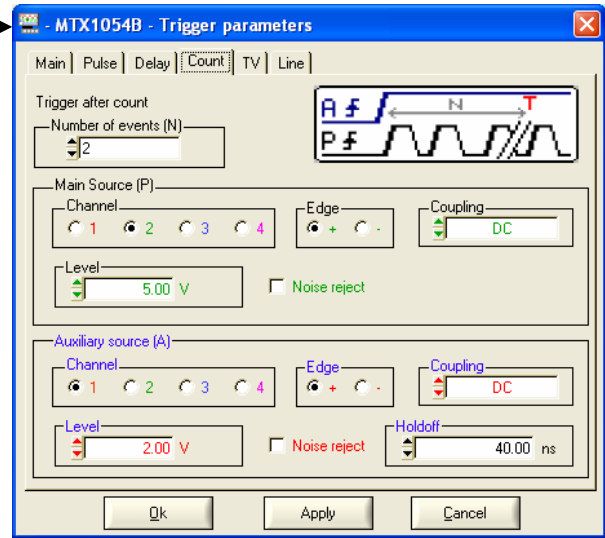
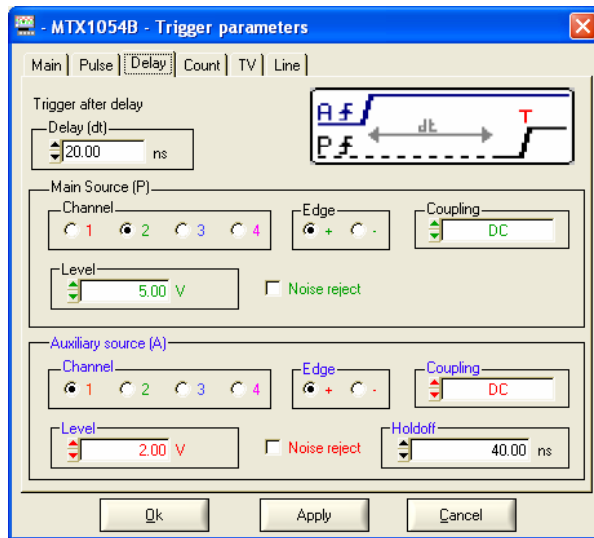
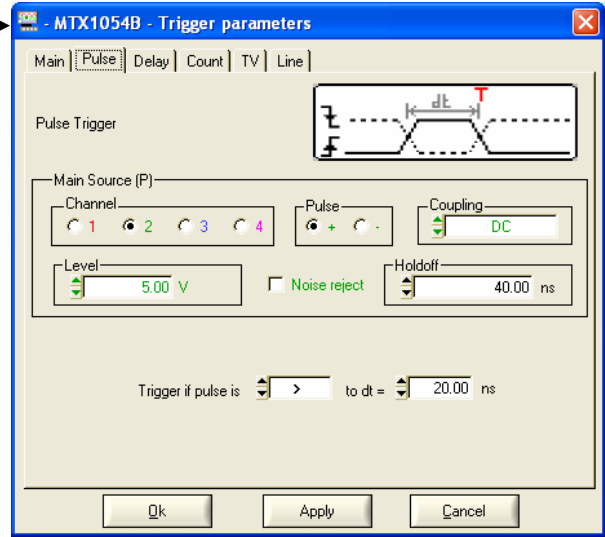
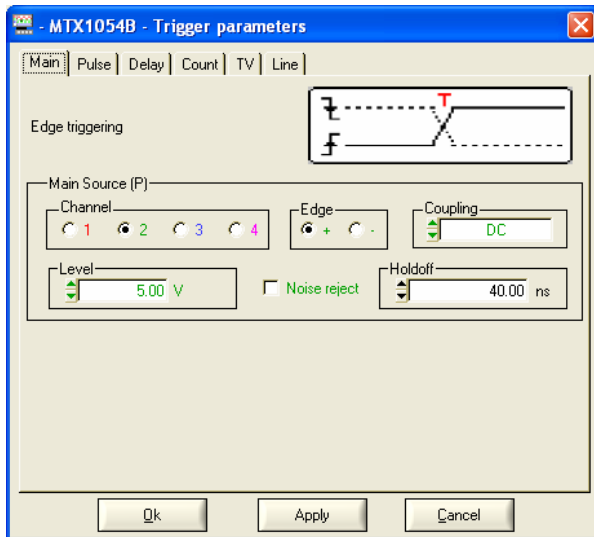

---

## "Oscilloscope" Instrument (contd.)

---

### Definition

- The "Delay" and "Count" trigger modes require parameterization of a second "auxiliary" trigger source. The auxiliary source may be the same as the main source.

The trigger choice is validated by exiting from the menu with OK.

If ...	Then ...
... the user exits from the <b>Main</b> tab	he is in <b>Main</b> trigger mode.
... the user exits from the <b>Pulse</b> tab	he is in <b>Pulse</b> trigger mode.
etc.	etc.

- There is only one Holdoff, although it can be programmed from the Main, Delay, Count, TV and Line tabs.*  
When Delay or Count is being used, the Holdoff applies the auxiliary source.  
In the other cases, Holdoff applies to the main trigger source.
- Each trigger source has its own specific attributes: Coupling, Level, Edge, Noise Reject, Filter*

# "Oscilloscope" Instrument (contd.)

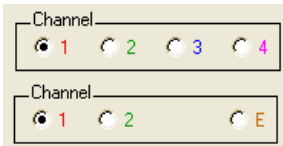
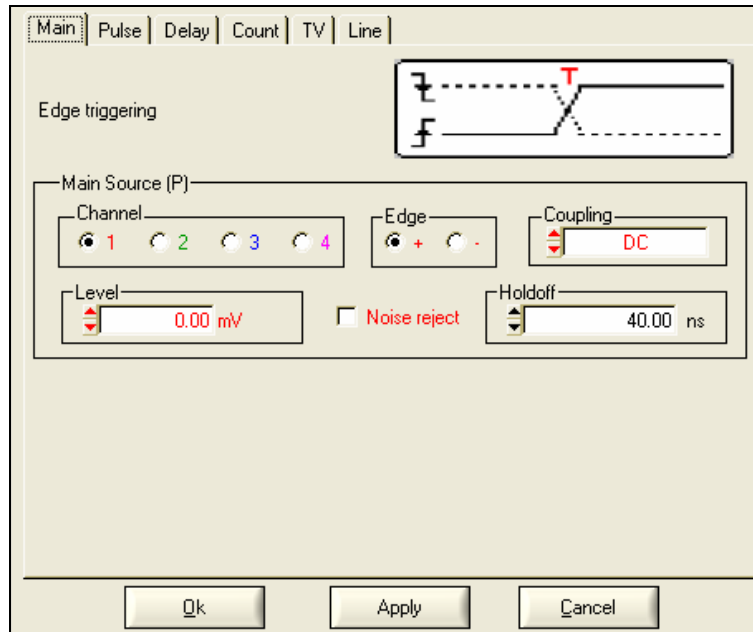

*Trigger on  
MAIN edge*

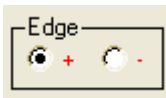

**MTX 1054** : Choice of main source: channel 1, 2, 3 or 4

**MTX 1052** : Choice of main source: channel 1, 2 or Ext



+ rising trigger slope   
 - falling trigger slope 

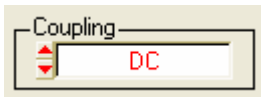

AC - DC - LF reject - HF reject

*The trigger symbol takes on the colour of the active trigger channel.  
 The active coupling of the trigger channel is indicated beside the  
 Trigger symbol in the "Oscilloscope Trace" window.*

**AC** **TAC** symbol  
 AC coupling (10 Hz to 200 MHz):  
 blocks the DC component of the signal.

**DC** **T** symbol  
 DC coupling (0 to 200 MHz):  
 allows the entire signal through

**LF Reject** **TLF** symbol  
 Reject of source signal frequencies < 10 kHz  
 facilitates observation of signals with a DC component or an  
 unwanted low frequency

**HF Reject** **THF** symbol  
 Rejection of source signal frequencies > 10 kHz:  
 facilitates observation of slow signals with high-frequency noise

## "Oscilloscope" Instrument (contd.)

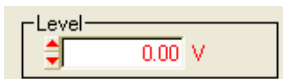

adjusts the trigger level by moving the scrollbar with the mouse or directly entering the value with the keyboard. The variation range is  $\pm 8$  vertical divs.



No Hysteresis  $\approx 0.6$  div.  
 Yes Hysteresis  $\approx 1.5$  div.

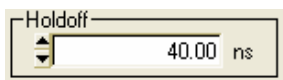

Variation range: from 40.00 ns to 10.5 s  
 disables the trigger for a predefined period  
 stabilises the trigger on pulse trains.

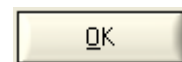

When adjustment is finished, clicking on the button:



applies the new trigger parameters by exiting the window

applies the new parameters without exiting the window

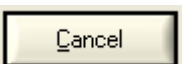

exits the window without applying the new parameters



*Example*

Signal injected on CH1: trains of 4 sine wave signals with a frequency of 4 kHz and amplitude 2.5 Vcc with no DC component, separated by 1 ms.

### Oscilloscope adjustment:

- Vertical sensitivity: 0.5 V/div.
- Time base: 500  $\mu$ s/div.
- Trigger source: channel 1
- Trigger level: 0.250 V
- Edge: rising

The Holdoff stabilises the signal by inhibiting the trigger for a value of between 2.8 ms and 3.8 ms (e.g. Holdoff = 3 ms).

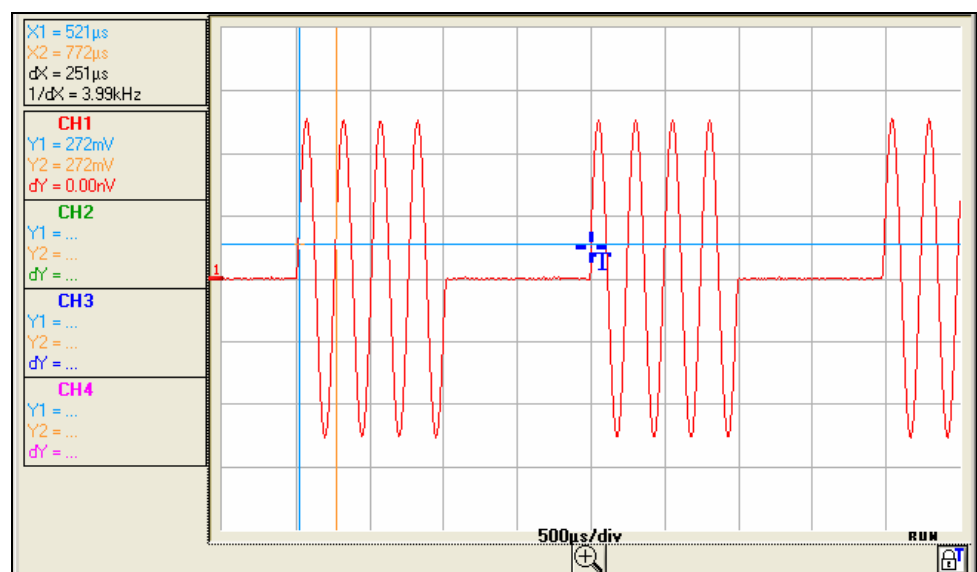

# "Oscilloscope" Instrument (contd.)

## Trigger on PULSE

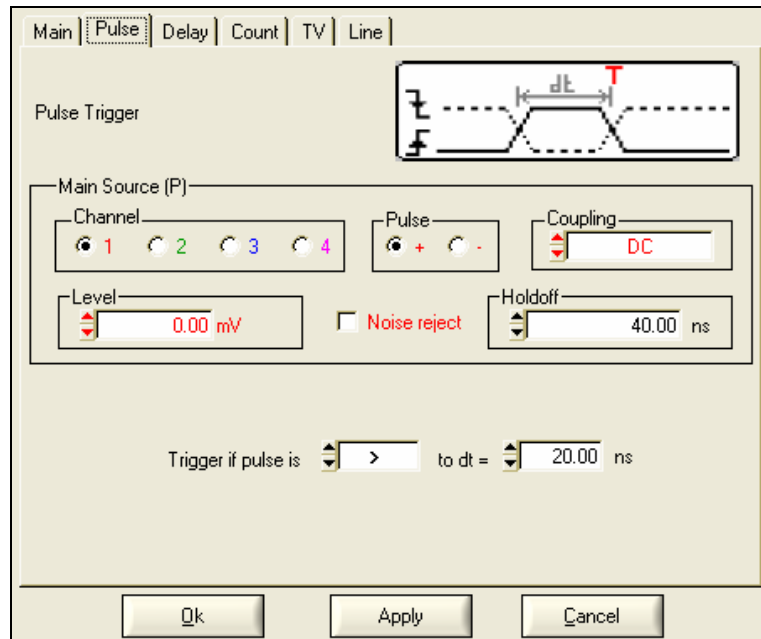

Selection of pulse-width trigger.

In all cases, the effective trigger occurs on the pulse trailing edge.

- < triggers on a pulse if its width is less than the value set
- = triggers on a pulse if its width is equal to the value set
- > triggers on a pulse if its width is greater than the value set

 *The pulse width is defined by the crossing of the signal with the vertical Trigger level*

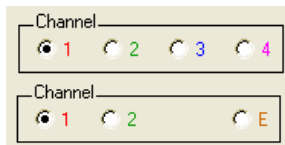



**MTX 1054** : Choice of main source: channel 1, 2, 3 or 4

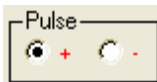

**MTX 1052** : Choice of main source: channel 1, 2 or Ext



Pulse type: + positive or - negative

The choice of the edge + (rising) or- (falling) defines the pulse polarity:

edge + defines a positive pulse between  and 

edge - defines a negative pulse between  and 

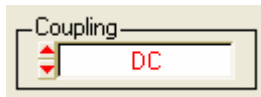

Filters the trigger channel: AC - DC - LF reject - HF reject

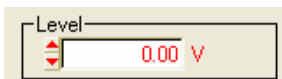

Variation range:  $\pm 8$  div.



Trigger sensitivity changes from  $\approx 0.6$  div. to  $\approx 1.5$  div.

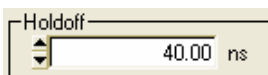

Variation range: from 40.00 ns to 10.5 s

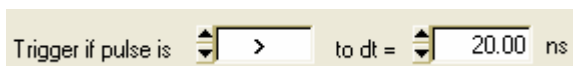

if pulse  $> = <$  the value specified (variation range from 20.00 ns to 10.5 s, our example: 20.00 ns)

## "Oscilloscope" Instrument (contd.)

✎ *Example* Signal injected on CH1: trains of 4 negative pulses with amplitude 2.25 Vcc, no DC component, and a frequency of 10 kHz, separated by 500  $\mu$ s.

### Oscilloscope adjustment:

- Vertical sensitivity: 0.5 V/div.
- Time base: 200  $\mu$ s/div.
- Trigger mode: Pulse
- Trigger source. : CH 1
- Trigger level: : 0.5 V
- Trigger on pulse: negative
- Trigger condition : "if the pulse width is < 50.05  $\mu$ s"

The oscilloscope is triggered when the negative pulse width is less than the specified pulse width (50.05  $\mu$ s + tolerance).

Measurement of the negative pulse width is triggered on the falling edge and the trigger is effective on the rising edge, if the pulse width meets the comparison criterion chosen.

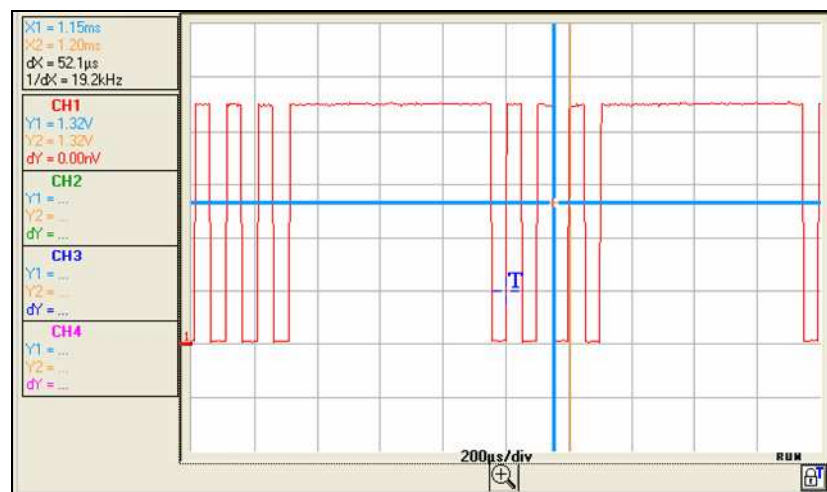



# "Oscilloscope" Instrument (contd.)

## Trigger with DELAY

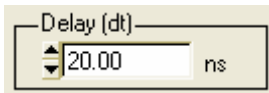
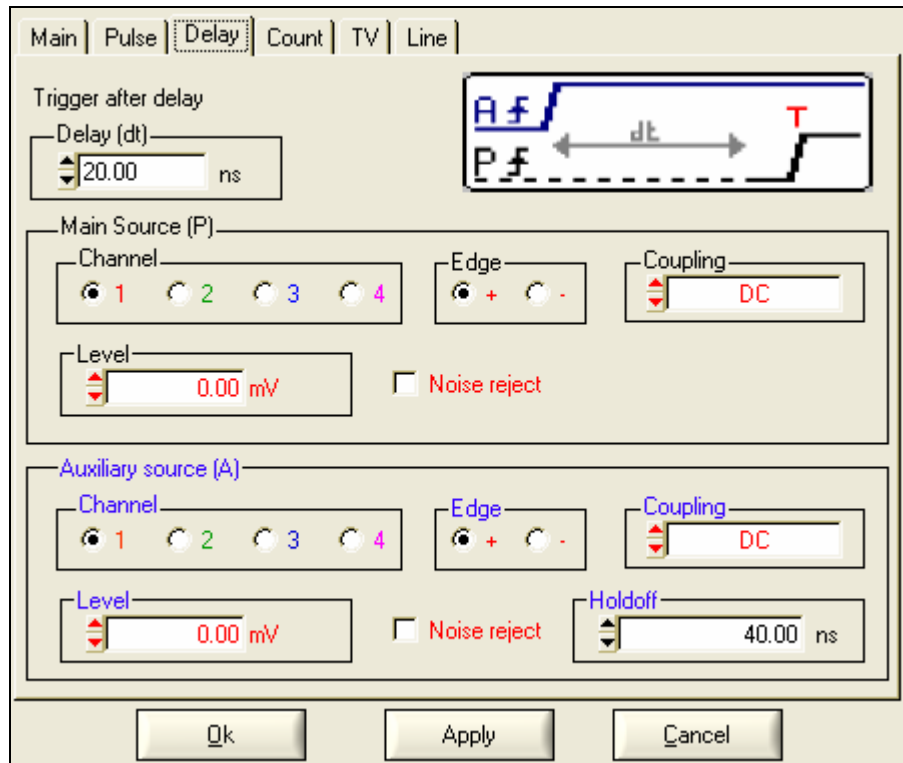

Selection of edge trigger with delay

The delay is triggered by the auxiliary source.

Effective triggering occurs after the end of the delay on the next event from the main source.

### Main source



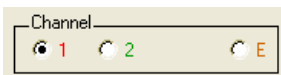

**MTX 1054** : Trigger source: channel 1, 2, 3 or 4

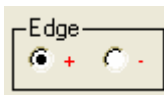

**MTX 1052** : Trigger source: channel 1, 2 or Ext



+ for rising edge   
 - for falling edge 

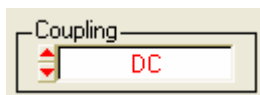

AC - DC - LF reject - HF reject

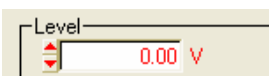

Variation range:  $\pm 8$  div.

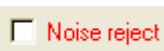

Trigger sensitivity changes from:  $\approx 0.6$  div. to  $\approx 1.5$  div.

## "Oscilloscope" Instrument (contd.)

### Auxiliary source



**MTX 1054** : Trigger source: channel 1, 2, 3 or 4

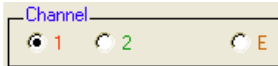

**MTX 1052** : Trigger source: channel 1, 2 or Ext

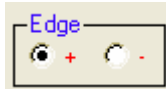

Trigger edge: + or -

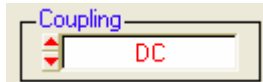

AC - DC - LF reject - HF reject

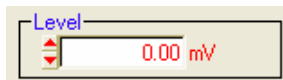

Variation range:  $\pm 8$  div.

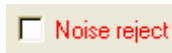

Trigger sensitivity changes from:  $\approx 0.6$  div. to  $\approx 1.5$  div.

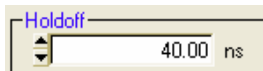

Variation range: from 40.00 ns to 10.5 s

 If the same source is selected for main and auxiliary trigger, the level, edge, coupling and noise reject have the same values.

 **Example** Signal injected on CH1: trains of 4 pulses with amplitude 2.25 Vcc and a frequency of 10 kHz, separated by 600  $\mu$ s.

#### Oscilloscope adjustment:

- Vertical sensitivity: 0.5 V/div.
- Time base: 200  $\mu$ s/div.
- Trigger mode: Delay
- Main channel: CH1
- Auxiliary channel: CH 1
- Trigger level: 0.5 V
- Trigger condition: 1st rising edge of the main source (CH1) occurring after the first rising edge of the auxiliary source

The trigger is active after the end of the delay (90.0  $\mu$ s) on the first ascending edge. The oscilloscope therefore triggers on the 2<sup>nd</sup> rising edge of the signal since the delay in relation to the 1<sup>st</sup> rising edge is 100  $\mu$ s.

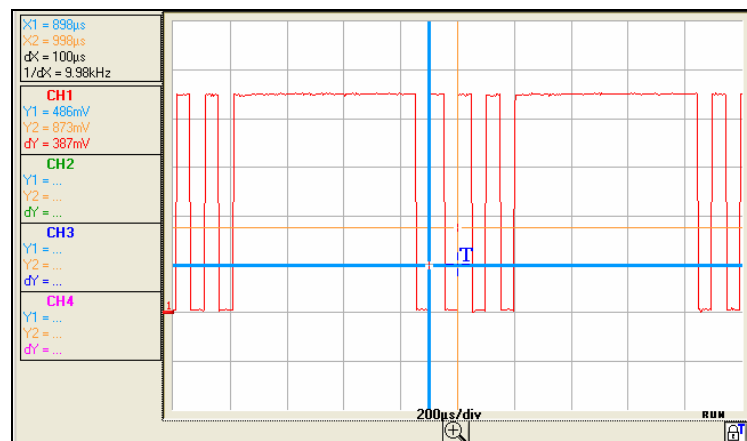

# "Oscilloscope" Instrument (contd.)

## Trigger with COUNT

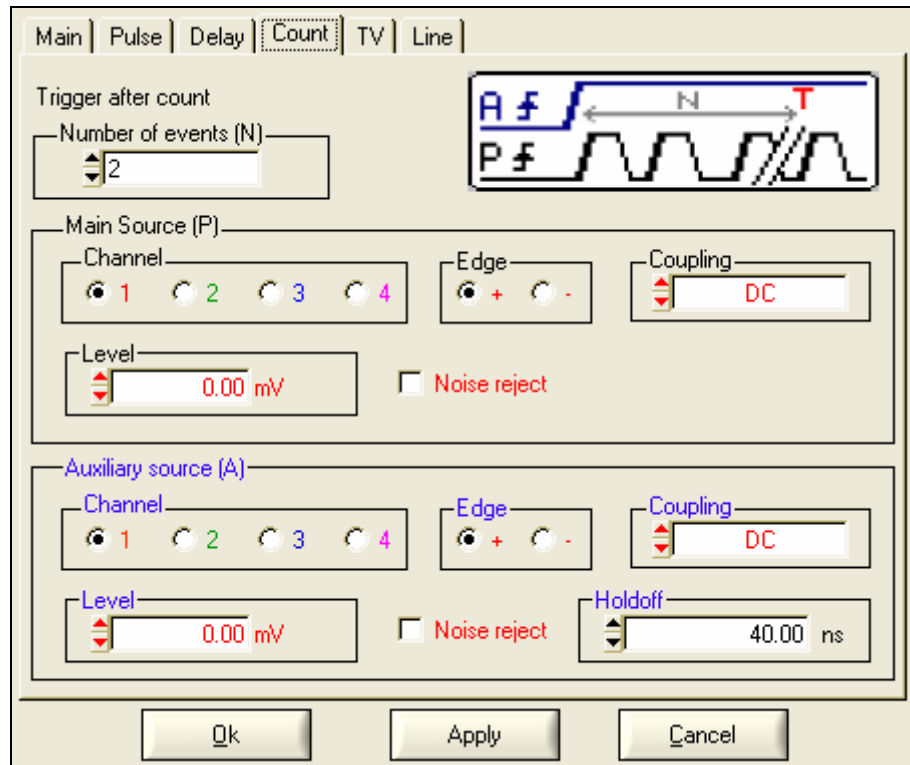

Selects the edge trigger with counting of events.

Events are counted on the main source and this is triggered by the auxiliary source.

The trigger position is situated after the end of the count on the next trigger event from the main source.

The symbolic representation of counting mode corresponds to a series of positive edges.

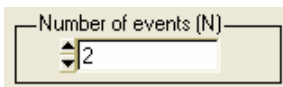

Range from 2 to 16,384

### Main source

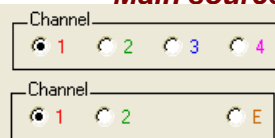

**MTX 1054** : Trigger source: channel 1, 2, 3 or 4

**MTX 1052** : Trigger source: channel 1, 2 or Ext

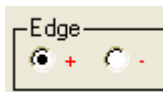

Trigger edge: + -

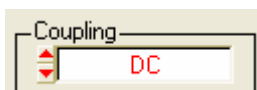

AC - DC - LF reject - HF reject

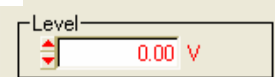

Variation range:  $\pm 8$  div.

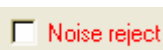

Trigger sensitivity changes from:  $\approx 0.6$  div. to  $\approx 1.5$  div.

## "Oscilloscope" Instrument (contd.)

### Auxiliary source



**MTX 1054** : Trigger source: channel 1, 2, 3 or 4

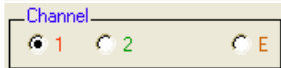

**MTX 1052** : Trigger source: channel 1, 2 or Ext

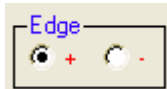

Trigger edge: + -

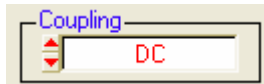

AC - DC - LF reject - HF reject

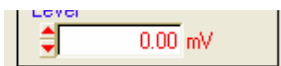

Variation range:  $\pm 8$  div.



Trigger sensitivity changes from:  $\approx 0.6$  div. to  $\approx 1.5$  div.

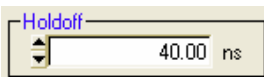

Variation range: from 40.00 ns to 10.5 s



*Example*

Signal injected on CH1: trains of 4 pulses with amplitude 2.25 Vcc and a frequency of 10 kHz, separated by 600  $\mu$ s.

### Oscilloscope programming:

- Vertical sensitivity: 0.5 V/div.
- Time base: 200  $\mu$ s/div.
- Trigger mode: Count
- Main trigger source: CH 1
- Auxiliary trigger source: CH1
- Number of events: 3

Trigger occurs on the 4<sup>th</sup> rising edge of the signal (the 1<sup>st</sup> rising edge on the auxiliary channel triggers counting, the oscilloscope counts 3 rising edges on the main channel and acquisition is then triggered).

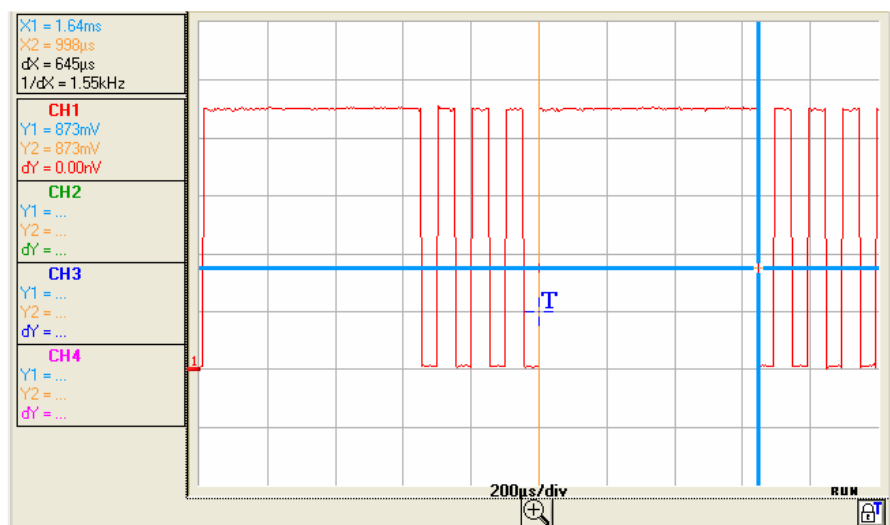

## "Oscilloscope" Instrument (contd.)

### Trigger on TV

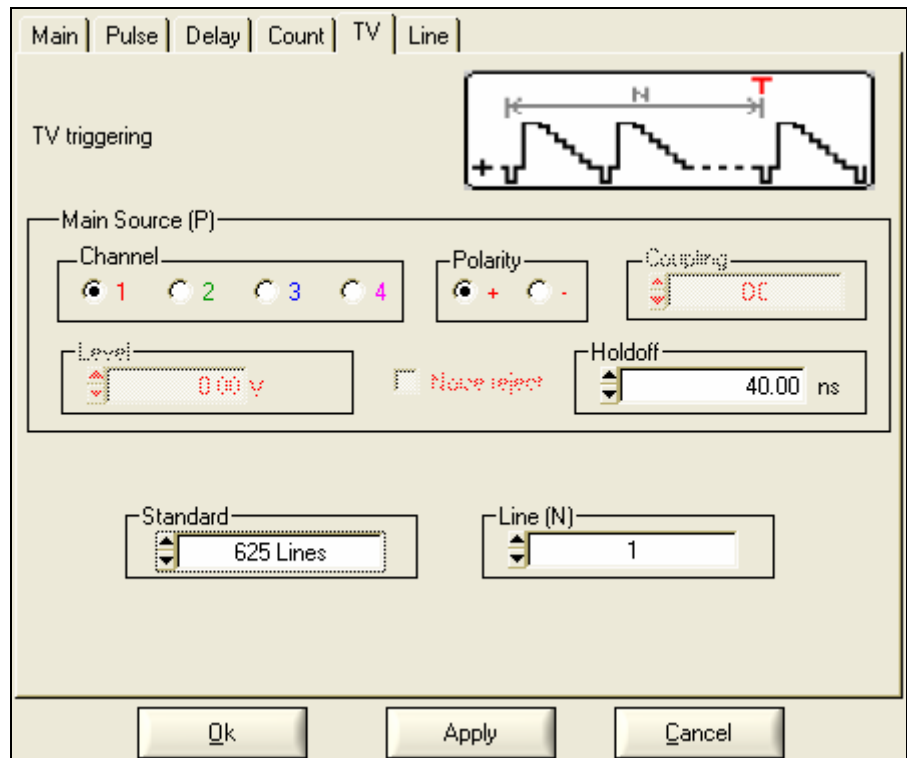

Trigger on a specific line number. The trigger position corresponds to the edge before line synchronisation go-ahead.

- 625 lines (SECAM or PAL)
- 525 lines (NTSC)

The symbolic representation of TV trigger corresponds to a positive video signal.



**MTX 1054** : Trigger source: channel 1, 2, 3 or 4

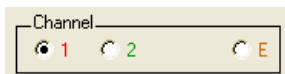

**MTX 1052** : Trigger source: channel 1, 2 or Ext



Video signal polarity: + positive or - negative

- + Direct video
- Reverse video

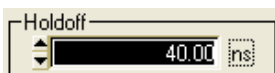

Variation range: from 40.00 ns to 10.5 s

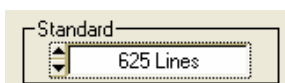

Standard 625 or 525 lines (PAL/SECAM, NTSC)

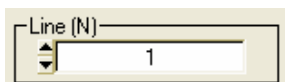

Line N°: from 0 to 525 or 625 depending on the standard

## "Oscilloscope" Instrument (contd.)

 *Example* Video signal display (SECAM)

Signal injected on CH1: video signal with a 625-line amplitude approx. 1.2V

Oscilloscope programming:

- Vertical sensitivity: 200 mV/div.
- Time base: 25  $\mu$ s/div.
- Trigger mode: TV
- Polarity: +
- Line number: 25
- Manual measurements: line frequency period with dX and 1 / dX

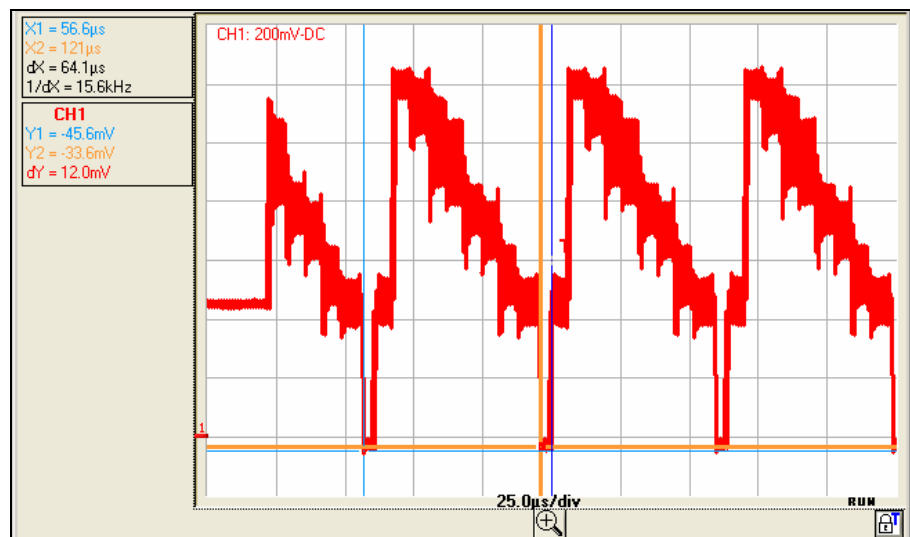

## "Oscilloscope" Instrument (contd.)

### Trigger on LINE

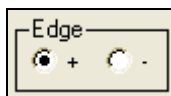
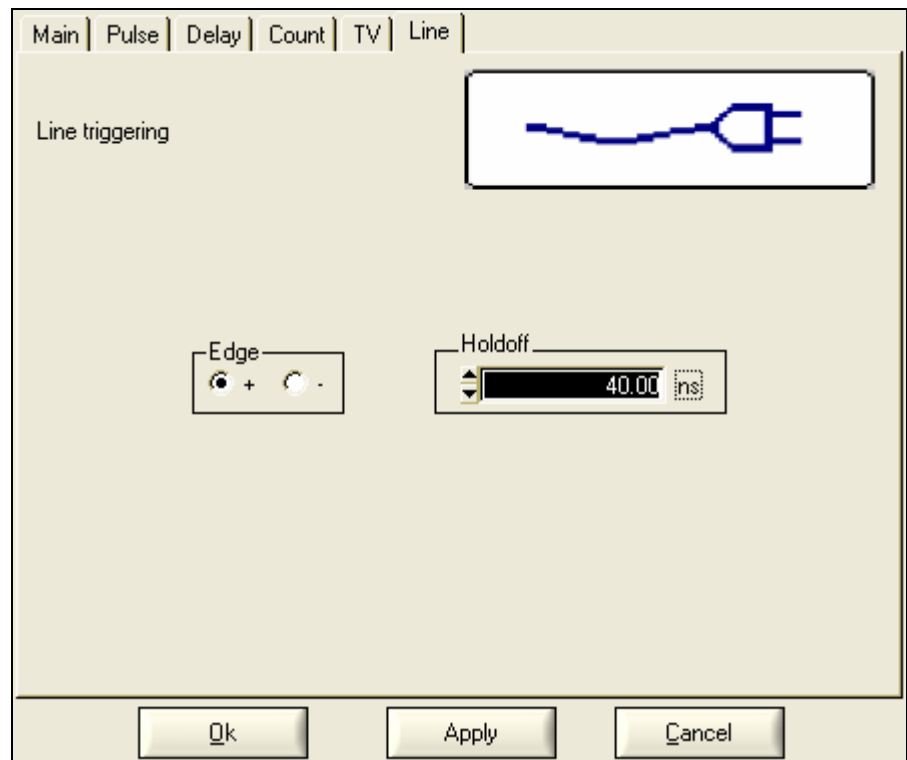

Trigger slope: + or -



Variation range: from 40.00 ns to 10.5 s

## "Oscilloscope" Instrument (contd.)

 *Example* Display of the 50 Hz network signal

Signal injected on CH1: an image of the instrument power voltage  
(mains voltage: 230 VAC  $\pm$  10%, 50 Hz)

Oscilloscope programming:

- Vertical sensitivity: 100 V/div.
- Time base: 5 ms/div.
- Trigger mode: Line
- Trigger slope: +
- Manual measurements:  $dt$ ,  $dv$

Position the manual measurement cursors to determine the frequency and amplitude of the 50 Hz mains supply signal.

**Frequency:**  
**50 Hz**

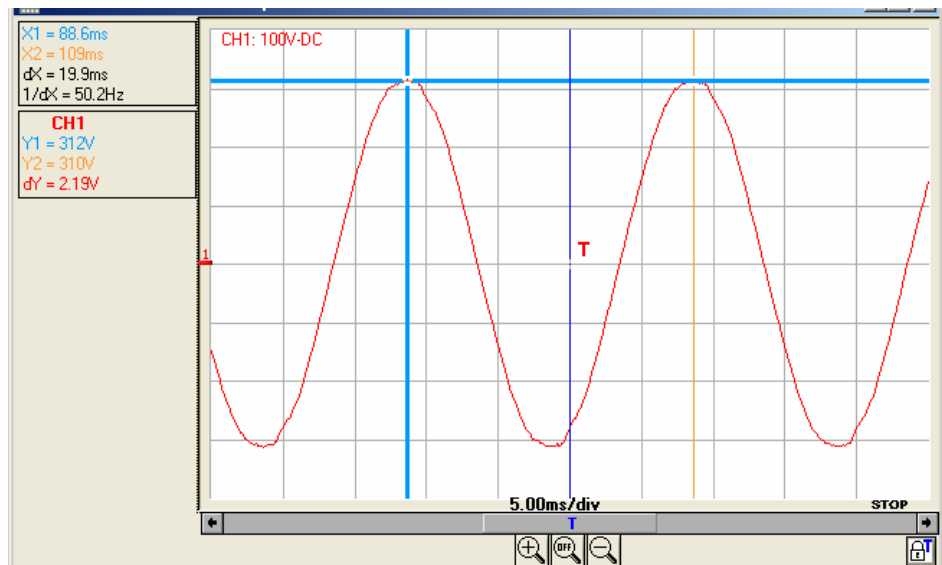

**Amplitude:**  
**623 V peak-to-peak**

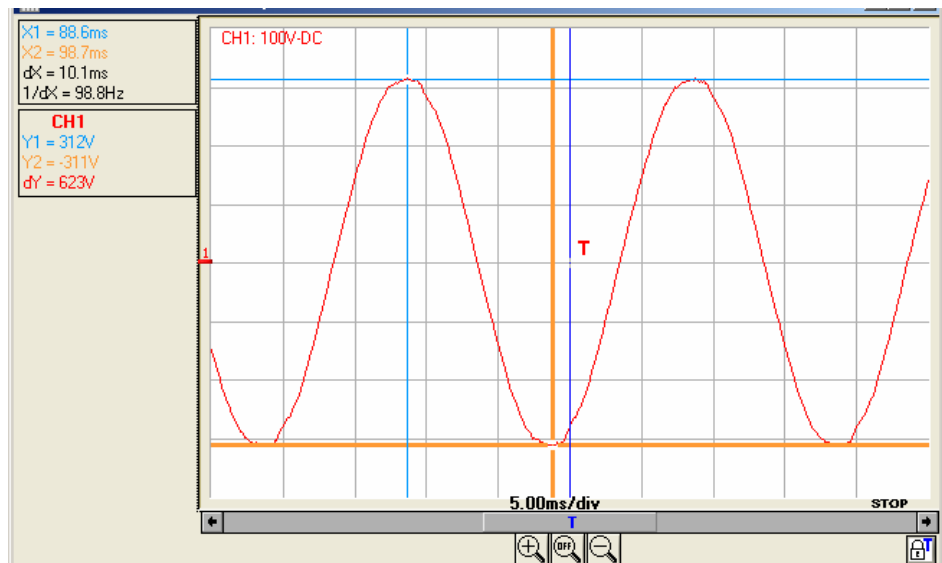

The status of the trigger circuit is indicated on the bottom right of the Oscilloscope trace window; in the previous example it is in STOP.



# "Oscilloscope" Instrument (contd.)

## f. Control buttons



activates a general AUTOSET



launches the LX 1600-PC software of the logic analyzer



captures the current traces (transfer of 50,000 points for each active trace) and displays them in an adjoining window



launches / stops RUN/STOP acquisition



activates the Fast Fourier Transform (FFT) of the signals

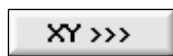

Validation of XY mode.  
The instrument adds a window containing the XY representation to the current f(t) and FFT representations. The windows are simultaneously updated.

The XY source menu is used for assigning one of the 4 traces available to the X (horizontal) and Y axes (vertical).

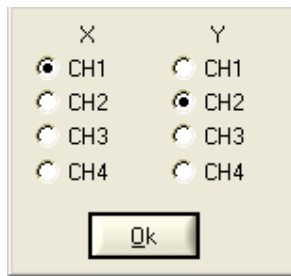

MTX 1054:

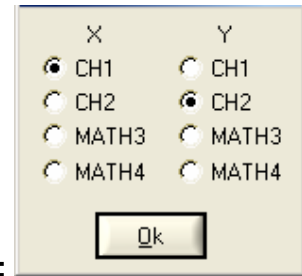

MTX 1052:

Validation of selections using the button.

- Each axis is graduated into 8 divisions.
- The X and Y axes have the nr. of the channel that is assigned to them.
- The « » symbols indicate the traces selected for each axis.

*F(t) and XY representation of these signals*

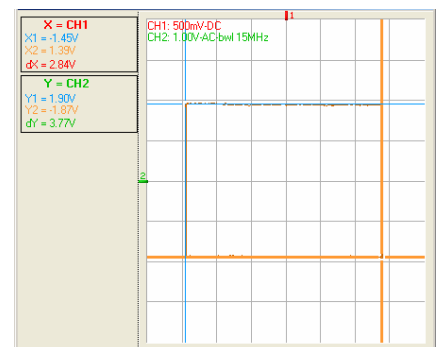
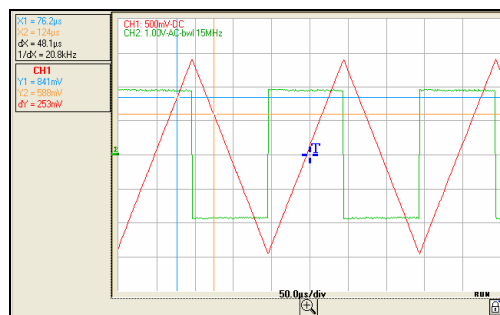

*Example* XY CH1&CH2: trace window: XY representation

In XY mode, there are 2 manual measurement cursors (X1 Y1) and (X2 Y2). The vertical calibres of the traces selected for XY display are indicated on the top left of the window.

The manual measurement cursors of the XY Trace window are separate from those of the Oscilloscope Trace window.

## "Oscilloscope" Instrument (contd.)

**g. FFT box**  
(if the function is activated)

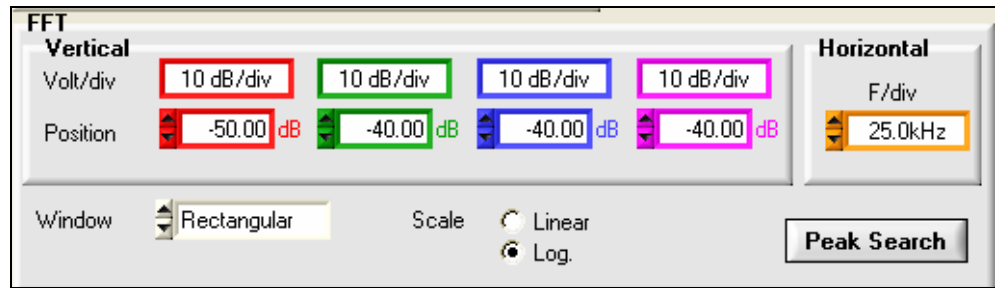

### Settings

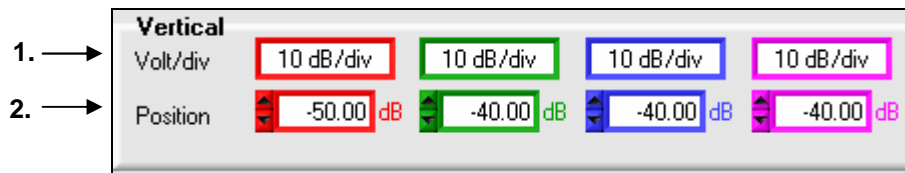

1. Vertical scale of the graphic representation (10 dB/div if log representation, depends on the sensitivity of the channel on a linear scale)
2. Position of the origin of the traces in relation to the graphic representation origin

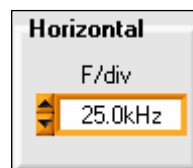

Horizontal sensitivity of traces: directly linked to the time base of the time representation

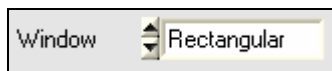

Choice of window type for the FFT calculation in order to limit time signal discontinuity effects

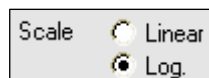

Choice of vertical representation scale for the curve



Display cursors and research of the maximum peak in the FFT



***If an autoset is carried out with the FFT window active, the frequency scale will be automatically set so as to position the fundamental on the first environment division.***

## "Oscilloscope" Instrument (contd.)

### FFT representation (Fast FOURIER Transform)

*Reminder:* Activation by clicking on the  button in the **Horizontal** box.

#### *Real-time calculation of the FFT*

The Fast FOURIER Transform (FFT) is used to calculate the discrete representation of a signal in the frequency domain, based on its discrete representation in the time domain.

FFT can be used in the following applications:

- measurement of the different harmonics and the distortion of a signal,
- analysis of a pulse response,
- search for noise source in logic circuits.

The FFT is calculated over 2500 points.

*The instrument simultaneously displays the FFT and the trace f(t).*

#### *Description*

The Fast Fourier Transform is calculated according to the equation:

$$X(k) = \frac{1}{N} * \sum_{n=-\frac{N}{2}}^{\frac{N}{2}-1} x(n) * \exp\left(-j \frac{2\pi nk}{N}\right) \text{ for } k \in [0 (N-1)]$$

with:

- x (n): a sample in the time domain
- X (k): a sample in the frequency domain
- N: resolution of the FFT
- n: time index
- k: frequency index

The displayed trace represents the amplitude in V or dB of the various signal frequency components depending on the selected scale.

The DC component of the signal is removed by software.

## "Oscilloscope" Instrument (contd.)

The finite duration of the study interval results in a convolution in the signal frequency domain with a function  $\sin x/x$ .

This convolution modifies the graphic representation of the FFT because of the lateral lobes characteristic of the  $\sin x/x$  function (unless the study interval contains an whole number of periods).

Five types of weighting windows are offered:

- Rectangular
- Hamming
- Hanning
- Blackmann
- Flattop

The following table enables the user to choose the type of window according to the type of signal, the desired spectral resolution and the amplitude measurement accuracy:

Window	Type of signal	Frequency resolution	Spectral resolution	Amplitude accuracy	Highest lateral lobe
Rectangular	transient	the best	poor	poor	- 13 dB
Hamming	random	good	reasonable	reasonable	- 42 dB
Hanning	random	good	good	reasonable	- 32 dB
Blackman	random or mixed	poor	the best	good	- 74 dB
Flat Top	sine wave	poor	good	the best	- 93 dB

The following table gives the theoretical maximum amplitude error for each type of window:

Window	Theoretical max. error in dB
Rectangular	3.92
Hamming	1.75
Hanning	1.42
Blackman	1.13
Flat Top	< 0.01

This error is linked to the calculation of FFT when there is not a whole number of periods for the signal in the observation window.

Shannon's theorem must be observed, that is to say the sampling frequency " $f_e$ " must be more than twice the maximum frequency contained in the signal.

If this condition is not met, spectrum folding phenomena are observed.

For example, if the sampling frequency " $f_e$ " is too low, the following will occur:

- Truncating of the spectrum beyond " $f_e/2$ "
- Modification of the spectrum below " $f_e/2$ " (due to the overlap of several staggered spectra).

## "Oscilloscope" Instrument (contd.)

Signal injected on CH1:  
 Square signal of amplitude 2.5 Vpp frequency 10.0 kHz

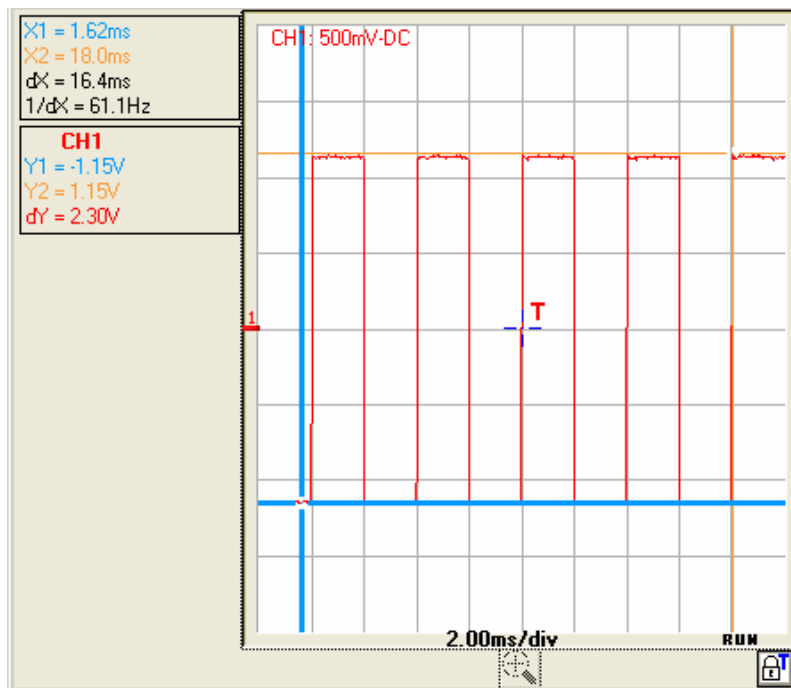

FFT obtained with a rectangular window and a logarithmic vertical scale (10 dB/div.)

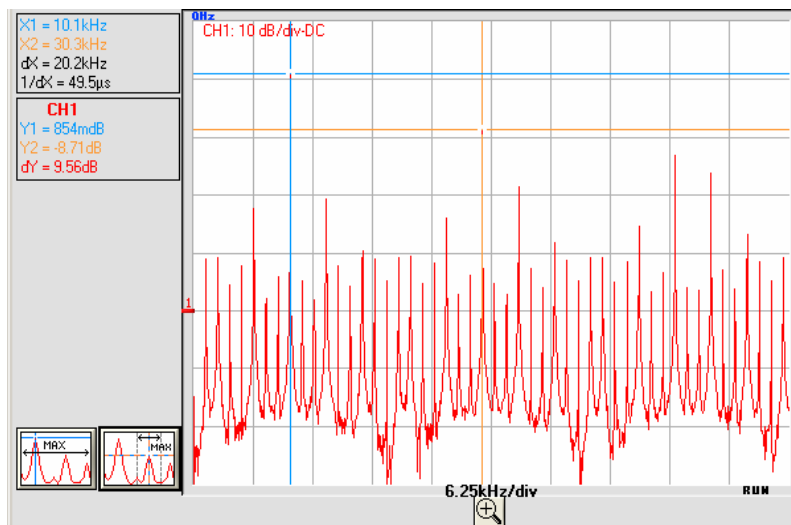

The frequency of the fundamental is 10.1 kHz and that of the harmonic 3 to 30.3 kHz and the difference of level between the fundamental and the first harmonic is 9.56 dB (which corresponds to an amplitude of the 3<sup>rd</sup> harmonic, equal to around 33% of that of the fundamental).

FFT units

Horizontal unit: this is calculated from the sweep coefficient:

$$\text{Unit (in Hz/div.)} = \frac{12.5}{\text{sweep coefficient}} \quad \text{Ex: } \frac{12.5}{2 \text{ ms}} = 6.25 \text{ kHz}$$

Vertical unit: 2 possibilities are offered:

- a) **Linear scale:** by checking the linear scale in the FFT box in V/div. = unit of the signal in its time representation V/div.
- b) **Logarithmic scale:** by checking the logarithmic scale

## "Oscilloscope" Instrument (contd.)

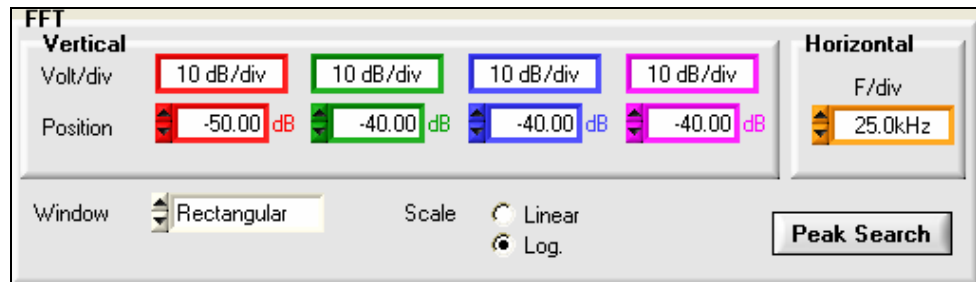

### Logarithmic scale dB/div - Flat Top window:

the level 0 dB corresponds to a sine wave signal with an amplitude  $1 V_{rms}$ .

We injected a sine wave signal with an amplitude  $1 V_{eff}$  and a frequency 50 kHz on the CH1 input of the oscilloscope; below is the FFT obtained with the logarithmic and linear scales and a Flattop window:

### Logarithmic scale

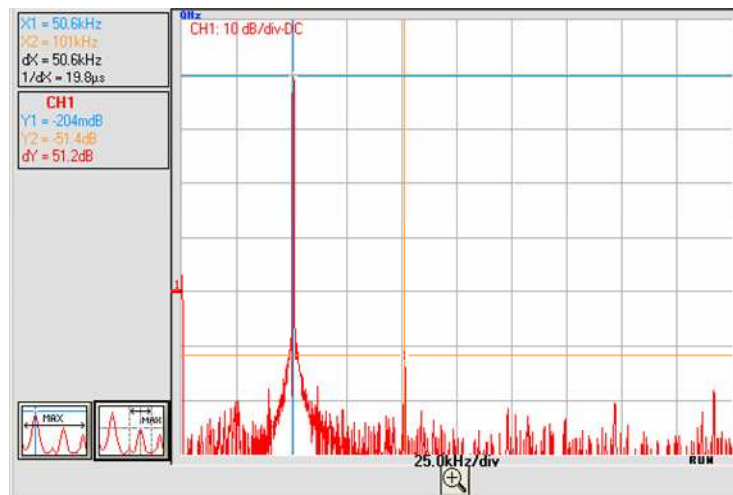

### Amplitude of the fundamental -0.204 dB frequency 50.6 kHz:

the vertical position indicator of the FFT representation is at -50 dB.

### Linear scale

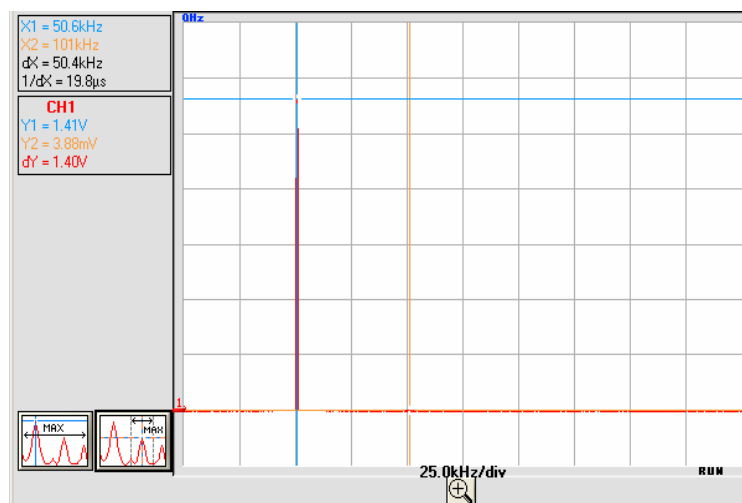

### Amplitude of the fundamental 1.40 V frequency 50.6 kHz

## "Oscilloscope" Instrument (contd.)

### Graphic representation

The FFT representation indicates symmetry in relation to the frequency origin; only positive frequencies are displayed.

- The "•" symbol, appearing before one of the options indicates the scale selected.

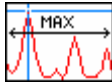

- The (window) MAX can be automatically located by clicking on the button opposite. Cursor 1 is therefore positioned on the MAX of the representation on the screen when pressed.

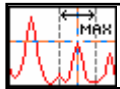

- The exact location of the MAX around the active cursor ( $\pm 25$  div) is obtained by clicking on the 2<sup>nd</sup> button opposite. The MAX search zone is evidenced when the button is pressed by a black rectangle around the cursor.
- Manual measurement can be carried out on the frequency representation with the "unattached cursors" ( §. Measurement Menu → Unattached manual cursors.



**To avoid distorting the spectral content of the signal and obtain the most accurate calculation of the FFT, it is advisable to work with a signal peak-to-peak amplitude of 3 to 7 div.**

If the amplitude is too low, accuracy will be reduced, and if it is too high, over 8 divisions, the signal will be distorted, leading to the appearance of undesirable harmonics.

Simultaneous time and frequency representation of the signal facilitates monitoring of changes in the signal amplitude.



### **Effects of under-sampling on frequency representation:**

*If the sampling frequency is not correctly adjusted (less than or twice the maximum frequency of the signal to be measured), the high-frequency components will be under-sampled and appear in the graphic representation of the FFT by symmetry (aliasing).*

- The Autoset function enables the above phenomenon to be avoided and the horizontal scale adapted to make the representation more readable.
- The "Zoom" function is active in FFT.

## "Oscilloscope" Instrument (contd.)

**Rectangular** In the calculation of the FFT, the type of window applied is selected with the up/down scroll bars or by clicking on the Window field in the FFT box.

**Hamming**

**Hanning**

**Blackman**

**Flat Top**

Before calculating the FFT, the oscilloscope weights the signal to be analyzed by means of a window acting as a band-pass filter. The choice of window type is essential to distinguish between the various lines of a signal and to make accurate measurements.

*Time representation of signal to be analyzed*

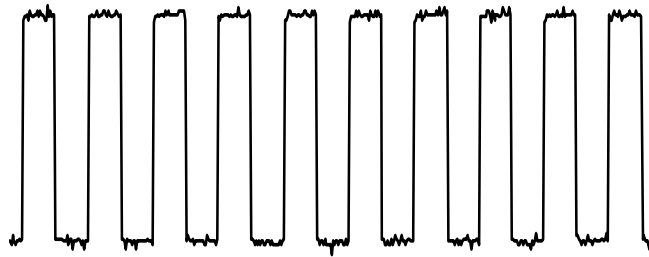

*Weighting window*



*Weighted signal*

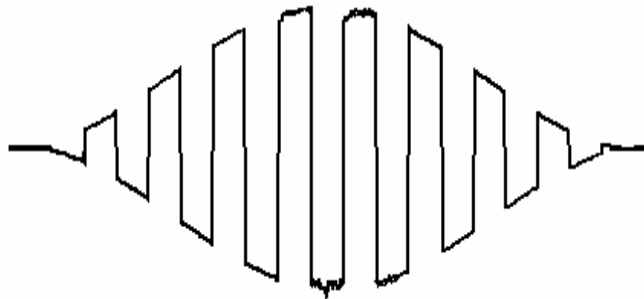

*Frequency representation of signal calculated by FFT*

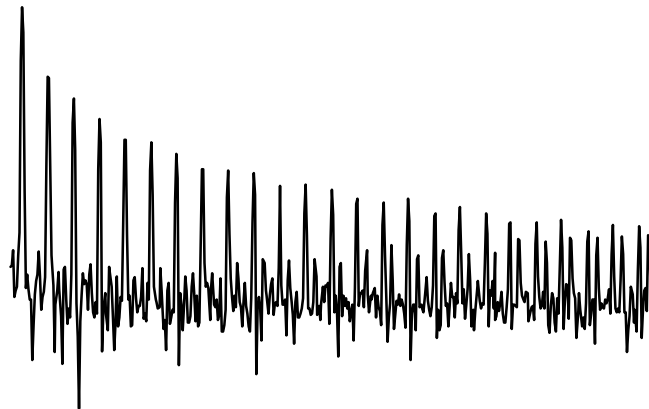



# "Oscilloscope" Instrument (contd.)

## Display of the Oscilloscope Trace Window

### Trace window

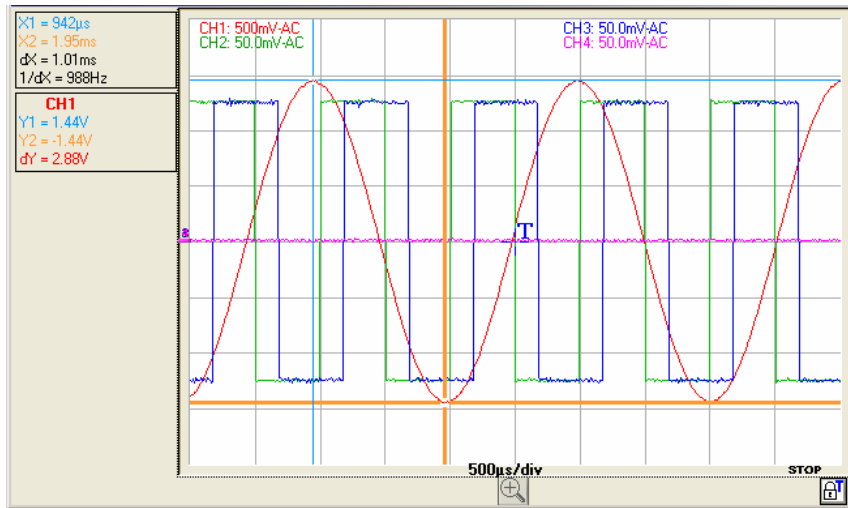

*Boxes displaying the values of manual measures dt, dv 1/dt*

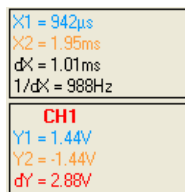

### Trace description

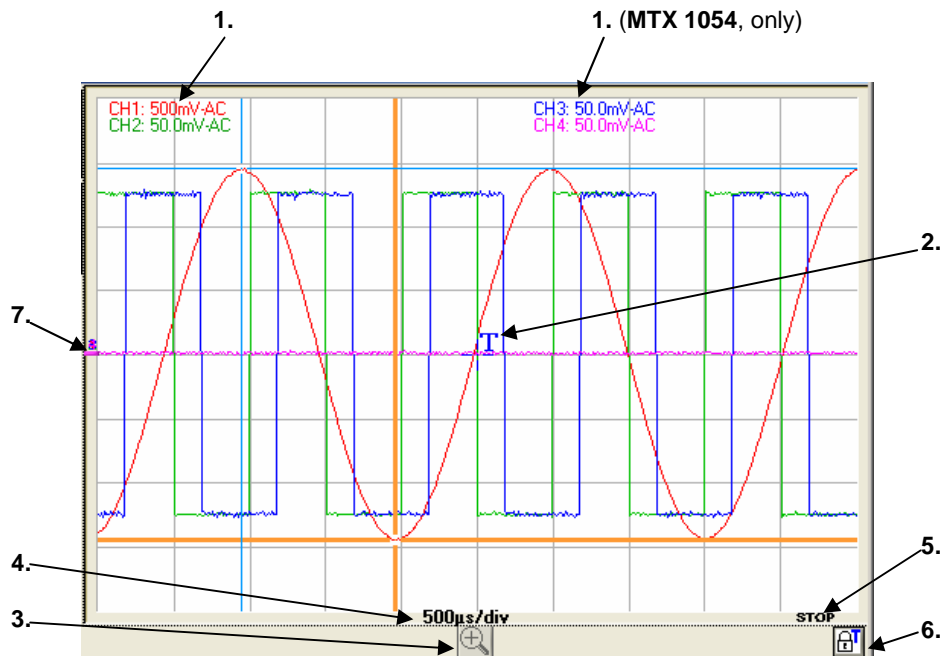

1. Display of sensitivity, coupling and channel bandwidth limit
2. Position of the Trigger T
3. Zoom in/out button: activation of the dynamic horizontal zoom
4. Display of the trace time base
5. Current status of acquisition
6. Locking of the Trigger to avoid untimely movement with the mouse
7. Position (0 V) of the channels

## « Oscilloscope » Instrument (contd.)

### The « File » menu

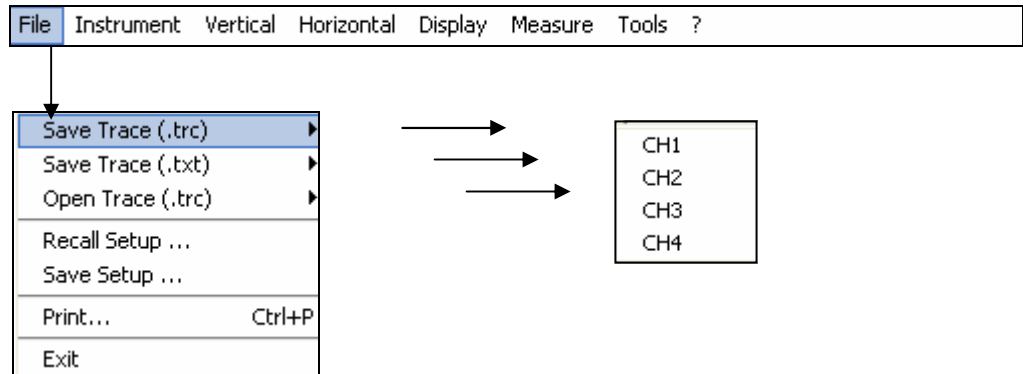

### Trace

The selected trace is saved to its volatile reference memory ; it can be saved in two formats :

**Save .trc** saving files to recall them in the trace window

**Save .txt** saving files to export them to another application

The files saved have the extension **.TXT** ; they can be exported in a standard format for use in another programme (spreadsheet, etc.).

### Example

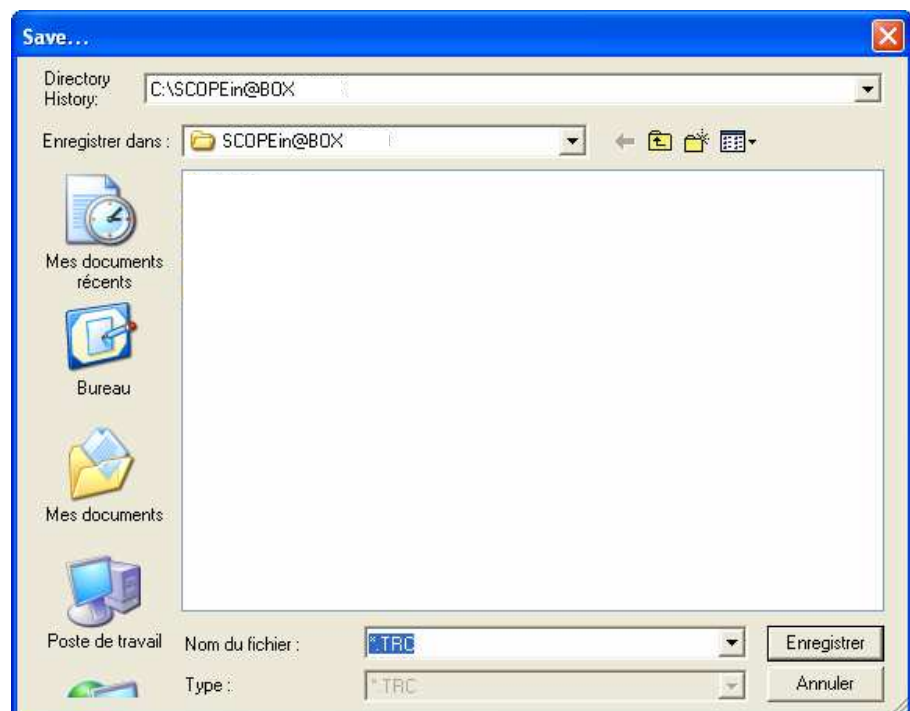

- Choose the save directory.
- Enter the name of the file to be saved using the keyboard (  : **xxx.TRC** or **xxx.TXT** for a text format).
- Click on **Enregistrer** to save the file.  
The name of the file saved takes the extension **.TRC** (or **.TXT**).
- To exit the menu without saving, click on **Annuler**.

## « Oscilloscope » Instrument (contd.)

**Open** selected opens following window :

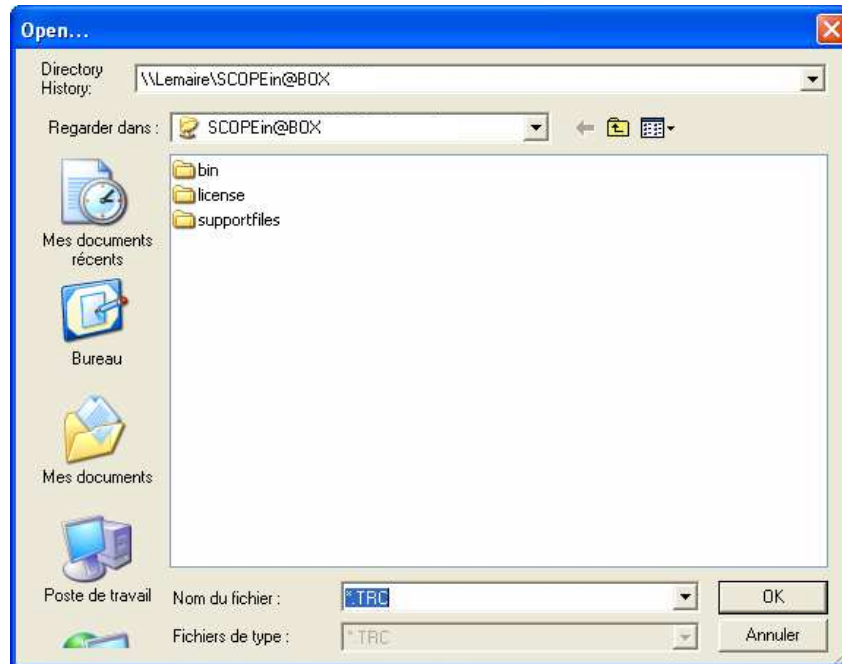

The list contains the .TRC files saved in the C:\TRC directory via the "Trace → Save.TRX" menu.

Select a file and click on  to call it up.

The trace is displayed on the channel selected, CHx (✎ : CH1):

On the Oscilloscope control panel:

- **CH1** is replaced with **MEM1**
- the Autoset button is replaced with the time base value and by the name of the trace record saved.

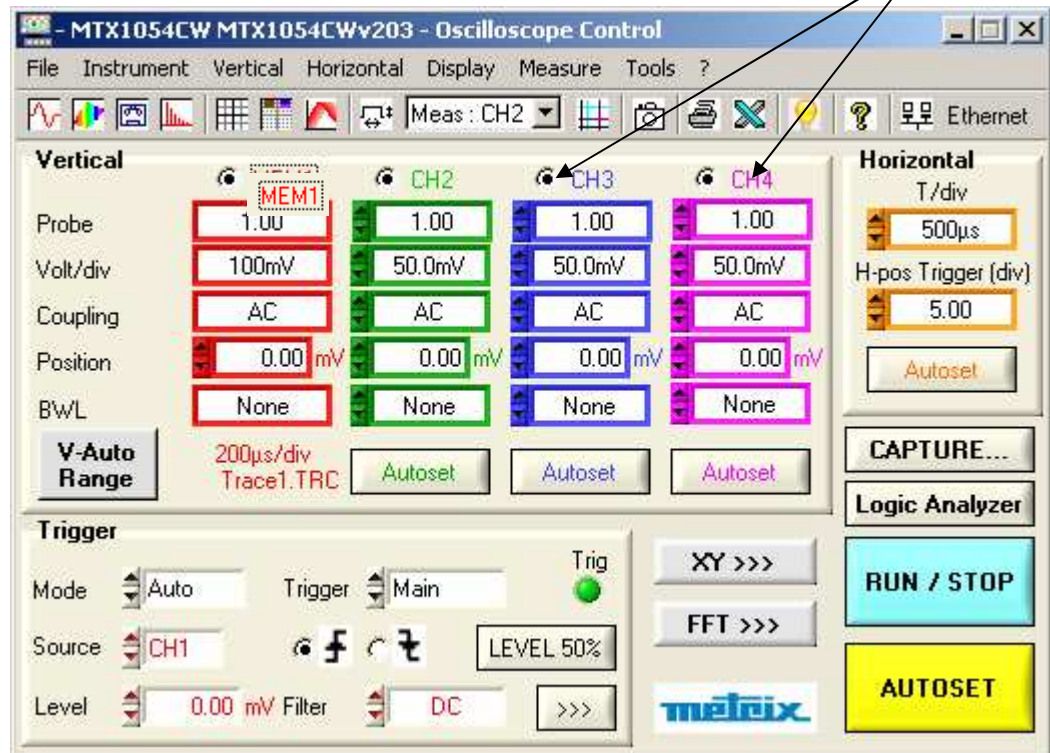

(\* ) MATHx for MTX 1052

## « Oscilloscope » Instrument (contd.)

If the user does a CAPTURE of the traces (🔍 : MEM1, CH2, CH3 and CH4) the following window is displayed:

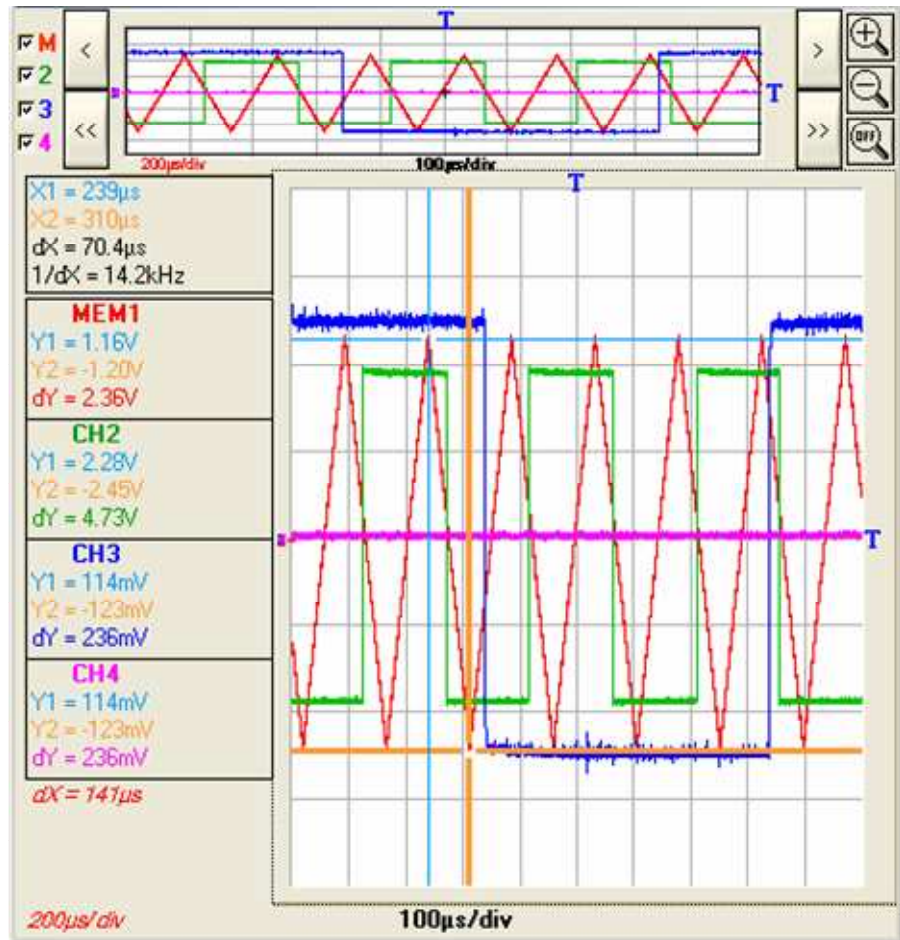

The following are indicated in this window:

- the current time base in s/div (black colour) corresponding to the channels not saved
- the time base of the trace saved (colour of the MEMx trace)
- When ZOOM coefficient values are changed, the CHx channel time base coefficients change.
- If manual cursors are present, the values of dX and dYs are indicated, corresponding to the CHx and MEMx channels, for all the ZOOM coefficients.

🔍 In the above example, MTX 1054:

The channels CH2, CH3, CH4 are acquired with a time base coefficient of 100µs/div.

The channel saved MEM1 was acquired with a time base coefficient of 200µs/div.

If a ZOOM coefficient of 2 is applied to these 4 traces, the time bases zoomed are 50µs/div. for CH2, CH3, CH4 traces and 100µs/div. for the MEM1 trace.



## « Oscilloscope » Instrument (contd.)

### Setup

#### Recall

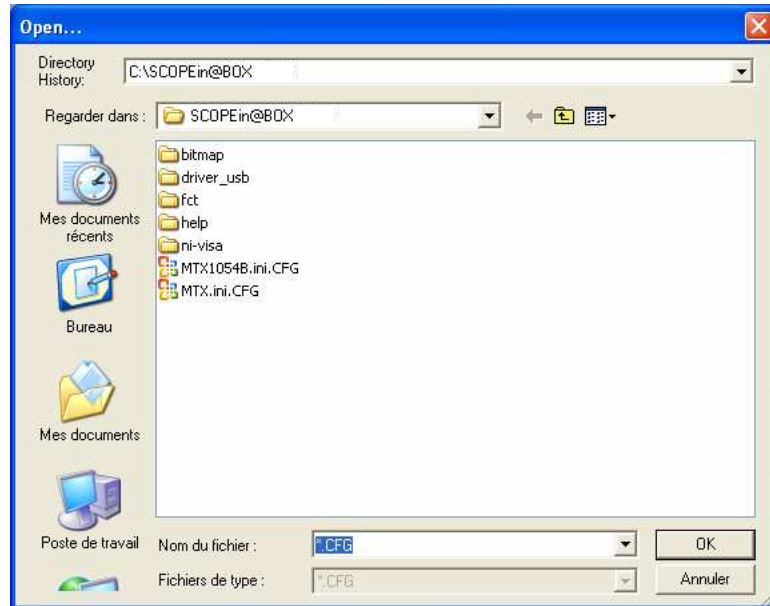

- The Filename box contains the default name \*.CFG This file contains the parameters of the instrument configuration when the window is opened.
- Enter the filename with the keyboard
- Click on **Enregistrer** to save the instrument settings.  
(save file: extension **.CFG**)
- **Annuler** To exit the window without recalling.

#### Save

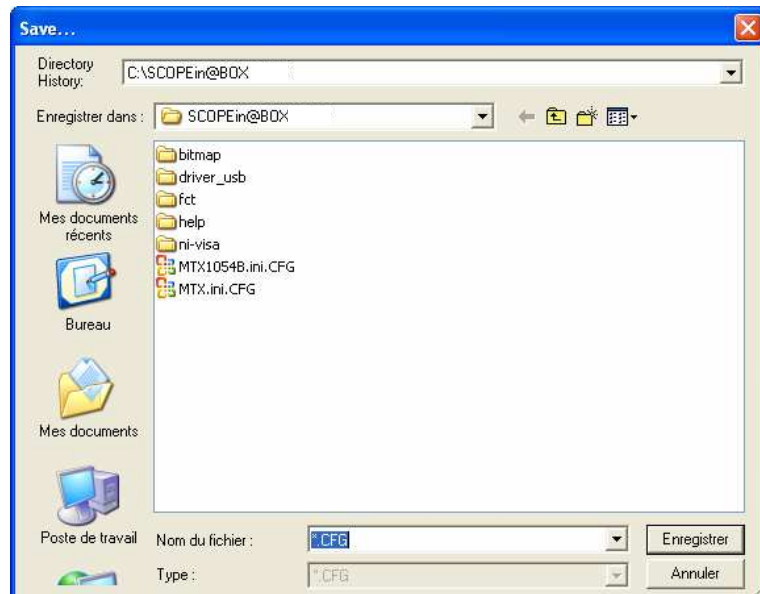

- This window shows a list of the files (**.CFG**) saved via the "Settings → Save" menu.
- Select the file to be called up by clicking with the mouse.
- Then click on the **OK** button to recall the settings saved.
- **Annuler** To exit the window without saving.

---

## « Oscilloscope » Instrument (contd.)

---

### Print

This window allows the selection of the panel(s) that you wish to print.

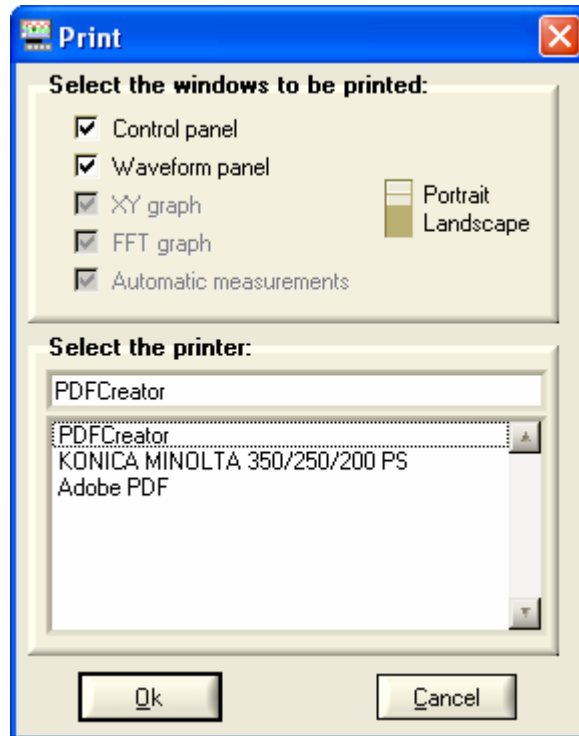

The paper orientation (Portrait/Landscape) is selected with the switch opposite.

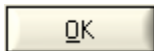

Start printing

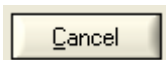

Exit without printing

---

### Exit

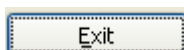
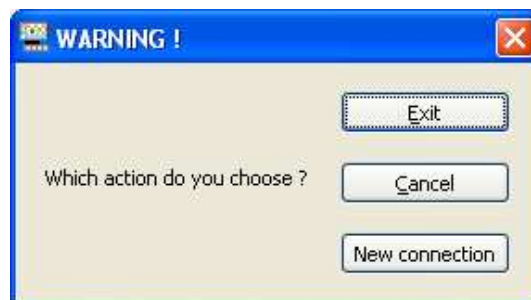

exits the application and save the current configuration.

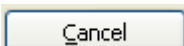

opens the same oscilloscope.

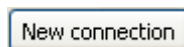

connects a new oscilloscope and opens « Starts of an oscilloscope » window.

---

## "Oscilloscope" Instrument (contd.)

---

### The "Instrument" menu

This menu:

- selects the instrument,
- exits the application, saving the current operating context.

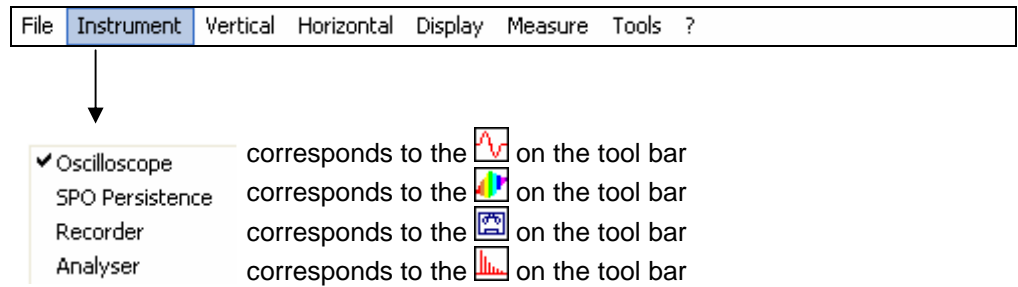



## "Oscilloscope" Instrument (contd.)

### The "Vertical" menu

- selects a vertical unit for each channel,
- defines / activates the "MATH" functions.

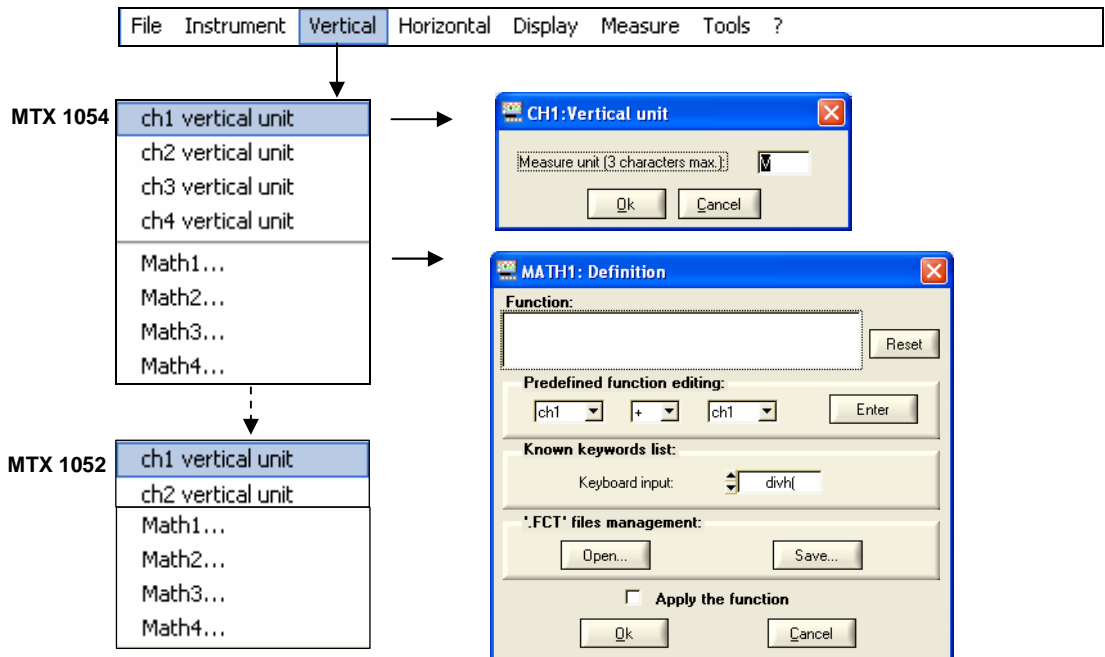

### CH1 CH2 CH3 CH4 vertical unit

inputs the measuring unit of the channel concerned. This unit can be encoded using a maximum of 3 characters (e.g.: VAC ...)

### Math1 ...2 ...3 ...4

gives access to the window for definition of the mathematical functions that can also be directly accessed from the "Vertical" box with a right click on the CHx channel labels.

A mathematical function can be input by:

1. automatic input, with the assistance of the predefined functions editor
2. callup of a ".fct" function file from the FCT file management menu
3. direct input of the function via the keyboard in the edit window

In all cases, the user can use the edit function manually (maximum of 100 characters).

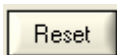

erases the content of the input box.

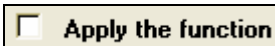

*Don't forget to check this box if you wish to display the result of this function before confirming your choice with the OK button. Whether or not the function is activated, its definition is memorised, even when the instrument has been turned off, until replaced by a new expression.*

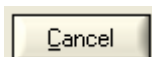

cancels the window without modifying the initial definition of the function or its possible activation.

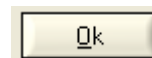

makes a syntactical, semantic analysis of the function input and closes the

window, activating or not activating the function if the box  **Apply the function** is checked

## "Oscilloscope" Instrument (contd.)

### Function definition

#### 1. Editing a predefined function

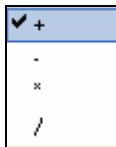
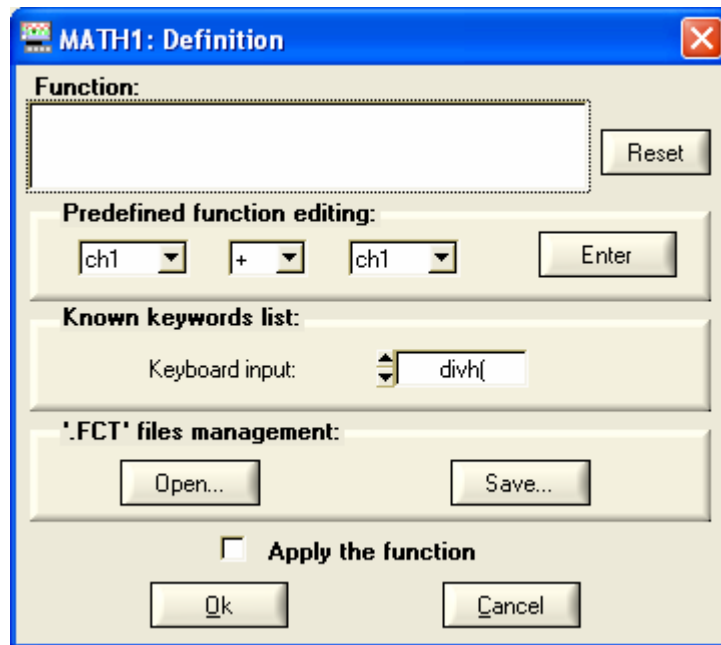

The multiple-choice dialogue boxes help the user to define the elementary functions on channels (channel inversion, addition, subtraction, multiplication and division).

Once the elements have been selected, input is validated by pressing  and the elementary function desired is generated (with automatic scaling management) in the input window.

#### 2. ".FCT" file management

Mathematical functions stored in ".FCT" extension files can be saved or recalled.

To call up a function: click on  and select the desired file from the management window.

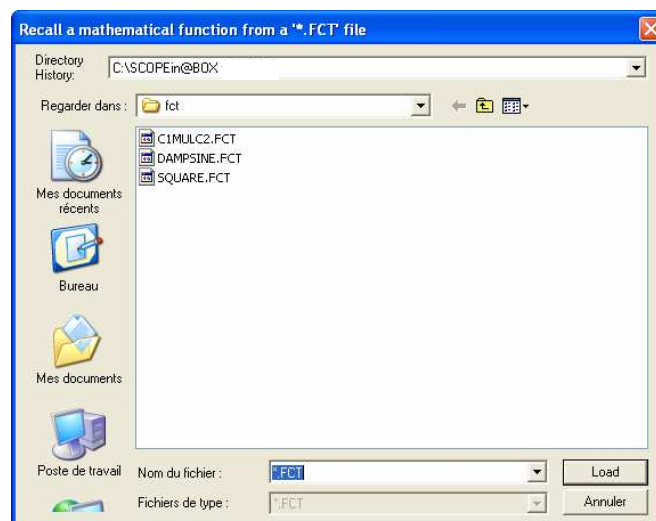

The function is selected with the mouse and it is loaded with .

The mathematical function is then copied into the edit window.

## "Oscilloscope" Instrument (contd.)

- ☞ *Three examples of mathematical functions come with the software* These functions, stored in the project FCT directory are:
- C1MULC2.FCT
  - SQUARE.FCT
  - DAMPSINE.FCT

**C1MULC2 .FCT function** The C1MULC2.FCT = CH1\*CH2/divv(4) calculates the product of 2 traces, scaling the result so that it is framed in the screen.

*The divv(4) factor is used to optimize the display as long as the source signals have sufficient dynamics and no overshooting.*

We have injected a square signal onto channel CH1 and a triangular signal on channel CH2, centred on 0 Volts. We represent the result of the MATH3 = C1MULC2.FCT function on channel 3.

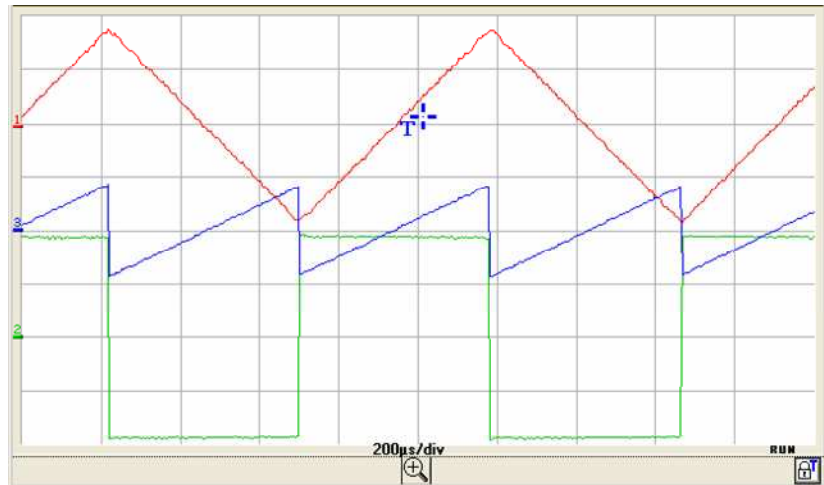

**SQUARE.FCT function** This is the definition of a square signal using the first 4 harmonics of a Fourier series development.

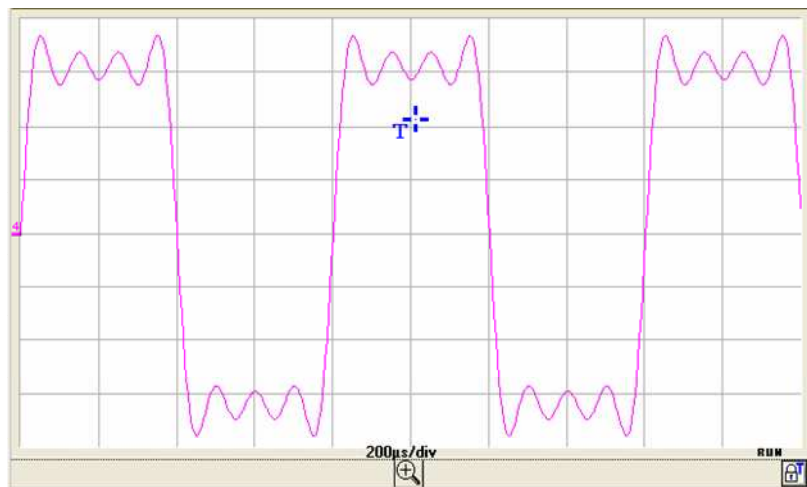

math4 = SQUARE.FCT

$$\text{math4} = (\sin(\pi \cdot t / \text{divh}(2)) + \sin(3 \cdot \pi \cdot t / \text{divh}(2)) / 3 + \sin(5 \cdot \pi \cdot t / \text{divh}(2)) / 5 + \sin(7 \cdot \pi \cdot t / \text{divh}(2)) / 7) \cdot \text{divv}(4)$$

# "Oscilloscope" Instrument (contd.)

**DAMP SINE.FCT** This is the definition of a damped sine wave.  
**function**

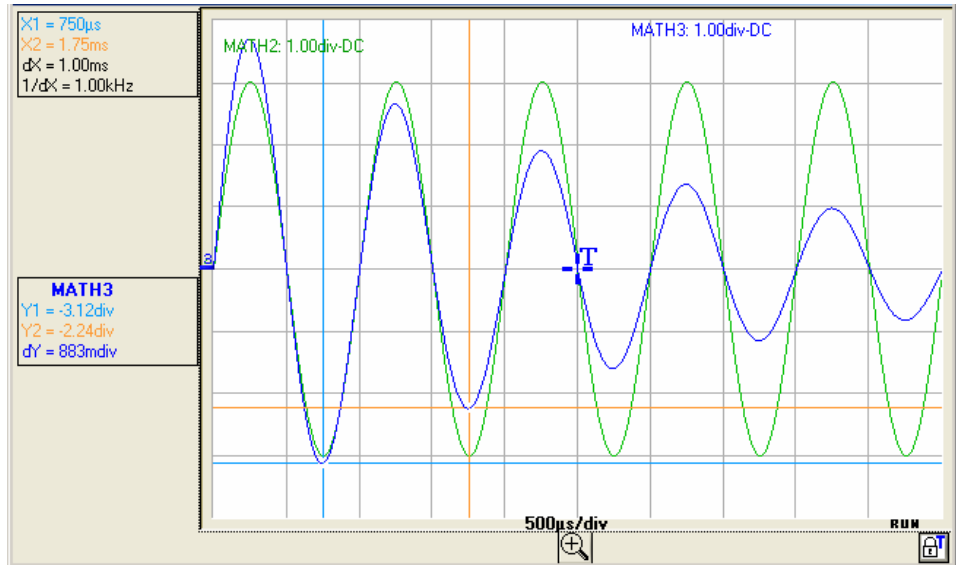

$$\text{Math3} = \sin(\pi * t / \text{divh}(1)) * \exp(-t / \text{divh}(6)) * \text{divv}(4)$$

**3. Manual input** This is an enhanced mode in which the user inputs the desired mathematical function on the keyboard.

For information purposes, a list of the key words recognised by the mathematical interpreter is available in the multiple-choice dialogue box. These key words are basic functions recognised by the instrument's mathematical interpreter.

8 basic mathematical functions can be linked to the traces

<b>divh(</b>	("horizontal division")
<b>divv(</b>	("vertical division")
<b>step(</b>	("step") using "t" (*)
<b>sin(</b>	("sine")
<b>cos(</b>	("cosine")
<b>exp(</b>	("exponential")
<b>log(</b>	("logarithmic")
<b>sqrt(</b>	("square root")

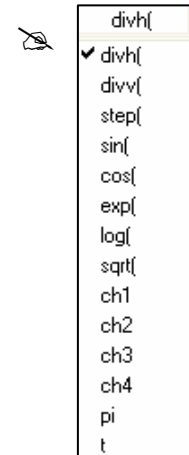

(\*) t = abscissa of the sample (point) in the 50,000-sample (points) depth acquisition memory.

*divh(1) is equivalent to 5,000 samples (points) = 1 horizontal division.*

The result of the calculation of a function is always an LSB. To obtain a vertical division deviation, 32,000 LSBs are needed (amplitudes are calculated using a virtual 19 dynamic 8 div. virtual ADC).

*divv(1) = 1 vertical division = 32,000 LSBs.*

**With certain mathematical formulae, the calculation time may be long and the application slowed down.**

## "Oscilloscope" Instrument (contd.)

### Use of elementary maths functions on CH1 CH2 CH3 CH4

🔍 Examples

#### Sum of CH1 + CH2

CH1 red trace  
CH2 green trace  
MATH4 = ch1 + ch2 pink trace

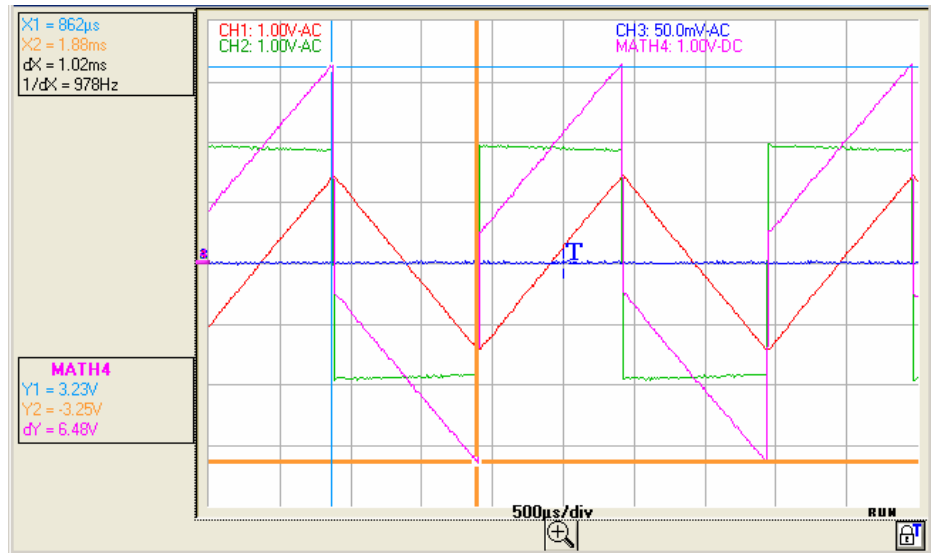

#### Difference CH1 - CH2

CH1 red trace  
CH2 green trace  
MATH4 = ch1 - ch2 pink trace

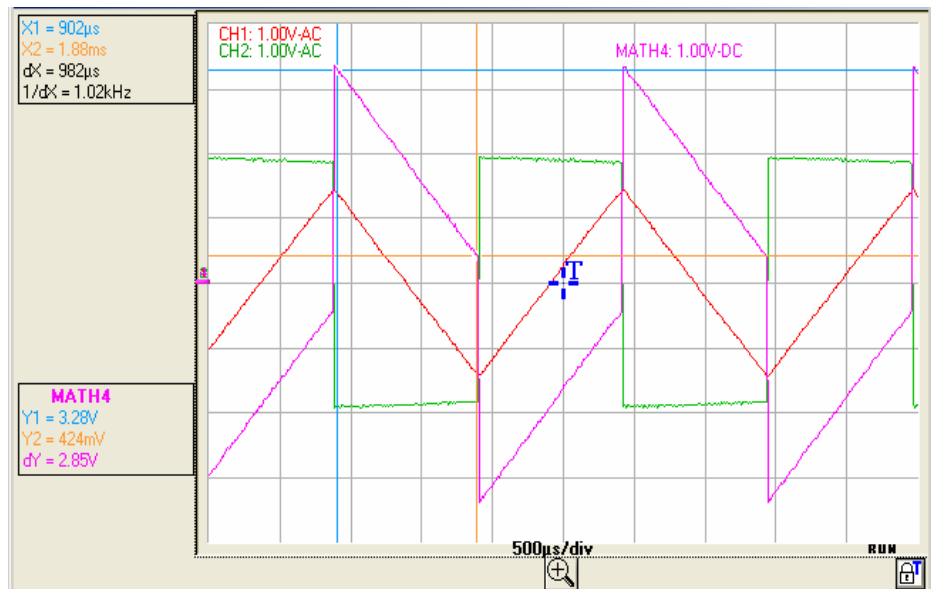

## "Oscilloscope" Instrument (contd.)

**Product (CH1 \* CH2)** CH1 **red** trace  
 CH2 **green** trace  
 MATH4 = (ch1 \* ch2) / divv(1) **pink** trace

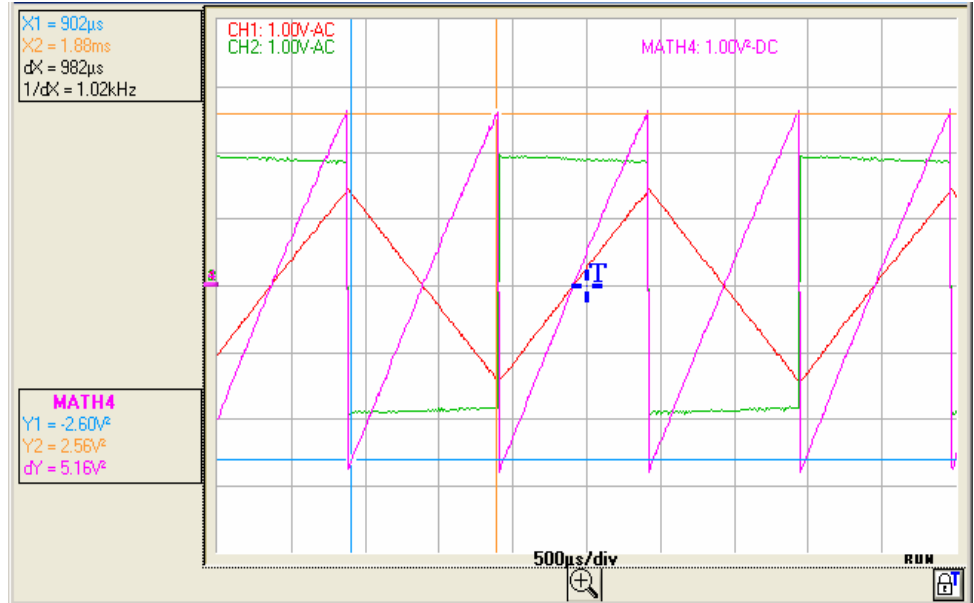

Multiplication by divv(1) is necessary to translate the result of the multiplication into divisions.

**Division CH1 / CH2** CH1 **red** trace  
 CH2 **green** trace  
 MATH4 = (divv(1) \* ch1) / ch2 **pink** trace

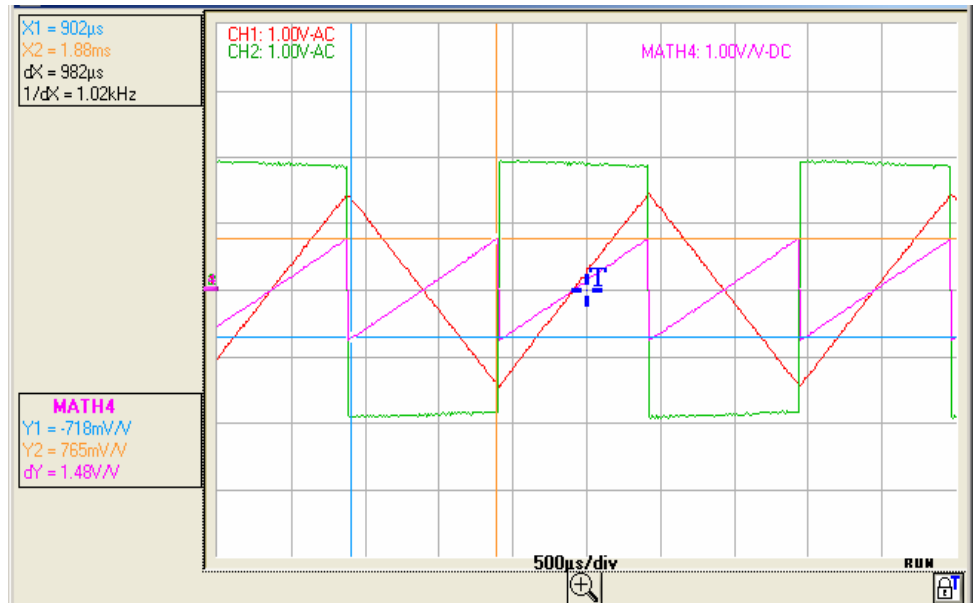

Division by divv(1) is necessary to translate the result of the division into divisions.

## "Oscilloscope" Instrument (contd.)

### Use of maths functions

 Examples

***Divv() function used on its own***

Math3 = divv(3)  
blue trace

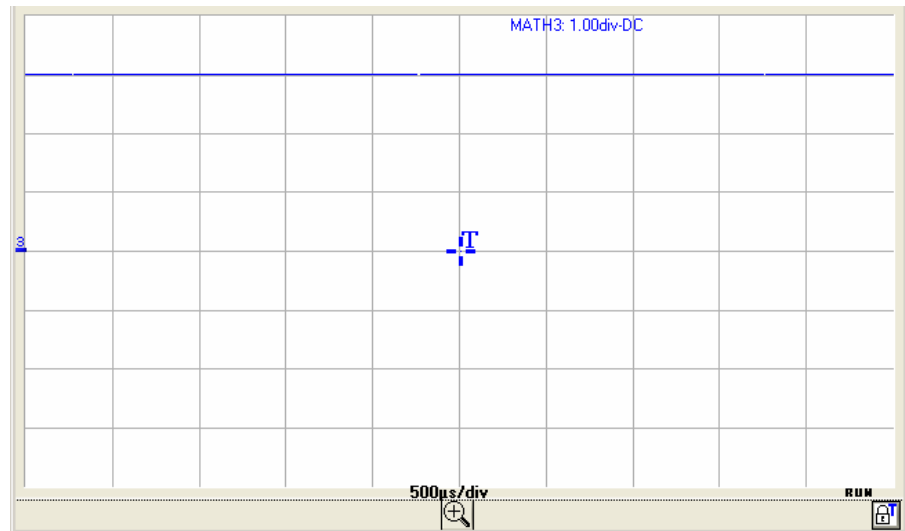

The trace is equal to 3 vertical divisions.  
 $\text{divv}(3) = 3 \times 32,000 \text{ LSBs} = 3 \text{ vertical divisions}$

***Step() function associated with a trace***

Math3 = ch1 \* step (t - divh(4))  
 CH1 red trace  
 Math3 blue trace

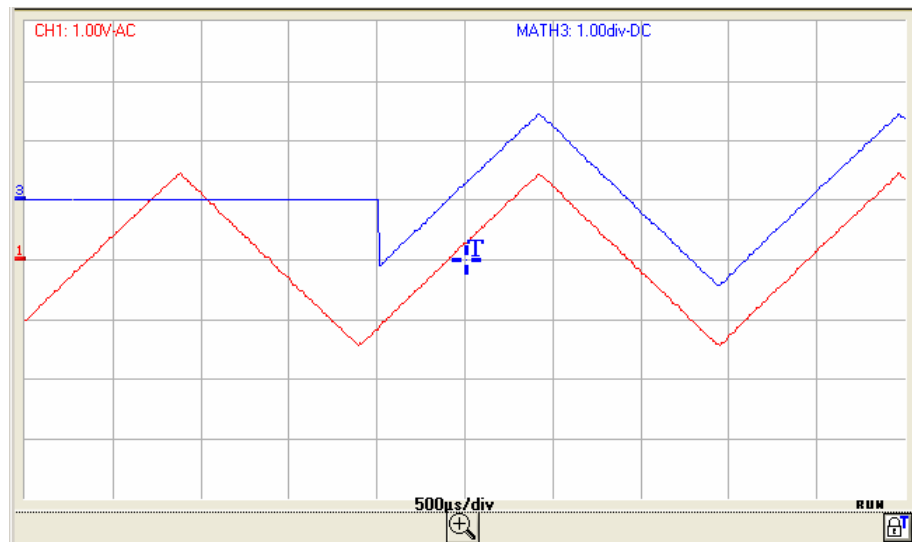

Math2 is at 0 vertical divisions as long as  $t$  (time) is less than four horizontal divisions.

Math3 is equal to CH1 when  $t$  (time) becomes greater than four horizontal divisions.

To facilitate signal observation, a vertical difference of 1 div. was introduced, acting on the vertical position of channels CH1 and Math3.

## "Oscilloscope" Instrument (contd.)

Math3 = ch1 \* step (divh(4) - t)

CH1 red trace

Math3 blue trace



Math3 is equal to CH1 as long as t (time) is less than four horizontal divisions.

Math3 is at 0 vertical divisions when t (time) becomes greater than four horizontal divisions.



## "Oscilloscope" Instrument (contd.)

Appropriate use of the operators for display optimisation

### Example 1

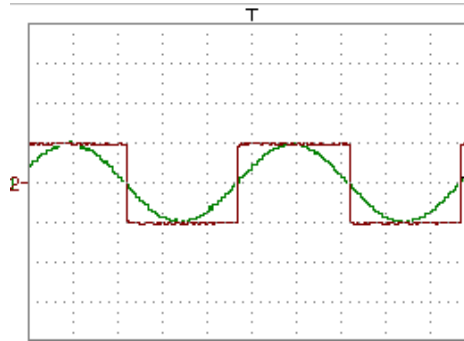

Vhigh ch1 = 1 vertical division => 1 x 32,000 LSBs = 32,000 LSBs  
 Vhigh ch2 = 1 vertical division => 1 x 32,000 LSBs = 32,000 LSBs

**Multiplication of two traces** math3 = ch1 \* ch2

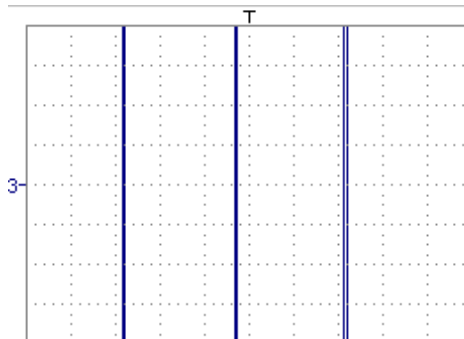

A considerable high and low overrun is noted.

Vhigh math3 = ch1 x ch2 = 1 vertical division x 1 vertical division  
 = 32,000 LSBs x 32,000 LSBs = 1024 10<sup>6</sup> LSBs  
 > (4 vertical divisions = 128,000 LSBs)

The function divv (vertical division) is necessary to optimise the display.

$$\text{math3} = (\text{ch1} * \text{ch2}) / \text{divv}(1)$$

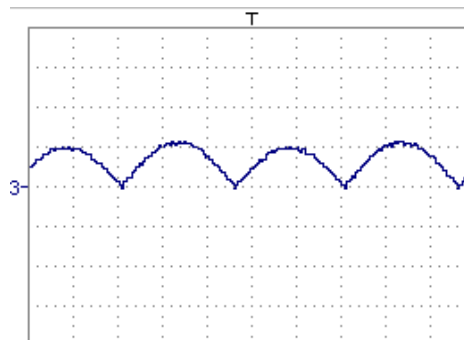

Divv(1) can be used to divide by 32,000 (1 vertical division = 32,000 LSBs): the result of the multiplication is translated into divisions on the screen.

☞ If Vpp of ch1 and ch2 had been 8 vertical divisions, the multiplication would have had to be divided by divv(4).

☞ When mathematical functions associated with traces are used, the dynamics of the result obtained must be verified.

Correction of the result of the operations by mathematical functions (divv(), divvh(), / ...) is recommended to optimize the screen display.

## "Oscilloscope" Instrument (contd.)

For immediate interpretation of the results, configure the vertical parameters of Math3.

In our example:

- The multiplication of CH1 by CH2 involves the multiplication of volts by volts, so the result is in square volts. "div" of the measurement unit of math3 can be replaced by  $V^2$  (square volts).
- A vertical division represents  $5\text{ V} \times 5\text{ V} = 25\text{ V}^2$  (vertical sensitivity of CH1 x vertical sensitivity of CH2). The coefficient of Math3 can be replaced by 25 to obtain the result of the automatic math3 measurements immediately.
- Then select math3 as the reference for the automatic and manual measurements (see "MEASUREMENT" menu).
- Then display the table of the 19 automatic measurements obtained on the math3 trace (see "MEASUREMENT" menu):

- MTX1054B - 1: Auto. measurem...			
Vmin =	-1.123 V	Trise=	28.50 $\mu$ s
Vmax =	1.193 V	Tfall=	28.39 $\mu$ s
Vpp =	2.316 V	W+ =	50.06 $\mu$ s
Vlow =	-1.091 V	W- =	49.93 $\mu$ s
Vhigh=	1.143 V	P =	100.0 $\mu$ s
Vamp =	2.234 V	F =	9.998kHz
Vrms =	800.6mV	DC =	50.0%
Vavg =	31.83mV	N =	4
Over+=	2.0%	Over=	1.0%
Sum =	15.20 $\mu$ Vs		

- The measurements displayed are the result of the multiplication of the two CH1 and CH2 traces in the right unit ( $V^2$ ).

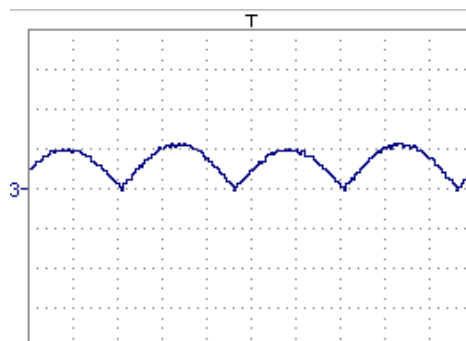

Math3 vertical scale =  $25\text{ V}^2$   
 Vpp math3 =  $25\text{ V}^2$

## "Oscilloscope" Instrument (contd.)

### Association of functions

#### **Generation of a sine wave using the sin() function**

Math3 = divv(3) \* sin (2 \* pi \* t / 10 000) blue colour trace.

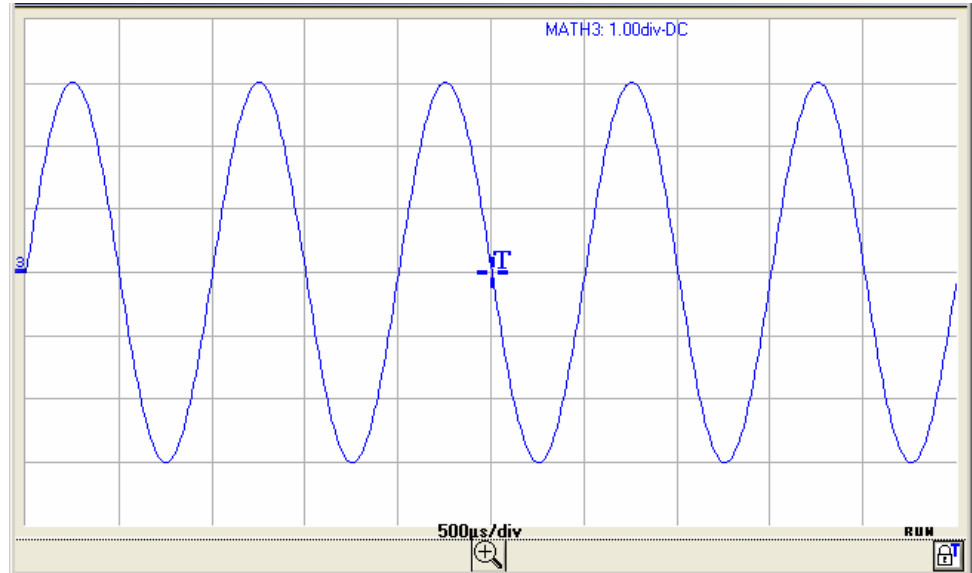

The trace obtained is a sine wave produced using the sin (sine) function, according to its mathematical definition ( $2 \times \pi \times \text{Frequency}$ ). The amplitude is 6 divisions ( $\text{divv}(3) \times 2 = 3 \times 32,000 \text{ LSBs} \times 2$ ). The period equal to 10,000 samples (2 horizontal divisions) depends on the time base.

The same trace can be obtained using the **divh()** function:

$$\text{Math3} = \text{divv}(3) * \sin (2 * \pi * t / \text{divh}(2))$$

In this example,  $\text{divh}(2)$  is equivalent to 10,000 samples.

*Note: 1 horizontal division = 5,000 samples*

The value in seconds of the period  $T = \text{divh}(2)$  equal to 10,000 samples (2 horizontal divisions) depends on the time base calibre (in s/div.)

## "Oscilloscope" Instrument (contd.)

### Generation of a sine wave by the cos() function

Sine wave trace by the cos (cosine) function

Math3 = divv(3) \* cos (2 \* pi \* t / divh(2)) blue colour trace

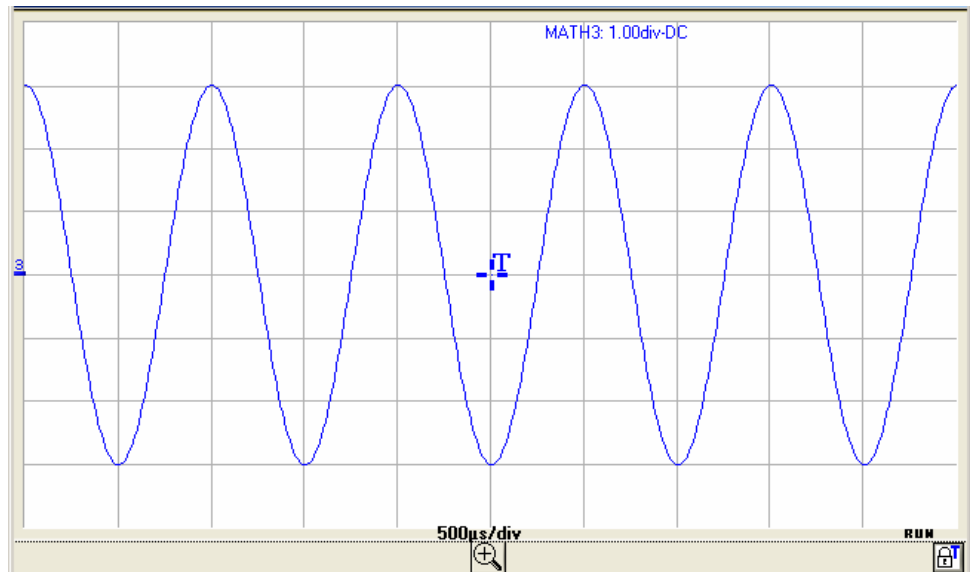

☞ The trace obtained with the cos() function is dephased by 90° in relation to the one obtained with the sin() function..

If the sine function is programmed on CH2 and the cosine function on CH3 and the dephasing between the 2 channels is measured, we can check this result:

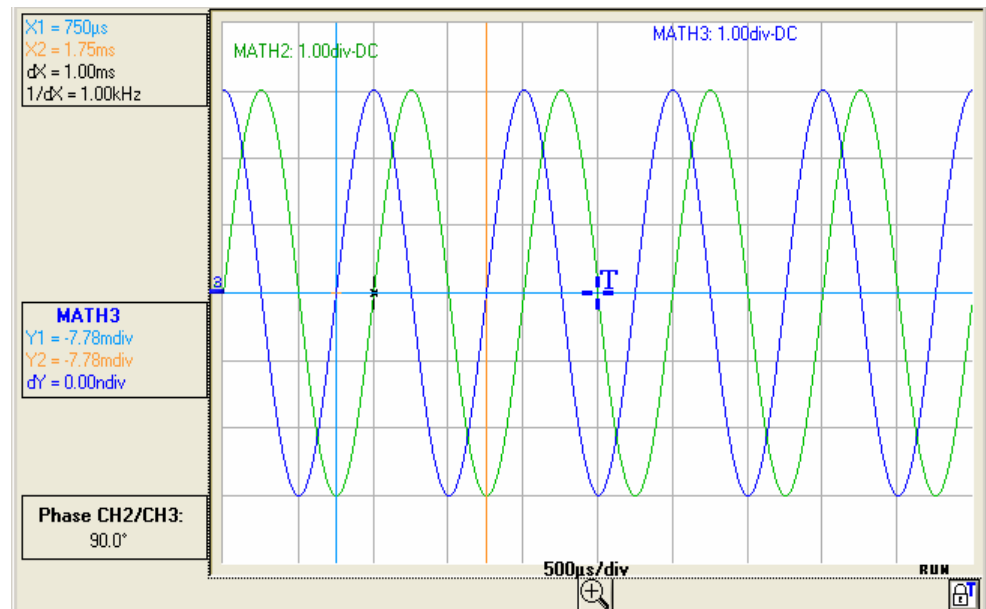

## "Oscilloscope" Instrument (contd.)

The XY representation of these 2 traces will give a circle:

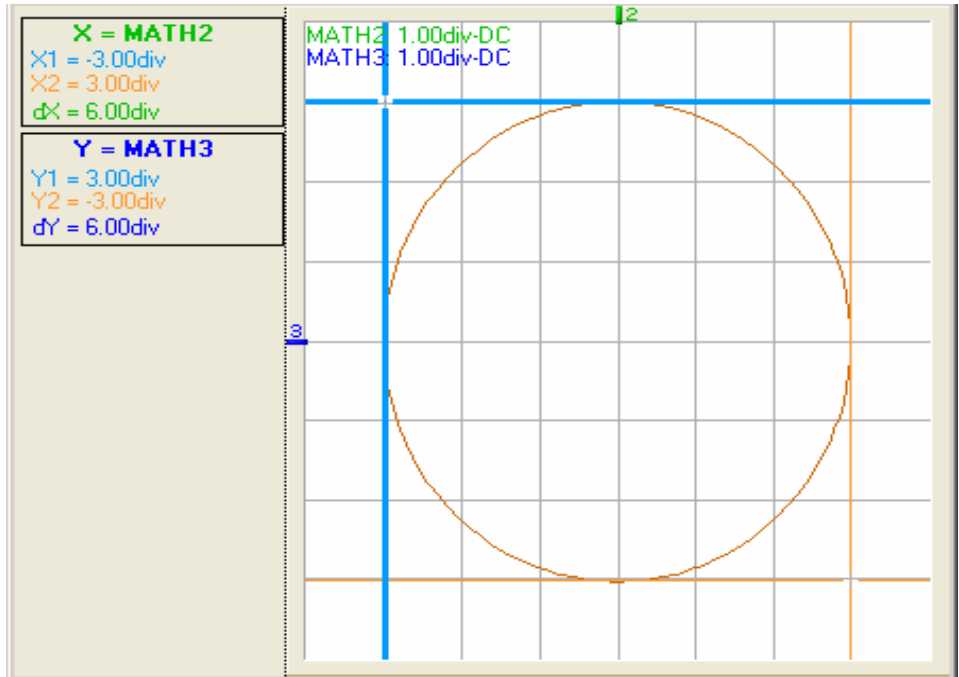

**Generation of a damped sine wave** Math3 =  $\sin(\pi * t / \text{divh}(1)) * \exp(-t / \text{divh}(6)) * \text{divv}(4)$  blue colour trace

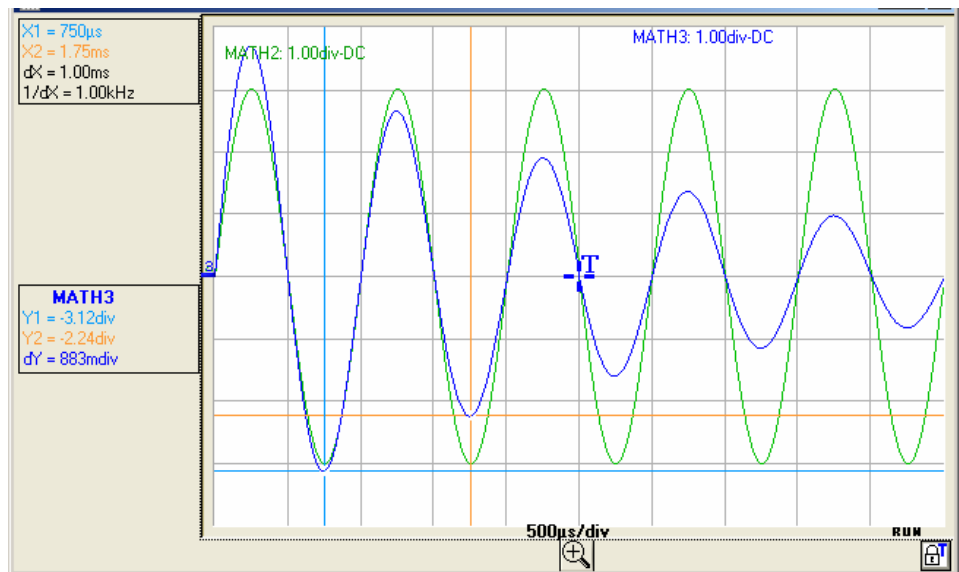

$\sin(\pi * t / \text{divh}(1))$  defines the number of periods on the screen.  
 $\exp(-t / \text{divh}(6))$  defines the damping level.

Note:  $\exp(-t)$  is equal to:  
 $\exp(-5000)$  when you reach the first horizontal division.  
 $\exp(-50,000)$  when you reach the tenth horizontal division.

## "Oscilloscope" Instrument (contd.)

In this case, the XY representation of the Math2 and Math3 traces gives:

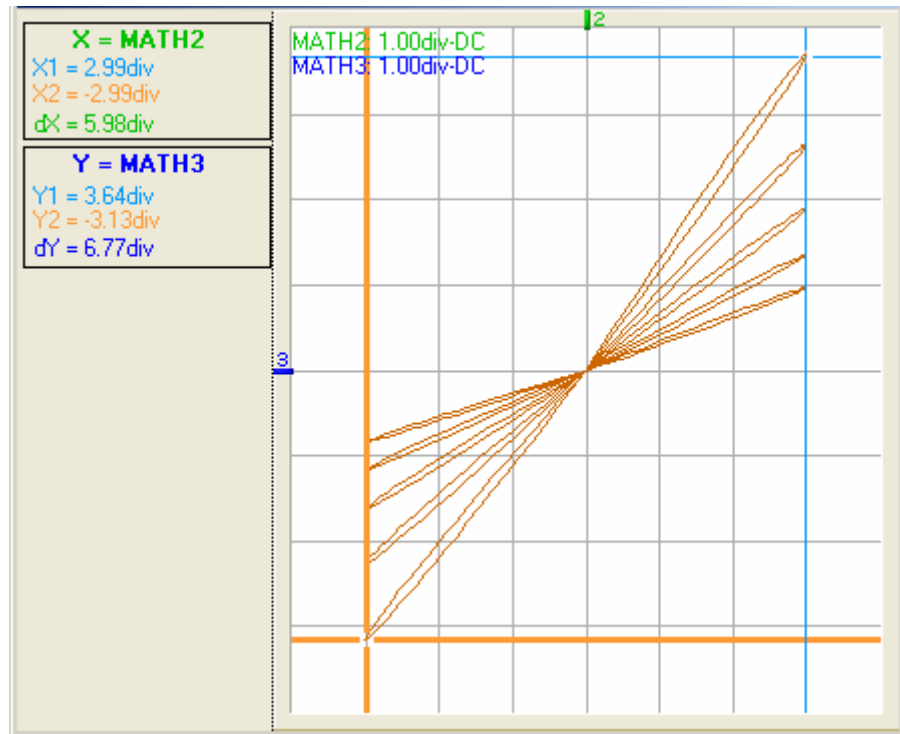

## "Oscilloscope" Instrument (contd.)

### The "Horizontal" menu

programmes:

- the repetitive signal
- Min/Max Acquisition
- average rate

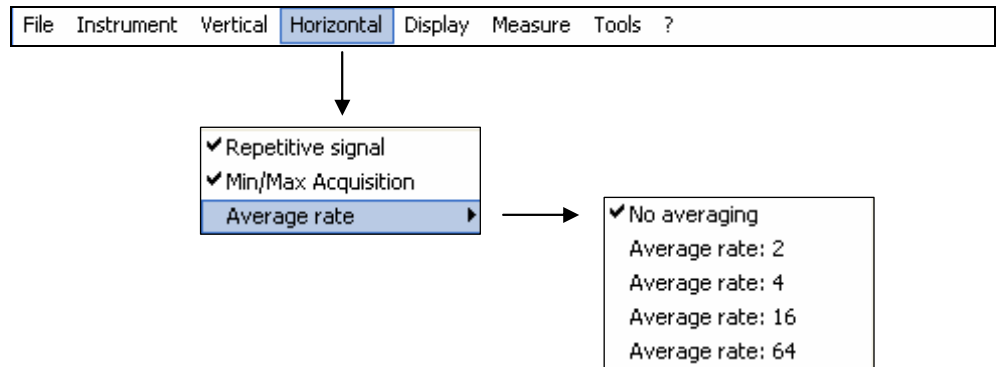

### Repetitive signal

The "✓" symbol indicates that the "Repetitive Signal" option has been selected.

☞ *Activation of this option increases the time definition of a trace (up to 100 Gs/s) for a repetitive signal.*

For time bases of less than 50  $\mu\text{s}/\text{div.}$  (zoom mode not active), the repetitive signal displayed is reconstituted by adding together successive acquisitions.

✎ *Example Measurement on a microprocessor timing clock.*

☞ *If the signal is not repetitive, do not use this option as the aggregate representation could be incorrect.*

*If Repetitive Signal mode is not selected, the time resolution will be 10 ns (or 5 ns, if only one channel is active in single stroke). In this mode, all the counts displayed are updated with each acquisition.*

*To indicate that repetitive signal mode is not selected, the "Non repetitive Signal" message is displayed at the top of the window:*



### Min/Max Acquisition

allows the signal to be sampled at high frequency (100 MS/s), even for slow time base speeds. The display represents extreme value samples, the Min and Max.

It is possible:

- to detect incorrect representation due to under-sampling
- to display short-term events (Glitch, > 10 ns).

Whatever time base is used, short-term events (Glitch, > 10 ns) are displayed.

☞ *The "✓" symbol indicates that the "Min/Max Acquisition" mode is active.*

## "Oscilloscope" Instrument (contd.)

### Average rate

**No averaging**  
**Average rate: 2**  
**Average rate: 4**  
**Average rate: 16**  
**Average: rate 64**

Selection of a rate to calculate an average for the displayed samples.

 Example: attenuation of the random noise observed on a signal.

The averaging rates are:   no averaging or  
   average rate: 2  
   average rate: 4  
   average rate: 16  
   average rate: 64

The calculation is performed using the following formula:

$$\text{Pixel}_N = \text{Sample} * 1 / \text{Average rate} + \text{Pixel}_{N-1} (1 - 1 / \text{Average rate})$$

with:

Sample       Value of new sample acquired at abscissa t

Pixel N       Ordinate of pixel with abscissa t on the screen, at moment N

Pixel N-1     Ordinate of pixel with abscissa t on the screen, at moment N-1

 *It is only possible to obtain the average rate if the Repetitive Signal option is activated.*



---

## "Oscilloscope" Instrument (contd.)

---

### The "Display" menu

sets the parameters for the following displays:

- Grid
- Vertical unit
- Vector
- Envelope
- Persistence

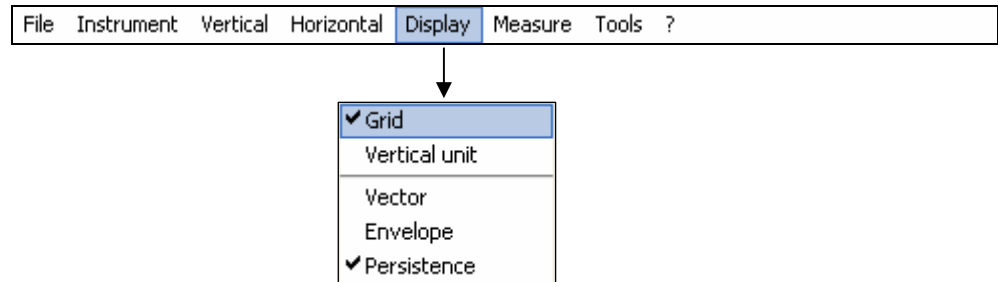

---

### Grid

Display with or without grid lines

---

### Vertical unit

Display in the Oscilloscope Trace  
FFT Trace and  
XY Trace windows  
of the vertical unit,  
the input coupling and  
the BWL selection of each active channel.

---

### Vector

A vector is traced at the centre of the sample.

---

### Envelope

The minimum and maximum observed on each horizontal position of the screen are displayed. This mode is used to display drifting in time or modulation.

---

### Persistence

Signal display persistence.



**The "✓" symbol indicates the active display mode.**

## "Oscilloscope" Instrument (contd.)

### The "Measurement" menu

selects the Reference Trace for:

- automatic measurement
- phase measurement (automatic or manual)
- measurement with a manual cursor

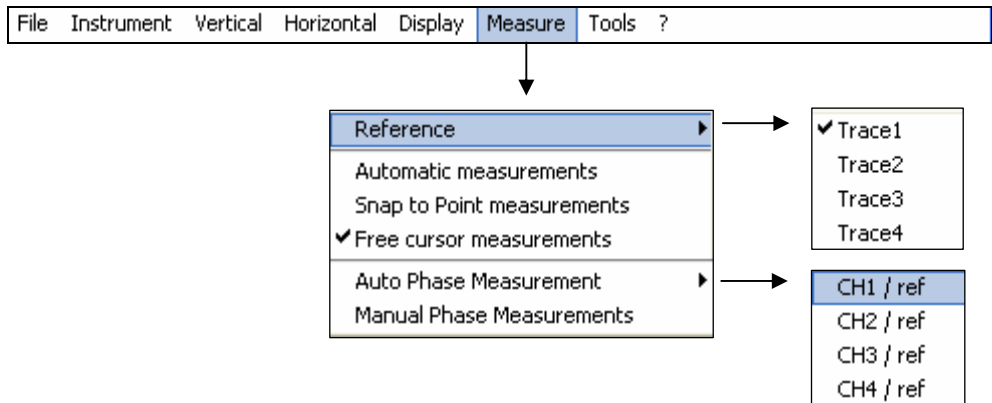

### Reference

Trace 1  
Trace 2  
Trace 3  
Trace 4

Selecting one of the active traces for which automatic or manual measurements are to be made.

*Only active traces can be selected. Inactive traces are shown greyed out.*

*The "✓" symbol indicates the reference trace selected.*

*The measurement reference "Ref: Trace 1, 2, 3, 4" can also be selected from the toolbar.*

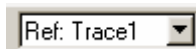

### Automatic measurements

Opens the Automatic measurements window.

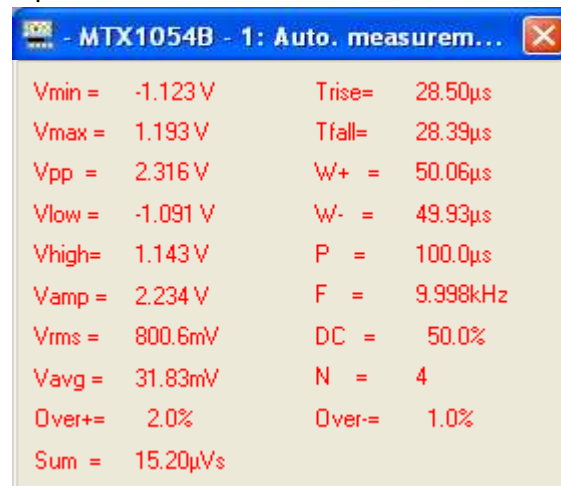

The 19 automatic measurements are made on the reference trace selected. All the measurements that can be performed on this trace are displayed and refreshed.

(- - -) is displayed for measurements that cannot be performed.

The window is closed by clicking on the **x icon**.

## "Oscilloscope" Instrument (contd.)

---



Activation of automatic measurement does not display the cursors in the trace display window. For measurements on periodic signals, choose the time base coefficient so that at least 2 signal periods are displayed on the screen.

### 19 automatic measurements

<b>Vmin</b>	minimum peak voltage
<b>Vmax</b>	maximum peak voltage
<b>Vpp</b>	peak-to-peak voltage
<b>Vlow</b>	established low voltage
<b>Vhigh</b>	established high voltage
<b>Vamp</b>	amplitude
<b>Vrms</b>	rms voltage
<b>Vavg</b>	average voltage
<b>Over+</b>	positive overshoot
<b>Tm</b>	rise time
<b>Td</b>	fall time
<b>W+</b>	positive pulse width (at 50 % of Vamp)
<b>W-</b>	negative pulse width (at 50 % of Vamp)
<b>P</b>	period
<b>F</b>	frequency
<b>DC</b>	cyclic ratio
<b>N</b>	number of pulses
<b>Over-</b>	negative overshoot
<b>Sum</b>	sum of elementary areas (= integral)

### Measurement conditions

- The measurements are made on the displayed part of the trace.
- Any change to the signal will lead to updating of the measurements. They are refreshed in step with acquisition.
- For greater accuracy of the measurements displayed:
  1. represent at least two complete periods for the signal
  2. choose the calibre and vertical position so that the peak-to-peak amplitude of the signal to be measured is represented on 4 to 7 divisions of the screen.

## "Oscilloscope" Instrument (contd.)

*Automatic  
measurement  
presentation*

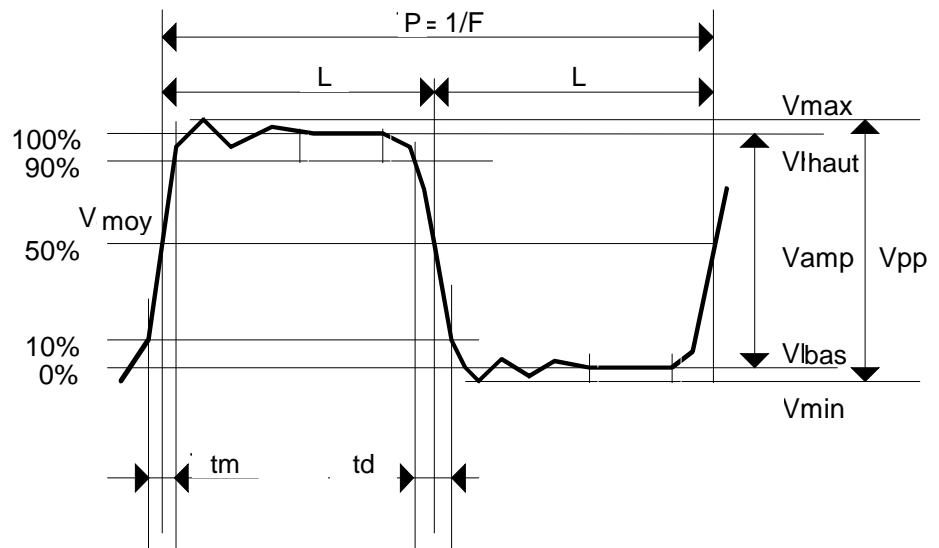

- Positive overshoot =  $[100 * (V_{max} - V_{high})] / V_{amp}$
- Negative overshoot =  $[100 * (V_{min} - V_{low})] / V_{amp}$

- $V_{rms} = \left[ \frac{1}{n} \sum_{i=0}^{i=n} (y_i - y_{GND})^2 \right]^{1/2}$

- $V_{avg} = \frac{1}{n} \sum_{i=0}^{i=n} (y_i - y_{GND})$

$Y_{GND}$  = value of the point representing zero Volts

## "Oscilloscope" Instrument (contd.)

### Snap to point measurements

#### Cursor measurements

The blue and yellow measurement cursors are displayed as soon as the menu is activated.

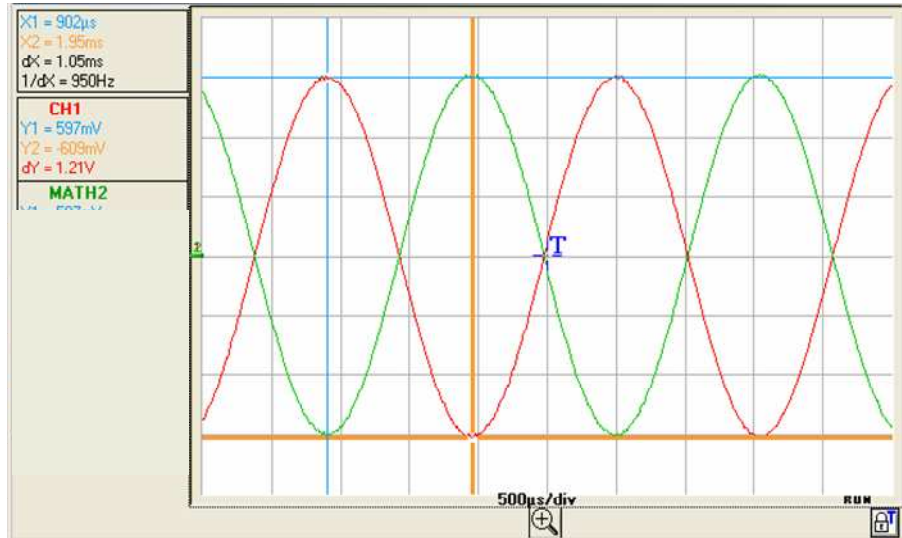

The two measurements made are:

**dX = dt** (time deviation between the two cursors)

**dY = dv** (voltage deviation between the two cursors).

The measurements performed and the cursors are linked to the selected reference trace (see §. Reference).

- The "✓" symbol indicates that the snap to point measurements (dt, dv) are active.
- The measurement cursors can be moved directly with the mouse.
- The dt and dv measurements in relation to the selected reference are indicated in the measurement display area.

✎ Example: (1)dt = dX = 1.05 ms, dv = dY = 1.21V

## "Oscilloscope" Instrument (contd.)

### Free cursor measurements

to link/unlink the (blue and yellow) manual measurement cursors to/from the reference trace.

When the "free cursor measurements" menu is selected, the blue and yellow cursors can be moved freely over the whole screen.

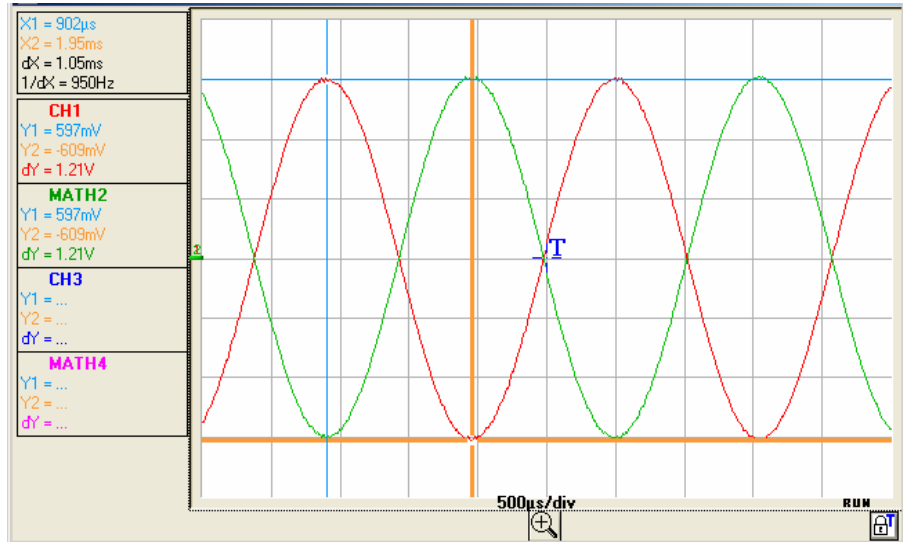

- The "✓" symbol indicates that the "Free cursor measurements" menu is active.
- To deactivate this menu, de-select it with the mouse.

## "Oscilloscope" Instrument (contd.)

### Auto Phase Measurement

Measurement of a trace phase compared with a reference trace (See §. Reference).

- CH1 / ref
- CH2 / ref
- CH3 / ref
- CH4 / ref

Selecting of the trace on which phase measurements are to be performed.  
To deactivate phase measurement, deselect the selected phase measurement.

Automatic phase measurement:

- The "✓" symbol indicates the trace selected for phase measurement.
- Activation of phase measurement displays 3 cursors:  
2 automatic measurement cursors on the reference trace indicate the signal period (blue and yellow cursors).  
A black cursor is positioned on the trace where phase measurement is to be carried out (CH2 in our example).

These 3 cursors are automatically placed on the reference and measurement traces; they cannot be moved.

- The phase measurement (in °) of the trace selected (CH2) compared with the reference trace (CH1) is indicated in the measurement display zone (Example: CH2/CH1 phase = 181.7°).

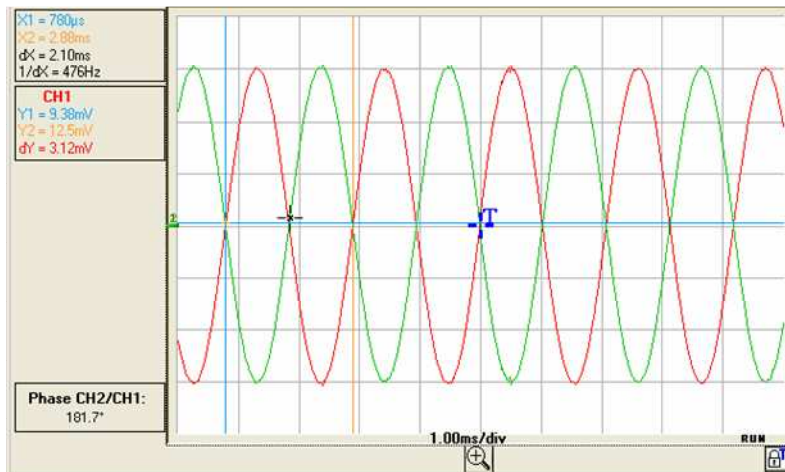

If the measurement cannot be performed, " - - - " is displayed. For example, if the time base chosen does not enable 2 complete signal periods to be represented:

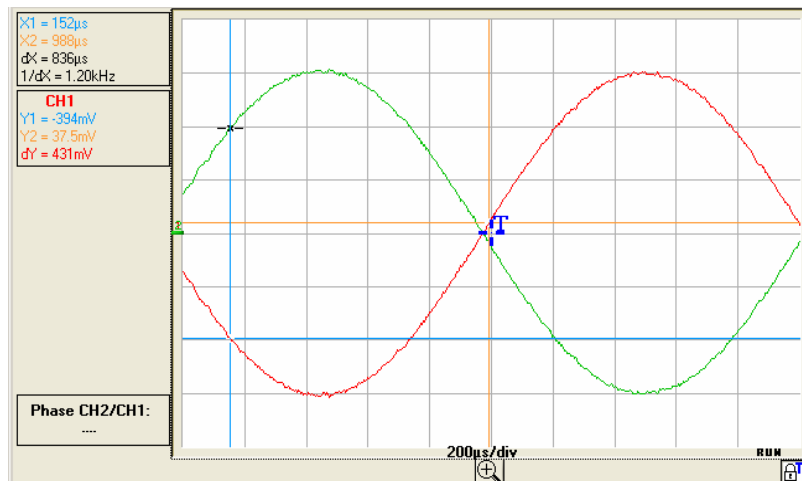

## "Oscilloscope" Instrument (contd.)

### Manual phase measurements

If manual phase measurements is selected:

The three cursors are unattached and can be placed anywhere in the trace display window:

The **blue** and **yellow** cursors determine the reference period for calculation of the phase and the dephasing value displayed depends on the position of the **black** cursor in relation to these 2 cursors.

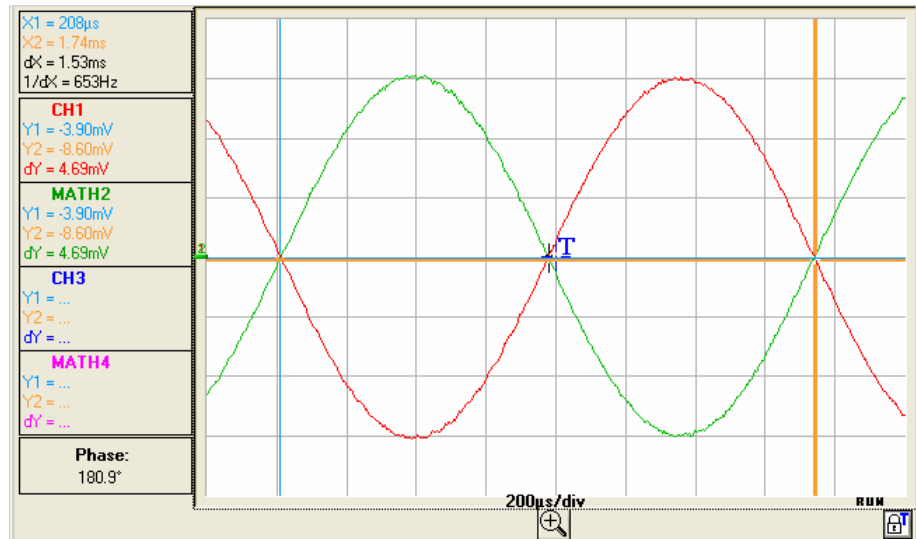

☞ For manual measurement of the phase, a signal on the screen is all that is needed.



## "Oscilloscope" Instrument (contd.)

The "Tools" menu allows the following functions to be carried out:

- network settings
- printing
- export to Excel
- choice of language
- system info display
- software updating

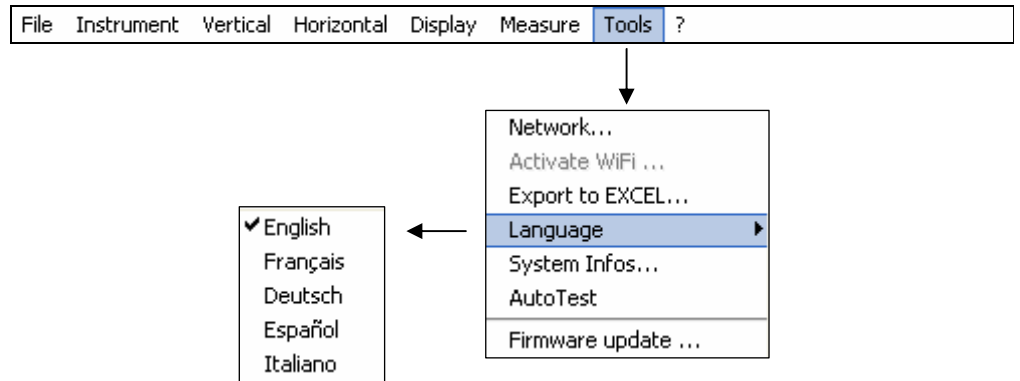

### Network...

configures the oscilloscope Ethernet link :

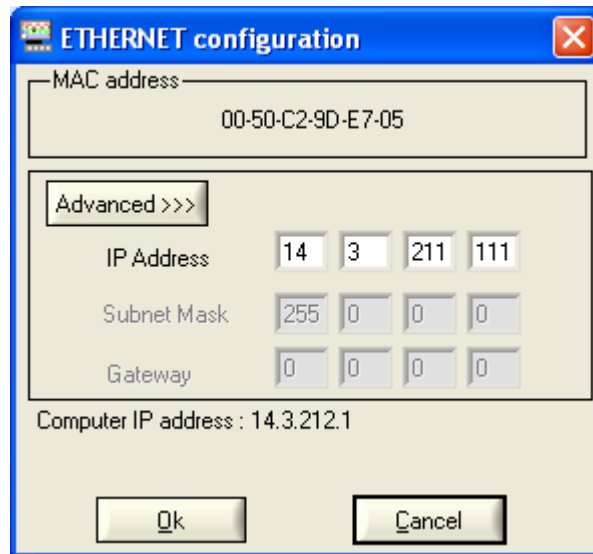

**MAC address** This is unique and cannot be modified by the user. It identifies the instrument on the network.



**IP address** The user may keep the default IP address or enter a new one via the keyboard.

**Subnet mask** Input of the network mask

**Gateway** Programming of the gateway IP address (if a gateway is used)

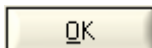

Validation of the new configuration settings.

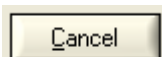

Exit without validation

## "Oscilloscope" Instrument (contd.)

### Programming the WiFi connection

Only the MTX 105xXW versions have the wireless communication option: WiFi.

This WiFi function is compatible with the IEEE 802.11b and g wireless communications standards, and for security it is compatible with the 802.11i Encryption standard.

The MTX 105xXW can be used in one of the network topologies described by this standard:

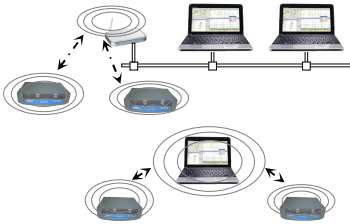

- the **infrastructure** topology, in which wireless clients are connected to an access point that permits the interconnection of this wireless network to a cabled network.
- the **Ad Hoc** topology, in which the clients are connected to each other without any access points. This mode makes it possible, for example, to connect one or more oscilloscopes directly to a PC.

It is strongly recommended that you protect your network using a data encryption and authentication mechanism, the MTX 105xXW manages the **WEP** (64 and 128 bits), **WPA** and **WPA2** security modes. The latter two are to be privileged in terms of security.

However, **when in Ad Hoc mode, only WEP security is supported.**

The MTX 105xXW operates in roaming mode. It is therefore capable, in an adapted network, (that has several access points with the same network name (SSID) and the same security characteristics), of automatically switching to the access point that has the greatest transmission power.

***The WiFi settings cannot be changed if the device is using this communication method. It is therefore necessary to return to a cable connection first (USB or Ethernet).***

If the oscilloscope is currently in WiFi mode it can be connected using the 'Tools' menu:

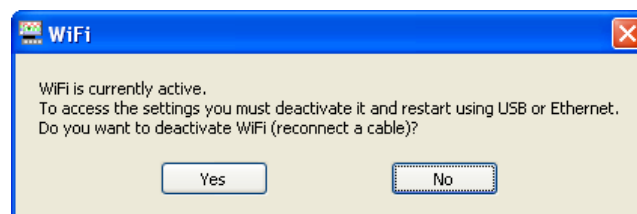
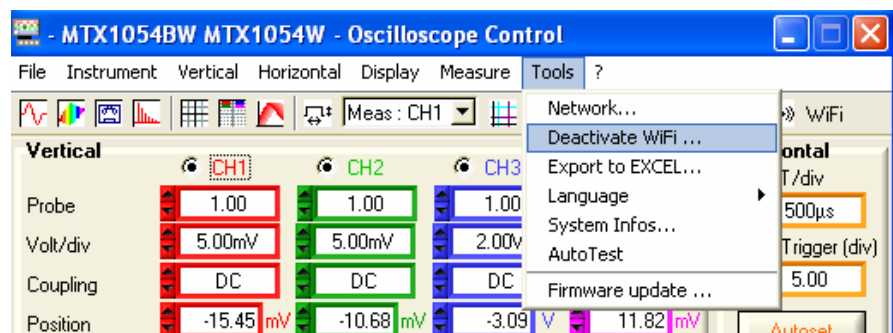

To continue, connect one of the communication cables to your oscilloscope and click on  to start a new connection.

## "Oscilloscope" Instrument (contd.)

### Programming the WiFi connection (continued)

Programming can also be carried out from the 'Tools → Activate WiFi ...' menu in the 'Oscilloscope Control' window (this menu is greyed out for instruments that are not equipped with the WiFi function).

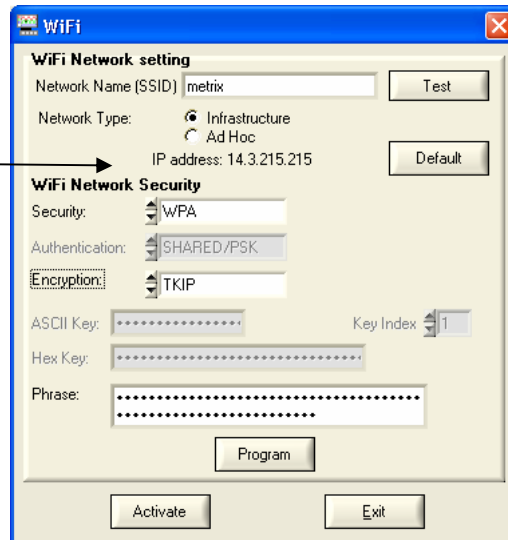
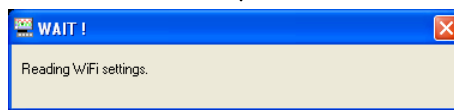
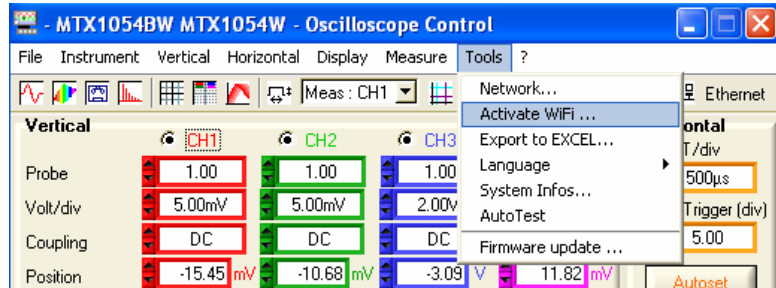

Current instrument Ethernet address

To program the WiFi settings, refer to your wireless access point documentation and copy its programming on the MTX 105xXW.

⚠ *The password cannot be re-read; it is only reprogrammed if the 'ASCII Key', 'Hex Key' or 'Phrase' fields are changed.*



used to test the reception level of the access point of which the SSID was entered in the 'Network Name' field. It shows the following window:

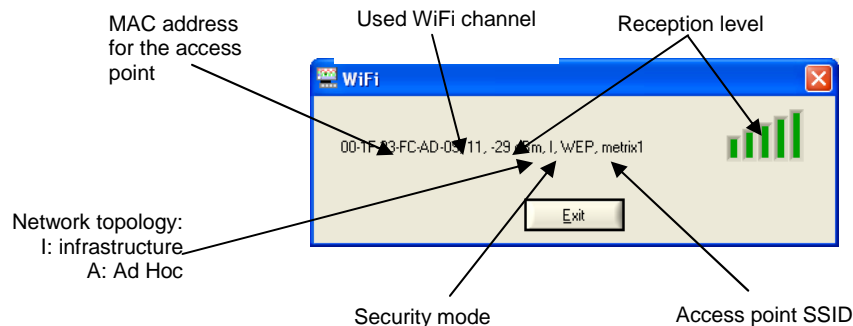

## "Oscilloscope" Instrument (contd.)

### Programming the WiFi connection (cont.)

- Default** Display of the "factory" settings with in order to completely reprogramme the oscilloscope. The default configuration is an Ad-Hoc non secured connection with the MTX 105xXW SSID.
- Program** This key is only accessible if one of the WiFi settings is changed; it sends the values entered to the oscilloscope to be memorised. Only the modified fields are programmed.
- Activate** Launch of a new WiFi connection with the current settings (last values memorised by pressing **Program** ).  
If some settings are changed but not programmed the following message is displayed:

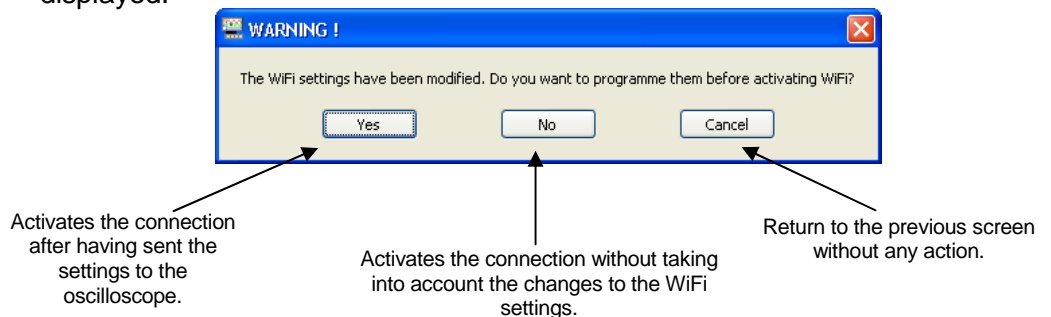

- Exit** closes the window.

### Starting a WiFi connection

The WiFi connection starts in several ways:

#### When powering on:

- if the instrument was using WiFi mode when it was powered off, the oscilloscope will restart by attempting to establish the previous WiFi connection.
- if not, if no cables (USB or Ethernet) are connected to the instrument, a search for a WiFi connection is begun using the current settings.

#### Cable operation (USB or Ethernet):

- if no WiFi is already operational, from the 'Tools → Activate WiFi...' menu in the 'Oscilloscope Control' window.

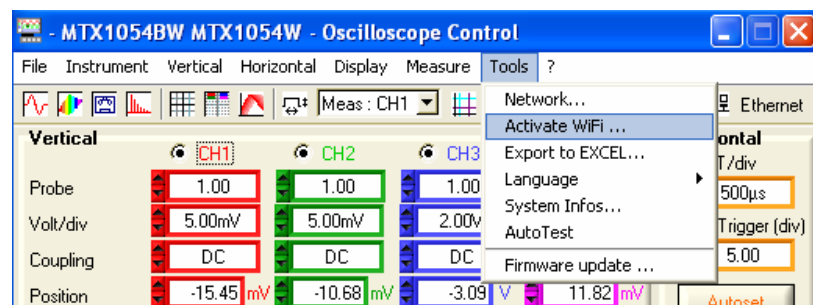

- Then in the WiFi' window (see above), click on **Activate**. A new WiFi session opens automatically if the connection is correctly established.
- if a WiFi connection is already established (the 'Tools → Deactivate WiFi...' menu is displayed), by closing the application and opening a new connection from the 'Start of an Oscilloscope' window.

## "Oscilloscope" Instrument (contd.)

### Starting a WiFi connection (continued)

The search for a WiFi network is visible on the front face of the instrument; the "READY" LED will blink for rapid salvos of 40 blinks.

A maximum of 10 salvos are shown; if the "READY" LED is permanently lit before the 10 salvos, the connection is established, otherwise the search for an Ethernet cable connection is activated.

If successful the "WiFi" LED in the 'Start of an oscilloscope' window lights in red:



On the rear face of the instrument, the green and yellow LEDs for the RJ45 network are lit:

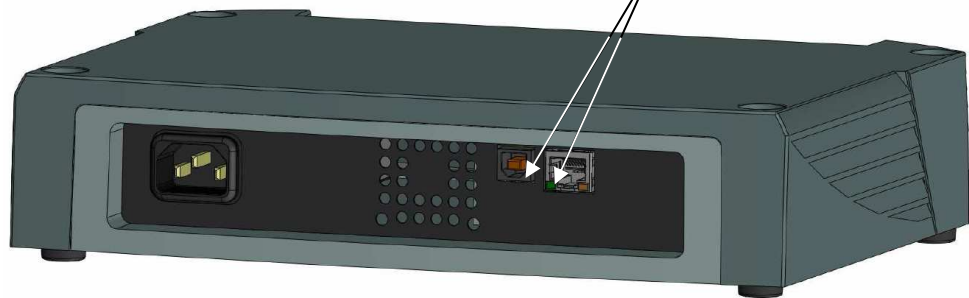

Select 'Ethernet WiFi' and click on  to start the instrument using WiFi.

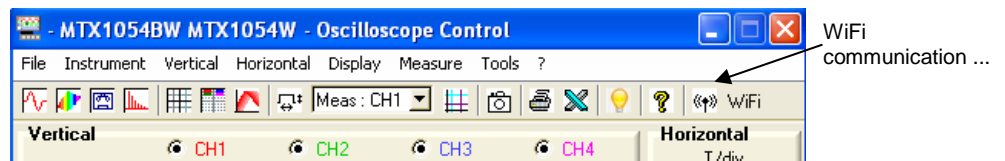

## "Oscilloscope" Instrument (contd.)

*Returning to an USB cable communication*

Two methods are possible:

Connect the USB cable between the device and the PC, then:

- to keep the WiFi connection:

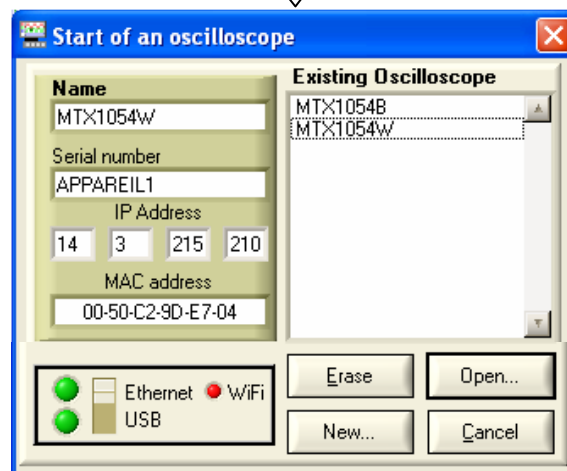
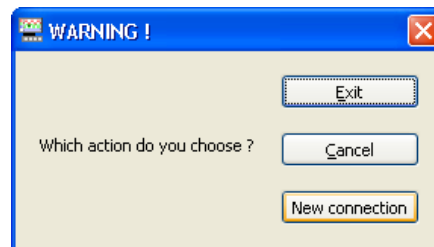
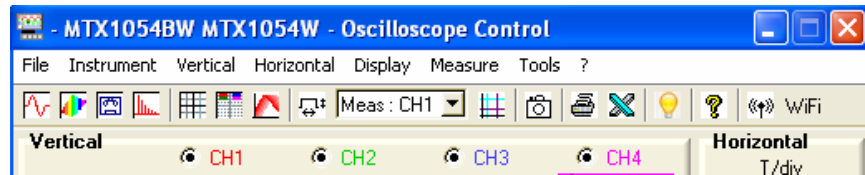

Select the USB and open the new connection.

- to abandon the WiFi connection:

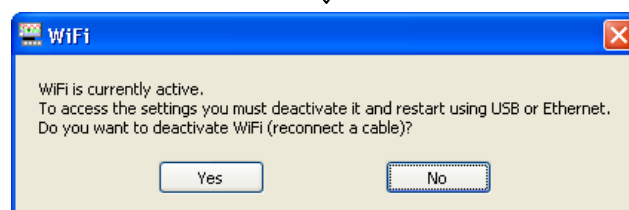
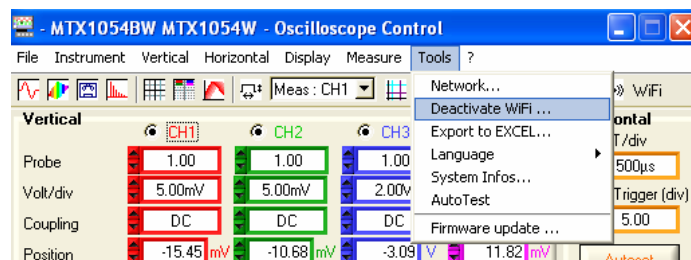

## "Oscilloscope" Instrument (contd.)

*Returning to a USB  
cable  
communication  
(continued)*

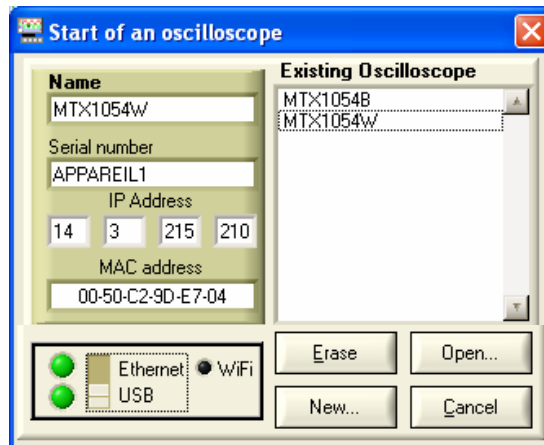

Select the USB and open the new connection.

Connect the Ethernet cable, then:

*Returning to  
an ETHERNET  
cable connection*

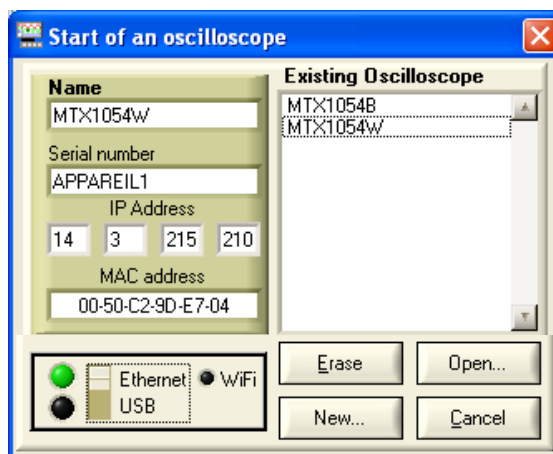
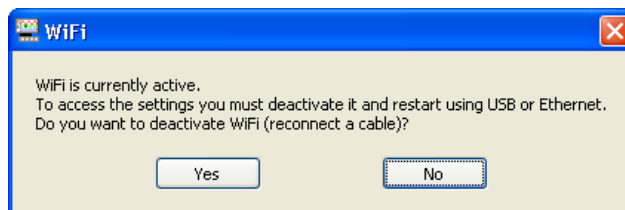
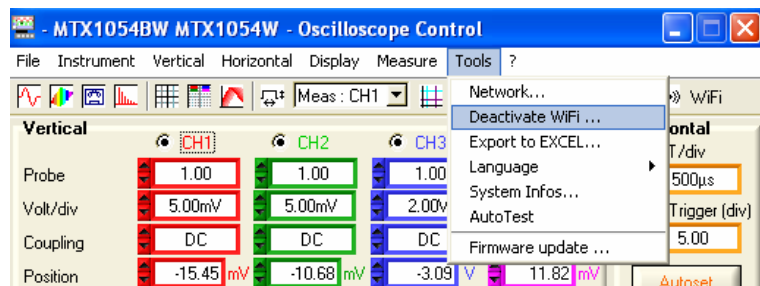

Select Ethernet and open the new connection.

---

## "Oscilloscope" Instrument (contd.)

---

### *Our recommendations*

If the WiFi connection is not operational in the 'Start of an oscilloscope' window:

- Make sure that the WiFi connection settings for your oscilloscope are identical to those programmed on your wireless access point.
- Use the  key in the WiFi programming window, to assess the reception level and, if needed, move your MTX 105xXW oscilloscope closer to your access point in order to check whether you have a range problem.
- Make sure (especially when switching from Ad Hoc / Infrastructure) that the oscilloscope's IP address is compatible with the rest of the equipment.
- For use in an Ad Hoc topology (PC + MTX 105xXW), it is imperative to establish the Ad Hoc connection on your PC before starting the network search on the oscilloscope (powering on the oscilloscope).



## "Oscilloscope" Instrument (contd.)

### Export to EXCEL...

- either by clicking on the  icon on the toolbar
- or via the menu "Tools → Export to EXCEL".

The following menu appears:

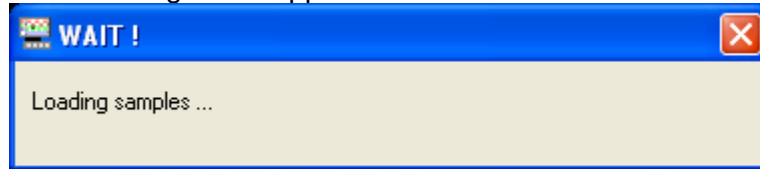



It indicates the transfer of 50,000 samples corresponding to each trace active at the time of the click.

Once the transfer is finished, the Capture Trace and Export to Excel windows are displayed.

 *Traces captured at the time of the click*



The memory zone to be exported corresponds to the one displayed in the black frame of the first trace, itself represented on the lower graph. It can be delimited using the Horizontal Zoom   and by moving the frame with the mouse or the buttons opposite.

The time necessary for an export to EXCEL depends on the number of samples to be exported.

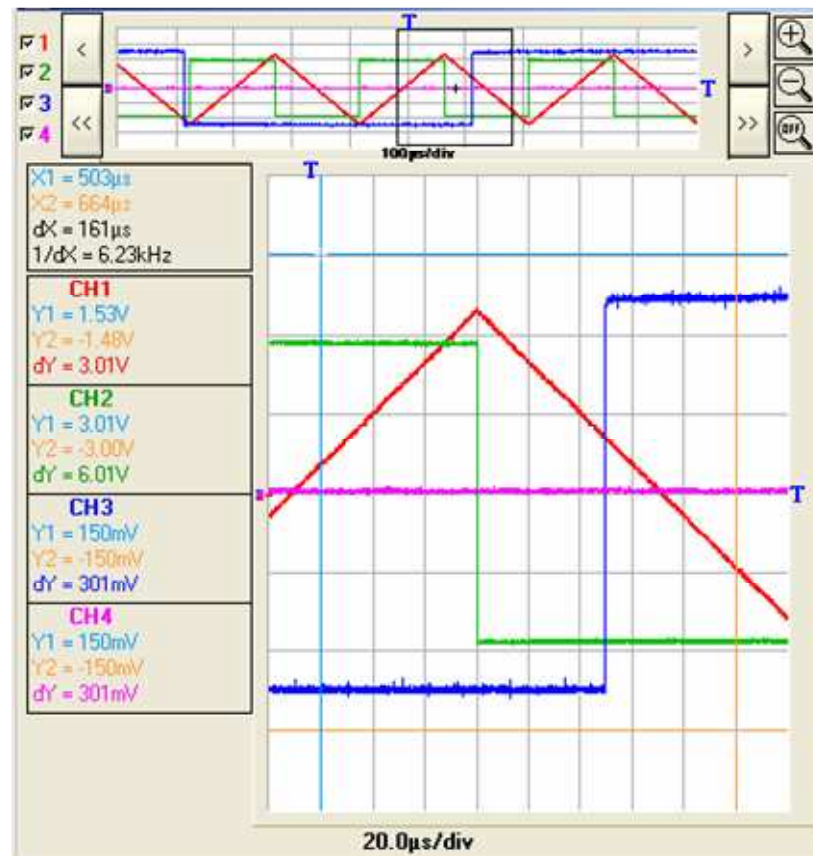

○

## "Oscilloscope" Instrument (contd.)

 *Export activation window*

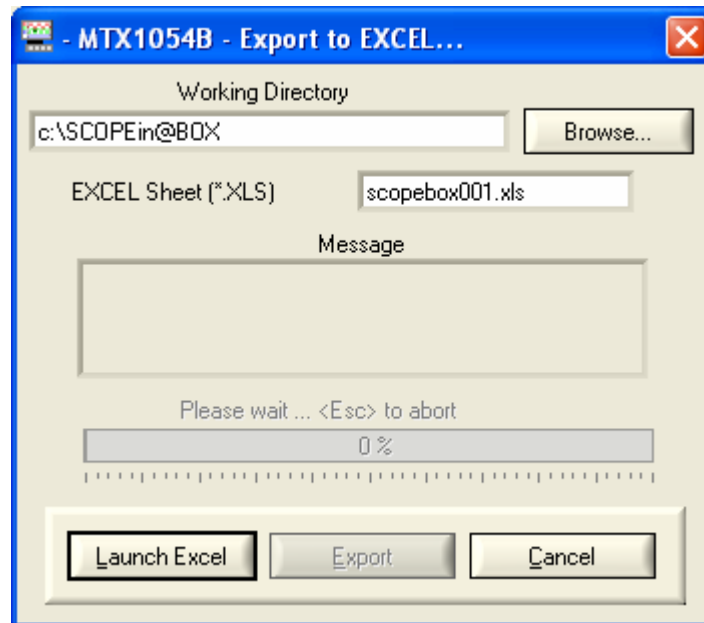

- Name the EXCEL spreadsheet (default name: scopebox001.xls).
- Choose the Working directory by clicking on "Browse"
- Click on Done.

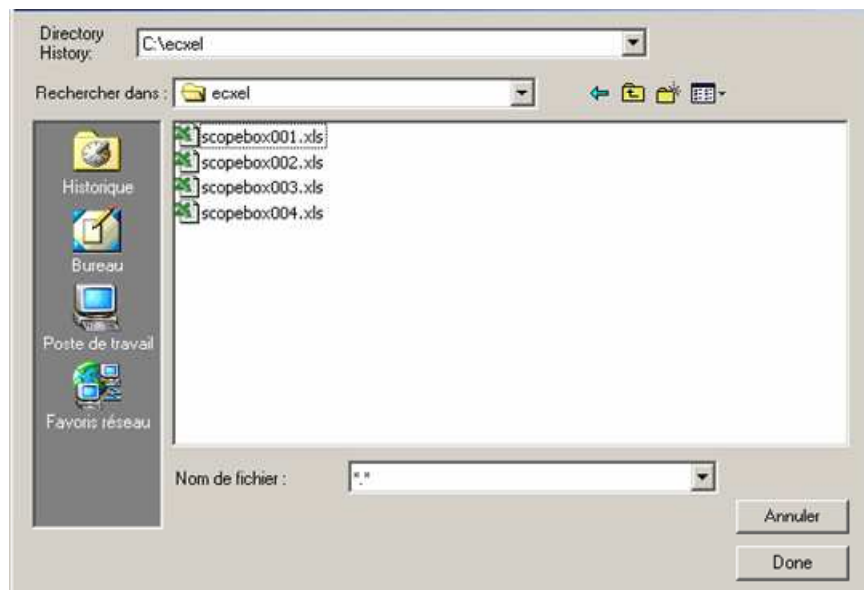

- Start Excel by clicking on the corresponding button.

## "Oscilloscope" Instrument (contd.)



- Start the export by clicking on Export.

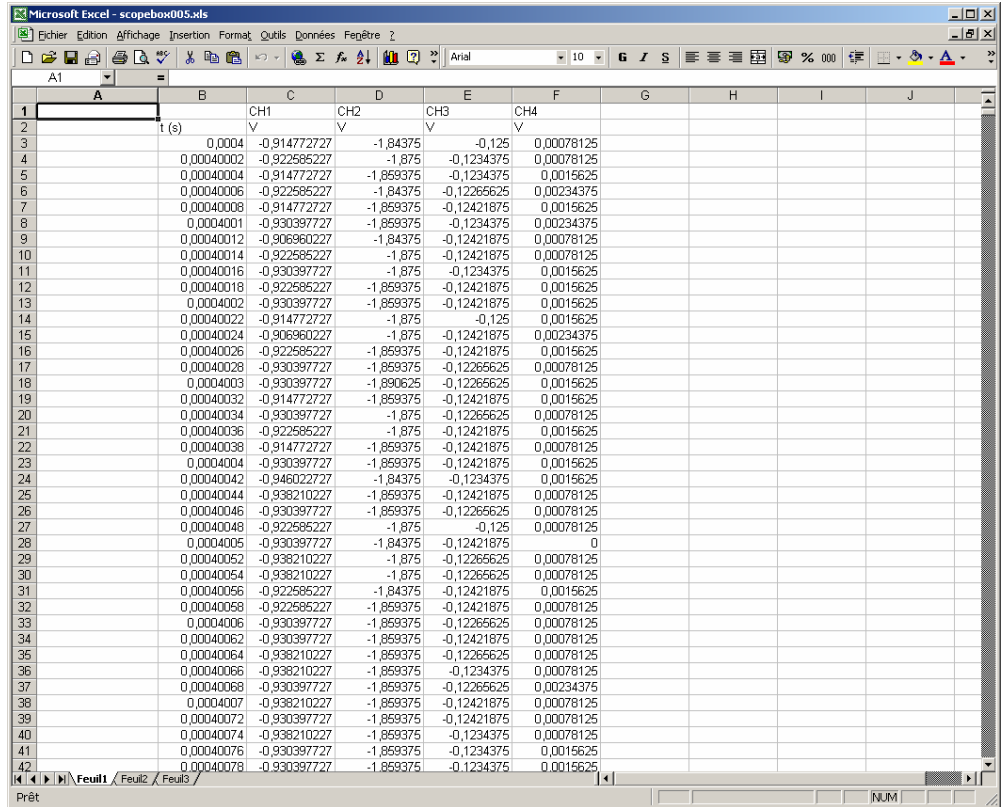

When the operation has finished the message Sheet Ready is displayed in the Message box.

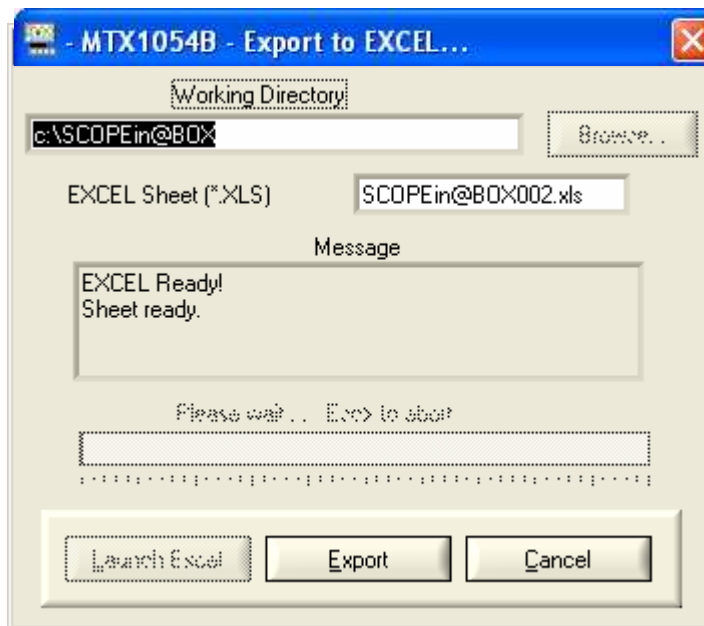

## "Oscilloscope" Instrument (contd.)

### Language

Selection of the language:

- English
- Français
- Deutsch
- Español
- Italiano

### System info ...

Display of data concerning the operation of the instrument since it was first used:

- the number of times switched on
- the number of hours of use

 *The instrument time is automatically set to that of the PC when a working session is set up. When a working session is closed, the instrument switches to low consumption mode, if not in recorder mode. It automatically switches to normal consumption when a new working session is set up.*

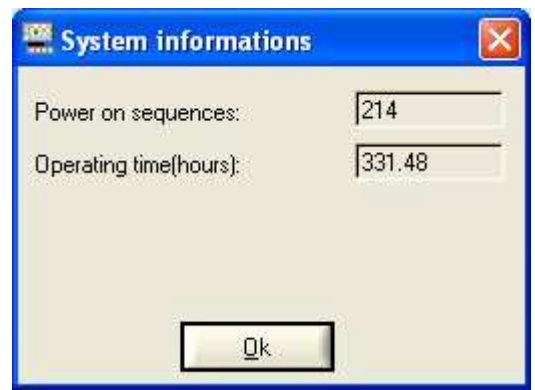

### Autotest

This function launches a series of internal tests in the oscilloscope. This process takes a few seconds and if a problem is detected, an error code is returned.

### Error messages

Autotest: Error n°0001: problem with Microprocessor or FLASH  
 Autotest: Error n°0002: RAM error  
 Autotest: Error n°0004: FPGA error  
 Autotest: Error n°0008: SSRAM error  
 Autotest: Error n°0010: SCALING 1 error  
 Autotest: Error n°0020: SCALING 2 error  
 Autotest: Error n°0040: SCALING 3 error  
**MTX1054**→ Autotest: Error n°0080: SCALING 4 error  
**MTX1054**→ Autotest: Error n°0100: acquisition problem – channel 1  
 Autotest: Error n°0200: acquisition problem – channel 2  
**MTX1054**→ Autotest: Error n°0400: acquisition problem – channel 3  
**MTX1054**→ Autotest: Error n°0800: acquisition problem – channel 4  
 Autotest: Error n°1000: Ethernet problem  
 Autotest: Error n°2000: Vernier problem

If one of these codes (or the addition of several codes) is present when getting started → a fault has been detected.

In this case, contact your closest distributor (see §. Maintenance p. 6).

## "Oscilloscope" Instrument (contd.)

### Upgrade firmware ...

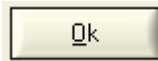
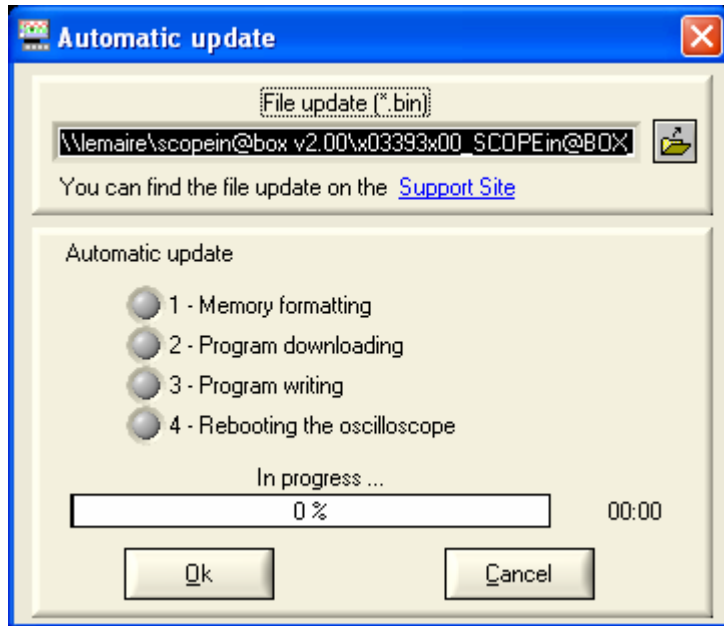

- Select the new version of the embedded software to be loaded.
- Click on the button opposite.

#### 4 steps

A red LED and bargraph indicate the progress of the update.

When the update is finished, the instrument restarts with the new embedded software.

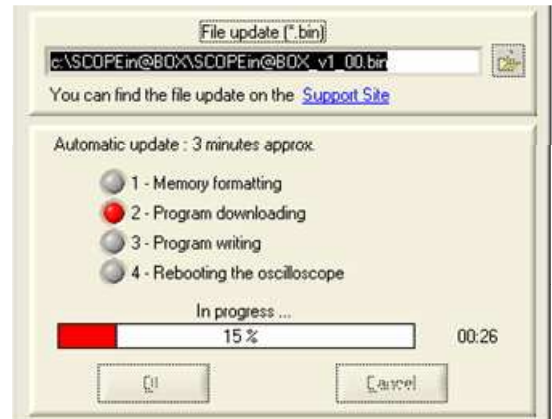

*If a problem occurs during the update (⚡: power cut during step 2), the following message is displayed:*

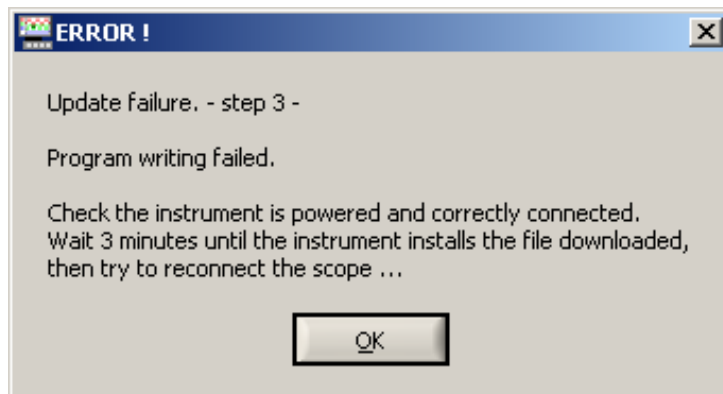

1. Check the instrument connection.
2. Check for the presence of the mains supply (the red LED on the back panel of the instrument should be lit)
3. Wait for 3 minutes (installation of the software in the memory).
4. Restart SCOPEin@Box program.

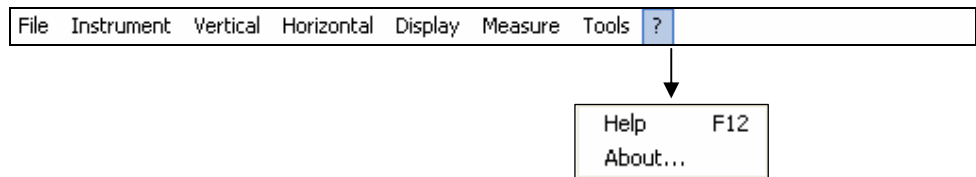

## "Oscilloscope" Instrument (contd.)

### The "?" Menu



### Help

opens the virtual oscilloscope user manual. The user can read the chapters of the manual with the oscilloscope still operative.

 This function can also be accessed by clicking on the  icon on the toolbar.

### About ...

opens the following window with:



- the PC software version: SCOPEin@BOX
- The embedded Firmware version:
  - the name of the instrument,
  - embedded software version,
  - configuration (Analyser, Recorder ...)
  - hardware version.

Click on the window to close.

**Reminder** By logging on to the [www.chauvin-arnoux.com](http://www.chauvin-arnoux.com) web site, the user can download updates.

A product support technician will answer any questions via the email address.

# "Oscilloscope with SPO Persistence" instrument

## Selection

Smart Persistence Oscilloscope (SPO) mode is activated from the Instrument menu.

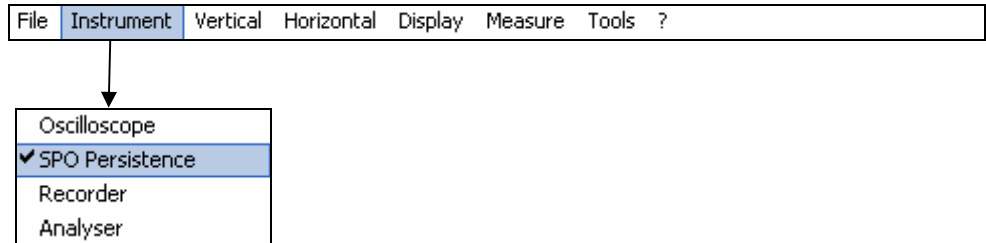

## Presentation

SPO Persistence:

- displays unstable, transient phenomena and glitch
- displays the evolution of the signal over a period of time, jitter and modulation in the same way as when an analogue oscilloscope is used
- causes acquisition to persist for a set period of time in order to observe trace aggregation.

The light intensity or colour assigned to the point on the screen diminishes if not renewed when a new acquisition process is implemented.

Acquisition is made according to 3 dimensions:

- time
- amplitude
- occurrence, which is a new dimension.

## Acquisition

SPO processing optimises the detection of transitory phenomena:

without SPO	with SPO
<p>Acquisition tasks and processing are serial.</p> <p style="text-align: center;"><i>1 acquisition = 1 display</i></p> <pre> graph LR     A[Acquisition] --&gt; B[Traitement]     B --&gt; C[Affichage]             </pre>	<p>Acquisition tasks and processing are in parallel.</p> <p>The number of acquisitions per second can be multiplied by 100. The idle time between two acquisitions is thus considerably reduced.</p> <p style="text-align: center;"><i>N acquisitions = one display</i></p> <pre> graph LR     A[Acquisition] --&gt; B[Traitement rapide]     A -.-&gt; C[Affichage]     B -.-&gt; C             </pre>
<p>Representation on the screen of 500 points out of the 50,000 points acquired.</p>	<p>Representation on the screen of 50,000 points acquired using an appropriate compression system.</p>
<p>Display of a segment to link the two points.</p>	<p>Display of a cloud of points not interconnected. No interpolation.</p>

## Occurrence

SPO brings a statistical dimension to the breakdown of samples. The colour or light intensity highlight signal irregularities. They also enable a distinction to be made between rare points and frequent points. These settings can be modified by adjusting the persistence period.

# "Oscilloscope with SPO Persistence" instrument

**Examples**

*Monochrome representation (one colour per trace):*

- the dark green points recur frequently,
- the light green points recur less frequently.

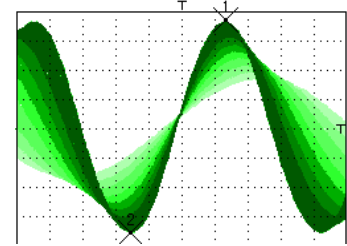

*Multicolour representation:*

- the red points are often renewed
- the purple points are renewed less often.

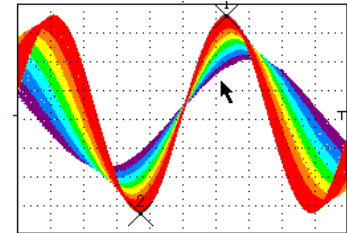

## Display

On the Instrument menu, click on SPO Persistence (or click on the SPO icon on the toolbar).

The Oscilloscope Control Panel and Oscilloscope Trace display window appear.

## SPO Control Panel

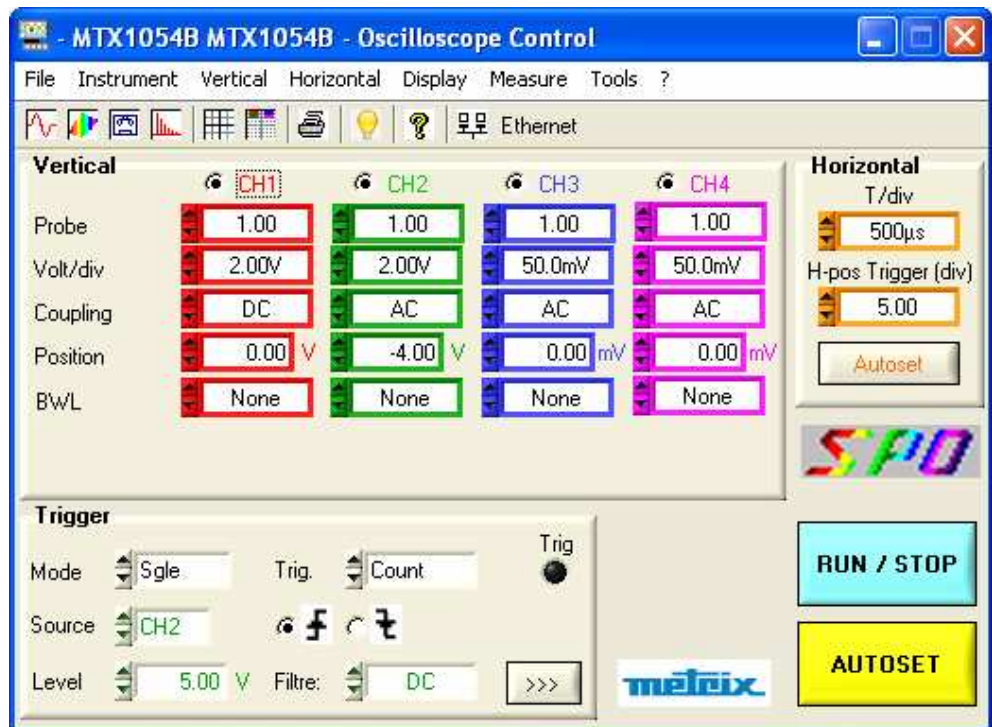

The toolbars and drop-down menus are identical to those in Oscilloscope mode, the settings boxes also.



An SPO sign at the bottom right of the screen indicates to the user that the oscilloscope is operating in analogue persistence mode.



## "Oscilloscope with SPO Persistence" Instrument (contd.)

### Oscilloscope Trace Window

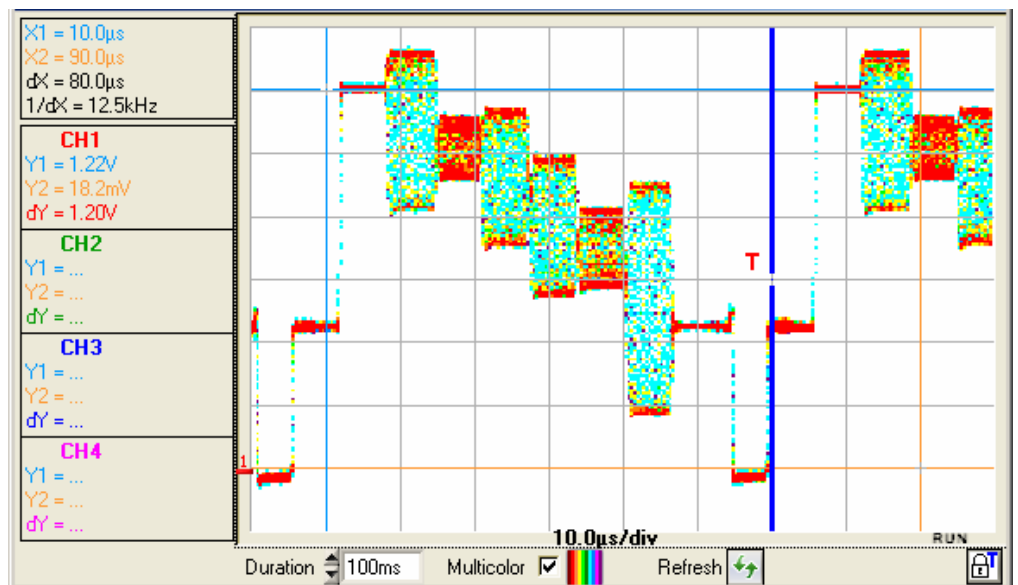

### Period

Setting the point persistence period:

- infinite
- 10s
- 5s
- ✓ 2s
- 1s
- 500ms
- 200ms
- 100ms

→ (all the points acquired since the last time acquisition was started are aggregated)

### Multicolour

Setting the representation type:

- With Multicolour validated:
  - the brightest colour is assigned to the most frequent points: red
  - the dullest colour is assigned to the least frequent points: purple
- With Multicolour not validated:
  - the darkest colour is assigned to the most frequent points: (Example: bright red for channel CH1)
  - the lightest colour to the least frequent points (Example: very light red for channel CH1)



Screen refreshment

By clicking on this button, the points displayed are erased and the acquisition system reset.

## "Oscilloscope with SPO Persistence" instrument

### Menus

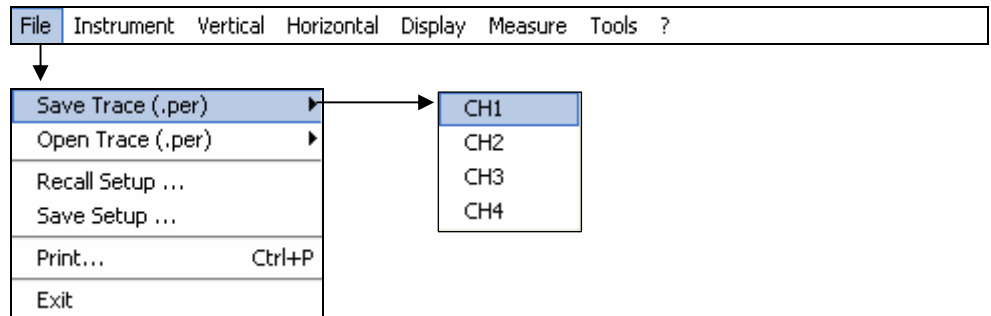

### Vertical

The Vertical menu limits the user to the choice of the vertical unit. Mathematical functions cannot be defined.

### Triggering

Ditto Oscilloscope mode.

### Horizontal

The Horizontal menu limits the user to the selection/deselection of Min/Max acquisition mode.

### Display

The Display menu limits the user to activation/deactivation of display of the grid or units, coupling and limitation of the band of each channel active on the trace.

### Measurement

The Measurement menu is limited to manual measurement with unattached cursors and manual phase measurement.

### Tools

This menu is identical to oscilloscope mode but no EXCEL export is possible.

### "?"

This menu is identical to the one in Oscilloscope mode.

# "Recorder" Instrument

## Presentation

The recorder makes it possible to observe very slow phenomena that are not visible in Oscilloscope mode. It enables signals to be acquired over a maximum period of one month. In addition, this mode is used to capture faults according to various criteria. These faults can be stored in the form of files on the computer.

## Selection

- Open the Instrument menu and click on Record or
- Click on the Recorder  icon on the toolbar

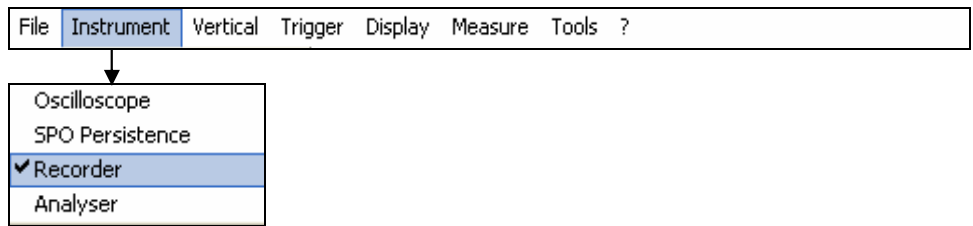

## Display

### Recorder Control Panel

All the oscilloscope functions can be accessed and parameters set via:

- a. the drop-down menus
- b. the tool bar
- c. the setting boxes
- d. the control buttons

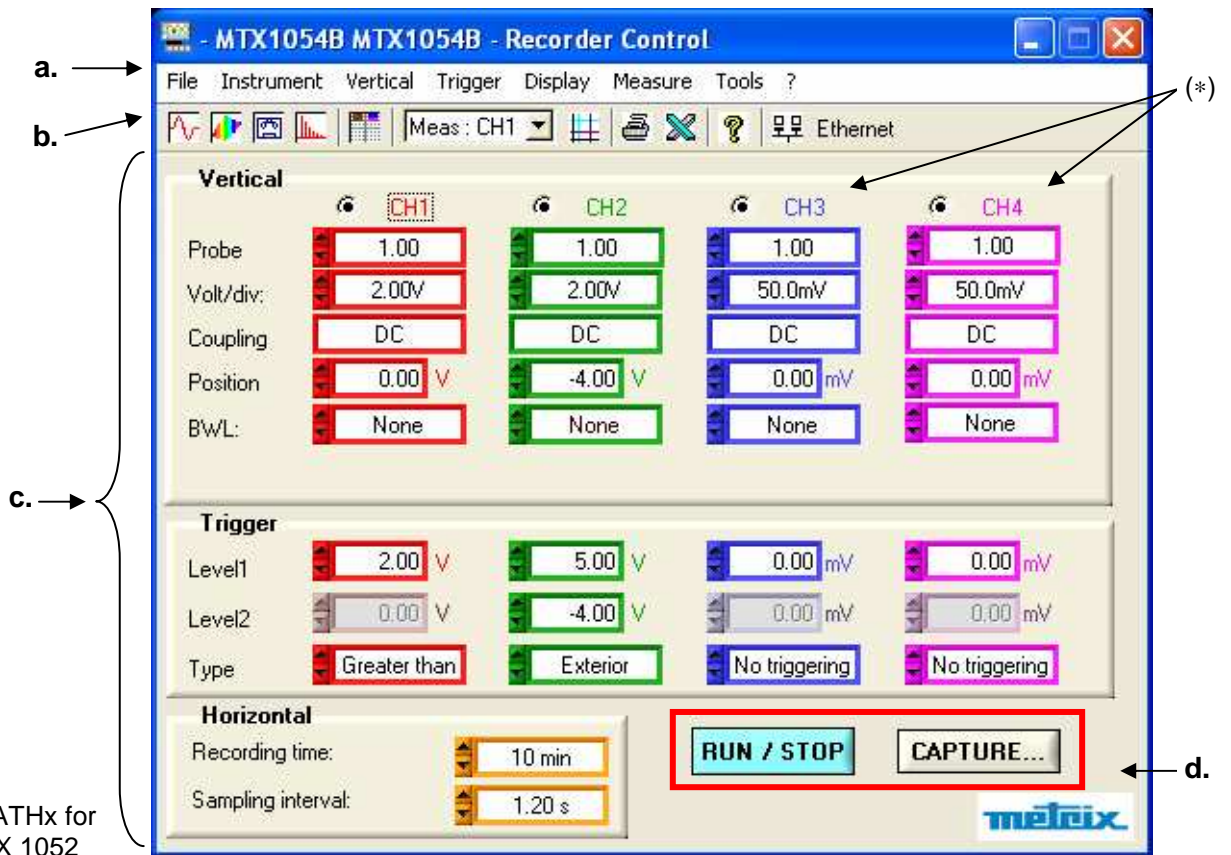

## "Recorder" Instrument (contd.)

### a. the drop-down menus

File Instrument Vertical Trigger Display Measure Tools ?

There is no Horizontal menu.

### b. the tool bar

 Meas: CH1

The functions of the icons on the toolbar are identical to those of the oscilloscope.

### c. the settings boxes

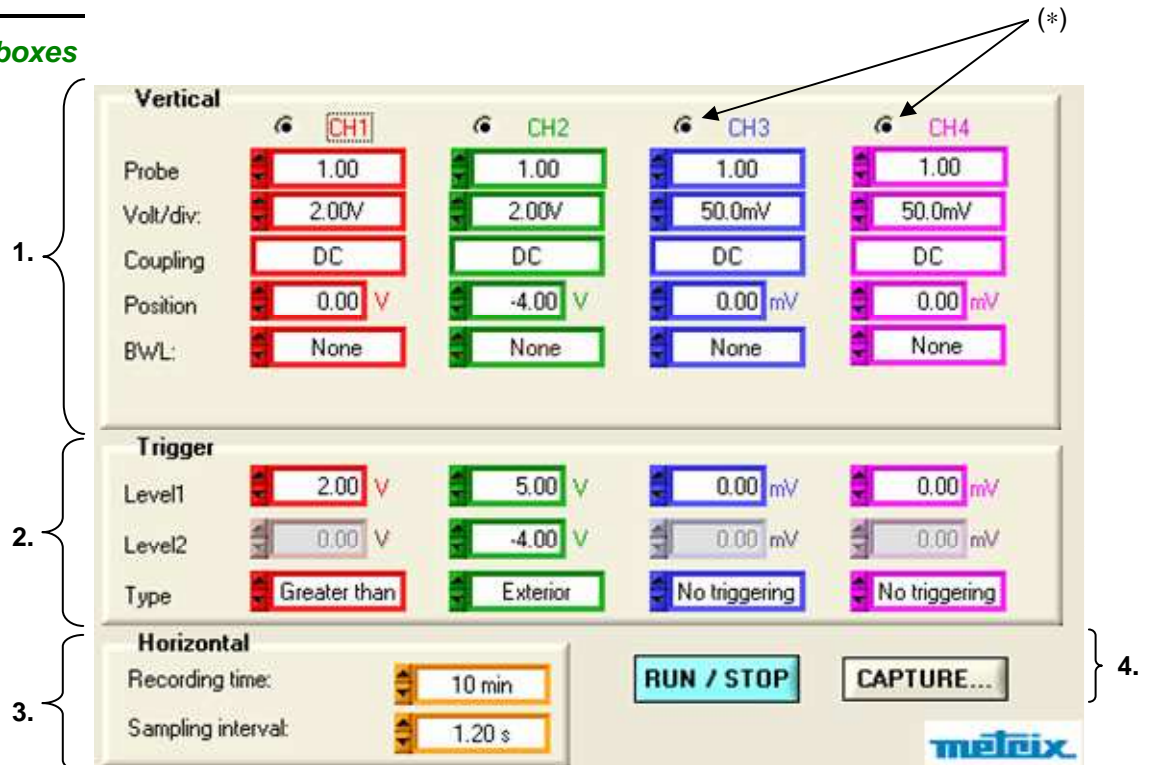

(\*)

(\*) MATHx for  
MTX 1052

1. **Vertical** box: the same as in Oscilloscope mode, the DC coupling is the only one permitted for each channel due to the low frequency of the signals analysed in this mode.
2. **Trigger** box: see the description on the next page.
3. **Horizontal** box: see the description on p. 95.
4. **RUN / STOP** and **CAPTURE** command buttons:

 **RUN:** starts acquisition  
**STOP:** stops acquisition

 transfers the 50,000 points of a recording to the PC.

## "Recorder" Instrument (contd.)

### Trigger box

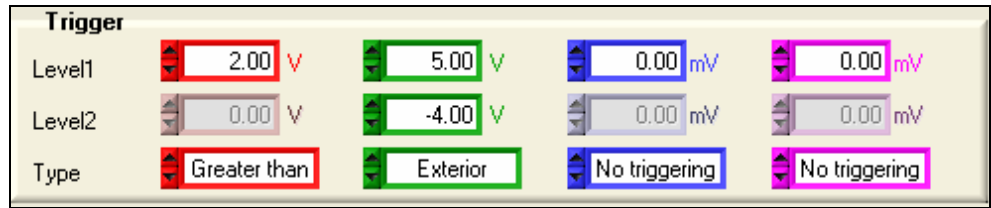

**Level 1** Adjustment of the main trigger threshold level using the mouse or keyboard.

**Level 2** Adjustment of the auxiliary trigger level using the mouse or keyboard. This adjustment is only active if the Exterior trigger Type is selected (otherwise the Level2 box is greyed out).

**Type** This window indicates the trigger type of the channel. Recorder mode enables a condition to be simultaneously monitored for each active channel.

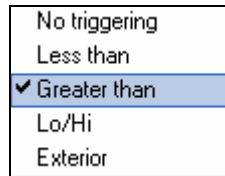

**No trigger:** if all the channels are in this mode, the instrument observes the trace indefinitely (continuously). When stopped, only 50,000 points are saved.

*Pretrig is monitored for each type of trigger.*

- Lower than:** triggering takes place when the signal drops below the Level1 threshold.
- Lower/higher than:** triggering takes place when the signal drops below or rises above the threshold.
- Higher than:** triggering takes place when the signal rises above the threshold.
- Outside:** triggering takes place when the signal goes outside the window defined by the two thresholds, Level1 and Level2.



*A half-division hysteresis is applied to prevent ill-timed triggers.*

## "Recorder" Instrument (contd.)

- ✎ Example: Case 1
- Channel 1 is set with a 1.00V "Greater than" trigger for Level1.
  - Channel 2 is set with a "Exterior" type trigger defined by a Level1 = 5.00V and a Level2 = -4.00V.
  - Channels 3 and 4 do not have any trigger.

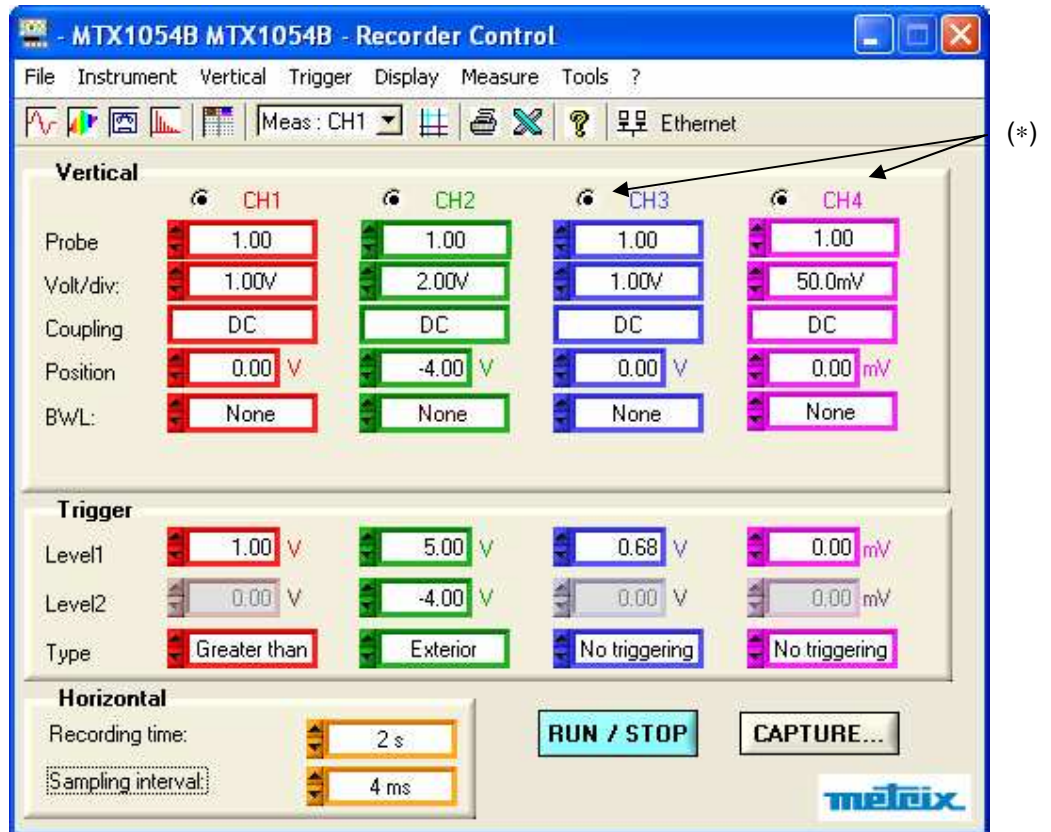

(\*) MATHx for  
MTX 1052

In this case, the trigger takes place on CH1 when the signal exceeds a level of 1.00V.

There is no trigger on CH2 because the signal amplitude is within the window defined by Level1 = 5.00V and Level2 = -4.00V and the programmed trigger condition is: "Outside" the window specified.

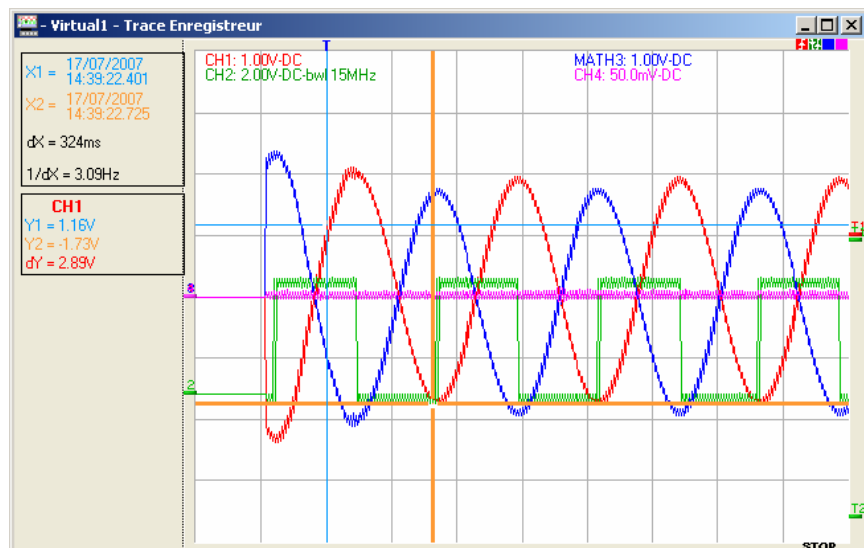

## "Recorder" Instrument (contd.)

- Example: Case 2 - Channel 1 is set with a 2.5V "Greater than" trigger for Level1.
- Channel 2 is set with an "Exterior" type trigger.

(\*)

Vertical	CH1	CH2	CH3	CH4
Probe	1.00	1.00	1.00	1.00
Volt/div.	1.00V	2.00V	1.00V	50.0mV
Coupling	DC	DC	DC	DC
Position	0.00 V	-4.00 V	0.00 V	0.00 mV
BWL:	None	None	None	None

Trigger	CH1	CH2	CH3	CH4
Level1	2.50 V	5.00 V	0.68 V	0.00 mV
Level2	0.00 V	-4.00 V	0.00 V	0.00 mV
Type	Greater than	Exterior	No triggering	No triggering

Horizontal	Value
Recording time:	2 s
Sampling interval:	4 ms

RUN / STOP
CAPTURE...

**metrix**

(\*) MATHx for MTX 1052

In this case, triggering takes place on channel CH2 since the condition on channel CH1 is not met.

Triggering takes place on the rising edge of CH2 when the signal on channel CH2 exceeds 1.00V and goes out of the window specified by "Level1 = 1.00V and Level2 = -4.00V".

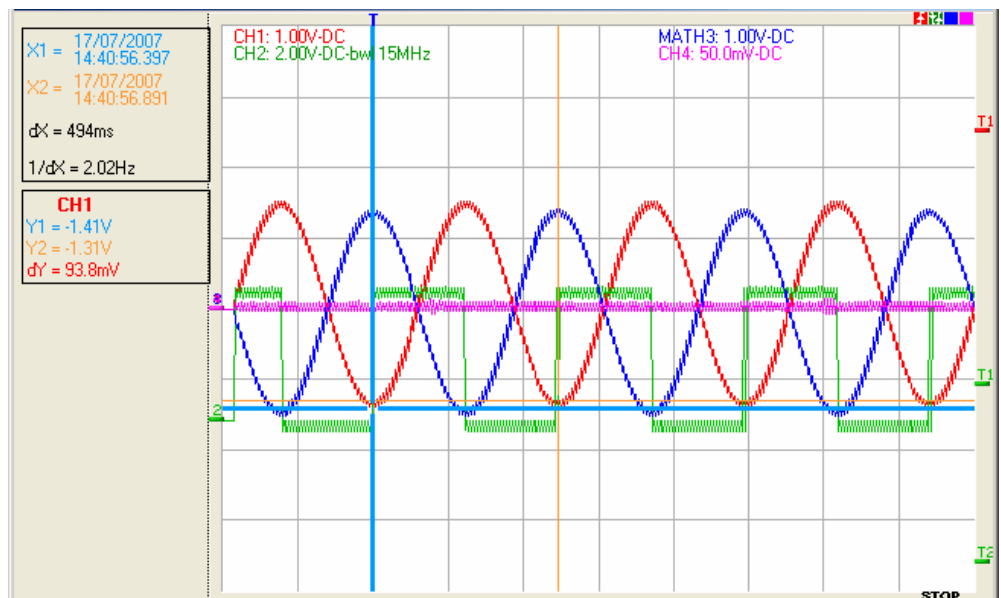

## "Recorder" Instrument (contd.)

**Horizontal box** The following can be set in this box:

Recording period Variation range from 2s to 31 days: this is the time that elapses between the first fault point and the last (*Note: trigger occurs 2 screen divisions after the first sample displayed in the case of the display of only one fault*).

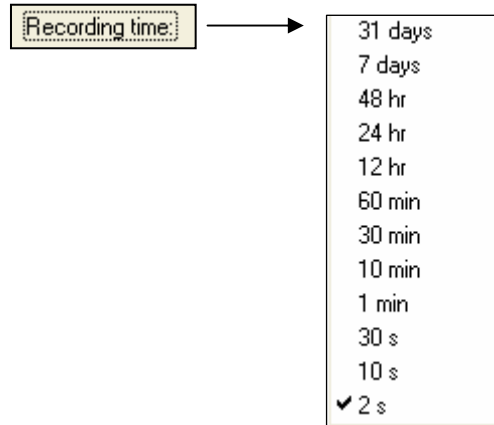

Acquisition interval This is the time separating 2 acquisition points.

Variation range: 40 $\mu$ s to 53.57s in Capture 1 fault

Variation range: 4ms to 1hr 29min 16s in Capture 100 faults.

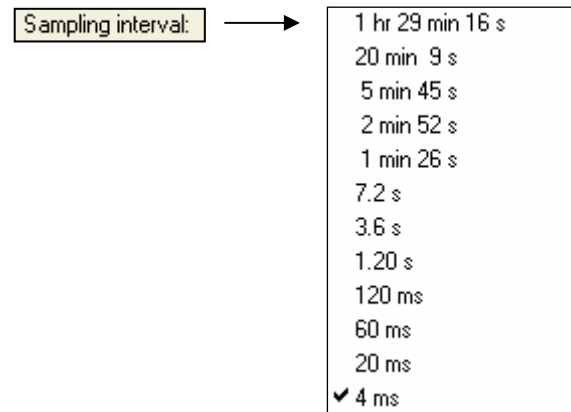

These two values are correlated. When the user modifies one, the other is automatically recalculated.

To set these values, use the mouse on one of the scroll bars.

Clicking in the boxes displays the available values and the value to apply can thus be selected with a simple click.



# "Recorder" Instrument (contd.)

## Recorder "Trace Panel"

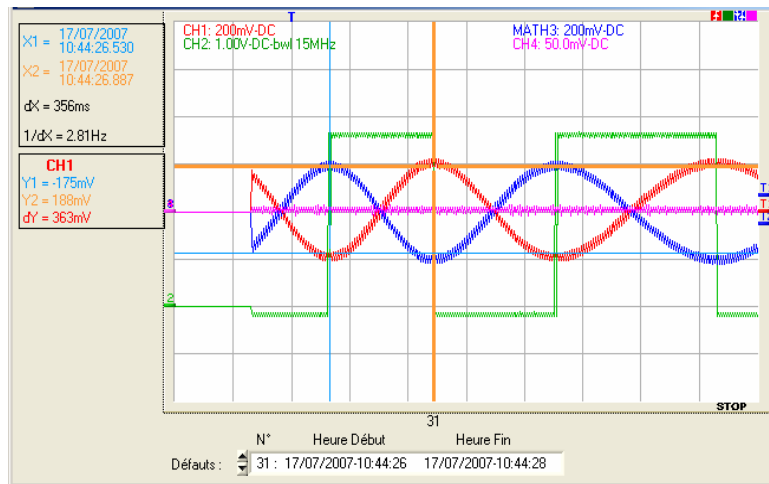

**Display box for manual cursor measurements X1, X2, Y1, Y2**

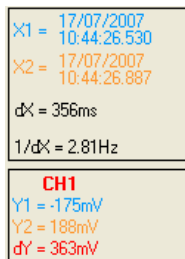

This display is only possible if manual measurements (dt/dv) are activated (see Measurements menu).

## Trace display box

Capture 1 fault

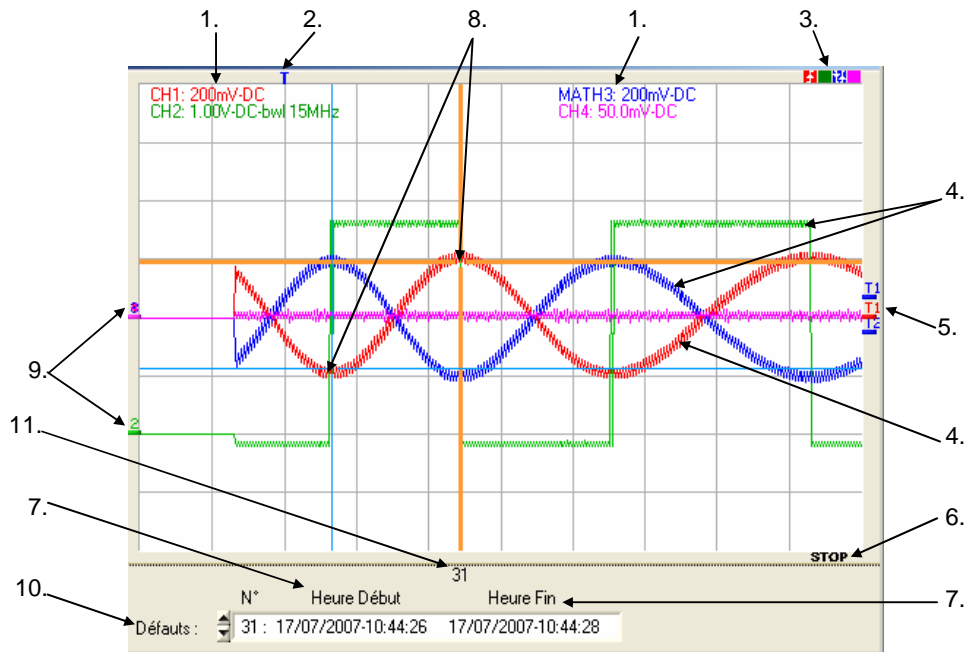

1. Display of the sensitivity, coupling and bandwidth of the channels activated
2. Position of the Trigger T
3. Types of trigger selected on the channels
4. Traces
5. Levels of trigger associated with the channels
6. Current status of acquisition
7. Recording start/end date/time
8. Manual cursors
9. Position "0 V" of the channels
10. Selection of the fault to be displayed
11. Display of the fault number

## "Recorder" Instrument (contd.)

### Trace display box

 Capture 100 fault

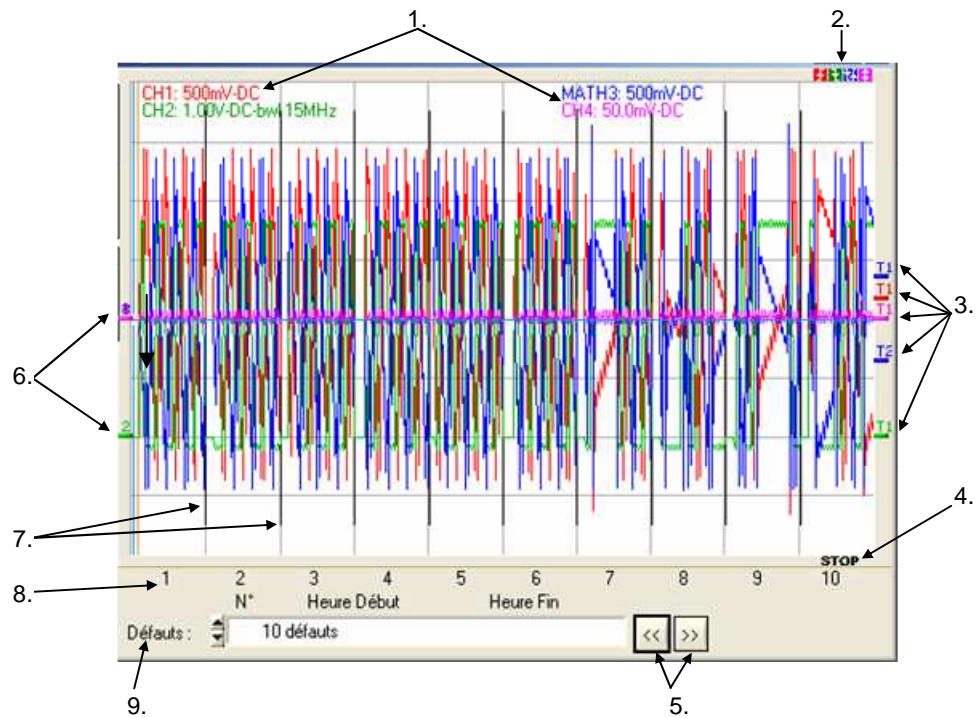

1. Display of the sensitivity, coupling and bandwidth of the channels activated
2. Types of trigger selected on the channels
3. Levels of trigger associated with the channels
4. Current status of acquisition
5. Transition to the Next/Previous 10 faults
6. Position "0 V" of the channels
7. Fault separator
8. Number of the 10 faults displayed
9. Selection of the fault to be displayed

### Trace display box



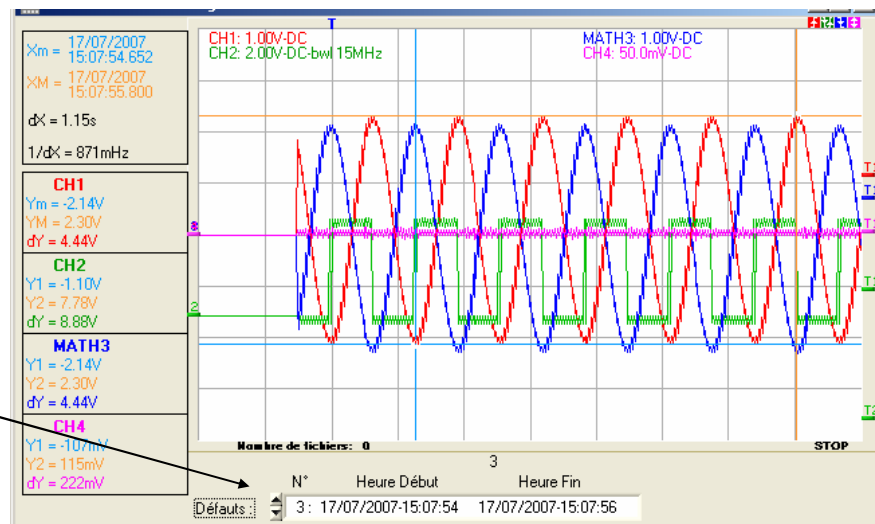

 File capture

Number of files created



### Trigger types



-  Trigger higher than the last channel activated
-  Trigger lower than the last channel activated
-  Trigger higher/lower than the last channel activated
-  Trigger outside the window of the last channel activated



*The colour of the level indicator is that of the channel activated.*

## "Recorder" Instrument (contd.)

Display with the  
**CAPTURE...** button

This button transfers the 50,000 points corresponding to a recording to the PC and analyses them.

When this button is pressed, two additional windows are opened after downloading:

- Capture: Recorder Control
- Capture: Recorder Trace

Capture: Recorder  
Control Panel

(\*)

Vertical	CH1	CH2	CH3	CH4
Probe	1.00	1.00	1.00	1.00
Volt/div:	1.00V	2.00V	1.00V	50.0mV
Coupling	DC	DC	DC	DC
Position	0.00 V	-4.00 V	0.00 V	0.00 mV
BWL:	None	None	None	None

Trigger	CH1	CH2	CH3	CH4
Level1	2.50 V	5.00 V	0.68 V	0.00 mV
Level2	0.00 V	-4.00 V	0.00 V	0.00 mV
Type	Greater than	Exterior	No triggering	No triggering

Horizontal	Value	Action
Recording time:	2 s	Print
Sampling interval:	40 $\mu$ s	Export to Excel

(\*) MATHX for  
MTX 1052

This panel indicates the values of the various parameters used to capture this recording:

- vertical,
- horizontal
- and trigger

at the moment the user clicks on the capture button.

It is associated with the **Capture: Recorder Trace** panel (next page)

When one of the 2 windows is closed, they disappear at the same time.

## "Recorder" Instrument (contd.)

Capture: Recorder  
Trace Panel

 Capture 1 fault

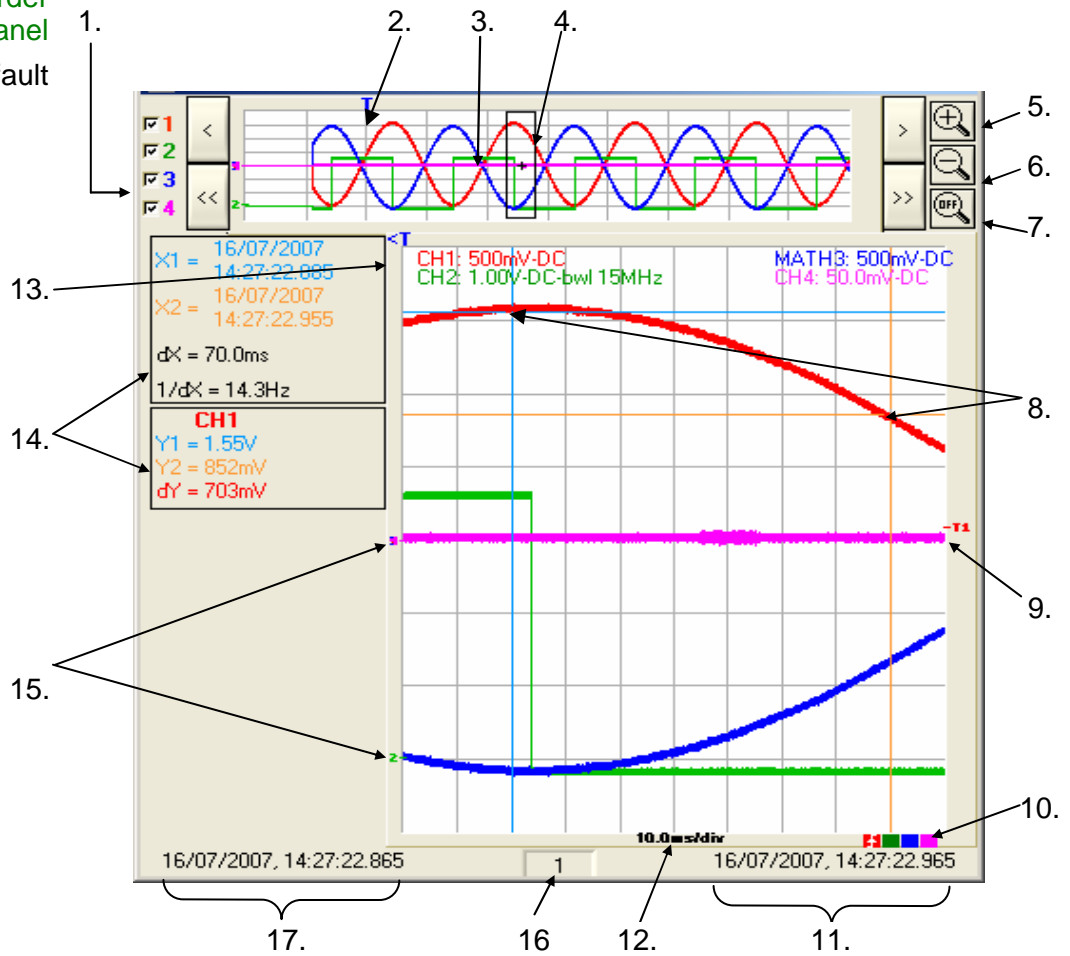

1. Selection of the traces to be displayed:
2. Trigger
3. Display of the entire recording
4. **Délimitation de la zone agrandie**
5. Expansion of the zone to be displayed
6. Compression of the zone to be displayed
7. Back to the display of the entire recording
8. Manual cursors
9. Trigger level
10. Trigger type
11. End date and time of the expanded zone
12. Time base
13. Trigger position
14. Manual cursor measurement display zone
15. Position "0 V" of the channels
16. Number of the fault displayed
17. Start date and time of the expanded zone

## "Recorder" Instrument (contd.)

On this panel, both the complete recording and zoomed zone are displayed with a rectangle indicating the position of this zone in the recording.

The 2 cursors (blue and yellow) can be moved to take manual measurements in the zoomed trace.



The position of the trigger in the recording is symbolised by the T.



- The horizontal zoom factor can be adjusted by clicking on the



magnifying glass icons .

- The zoomed zone can be moved:

slowly to the left or right by clicking on  

or by 8 divisions by clicking on  

The values displayed have the same significance as in Oscilloscope mode.

Maximum and minimum searches are possible:  
Display → Min & x → TraceX Menu .

Manual and automatic measurements can be activated.

Capture: Recorder  
Trace Panel

 Capture 100  
faults (or file capture)

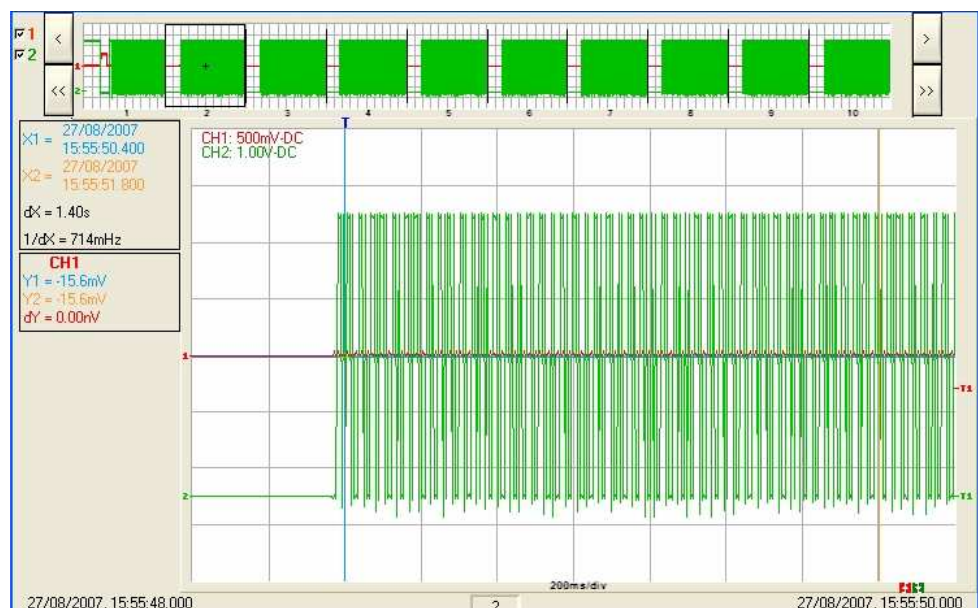

## "Recorder" Instrument (contd.)

### The « File » menu

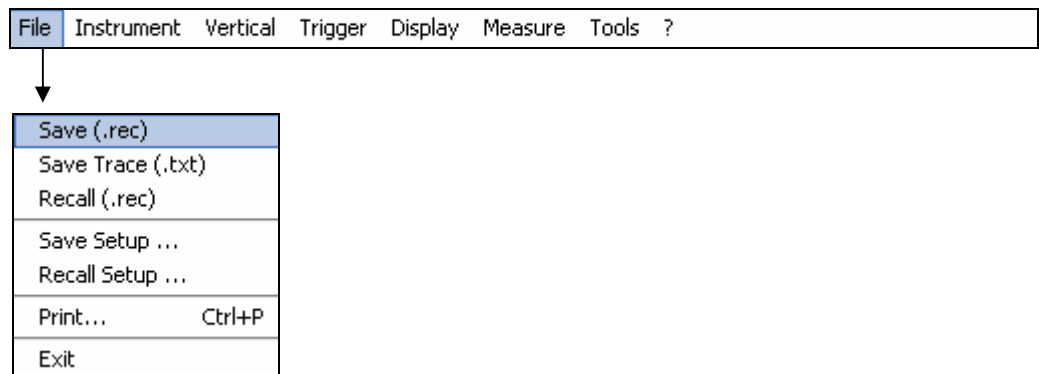

### Save (.rec)

A save records up to 100 faults in one .REC file.

When selected a "Save as" window is opened:

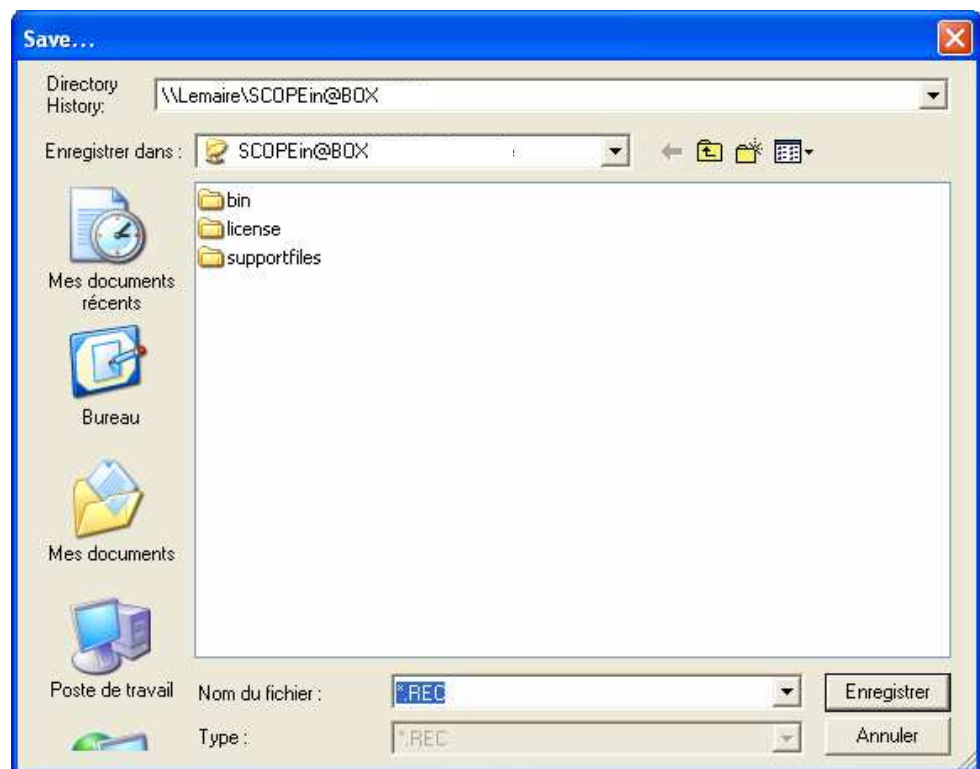

- Entrez un nom de fichier de sauvegarde par le clavier.
- Un clic sur la touche **Enregistrer** confirme l'enregistrement dans le répertoire sélectionné.

☞ *Les 4 traces sont sauvegardées dans un même fichier.*

## "Recorder" Instrument (contd.)

### Save (.txt)

Identical to Oscilloscope mode.

 *The 4 traces are saved in the same file.*

### Rappel (.rec)

when selected, opens the following message:

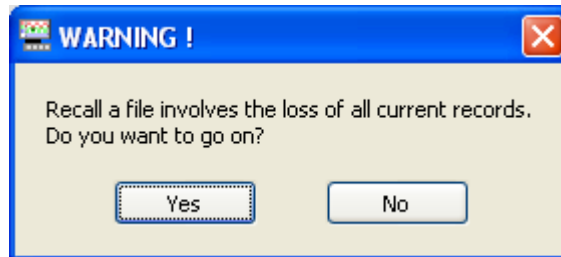

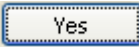
If the user clicks on , the following window is displayed:

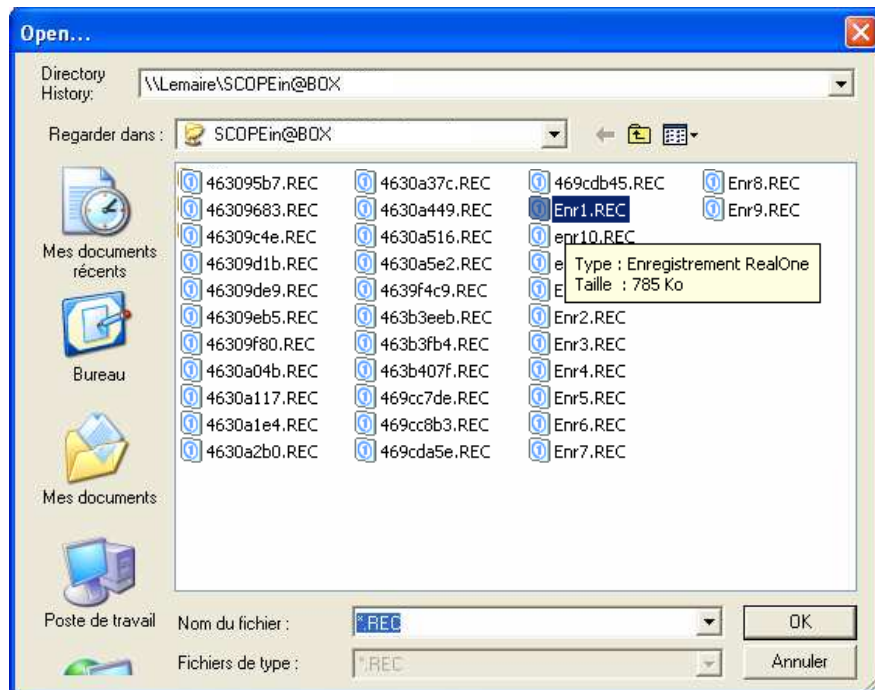



Previously saved .REC files are displayed in the Source list.

The file to be recalled is selected by double clicking on it with the mouse.

To exit the menu without recalling a file, click on .



- *It is impossible to launch an acquisition or deselect a channel while the recorder is in memory display mode.*
- *It is not possible to switch from a normal acquisition to fault capture while the recorder is in memory display mode.*
- The  button reminds the user that the recorder is in memory display mode.
- *When a .REC file is recalled, the symbol "MEMx" is displayed in the parameters of all the traces.*
- *To exit memory display, click on  with the mouse.*



## « Recorder » Instrument (contd.)

---

Identical to Oscilloscope mode.

**Save Setup**

**Recall Setup**

**Print ...**

**Exit**

## "Recorder" Instrument (contd.)

### The "Vertical" menu

is identical to the one described in Oscilloscope mode.

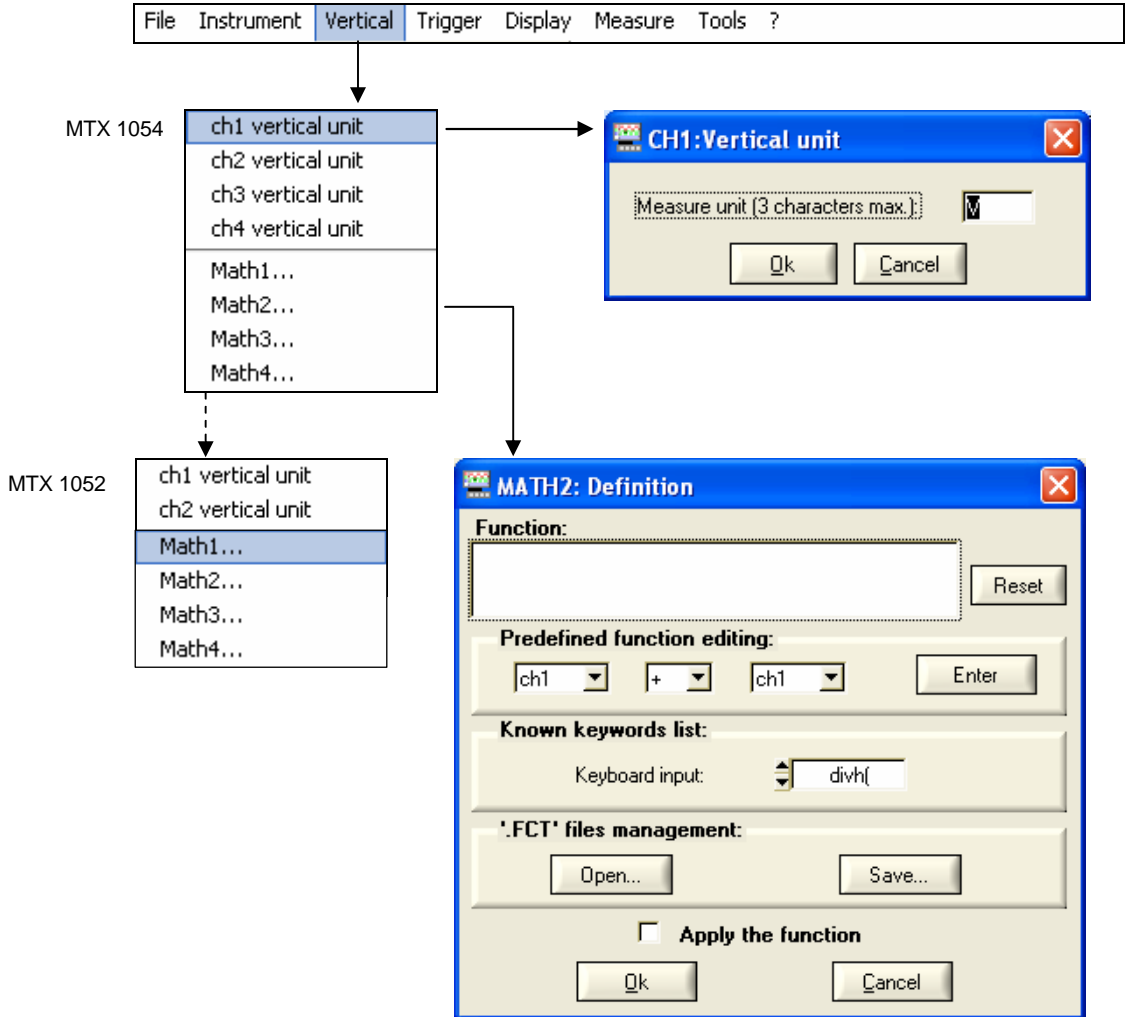

## "Recorder" Instrument (contd.)

### The "Trigger" menu

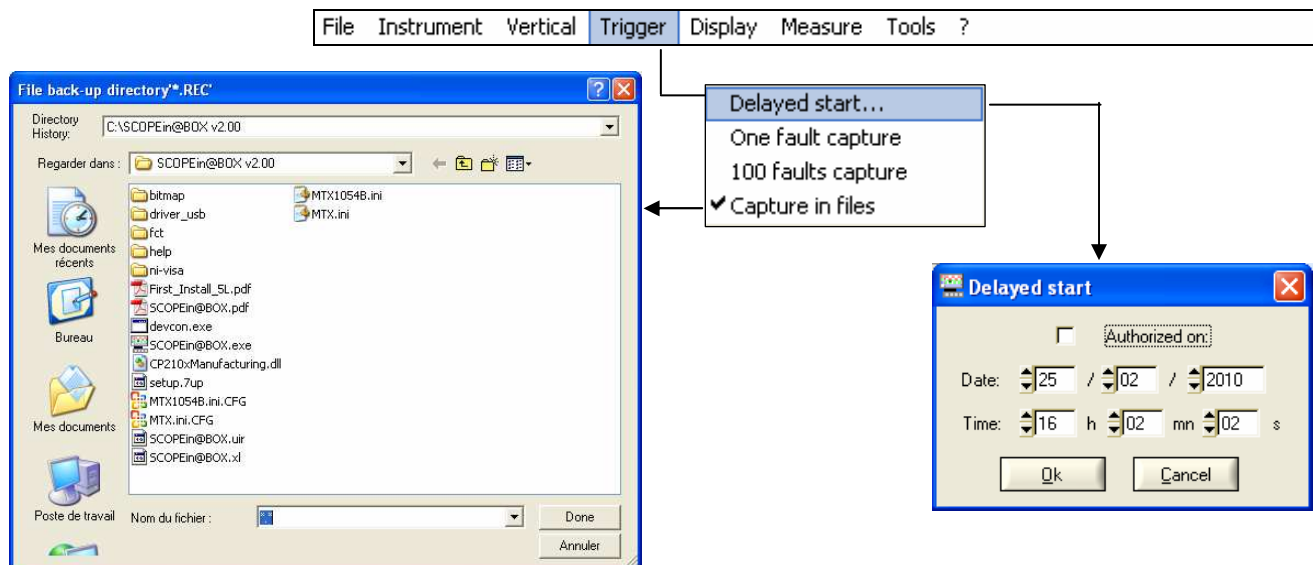

### Delayed start

Delayed start offers the possibility of starting up an acquisition at a date and time chosen by the user.

#### Authorised on

- If the symbol "✓" is displayed, delayed start has been validated.
- If there is no "✓" symbol, delayed start has not been validated.



- When delayed triggering is validated, the user can no longer trigger acquisition in recorder mode. However, the other modes (scope, analyser) can be used as desired.



If deferred triggering is programmed and an instrument other than recorder is activated, triggering will not be started.

If the user wishes to make an acquisition in record mode, he/she must:

- either unvalidate delayed start-up,
- or wait until the delayed start-up acquisition begins.

- At the startup of acquisition (time programmed for delayed start), the instrument must be switched on and the user must have activated recorder mode.

#### Date/Time

Different scroll boxes allow the user to set the date and time he/she wishes the acquisition to commence.

#### Example

Acquisition to start at 18h 32mn 35s on 11/06/2007.

The red clock symbol shows the user that delayed start-up is enabled.



## "Recorder" Instrument (contd.)

### One fault capture 100 fault capture

One fault capture mode enables a fault to be recorded for 50,000 samples.  
100 fault capture mode enables 100 faults to be recorded on 500 samples.

At a given moment, 10 recordings will be displayed on the screen. Each recording is separated by a solid vertical line.

They are recorded in the volatile memory.

#### Example

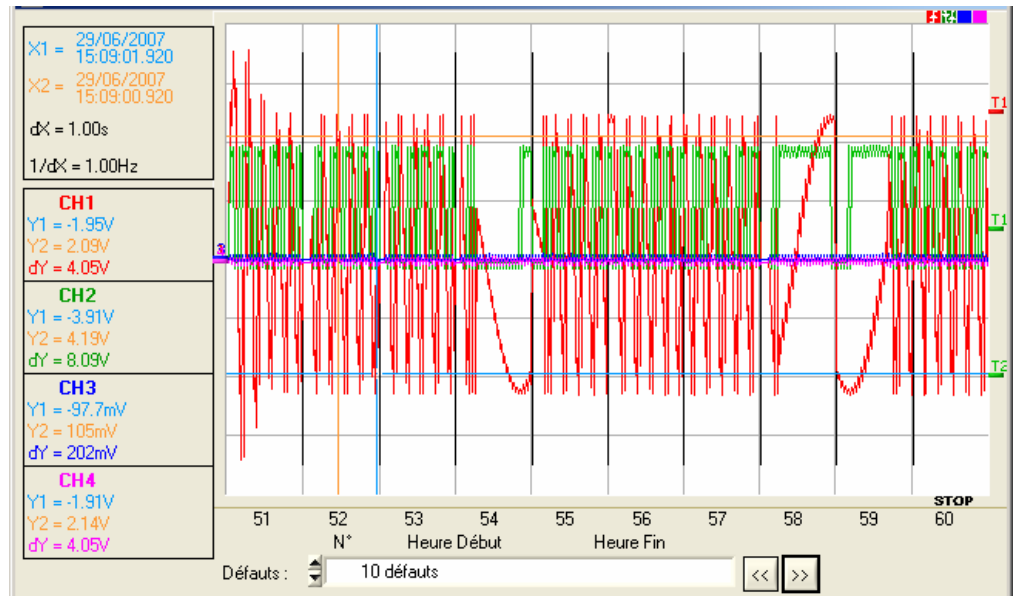

Capture 100 faults mode has been selected:  
the screen is divided into 10 parts.

The Zoom function enables one fault to be selected and displayed from the 100 recorded. Below is the display of fault N°9:

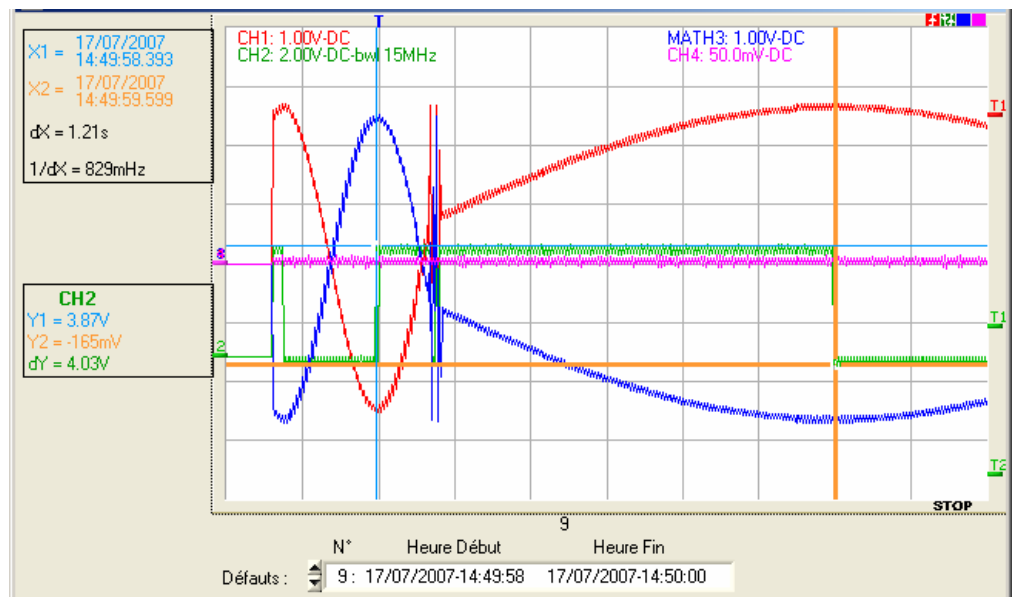

## "Recorder" Instrument (contd.)

### Capture in files

This mode is similar to 100 fault capture mode:

- Several series of recordings of 100 faults from 500 samples are made.
- The directory where the files are to be saved is defined when the mode is initiated.
- Each series of 100 faults is automatically stored in this directory in a .REC file.
- The total number of recordings that may be made depends on the space left on the PC hard disk.
- A counter indicates the number of files created:

(Example: Number of files: 2).



They are displayed folder by folder. The content of a file may be displayed on the screen. A file contains 100 faults. Capture 100 faults option display mode is therefore available.

The acquisition can be interrupted at any time by pressing the RUN/HOLD button. The user can then study previously recorded faults.



## "Recorder" Instrument (contd.)

### The "Display" menu

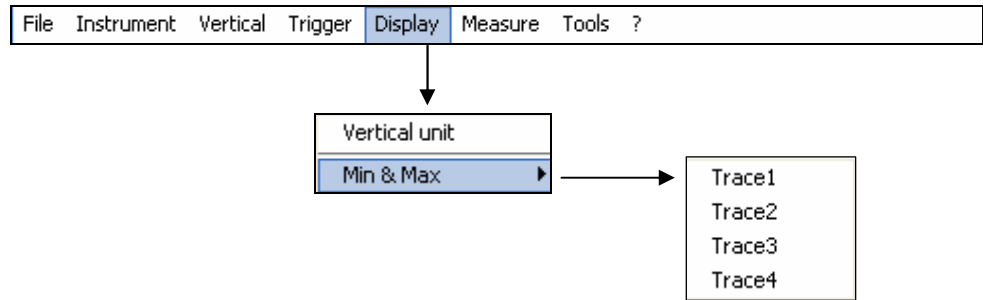

#### Vertical unit

validates the vertical sensitivity and BWL filter, if applicable, in the Recorder Trace window.

#### Min & Max

searches for the Min. and Max. values for a given trace. The cursors are then automatically fixed on these samples.

Select the trace for which the Min and Max are to be sought:

- Xm and XM indicate the horizontal position of the Min and Max respectively.
- Ym and YM indicate the value of the Min and Max respectively.

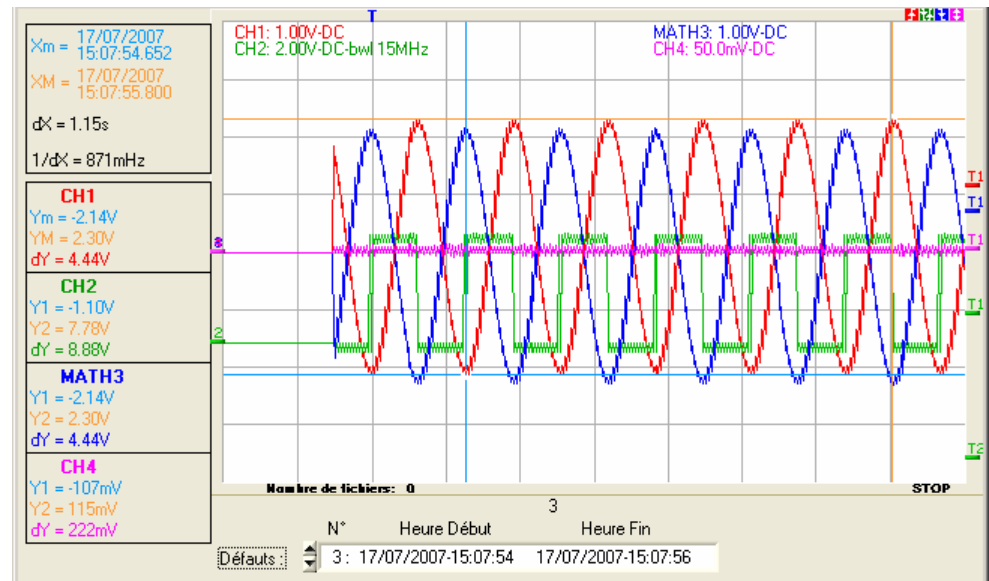

#### Particular case

Display of 10 faults on the screen (capture 100 faults or file capture mode) with the horizontal zoom not activated:

By default, the Min and Max values correspond to the 1st of the 10 recordings (but it is possible to choose another value by moving the cursors).

If the user has zoomed on a fault, the Min and Max of this fault are displayed.

## "Recorder" Instrument (contd.)

### The "Measurement" menu

enables the following to be chosen:

- the reference channel for measurement
- the display of the 19 automatic measurements
- the display of manual dt/dv measurements
- the type of cursors unattached or attached to the reference trace

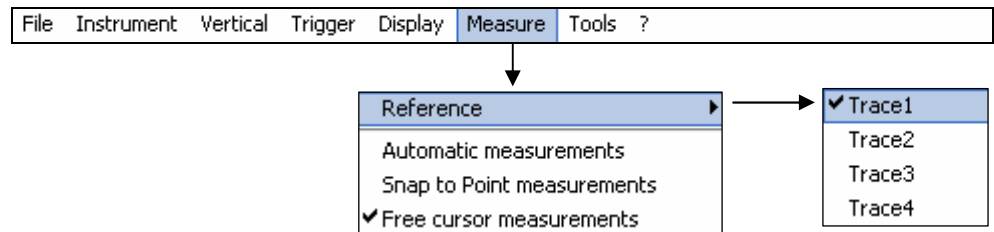

### Reference

Trace 1 ...2 ...3 ...4

Identical to Oscilloscope mode.

### Automatic measurements

This window is identical to the one in Oscilloscope mode.

The automatic measurement calculation zone is defined by the 2 cursors.

#### Particular case

*In Capture 100 faults mode (or file capture mode) with the horizontal zoom not activated, the Automatic Measurements function is impossible.*

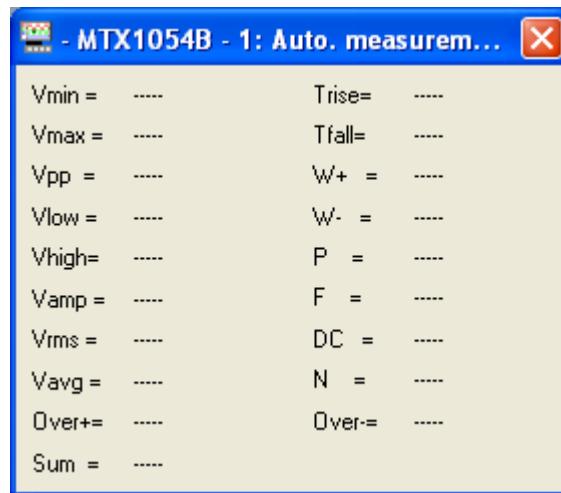

---

## "Recorder" Instrument (contd.)

---

### The "Tools" menu

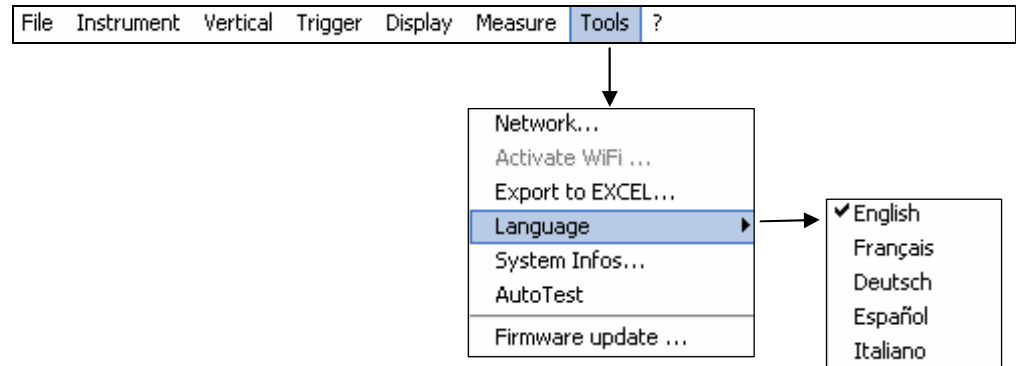

---

These sub-menus are identical to those described in Oscilloscope mode:

**Network...**

**Export to Excel...**

**Language**

**System Infos...**

**Autotest...**

**Firmware  
Update ...**



---

## "Recorder" Instrument (contd.)

---

**The "?" menu** gives access to the Help and About... sub-menus

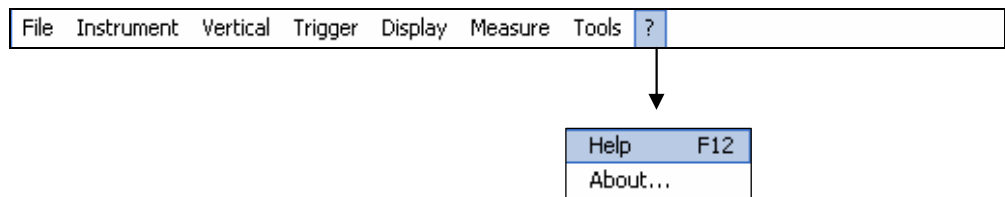

---

### Help

These sub-menus are identical to Oscilloscope mode.

---

### About ...

## "Harmonic Analyser" Instrument

### Presentation

The harmonic analysis function displays the **fundamental** and the **31 first harmonic ranks** of the signals present on the inputs.

In this mode, triggering is automatic and the time base is adaptive, it can not be adjusted manually.

This analysis is reserved for signals whose fundamental frequency is between 40 Hz and 1 kHz.

Channel parameter settings remain active:  
sensitivity/coupling, vertical scale, band limitation.

Only the signals (and not the traces calculated using mathematical functions) can be the subject of harmonic analysis.

The harmonic analyses of signals present on the four channels can be viewed simultaneously.

### Selection

- Click on **Instrument** on the toolbar and on **Analyser**,
- or click on the  icon on the toolbar

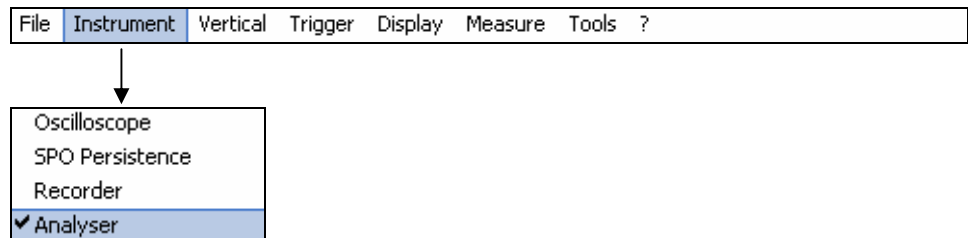

### Display

#### Harmonic Analyser Control Panel

The analyser functions can be accessed and parameters set via:

- a. the drop-down menus
- b. the tool bar
- c. the settings box

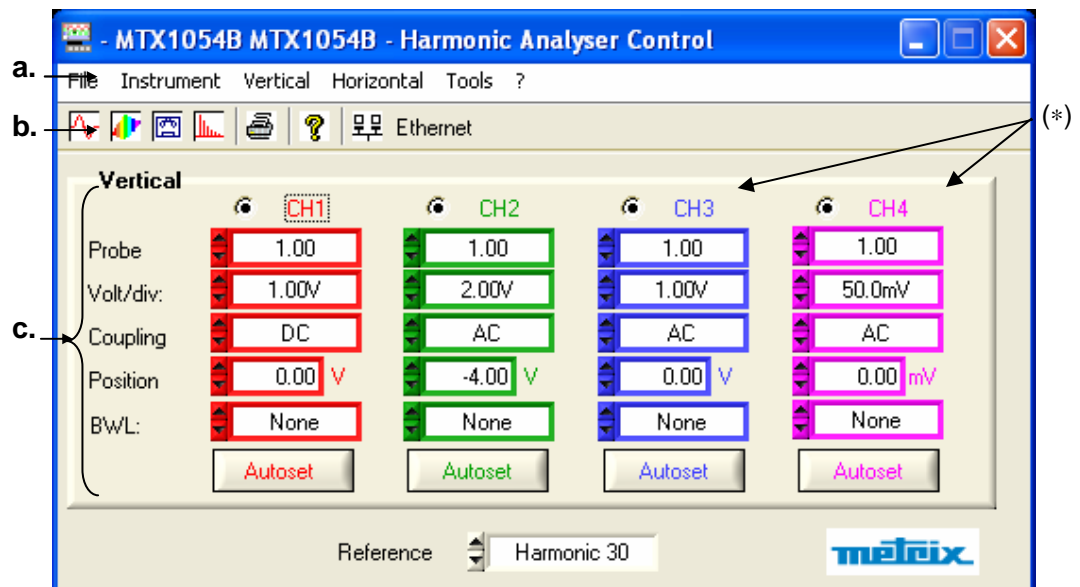

(\*) MATHx for  
MTX 1052B

## "Analyser" Instrument (contd.)

**a. the drop-down menus**

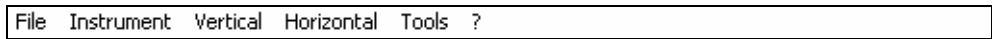

The Trigger, Display and Measurement menus are not present.

**b. the tool bar**



The functions of the icons on the toolbar are identical to those of the oscilloscope.

**c. the vertical setting box**

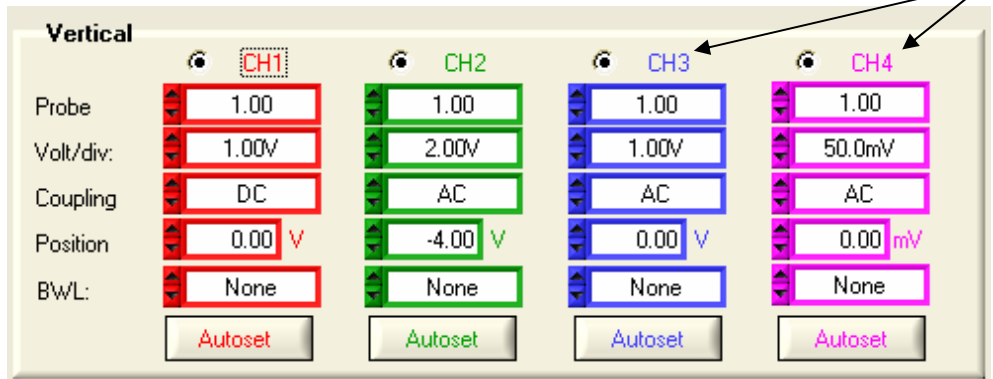

(\*) MATHX for the MTX 1052

The **Vertical** box is identical to the one in **Oscilloscope** mode.

**d. selection of the measurement reference**



This dialogue box enables the harmonic to be selected on which the measurements displayed in the Analyser Trace panel are to be made. The possible choices range from Harmonic 1 (or Fundamental) to Harmonic 31.

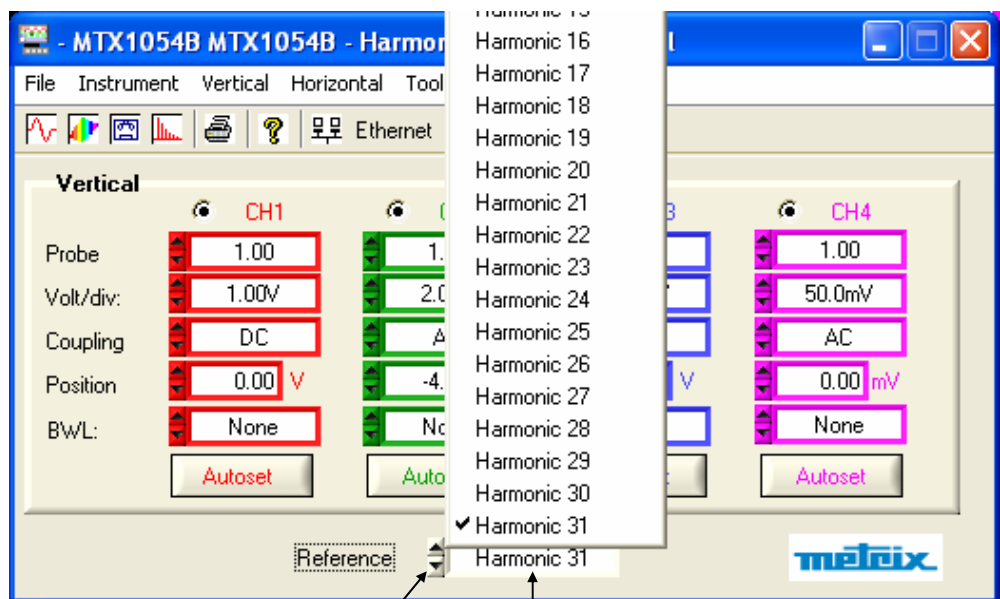

- Use the up/down scrollbar
- or click in the box where the current harmonic is displayed to bring up the list of harmonics; then select the desired harmonic.

## "Analyser" Instrument (contd.)

### Harmonic Analyser Trace Control Panel

The four Harmonic Analyses of the signals present on the channels are displayed simultaneously, together with the calibre and vertical coupling of each channel.

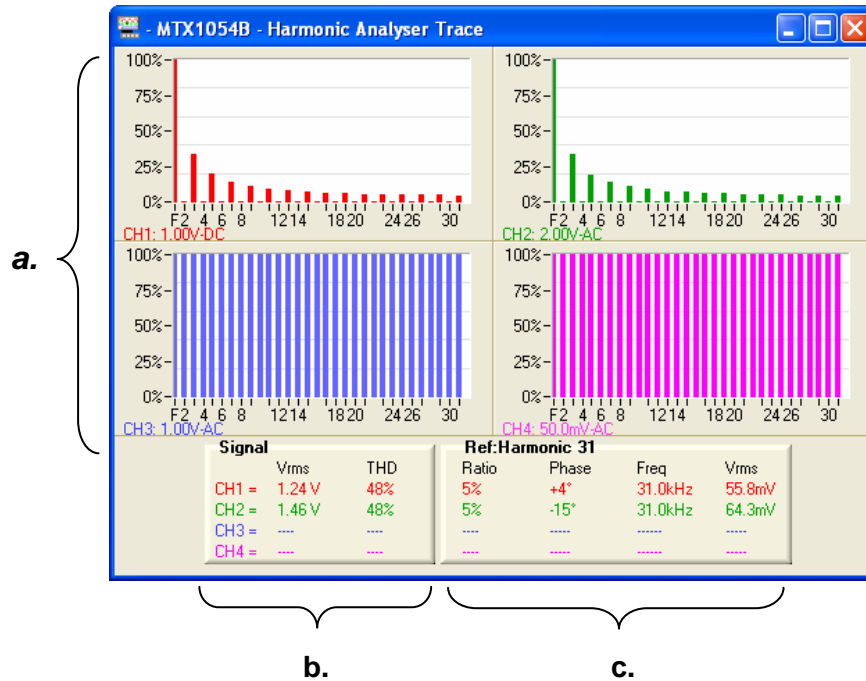

### a. Trace bargraph display box

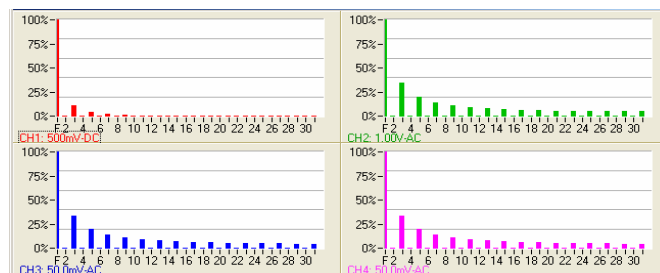

### b. Signal box

Signal		
	Vrms	THD
CH1 =	684mV	12%
CH2 =	1.84 V	49%
CH3 =	124mV	48%
CH4 =	125mV	48%

This indicates:

- the active channel(s)
- the RMS of the signal present on these channels
- the harmonic distortion rate (HDR) as a %
- if " - - - " is displayed, this indicates that the channel is not active or the signal on the active channel is absent.
- if " -OL-" is displayed, this indicates the overshoot of the signal for the channel displayed. Return to Oscilloscope mode to adjust the channel sensitivity.

### c. Fundamental Ref. Harmonic Ref. Box

Ref:Harmonic 21			
Ratio	Phase	Freq	Vrms
6%	+2°	21.0kHz	63.2mV
----	----	----	----
----	----	----	----
----	----	----	----

This indicates the following for the fundamental or the selected harmonic:

- the amplitude ratio of the harmonic selected in relation to the fundamental, expressed as a %
- the dephasing value of the harmonic in relation to the fundamental
- its frequency in Hz
- its RMS

## « Analyser » Instrument (contd.)

---

### The « File » menu

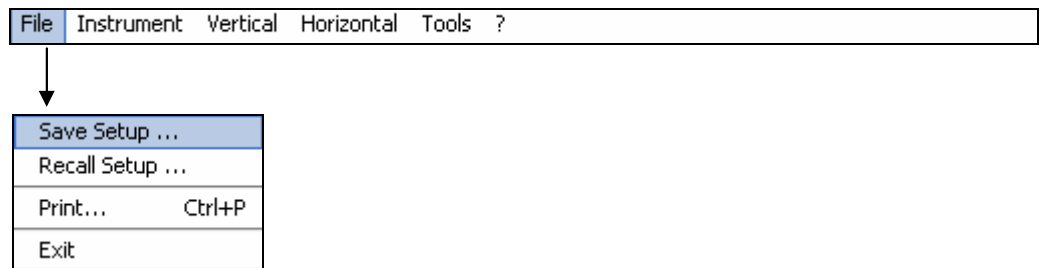

Identical to « Oscilloscope » mode.

**Save Setup ...**

**Recall Setup ...**

**Print ...**

**Exit**

## "Analyser" Instrument (contd.)

The "Vertical" menu defines the vertical unit of channels: CH1, CH2 (MTX 1052)  
CH1, CH2, CH3 and CH4 (MTX 1054)

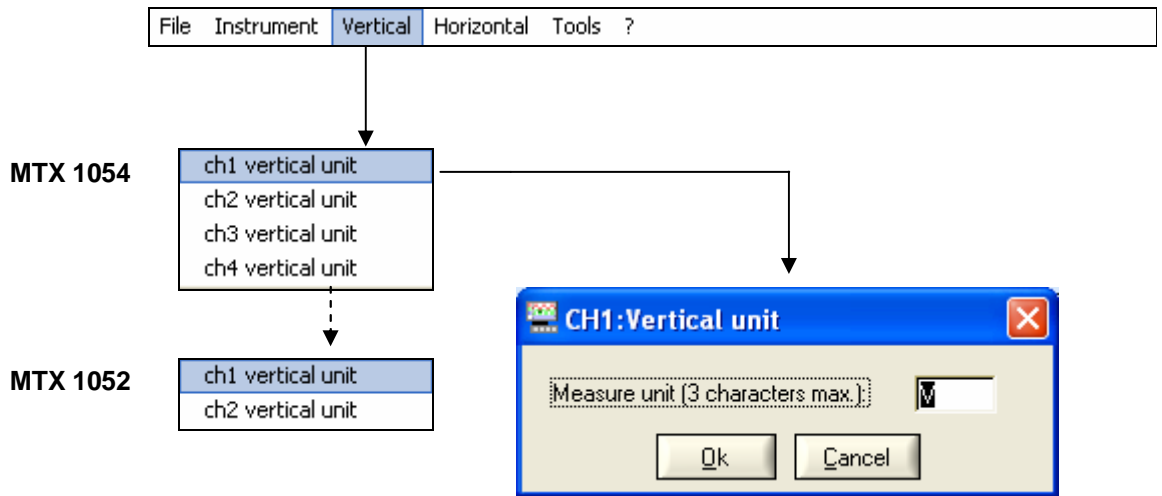

*The vertical scale unit is entered with the keyboard (max. 3 characters) and will be indicated in the display of the settings for the modified channel.*

## "Analyser" Instrument (contd.)

### The "Horizontal" menu

In Analyser mode, the Horizontal menu is reduced to the selection of the average rate.

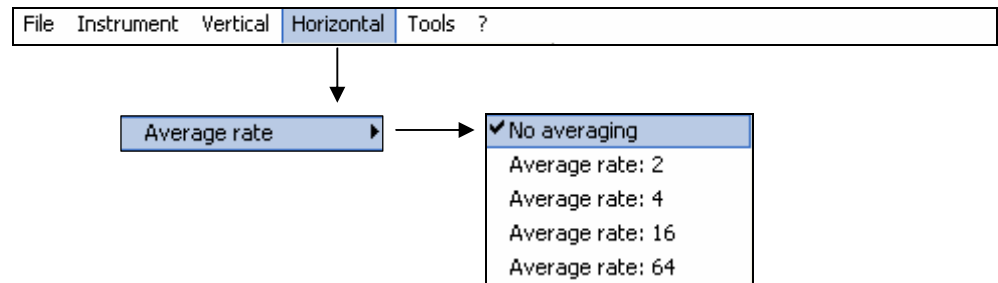

### Average rate

Averaging attenuates any random noise observed on a signal.

The following coefficients can be selected:

**No averaging**  
**Average rate: 2**  
**Average rate: 4**  
**Average rate: 16**  
**Average rate: 64**

no averaging,  
average rate: 2  
average rate: 4  
average rate: 16  
average rate: 64

The **Average rate** selected will be applied in the formula below:

$$\text{Pixel}_N = \text{Sample} * \frac{1}{\text{Average rate}} + \text{Pixel}_{N-1} (1 - \frac{1}{\text{Average rate}})$$

with:

- Sample: value of new sample acquired at abscissa t
- Pixel N: ordinate of the pixel with abscissa t on the screen at instant N
- Pixel N-1: ordinate of the pixel with abscissa t on the screen at instant N-1



*The "✓" symbol indicates the average rate selected.*

---

## "Analyser" Instrument (contd.)

---

**The "Tools" menu** This menu is identical to the one in "Oscilloscope" instrument :

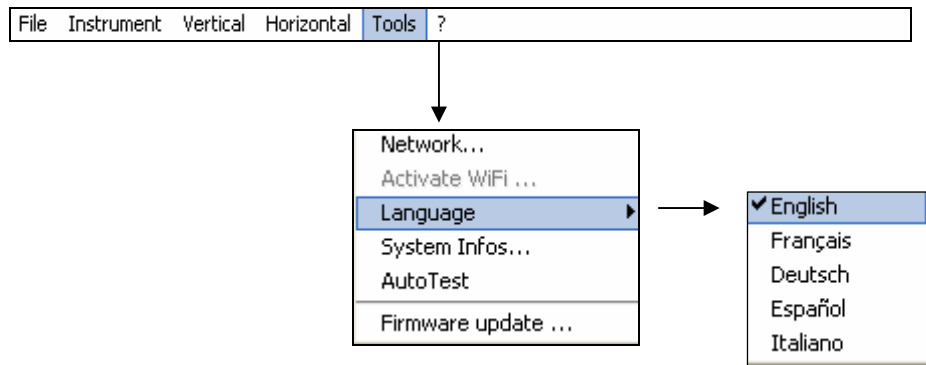

---

**The "?" Menu** Id. Oscilloscope instrument.

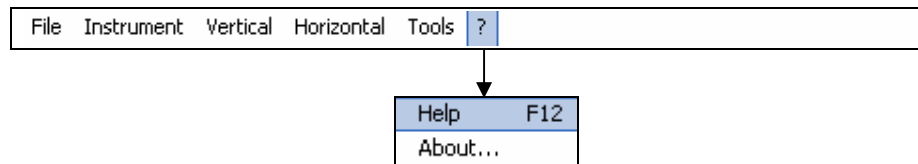



# Applications

## 1. Display of the calibration probe signal

- Connect the calibrator output (Probe Adjust 2.5 V, 1 kHz) to the CH1 input using a 1/10 measuring probe (for example).
- In the menu bar:
  - click on Instrument, select Oscilloscope
  - or click on the  icon to display the Oscilloscope Control window, as follows:

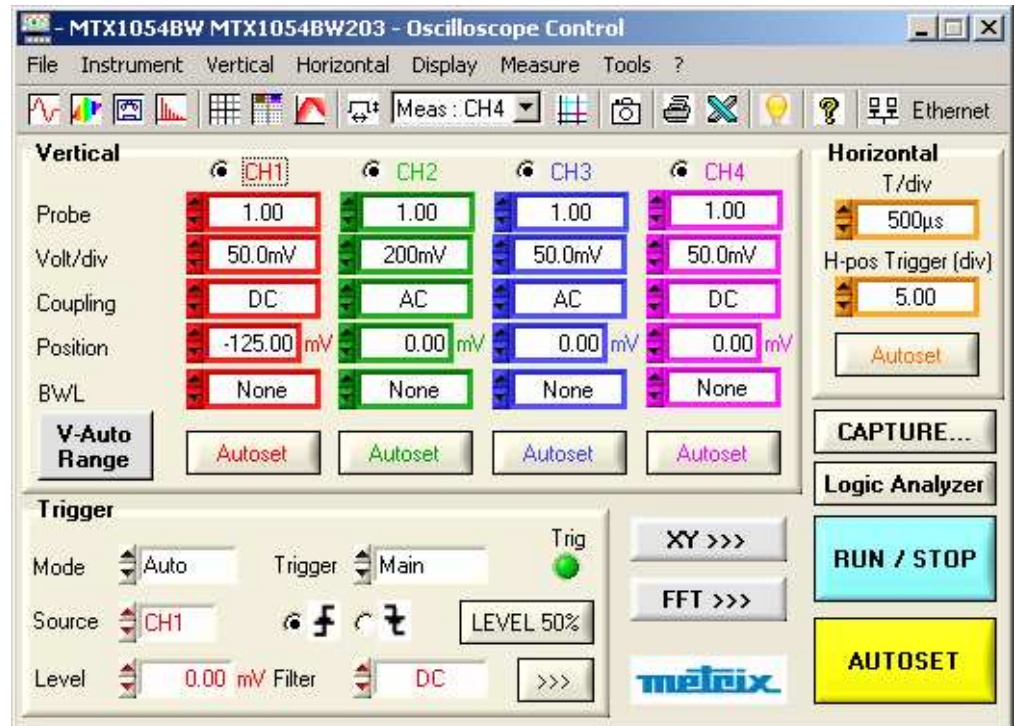

### In the **CH1 vertical** box :

- \* Validate the channel: **CH1**
- \* Probe: **1.00**
- \* CH1 V/div sensitivity: **50.0 mV** (1/10 probe)
- \* CH1 input coupling: **DC**
- \* Position: **-125.00 mV**
- \* BWL: **none**

### In the **Horizontal** box :

- \* T/div sweep coef.: **500 µs**
- \* H-pos Trigger: **5.00 div**

## Applications (contd.)

### In the Trigger box:

- \* Trigger mode: Auto
- \* Trigger source : CH1
- \* Trigger channel coupling: DC
  - Go into the Trigger menu to display the Trigger Settings window
  - or click on the rising edge  of the toolbar
  - or right click on the Trigger box on the control panel

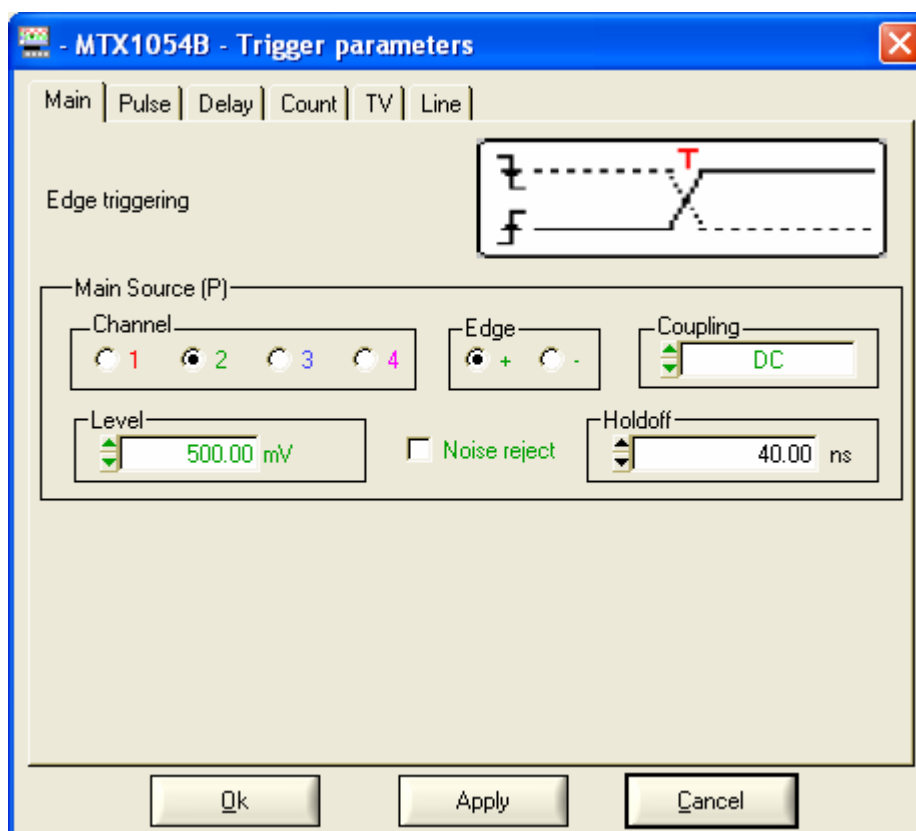

- \* Trigger level: 125.00 mV
- \* Click on the *RUN/STOP* button, launch acquisition (*RUN* is displayed under the Oscilloscope Trace window).
- \* Activate the manual *dt / dv* measurements.
- \* Position the cursors to measure the signal amplitude and frequency.

## Applications (contd.)

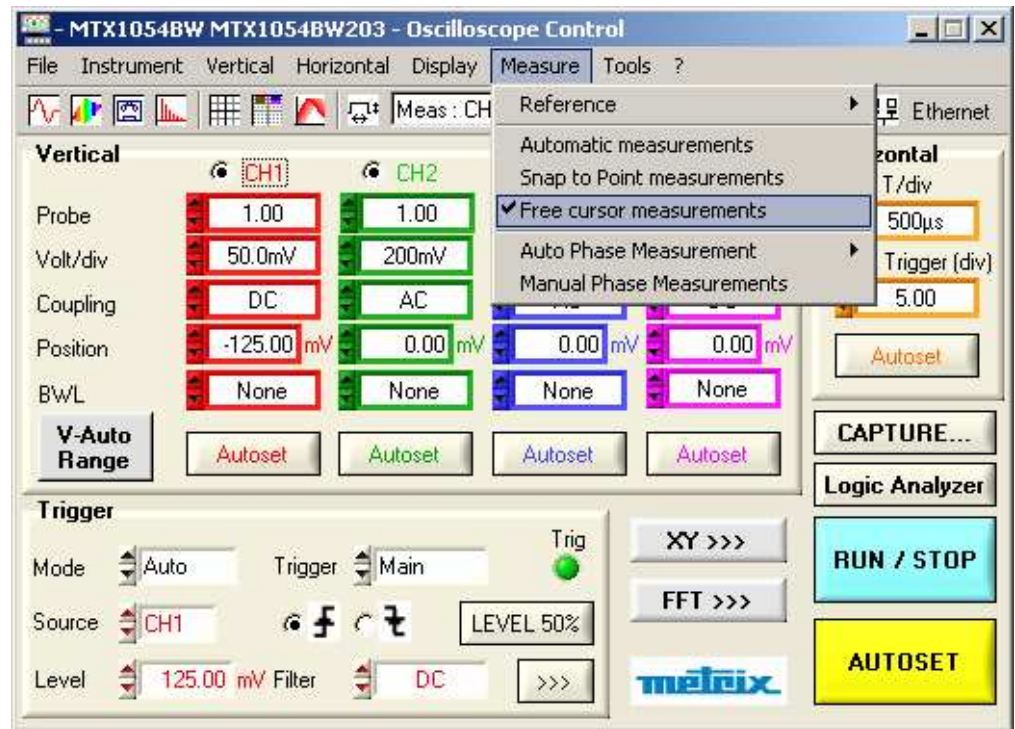

The calibrator output signal is displayed in the Oscilloscope Trace window:

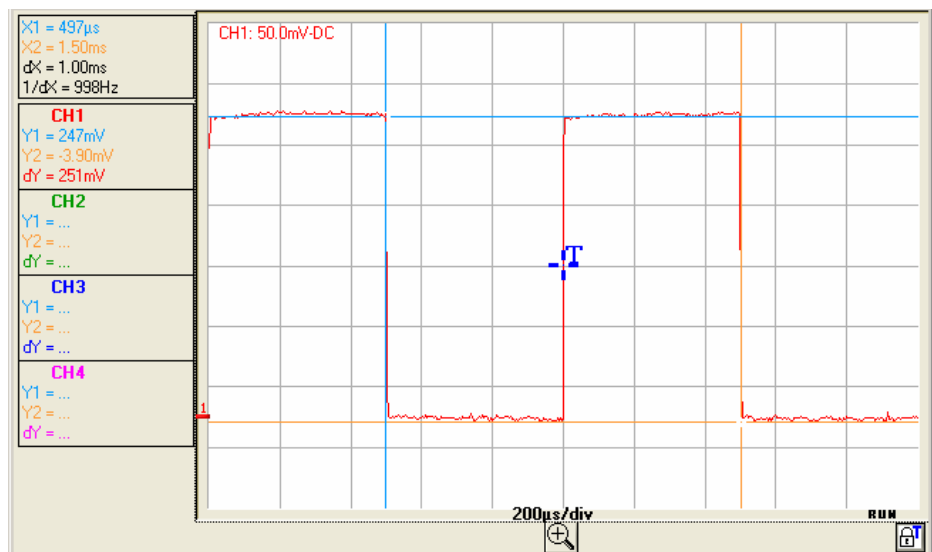

The amplitude of the signal given by the cursors (X1, Y1) and (X2, Y2) is  $dY = 251 \text{ mV}$  as the probe used attenuates by 10, the calibrator amplitude output is  $251 \text{ mV} \times 10 = 2.51 \text{ V}$  and the frequency,  $1 / dX = 998 \text{ Hz}$ .

---

## Applications (contd.)

---

### 2. Probe compensation

Adjust the audio frequency compensation of the probe so that the signal plateau is horizontal (see figure below).

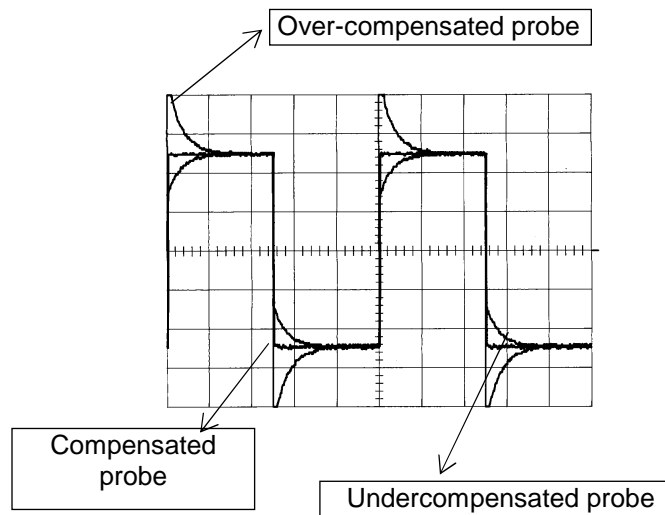

 Refer to the manual enclosed with the probe when making compensation.

## Applications (contd.)

### 3. Automatic measurement with compensation of the probe attenuation coefficient

- Connect the calibrator output (2.5 V, 1 kHz) to the CH1 input using a 1/10 measuring probe.
- For probe adjustments, see the §. Calibration signal display.
- Select the:
  - \* vertical calibre of CH1: **50 mV/div.**
  - \* the time base coef.: 200  $\mu$ s/div.
  - \* the vertical scale coef.: **10** ( $\rightarrow$  the calibre becomes **500 mV/div.**)
  - \* DC coupling: CH1
- Display the automatic measurement table for the channel **CH1** signal via the Measurement  $\rightarrow$  Automatic Measurements menu (see §. Measurement).

The table of the 19 measurements made on Trace 1 is displayed:

Parameter	Value
Vmin =	----
Vmax =	----
Vpp =	----
Vlow =	----
Vhigh =	----
Vamp =	----
Vrms =	----
Vavg =	----
Over+ =	----
Sum =	----
Trise =	0.000 s
Tfall =	20.00ns
W+ =	500.0 $\mu$ s
W- =	499.9 $\mu$ s
P =	1.000ms
F =	1.000kHz
DC =	50.0%
N =	2
Over- =	----

The peak-to-peak amplitude of the calibrator is given by **Vamp= 2.508V** and the frequency by **F = 1.000kHz**.

When no longer used, deselect the automatic measurements as they slow down the trace refreshment frequency.

To do this, close the **MTX1054 - 1: Automatic Measurements** window.

#### **Reminder**

*For greater measurement accuracy, display at least 2 periods for the signal and choose the calibre and vertical position to represent the peak-to-peak amplitude of the signal to be measured on 4 to 8 vertical divisions.*

---

## Applications (contd.)

---

### 4. Cursor measurements

Select measurement by cursors using the menu: Measurements → Free cursor measurements and Snap to point measurements (see §. Measurement menu).

- \* Two measurement cursors (1 and 2) are displayed as soon as the menu has been activated.
- \* The 2 measurements made are **dt** (dX interval between the 2 horizontal cursors X1 and X2) and **dv** (voltage difference dY between the 2 vertical cursors Y1 and Y2).

 *Example:* (1)dt = dX = 1.0 ms, dv = dY = 251.0 mV

## Applications (contd.)

### 5. Cursor dephasing measurements

#### a) Automatic phase measurement

- Initially, there must be 2 out-of-phase signals to be displayed on the channels.
- Select the reference trace in relation to which you want to perform the phase measurements via the menu:  
Measurement → Reference → Trace 1 or Trace 2  
(see §. Reference).  
Example: Reference Measurement → Trace 1.
- Select automatic phase measurement via the menu:  
Measurement → Auto Phase measurements (see §. Auto Phase measurement).  
Example: Auto Phase Measurement → CH2 / ref.
- The 2 markers (+, -) for automatic measurements are displayed on the reference trace (CH1). A "+" marker is displayed on the trace on which the phase measurements are made (CH2).
- The phase measurement (in °) is indicated under the display of values dX and dY.  
Example: CH1 / ref or CH2 / ref = 180.0°

*The instrument simultaneously displays the values of the 19 automatic measurements and the automatic (or manual) phase measurements.*

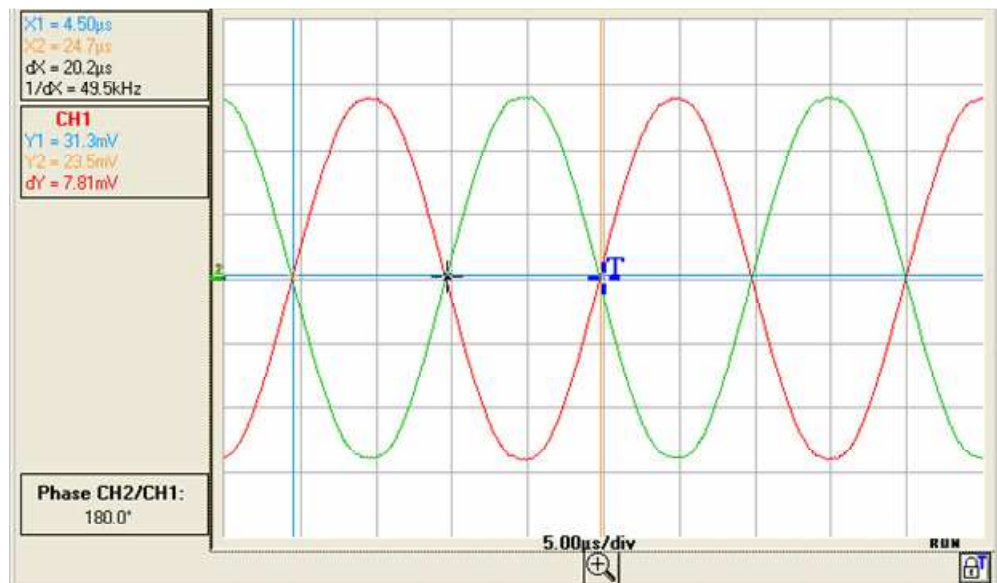

- The 3 markers are fixed; they cannot be moved.
- If it is not possible to perform the measurement, "-.-" appears.

## Applications (contd.)

### b) Manual phase measurement

- Select manual phase measurement via the menu: Measurement → Manual phase measurement (see § Measurement).
    - \* The 2 cursors (+, -) for automatic measurements are displayed on the reference trace (CH1). They must be positioned so that they declare the period (which corresponds to 360°). A "+" cursor with respect to which the phase measurement is made, will be displayed. This cursor can be moved in the Oscilloscope Trace display window.
    - \* The phase measurement (in °) is indicated under the display of the values dX and dY.
- Example: (1)Ph = 180.4°

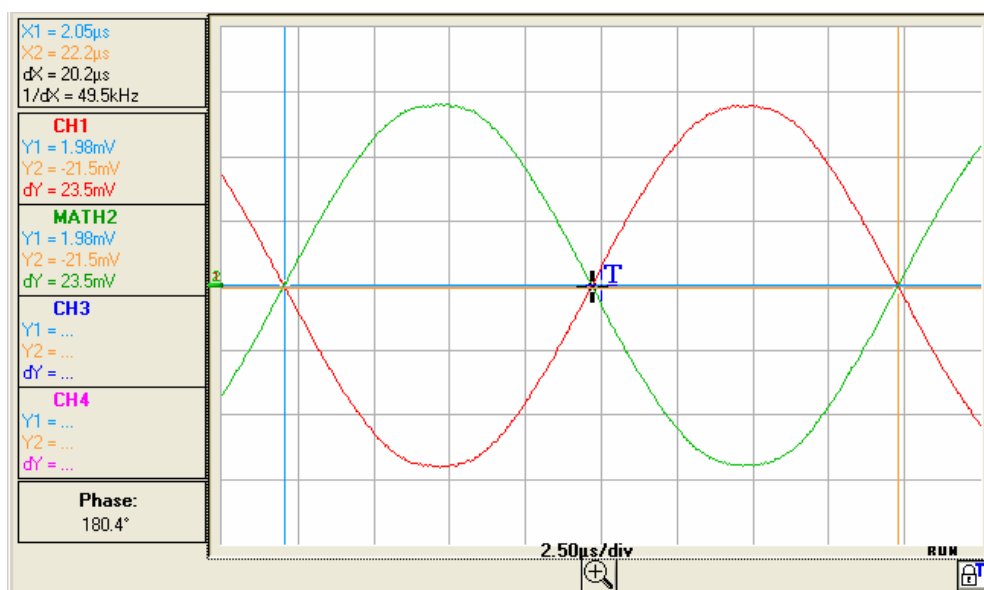

- The 3 measurement cursors are present if at least one trace is present on the screen.
- The 3 measurement cursors can be moved freely using the mouse.



---

## Applications (contd.)

---

### 6. Video signal display

This example illustrates the TV synchronisation functions and use of SPO mode for a complex signal.

 *It is recommended to use a 75  $\Omega$  adapter for observing a video signal.*

- Inject a composite TV signal into channel CH1 with the following characteristics:
  - 625 lines
  - positive modulation
  - vertical grey scale stripes
- Select channel CH1.
- On the Trigger window, select , and then the “Main” tab
- Validate channel 1 as the main trigger source.
- Select the TV tab.
- Set:
  - the number of standard lines to 625 lines (SECAM) or 525 lines (PAL, NTSC) according to the standard used.
  - the polarity to +
  - the line N° to 25.
- Select the CH1 coupling: **DC**
- Vertical position: **- 600mV**
- Select the CH1 V/div sensitivity: **200mV**
- Set the T/div sweep coef. to: **25 $\mu$ s**
- Select automatic trigger
- Select the display: **Envelope**

## Applications (contd.)

- Click on the RUN/STOP button to start acquisition.

The acquisition status (Ready, RUN, STOP) is indicated on the right, under the display of the trace, in the trigger status display zone.

- Optimize the time base speed to observe several complete TV lines.

 Example of a video signal (MTX1054)

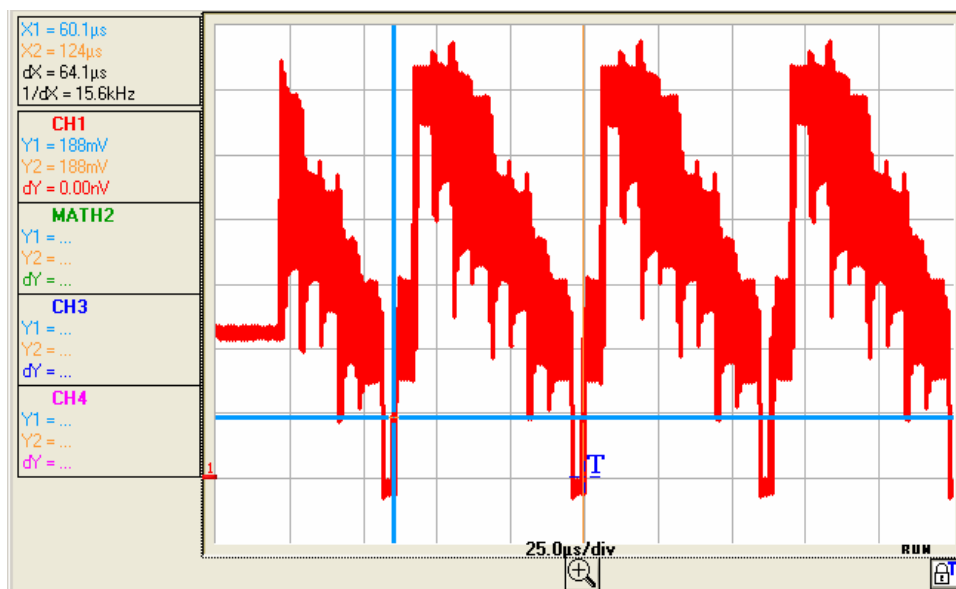

Use the manual cursors to check the duration of a line (64 μs)

- Display the manual cursors by clicking on the icon :  
or from the menu bar Measurement → Manual measurement (dt, dv)
- With the mouse, position cursors 1 and 2 respectively on the beginning and end of a line.

The dv and dt measurements between the 2 cursors are indicated top left in the trace display zone.

 Example:  $dX = 64.1 \mu\text{s} = \text{duration of a line}$

## Applications (contd.)

### 7. Examination of a specific TV line

For more detailed examination of a video line signal, the TV trigger menu can be used to select a specific line number.

- In the Trigger window, select **FFT >>>**, and then the „TV” tab.
- Set:
  - the standard number of lines: 625 lines for the SECAM standard
  - the polarity: + (video positive)
  - line: 25
- Select the sensitivity of CH1: 200 mV/div
- Select the sweep coef.: 25  $\mu$ s/div. with the T/div time base box scroll bar
- Select SPO persistence mode  to observe details of the video signal.

#### Example of video line 25

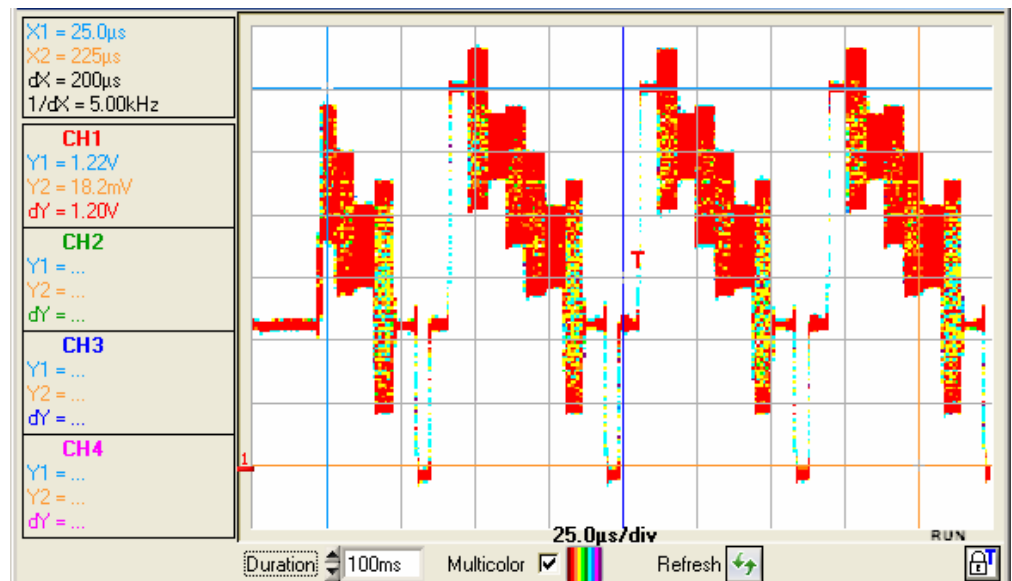

---

## Applications (contd.)

---

### 8. Measurement in "Analyser" mode

Initially, a frequency signal between 40 Hz and 1 kHz should be injected on channels CH1, CH2, CH3 or CH4.

#### Reminder

- Only CHx channel signals (and not the Mathx functions) can be the subject of harmonic analysis.
- In Analyser mode, the time base is not adjustable.
- Set the amplitude of the channels in Oscilloscope mode correctly (the signals displayed should not be saturated).
- On the **Instrument** menu, select **Analyser** or click on the  icon on the toolbar.

#### Reminder

The harmonic content of the signal for channels CH1, CH2, CH3, CH4 is represented by "full" bars in the colour of the channel (red for CH1, green for CH2, blue for CH3 and pink for CH4).

- The SIGNAL box under the breakdown indicates:
  - the active channel(s)
  - the RMS voltage of the signal in Volts
  - harmonic distortion rate (in %) of the signal
- The Reference box enables the reference harmonic to be selected for the measurements.

## Applications (contd.)

- The “Ref.: Harmonic X” box indicates, for the harmonic selected:
  - its value as a % of the fundamental
  - its phase in ° in relation to the fundamental
  - its frequency in Hz
  - its RMS voltage in Volts

*Example of harmonic breakdown (MTX 1054)*

*Inject on:*

- CH1: the signal of the output calibrator (2.5 V, 1 kHz) (see §. Display of the calibration signal)
- CH2: a 200 kHz triangular signal with a peak-to-peak amplitude of 1V.

**Display of the CH1-CH2 signals in Oscilloscope mode**

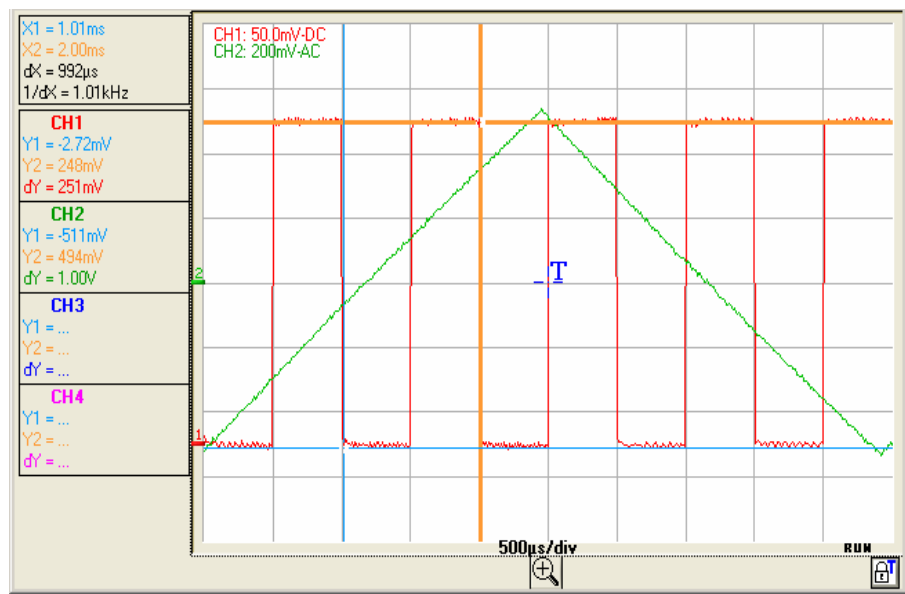

**Harmonic Analysis Display Analyser mode**

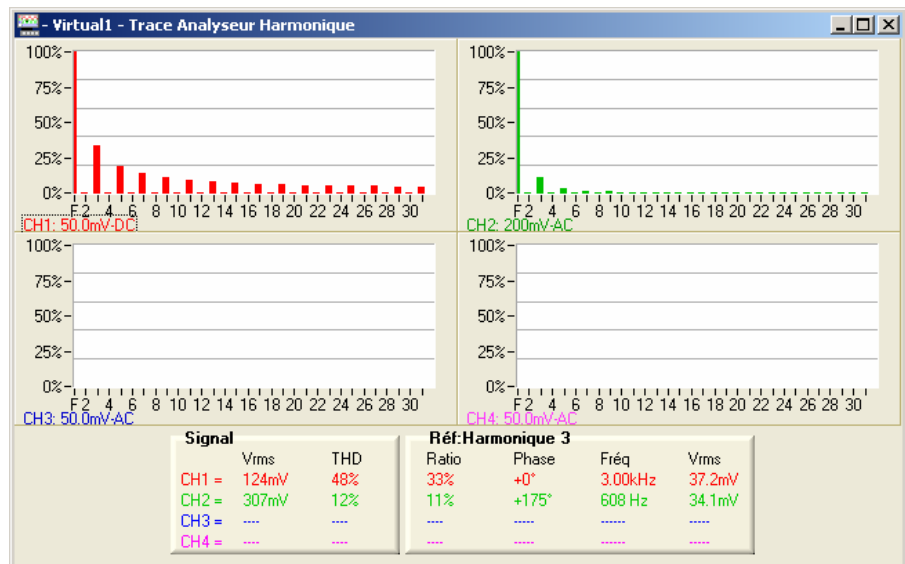

Note that, for the CH1 signal (square 1 kHz signal), the amplitude of harmonic 3 (at 3 kHz) represents 33% (ratio) of the fundamental and, for the CH2 signal, the frequency of harmonic 3 is 608 Hz.



## Applications (contd.)

### 9. Display of slow events ROLL Mode

✎ Examination of a slow event

The purpose of this example is to analyse slow events for time bases ranging from 200 ms to 200 s per division.

Samples are displayed during acquisition without waiting for the Trigger (Roll mode).

- Select Oscilloscope mode, on the Instrument menu .
- Inject a 1 V peak-to-peak 1 Hz sine wave signal on the CH1 input.
- Adjust the time base to 500 ms.
- Select channel CH1.
- Select the sensitivity and coupling for CH1:
  - Sensitivity: **200 mV/div**
  - Coupling: **DC**
- Select the trigger parameters:
  - Trig → Parameters menu:
    - Trigger source: **CH1**
    - Trigger edge: **+**
- Select the Single Shot trigger mode.
- Click on the  icon to authorise selection of the trigger in the trace window. . Position the Trigger level to + 4 div and start acquisition with the RUN/STOP button:
 

The signal is acquired continuously, move the trigger in the display window until 0 div is reached to obtain a trigger event.

*When the trigger level is reached, the oscilloscope stops acquisition after filling the memory (it switches to STOP mode), keeping to the pre-trigger defined by the horizontal position of the trigger.*
- To restart acquisition, reset the trigger by clicking on the RUN/STOP button.

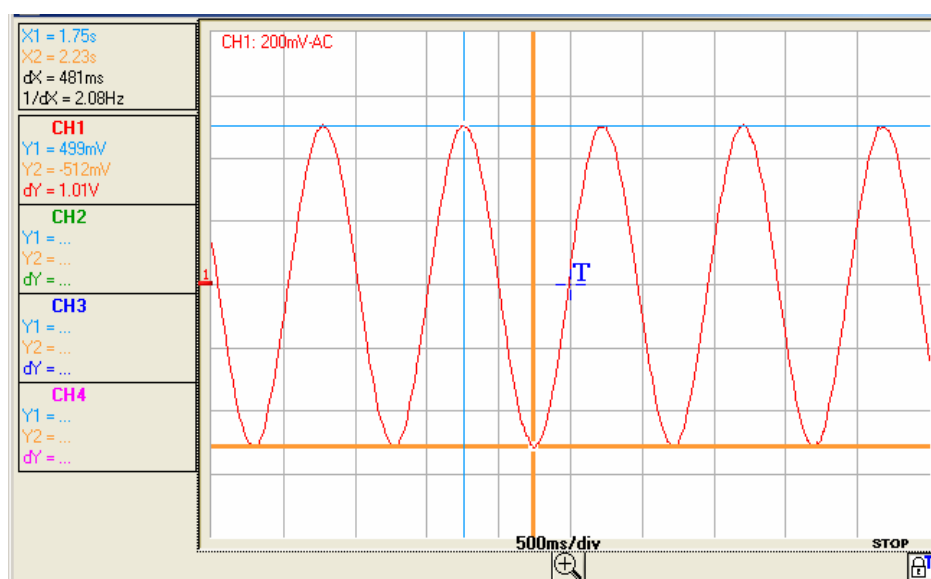

Examination of the signal (MTX 1054)





## Applications (contd.)

### 10. Measurement in "Recorder" Mode

 Example:  
*Monitoring of voltage variance and detection that a level has been passed*

- Select Recorder mode with the  icon or Instrument menu.
- Check that Capture Fault 1 is activated (see Trigger menu).
- Inject the signal to be monitored on CH1.
- Select the CH1 input.
- Adjust the vertical sensitivity ( 2 V/div).
- Adjust the recording period or the sampling interval ( 1 min)
- Adjust the trigger settings on the Recorder Control panel: threshold type and level.

 Example

**Greater than** trigger on channel CH1 represented by the symbol  $\uparrow 1^T$  with a level 1 ( 6 V).

On the other channels, select: "no triggering".

Start acquisition by clicking on the RUN/STOP button.

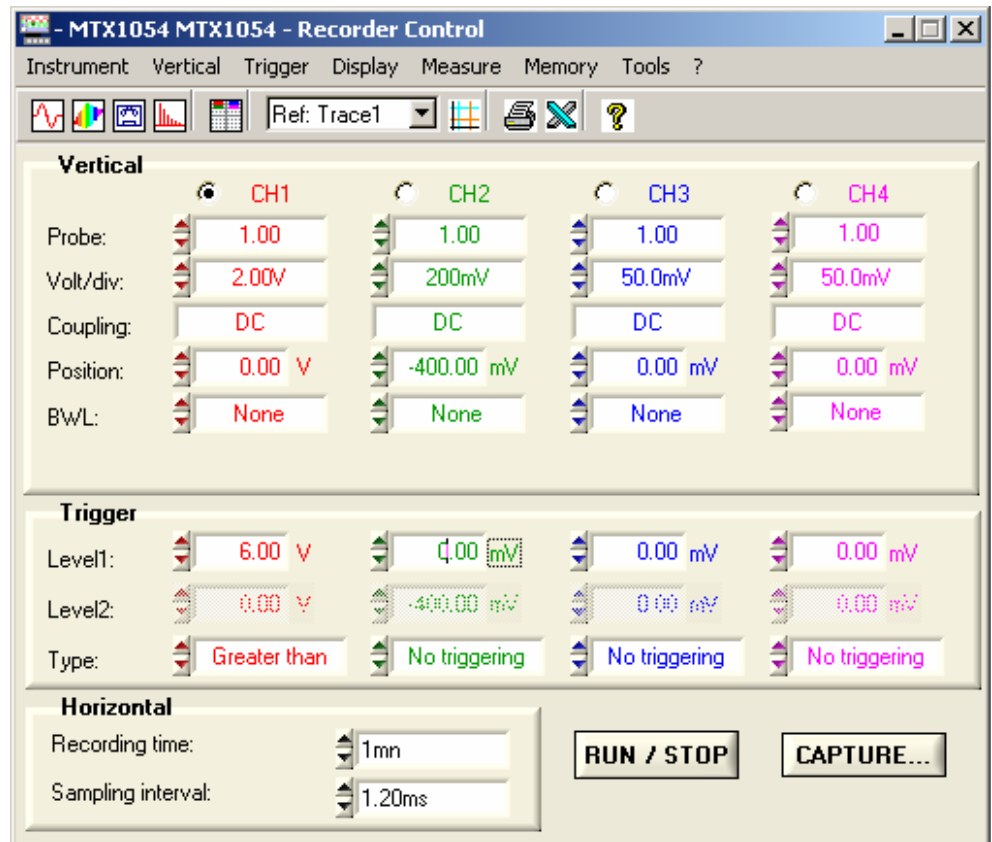

## Applications (*cont'd*)

- On channel CH1, inject a sine wave signal with a frequency of 0.1 Hz and a peak-to-peak amplitude of 3V.
- Suddenly increase the signal amplitude to exceed a threshold of 6 V, then return to the initial amplitude.
- Acquisition of the amplitude fault will be implemented since the “Greater than” threshold of 6V has been exceeded.

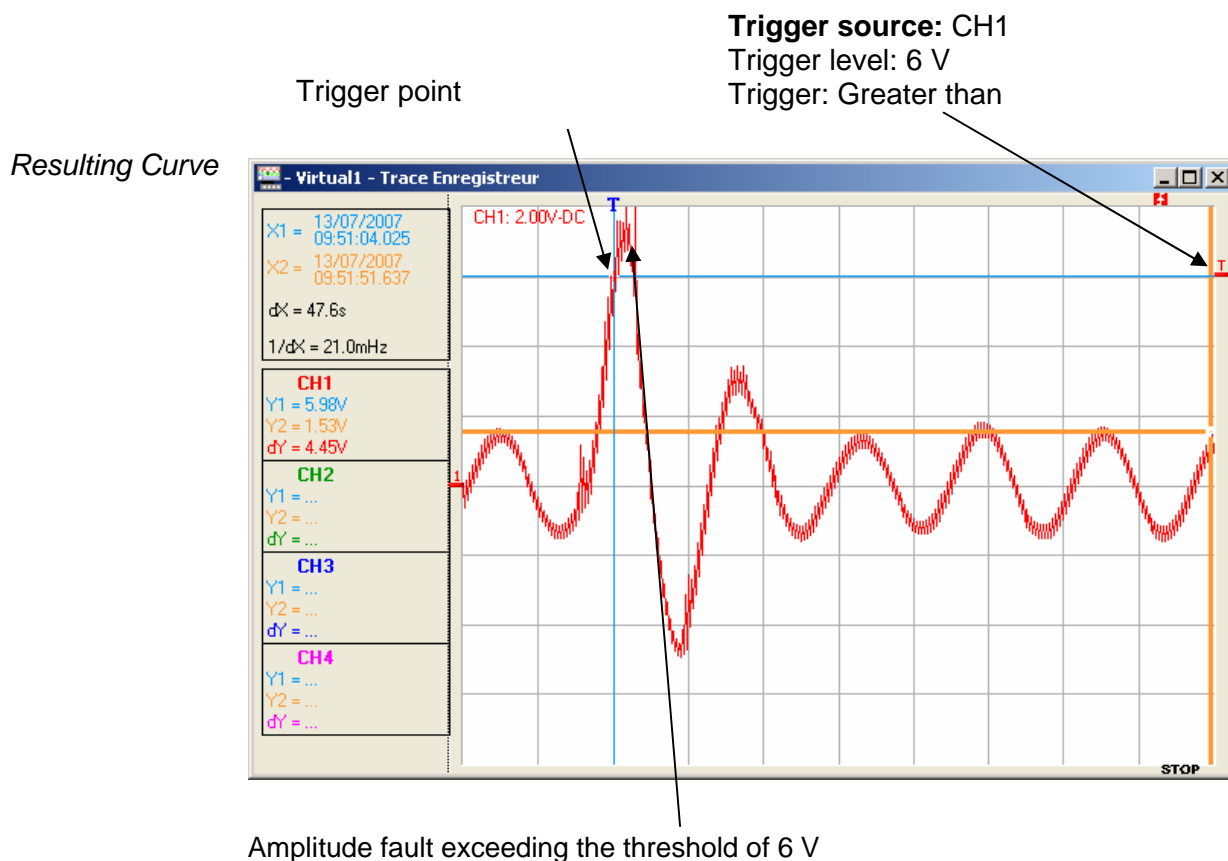

Acquisition was triggered when the signal went above the 6 V trigger level, the fault was captured, respecting a pre-trigger of 2 divisions.



# Applications (contd.)

## 11. ETHERNET network applications

### Printing on a network printer

To start printing of the various active windows on a network printer from the PC:

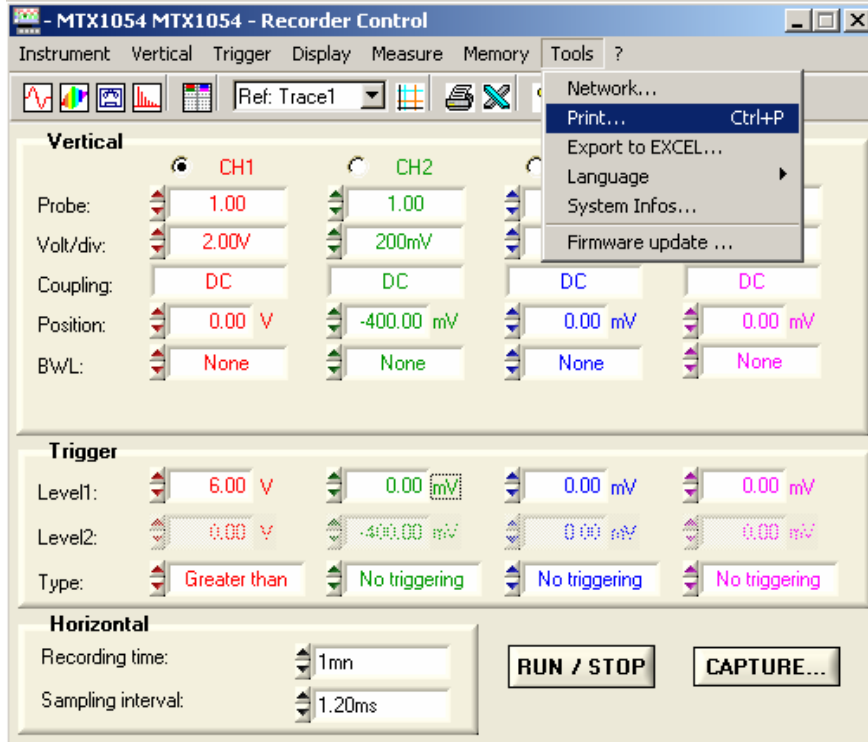

### Printing

- On the "Tool" menu, select Print ... or
- Click on the  icon on the toolbar
- Select the type of printer from those installed on your PC.
- Check the elements to be printed from those available.
- Choose Portrait or Landscape print orientation.
- Click on **OK** to start printing.

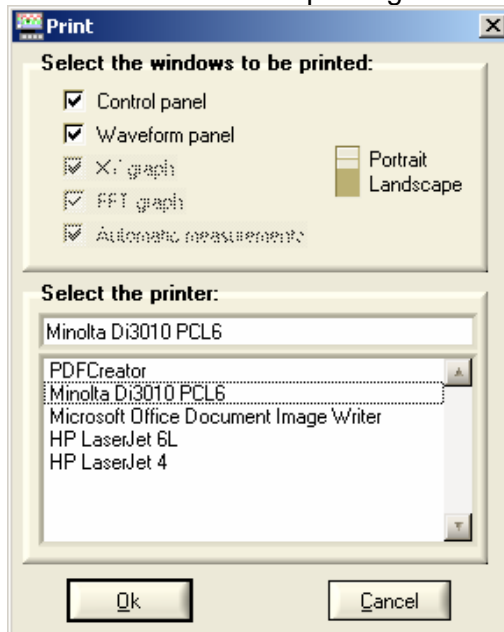

## Applications (contd.)

### 12. WEB Server

Minimum PC Configuration:

Pentium II, 200 MHz, 64 Mb RAM.  
Screen resolution: > 1152 x 864 pixels  
Install JVM SUN (minimum version  
J2RE 1.4.2) from site //java.sun.com

Recommended browsers:

Internet Explorer 6.0 or Netscape 6.0

Screens obtained on PC logged on to same network as the instrument.

### Oscilloscope mode

Instrument IP address: see p. 12

Clicking on the title of the window with the mouse refreshes the window.

The window settings are taken into account after clicking on "Remote Control".

# Applications (contd.)

## FFT Mode

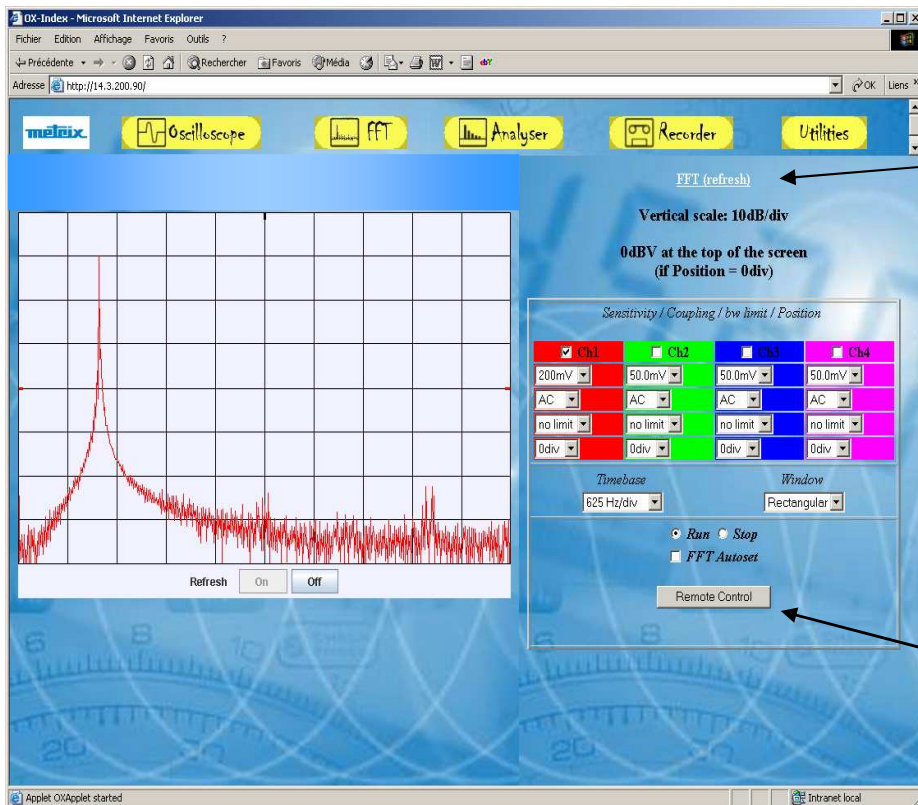

Clicking on the title of the window with the mouse refreshes the window.

The window settings are taken into account after clicking on "Remote Control".

## Analyser mode

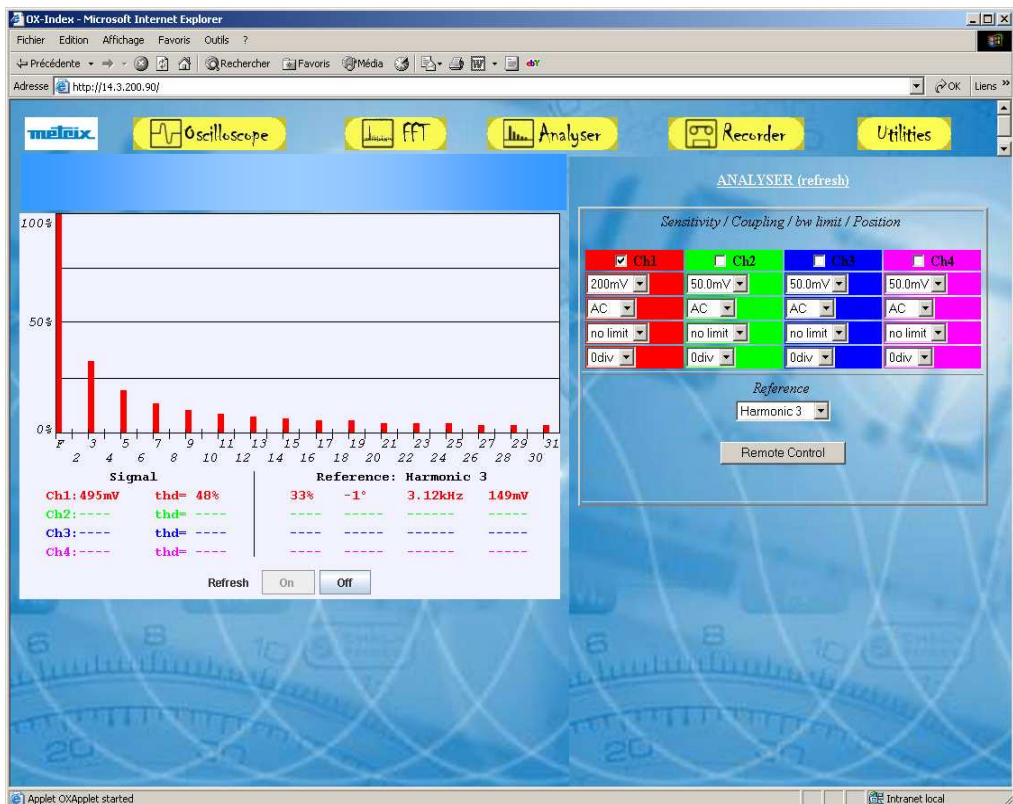

## Applications (contd.)

### Recorder Mode

The screenshot shows the Recorder Mode interface in a web browser. The interface includes a grid with a red waveform, a 'Recorder (refresh)' button, and a settings panel. The settings panel has the following sections:

- Sensitivity / Coupling / bw limit / Position:** A table with columns for Ch1, Ch2, Ch3, and Ch4. Each column has dropdown menus for Sensitivity (e.g., 200mV, 50.0mV), Coupling (no limit), bw limit (no limit), and Position (0div).
- TRIGGER: Main level / Aux level / Type:** A table with columns for Ch1, Ch2, Ch3, and Ch4. Each column has dropdown menus for Main level (0div), Aux level (0div), and Type (No trig).
- Recording time:** A dropdown menu set to 2s.
- Recording mode:** Radio buttons for 'Run' and 'Stop'.
- Fault detection:** A checkbox and a 'List of faults' button.
- Remote Control:** A button at the bottom of the settings panel.

Annotations with arrows point to the 'Recorder (refresh)' button and the 'Remote Control' button. A note (\*) indicates that window settings are taken into account after clicking on 'Remote Control'.

Clicking on the title of the window with the mouse refreshes the window

(\*) The window settings are taken into account after clicking on "Remote Control".

(\*) After refreshing the window, this list indicates the moment of acquisition of all the faults:

- in Capture 1 Fault mode: a single fault is acquired,
- in Capture 100 Faults mode: 100 faults can be acquired, they are viewed in blocks of 10 faults.

# Applications (contd.)

## Utilities

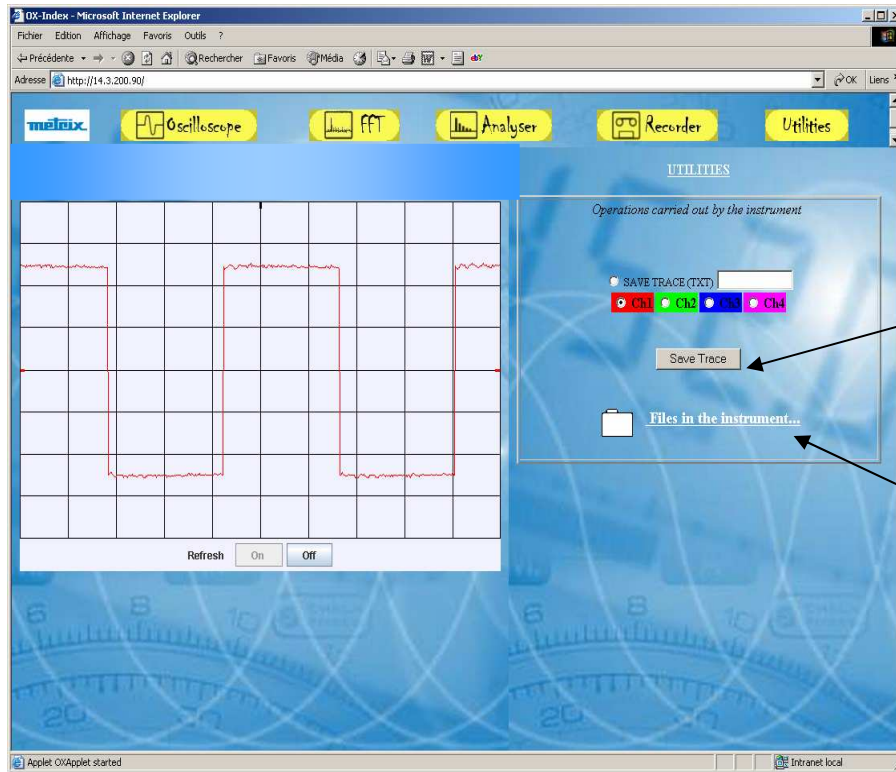

The selection button determines the action: Saves the Trace

FTP window display indicating the files contained on the instrument's virtual disk See next.

## File transfer

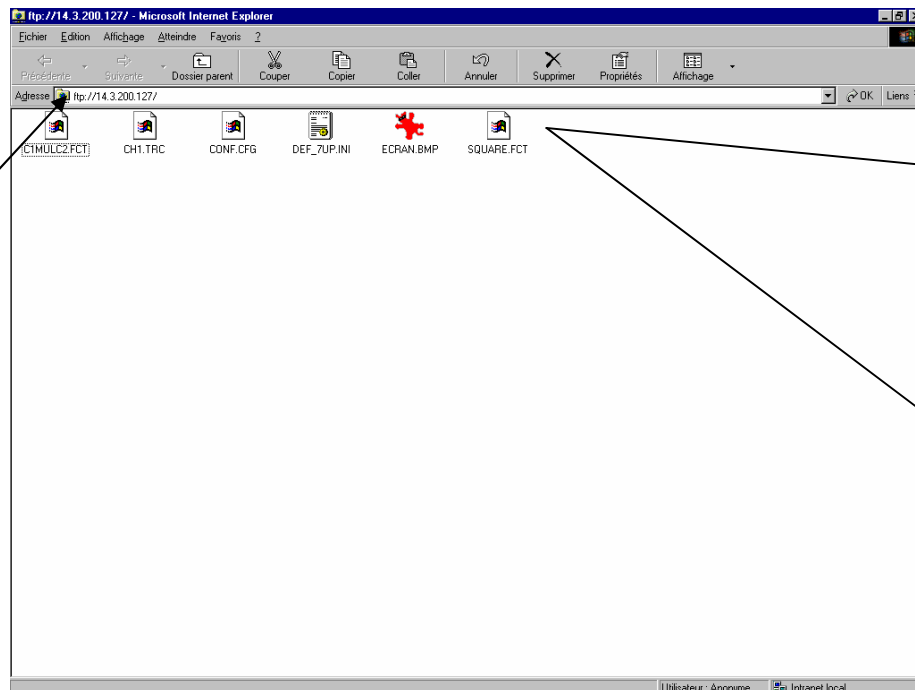

Instrument IP address

FTP window display indicating the files contained on the instrument's virtual disk.

The files can be copied onto the PC using classic Windows commands.

## Technical Specifications - Oscilloscope Mode

**Vertical deviation** Only the values assigned with a tolerance or limits are guaranteed values (after ½ h warm-up). Values without a tolerance are for information only.

<b>Characteristics</b>		<b>Specifications</b>	<b>Comments</b>
<b>Nr. of channels</b>	<b>MTX 1054B/C</b> <b>MTX 1052B/C</b>	4 channels: CH1, CH2, CH3 & CH4 2 channels: CH1, CH2, EXT	
<b>Input Type</b>		Class 1, common earths	
<b>Bandwidth at -3dB</b>		> 150 MHz (200 MHz <sup>1</sup> ) on all vertical ranges from 5 mV to 5 V/div. ≥ 15 MHz on the 2.5 mV/div. range ≥ 15 MHz on ranges from 10 V/div. to 100 V/div. → ⚠	Measured on 50 Ohm load with 6 div. amplitude signal
<b>Vertical offset dynamic</b>		± 10 divisions on all ranges	
<b>Input coupling</b>		AC: 10 Hz to 150 MHz (200 MHz <sup>1</sup> ) DC: 0 to 150 MHz (200 MHz <sup>1</sup> ) GND: reference	
<b>BWL bandwidth limit</b>		4 values: none, 15 MHz, 1.5 MHz, 5 kHz	
<b>Rise time</b>		< 23 ns for the vertical calibre 2.5 mV/div. < 3 ns (< 2 ns <sup>1</sup> ) on all vertical ranges from 5 mV to 100 V/div.	
<b>Cross-talk between channels</b>		DC at 100 MHz ≥ 30 dB	- for ranges with a bandwidth > 150 MHz - same sensitivity on both channels
<b>ESD tolerance</b>		± 2 kV	
<b>Response to rectangular signals: 1 kHz and 1 MHz</b>		Overshoot < 5% on the rising or falling edge Aberrations < 5 %	
<b>Vertical calibre accuracy</b>		± 2 %	Sequence of vertical ranges 1 - 2 - 5
<b>Vertical resolution</b>		± 0.2 % of full scale	Variation in steps
<b>DC vertical measurement accuracy</b>		± [2 % (reading – offset) + precision of vertical offset + (0.05 div.) x (V/div.)]	
<b>Accuracy of vertical offset</b>		± [0.01 x (offset value) + 4 mV + (0.1 div.) x (V/div.)]	
<b>Probes</b>		Take into consideration the attenuation factor of the probe in display: (⚡ : with a 1/10 attenuating probe, set the Probe coefficient to 10 for direct display of the signal amplitude at the end of the probe) probe coefficient variation range: 0.00001 to 100000.00	<i>NB: the probe factor must be brought in manually. There is no automatic detection of probe presence.</i>
<b>Maximum input voltage</b>		420 Vpk (DC + AC peak at 1 kHz) without probe 1400 Vpk (DC + AC peak at 1 kHz) with probe 1/10 ref. HX0004 or /5	
<b>Electrical safety</b>		300 V, CAT II without probe 1000 V, CAT II with probe 1/10 HX0004 or HX0005	
<b>Input impedance</b>		1 MΩ ± 1 % approx. 13 pF	
<b>Display modes</b>	<b>MTX 1052B/C</b> <b>MTX 1054B/C</b>	CH1, CH2, MATH3, MATH4 CH1, CH2, CH3, CH4	

<sup>1</sup> MTX 105xC

## Technical specifications - Oscilloscope Mode (contd.)

### Processing of measurements

<b>Mathematical functions</b>	Equation editor Addition, subtraction, multiplication, division and complex functions between channels.	
<b>Automatic measurements</b>	<b>Time measurements</b> rise time fall time positive pulse negative pulse cyclic ratio period frequency phase. counting	<b>Level measurements</b> DC voltage rms voltage peak-to-peak voltage amplitude max. voltage min voltage high plateau low plateau overshoot  integral
Resolution of the measurements	9 bits	

### Horizontal deviation (time base)

Characteristics	Specifications	Comments
<b>Time base ranges</b>	35 ranges, from 1 ns to 200 s/div.	Sequence 1 - 2 - 5
<b>Time base accuracy</b>	± 0.5 %	
<b>Single shot sampling rate</b>	<b>MTX 1054B/C</b> 100 MS/s on 4 channels 200 MS/s on 2 channels → 1 out of CH1/CH2 → 1 out of CH3/CH4  <b>MTX 1052B/C</b> 100 MS/s on 2 channels 200 MS/s on 1 channel → 1 out of CH1/CH2	} Accuracy ± 200 ppm
<b>Time measurement accuracy</b>	± [0.04 div.) x (time/div.)] + 0.005 x (reading) + 1 ns]	
<b>Horizontal ZOOM</b>	The available horizontal zoom factors range from x1 to x100 according to the sequence 1-2-5 (in ZOOM mode, we have the same time base criterion sequence as in normal mode).	<i>N.B.: The oscilloscope has a memory capacity for recording 50 k points per channel. The horizontal screen display is 500 points for 10 divisions.</i>
<b>XY Mode</b>	The bandwidth in X and Y is identical	
<b>Bandwidth in X and Y</b>	150 MHz (200 MHz <sup>2</sup> )	
<b>Phase error</b>	< 3° at 1 MHz	
	<b>In XY mode, at each instant t:</b> The smallest time increment between two successive XY points is given by the real acquisition frequency of the oscilloscope. XY mode representation therefore depends on the selected time-base range.	
<b>Cursor measurements</b>	Manual measurement cursors dt, dv	

<sup>2</sup> MTX 105xC

## Technical specifications - Oscilloscope Mode (cont'd)

### Trigger circuit

Characteristics	Specifications	Comments
<b>Trigger sources</b>	<b>MTX 1052B/C</b> CH1, CH2, EXT, Line <b>MTX 1054B/C</b> CH1, CH2, CH3, CH4, Line	
<b>Trigger mode</b>	Automatic Triggered Single shot	
<b>Trigger coupling without band limit</b>	AC: BW 10 Hz to 150 MHz (200 MHz <sup>3</sup> ) DC: BW 0 to 150 MHz (200 MHz <sup>3</sup> )  HF reject: BW 0 to 10 kHz LF reject: BW 10 kHz to 150 MHz	
<b>Trigger gradient</b>	<b>Falling edge or</b> Rising edge	
<b>Trigger sensitivity Sources</b> <b>Input coupling: DC</b> <b>Trigger channel coupling: DC</b>	0.6 div. from 0 to 10 MHz 1.5 div from 10 MHz to 150 MHz (< 3 div. from 150 to 200 MHz <sup>3</sup> ) (if "noise rejection" → inactive) 1.5 div. at 1 kHz (if "noise rejection active")	Amplitude of the signal observed on the screen
<b>Trigger level Variation range</b>	± 8 div.	
<b>Trigger type</b>	on edge on pulse width      < t    ≈ t    > t      from 20 ns to 10.5 s  <u>Trigger after delay</u> of 40 ns to 10.5 s <b>MTX 1052B/C →</b> • Qualifier source: CH1 CH2 EXT • trigger source: CH1 CH2  <b>MTX1054B/C →</b> • Qualifier source: CH1 CH2 CH3 CH4 • trigger source: CH1 CH2 CH3 CH4  <u>Trigger after counting</u> 2 to 16,384 events <b>MTX 1052B/C →</b> • Qualifier source: CH1 CH2 EXT • counting source: CH1 CH2 EXT  <b>MTX1054B/C →</b> • Qualifier source: CH1 CH2 CH3 CH4 • trigger source: CH1 CH2 CH3 CH4	
<b>MTX 1052B/C, MTX1054B/C →</b>	<u>TV</u> - Polarity selection: + and - - Line N°selection: 525 lines (NTSC) or 625 lines (PAL/SECAM) - TV trigger sensitivity: > 1 div.	
<b>Pre-triggering</b>	Adjustable from 0 to 100 %	
<b>HOLDOFF</b>	Adjustable from 40 ns to 10.5 sec.	

<sup>3</sup> MTX 105xC



## Technical specifications - Oscilloscope Mode (contd.)

### Acquisition chain

<i>Characteristics</i>	<i>Specifications</i>	<i>Comments</i>
<b>ADC Resolution</b>	9 bits (22 LSB/div.)	1 converter per channel
<b>Sampling rate frequency</b>	100 MS/s	
<b>Sampling modes Real time</b>		
<b>MTX1054B</b>	200 MS/s max. on 2 channels	} Single non-repetitive signals Accuracy ± 200 ppm
<b>MTX1052B</b>	200 MS/s max. on 1 channel	
<b>MTX1054B/C</b>	100 MS/s max. on 4 channels	
<b>MTX1052B/C</b>	100 MS/s max. on 2 channels	
<b>Equivalent time ETS</b>	100 GS/s max.	Repetitive signals Accuracy ± 200 ppm
<b>Transient capture</b>		Whatever time base is used, short-term events (Glitch, ≥ 10 ns) are displayed.
<b>Minimum detectable Glitch width (min/max acquisition)</b>	≥ 10 ns	
<b>Acquisition memory depth</b>	50 kb	fixed
<b>PRETRIG function</b>	from 0 kbyte to 50 kbytes	
<b>Back-up memories of channels</b>	Channels are saved onto the PC hard disk: The maximum number of files that can be saved therefore depends on the configuration of the PC used.	
<b>Back-up memories</b>	Size of the storage memory = PC hard disk: File types: - trace - text - config - function - printout - image - etc.	The file names contain 15 characters + extension
<b>Storage formats (file sizes)</b>	Trace (.TRC) (≈ 200 kb) (.TXT) (≈ 500 kb)	Back-up of trace and acquisition parameters
	Configuration (.CFG) (≈ 15 kb)	Back-up of complete equipment configuration
	File (.FCT) (< 1 kb)	Back-up of a function

## Technical specifications - Oscilloscope Mode (contd.)

### Display

Characteristics	Specifications	Comments
Display screen	PC screen	
Resolution	The Oscilloscope Trace window represents 500 samples acquired with a 9-bit ADC. The number of abscissa and ordinate axes is calculated according to the size of the Oscilloscope Trace display window. Linear interpolation is used if necessary.	
Displayed mode window Normal	Complete memory represented on the screen for 500 abscissas.	50 kb
Horizontal ZOOM	from 1 to 100 up to 500 pts from the full memory of 50 kpts	case of max. ZOOM x 100
Display modes	Acquired points, interpolated points, averaging <b>Vector</b> The acquired points are attached by a segment. <b>Envelope</b> Min. and max. on each horizontal screen position are displayed. <b>Average rate</b> Factors: none, 2, 4, 16, 64	
Graticule	Complete Axes Borders	
Indications on screen	<b>Triggering</b> The trigger point is represented on the trace in the colour of the $T_{AC}$ channel in order to simultaneously indicate: The level in the range +/- 10 vertical divisions (with overshoot indicator) The horizontal position of the trigger point in the range of 0 to 10 divisions. The trigger filter ( $\otimes$ Channel CH1: $T - T_{AC} - T_{LF} - T_{HF}$ ).  <b>Traces</b> Trace identifiers Position, Sensitivity Earth reference Top and bottom trace reference overshoot indicators.	

### Miscellaneous

Calibration signal	Form Amplitude Frequency	rectangular 0 - 2.5 V $\pm$ 2 % 1 kHz $\pm$ 1 %
Autoset	<b>Search time</b> < 5 s <b>Frequency range</b> 30 Hz to 150 MHz (200 MHz <sup>4</sup> ) <b>Range of amplitude</b> 40 mVpp to 400 Vpp <b>Cyclic ratio limits</b> from 20 to 80 %	

<sup>4</sup> MTX 105xC

## Technical specifications - **Harmonics Analysis Mode**

<b>Display of the fundamental and Harmonics</b>	The fundamental and the first 31 harmonics of the signal present on the channels are simultaneously displayed.
<b>Selection of the reference for measurement</b>	The fundamental or a harmonic can be selected from the 31.
<b>Frequency of the signal analyzed</b>	40 Hz to 1 kHz
<b>Measurement accuracy</b>	
<i>Level of Fundamental</i>	± 2% ± +10 D
<i>Level of Harmonics</i>	± 3% ± +10 D
<i>Harmonic Distortion</i>	± 4 %

## Technical specifications - **Recorder Mode**

<b>Recording period</b>	from 2 seconds to 31 days
<b>Sampling rate</b>	from 40 μs to 53.57 s (Capture 1 Fault mode)
<b>Capture 1 fault</b>	100 faults in the working memory
<b>Capture 100 faults</b>	
<b>File capture</b>	Recording capacity = PC capacity
<b>Triggering</b>	on upper and lower threshold } on upper or lower threshold } for each active channel
<b>Display</b>	Search for minimum and maximum Fault search
<b>Vertical, horizontal accuracy</b>	Identical specifications to those in "Oscilloscope" mode

---

## Technical Specifications (contd.)

---

### Communication interfaces

---

<b>USB connector type B</b>	connects the oscilloscope to the PC with a USB lead.
<u>Location</u>	on rear panel of the oscilloscope
<u>Interface</u>	USB 1.1
<u>Driver</u>	The USB interface driver is available on the CD ROM supplied with the instrument.

---

<b>ETHERNET interface</b>	<u>Location</u>	on rear panel of the instrument
	<u>Type</u>	10BASE-T (Twisted Pair)
	<u>Connector</u>	RJ 45 8 points
	<u>Standard</u>	IEEE 802.3

---

#### WiFi interface

<u>Category</u>	IEEE 802.11b/g
<u>Frequency range</u>	2,400 - 2,484 GHz
<u>Output power</u>	14 + 2 / -1,5 dBm
<u>Data speed</u>	11 Mbps
<u>Modulation</u>	DSSS, DBPSK, DQPSK, CCK, OFDM, 16QAM, 64QAM
<u>Safety</u>	WEP 64/128, WPA, WPA2/802.11i
<u>Max. receipt level</u>	-10 dBm (with PER < 8 %)
<u>Receipt sensitivity</u>	- 88 dBm

---

### Remote programming of the oscilloscope by a PC

---

The oscilloscope can be remotely programmed with a PC from simple standardised commands using:

- the USB interface
- the ETHERNET interface (port 23)
- the WiFi

The programming instructions comply with the IEEE 488.2 standard, SCPI protocol.



*Refer to the remote programming manual for a complete list of commands and syntax information.*

## General Specifications

---

<b>Environment</b>	• Reference temperature	18°C to 28°C
	• Operating temperature	0°C to 40°C
	• Storage temperature	- 20°C to + 60°C
	• Utilisation	indoors
	• Altitude	< 2,000 m
	• Relative humidity	< 80 % up to 31°C

---

<b>Mains power supply</b>	• Mains voltage	Use nominal range 100 to 240 VAC
	• Frequency	from 47 to 63 Hz
	• Consumption	< 16 W at 230 VAC, 50 Hz
	• Fuse	2.5 A / 250 V / delayed
	• Detachable mains power cable	

---

<b>Safety</b>	As per IEC 61010-1 :
• Insulation	class 1
• Degree of pollution	2
• Category of power supply overvoltage:	CAT II 240 V
• "Measurement" input overvoltage category	CAT II 300 V



This equipment is designed to conform to current EMC standards and its compatibility has been tested as per NF Standard EN 61326-1+ A1 :

Immunity	Influence quantity: 5 mV in the presence of a magnetic field of 3 V/m
	Influence quantity: 10 mV in the presence of a magnetic field of 10 V/m

---

## Mechanical Specifications

---

<b>Casing</b>	• Dimensions	270 x 213 x 63 (in mm)
	• Weight	1.8 kg
	• Materials	ABS VO (self-extinguishing)
	• Sealing	IP 30

---

<b>Packaging</b>	• Dimensions	300 (l) x 330 (L) x 230 (D) in mm
------------------	--------------	-----------------------------------

---

## Supply

---

### Accessories

---

#### *comes with*

- User manual on CD-ROM
- Programming manual on CD-ROM
- [SCOPEin@BOX](#) software
- First installation instructions for the software
- Mains power cable
- 1/1, 1/10, 200 MHz, 300 V (x 2) voltage probes
- Untwisted Ethernet cable
- Twisted Ethernet cable
- USB cable 1.8m

---

#### *optional accessories*

- Takeoff Tee  
1 x BNC male - 2 x BNC female (package of 3 u.) HA2004-Z
- BNC female - BNC female extender (package of 5 u.) HA2005
- Safety adapter  
BNC male / 4 mm socket, CAT III, 500 V (package of 5 u.) HA2002
- Safety adapter  
BNC male - BNC male extender (package of 3 u.) HX0107
- Cord. RJ45/RJ45 straight 2 m 541116
- Cord. RJ45/RJ45 crossed 2 m 541117
- Cord. USB.A/B/1.80 m 541318
- Cord. SECT/EURO.1,5 m elbowed AG0416
- BNC male / 4 mm socket, CAT III, 500 V (package of 3 u.) HX0107
- 1/1, 1/10, 200 MHz, 300 V voltage probes HX0220
- Voltage probe 1:10 fixed, 450 MHz, CAT II / 1000 V HX0005
- Voltage probe 1:100 fixed, 300 MHz, 5 kV Peak HX0006
- 1-channel 30 MHz differential probe MX9030-Z
- 2-channel 50 MHz differential probe, BNC inputs MTX1032-C
- BNC male / BNC male cord CAT III, 500 V, length 1.5 m HX0106
- WiFi access HX0090
- 16 channel Logic Analyzer LX 1600-PC
- 2.5 A, 250 V, T, 5 x 20 mm fuse AT0090