

- DIGITAL / ANALOG
MEGOHMMETERS

1030
1040
1045

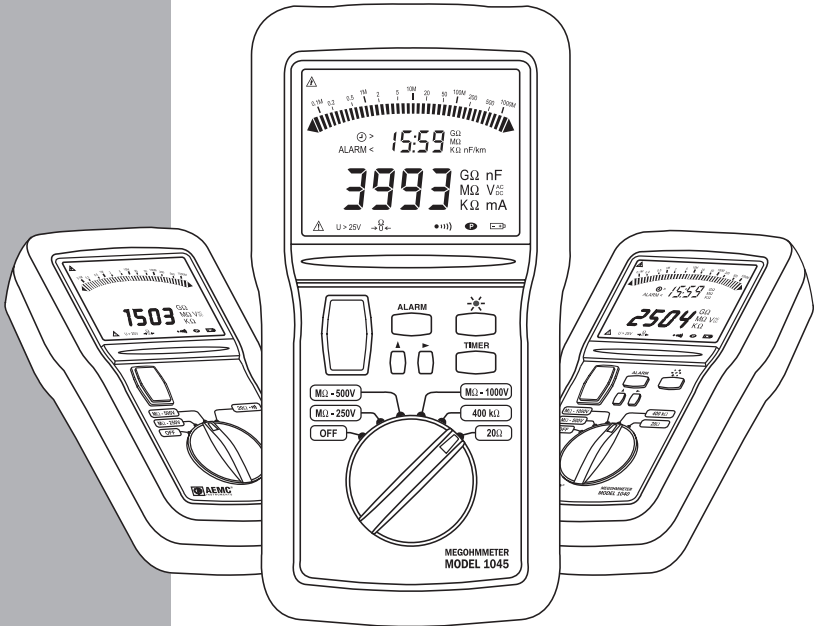

Statement of Compliance

Chauvin Arnoux®, Inc. d.b.a. AEMC® Instruments certifies that this instrument has been calibrated using standards and instruments traceable to international standards.

We guarantee that at the time of shipping your instrument has met its published specifications.

An NIST traceable certificate may be requested at the time of purchase, or obtained by returning the instrument to our repair and calibration facility, for a nominal charge.

The recommended calibration interval for this instrument is 12 months and begins on the date of receipt by the customer. For recalibration, please use our calibration services. Refer to our repair and calibration section at www.aemc.com.

Serial #: _____

Catalog #: 2116.89/2116.92/2116.93

Model #: 1030/1040/1045

Please fill in the appropriate date as indicated:

Date Received: _____

Date Calibration Due: _____



Chauvin Arnoux®, Inc.
d.b.a AEMC® Instruments
www.aemc.com

Table of Contents

1. INTRODUCTION.....	3
1.1 International Electrical Symbols.....	4
1.2 Definition of Measurement Categories.....	4
1.3 Receiving Your Shipment.....	4
1.4 Ordering Information.....	5
1.4.1 Accessories and Replacement Parts.....	5
2. PRODUCT FEATURES.....	6
2.1 Description.....	6
2.2 Control Features.....	7
2.2.1 Model 1030.....	7
2.2.2 Model 1040.....	8
2.2.3 Model 1045.....	9
2.3 Display Features.....	10
2.3.1 LCD Display Symbols.....	10
2.3.2 Analog Bargraph.....	10
2.3.3 Digital Display Symbols.....	10
2.4 Control Features.....	11
2.4.1 Yellow Push Button.....	11
2.4.2 ALARM Button (Models 1040/1045).....	11
2.4.3 Cursor Button (Models 1040/1045).....	11
2.4.4 Scroll Cursor Button (Models 1040/1045).....	12
2.4.5 Backlight Button (Models 1040/1045).....	12
2.4.6 TIMER Push Button (Model 1045).....	12
2.5 Measurement Functions.....	12
2.5.1 Insulation Resistance Testing.....	12
2.5.2 Continuity Testing.....	14
2.5.3 Resistance Measurement (Models 1040/1045).....	14
2.6 Special Functions.....	15
2.6.1 Turning ON/OFF - Battery Life Indication.....	15
2.6.2 Auto OFF Function.....	15
2.6.3 Battery Auto Test.....	16
2.6.4 Buzzer.....	16
2.6.5 Alarm Setpoints (Models 1040/1045).....	17

2.6.6	Measurement Lead Resistance Compensation (Models 1040/1045).....	18
2.6.7	Timer (Model 1045).....	19
3.	SPECIFICATIONS.....	20
3.1	Electrical Specifications.....	20
3.1.1	Reference Conditions.....	20
3.1.2	Voltage Detection.....	20
3.1.3	Insulation Resistance Testing.....	20
3.1.4	Continuity.....	21
3.1.5	Resistance (Model 1040/1045).....	21
3.1.6	Timer (Model 1045).....	22
3.1.7	Power Supply.....	22
3.2	Environmental Specifications.....	22
3.2.1	Influencing Parameters.....	22
3.2.2	Limits.....	23
3.3	Mechanical Specifications.....	23
3.4	Safety Specifications.....	23
3.5	Application Examples.....	24
3.5.1	Insulation Measurements on Installations.....	24
3.5.2	Insulation Measurements on Cables.....	24
3.5.3	Insulation Measurements on Motors.....	25
4.	OPERATION.....	26
4.1	Operation.....	26
4.2	Insulation Resistance Testing.....	26
4.3	Continuity Measurements.....	27
4.4	Resistance Measurements (Models 1040/1045).....	28
5.	MAINTENANCE.....	29
5.1	Battery Replacement.....	29
5.2	Fuse Replacement.....	29
5.3	Cleaning.....	30
5.4	Storage.....	30
	Repair and Calibration.....	31
	Technical and Sales Assistance.....	31
	Limited Warranty.....	32
	Warranty Repairs.....	32





INTRODUCTION

Warning

These safety warnings are provided to ensure the safety of personnel and proper operation of the instrument.

- Read the instruction manual completely and follow all safety information before operating this instrument.
- Safety is the responsibility of the operator!
- Tests are to be carried out only on non-energized circuits! Check for live circuits before making resistance measurements (safety check).
- The Megohmmeter Models 1030, 1040 and 1045 are sources of high voltage, as is the sample connected to them. All persons performing or assisting in the tests must employ all safety precautions to prevent electrical shock to themselves and to others.
- AEMC® considers the use of rubber gloves to be an excellent safety practice even if the equipment is properly operated and correctly grounded.
- When testing capacitance samples, make sure that they have been properly discharged and that they are safe to touch. Dielectric insulation samples should be short-circuited for at least five times the amount of time they were energized.
- Megohmmeters should never be used in an explosive environment.
- Use the leads supplied with the megohmmeters. If they are defective or worn, replace before testing.
- This instrument can be used on installations rated for 300V, Category II (CAT II).

1.1 International Electrical Symbols

	This symbol signifies that the instrument is protected by double or reinforced insulation.
	This symbol on the instrument indicates a WARNING and that the operator must refer to the user manual for instructions before operating the instrument. In this manual, the symbol preceding instructions indicates that if the instructions are not followed, bodily injury, installation/sample and product damage may result.
	Risk of electric shock. The voltage at the parts marked with this symbol may be dangerous.
	In conformity with WEEE 2002/96/EC

1.2 Definition of Measurement Categories

- Cat. I:** For measurements on circuits not directly connected to the AC supply wall outlet such as protected secondaries, signal level, and limited energy circuits.
- Cat. II:** For measurements performed on circuits directly connected to the electrical distribution system. Examples are measurements on household appliances or portable tools.
- Cat. III:** For measurements performed in the building installation at the distribution level such as on hardwired equipment in fixed installation and circuit breakers.
- Cat. IV:** For measurements performed at the primary electrical supply (<1000V) such as on primary overcurrent protection devices, ripple control units, or meters.

1.3 Receiving Your Shipment

Upon receiving your shipment, make sure that the contents are consistent with the packing list. Notify your distributor of any missing items. If the equipment appears to be damaged, file a claim immediately with the carrier and notify your distributor at once, giving a detailed description of any damage. Save the damaged packing container to substantiate your claim. Do not use an instrument that appears to be damaged.

1.4 Ordering Information

Megohmmeter Model 1030..... Cat. #2116.89

Megohmmeter Model 1040..... Cat. #2116.92

Megohmmeter Model 1045..... Cat. #2116.93

All models include a soft carrying pouch, two 1.5m test leads (red and black), 2 alligator clips (red and black), 1 black test probe, 6 batteries, and user manual.

Megohmmeter Model 1040 Field Kit Cat. #2117.30

Megohmmeter Model 1045 Field Kit Cat. #2117.31

Each kit is delivered with a field case, two 1.5m test leads (red and black), 2 alligator clips (red and black), 1 black test probe, 1 remote test probe, 6 batteries, and user manual.

1.4.1 Accessories and Replacement Parts

Remote Test Probe..... Cat. #2118.97

Soft Carrying Pouch Cat. #2119.02

Set of 5 Fuses, Fast Acting, 600V,
0.63A 1/4 x 1 1/4" (6.3 x 32mm) Cat. #2970.78

Field Case (Waterproof) Cat. #2118.98

Hands Free Carrying Case..... Cat. #2118.99

Replacement Lead Set
(2 leads, probe, 2 alligator clips)..... Cat. #2119.01

Order Accessories and Replacement Parts Directly Online

Check our Storefront at www.aemc.com/store for availability

PRODUCT FEATURES

The term “continuity” is used to define a resistance measurement with a test current of at least 200mA (with the measured resistance lower than 20Ω) in accordance with the VDE 0413 and IEC 61557 standards, and to distinguish it from a resistance measurement performed with a lower unspecified test current.

2.1 Description

The Megohmmeters Model 1030, 1040 and 1045 are battery powered digital insulation resistance testers. They are designed to measure insulation resistance, continuity, voltage, and to measure resistance.

These megohmmeters are used to verify the safety state of electrical installations, motors, cables and other insulated products. The measurement acquisition, processing and displaying technology are managed by a microprocessor.

The Models 1030, 1040 and 1045 offer many features such as:

- Automatic detection of potentially dangerous voltages
- Protection against external voltage surges
- Enhanced operator safety through automatic discharge of the tested sample
- Automatic shutdown to optimize the battery life
- Large LCD display with easy to read symbols and indicators and, depending on the model, bright blue electroluminescent back-lighting
- Alarm programming for quick tests
- Lead resistance compensation for accurate continuity measurements
- Display of the duration of the measurement for easy DAR and PI measurements

2.2 Control Features

2.2.1 Model 1030

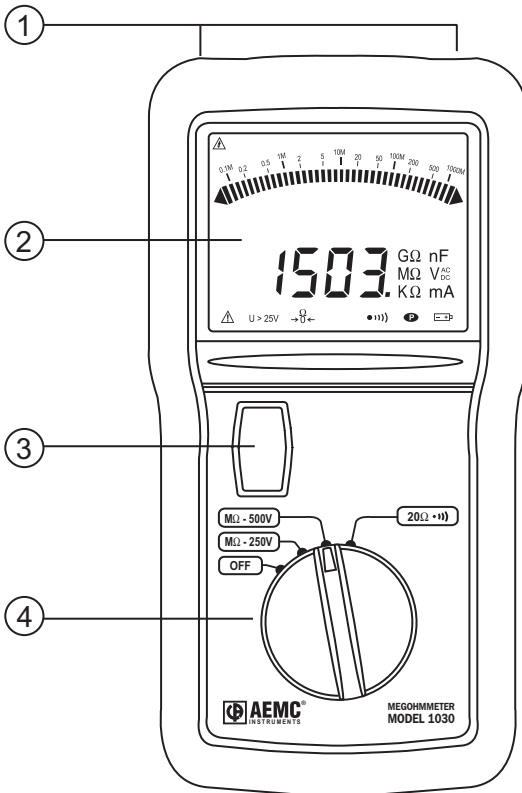

Figure 1

1. Safety terminals, \varnothing 4mm
(marked “+” on Red and “-”)
2. Liquid crystal display (LCD)
3. Yellow test button
(used to test insulation resistance)
4. 4 position rotary switch:
OFF, MΩ - 250V, MΩ - 500V, 20Ω
5. Battery compartment and stand (not shown in the drawing)

2.2.2 Model 1040

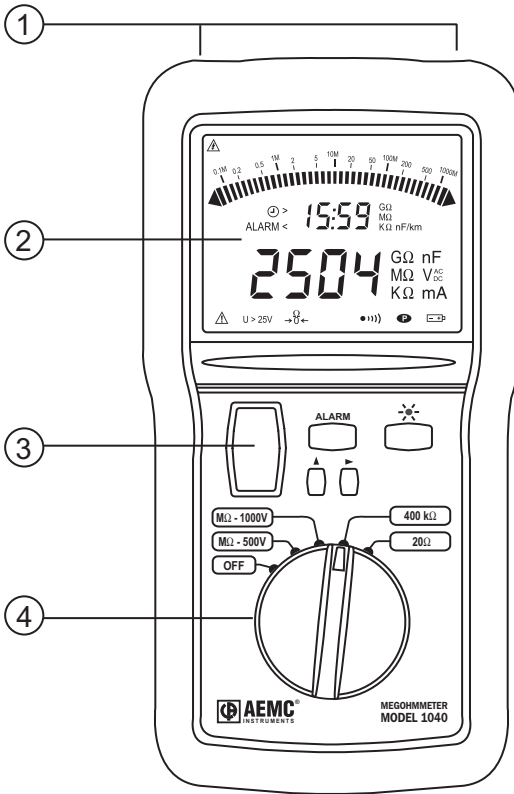

Figure 2

1. Safety terminals, \varnothing 4mm (marked “+” on Red and “-”). Note the input for the remote test probe (3-point jack) next to the “-” terminal.
2. Backlight liquid crystal display (LCD) with primary (large) display and secondary (small) display for alarm and timer features.
3. Yellow test button (to test insulation resistance), ALARM, selection and scroll cursors ▲, ►, and ☀ backlight buttons.
4. 5 position rotary switch:
OFF, MΩ - 500V, MΩ - 1000V, 400kΩ, 20Ω
5. Battery compartment and stand (stand not shown in the drawing).

2.2.3 Model 1045

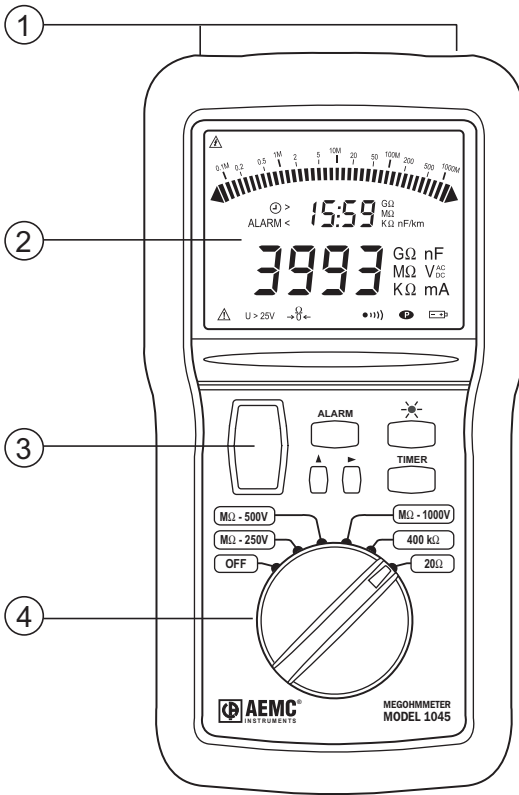









Figure 3



1. Safety terminals, \varnothing 4mm (marked "+" on Red and "-"). Note the input for the remote test probe (3-point jack) next to the "-" terminal
2. Backlight liquid crystal display (LCD) with primary (large) display and secondary (small) display for alarm and timer features
3. Yellow test button (to test insulation resistance), ALARM, selection and scroll cursors \blacktriangle , \blacktriangleright , and \odot backlight buttons
4. 6 position rotary switch:
 OFF , $M\Omega - 250V$, $M\Omega - 500V$, $M\Omega - 1000V$, $400k\Omega$, 20Ω
5. Battery compartment and stand (stand not shown in the drawing)

2.3 Display Features

2.3.1 LCD Display Symbols

-  Timer active (TIMER mode)
- ALARM** Alarm ON or programming in progress
- >** Alarm triggered above setpoint
- <** Alarm triggered below setpoint
-  Dangerous test voltage generated
-  See the user manual
- > 25V** Voltage at terminals (non generated) > 25V
-  Compensated lead resistance
-))** Buzzer active
-  Auto Off disabled (no automatic shutdown)
-  Battery status
-  and  Flashing: incorrect compensation of lead resistance

2.3.2 Analog Bargraph

-  Insulation > 2GΩ
-  Insulation < 50kΩ

2.3.3 Digital Display Symbols

- BAT** Batteries low – must be replaced
- OL** Over Range - Over Load
- Insulation < 50kΩ at 250V, < 100kΩ at 500V
or < 200kΩ at 1000V

2.4 Control Features

2.4.1 Yellow Push Button

The yellow button is only used to initiate the test voltage when measuring insulation resistance. It is not used for voltage, resistance, or continuity tests.

In any function setting (except OFF), the megohmmeter is in the voltage mode and works as a voltage tester to detect if any voltage is present on the tested sample. If a voltage greater than 25V is detected, the yellow test button is disabled and insulation testing is not possible.

The yellow test button is only active as long as it is pressed, (exception in the TIMER mode - the Model 1045 - where first press = ON, second press = OFF).

2.4.2 ALARM Button (Models 1040/1045)

The ALARM button is used to turn the alarm ON and OFF for insulation, resistance, and continuity measurements.

It is also used with the ◀ and ▲ selection cursor buttons to adjust the alarm set points.

2.4.3 Cursor Button (Models 1040/1045)

When programming the alarm setpoints, the ► cursor button makes the following symbols flash as follows:

- the measurement unit (if applicable),
- the thousands digit,
- the hundreds digit,
- the tens digit,
- the units digit,
- the decimal point,
- the alarm trigger (above or below the setting),
- and it then returns to the measurement units.

2.4.4 Scroll Cursor Button (Models 1040/1045)

When programming the alarm setpoints, the ▲ scroll cursor is used to scroll through the possible values for each parameter, which flashes:

- MΩ or GΩ for insulation, kΩ or Ω for resistance, for the measurement units,
- 1, 2, 3 or _ for the thousands digit,
- 0, 1, 2, 3, 4, 5, 6, 7, 8 and 9 for the hundreds, tens and units,
- “-.-.-” or “-.-.-” or “-.-.-” or “-.-.-” for the decimal separator,
- > or < for above or below threshold trigger.

2.4.5 Backlight Button (Models 1040/1045)

The ☀ button turns the backlight on and off. The backlight will automatically turn off after one minute. It may also be turned off by pressing the button again at any time.

2.4.6 TIMER Push Button (Model 1045)

This button is used to turn on or off the timed insulation resistance measurement. It may be pressed either before the yellow test button, or during the insulation resistance test. If pressed during a timed test it will stop the measurement.

2.5 Measurement Functions

2.5.1 Insulation Resistance Testing

The rotary switch MΩ positions determine the insulation resistance testing voltage.



Tests are to be carried out on non-energized circuits only!



- **Voltage Detection (Safety Check)** 

This is an automatic safety feature. As soon as the switch is turned to a MΩ position and before the yellow test button is pressed, the megohmmeter enters a voltage detection mode. It measures any voltage between the test leads and the sample. This is a safety check to ensure that the tested sample is not live.

If the voltage detected is less than 25V, testing may continue, but an error may occur. The lower the test voltage (250V, 500V or 1000V) the greater the error.

If the voltage is greater than 25V, “ and > 25V” are displayed.

Insulation resistance testing is disabled. Pressing the yellow button will only cause the buzzer to turn on and the  symbol to flash.



Do not perform measurements if any voltage is present.



The warnings turn off only if the voltage at the terminals falls below 25V (removal of the test leads from the sample or disappearance of the voltage), or if the instrument is turned OFF.





If the voltage detected is above 600V (outside of the measurement range) the megohmmeter will display “OL” on the digital display.

- **Insulation Resistance Testing**

As soon as the switch is turned to a M Ω position, the megohmmeter enters a voltage detection mode (safety check). It checks if there is any voltage between the test leads and the sample. This is a safety check to ensure that the tested sample is not live. (see above).

Insulation resistance testing is initiated by pressing the yellow test button. The high test voltage is then generated. The insulation resistance value is displayed on the analog bargraph (log scale) and on the digital display.

If the measured insulation resistance is greater than 2G Ω (2000M Ω), the OL symbol is displayed on the digital display instead of a value, and if the measurement is greater than 2G Ω , the  symbol lights up on the right-hand side of the bargraph. Similarly, if the measured insulation resistance is less than 50k Ω at 250V, 100k Ω at 500V, or 200k Ω at 1000V, the digital measurement display indicates “- - -”, and if the measurement is less than 50k Ω , only the  symbol lights up on the left-hand side of the bargraph.

As soon as the yellow button is released the test voltage is stopped (except in TIMER mode where it needs to be pressed again), and the megohmmeter returns to the voltage test mode (safety check). It may continue to display the voltage, due to the possibly charged sample. The voltage may drop off more or less rapidly based on the sample capacitance.

When the test voltage is generated the  symbol is displayed to warn the user that the generated test voltage may be dangerous.

Note (Models 1040/1045): A programmed alarm setting may be triggered (see pg 17) during the measurement.

Note (Model 1045): The measurement may be timed (see §2.6.7).

2.5.2 Continuity Testing



Tests are to be carried out on non-energized circuits only!



Continuity measurement corresponds to the “20 Ω ” rotary switch position. The megohmmeter takes a measurement at $I \geq 200\text{mA}$, and the Ω symbol is displayed. When the ALARM is active and the buzzer turned on, the buzzer will sound before the measurement value is displayed. If the resistance is greater than 20 Ω , OL is displayed on the digital display. The bargraph is not active in the continuity mode.



During continuity testing, the fuse is checked automatically after each measurement.

Note (Models 1040/1045): The resistance of the measurement leads may be compensated. The alarm may be active in the continuity mode (see §2.6.5).

Note (Model 1030): In the continuity mode, a lower alarm point of 2 Ω is constantly active. The buzzer will sound below this value. However, the buzzer may be disabled by pressing the yellow button.

2.5.3 Resistance Measurement (Models 1040/1045)



Measurements to be carried out on non-energized circuits only!



Resistance measurement corresponds to the 400k Ω position of the rotary switch. The Ω symbol is displayed with the k multiplier symbol if necessary. The measurement value is shown on the digital display.

If the resistance is greater than 400k Ω , OL is displayed on the digital display. The bargraph is not active in the continuity mode.

The alarm may be active in resistance measurement mode.

2.6 Special Functions

2.6.1 Turning ON/OFF - Battery Life Indication

When you move the rotary switch from the OFF position to one of the function positions, the battery voltage is applied to the circuit. The instrument turns on, and all of the display lights up at the same time for 1 second. Then for 2 seconds, the  symbol stays on, and the bargraph and the digital display indicate the remaining battery life in percentage (0 to 100%, e.g. 0.95 = 95%).

Note, that this is approximate and based on a typical battery with total voltage varying from 6.7 to 10V.

The instrument may be turned off at any time by turning the rotary switch to OFF. This cuts off the battery power supply to the whole instrument.

2.6.2 Auto OFF Function

After 5 minutes without any operation to the instrument (button pressed, or on the remote control test probe, or turn of the rotary switch), the instrument automatically enters a stand-by mode.



To start up the instrument again do one of the following:

- Press any one of the buttons
- Turn the switch
- Press the yellow test button on the remote control test probe

The Auto OFF is disabled when measuring continuity, for as long as the test current varies from zero (which means that a measurement is in progress).

On the Model 1045, in the TIMER mode (see §2.6.7), the five minutes steady state begins at the end of the maximum 15-minute measurement period.

- **Disabling/Enabling the Auto OFF (Models 1040/1045)**



To disable the Auto OFF, keep the  button pressed down when turning ON the instrument. The  symbol is then displayed, indicating that the Auto OFF function has been disabled.

To enable the Auto OFF function, turn the instrument off (turn the switch to OFF) and then turn it back on again. Auto OFF is the default mode.

2.6.3 Battery Auto Test

The battery supply voltage is measured automatically every second. The battery voltage range for correct operation is 7V to 10V.

There are four possible cases:

- **The voltage is correct:** Nothing is displayed.
- **The voltage < 7.1V:** The  symbol flashes. Remaining battery life is limited.
- **The voltage < 6.9V:** The  symbol remains lit. Measurement accuracy is no longer assured. Replace the batteries.
- **The voltage is close to 6.7V:** The digital display indicates “BAT” and then, after 5 seconds, the shutdown buzzer sounds, and the Auto OFF function is activated. The instrument shuts down.

2.6.4 Buzzer

- **The Different Sounds**

When the  symbol is displayed, the buzzer is active and gives out different sounds, depending on the operation or warning.

- **Short buzz (65 ms at 2kHz):**
 - push on a button
 - auto OFF
 - lead resistance compensation
 - after 30 s, 1 min and 10 min during TIMED insulation resistance measurement (Model 1045)
- **Continuous buzz (at 2kHz):**
 - measurement is lower than the minimum setpoint
 - measurement is higher than the maximum setpoint
- **Short, higher buzz (65 ms at 4kHz):**
 - when a disabled (inactive) button is pressed (except the yellow test button)
- **Repeated high buzzes (at 4kHz):**
 - the detected voltage (safety check) at the sample is greater than 25V, and the user presses the yellow test button

- **Disabling/Enabling the Buzzer**

Model 1030: to disable the buzzer, turn the rotary switch to continuity measurement (20Ω), and then press the yellow test button. The buzzer sounds and the buzzer symbol turns off. To enable the buzzer, press the yellow test button again, or turn switch to OFF and then back on again. Buzzer on is the default mode.

Models 1040 and Model 1045: to disable the buzzer, keep the ALARM button pressed down and turn the instrument ON. The buzzer symbol is off (not lit). To enable the buzzer, turn switch to OFF and then back on again. Buzzer on is the default mode.

2.6.5 Alarm Setpoints (Models 1040/1045)

Alarm setpoints are fully programmable for each function. There can be an alarm setpoint for each measurement function. The setpoints can be upper or lower thresholds. They can be active or inactive, and will be kept in memory even after the instrument has been turned off.

- **Programming of the Alarm Setpoints**

To program the setpoint press the ALARM button until the “ALARM” symbol is displayed and beeps a second time (the setpoint unit will blink, e.g. $M\Omega$). The value of the setpoint corresponding to the selected range is indicated on the small digital display.

The display indicates the following default setpoints settings:

- $> 0.25M\Omega$ for the $M\Omega$ - 250V position
- $> 0.50M\Omega$ for the $M\Omega$ - 500V position
- $> 1.00M\Omega$ for the $M\Omega$ - 1000V position
- $< 10.00k\Omega$ for the $400k\Omega$ position
- $< 2.00\Omega$ for the 20Ω position

The setpoints may be programmed using the cursor buttons (see §2.4.3). During programming, the megohmmeter continues measuring.

To save the setpoints into memory, quit the programming mode by another long press on the ALARM button until the second beep.

There are limitations on the value of the setpoints. If the programmed setpoint is too high, it is corrected when it is stored into memory: the maximum range value will be entered. For example, for continuity measurements, a 30.00Ω setpoint will be stored as 20.00Ω (max value for continuity).

If the setpoint has been improperly input, it is also corrected when it is stored into memory: For example, $002M\Omega$ will become $2.00M\Omega$.

- **Turning the Alarm ON and OFF**

The Alarm can be turned ON by a short press on the ALARM button. The buzzer beeps and the ALARM symbol, the < or > symbol, and the programmed setpoint value is then displayed on the digital setpoint display.

The Alarm can be turned OFF by a second short press (and one beep) on the ALARM button. The ALARM symbol, the < or > symbol, and the alarm setpoint will disappear.

- **Triggering the Alarm**



When a setpoint is reached and the alarm is turned on, the buzzer will sound continuously and the ALARM and the settings will flash.



For example, when measuring continuity with a setpoint with a value of $>10\Omega$, the instrument displays "ALARM $>10.00\Omega$ " when the alarm is on. If the measurement exceeds 10.00Ω , a continuous beep will be triggered and the alarm display will flash.

Similarly, if when measuring insulation with a setpoint value of $<10M\Omega$, the instrument displays "ALARM $<10.00M\Omega$ ". If the measurement falls below this value, a continuous beep will be triggered and the alarm display will flash.

2.6.6 Measurement Lead Resistance Compensation (Models 1040/1045)

Test lead resistance may be important in a continuity measurement, and removing this resistance improves the measurement accuracy of low resistances. The lead resistance compensation feature is only active in the continuity measurement mode (20Ω).

To compensate (offset) the test leads resistance, short-circuit the leads and press the  button for a short time (long press). When the compensation has been recorded, the display indicates 0.00 and the buzzer sounds. From this moment on, the measurements displayed will be automatically reduced by the value recorded and the  symbol will be displayed.

To delete the compensated lead resistance, remove the test leads and press the  button for a short time (long press). When the lead compensation is cancelled, the  symbol goes out. Note that the maximum 20Ω continuity measurement range is reduced by the stored compensation value.

Note: When you change the leads, the measurement may become negative if the compensation is higher than the resistance measured with the resistance of the new leads. 0.00 is then displayed up to -0.02Ω and the $\rightarrow 0 \leftarrow$ and \triangle symbols flash to indicate that the lead compensation is no longer suitable and should be redone.

2.6.7 Timer (Model 1045)

The timer function is available only for insulation resistance testing mode (M Ω positions).

When the TIMER button is pressed, the \odot symbol appears in front of the small digital display which indicates 0:00 (elapsed time). If there was a programmed alarm setpoint displayed, it will disappear.

A short press on the yellow test button starts both the timer and insulation resistance measurement. You do not have to keep the test button pressed down in the TIMER mode.

A second press on the yellow test button stops the timer and the measurement. The elapsed time remains displayed and the instrument switches back to voltage measurement.

To perform another timed measurement, simply press the yellow test button again. The timer is reset to zero and restarts along with the measurement.

To end the timer mode, simply press the TIMER button again or switch the instrument OFF and then back on again. The \odot symbol is no longer displayed.

When in the timer mode, the buzzer sounds after 30 seconds, 1 minute and 10 minutes. This is to notify the user when to take readings required to calculate the dielectric absorption rate (DAR) (= measurement after 1 min / measurement after 30 s) and the polarization index (PI) (= measurement after 10 min / measurement after 1 min).

Reminder: For acceptable insulation, they must be greater than 1.25 and 2, respectively.

When measuring, if an alarm setpoint is triggered, the buzzer sounds and display of the timer is interrupted to display the alarm message (see §2.6.5).

If you forget to stop the insulation test in the TIMER mode, the megohmmeter will automatically switch back to voltage measurement after 15 minutes and the TIMER remains locked at 15:00.

SPECIFICATIONS

The megohmmeters refresh the measurement every 400ms, which corresponds to 2.5 measurements per second for the digital display. The bargraph is refreshed every 100ms. The digital measurement is smoothed, while the bargraph always indicates the instantaneous measurement.

3.1 Electrical Specifications

3.1.1 Reference Conditions

Parameters	Reference Conditions
Temperature	23°C ± 3K
Relative humidity	45 to 55% RH
Supply voltage	8V ± 0.2V
Capacity in parallel on resistance	nil
Electrical field	nil
Magnetic field	< 40A/m

3.1.2 Voltage Detection

Detection Range: 0 to 600V_{AC/DC}

3.1.3 Insulation Resistance Testing

Measurement Range:

Model 1030: 250V 50kΩ to 2GΩ
500V 100kΩ to 2GΩ

Model 1040: 500V 100kΩ to 2GΩ
1000V 200kΩ to 2GΩ

Model 1045: 250V 50kΩ to 2GΩ
500V 100kΩ to 2GΩ
1000V 200kΩ to 2GΩ

Analog Bargraph	50kΩ to 2GΩ
Resolution	8 segments per 10-unit interval
Accuracy	5% Rdg \pm 1 segment

Digital Display	0.05 to 0.19MΩ	0.2 to 39.99MΩ	40.0 to 399.9MΩ	400 to 2GΩ
Resolution	10k Ω	10k Ω	100k Ω	1M Ω
Accuracy	3% Rdg \pm 7cts	3% Rdg \pm 5cts	3% Rdg \pm 2cts	

Test Voltage	250V	500V	1000V
Open Circuit Voltage	< 300V	< 600V	< 1200V
Test Current	\geq 1mA for R \leq 250k Ω	\geq 1mA for R \leq 500k Ω	\geq 1mA for R \leq 1M Ω
Short-circuit Current	\leq 3mA		

The residual voltage present on the terminals when the yellow button is released, is automatically discharged through the instrument at a rate of 1.5 s/ μ F into an impedance of 300k Ω .

Average charging time:

	500V	1000V	
1M Ω	3s	3s	1 μ F
	3s	6s	5 μ F
100M Ω	6s	6s	1 μ F
	20s	20s	5 μ F

3.1.4 Continuity

Measurement Range: 0 to 20 Ω

Range	0.00 to 19.99Ω
Resolution	10M Ω
Accuracy	\pm 3% Rdg \pm 1ct
Measuring Current	\geq 200mA
Open Circuit Voltage	7V \leq V open \leq 9V

3.1.5 Resistance (Model 1040/1045)

Measurement Range: 0 to 400k Ω

Range	0.0 to 399.9Ω	400 to 3999Ω	4.00 to 39.99kΩ	40.0 to 399.9kΩ
Resolution	0.1 Ω	1 Ω	10 Ω	100 Ω
Accuracy	3% Rdg \pm 5cts		3% Rdg \pm 1ct	
Test Current	600 μ A		60 μ A	
Open Circuit Voltage	7V \leq V open \leq 9V			

3.1.6 Timer (Model 1045)

Measurement Range: 0 to 15 min

Range	0:00 to 15:00
Resolution	1 second
Accuracy	2% Rdg

3.1.7 Power Supply

The instrument is powered by 6 x 1.5V AA alkaline batteries, type NEDA 15A, or LR6.

Measurement	Consumption	Average Life
Voltage detection	25mA	57,000 5-second measurements
Resistance	50mA	28,000 5-second measurements
Insulation 250V (R = 250kΩ)	160mA	7,200 5-second measurements
Insulation 500V (R = 500kΩ)	200mA	3,800 5-second measurements
Insulation 1000V (R = 1000kΩ)	350mA	1,440 5-second measurements
Continuity	230mA	3,300 5-second measurements

* Add approximately 45mA for the backlighting.

3.2 Environmental Specifications

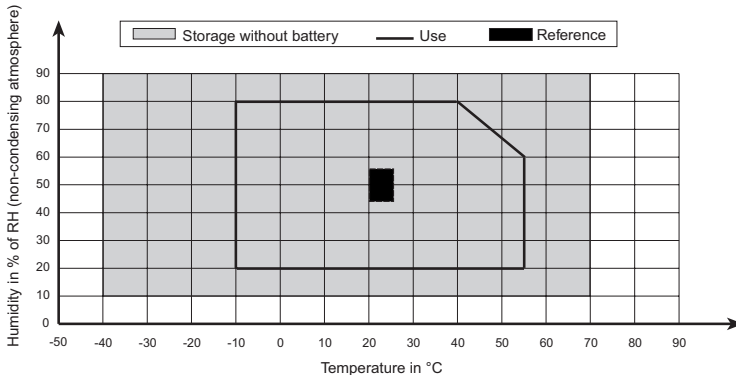

3.2.1 Influencing Parameters

Influence Parameter	Range	Measurement Variations	
		Typical	Maximum
Temperature	-10 to +55°C	1% Rdg ± 1ct / 10°C	2% Rdg ± 2cts / 10°C
Relative Humidity	20 to 80% RH	1% ± 1ct	3% ± 2cts
Supply Voltage	6.9 to 10V	1% Rdg ± 1ct	2% Rdg ± 2cts
Capacity in parallel to the resistance	0 to 5µF at nominal current	n/a	1% Rdg ± 1ct

3.2.2 Limits

The megohmmeters are protected on all ranges against a voltage of 720VAC/DC, applied permanently between any two terminals.

The Models 1040 and 1045 are also protected against accidental voltage surges of 1200VAC/DC on all ranges for 10s.

3.3 Mechanical Specifications

LCD Display: 2.87 x 2.14" (73 x 54.3mm)

Dimensions: 8.30 x 4.25 x 2.36" (211 x 108 x 60mm)

Weight: Approx 830g

Materials: Polycarbonate casing
Crystal polycarbonate screen
Elastomer external mouldings
Silicon keyboard

Stand: Enables the instrument to be tilted at 30°.
Clips away into the bottom of the case when not in use.

3.4 Safety Specifications

Electrical Safety (according to IEC 1010-1 +A2 (Nov. '95), IEC 61557 (Feb. '97), and DIN EN 61557)

300Vrms, Cat. II, Pollution Degree 2

Electromagnetic Compatibility:



Emissivity: NF EN 55 081-1 (June '92)

Immunity: NF EN 55 082-1 (Jan. '98)

IP44 according to NF EN 60529 (Oct. '92)

IK04 according to NF EN 50102 (June '95)

UL Listed: E192383

3.5 APPLICATION EXAMPLES

3.5.1 Insulation Measurements on Installations

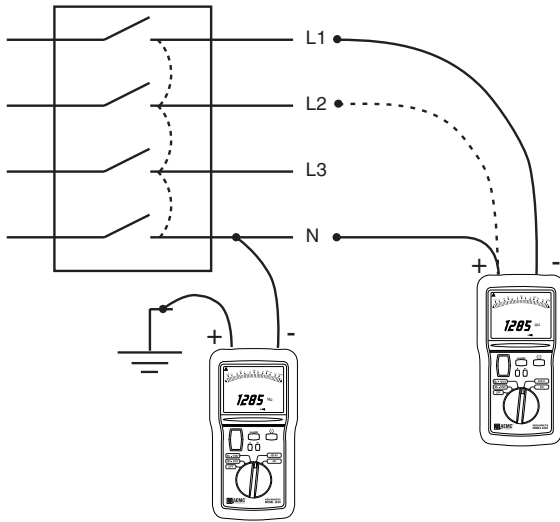

Figure 4

3.5.2 Insulation Measurements on Cables

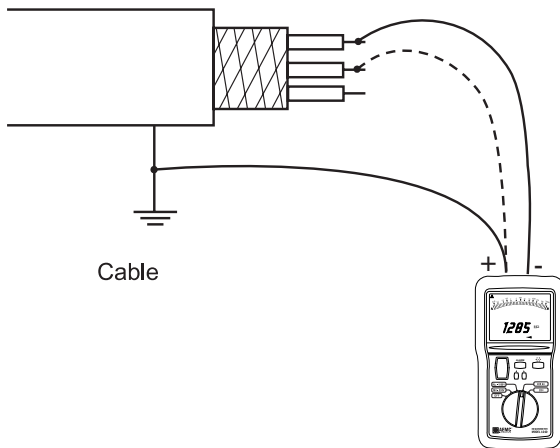

Figure 5

3.5.3 Insulation Measurements on Motors

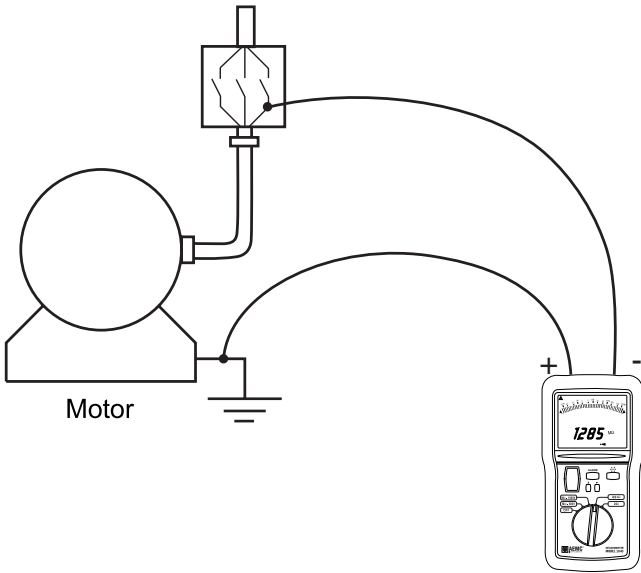

Figure 6

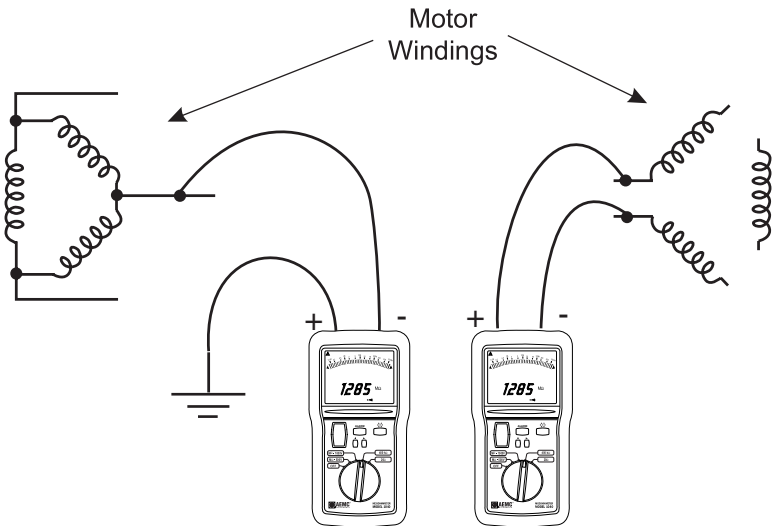

Figure 7

OPERATION

4.1 Operation

Turn the rotary switch to the measurement to be performed. Connect the instrument to the sample to be tested. The units and the range are automatically selected for the best reading.

The megohmmeter may be shut down manually by turning the switch to OFF. Otherwise, the instrument will shut down automatically after 5 minutes in the absence of any action by the user (see §2.6.2).

4.2 Insulation Resistance Testing (see pages 24 & 25)

- Turn the megohmmeter ON by turning the range switch to the appropriate M Ω - Voltage range.
- Connect the lead from the “ + ” terminal to the ground/earth point and the lead of the “ - ” terminal lead (or remote control probe) to the other test point.
- Before the yellow test button is pressed, the instrument operates as a voltage tester (safety check) to ensure that there is no dangerous voltage at the sample (see §2.5.1).
- On the Model 1040 and 1045 the user can turn on the display backlight by pressing the ☀ button.
- Press the yellow test button. Keep it pressed down until the measurement is displayed, or as long as needed. If released, the insulation test will stop. The yellow button on the remote control probe works the same way as the yellow test button on the megohmmeter (see §2.4.1).
- Record the insulation resistance value before releasing the test button.
- To end the measurement, release the yellow test button. The megohmmeter then enters the voltage detection mode and displays the voltage at the terminals. If the tested sample was capacitive, a voltage may appear and drop off slowly. Wait for the sample tested to discharge fully (voltage < 25V) before disconnecting the leads.

On the Model 1040 and Model 1045, the alarm function may be used in insulation resistance measurements, and can be activated by pressing the ALARM button.

On the Model 1045, timed insulation resistance measurements are initiated by using the TIMER button.

Note: When you change the leads, the measurement may become negative if the compensation is higher than the resistance measured with the resistance of the new leads. 0.00 is then displayed up to -0.02Ω and the $\rightarrow 0 \leftarrow$ and $\triangle!$ symbols flash to indicate that the lead compensation is no longer suitable and should be redone.

4.3 Continuity Measurements



Tests are to be carried out on non-energized circuits only!



- Turn the megohmmeter ON by turning the range switch to 20Ω . The test current is generated without pressing the yellow test button.
- On the Models 1040 and 1045 it is possible to compensate for the lead resistance (see §2.6.6).
- Connect the + and - leads to the measurement points.
- On the Models 1040 and 1045 the user can turn on the display backlight by pressing the \star button.
- Record the continuity resistance.
- The megohmmeter will continue generating a test current (200mA) until it is switched out of the continuity range. Turn the megohmmeter OFF when finished and before touching the lead ends.
- When there are inductive or capacitive elements in the tested sample, it may be useful to invert the polarity by switching the leads around on the sample. Take both measurements and use their average as a measurement result.

On the Models 1040 and 1045, the alarm function may be used in continuity measurements, and can be activated by pressing the ALARM button (see §2.6.5).

4.4 Resistance Measurements (Models 1040/1045)



Measurements to be carried out on non-energized circuits only!



- Turn the megohmmeter ON by turning the range switch to 400k Ω . The test voltage is generated without pressing the yellow test button.
- On the Models 1040 and 1045 the user can turn on the display back-light by pressing the  button.
- Record the continuity resistance.
- The megohmmeter will continue generating a test current until it is switched out of the resistance range. Turn the megohmmeter OFF when done.



On the Models 1040 and 1045, the alarm function may be used in resistance measurements, and can be activated by pressing the ALARM button.

MAINTENANCE

Use only factory specified spare parts. The manufacturer will not be held responsible for any accident, incident, or malfunction following a repair done other than by its Service Center or by an approved repair center.

5.1 Battery Replacement

Before any measurements, make sure that the  symbol is not displayed when a measurement function is selected. If it is displayed, change all the batteries.

Make sure that none of the terminals are connected and that the switch is set to OFF before opening the battery compartment. The battery cover is located on the back of the unit. It can be opened and closed using a coin or a large screwdriver (1/4-turn captive screw). To avoid errors, the    symbol on the power-supply board shows the direction in which the 2 x 3AA 1.5V batteries should be inserted. Make sure that you put the cover back properly and close it after changing the batteries.

5.2 Fuse Replacement

Change the fuse if “FUS” appears on the digital display at power up or when measuring continuity. Take all necessary precautions when opening the instrument. It can be opened and closed using a coin or a large screwdriver (1/4-turn captive screw). The fuse is placed on a fuse holder on the power-supply board.

Make sure that none of the terminals are connected and that the switch is set to OFF before opening the back cover. To avoid any errors, the text “F-0.63A” is written next to the fuse holder. Make sure that you replace the faulty fuse with fuse of the same rating and type. Replace and close the cover.

Type of fuse: Fast Acting 0.63A - 660V - 1/4" x 1 1/4" (6.3x32mm), 30kA

5.3 Cleaning

Disconnect the instrument from any power source. Use a soft cloth slightly moistened with soapy water. Rinse with a damp cloth and quickly dry with a dry cloth or forced dry air. Do not use alcohol, solvents or any hydrocarbon material.

5.4 Storage

If the instrument is to be unused for an extended period (more than 2 months), remove the batteries and store them separately.

Repair and Calibration

To ensure that your instrument meets factory specifications, we recommend that it be scheduled back to our factory Service Center at one-year intervals for recalibration, or as required by other standards or internal procedures.

For instrument repair and calibration:

You must contact our Service Center for a Customer Service Authorization Number (CSA#). This will ensure that when your instrument arrives, it will be tracked and processed promptly. Please write the CSA# on the outside of the shipping container. If the instrument is returned for calibration, we need to know if you want a standard calibration, or a calibration traceable to N.I.S.T. (Includes calibration certificate plus recorded calibration data).

Ship To: Chauvin Arnoux®, Inc. d.b.a. AEMC® Instruments
15 Faraday Drive
Dover, NH 03820 USA
Phone: (800) 945-2362 (Ext. 360)
(603) 749-6434 (Ext. 360)
Fax: (603) 742-2346 or (603) 749-6309
E-mail: repair@aemc.com

(Or contact your authorized distributor)

Costs for repair, standard calibration, and calibration traceable to N.I.S.T. are available.

NOTE: You must obtain a CSA# before returning any instrument.

Technical and Sales Assistance

If you are experiencing any technical problems, or require any assistance with the proper operation or application of your instrument, please call, mail, fax or e-mail our technical support team:

Chauvin Arnoux®, Inc. d.b.a. AEMC® Instruments
200 Foxborough Boulevard
Foxborough, MA 02035 USA
Phone: (800) 343-1391
(508) 698-2115
Fax: (508) 698-2118
E-mail: techsupport@aemc.com
www.aemc.com

NOTE: Do not ship Instruments to our Foxborough, MA address.

Limited Warranty

The Model 1030, 1040 and 1045 are warranted to the owner for a period of one year from the date of original purchase against defects in manufacture. This limited warranty is given by AEMC® Instruments, not by the distributor from whom it was purchased. This warranty is void if the unit has been tampered with, abused or if the defect is related to service not performed by AEMC® Instruments.

For full and detailed warranty coverage, please read the Warranty Coverage Information, which is attached to the Warranty Registration Card (if enclosed) or is available at www.aemc.com. Please keep the Warranty Coverage Information with your records.

What AEMC® Instruments will do:

If a malfunction occurs within the one-year period, you may return the instrument to us for repair, provided we have your warranty registration information on file or a proof of purchase. AEMC® Instruments will, at its option, repair or replace the faulty material.

**REGISTER ONLINE AT:
www.aemc.com**

Warranty Repairs

What you must do to return an Instrument for Warranty Repair:

First, request a Customer Service Authorization Number (CSA#) by phone or by fax from our Service Department (see address below), then return the instrument along with the signed CSA Form. Please write the CSA# on the outside of the shipping container. Return the instrument, postage or shipment pre-paid to:

Ship To: Chauvin Arnoux®, Inc. d.b.a. AEMC® Instruments
15 Faraday Drive • Dover, NH 03820 USA
Phone: (800) 945-2362 (Ext. 360)
(603) 749-6434 (Ext. 360)
Fax: (603) 742-2346 or (603) 749-6309
E-mail: repair@aemc.com

Caution: To protect yourself against in-transit loss, we recommend you insure your returned material.

NOTE: You must obtain a CSA# before returning any instrument.



08/08

99-MAN 100170 v10