

ScreenMaster RVG200

Paperless recorder



Measurement made easy

— Commissioning
your RVG200

Introduction

This publication provides the following commissioning instructions for the ScreenMaster RVG200 paperless recorder:

- 1 Locating the recorder
(location requirements)
- 2 Panel-mounting the recorder
(installation requirements to achieve IP66 / NEMA 4X hose-down rating)
- 3 Electrical connections
(AC and DC min. / max. values and fuse requirements)
- 4 Navigation
(navigating the user-interface quickly and effectively)
- 5 Menus overview
(menu familiarization)
- 6 Basic setup
(steps required for first-time use)
- 7 Symbols and icons
(a schedule of icons / warning symbols that may be displayed during operation)

For more information

Further publications for the ScreenMaster RVG200 paperless recorder are available for free download from www.abb.com (see links and reference numbers below) or by scanning this code:



Search for or click on:

RVG200 paperless recorder Operating instructions	OI/RVG200-EN
RVG200 paperless recorder Datasheet	DS/RVG200-EN

Health & Safety

Safety precautions

Be sure to read, understand and follow the instructions contained within this manual before and during use of the equipment. Failure to do so could result in bodily harm or damage to the equipment.



WARNING

Installation and maintenance of this product must only be conducted by personnel authorized to work on electrical installations and in accordance with relevant local regulations..

Potential safety hazards

Electrical



WARNING

To ensure safe use when operating this equipment, the following points must be observed:

- Up to 240 V AC may be present. Be sure to isolate the supply before removing the terminal cover.
- Normal safety precautions must be taken to avoid the possibility of an accident occurring when operating in conditions of high pressure and / or temperature.

Safety advice concerning the use of the equipment described in this manual or any relevant Material Safety Data Sheets (where applicable) can be obtained from the Company, together with servicing and spares information.

Safety standards

This product has been designed to satisfy the requirements of IEC61010-1:2010 3rd edition 'Safety Requirements for Electrical Equipment for Measurement, Control and Laboratory Use' and complies with US NEC 500, NIST and OSHA.

Safety conventions



WARNING

In this manual, a warning is used to indicate a condition which, if not met, could cause serious personal injury and / or death. Do not proceed beyond a warning until all conditions have been met.



CAUTION

A caution is used to indicate a condition which, if not met, could cause minor or moderate personal injury and / or damage to the equipment. Do not proceed beyond a caution until all conditions have been met.



IMPORTANT (NOTE)

A note is used to indicate important information or instructions that should be considered before operating the equipment.

EC Directive 89/336/EEC

Electrical – In order to meet the requirements of the EC Directive 89/336/EEC for EMC regulations, this product must be used in an industrial environment.

End-of-life disposal (Europe only)



The recorder contains a small lithium battery that must be removed and disposed of responsibly in accordance with local environmental regulations. The remainder of the recorder does not contain any substance that causes undue harm to the environment and must be disposed of in accordance with the Directive on Waste Electrical and Electronic Equipment (WEEE). It must not be disposed of in Municipal Waste Collection.

Cleaning

The complete recorder can be hosed down if it has been installed to IP66 / NEMA 4X standards – see Section ②, page 4. Warm water and a mild detergent can be used.

Symbols

Symbols that may appear on this product are shown below:



Functional earth (ground) terminal.



Both direct and alternating current supply.



This symbol, when noted on a product, indicates a potential hazard which could cause serious personal injury and / or death. The user should reference this instruction manual for operation and / or safety information.



This symbol, when noted on a product enclosure or barrier, indicates that a risk of electrical shock and / or electrocution exists and indicates that only individuals qualified to work with hazardous voltages should open the enclosure or remove the barrier.



The equipment is protected through double insulation.



Recycle separately from general waste under the WEEE directive.

Cyber security

This product is designed to be connected to and to communicate information and data via a network interface. It is your sole responsibility to provide and continuously ensure a secure connection between the product and your network or any other network (as the case may be). You shall establish and maintain any appropriate measures (such as but not limited to the installation of firewalls, application of authentication measures, encryption of data, installation of anti-virus programs, etc.) to protect the product, the network, its system and the interface against any kind of security breaches, unauthorized access, interference, intrusion, leakage and/or theft of data or information.

ABB Ltd and its affiliates are not liable for damages and/or losses related to such security breaches, any unauthorized access, interference, intrusion, leakage and/or theft of data or information.

Specification

Electrical

Power supply ranges

100 to 240 V AC $\pm 10\%$ (90 min. to 264 V max.)
50 / 60 Hz
24 V DC (23.0 to 24.5 V DC)

Power consumption

25 W max.

Isolation

500 V DC to earth (ground).

General safety

EN61010-1
cULus
Overvoltage Class III on mains,
Class II on inputs and outputs
Pollution category 2

Physical

Size – mm (in.)

Height and width: 144 x 144 (5.7 x 5.7)
Depth behind panel: 147 (5.8)
(including terminal cover)

Weight – kg (lb)

2.0 (4.4) approx. (unpacked)

EMC

Emissions & Immunity

Meets
requirements of: EN50081-2
EN50082-2
EN61326 for an industrial environment

Environmental

Operating temperature range

0 to 50 °C (32 to 122 °F)

Storage temperature range

-10 to 60 °C (14 to 140 °F)

Humidity range

5 to 95 % RH (non-condensing)

Front panel sealing

IP66 and NEMA4X

Rear panel sealing

IP40 (with rear cover)
IP20 (without rear cover)

Vibration

Conforms to EM60068-2

1 Locating the recorder



WARNING

- Locate the recorder in a position where its temperature and humidity specification are not exceeded and ensure it is suitably protected from direct sunlight, rain, snow and hail.
- Select a location away from strong electrical and magnetic fields. If this is not possible, particularly in applications where mobile communications equipment is expected to be used, screened cables within flexible, earthed metal conduit must be used.

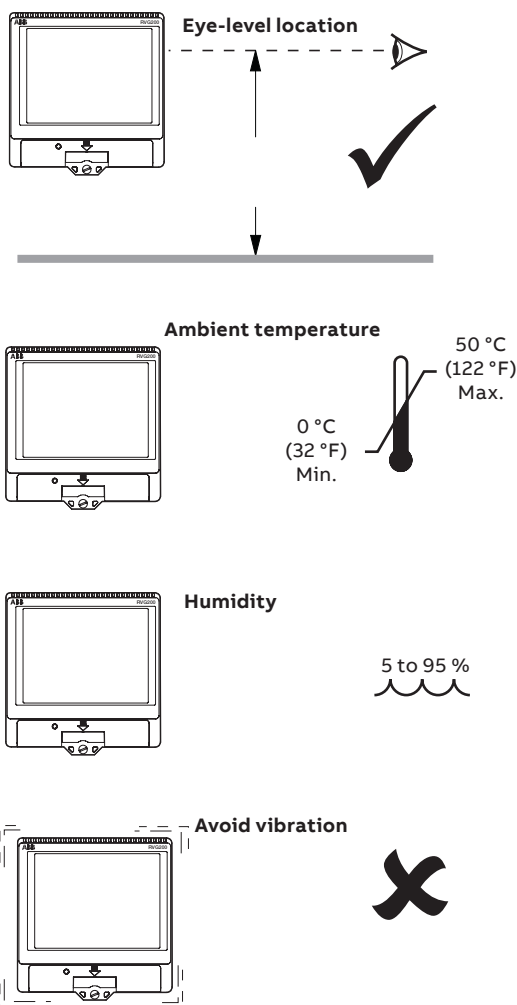

Figure 1 Locating the recorder

2 Panel-mounting the recorder

Referring to Figure 2:

- 1 Cut the correct sized hole (A) in the panel.
- 2 Insert recorder (B) into the panel cut-out.
- 3 Fit upper and lower panel clamps (C) to the recorder.
- 4 Tighten the clamping screws (D) evenly and securely to a torque of 0.2 Nm (1.77 lbf.in).



CAUTION

Correct tightening of the clamping screws is critical to ensure proper compression of the panel seal and achieve the IP66 / NEMA 4X hose-down rating.

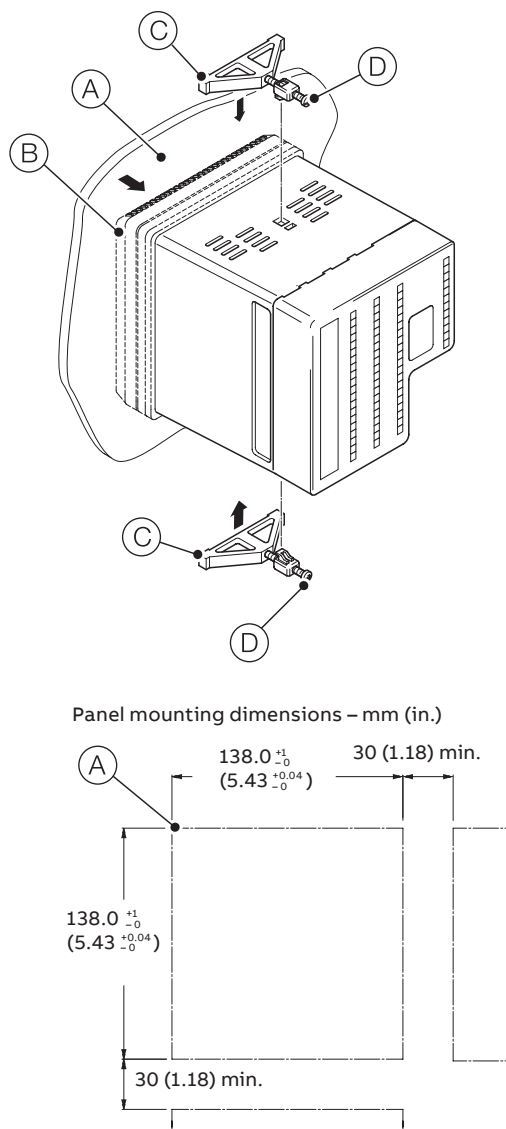

Figure 2 Panel-mounting the recorder

3

Electrical connections



WARNING

- The recorder is not fitted with a switch therefore a disconnecting device such as a switch or circuit breaker conforming to local safety standards must be fitted to the final installation. It must be fitted in close proximity to the recorder, within easy reach of the Operator and marked clearly as the disconnection device for the recorder. A fuse must be fitted in accordance with Figure 4.
- Remove all power from supply, relay and any powered control circuits and high common mode voltages before accessing or making any connections.
- Use cable appropriate for the load currents: 3-core cable rated 3 A and 90 °C (194 °F) minimum, that conform to either IEC 60227 or IEC 60245. The terminals accept cables from 0.8 to 2.5 mm² (18 to 14 AWG).
- The recorder conforms to Installation Category II of IEC 61010.
- All connections to secondary circuits must have basic insulation.
- After installation, there must be no access to live parts, for example, terminals.
- Terminals for external circuits are for use only with equipment with no accessible live parts.
- If the recorder is used in a manner not specified by the Company, the protection provided by the equipment may be impaired.
- All equipment connected to the recorder's terminals must comply with local safety standards (IEC 60950, EN61010-1).



IMPORTANT (NOTE)

- Always route signal leads and power cables separately, preferably in earthed (grounded) metal conduit.
- Use screened cable for signal inputs and relay connections.
- Replacement of the internal battery (type Varta CR2025 3V lithium cell) must be carried out by an approved technician only.

... 3 Electrical connections

Accessing the recorder connection terminals

Referring to Figure 3:

- 1 Press the terminal cover release plate in recess (A) and pull terminal cover (B) away from the recorder body to expose the terminal connections.

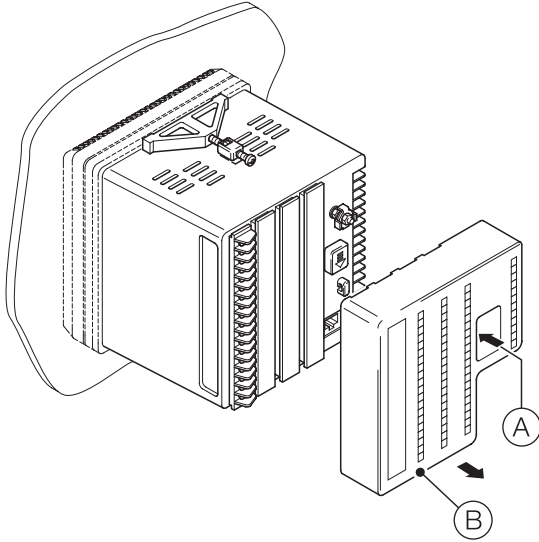

Figure 3 Accessing the recorder connection terminals

Power supply connections

Referring to Figure 4:

- 1 Make connections to the power supply terminals (module position E) as follows:
 - AC supply: terminals 1 (line), 2 (neutral), 3 (ground) or
 - DC supply: terminals 4 (+), 5 (-)



IMPORTANT (NOTE)

Tighten terminal screws to a torque of 0.1 Nm (0.9 lbf.in).

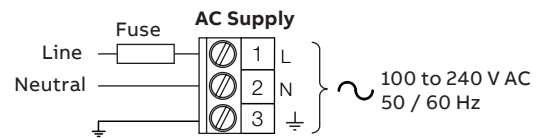
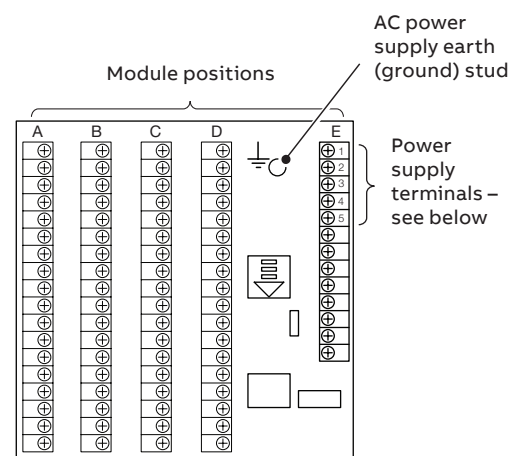

Warning. Use fuse rating 500 mA (maximum) Type T IR (UL category JDYX2)

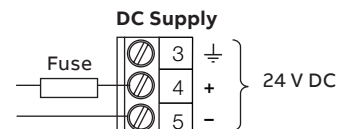

Warning. Use fuse rating 2.5 A (maximum) Type T

Figure 4 Power supply connections and fuse ratings

Analog input / relay / hybrid connections

IMPORTANT (NOTE)

- Tighten terminal screws to a torque of 0.1 Nm (0.9 lbf.in).
- Analog inputs:
 - 3-Lead RTD: 3-leads must have equal resistance, not exceeding 20 W each
 - for mA input types, to ensure loop continuity when the recorder is switched off, fit a suitably-rated diode (for example, type 1N4148 or equivalent)

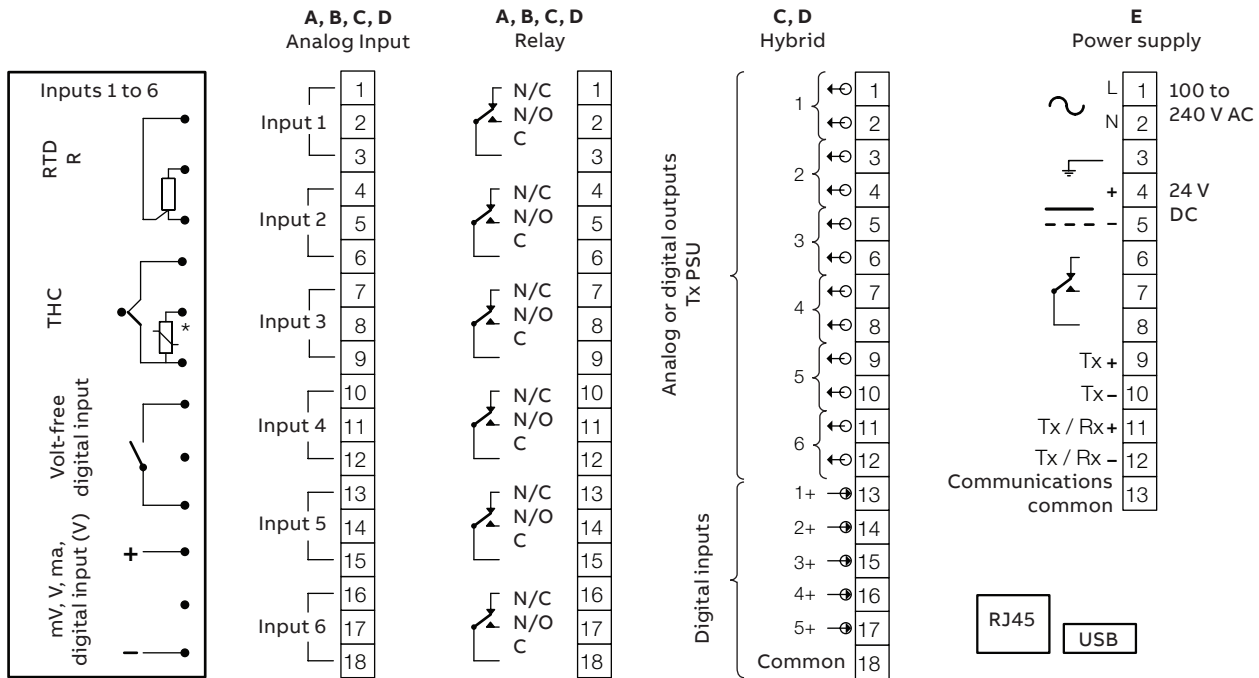

*Each thermocouple input must have either a cold junction assembly (part number CM30/0052) or shorting link (part number RVG200/0118) fitted. Each analog input card with a thermocouple input must have a minimum of 1 cold junction assembly fitted.



Figure 5 Analog input / relay / hybrid connections

Connecting a 2-lead temperature transmitter

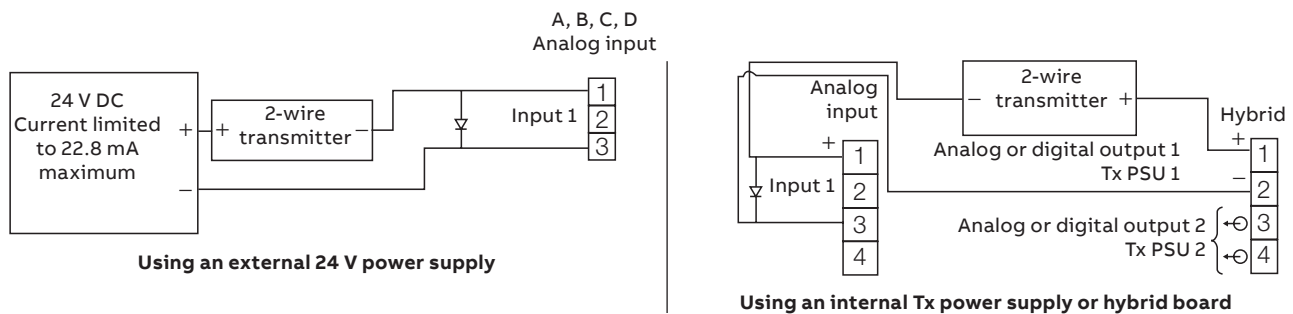

* In the powered-down condition the current input is open circuit. In order to maintain a current loop when the recorder is powered down, fit a zener diode (BZX79 – B/C2V4) to the input as shown.

Figure 6 Connecting a 2-wire temperature transmitter

4 Navigation

Navigating menus

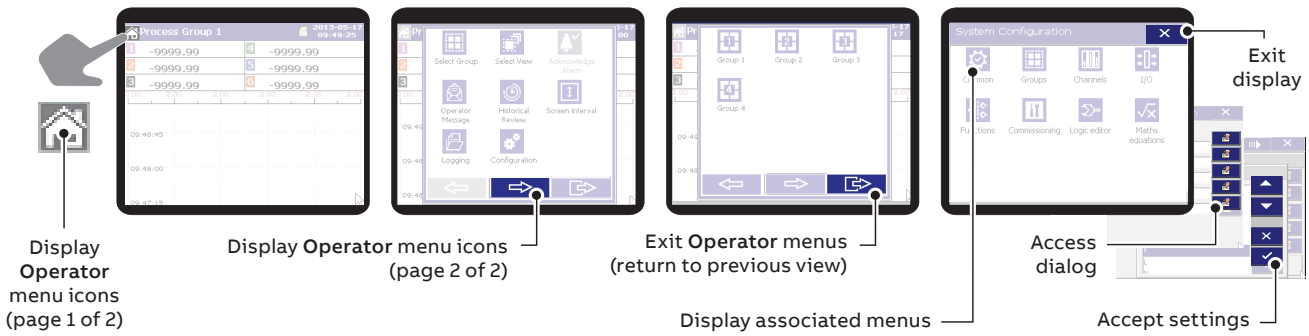

Figure 7 Navigating menus

Navigating groups and views

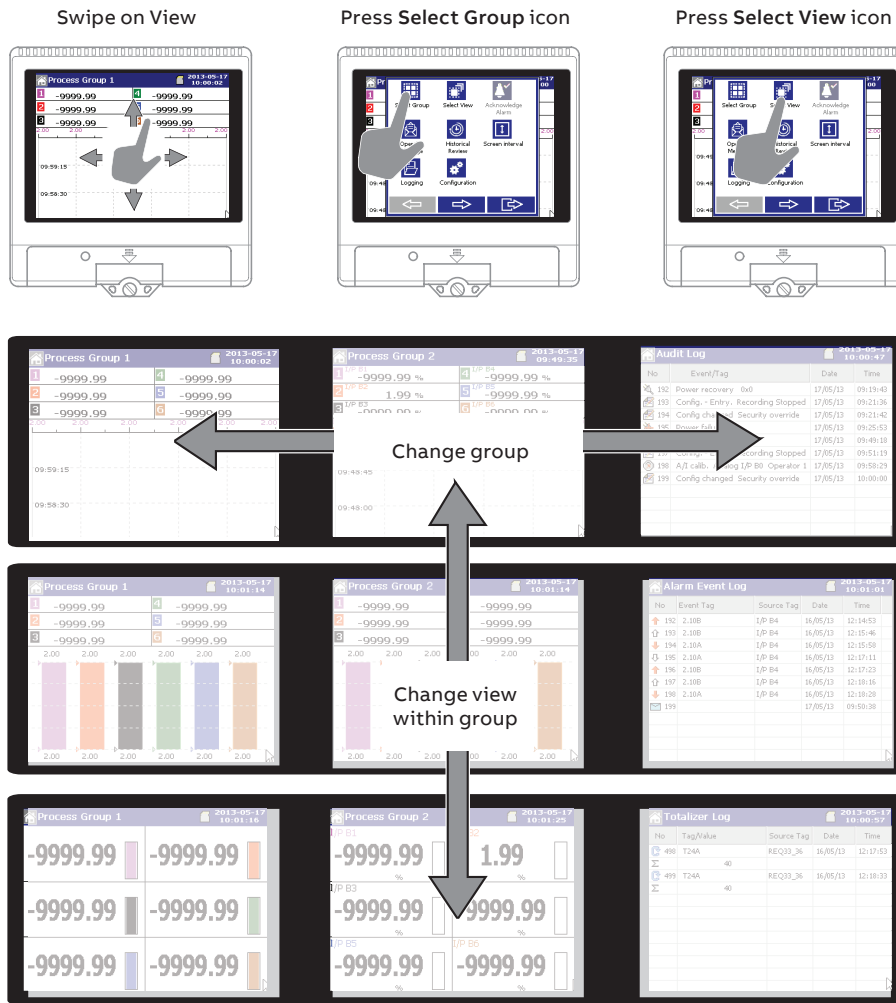

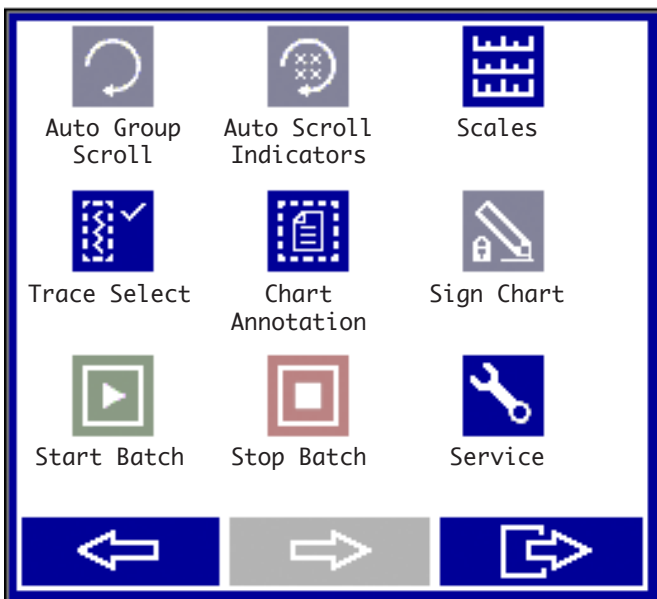
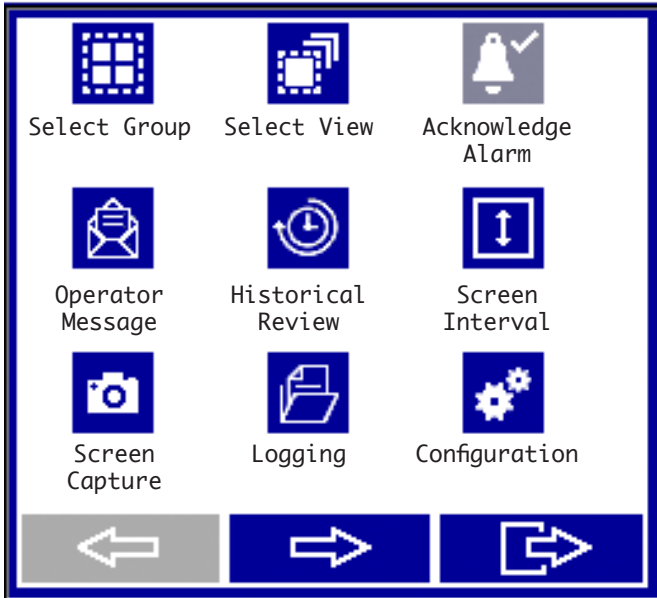

Figure 8 Navigating groups and views

5 Menu overview

Operator menus





Operator menus are accessed by pressing  from any **Operator** or **Log view**. Recorder functions are accessed by pressing the icon associated with the required function.



... 5 Menus overview

Configuration level menus

To access the **Configuration** menus:

- 1 Press  on the first **Operator** menu page.
- 2 Enter an operator password if configured (not set at first-time use).
- 3 Select the required configuration entry mode:
 - a  – Edit a current configuration.
 - b  – Edit an existing configuration stored in the instrument's internal memory or external storage media.
 - c  – Create a new configuration based on the instrument's default configuration.

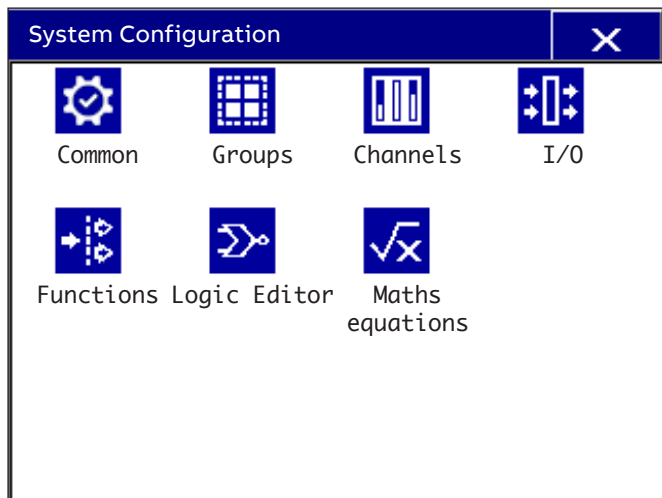

Configuration menu options comprise:

 Common	
Setup	Number of groups Channel Allocation Language Global alarm ack source Instrument tag Options enabled
Archive	Archive Media Wrap Archiving Groups
Screen	Screen saver wait time Screen Capture Brightness Overview Display Chart View Timer Touchscreen Tips
Time	Date and time Daylight Saving – Enable
Security (Basic)	Security type Logging security
User	User 1(4)
Op. Messages 1 ...24	Message 1(24)

 **GROUPS 1 (6)**

Recording

- Tag
- Recording enable source
- Primary sample rate
- Secondary sample rate
- Sample rate select source

Chart

- Chart view enable
- Chart Annotation
- Chart divisions
- Pointers/Indicators
- Screen interval
- Trace width
- Menu enables

Indicator

- Indicator
- Totalizer / statistics
- Bar graph display
- Alarm Trip Points
- Menu enables

Bar

- Bar graph view enable
- Bar graph markers
- Menu enables

Batch (if option enabled)

- Enable Batch Recording
- Start/Stop, Abort
- Operator Login
- Batch Number
- Field 1(3) Title

 **Channels**

Setup

- Source ID
- Trace color / Zone
- Filter type
- Scale Type

Analog I/P

- Input type
- Engineering range
- Tag
- Filter time constant
- Fault detect level
- Broken sensor direction

Alarm A (D)

- Alarm type
- Alarm tag
- Trip
- Hysteresis
- Enable source
- Log Enable/Ack Timeout
- Alarm group

Totalizer A (B) (if option enabled)

- Setup
- Tag/Units
- Stop/Go/Reset
- Timed Reset
- Count range
- Log update
- Count rate/Cut off

... 5 Menus overview

...Configuration level menus

 I/O	
Analog I/P	
Input	Input adjust Operator Calibrate Sensor Calibration
Relay	
Relay F1	Source Polarity
Ethernet	
Ethernet	DHCP IP Address
FTP	FTP user 1 (4)
Modbus TCP	
email	Auto Address Sender Address
Email 1(2)	SMTP Server IP address Recipient 1, 2, 3 Options enabled Trigger 1-5 Trigger 6-10
Modbus TCP	Implementation – Slave Modbus TCP Port Reverse IEEE Data Implementation – Master Modbus TCP Port Poll Rate Poll fail limit Response Timeout
Client Authorization TCP	TCP Client Access Authorized IP 1 – 6
Comms analog I/P	Comms analog I/P Protocol
Comms Digital I/P	Comms Digital I/P Protocol

 Functions	
Linearizer	
	Adjust custom linearizer1 (2)
RTA 1 (4)	
	Alarm tag Daily enables 1st of the month enable On time Duration Log enable

 Logic Editor	
LE 1 (24)	
	Operand / Operator 1 (6) Eqtn tag & log enable

 Maths equations	
Maths 1 (24)	
	Block Type Equation Reset source Engineering range Tag Fault detect level Fault Detect Direction

6 Basic setup

Perform the following steps, in sequence, when setting up the recorder for first-time use – for detailed configuration routines refer to the Operating instructions (OI/RVG200-EN).

Start-up

- 1 Locate and mount the recorder as described in Sections ① and ②.
- 2 Make electrical and signal connections as described in Section ③.
- 3 Power-up the recorder.



IMPORTANT (NOTE)

At power-up, a start-up screen is displayed while a self-test sequence is performed. An operator view is displayed when the self-test sequence is complete and the recorder is ready for operation.

- 4 Proceed to the next step to set the date and time.

Set the date and time

- 1 Press the **Home** icon (🏠) from any Operator or Log view to display page 1 of the Operator menus.
- 2 Press the **Configuration** icon (⚙️) to display the **Select Operator** page.
- 3 Press and at the **Operator 1 – Password (0..9999)** page press again (passwords are not set at first-time use). The **Operator 1 Edit / Open / New configuration** page is displayed.
- 4 Press the **Edit Configuration** icon (⚙️) at the **Operator 1(4)** page to display the **System Configuration** page and press the **Common** icon (⚙️) to display the **Common Configuration** level menus.
- 5 Press the **Time** tab and at the **Date and time** field, press the icon to display the **Date and Time** dialog.
Enter the required information in each field, pressing to accept the content and return to the **Date and Time** dialog.
- 6 When all fields have been set, press to return to the **Common Configuration** level **Time** menu options.

Setup Groups and Channel allocation

- 1 Press the **Setup** tab and at the **Number of Groups** field, press and enter the number of **Groups** required.
Press to return to the **Common Configuration** **Setup** level.
- 2 At the **Channel Allocation** field, press to display the **Group Configuration** dialog. Select the channel(s) to be assigned to each group. When allocation is complete, press to return to the **Common Configuration** **Setup** level.

Set up the archive files

- 1 Press the **Archive** tab to display the associated fields.
- 2 Press the icon associated with each field to enter and configure **Archive** parameters – press to accept the content at each field.
- 3 When all fields have been configured, press to return to the **I/O Groups 1(6)** page then to return to the **Common Configuration** page.
- 4 Press to exit the **Common Configuration** level and return to the **System Configuration** page.

Set the sample rate



- 1 At the **System Configuration** page, press the **Groups** icon (📊) to display the **I/O Groups 1 (6)** page.
- 2 Press the icon associated with the required **Group** (for example) to display the **Group 1 (6)** dialog.
- 3 Press the **Recording** tab and then the icon associated with each field to enter and configure **Recording** parameters – press to accept the content at each field.

Select Operator views and Menu enables

- 1 At the **Group 1 (6)** dialog, select the view(s) required by pressing the **Chart** / **Indicator** / **Bar** tabs to display the associated fields.
- 2 Press the icon associated with each field to enter and configure view parameters (**Chart** / **Indicator** / **Bar**) and **Menu enables** for each view – press to accept the content at each field.
- 3 Proceed to the next section to set up the archive files.



... 6 Basic setup



Change the channel configuration



- 1 At the **System Configuration** page, press the **Channels** icon  to display the **I/O Groups 1(6) Channels** page.
- 2 Press the icon associated with the required **Group 1 (6) Channels** (for example ) to display the **Channel 1 (01 ...06)** dialog.



IMPORTANT (NOTE)

Use the   arrows to select different **Channels** in the same process group.

- 3 Press the **Setup** tab and then the  icon associated with each field to enter and configure **Setup** parameters – press  to accept the content at each field.
- 4 Repeat for all other tabs on the **Channel 1.01 (1.06)** dialog and for all other required channels.

When all fields have been configured, press  to return to the **I/O Groups 1(6) Channels** page then  to return to the **System Configuration** page.

- 5 Proceed to the next section to set up the inputs / outputs (I/O).



Set up the inputs / outputs (I/O)

- 1 At the **System Configuration** page, press the I/O icon  to open an I/O page displaying fitted I/O modules.



IMPORTANT (NOTE)

I/O modules are detected automatically.

- 2 Press the icon associated with the required module to display the dialog and fields associated with that module.
- 3 Configure parameters for each required module.
- 4 When all parameters have been configured, press  to return to the I/O page then  to return to the **System Configuration** page.
- 5 Proceed to the next section to exit **Configuration** level and save changes.

Save current configuration and exit

- 1 Press  at the **System Configuration** page – a prompt is displayed with options to **Apply Changes**, **Export Configuration**, **Return to Configuration Mode** or **Discard Changes**:

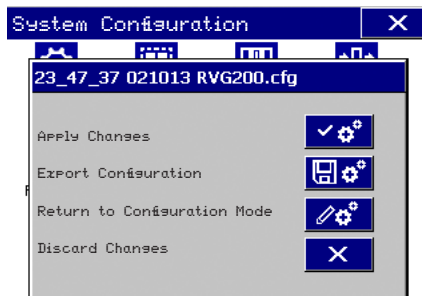

- 2 Press **Apply Changes** () to save the current configuration and return to the **Operator** page.
- 3 Proceed to the next section to start recording.

Start recording (archiving)

- 1 Open the media door and insert the external media card and close the door.

Recording is initiated automatically.

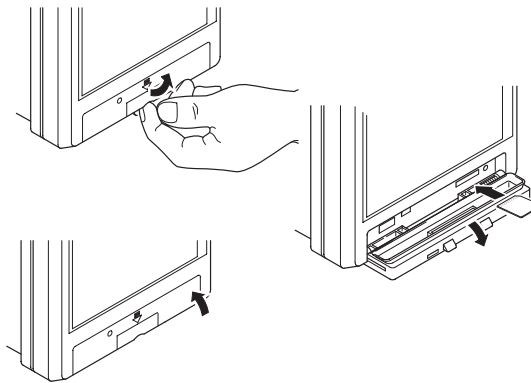

IMPORTANT (NOTE)

Alternative archive media can be used – refer to the Operating instructions (OI/RVG200-EN) for compatible media types.

7 Symbols and icons

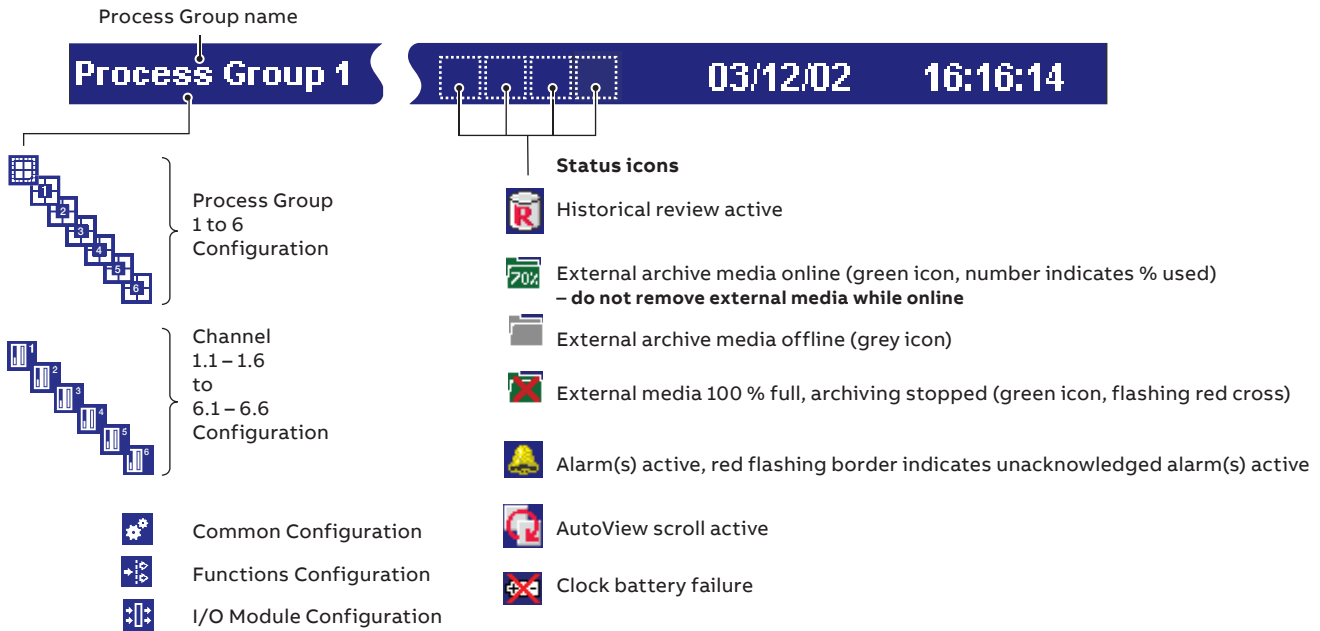

Alarm event icons

Inactive	Active	Description
		High process alarm
		Low process alarm
		Delayed high process alarm
		Delayed low process alarm
		High latch alarm
		Low latch alarm
		Fast rate alarm
		Slow rate alarm
		High annunciate alarm
		Low annunciate alarm
		Real-time alarm
		Alarm acknowledged
		Operator message
		Daylight saving start / end changed
		Electronic Signature

Totalizer icons

	Totalizer started
	Totalizer stopped
	Totalizer wrapped
	Totalizer reset
	Intermediate value reached
	Timed event
	Triggered event
	Power failed
	Power restored
	Batch total
	Maximum value
	Minimum value
	Average value

Audit log icons

	Power failed
	Power restored
	Calibration change
	Configuration change
	File deleted
	Archive media inserted
	Archive media removed
	Archive media offline
	Archive media online
	Archive media full
	System error / reset archiving
	Daylight time or daylight saving start end changed
	FTP Logon



ABB Limited
Measurement & Analytics

Howard Road
St. Neots
Cambridgeshire
PE19 8EU
UK
Tel: +44 (0)870 600 6122
Fax: +44 (0)1480 213 339
Mail: enquiries.mp.uk@gb.abb.com

ABB Inc.
Measurement & Analytics

125 E. County Line Road
Warminster
PA 18974
USA
Tel: +1 215 674 6000
Fax: +1 215 674 7183

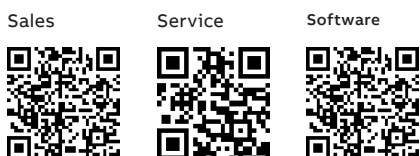
abb.com/measurement



We reserve the right to make technical changes or modify the contents of this document without prior notice. With regard to purchase orders, the agreed particulars shall prevail. ABB does not accept any responsibility whatsoever for potential errors or possible lack of information in this document.

We reserve all rights in this document and in the subject matter and illustrations contained therein. Any reproduction, disclosure to third parties or utilization of its contents – in whole or in parts – is forbidden without prior written consent of ABB.

© ABB 2017