

C1300

Advanced circular chart recorder



Measurement made easy

—
C1300 advanced circular
chart recorder

For more information

Further publications are available for free download
from:

www.abb.com/measurement

or by scanning this code:



Search for or click on

C1300 Advanced circular chart recorder Datasheet	DS/C1300-EN
C1300 Advanced circular chart recorder User Guide supplement Advanced software options	IM/C1300-ADV
C1300 Advanced circular chart recorder User Guide supplement Modbus communications option	IM/C1300-MOD

Electrical Safety

This equipment complies with the requirements of CEI/IEC 61010-1:2001-2 'Safety Requirements for Electrical Equipment for Measurement, Control and Laboratory Use'. If the equipment is used in a manner NOT specified by the Company, the protection provided by the equipment may be impaired.

Symbols

One or more of the following symbols may appear on the equipment labelling:



Warning – refer to the manual for instructions



Caution – risk of electric shock



Protective earth (ground) terminal



Earth (ground) terminal



Direct current supply only



Alternating current supply only



Both direct and alternating current supply



The equipment is protected through double insulation

Information in this manual is intended only to assist our customers in the efficient operation of our equipment. Use of this manual for any other purpose is specifically prohibited and its contents are not to be reproduced in full or part without prior approval of the Technical Publications Department.

Health and Safety

To ensure that our products are safe and without risk to health, the following points must be noted:

- The relevant sections of these instructions must be read carefully before proceeding.
- Warning labels on containers and packages must be observed.
- Installation, operation, maintenance and servicing must only be carried out by suitably trained personnel and in accordance with the information given.
- Normal safety precautions must be taken to avoid the possibility of an accident occurring when operating in conditions of high pressure and/or temperature.
- Chemicals must be stored away from heat, protected from temperature extremes and powders kept dry. Normal safe handling procedures must be used.
- When disposing of chemicals ensure that no two chemicals are mixed.

Safety advice concerning the use of the equipment described in this manual or any relevant hazard data sheets (where applicable) may be obtained from the Company address on the back cover, together with servicing and spares information.

Contents

1	Preparation	2	5	Electrical Installation	64
1.1	Preparing the Recorder for First Use	2	5.1	Identifying the Input/Output Modules	66
1.2	Powering up the Recorder	4	5.2	Channel Connections	66
1.2.1	Recorder Status and Error Page	5	5.2.1	Selecting the Analog Input Type(s)	67
			5.2.2	Voltage and Current	69
			5.2.3	2-wire Transmitter Input)	69
			5.2.4	Thermocouple	69
			5.2.5	Resistance Thermometer (RTD)	69
			5.2.6	Logic Inputs	69
			5.2.7	Analog Output	69
			5.2.8	Relay Output	69
			5.3	Module Connections	70
			5.3.1	Standard I/O or Analog + Relay (Module Types 1, 2 and 7)	70
			5.3.2	Four Relay Module (Module Type 3)	70
			5.3.3	Eight Digital Inputs or Outputs (Module Types 4 and 5 respectively)	70
			5.4	Power Supply Selection and AC Connections	71
2	Operation	6	6	Fault Diagnosis	72
2.1	Display Screens and Operator Keys	6	7	Spares and Accessories	73
2.2	Input Error Messages and Alarm Icons	7	8	Specification	74
2.3	Operating Pages	8		Appendix A – Signal Sources	77
2.3.1	Accessing the Operating Pages	8		Appendix B – Units	78
2.3.2	Autoscroll	9		Appendix C – Installation Record	80
2.3.3	Input (Pen) Channel Display – Separate	10		Index	82
2.3.4	Input (Pen) Channel Display – Dual	11		Acknowledgments	84
2.3.5	Input (Pen) Channel Display – Separate and Dual	12			
2.3.6	Totalizer Display – Separate	13			
2.3.7	Totalizer Display – Rate with Total	13			
2.3.8	Totalizer Display – Total with Rate	14			
2.3.9	Totalizer Display – Dual Total	14			
2.3.10	Totalizer Display – Dual + Flow Rate	15			
2.3.11	Data Logging	15			
2.4	Totalizer Log	16			
2.5	Totalizer Control	17			
2.6	Alarm Set Point Adjustment	18			
3	Configuration	19			
3.1	Introduction	19			
3.2	Preparation for Configuration	19			
3.3	Configuration Level Security	19			
3.4	Common Configuration	20			
3.5	Channels Configuration	24			
3.6	Alarms Configuration	31			
3.7	Totalizer Configuration	35			
3.8	Relay Configuration	42			
3.9	Digital Input and Output Configuration	43			
3.10	Analog Output Configuration	45			
3.11	Logic Equation Configuration	47			
3.12	Data Logging Configuration	50			
3.13	System Clock Configuration	54			
3.14	Pen Function	55			
3.15	Calibration	56			
3.16	Backing Up and Restoring Configurations	58			
3.16.1	Backing Up a Configuration	58			
3.16.2	Restoring a Configuration	59			
4	Mechanical Installation	60			
4.1	Siting	60			
4.2	Mounting	61			
4.2.1	Wall-/Pipe-Mounting	62			
4.2.2	Panel Mounting	63			

1 Preparation

1.1 Preparing the Recorder for First Use

Prepare the recorder for first use as follows:

1. Install the recorder – see Section 4, page 60.
2. Connect the recorder – see Section 5, page 64.

Warning. Ensure all connections are made correctly, especially to the earth (ground) stud – see Section 5.4, page 71.

3. Switch on the power supply to the recorder.

Note. On power-up, the pen arm(s) is (are) moved to an off-chart position for automatic referencing. Pen chatter may occur on the pen(s) nearest the reference position. This is a normal function of the recorder.

4. Fit the pen capsule(s) – see Fig. 1.1.

Note.

- Ensure the correct colored capsule is fitted to the appropriate pen arm. Each pen arm is identified by a colored band – see Fig. 1.1.
- If the violet, true-time line event option is fitted, the pen records on the same time line as the red pen, but on the outer edge of the chart.

5. Fit a chart – see Fig. 1.2 on page 3.

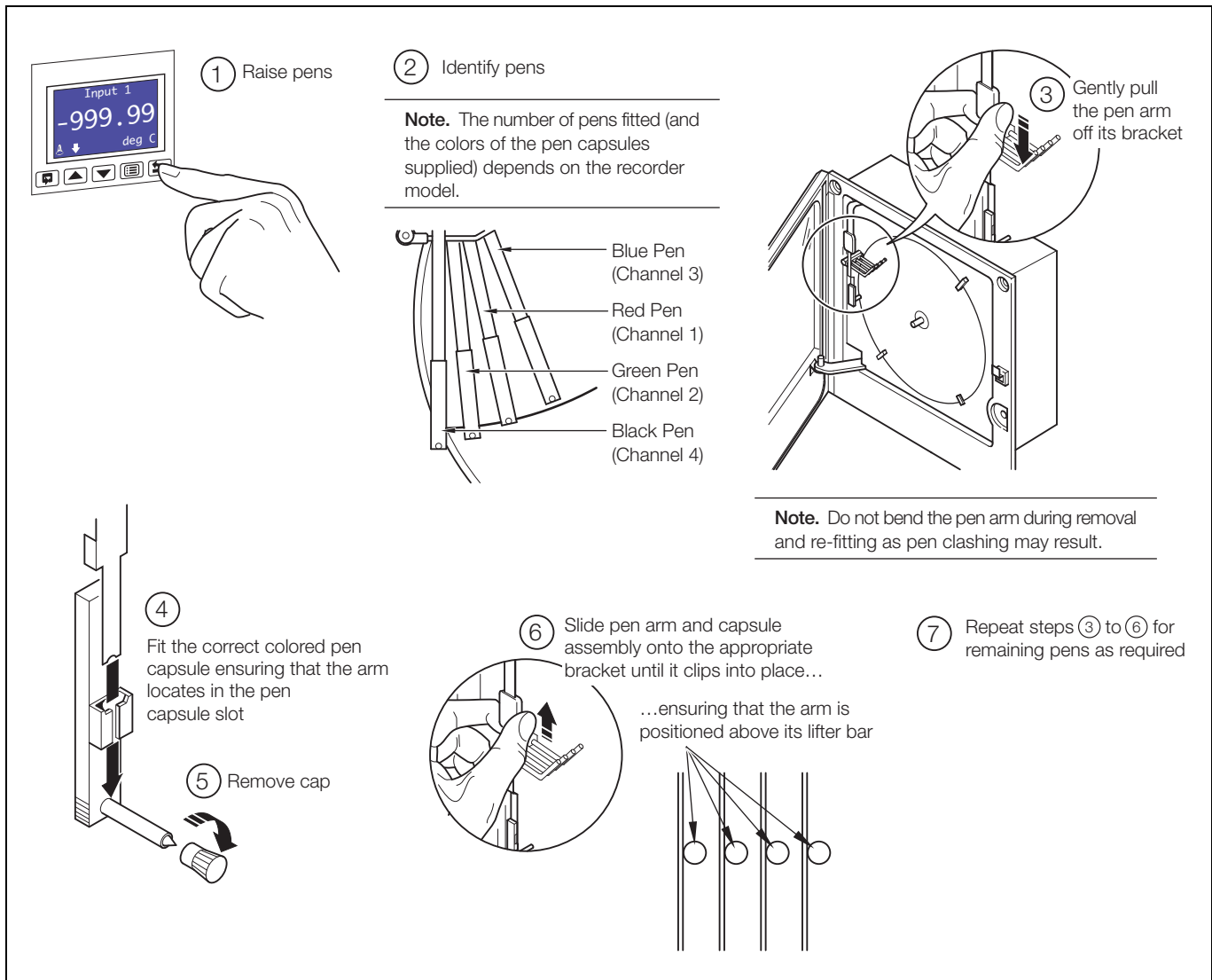

Fig. 1.1 Fitting the Pen Capsule(s)

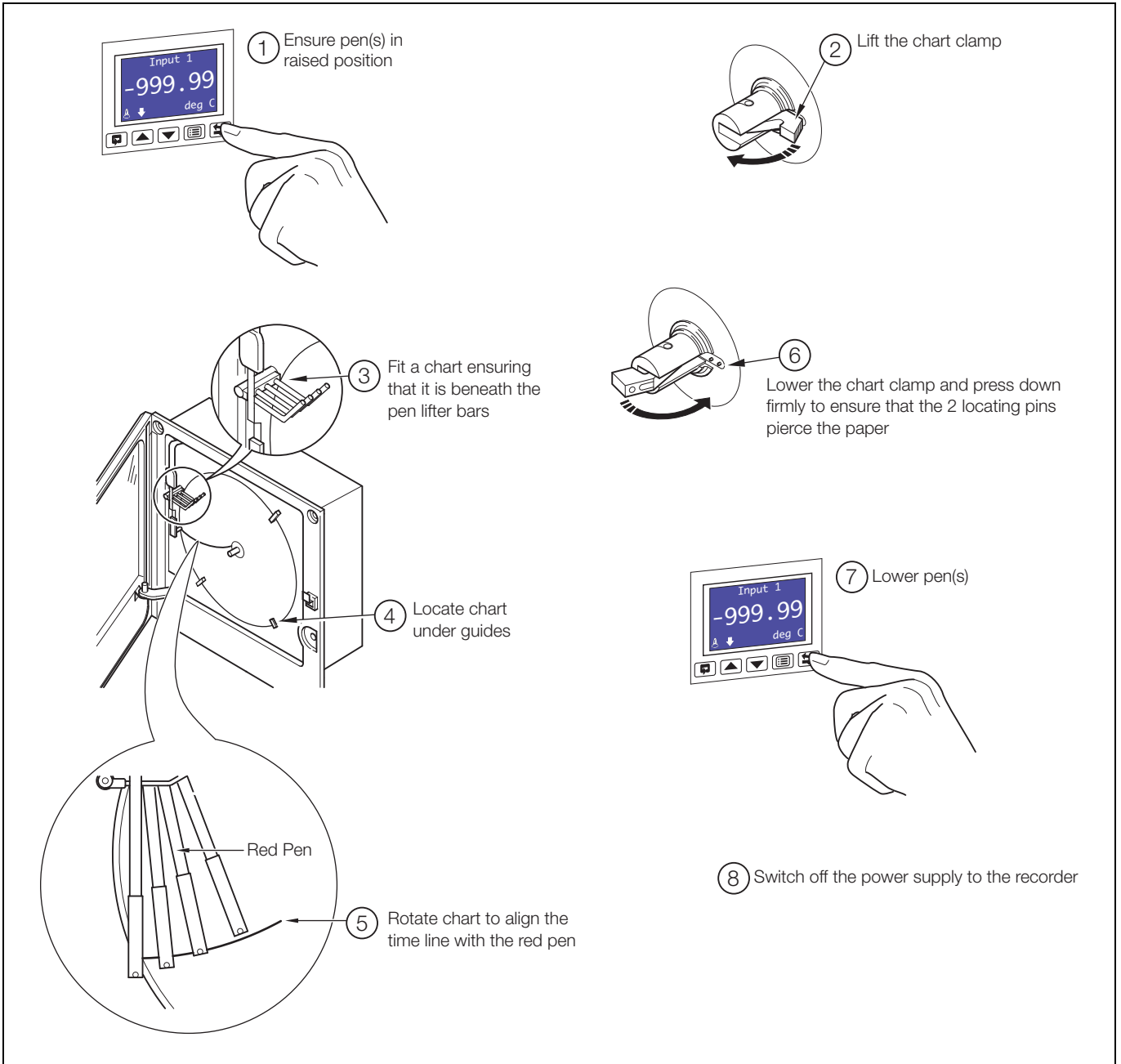

Fig. 1.2 Fitting a Chart

1.2 Powering up the Recorder

To power up the recorder:

1. Switch on the supply to the recorder, any power-operated control circuits and the input signals. Wait for the pens to settle.
2. The start-up self-test sequence shown in Fig. 1.3 is shown on display screen 1 when the power supply is first switched on.

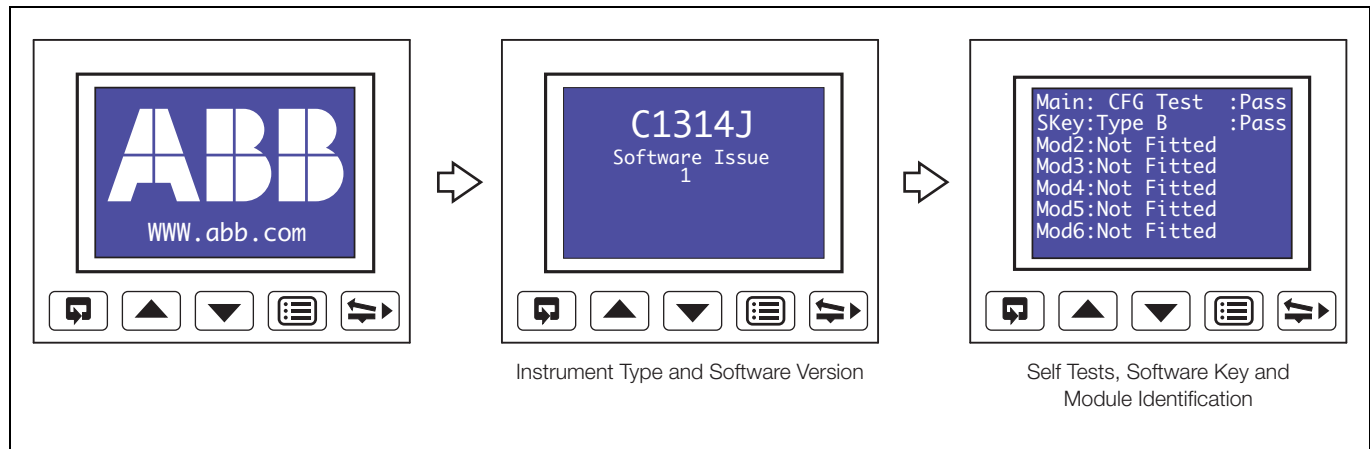

Fig. 1.3 Recorder Start-up Self-test Sequence

1.2.1 Recorder Status and Error Page

If any of the start-up self-tests (see Fig. 1.3) fail, the error message 'Fail' is displayed. Refer to Fig. 1.4 for possible cause and remedial action information.

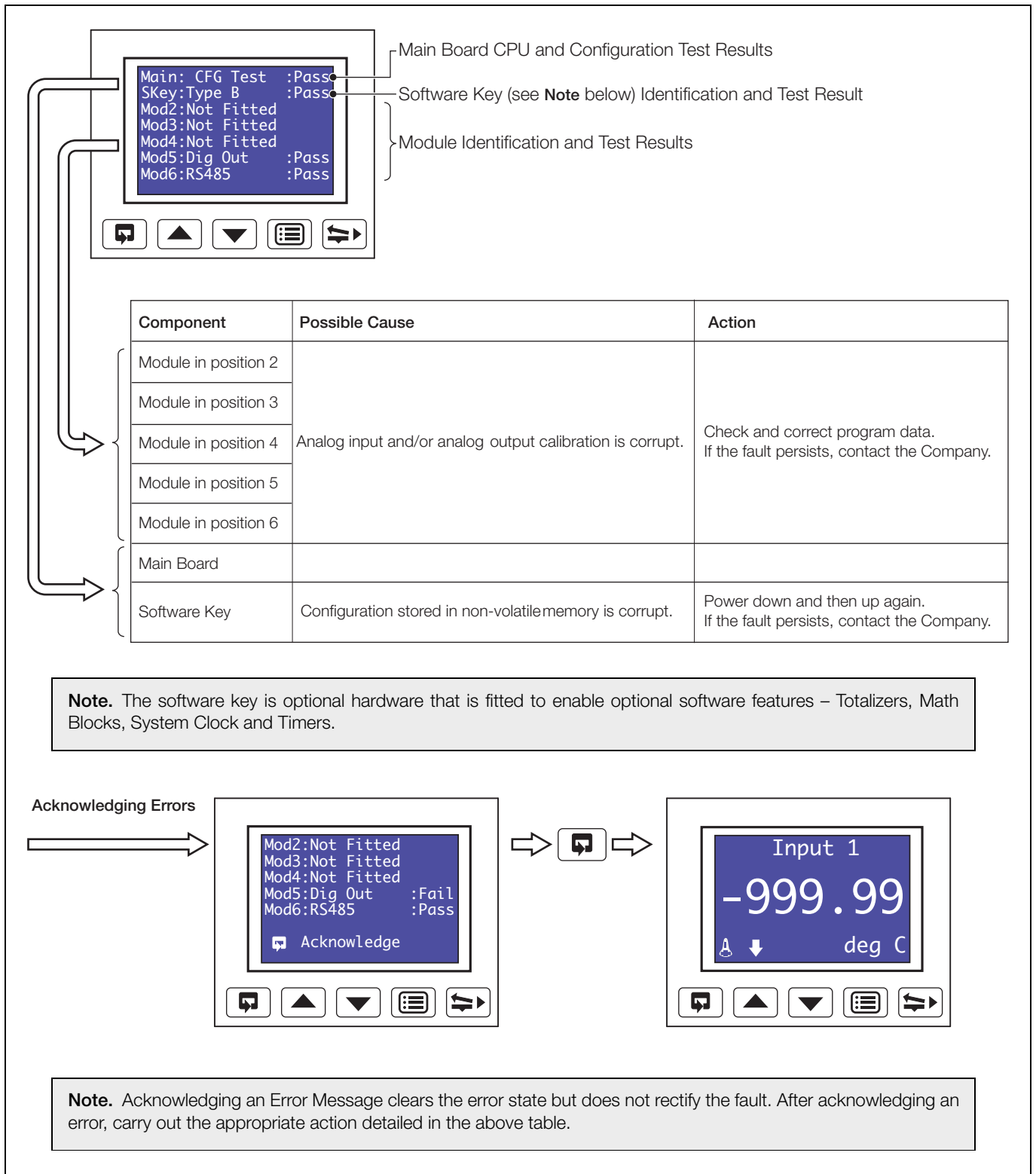

Fig. 1.4 Start-up Error Messages

2 Operation

2.1 Display Screens and Operator Keys

Up to two faceplates are fitted to the front of the recorder, each comprising a display screen and associated operator keys – see Fig. 2.1.

Each high resolution, dot matrix display screen shows the operating and programming information for up to two input channels in a variety of formats.

Alarm states are indicated by icons in the lower left corner of the display screen(s) – see Fig. 2.3 on page 7.

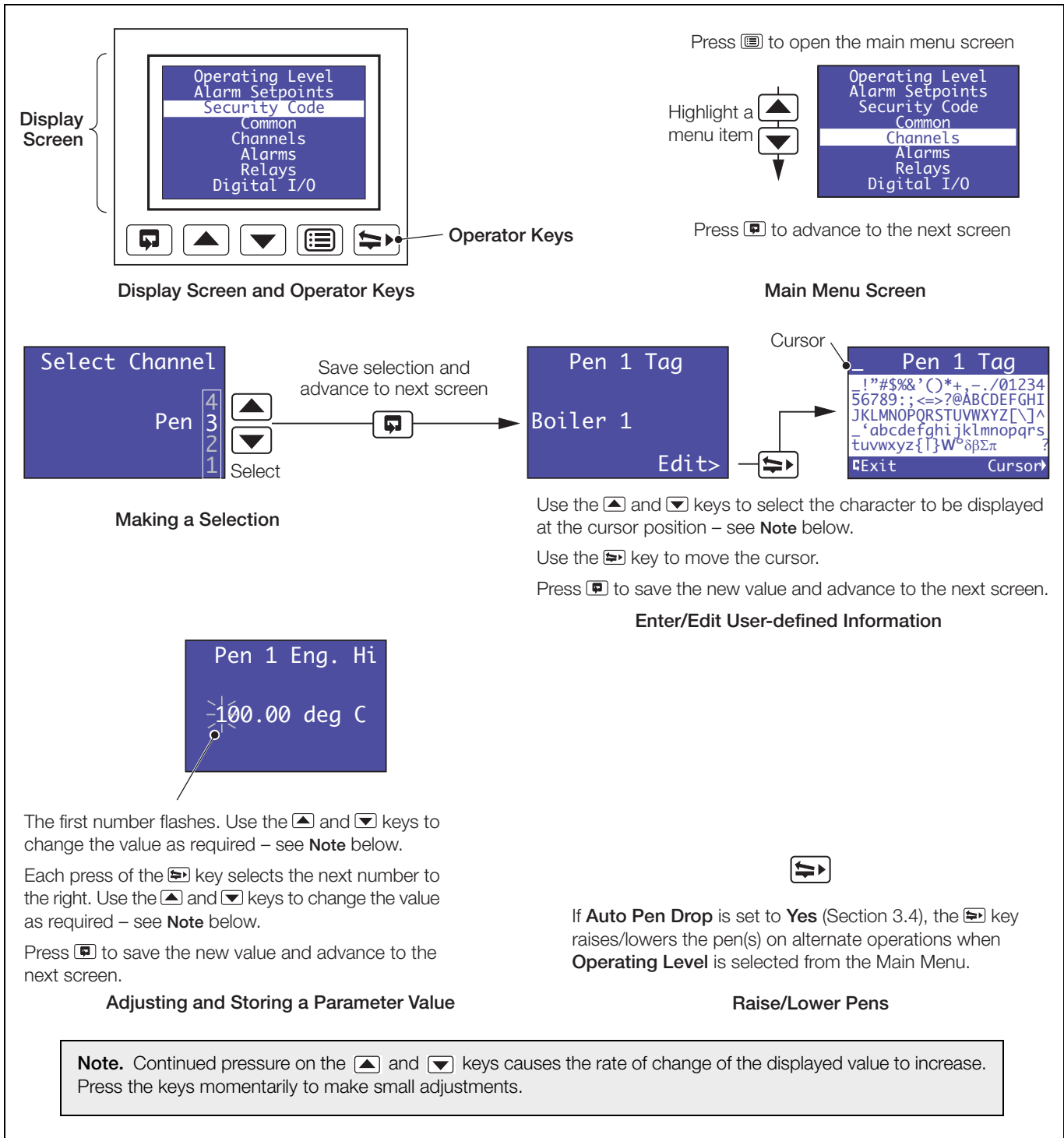

Fig. 2.1 Display Screen and Operator Keys

The recorder has dedicated *Operating Pages* in the **Operating Level** – see Sections 2.3 to 2.6. These pages display the process measurements and are not affected by the security system which inhibits access to the **Configuration Pages** – see Section 3.3, page 19.

2.2 Input Error Messages and Alarm Icons

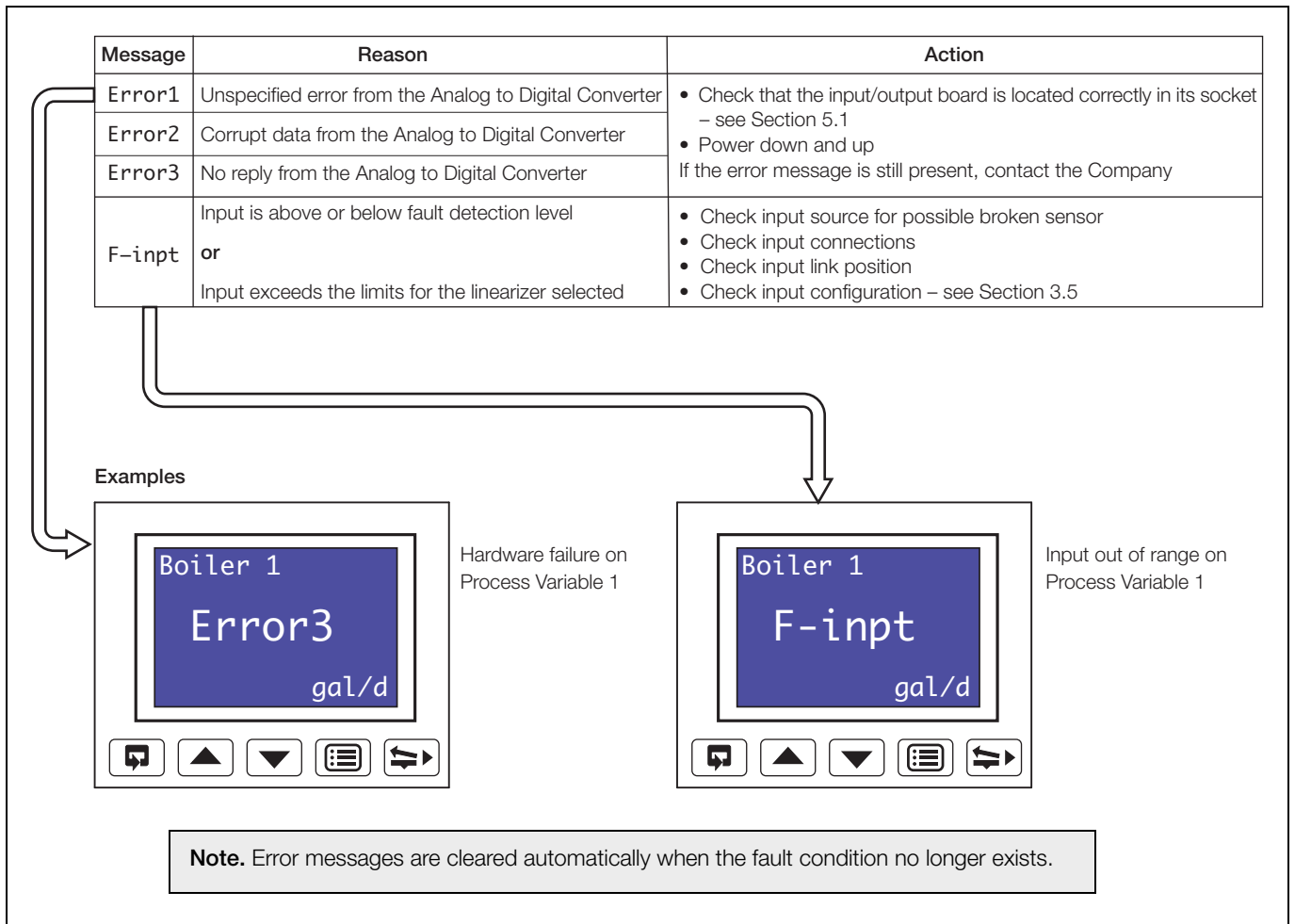

Fig. 2.2 Input Error Messages Displayed in the Operating Page

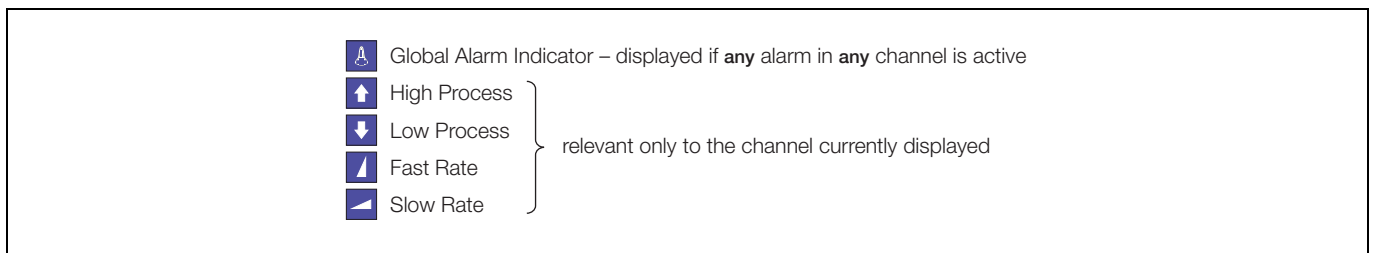

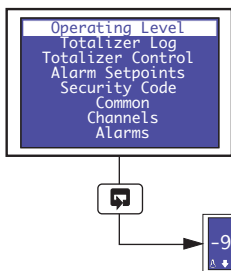



Fig. 2.3 Alarm Icons

2.3 Operating Pages Overview.

- The following information is displayed in the Operating Pages:
 - Input (pen) channel readings
 - Data logging status (if data logging option is enabled by installation of the appropriate hardware)
 - System time/date (if any one of the Totalizer, Math or Timers software options are enabled by installation of the appropriate software key)
 - Totalizer readings (if the totalizer software option is enabled by installation of the appropriate software key)
 - Totalizer log (if the totalizer software option is enabled by installation of the appropriate software key)
 - Totalizer control (if the totalizer software option is enabled **and Totalizer Reset** is set to **YES** – see Section 3.4, page 20.)
 - Alarm set points (if **Alarm Adjust** is set to **Yes** – see Section 3.4, page 20.)
- The Input (pen) channel and totalizer displays are configured separately (see **Pen Ch Display** and **Totals Display** in Section 3.4) and each can be displayed in one of several ways. Input channel information can be displayed without totalizer information and vice-versa.
- Input channel 1 and 2 information and system time/date is shown on display screen 1.
- If the recorder is fitted with the optional second faceplate:
 - Input channel 3 and 4 information, together with system time/date is shown on display screen 2
 - Totalizer logs, totalizer control and alarm set point adjustment for pens 3 and 4 and associated totalizers are accessed from the menu shown on display screen 2 when the  key is pressed on faceplate 2.
- Totalizer information is shown on the same display screen as the pen to which the totalizer is assigned.
- All channel and totalizer configuration is done using faceplate 1.

2.3.1 Accessing the Operating Pages



Press the  key to open the **Main Menu**.



Highlight **Operating Level**.

see Section 2.3.3, page 10.

2.3.2 Autoscroll

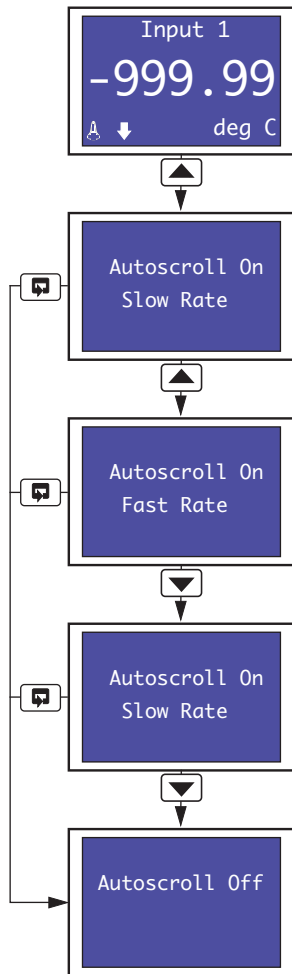



Autoscroll

When **Autoscroll** is set to **On**, each *Operating Page* screen is displayed in turn for a period of time determined by the rate selected:

Slow Rate – each screen is displayed in turn for 10 seconds

Fast Rate – each screen is displayed in turn for 5 seconds

Press the  key from any *Operating Page* screen to initiate Autoscroll in Slow Rate mode.

Press the  key again to switch to Fast Rate mode.

When in Fast Rate mode, press the  key to switch to Slow Rate mode.

When in Slow Rate mode, press the  key to switch Autoscroll off.

Press the  key at any time to switch Autoscroll off.

2.3.3 Input (Pen) Channel Display – Separate

The following screens are displayed only if **Pen Ch Display** is set to **Separate** – see Section 3.4, page 20.

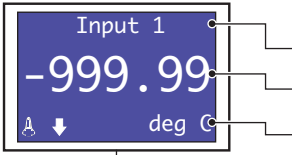

Input Channel 1 (Pen 1)

- Channel tag.
- Measured value.
- Alarm icons and measured value units.

Note. If **Pen 1 Source** is set to **None** (Section 3.14), only a measured value of 0 is displayed.

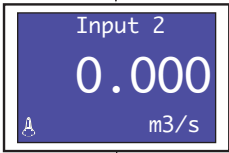

Input Channel 2 (Pen 2)

Note. If **Pen 2 Source** is set to **None** (Section 3.14), only a measured value of 0 is displayed.



Totalizer, Math or Timers software options not enabled by installation of the appropriate software key **and** optional Data Logging hardware not installed – return to top of page.



Totalizer software option enabled by installation of the appropriate software key **and** **Totals Display** not set to **Off** (Section 3.4) – see Sections 2.3.6 to 2.3.10.



Optional Data Logging hardware installed – see Section 2.3.11, page 15.



Optional Data Logging hardware not installed **and** Totalizer software option enabled by installation of the appropriate software key **and** **Totals Display** set to **Off** (Section 3.4) – continued below.

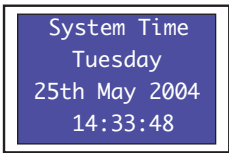

System Time/Date Display

Notes.

- Available only if any one of the Totalizer, Math or Timers software options are enabled by installation of the appropriate software key, or the optional Data Logging hardware is installed.
- If **Pen Ch Display and Totals Display** are set to **Off** (Section 3.4) and any of the above software options are enabled and the optional Data Logging hardware is not installed, the **System Time Display** is the only *Operating Page* screen available.



Return to top of page.

2.3.4 Input (Pen) Channel Display – Dual

The following screens are displayed only if **Pen Ch Display** is set to **Dual** – see Section 3.4, page 20.

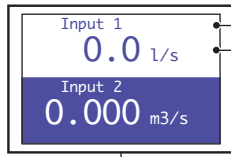

Input Channels 1 and 2 (Pens 1 and 2)

Channel tag.

Measured value and units.

Note. If **Pen X Source** (where **X** is the pen number) is set to **None** (Section 3.14), only a measured value of 0 is displayed for that channel.



Totalizer, Math or Timers software options not enabled by installation of the appropriate software key **and** optional Data Logging hardware not installed – return to top of page.



Totalizer software option enabled by installation of the appropriate software key **and** **Totals Display** not set to **Off** (Section 3.4) – see Sections 2.3.6 to 2.3.10.



Optional Data Logging hardware installed – see Section 2.3.11, page 15.



Optional Data Logging hardware not installed **and** Totalizer software option enabled by installation of the appropriate software key **and** **Totals Display** set to **Off** (Section 3.4) – see Section 2.3.3, page 10.

2.3.5 Input (Pen) Channel Display – Separate and Dual

The following screens are displayed only if **Pen Ch Display** is set to **Separate & Dual** – see Section 3.4, page 20.

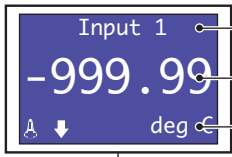

Input Channel 1 (Pen 1)

- Channel tag.
- Measured value.
- Alarm icons and measured value units.

Note. If **Pen 1 Source** is set to **None** (Section 3.14), only a measured value of 0 is displayed.

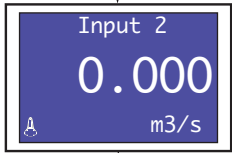

Input Channel 2 (Pen 2)

Note. If **Pen 2 Source** is set to **None** (Section 3.14), only a measured value of 0 is displayed.

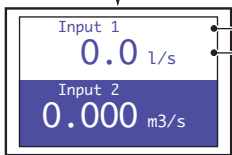

Input Channels 1 and 2 (Pens 1 and 2)

- Channel tag.
- Measured value and units.

Note. If **Pen X Source** (where **X** is the pen number) is set to **None** (Section 3.14), only a measured value of 0 is displayed for that channel.

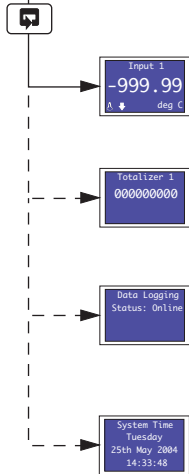

Totalizer, Math or Timers software options not enabled by installation of the appropriate software key **and** optional Data Logging hardware not installed – return to top of page.



Totalizer software option enabled by installation of the appropriate software key **and** **Totals Display** not set to **Off** (Section 3.4) – see Sections 2.3.6 to 2.3.10.



Optional Data Logging hardware installed – see Section 2.3.11, page 15.



Optional Data Logging hardware not installed **and** Totalizer software option enabled by installation of the appropriate software key **and** **Totals Display** set to **Off** (Section 3.4) – see Section 2.3.3, page 10.

2.3.6 Totalizer Display – Separate

The following screens are displayed only if **Totals Display** is set to **Separate** (Section 3.4) **and Tot X Source** (where **X** is the totalizer number) is set to anything other than **None** – see Section 3.7, page 35.

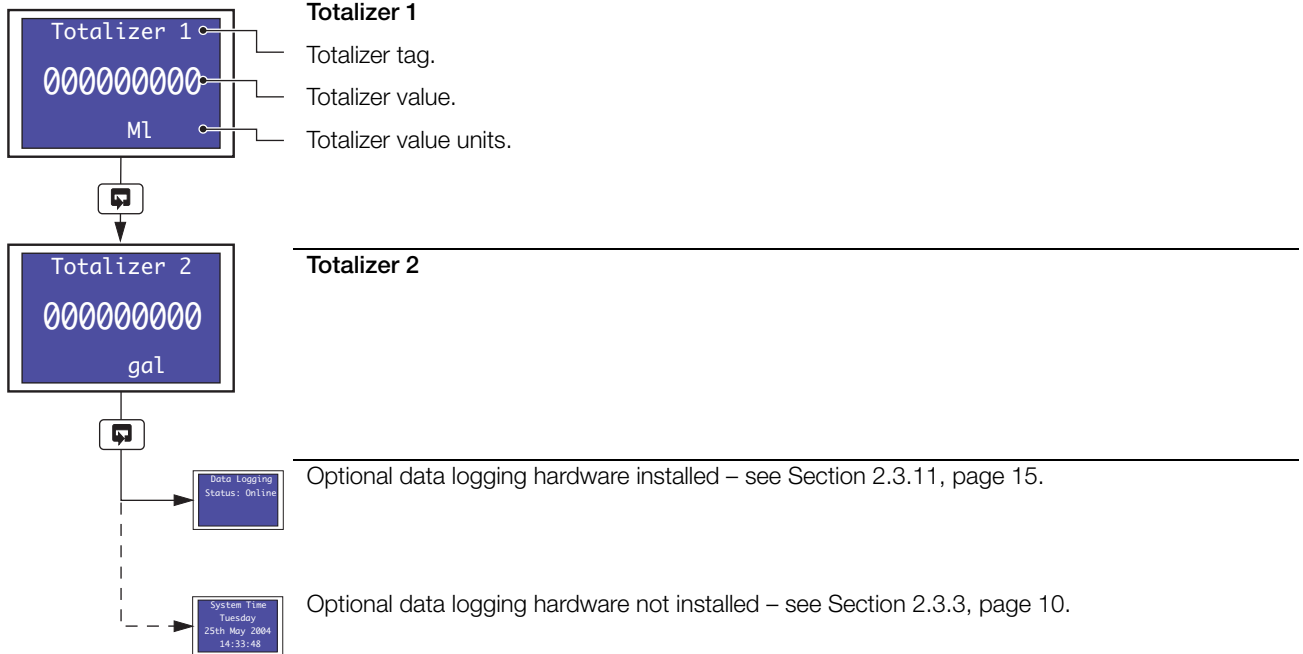

2.3.7 Totalizer Display – Rate with Total

The following screens are displayed only if **Totals Display** is set to **Rate with Total** (Section 3.4) **and Tot X Source** (where **X** is the totalizer number) is set to anything other than **None** – see Section 3.7, page 35.

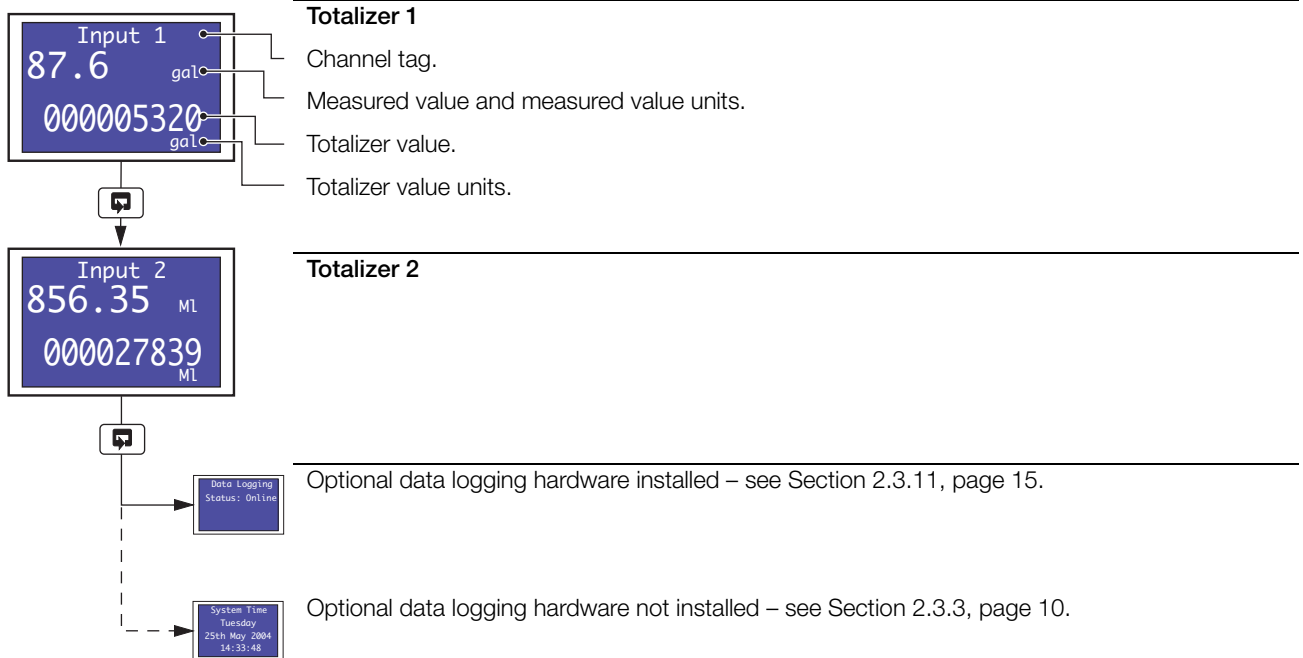

2.3.8 Totalizer Display – Total with Rate

The following screens are displayed only if **Totals Display** is set to **Total with Rate** (Section 3.4) **and Tot X Source** (where **X** is the totalizer number) is set to anything other than **None** – see Section 3.7, page 35.

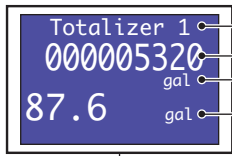

Totalizer 1

- Totalizer tag.
- Totalizer value.
- Totalizer units.
- Measured value and measured value units.

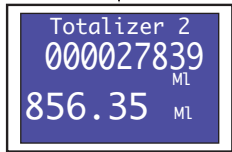

Totalizer 2



Optional data logging hardware installed – see Section 2.3.11, page 15.



Optional data logging hardware not installed – see Section 2.3.3, page 10.

2.3.9 Totalizer Display – Dual Total

The following screen is displayed only if **Totals Display** is set to **Dual Total** (Section 3.4) **and Tot X Source** (where **X** is the totalizer number) is set to anything other than **None** – see Section 3.7, page 35.

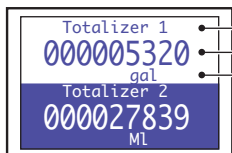

Totalizers 1 and 2

- Totalizer tag.
- Totalizer value.
- Totalizer units.



Optional data logging hardware installed – see Section 2.3.11, page 15.



Optional data logging hardware not installed – see Section 2.3.3, page 10.

2.3.10 Totalizer Display – Dual + Flow Rate

The following screen is displayed only if **Totals Display** is set to **Dual + Flow Rate** (Section 3.4) **and Tot X Source** (where **X** is the totalizer number) is set to anything other than **None** – see Section 3.7, page 35.

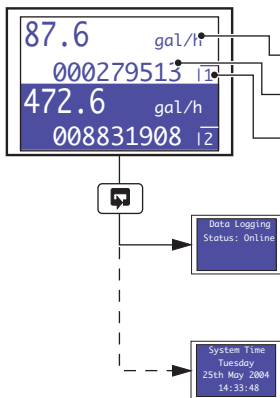

Totalizers 1 and 2

- Measured value and measured value units.
- Totalizer value.
- Totalizer units and channel number.

Optional data logging hardware installed – see Section 2.3.11, below.

Optional data logging hardware not installed – see Section 2.3.3, page 10.

2.3.11 Data Logging

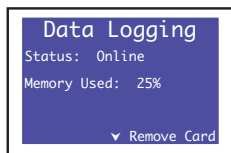

Data Logging Status

Provides information on current data logging status.



Press the  key to place data logging off-line.

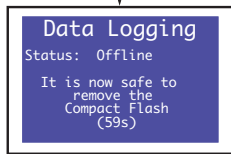

When data logging is off-line, the Compact Flash card can be removed safely.

If the card is not removed within 1 minute, data logging is placed on-line automatically. A timer indicates the number of seconds remaining before data logging resumes.

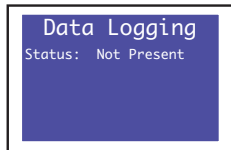

This screen is displayed when a Compact Flash card is not inserted.

Data logging starts automatically when a Compact Flash card is inserted.





see Section 2.3.3, page 10.

2.4 Totalizer Log

Note.

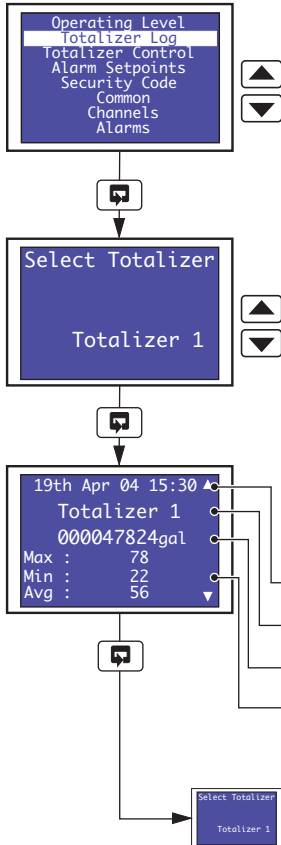
- The totalizer log is available only if the totalizer software option is enabled by installation of the appropriate software key.
- The recorder can store up to 21 log entries for each enabled totalizer. When the maximum number of entries has been reached, the oldest data is overwritten by the newest.
- A new log entry is created for each totalizer at the interval selected in the **Tot X Log Enable** parameter (where **X** is the totalizer number) – see Section 3.7, page 35.



Press the  key to open the **Main Menu**.

Highlight **Totalizer Log**.

Select Totalizer

Select the totalizer log to display.

Totalizer Log

The first log displayed for the selected totalizer is the most recent. Use the  key to display each log in descending date order.

Date and time.

Totalizer tag.

Current value and units.

Maximum, minimum and average values.

Note. If no log entries exist, **Log is empty** is shown on the display screen.

Return to top of page.

2.5 Totalizer Control

Note. Totalizer control is available only if the totalizer software option is enabled by installation of the appropriate software key **and** **Totalizer Reset** is set to **YES** – see Section 3.4, page 20.

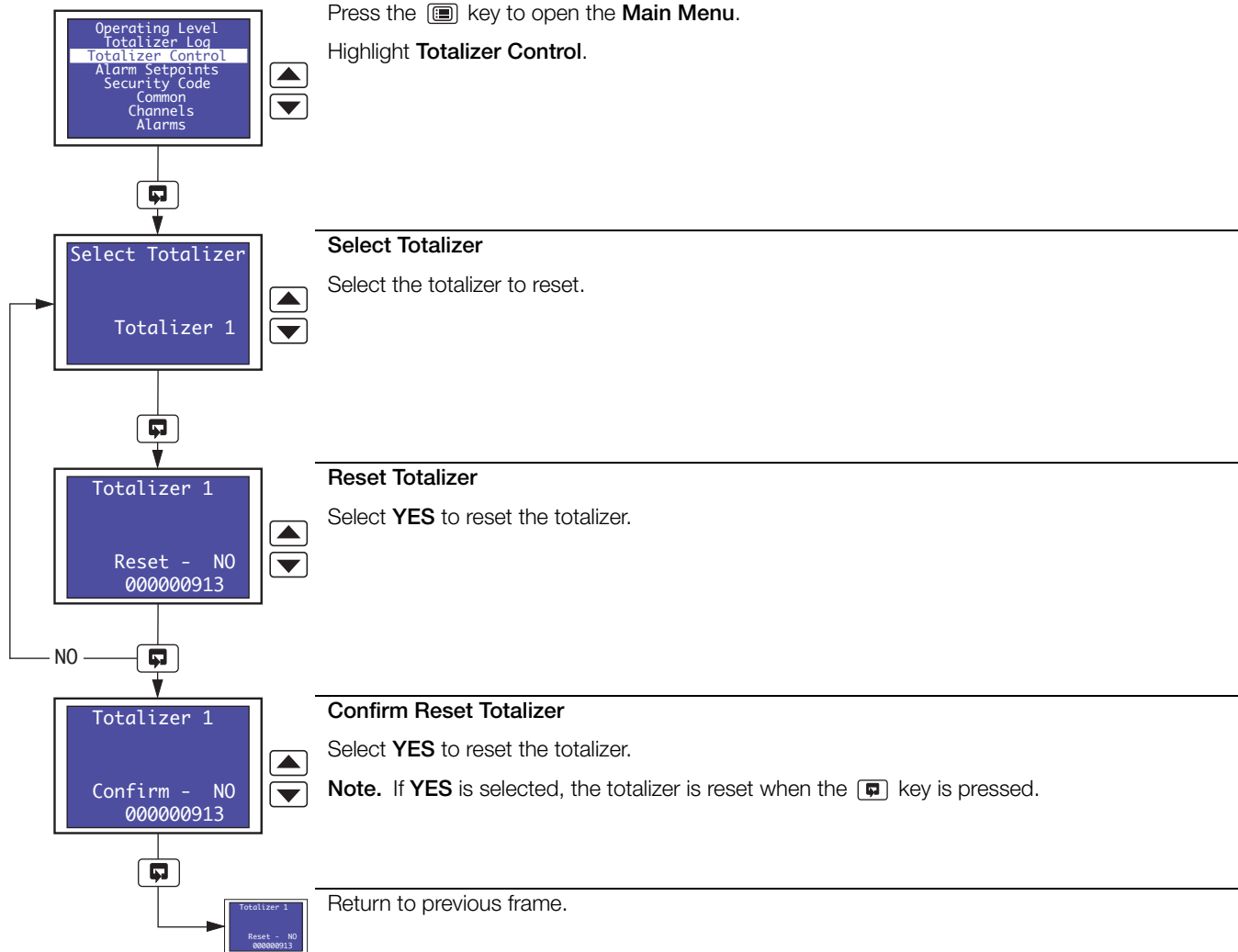

2.6 Alarm Set Point Adjustment

Note. Alarm set point adjustment is available only if **Alarm Adjust** is set to **YES** – see Section 3.4, page 20.

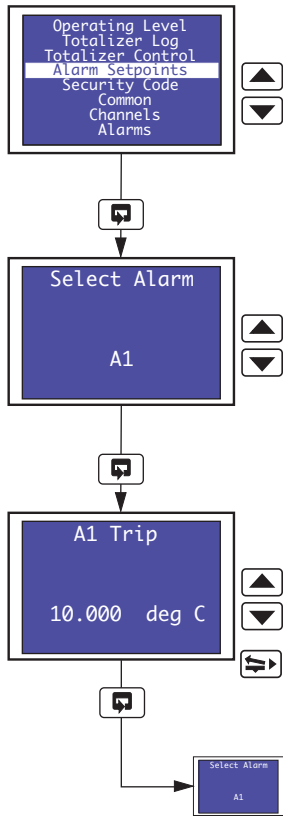

Press the  key to open the **Main Menu**.

Highlight **Alarm Adjust**.

Select Alarm

Select the alarm to adjust.

Alarm Set Point

Adjust the alarm set point.

Return to top of page.

3 Configuration

3.1 Introduction

The configuration procedures are used to make changes to the operating parameter values and for scale adjustment. Configuration of all channels is performed from faceplate 1.



The configuration settings can be backed up to a PC and restored to the recorder as required – see Section 3.16, page 58.

An overview of the **Configuration Pages** is on the rear cover fold-out.

When changing the input type, it may be necessary to reposition the input selector links accordingly – see Section 5.2.1, page 67.

3.2 Preparation for Configuration

Note.

- Isolate any external alarm/control circuits if inadvertent operation during configuration is undesirable.
- The recorder responds instantly to parameter changes. These are saved automatically when either the  or  key is pressed.
- The display screen of faceplate 2 (if fitted) shows **Configuration Mode** when the configuration pages are accessed by scrolling past **Security Code** in the Main Menu on the display screen of faceplate 1.

3.3 Configuration Level Security

Unauthorized access to the configuration pages is prevented by the use of a security code.

The security code, set to '0' when the recorder is despatched, can be set to any value from 0 to 9999 – see **Configure Password** in Section 3.4 on page 20. When set to anything other than '0', access to all configuration menus (i.e. all menus below **Security Code**) is prevented. Enter the correct code to enable access to the configuration menus.

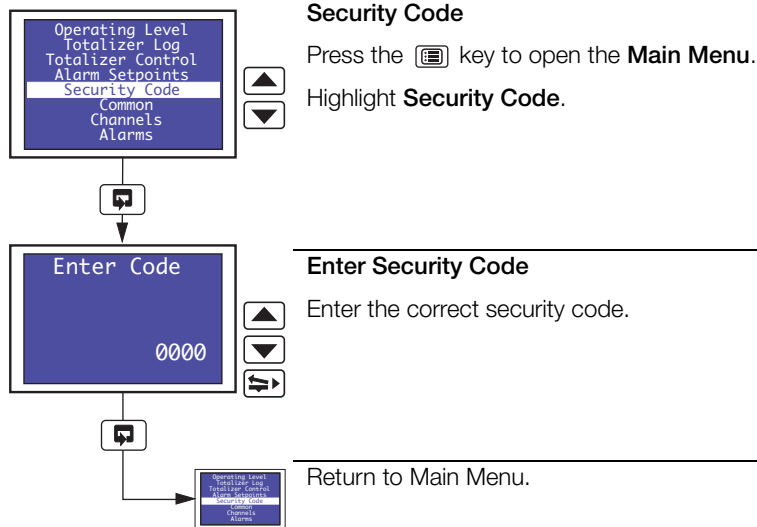

3.4 Common Configuration

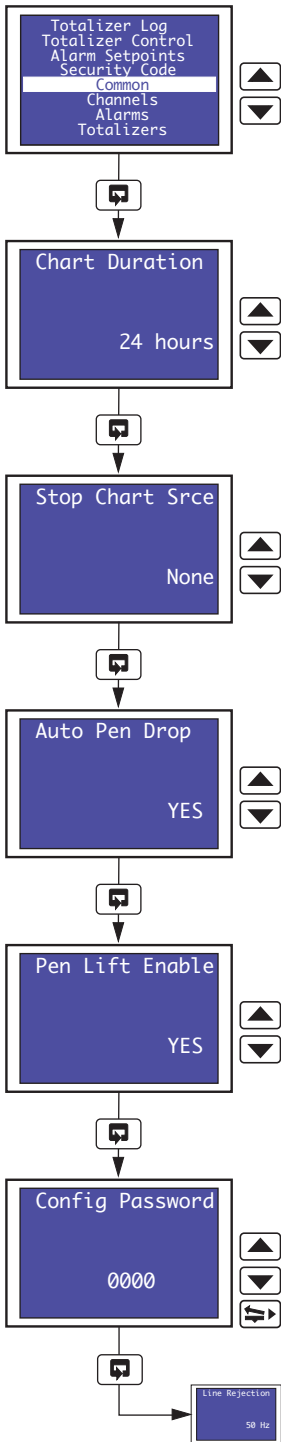

Common Configuration

Press the  key to open the **Main Menu**.

Highlight **Common**.

Chart Duration

Select the chart duration required per revolution of the chart:
between 1 and 167 hours in 1 hour increments
between 7 and 32 days in 1 day increments

Stop Chart Source

Select the source required for stopping the chart.
Refer to Appendix A on page 77 for a description of sources.

Auto Pen Drop

Select **YES** to enable the pen(s) to drop automatically onto the chart 5 minutes after they are lifted.
If **NO** is selected, the pen(s) remain lifted until they are dropped manually by the operator.

Pen Lift Enable

Select **YES** to enable the pen(s) to be raised and lowered using the pen lift key ().

Configure Password

Select a code between 1 and 9999.

Continued on next page.

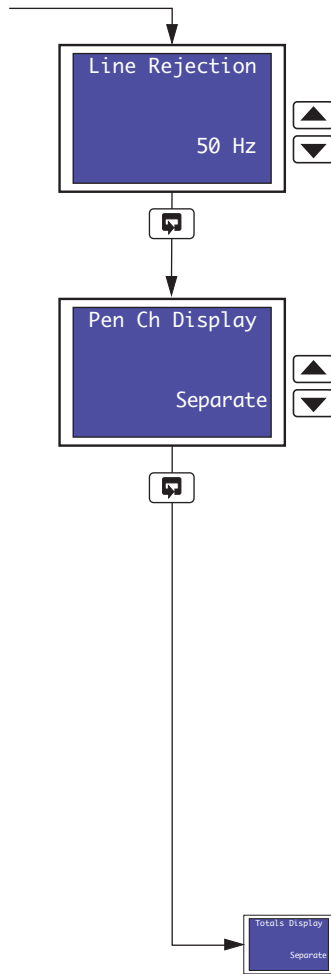

Line Rejection

Select the frequency of the mains supply to ensure maximum noise rejection on analog inputs.

Pen Channel Display

Select the style of input (pen) channel display required in the *Operating Page* – see Sections 2.3.3 to 2.3.5.

- Off** – input channel information is not displayed in the *Operating Page*
- Separate** – input channel information for channels 1 and 2 is shown separately on display screen 1. Input channel information for channels 3 and 4 (3 and 4 pen recorders only) is shown separately on display screen 2 – see Section 2.3.3, page 10
- Dual** – input channel information for channels 1 and 2 is shown simultaneously on display screen 1. Input channel information for channels 3 and 4 (3 and 4 pen recorders only) is shown simultaneously on display screen 2 – see Section 2.3.4, page 11
- Separate & Dual** – input channel information for channels 1 and 2 is first shown separately, then simultaneously on display screen 1. Input channel information for channels 3 and 4 (3 and 4 pen recorders only) is first shown separately, then simultaneously on display screen 2 – see Section 2.3.5, page 12

Continued on next page.

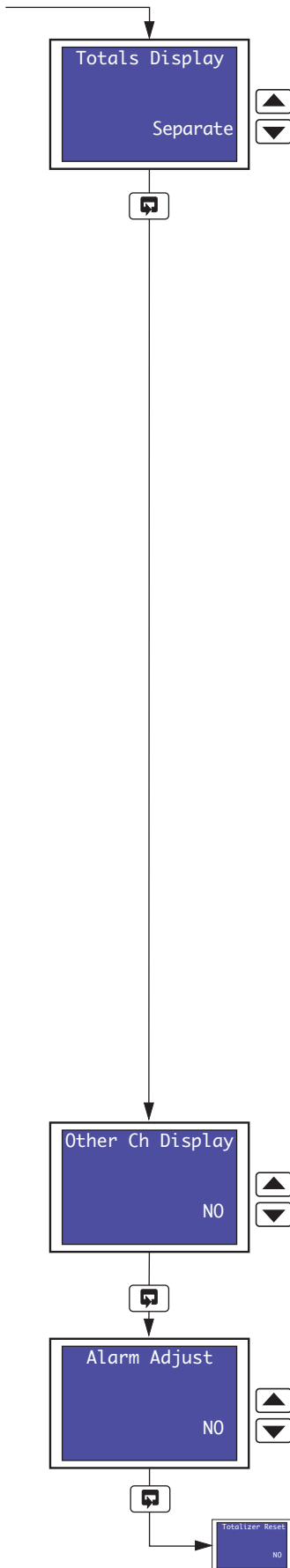

Totalizers Display

Note. Displayed only if the totalizer software option is enabled by installation of the appropriate software key.

Select the style of totalizer display required in the *Operating Page* – see Sections 2.3.6 to 2.3.10.

- Off** – totalizer values are not displayed in the *Operating Page*
- Separate** – totalizer values for totalizers assigned to channels 1 and 2 are shown separately on display screen 1. Totalizer values for totalizers assigned to channels 3 and 4 (3 and 4 pen recorders only) are shown separately on display screen 2 – see Section 2.3.6, page 13
- Rate with Total** – totalizer values for totalizers assigned to channels 1 and 2, together with the current measured values for channels 1 and 2, are shown separately on display screen 1. Totalizer values for totalizers assigned to channels 3 and 4 (3 and 4 pen recorders only), together with the current measured values for channels 3 and 4, are shown separately on display screen 2 – see Section 2.3.7, page 13
- Total with Rate** – the current measured values for channels 1 and 2, together with totalizer values for totalizers assigned to channels 1 and 2, are shown separately on display screen 1. The current measured values for channels 3 and 4 (3 and 4 pen recorders only), together with totalizer values for totalizers assigned to channels 3 and 4, are shown separately on display screen 2 – see Section 2.3.8, page 14
- Dual Total** – totalizer values for totalizers assigned to channels 1 and 2 are shown simultaneously on display screen 1. Totalizer values for totalizers assigned to channels 3 and 4 (3 and 4 pen recorders only) are shown simultaneously on display screen 2 – see Section 2.3.9, page 14
- Dual + Flow Rate** – totalizer values for totalizers assigned to channels 1 and 2, together with the current measured values for channels 1 and 2, are shown simultaneously on display screen 1. Totalizer values for totalizers assigned to channels 3 and 4 (3 and 4 pen recorders only), together with the current measured values for channels 3 and 4, are shown simultaneously on display screen 2 – see Section 2.3.10, page 15

Note. Do not select **Dual + Flow Rate** if a totalizer is not assigned to each of the channels to be displayed – see Section 3.7, page 35.

Other Channels Display

Select **YES** to display information for input channels not assigned to pens.

Alarm Adjust

Select **YES** to enable alarm set point adjustment in the *Operating Page* – see Section 2.6, page 18.

Continued on next page.

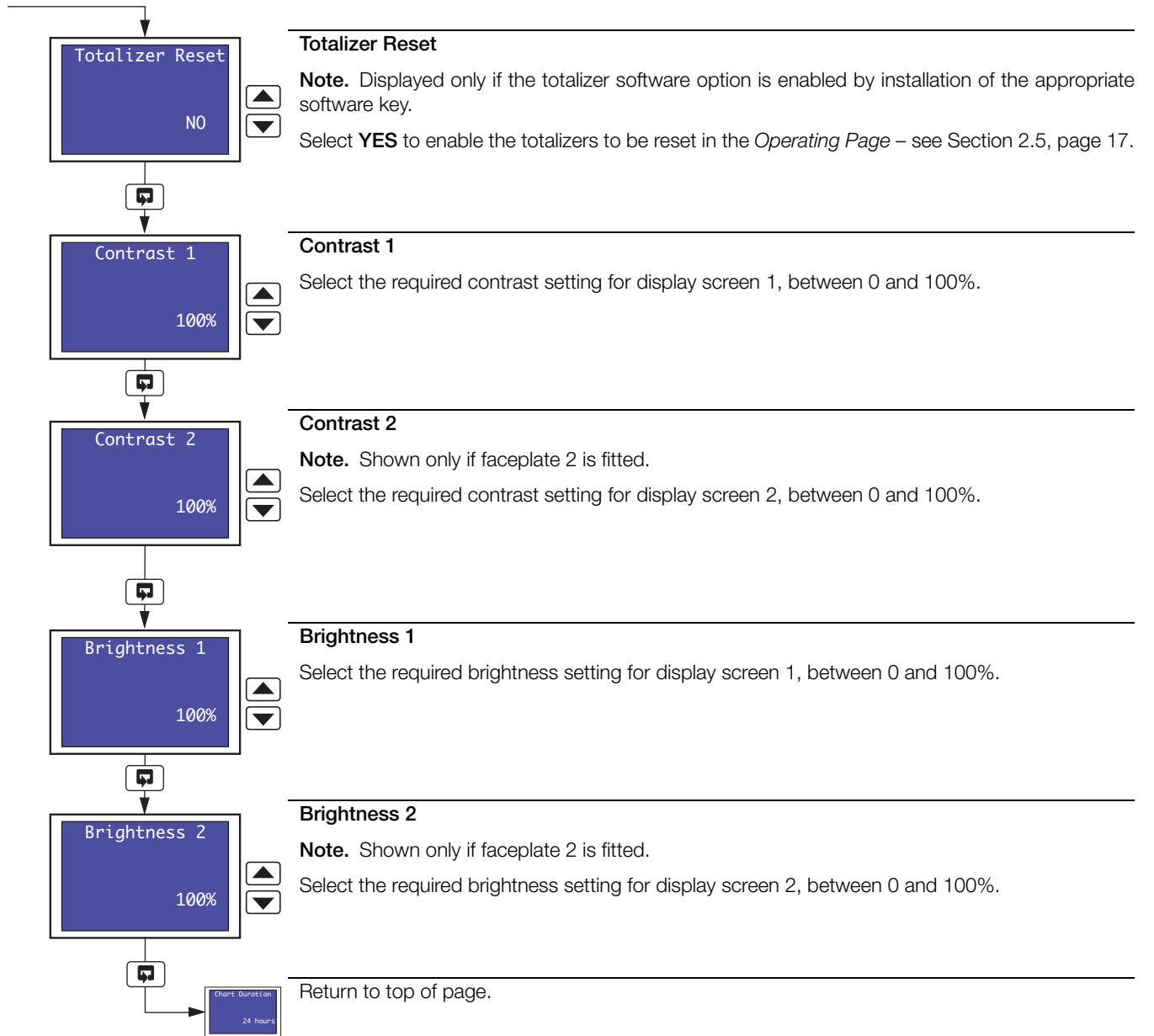

3.5 Channels Configuration Overview.

- **Universal inputs** – mV, mA, V, THC, RTD and resistance.
- **Internal cold junction compensation.**
- **Linearization** – enables use of non-linearizing temperature transmitters or any electrical input.
- **Programmable fault levels and actions.**
- **Digital filter** – reduces the effect of noise on inputs.

Example A – setting up:

- a current input of 4 to 20mA
- displaying a range of 0 to 200psi
- a fault detection level 10% above 200psi (engineering/display range) and 10% below 0psi (engineering/display range)
- in the event of a fault being detected and/or the fault detection level being exceeded, the process variable is driven downscale.

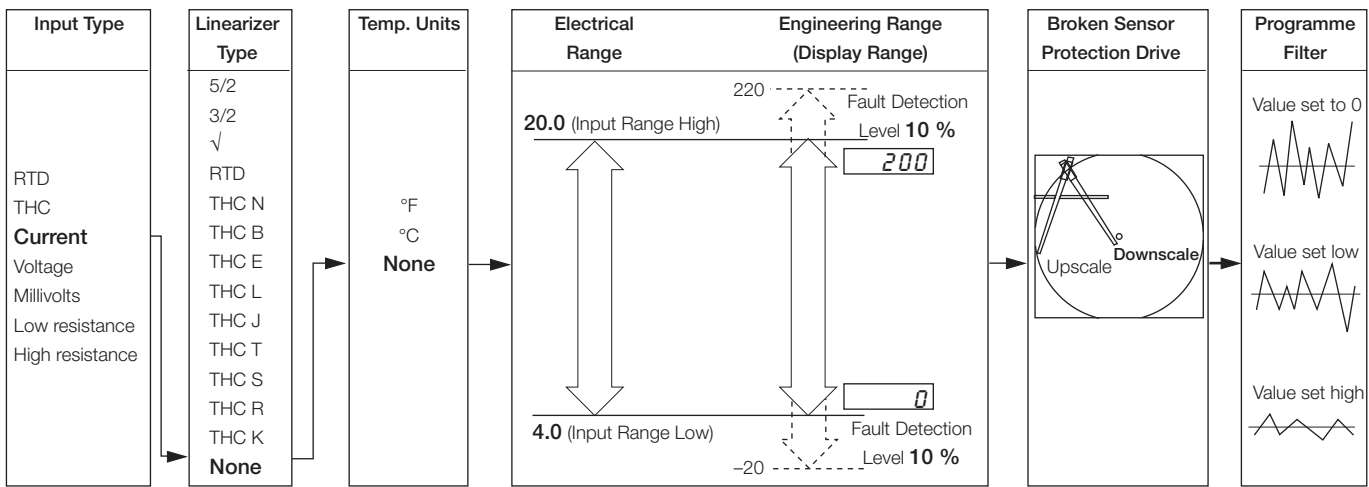

Example B – setting up:

- a Type K thermocouple
- displaying temperature in °F
- displaying a range of 0 to 2000°F
- a fault detection level 10% above 2000°F (engineering/display range) and 10% below 0°F (engineering/display range)
- in the event of a fault being detected and/or the fault detection level being exceeded, the process variable is driven upscale.

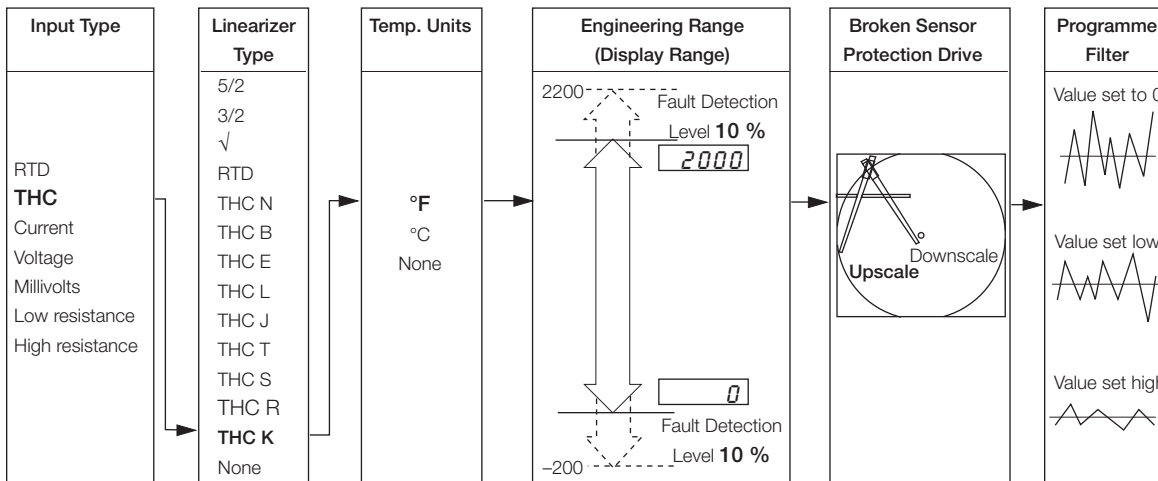



Channels Configuration

Press the  key to open the **Main Menu**.

Highlight **Channels**.

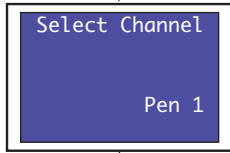

Select Channel

Select the channel to configure.

Note. If **Pen X Function** or **Pen X Source** (where **X** is the pen number) is set to **Off** or **None** respectively (Section 3.14), that pen cannot be selected.



Pen X Function set to **Trend** (Section 3.14) – continued on next page.



Pen X Function set to **Event** (Section 3.14) – continued on page 30.

Pen X Function
set to Trend
(Section 3.13)

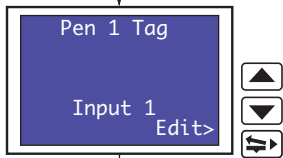

Channel Tag

Press the key to open the Edit screen.

Use the , and keys to enter the channel tag required – see Fig. 2.1 on page 6.

Note. Any characters not permitted in this tag are skipped when scrolling through the selection.

Press the key to close the edit screen and save the tag.

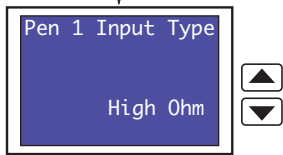

Channel Input Type

Select the required channel input type:

- None – None
- Millivolt – Millivolt ($\leq 150\text{mV}$)
- Milliamp – Current
- High Ohm – High resistance ($>750\Omega$)
- Low Ohm – Low resistance ($\leq 750\Omega$)
- Volts – Voltage
- Thermocouple – Thermocouple
- Rtd – Resistance thermometer

Return to top of page.

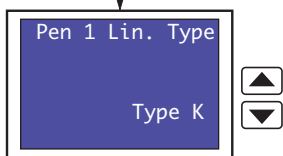
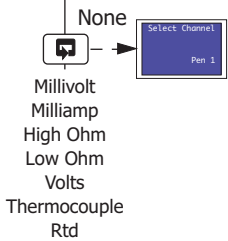

Linearizer Type

Select the required linearizer type.

- None – No linearizer
- Type K – Type K thermocouple
- Type R – Type R thermocouple
- Type S – Type S thermocouple
- Type T – Type T thermocouple
- Type J – Type J thermocouple
- Type E – Type E thermocouple
- Type N – Type N thermocouple
- Type B – Type B thermocouple
- Rtd – Resistance thermometer
- Square Root – Square root
- 3/2 – $X^{3/2}$ (Open channel flow applications)
- 5/2 – $X^{5/2}$ (Open channel flow applications)

Continued on next page.

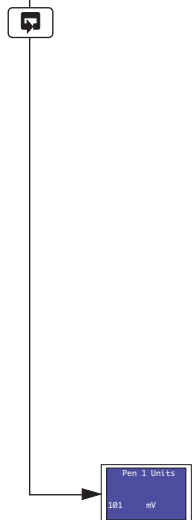

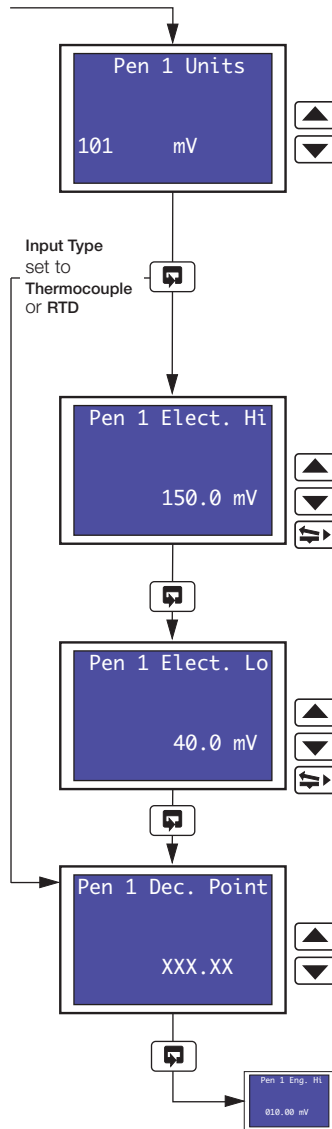

Channel Units

Select any of the units pre-programmed into the recorder or select **113 Custom** and the ▲, ▼ and ↔ keys to enter the units required – see Fig. 2.1 on page 6.

Notes.

- Any characters not permitted in user-defined units are skipped when scrolling through the selection.
- Refer to Appendix B on page 78 for a description of the units pre-programmed into the recorder.

Electrical Input Range High

Set the maximum electrical input value required, within the limits shown in Table 3.1.

Electrical Input Range Low

Set the minimum electrical input value required, within the limits shown in Table 3.1.

Decimal Point

Select the decimal point position for the engineering and chart ranges.

Continued on next page.

Input Type	Electrical Range Low	Electrical Range High	Minimum Span (Low to High)
Millivolts	0	150	5.0
Milliamps	0	50	1.0
Resistance (High)	0	9999	400
Resistance (Low)	0	750	20
Volts	0	5	0.1

Table 3.1 Limits of Electrical Ranges

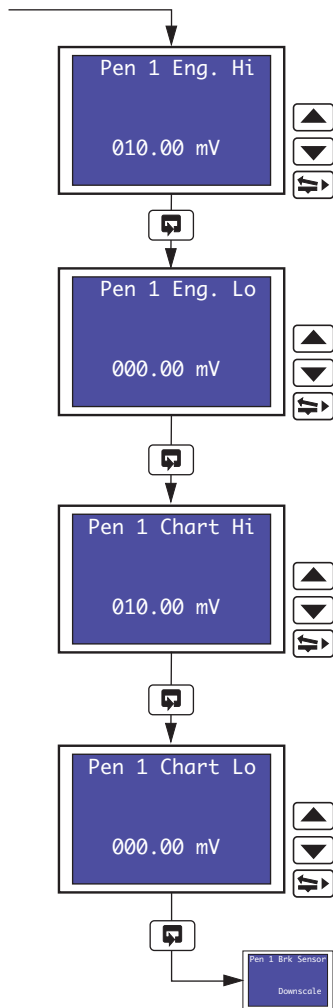

Engineering Range High

Set the maximum engineering value required, within the limits shown in Table 3.2.

Engineering Range Low

Set the minimum engineering value required, within the limits shown in Table 3.2.

Chart Range High

Set the maximum value, in engineering units, required on the chart.

Note. If the **Engineering Range High** setting is changed, the **Chart Range High** setting is reset automatically to the same value.

Chart Range Low

Set the minimum value, in engineering units, required on the chart.

Note. If the **Engineering Range Low** setting is changed, the **Chart Range Low** setting is reset automatically to the same value.

Continued on next page.

Linearizer Type	Degrees Celsius			Degrees Fahrenheit		
	Minimum	Maximum	Minimum Span	Minimum	Maximum	Minimum Span
Type K	-100	1300	65	-148	2372	117
Types R & S	-18	1700	320	0	3092	576
Type T	-250	300	60	-418	572	108
Type J	-100	900	50	-148	1652	90
Type E	-100	900	45	-148	1652	81
Type N	-200	1300	90	-328	2372	162
Type B	-18	1800	710	0	3272	1278
Rtd	-200	600	25	-328	1112	45

Performance accuracy is not guaranteed below 400°C (725°F) for types B, R and S thermocouples.

Minimum span below zero for Type T thermocouples is 70°C (126°F).

Minimum span below zero for Type N thermocouples is 105°C (189°F).

THC standard DIN 4730 IEC 584.

RTD standard DIN 43760 IEC 751.

Linearizer Type	Engineering Range High and Low	
	Minimum	Maximum
Square Root	-999	9999
3/2		
5/2		
None		

Table 3.2 Limits of Engineering Ranges

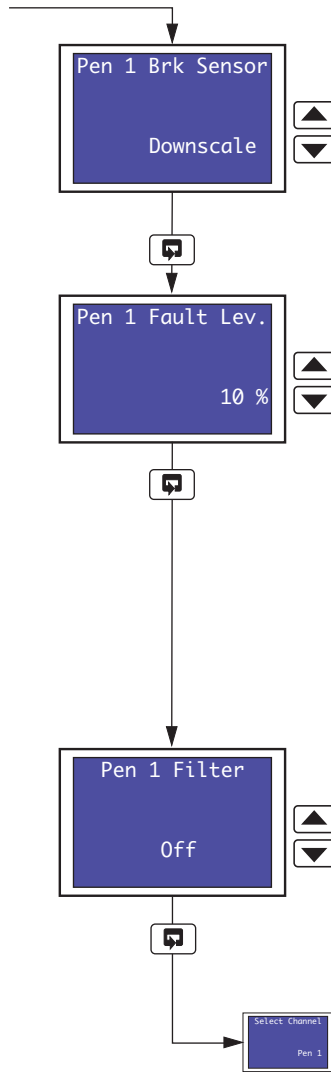

Broken Sensor Protection Drive

In the event of an input failure, the process variable is driven in the direction selected:

- Downscale** – Process variable driven below zero
- None** – Process variable driven in direction of failure
- Upscale** – Process variable driven beyond full scale

Fault Detection Level Percentage

Set a tolerance level, between 0 and 100% of the engineering range, to allow for deviation of the input signal above or below the input span before an input failure is detected.

Example – setting the fault detection level to 10% on input range of 50 (**Engineering Range Low**) to 250 (**Engineering Range High**) bar causes an analog input failure fault to be detected below 30 bar and above 270 bar.

Notes.

- On some ranges the input circuitry may saturate before the fault level setting is reached. In this case, an error is detected below the level set.
- If an input exceeds the minimum or maximum value for the selected linearizer, an error is detected regardless of the fault level setting.

Pen Filter

Filters the process variable input, i.e. if the input is stepped it smooths the transition between steps and may also be used for some degree of cleaning of noisy inputs. The filter time represents the time a step in the input takes to change the displayed process variable from 10 to 90% of the step.

Set the value required, between Off and 60 seconds in 1 second increments.

Return to top of page.

Pen X Function
set to **Event**
(Section 3.13)

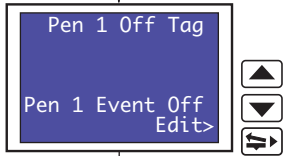

Pen Off Tag

Press the key to open the Edit screen.

Use the , and keys to enter the pen off tag required – see Fig. 2.1 on page 6.

Note. Any characters not permitted in this tag are skipped when scrolling through the selection.

Press the key to close the edit screen and save the tag.

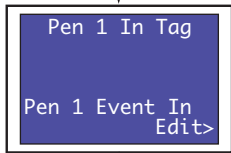

Pen In Tag

Press the key to open the Edit screen.

Use the , and keys to enter the pen in tag required – see Fig. 2.1 on page 6.

Note. Any characters not permitted in this tag are skipped when scrolling through the selection.

Press the key to close the edit screen and save the tag.

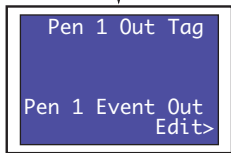

Pen Out Tag

Press the key to open the Edit screen.

Use the , and keys to enter the pen out tag required – see Fig. 2.1 on page 6.

Note. Any characters not permitted in this tag are skipped when scrolling through the selection.

Press the key to close the edit screen and save the tag.

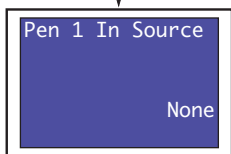

Pen In Source

Select a digital source to move the pen inwards on the chart.

Refer to Appendix A on page 77 for a description of sources.

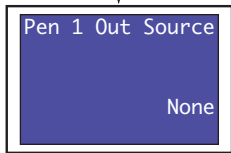

Pen Out Source

Select a digital source to move the pen outwards on the chart.

Refer to Appendix A on page 77 for a description of sources.



Return to top of page.

3.6 Alarms Configuration

Overview.

- Four alarms per channel – identified A1 to D1 (for channel 1) up to A4 to D4 (for channel 4).
- High/Low process alarms.
- Fast/Slow rate alarms.
- Adjustable hysteresis value – prevents oscillation of alarm state.
- Time hysteresis – enables delayed triggering of alarms.

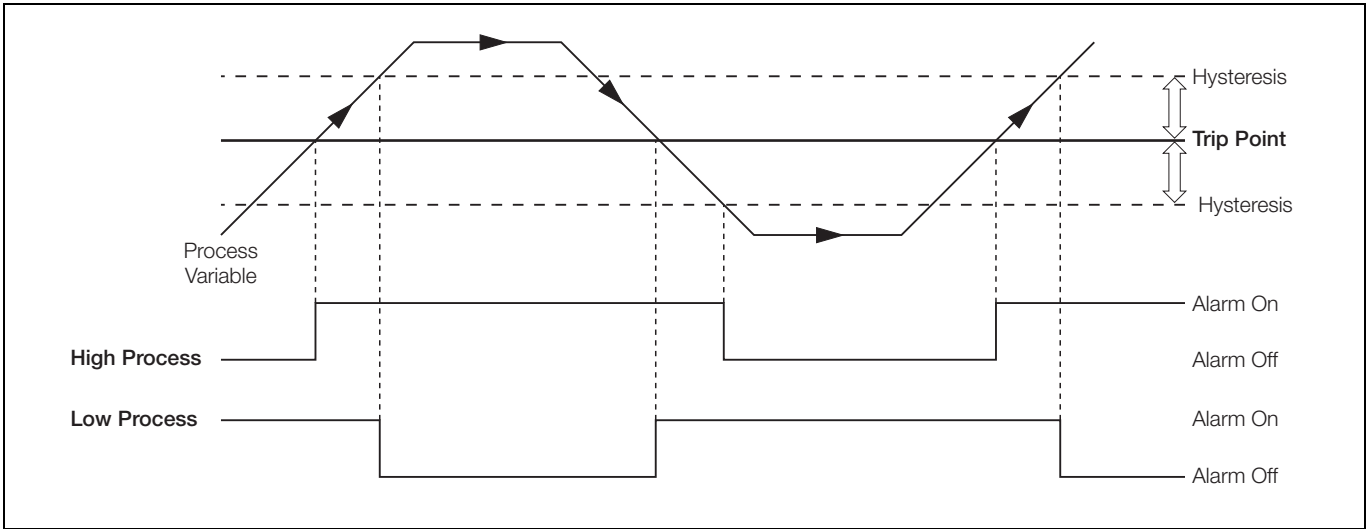

Fig. 3.1 High and Low Process Alarm with Hysteresis

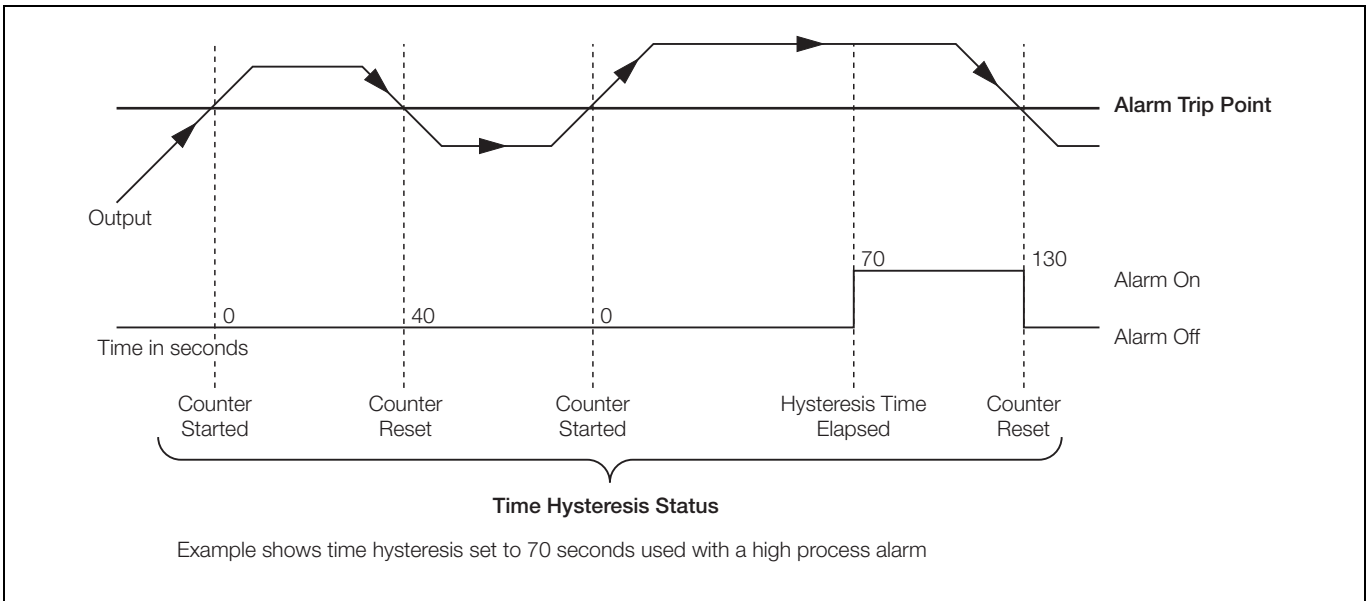

Fig. 3.2 Time Hysteresis Alarm

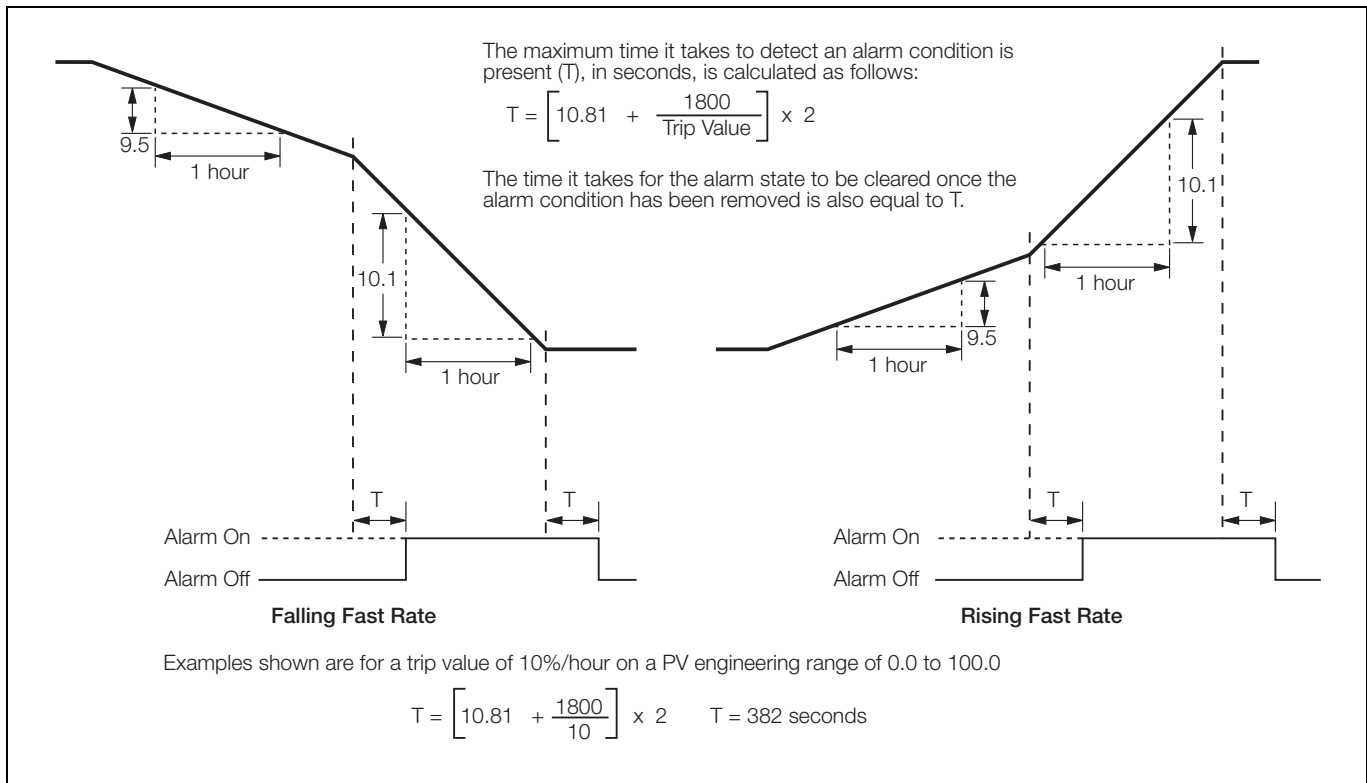

Fig. 3.3 Fast Rate Alarms with Hysteresis

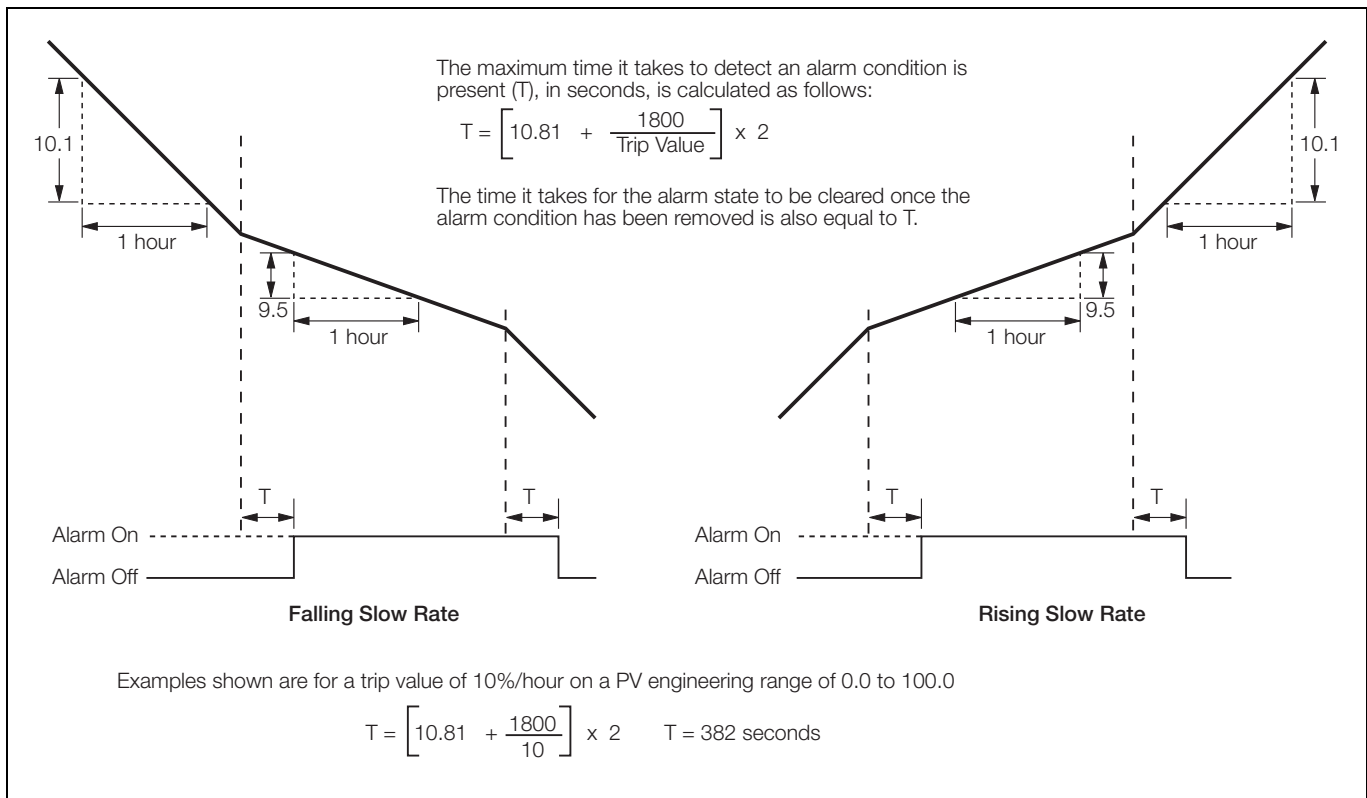
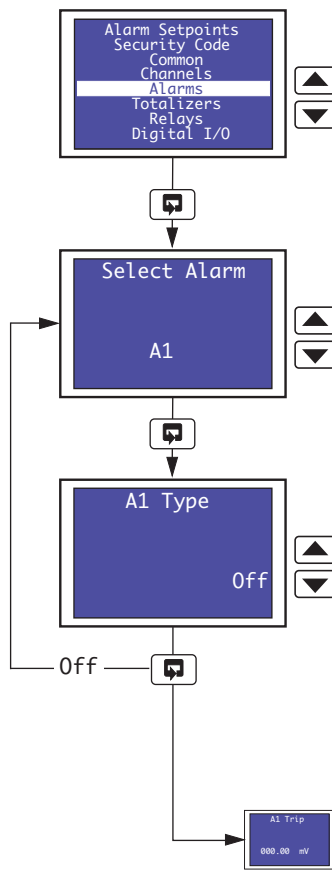

Fig. 3.4 Slow Rate Alarms with Hysteresis



Alarms Configuration

Press the key to open the **Main Menu**.

Highlight **Alarms**.

Select Alarm

Select the alarm to be configured.

Alarm Type

Select the alarm type required:

- Off – No alarm
- High Process – See Fig. 3.1 on page 31
- Low Process – See Fig. 3.1 on page 31
- Fast Rate – See Fig. 3.3 on page 32
- Slow Rate – See Fig. 3.4 on page 32

Continued on next page.

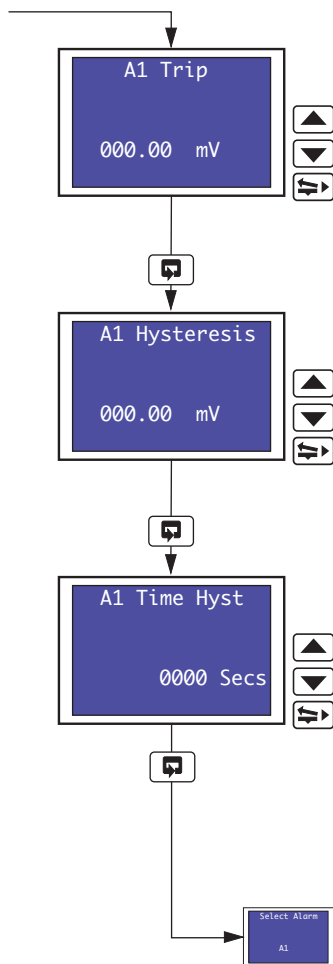

Trip Level

Set the value at which the alarm is to activate.

For High and Low Process alarms, the value is set in engineering units.

For Fast and Slow Rate alarms, the trip level is set as a percentage of the engineering span (engineering range high – engineering range low) per hour, between 500 and 500% in 0.1% increments.

Hysteresis

Set the hysteresis value, either in engineering units (High and Low Process alarms) or as a percentage of the engineering span (Fast and Slow Rate alarms).

Hysteresis is operational only when the alarm is active. The alarm is activated at the trip level but is de-activated only after the alarm variable has moved into the safe region by an amount equal to the hysteresis value. For rate alarms this setting is a percentage of the trip level.

Time Hysteresis

Set the time hysteresis value required, between 0 and 9999 seconds.

If a **Time Hysteresis** value is set, the alarm becomes active only when the alarm condition is present continuously for the time set.

If a **Hysteresis** value is also set (see above) and an alarm is activated, the alarm remains active until the process variable moves outside the hysteresis band. When the alarm condition no longer exists the alarm becomes inactive immediately, i.e. time hysteresis does not affect turning off of alarm states.

Return to top of page.

3.7 Totalizer Configuration

Overview.

- **Up to four, 9-digit totalizers** – assignable to any pen, analog input or math block (if math software option enabled by installation of the appropriate software key).
- **Count up or count down.**
- **Automatic count rate calculation** – wherever possible, the recorder calculates the count rate automatically according to source units, totalizer units and engineering range, from 0.0001 to 99.9999 counts/second.
- **External counter pulse** – can be used to energize relays or digital outputs (a maximum of 4 pulses per second are generated).
- **Wrap function** – with external wrap pulse used to energize relays or digital outputs.
- **Programmable preset and predetermined count values** – for (batch) flow total.
- **Adjustable cut-off values.**
- **Operator level reset and stop/go.**
- **Digital signal reset and stop/go.**

When enabled by installation of the appropriate software key, the totalizer software provides indication and recording of flow rates from input signals with linear, square law or power law characteristics. Totalization is available for each channel and can be switched on or off as required.

The flow total for any channel can be viewed on the same display screen as the input (pen) channel to which it is assigned. The flow total can also be reset using the control keys on the associated faceplate. An additional internal 'Secure' total is also provided that can be reset only in the Totalizer Configuration level.

External counters with their own power supplies can be driven using 4 relay and digital output module options.

Count Rate

Totalizers are normally used in flow applications and their purpose is to summate the volume of process fluid passing the point of measurement. Totalizers have no relationship to time and continue to count up or down (dependant on setting) until instructed to reset. A trip meter on a typical family car is an example of a basic totalizer – the meter counts and displays the distance travelled by the vehicle until reset by the driver. In this example, the speedometer and trip meter read in the same unit of distance.

Flow totalization is more complex than that of a trip meter. In flow totalization, the flow recorder typically measures the instantaneous value in one flow unit whilst the totalizer counts in a larger flow unit. When configuring a totalizer, a count rate must be calculated and entered to compensate for the difference between the totalized measurement unit and the instantaneous measurement unit.

Where possible, the recorder calculates automatically the count rate for the most popular measurement units, e.g. gallons, cubic feet, liters and cubic meters. When configuring a totalizer, first ensure that the unit of measurement (**Channel Units**) selected for the channel to which the totalizer is assigned is a volumetric unit (i.e. quantity per unit of time, for example gallons per hour) – see Section 3.5, page 24. Finally, enter the required Totalizer unit of measurement. If the recorder holds the relationship data between the selected measurement and totalizer units, '**Automatic**' is displayed under the count rate to indicate that it has been set automatically. If the relationship data is not in the recorder's look-up table, '**Manual**' is displayed and the count rate must be set manually – see next page.

Calculating The Count Rate Manually

The count rate determines how many units the totalizer increments per second when the flow input signal is at 100%. To calculate this parameter manually, follow the procedure below:

1. Calculate the volume relationship

Typically the unit of measure used by the totalizer is larger than that used for displaying the instantaneous flow-rate. Use standard conversion tables to calculate how many times the flow units used for the input will fit into the desired totalizer unit.

Example: Measurement channel units is set to gallons/minute. Instantaneous process flow-rate (engineering range) is 0-300 imperial gallons/minute, totalizer is required to increment in cubic feet. From standard conversion tables, 1 cubic foot = 6.229 imperial gallons.

2. Calculate the unit time

Ensuring that the time-base of the instantaneous flow-rate is used, the following equation determines how many seconds it will take at full scale flow for a single totalizer unit to pass the measurement point:

$$\frac{\text{Volume relationship}}{\text{Full scale flow}} \times \text{number of seconds in time-base} = \text{Seconds to pass one totalizer unit}$$

Example:

$$\frac{6.229 \text{ (imperial gallons in } 1\text{ft}^3\text{)}}{300 \text{ (imperial gallons max. flow rate)}} \times 60 \text{ (seconds in 1 minute)} = 1.2458 \text{ seconds to pass } 1\text{ft}^3$$

3. Calculate the count rate

The totalizer count rate is the reciprocal of the result of the calculation above:

$$\frac{1}{\text{Seconds to pass 1 totalizer unit}} = \text{Totalizer count rate}$$

Example:

$$\frac{1}{1.2458} = 0.803$$

Note. Totalizer configuration is available only if the totalizer software option is enabled by installation of the appropriate software key.

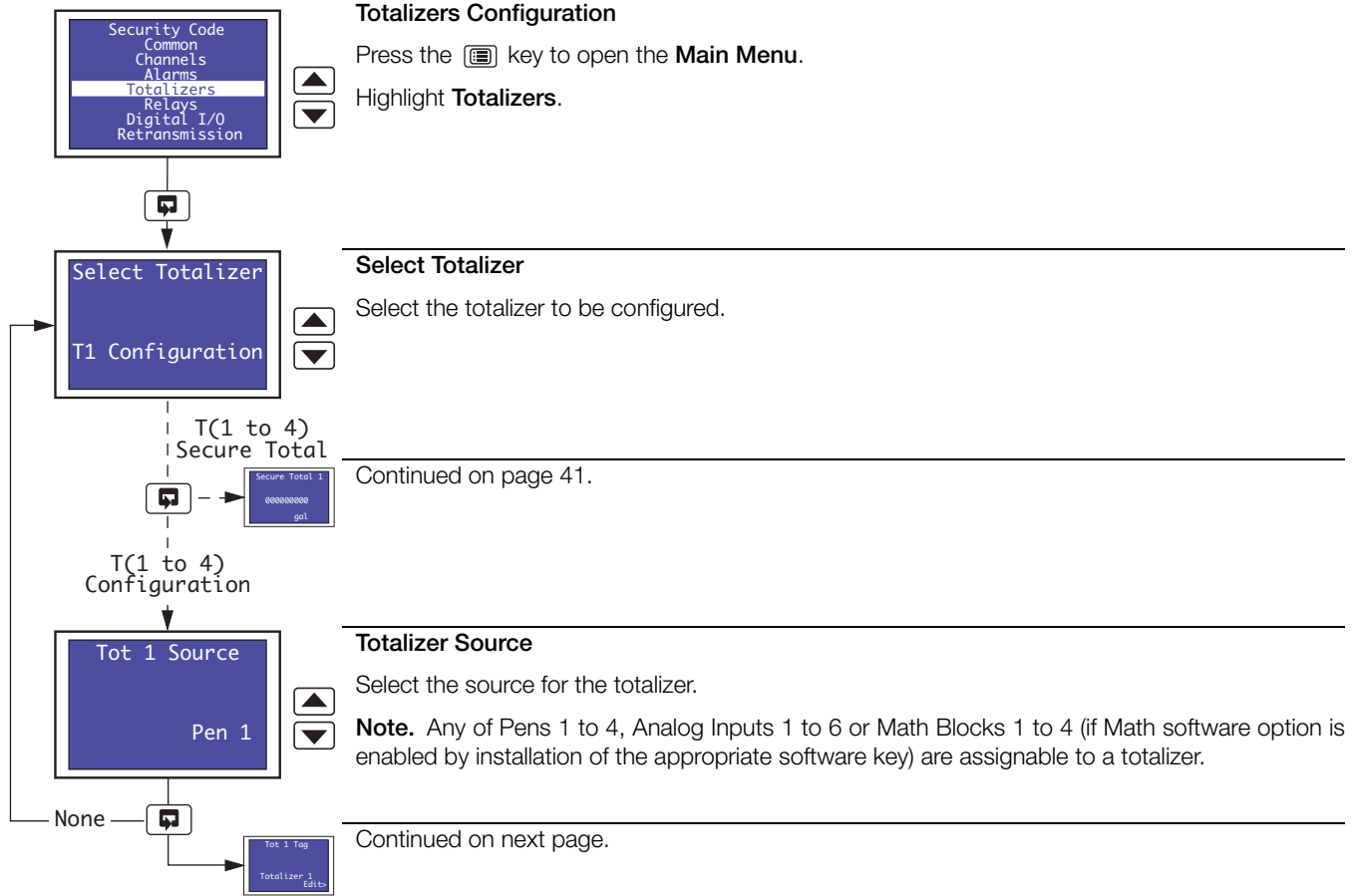

Totalizers Configuration

Press the  key to open the **Main Menu**.
Highlight **Totalizers**.

Select Totalizer

Select the totalizer to be configured.

Continued on page 41.

Totalizer Source

Select the source for the totalizer.

Note. Any of Pens 1 to 4, Analog Inputs 1 to 6 or Math Blocks 1 to 4 (if Math software option is enabled by installation of the appropriate software key) are assignable to a totalizer.

Continued on next page.

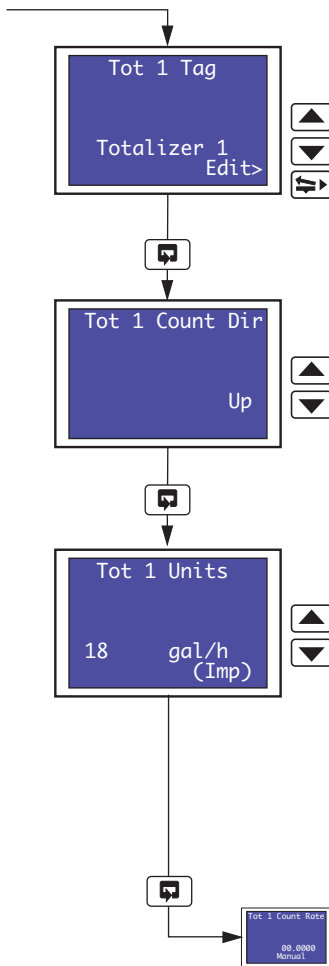

Totalizer Tag

Press the key to open the Edit screen.

Use the , , and keys to enter the totalizer tag required – see Fig. 2.1 on page 6.

Note. Any characters not permitted in this tag are skipped when scrolling through the selection.

Press the key to close the edit screen and save the tag.

Count Direction

Select the count direction:

Up – Incremental counter (Preset Value < Predetermined Value)

Down – Decremental counter (Preset Value > Predetermined Value)

Totalizer Units

Select any of the units pre-programmed into the recorder or select **113 Custom** and use the , , and keys to enter the units required – see Fig. 2.1 on page 6.

Notes.

- Any characters not permitted in user-defined units are skipped when scrolling through the selection.
- Refer to Appendix B on page 78 for a description of the units pre-programmed into the recorder.

Continued on next page.

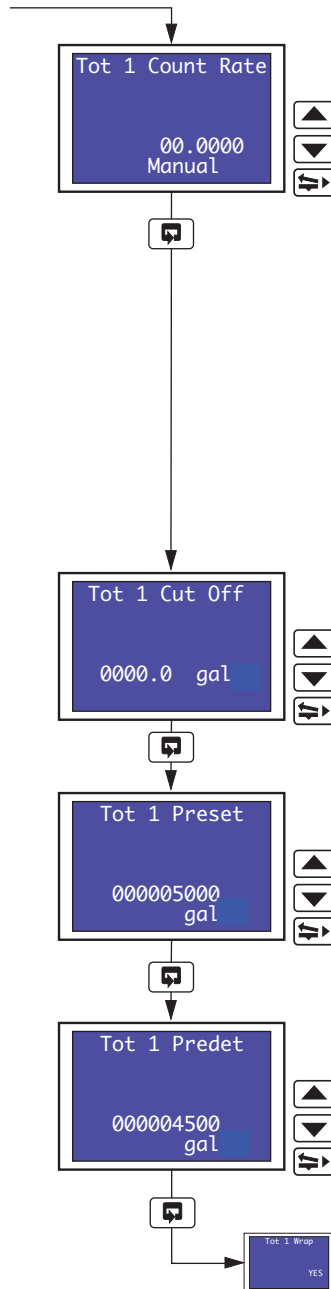

Totalizer Count Rate

Automatic – the recorder has calculated the count rate automatically. No further adjustment is possible.

Manual – the count rate must be calculated manually (see page 36). Use the ▲, ▼ and ↵ keys to enter the calculated count rate in pulses per second, from 00.0000 to 99.9999 in 0.0001 increments.

Note. To configure the totalizer for Automatic count rate calculation:

1. Ensure that the unit of measurement (**Channel Units**) selected for the channel to which the totalizer is assigned is a volumetric unit (i.e. quantity per unit of time, for example gallons per hour) – see Section 3.5, page 24.
2. Enter the required Totalizer unit of measurement (**Totalizer Units**) – see previous page.

If the recorder holds the relationship data between the selected measurement and totalizer units, **Automatic** is displayed under the count rate to indicate that it has been set automatically.

Totalizer Cut Off

Set the value, in engineering units, at which the totalizer is to stop counting.

Totalizer Preset Value

Set the value, in engineering units, from which the totalizer is to start counting and the value that is applied when the totalizer is reset.

Totalizer Predetermined Value

Set the value, in engineering units, at which the totalizer stops or wraps.

Continued on next page.

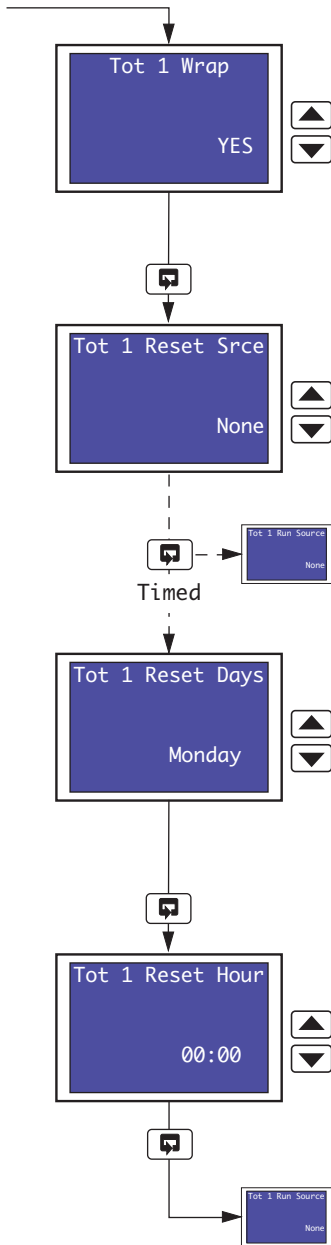

Totalizer Wrap

Select the required totalizer wrap action:

- YES – the total is reset automatically to the preset value when the predetermined value is reached.
- NO – the count stops when the predetermined value is reached

Totalizer Reset Source

If required, select a digital signal to reset the totalizer or select **Timed** to configure the totalizer to reset at a predetermined time.

Refer to Appendix 1 for description of sources.

Anything other than **Timed** selected – continued on next page.

Totalizer Reset Day

Select the day or days on which the totalizer is to reset:

- Monday to Sunday – the totalizer resets on the day selected
- Mon-Fri – the totalizer resets every Monday to Friday inclusive
- All – the totalizer resets every day
- 1st of Month – the totalizer resets on the 1st day of every month

Totalizer Reset Time

Select the time of day at which the totalizer is to reset, from 00:00 (midnight) to 23:00 (11 pm) in 1 hour increments.

Continued on next page.

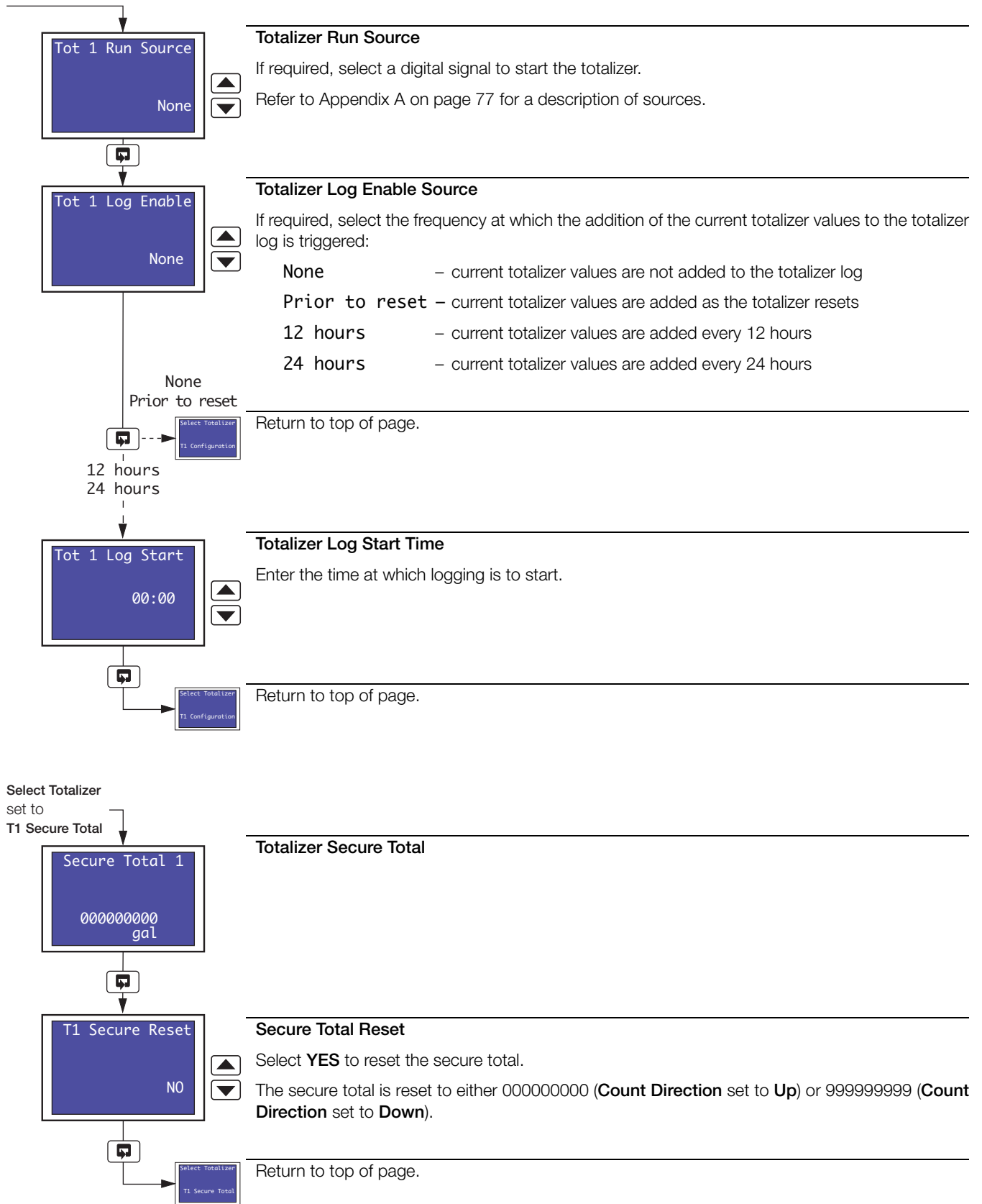

3.8 Relay Configuration Overview.

- **Relays** – can be energized by alarms, logic equation results (math software option enabled by installation of the appropriate software key), digital inputs, real time events (timer software option enabled by installation of the appropriate software key) and totalizer wrap signal (totalizer software option enabled by installation of the appropriate software key)
- **External totalizer count function** – external counter can be driven only by Module Type 3 (4-relay module) fitted in module positions 4, 5 or 6 (see Section 5.2, page 66).
- **Polarity** – allows fail-safe settings

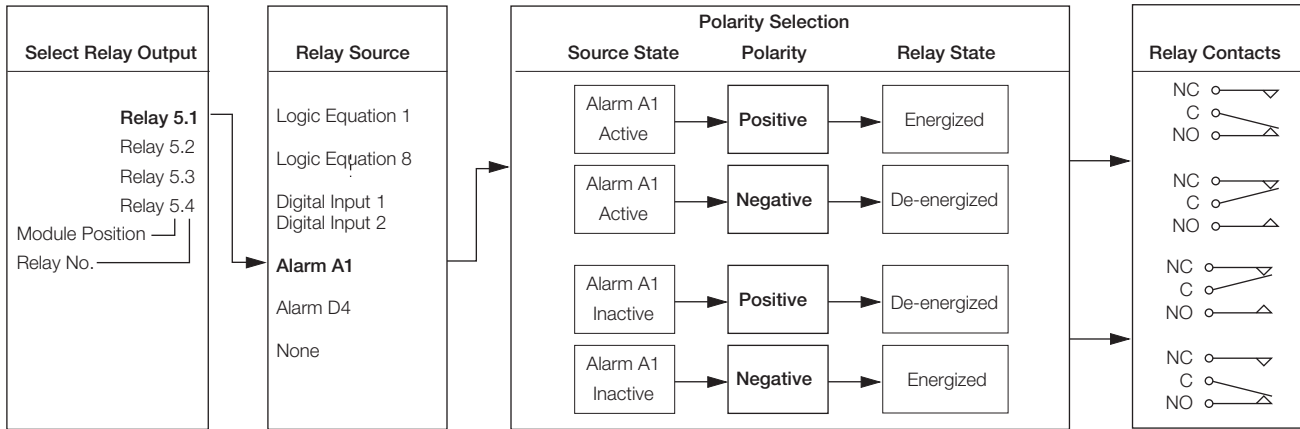

Relay Configuration

Press the key to open the **Main Menu**.

Highlight **Relays**.

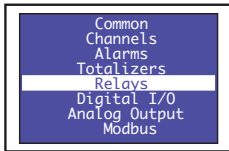

Select Relay

Select the relay to be configured.

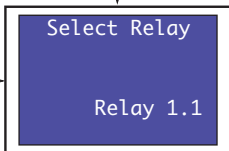

Relay Source

Select the source required to activate the selected relay.
Refer to Appendix A on page 77 for a description of sources.

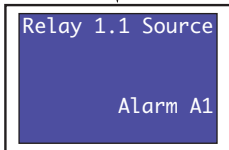

Relay Polarity

Select the polarity required for the selected relay:
Positive – relay is energized when the relay source is active (On)
Negative – relay is energized when the relay source is inactive (Off)

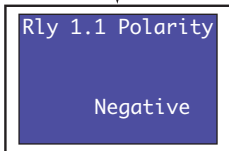

Return to top of page.



3.9 Digital Input and Output Configuration Overview.

- The **Digital I/O** menu selection is displayed only if a digital input/output module is fitted – see Section 5.3.3, page 70.
- **Up to 24 digital outputs available** – depending on the module types fitted.
- **Digital outputs** – can be energized by alarms, logic equation results (math software option enabled by installation of the appropriate software key), digital inputs, real time events (timer software option enabled by installation of the appropriate software key) and totalizer wrap signal (totalizer software option enabled by installation of the appropriate software key).
- **External Totalizer count function** – external counter can be driven only by Module Type 5 (8-digital output module) fitted in module positions 4, 5 or 6 (see Section 5.2, page 66).
- **Polarity** – inverts the effect of the selected source on the output state.

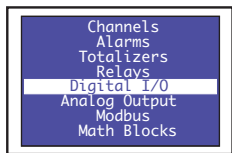
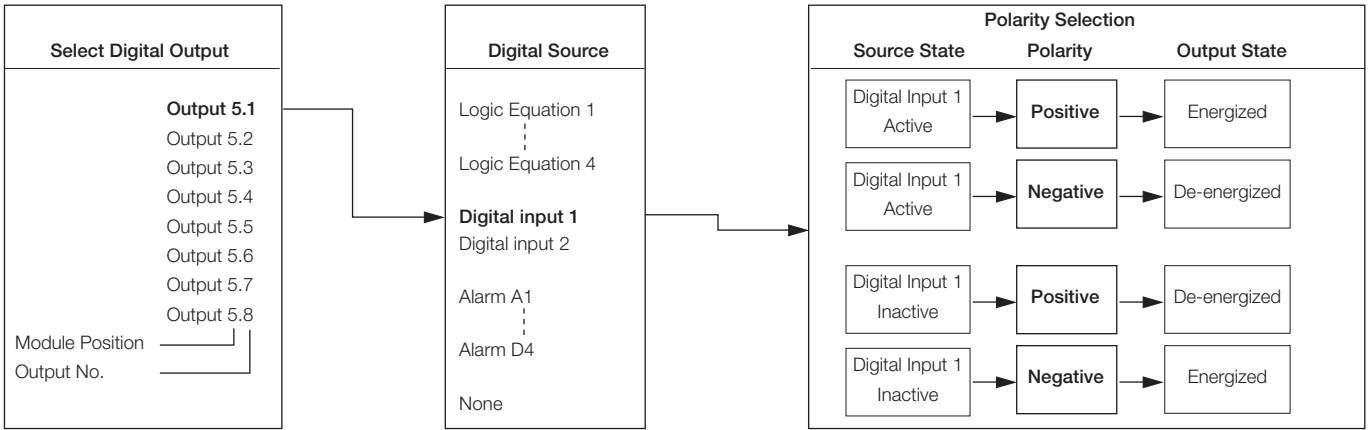

Digital I/O Configuration

- Press the key to open the **Main Menu**.
- Highlight **Digital I/O**.

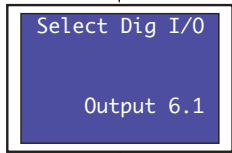

Select Digital Input/Output

- Select the digital input or output to be configured.



Output X.X selected – continued on next page.

Input X.X selected – continued on next page.

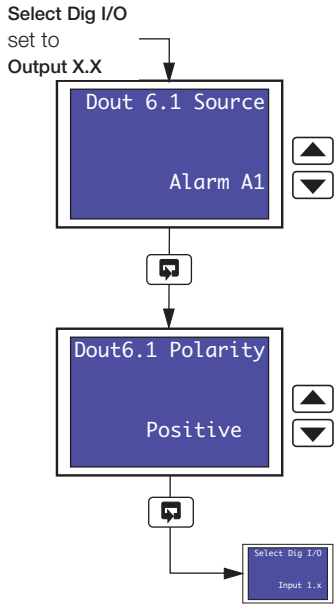

Digital Output Source

Select the channel source for the digital output.
Refer to Appendix A on page 77 for a description of sources.

Digital Output Polarity

Select the polarity required for the selected digital output:
Positive – digital output is energized when the relay source is active (On)
Negative – digital output is energized when the relay source is inactive (Off)

Return to top of page.

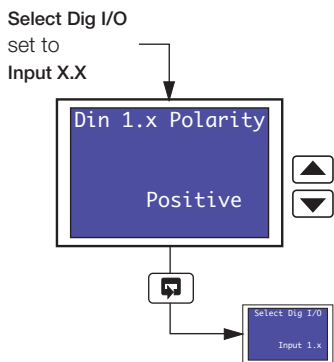

Digital Input Polarity

Select the polarity required for the selected digital input:
Positive – digital output state is unchanged
Negative – digital output state is inverted

Return to top of page.

3.10 Analog Output Configuration Overview.

- **Fitted analog outputs** – assignable to retransmit any process variable
- **Selectable analog output range** – allows maximum resolution on range of interest
- **Adjustable output range** – for non-standard and reversed outputs

The example below shows analog output 1 programmed to retransmit part of process variable 1's engineering range (250 to 750°C) as a 4.0 to 20.0 mA current output.

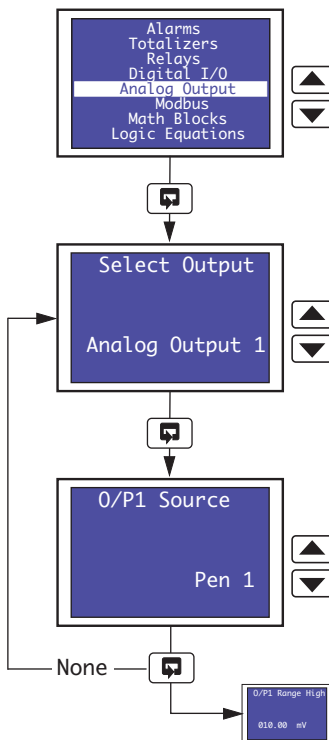
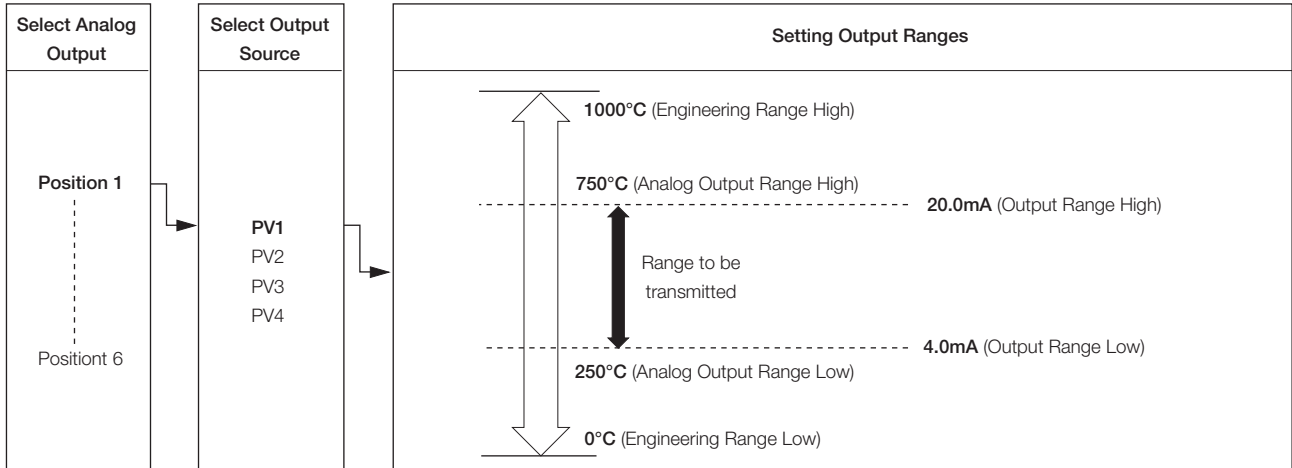

Analog Output Configuration

Press the key to open the **Main Menu**.
Highlight **Analog Output**.

Select Analog Output

Select the analog output to be configured.

Analog Output Source

Select the source for the analog output.
Refer to Appendix A on page 77 for a description of sources.

Continued on next page.

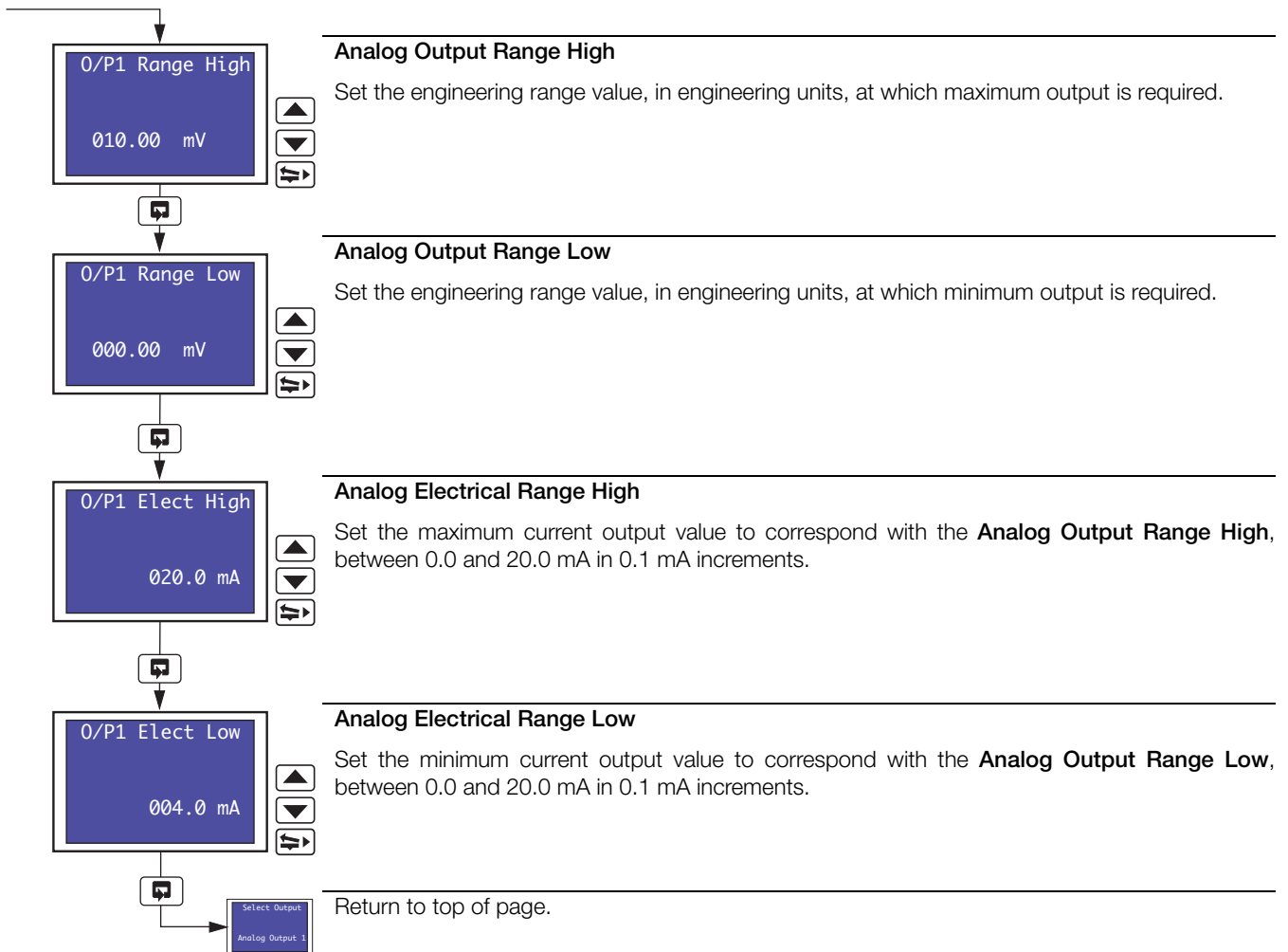

3.11 Logic Equation Configuration

Overview.

- 8 logic equations
- Up to 4 operands and 3 operators per equation
- OR/AND/XOR/NAND/NOR/NOT operators
- Can combine internal and external digital signals – i.e. alarms, digital inputs, other logic equation results and real-time events (if timer software option enabled by installation of the appropriate software key)

For each equation, the logic elements 1 to 7 are arranged sequentially, as shown below. Odd numbered elements are used for logic inputs (operands) and even numbered elements for logic gates (operators).

Logic inputs must be set to one of the digital sources in Appendix A on page 77.

Logic inputs may be inverted (set to NOT)

Logic gates must be set to AND, OR, XOR, NAND, NOR or END. Setting an element to END terminates the equation.

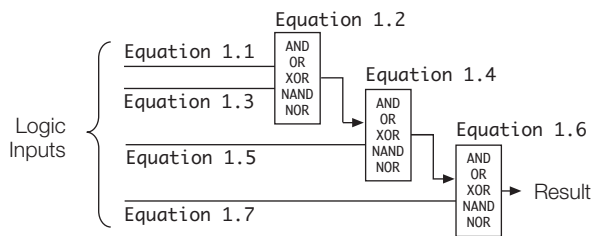

Note. The elements of each equation are calculated sequentially, i.e. elements 1, 2 and 3 are evaluated first and the result combined with elements 4 and 5. This result is then combined with elements 6 and 7 to give the logic equation result.

Example – Reservoir level monitoring using:

- process variable 1 with an engineering range of 0 to 100 feet
- logic equation 1 result assigned to relay 1.1 that is used to operate the control valve.

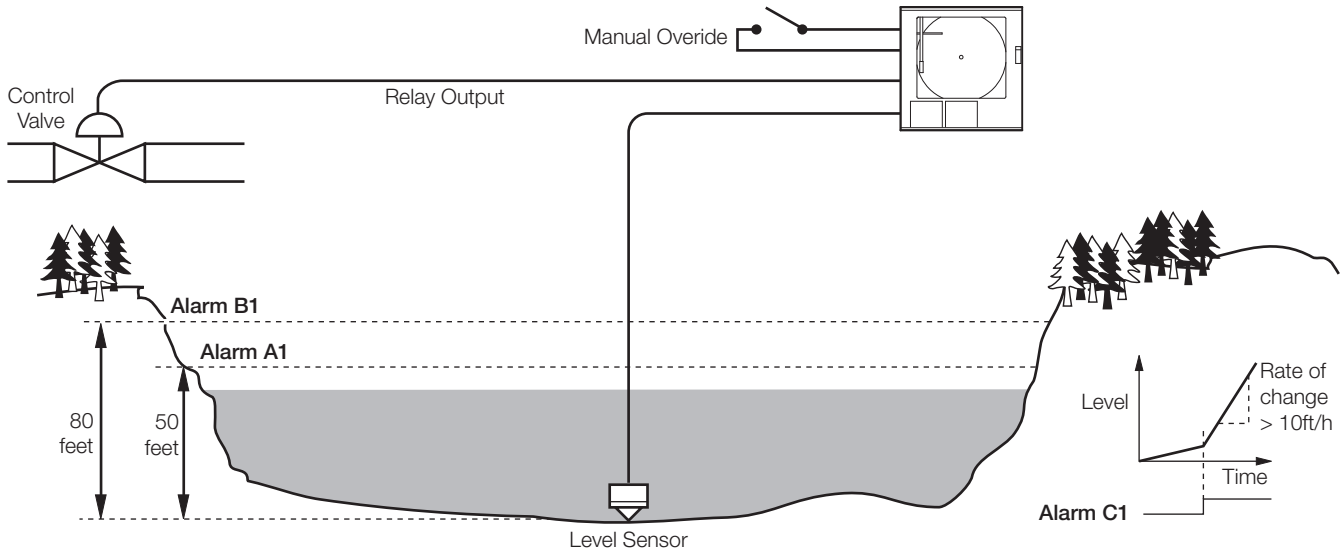

Flow Conditions
Close reservoir control valve if:
<ul style="list-style-type: none"> • Reservoir level >50 feet AND rate of change >10 ft/hr
OR
<ul style="list-style-type: none"> • Reservoir level >80 ft
OR
<ul style="list-style-type: none"> • Manual override switch operated

Input Elements
<ul style="list-style-type: none"> • Alarm A1 – set to high process trip at 50 ft • Alarm B1 – set to high process trip at 80 ft • Alarm C1 – set to fast rate trip at 10% of range per hour (10 ft/hr) • Manual override switch: Connected to digital input 1.1 Digital input number <u> </u> Module number <u> </u> Negative polarity Volt-free switching

Entering the Logic Equation
Equation 1.1 ⇔ Alarm A1
Equation 1.2 ⇔ AND
Equation 1.3 ⇔ Alarm C1
Equation 1.4 ⇔ OR
Equation 1.5 ⇔ Alarm B1
Equation 1.6 ⇔ OR
Equation 1.7 ⇔ Digin Main 1

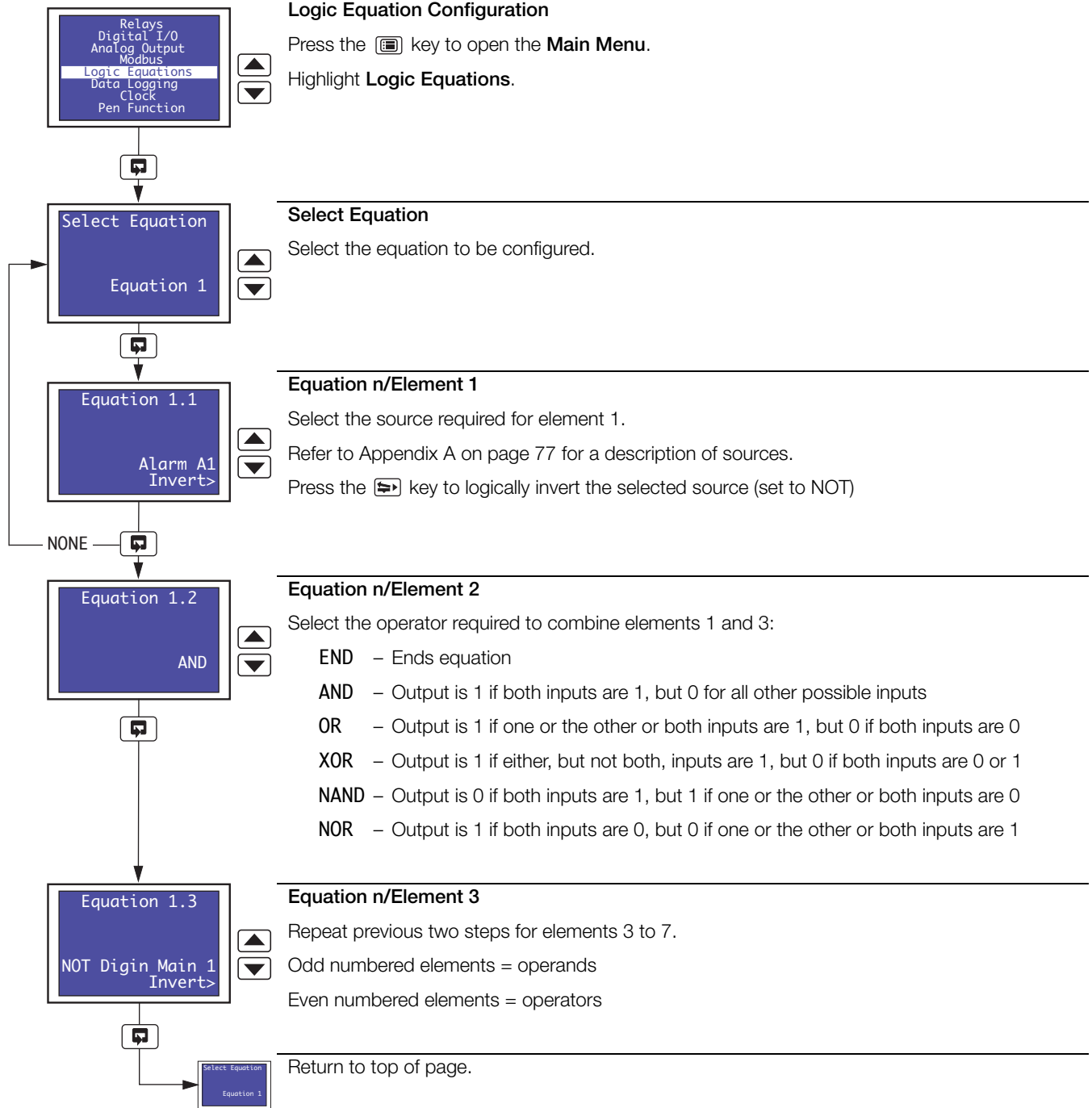

3.12 Data Logging Configuration

Note. The data logging option is no longer available. Data logging information has been retained in this publication for reference purposes only.

Trend pen channel data values and the contents of the totalizer log (if the totalizer option is enabled by installation of the appropriate software key) can be saved to a Compact Flash card if the optional data logging hardware is installed and data logging is on-line. Logged data is compatible with the Company's DataManager data analysis software package. DataManager is a Microsoft® Excel add-in that enables the analysis and validation of the recorder's pen channel data values and log files on a PC.

- Note.**
- The recorder is not equipped with an internal memory therefore recorded pen channel data values are **lost** if a Compact Flash card with *sufficient available free space* is not inserted.
 - Logging starts automatically when a card is inserted and continues until either the card is removed or becomes full.
 - The content of the totalizer log (if the totalizer option is enabled by installation of the appropriate software key) is saved automatically to the Compact Flash card when data logging is on-line.
 - Event pen data is not logged.

File Types

Files created by the recorder are given filenames automatically. Each type of file is given a different filename extension as shown in Table 3.3.

Type	Extension	Contents
Pen channel data files	*.D00	Digital recording channel data
Totalizer log files	*.TE0	The historical record of all totalizer and associated statistical values relating to a particular pen channel

Table 3.3 File Types

Filenames

Filenames are formatted as shown in Table 3.4.

Type	Format
Pen channel data files	<Start Time hh_mm> Start Date ddmmmyy><Instrument tag>.D00
Totalizer log files	<Start Time hh_mm> Start Date ddmmmyy><Instrument tag>.T00

Table 3.4 Filenames

Data Verification and Integrity

Each block of data in the pen channel data files has its own data integrity check. This enables the integrity of the data stored on the Compact Flash card to be verified when it is viewed using the DataManager software.

Totalizer log files also contain built-in integrity checks enabling the integrity of the data to be verified by the DataManager software.

Recording Duration

(4 Channels)	128MB	256MB	512MB	1GB
1 s	1.1 months	2.3 months	4.5 months	8.8 months
5 s	5.6 months	11.3 months	1.9 years	3.6 years
10 s	11.3 months	1.9 years	3.7 years	7.2 years
30 s	2.8 years	5.6 years	11.1 years	21.7 years
60 s	5.6 years	11.1 years	22.2 years	43.4 years
5 min.	27.8 years	55.5 years	111.0 years	216.8 years
10 min.	55.5 years	111.0 years	222.1 years	433.7 years
30 min.	166.5 years	333.1 years	666.2 years	1301.1 years
1 hour	333.1 years	666.2 years	1332.3 years	2602.2 years
6 hour	1998.5 years	3996.9 years	7993.9 years	15613.1 years

Table 3.5 Recording Duration

Note. Data Logging is available only if the Data Logging option is enabled by installation of the optional hardware.

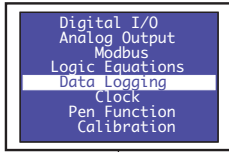

Data Logging Configuration

Press the key to open the **Main Menu**.
Highlight **Data Logging**.



Sample Rate

Select the sample rate to be applied to all recording channels.

Select from:
1, 5, 10, 30 or 60 seconds
5, 10 or 30 minutes
1 or 6 hours

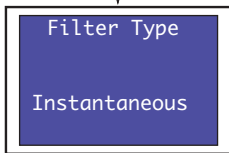

Pre-logging Filter Type

Select the filter type to be applied to all recording channels prior to logging.

Instantaneous—A single value based on process conditions at the time of sampling

Max/Min—Two values are recorded to capture the maximum and minimum signal values since the previous sample

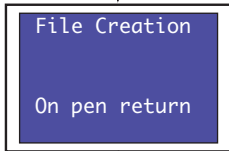

New File Creation

Select the interval at which new data logging files are created:

Standard—new files are created when:
a file becomes full (i.e. it has reached 65,000 entries)
or
the Compact Flash card is removed and re-inserted
or
power to the recorder is restored after being interrupted
or
the recorder's configuration is changed

On Pen Return—In addition to the Standard file creation intervals, new files are also created when the pens are returned to their recording positions. This enables recorded files to match the chart record.

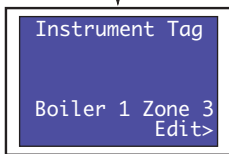

Instrument Tag

Use the , , and keys to enter a tag of up to 16 characters – see Fig. 2.1 on page 6.

Note. Any characters not permitted in this tag are skipped when scrolling through the selection.

The tag is included in the archive files to identify the source of the data.



Continued on next page.

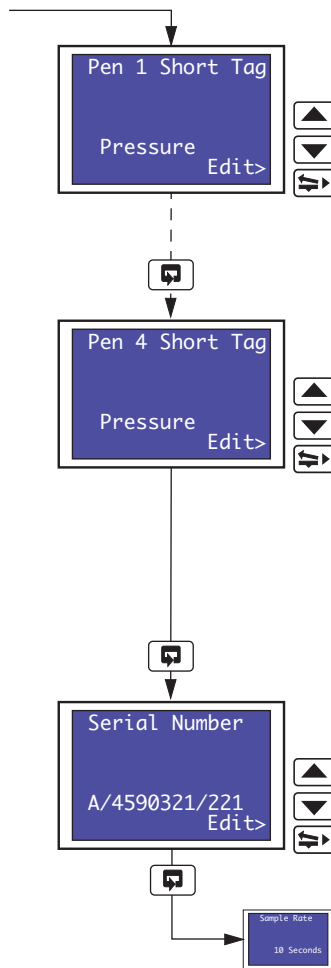

Pen 1 Short Tag

Note. This tag is required to provide compatibility with the Company's DataManager data analysis software package and is used to identify the column of data for Pen 1.

Use the ▲, ▼ and ⇨ keys to enter the a tag of up to 8 characters – see Fig. 2.1 on page 6.

Note. Any characters not permitted in this tag are skipped when scrolling through the selection. The tag is included in the archive files to identify the channel.

Pens 2 to 4 Short Tag

Notes.

- Displayed only if the pen is fitted.
- These tags are required to provide compatibility with the Company's DataManager data analysis software package and are used to identify the column of data for each pen.

Use the ▲, ▼ and ⇨ keys to enter the a tag of up to 8 characters – see Fig. 2.1 on page 6.

Note. Any characters not permitted in this tag are skipped when scrolling through the selection. The tag is included in the archive files to identify the channel.

Serial Number

Use the ▲, ▼ and ⇨ keys to enter a serial number to be used to identify the recorder – see Fig. 2.1 on page 6.

Note. Any characters not permitted in this tag are skipped when scrolling through the selection.

Return to top of page.

3.13 System Clock Configuration

Note. The System Clock is available only if any of the Totalizer, Math or Timers software options are enabled by installation of the appropriate software key, or the optional Data Logging hardware is installed.

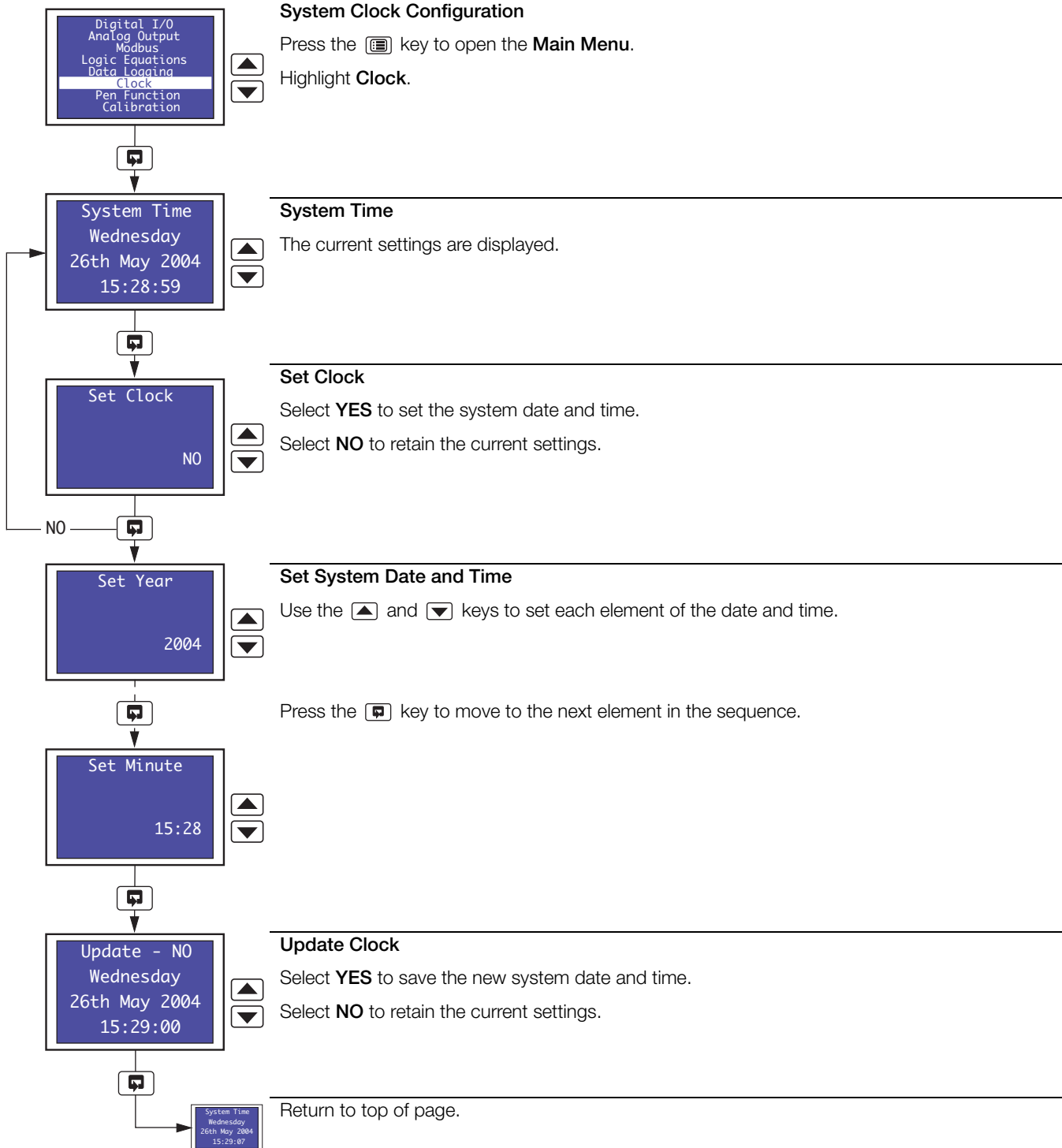

3.14 Pen Function

Overview.

- **Trend Pens** – the chart range is configured independently of the engineering range (see Section 3.5, page 24) to enable a selected part of the engineering range to be used for display thus giving extra detail on the chart.
- **Event Pens** – assigned to digital inputs, alarms, logic equation results and real-time events (if timer software option enabled by installation of the appropriate software key).

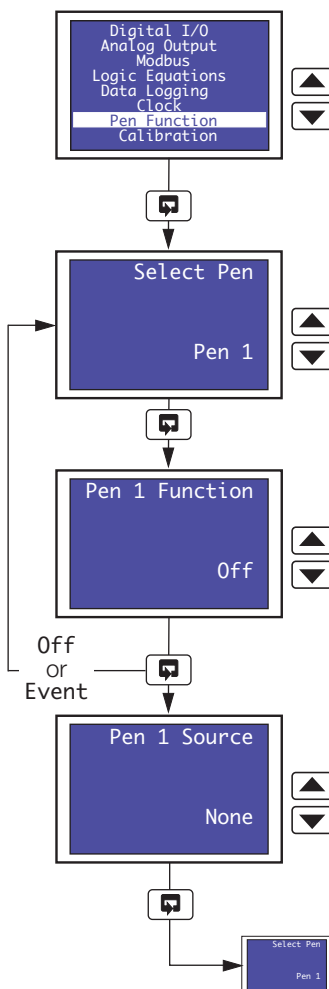
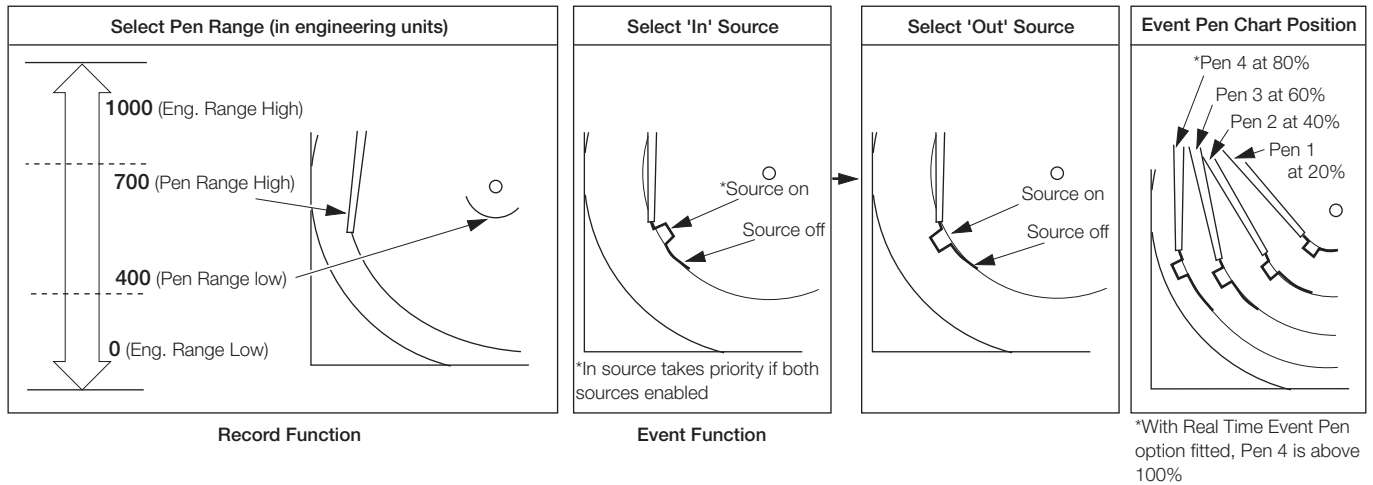

Pen Function

Press the key to open the **Main Menu**.

Highlight **Pen Function**.

Select Pen

Select the pen to configure.

Pen Function

Select the required pen function:

- Off** – No function
- Trend** – Trend
- Event** – Event

Pen Source

Select an input source or math block for the selected pen as required.

Return to top of page.

3.15 Calibration

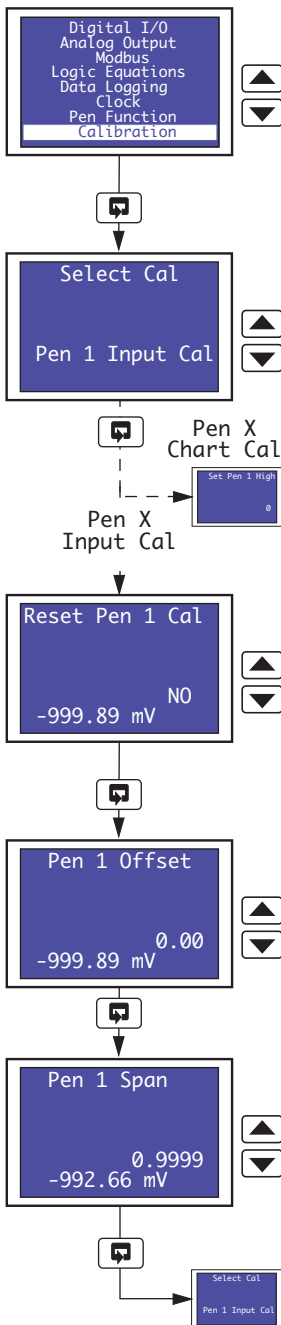

Calibration

Press the key to open the **Main Menu**.

Highlight **Calibration**.

Select Cal

Select the pen input channel or pen chart position to calibrate.

Continued on next page.

Reset Pen Calibration

Select **YES** to reset the offset and span values to their nominal values.

Select **NO** to retain the current offset and span values.

Offset

Set the required offset value for the selected pen or analog input.

Span

Set the required span value for the selected pen or analog input.

Return to top of page.

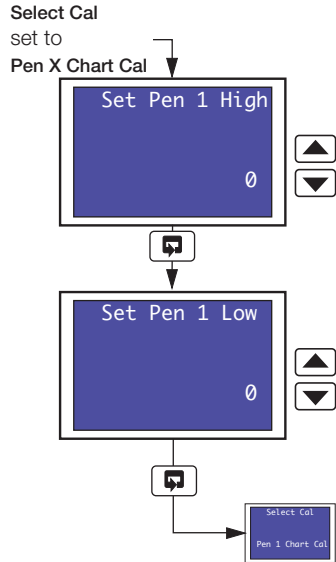

Pen High Value

Set the required chart high value for the selected pen, between 0 and 200.

Pen Low Value

Set the required chart low value for the selected pen, between 0 and 200.

Return to top of page.

3.16 Backing Up and Restoring Configurations

A backup file of the recorder's configuration settings can be saved to a PC and restored to the recorder using the **C1300 Configuration Backup Utility Software** (download from www.abb.com/recorders) and **Configurator Cable** (part no. C100/0051 – available from the Company).

3.16.1 Backing Up a Configuration

- 1 Connect the Configurator Cable to the recorder's configuration backup port (see Fig. 3.5) and the PC's serial port.

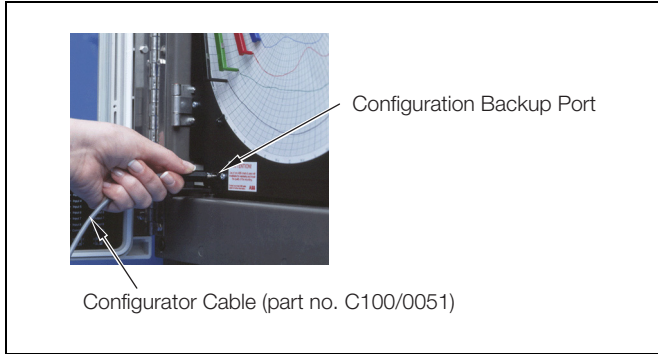
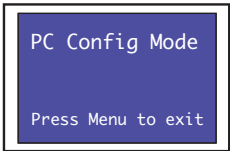

Fig. 3.5 Configuration Backup Port



- 2 Press the key to open the **Main Menu**.



- 3 Highlight **Common** (or any of the Configuration level selections below Common).

- 4 Press the and keys simultaneously to place the recorder into **PC Config Mode**.

- 5 Run the software 'C1300 Configuration Backup Utility.exe' on the PC.

- 6 Save the current configuration – see Fig. 3.6.

- 7 Exit the **C1300 Configuration Backup Utility Software**.

- 8 Disconnect the **Configurator Cable**.

- 9 Press the key to return the recorder to normal operation – see Section 2.3.1, page 8.

- 1 Select the port to which the configurator cable is connected
- 2 Select 'Upload Config.' radio button
- 3 Assign a name and location to the configuration file to be saved
- 4 Click to save the configuration backup file
- 5 The following message is displayed
- 6 The following is displayed when upload is complete

Fig. 3.6 Backing Up a Configuration

Note. The following warning is displayed if an incorrect port was selected in step 1 or the recorder is not connected correctly to the PC.

3.16.2 Restoring a Configuration



① Connect the Configurator Cable to the recorder's configuration backup port (see Fig. 3.5) and the PC's serial port.

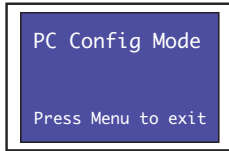

② Press the  key to open the **Main Menu**.

③ Highlight **Common** (or any of the Configuration level selections below Common).



④ Press the  and  keys simultaneously to place the recorder into **PC Config Mode**.

- ⑤ Run the software 'C1300 Configuration Backup Utility.exe' on the PC.
- ⑥ Restore the configuration – see Fig. 3.7.
- ⑦ Exit the **C1300 Configuration Backup Utility Software**.
- ⑧ Disconnect the **Configurator Cable**.
- ⑨ Press the  key to return the recorder to normal operation – see Section 2.3.1, page 8.

① Select the port to which the configurator cable is connected

③ Select the configuration file to be restored

② Ensure 'Download Config.' radio button selected

④ Click to restore the configuration backup file

⑤ The following message is displayed

Note. The following warning is displayed if an incorrect port was selected in step ① or the recorder is not connected correctly to the PC.

Note. Select a location away from strong electrical and magnetic fields. If this is not possible, particularly in applications where mobile communications equipment is expected to be used, screened cables within earthed metal conduit must be used.

⑥ The following is displayed when upload is complete

Fig. 3.7 Restoring a Configuration

4 Mechanical Installation

4.1 Siting

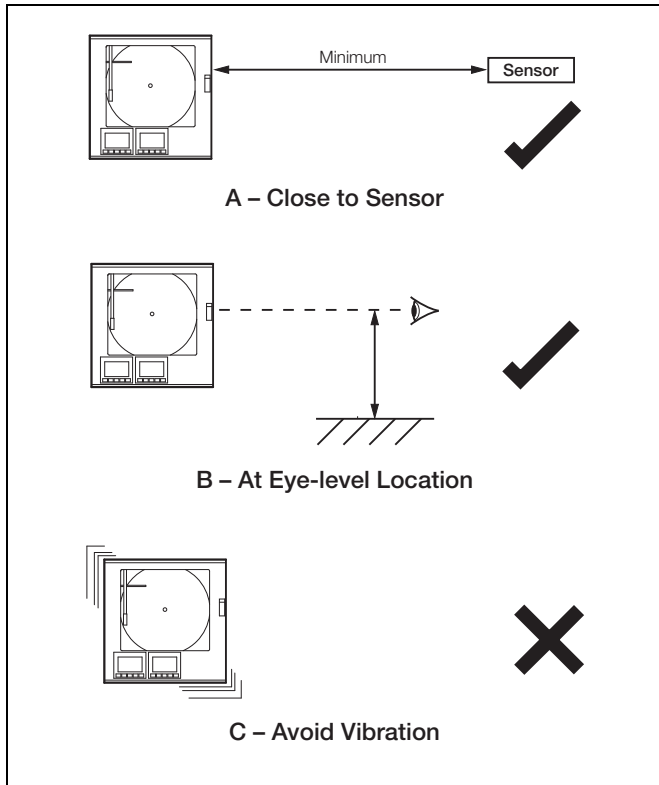

Fig. 4.1 General Requirements

Note. Remove knockouts by striking from the inside of the case, taking great care not to damage any internal components. Alternatively, drill out to 0.875 in. (22.2mm) using a suitable drill bit.

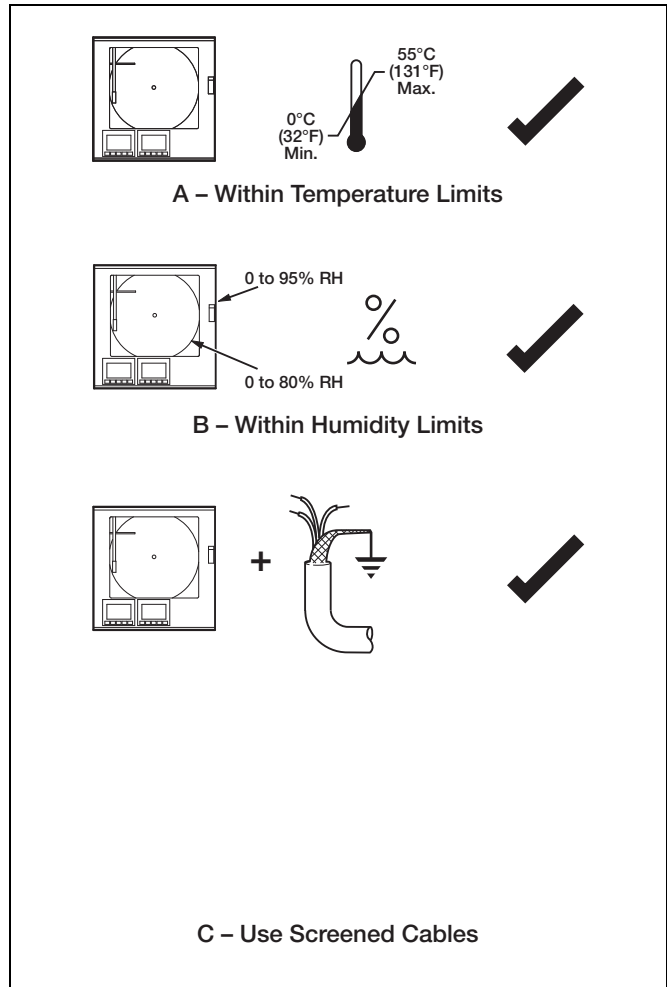

Fig. 4.2 Environmental Requirements

4.2 Mounting

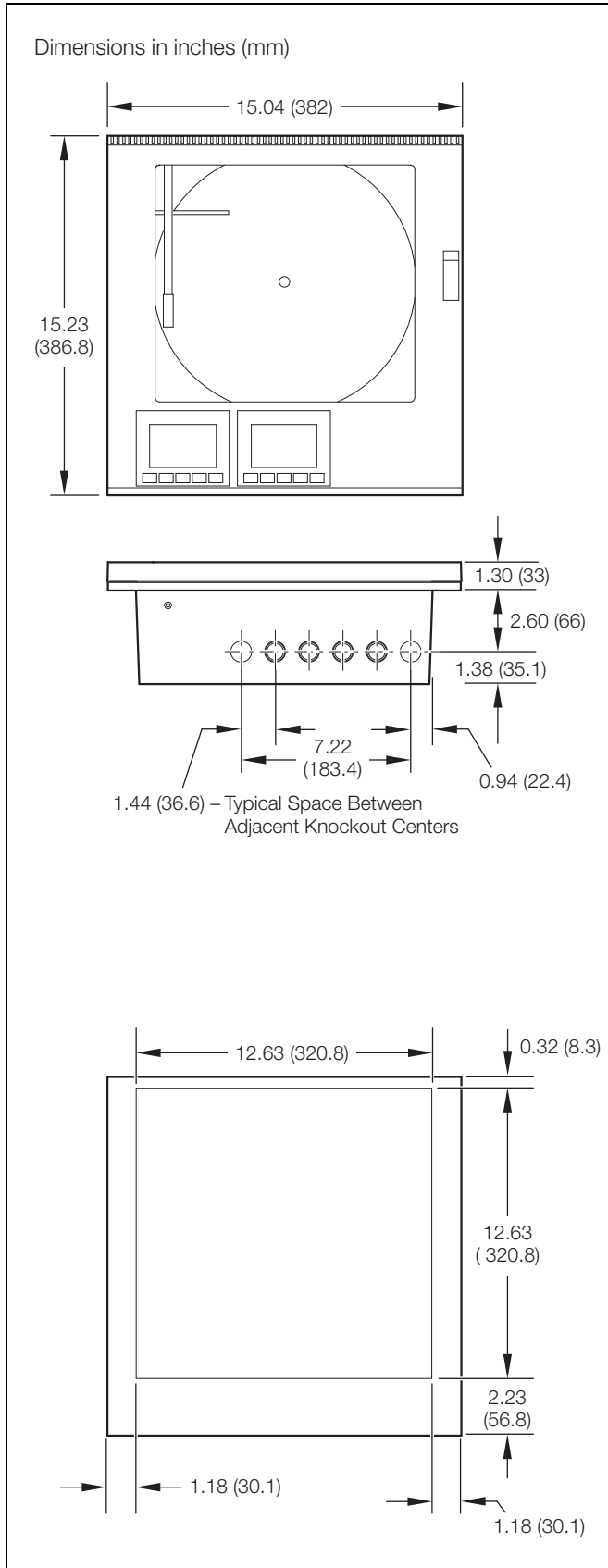

Fig. 4.3 Overall Dimensions

4.2.1 Wall-/Pipe-Mounting

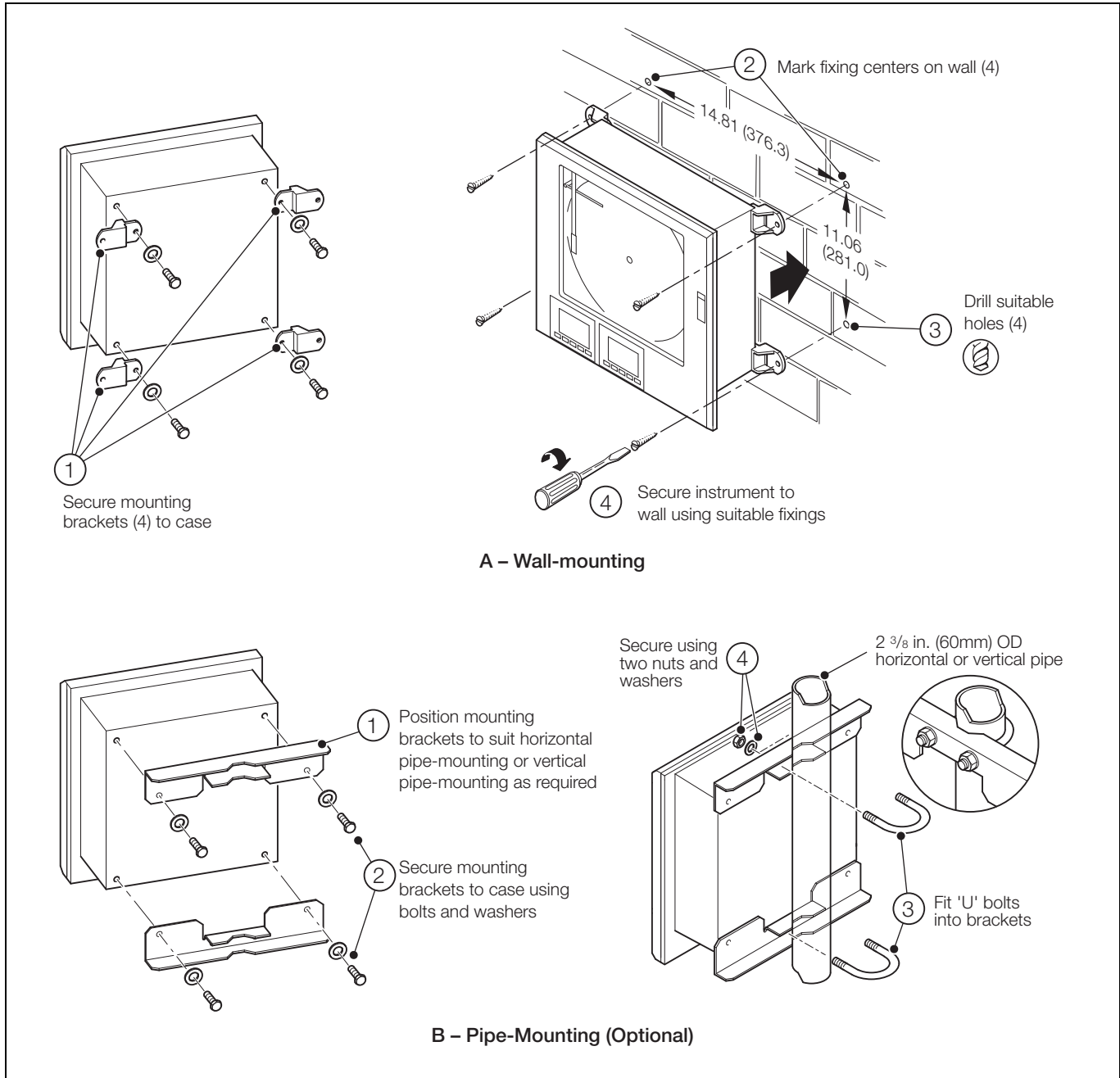

Fig. 4.4 Wall-/Pipe Mounting

4.2.2 Panel Mounting

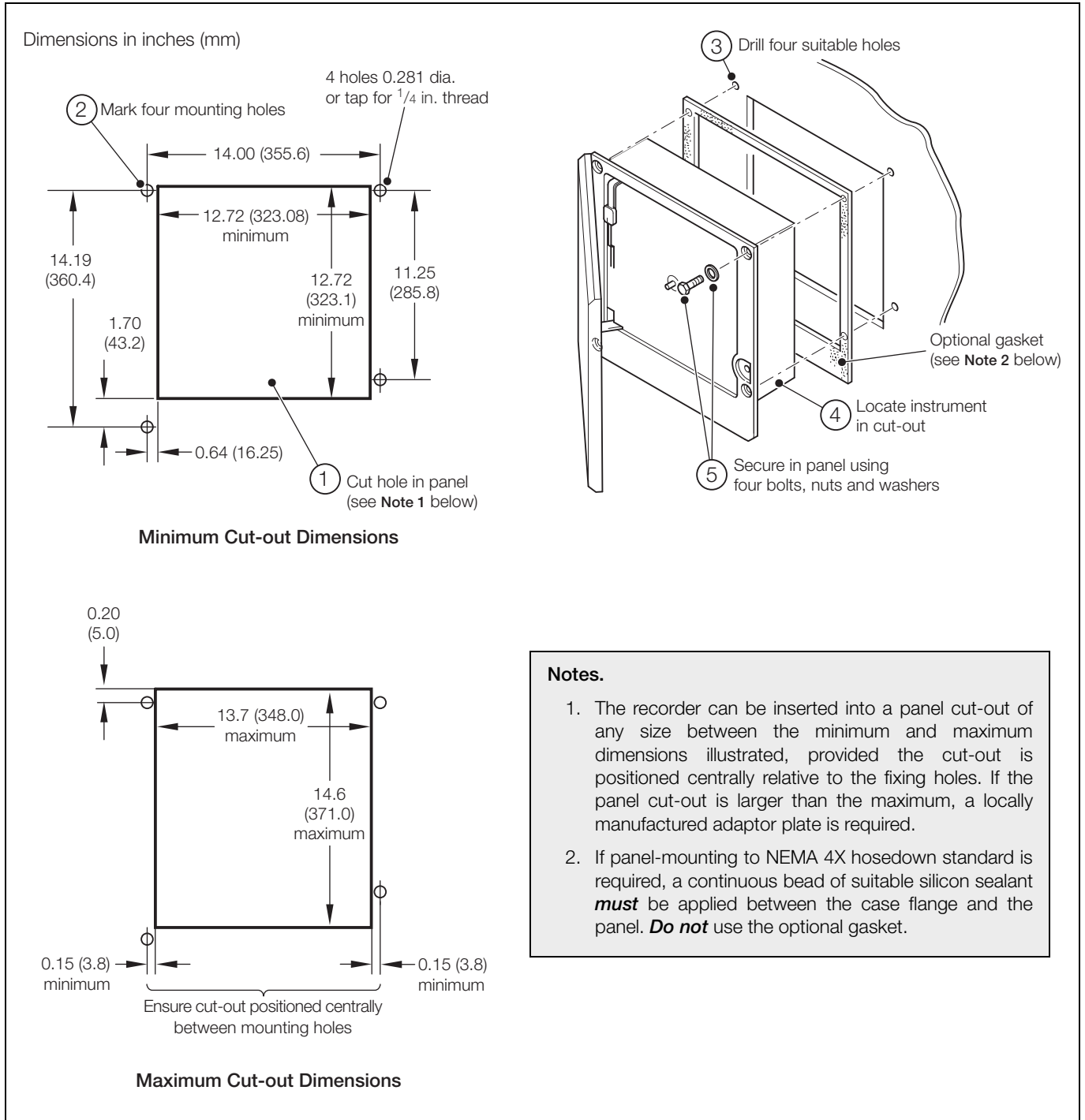

Fig. 4.5 Panel Mounting

5 Electrical Installation

Warning.

- To comply with Underwriter Laboratories (UL) and Canadian Standards Association (CSA) certification, route signal leads and power cables in earthed (grounded), flexible metal conduit.
- Recorders not fitted with the optional internal on/off switch and fuse must have an external fuse and disconnecting device such as a switch or circuit breaker conforming to local safety standards fitted to the final installation. They must be fitted in close proximity to the recorder within easy reach of the operator and must be marked clearly as the disconnection device for the recorder.
- Remove all power from supply, relay and any powered control circuits and high common mode voltages before accessing or making any connections.
- Use cable appropriate for the load currents. The terminals accept cables up to 14AWG (2.5mm²).
- The power supply and all inputs and outputs conform to Insulation Category II, Pollution Degree II.
- All connections to secondary circuits must have basic insulation.
- After installation, there must be no access to live parts e.g. terminals.
- Terminals for external circuits are for use only with equipment with no accessible live parts.
- If the recorder is used in a manner not specified by the Company, the protection provided by the equipment may be impaired.
- All equipment connected to the recorder's terminals must comply with local safety standards (IEC 60950, EN601010-1).

Note.

- Always route signal leads and power cables separately.
- Use screened cable for signal inputs and relay connections. Connect the screen to the earth (ground) stud – see Fig. 5.9 on page 71.
- The terminal blocks can be removed from the main PCB when making connections – see Fig. 5.1 on page 65. Before removing a module, note its position.
- If wall- or pipe-mounting to NEMA 4X hosedown standard is required, suitable cable glands *must* be used to prevent water ingress.
- The optional Software Key (if fitted), part number C1900/0463, contains a non-replaceable 3.0V lithium cell.

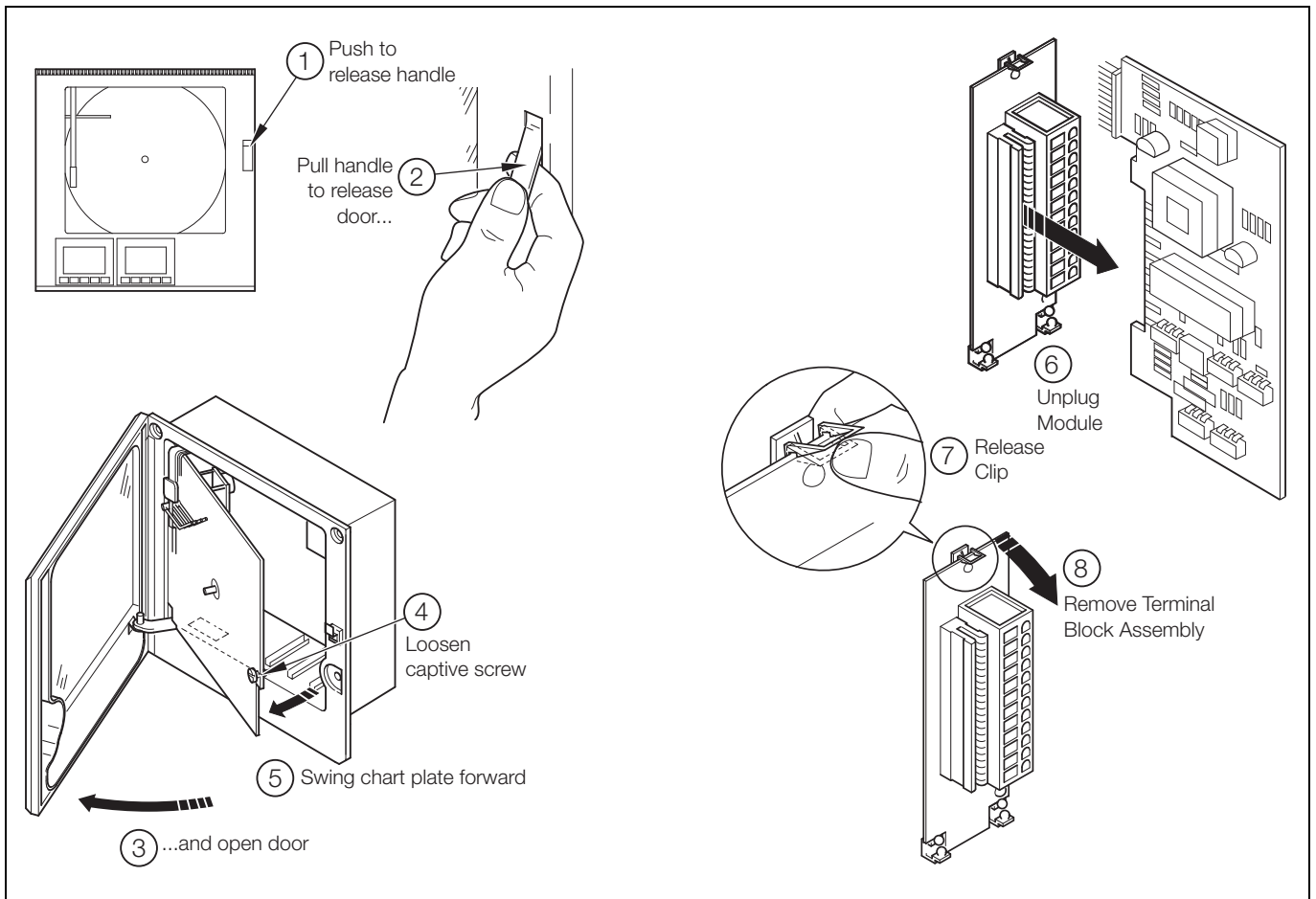

Fig. 5.1 Removing Terminal Block Assembly

5.1 Identifying the Input/Output Modules

To gain access to the modules, open the door and chassis – see Fig. 5.1 on page 65. There are five module positions (2 to 6) as shown in Fig. 5.2.

5.2 Channel Connections

Channel 1 connections are made directly to the terminal block mounted on the motherboard.

Other Channel connections are made to standard I/O modules, fitted in positions 2, 3 or 4 – see Fig. 5.2.

Warning. The maximum channel to channel voltage (between any 2 channels) must not exceed 500V DC.

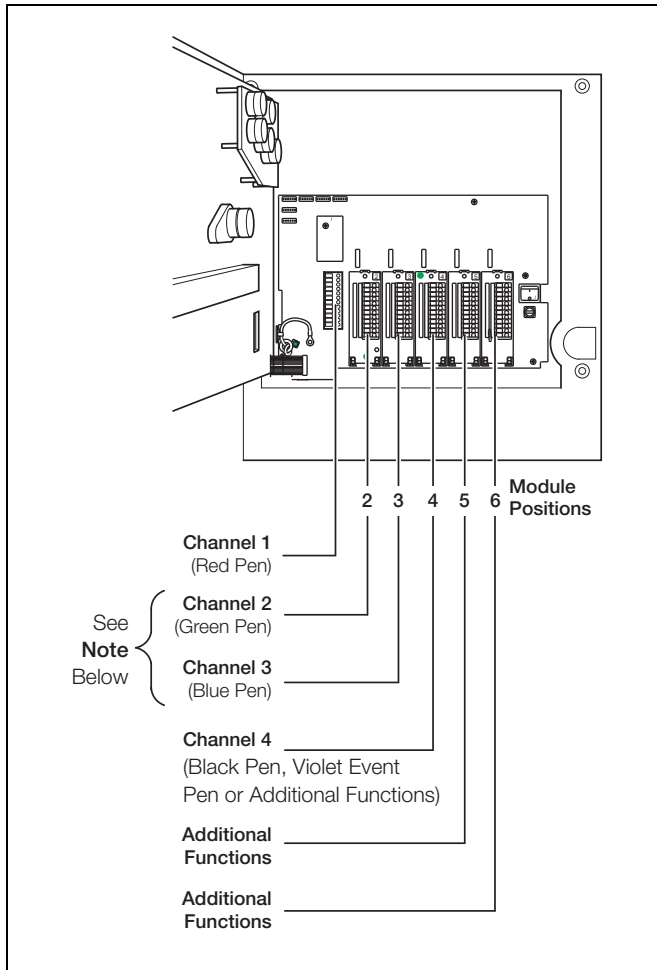

Fig. 5.2 Module Positions and Functions

Note.

- Module positions 2 and 3 can also be used for additional I/O modules (module types 1 and 2) for use with math functions.
- The module type is marked on the component side of the PCB.

5.2.1 Selecting the Analog Input Type(s)

Plug-in links are used to select the input type:

Channel 1 PL1 & PL8 on the main PCB (Fig. 5.3)

Channels 2 to 4 PL1 & PL3 on the module (Fig. 5.4)

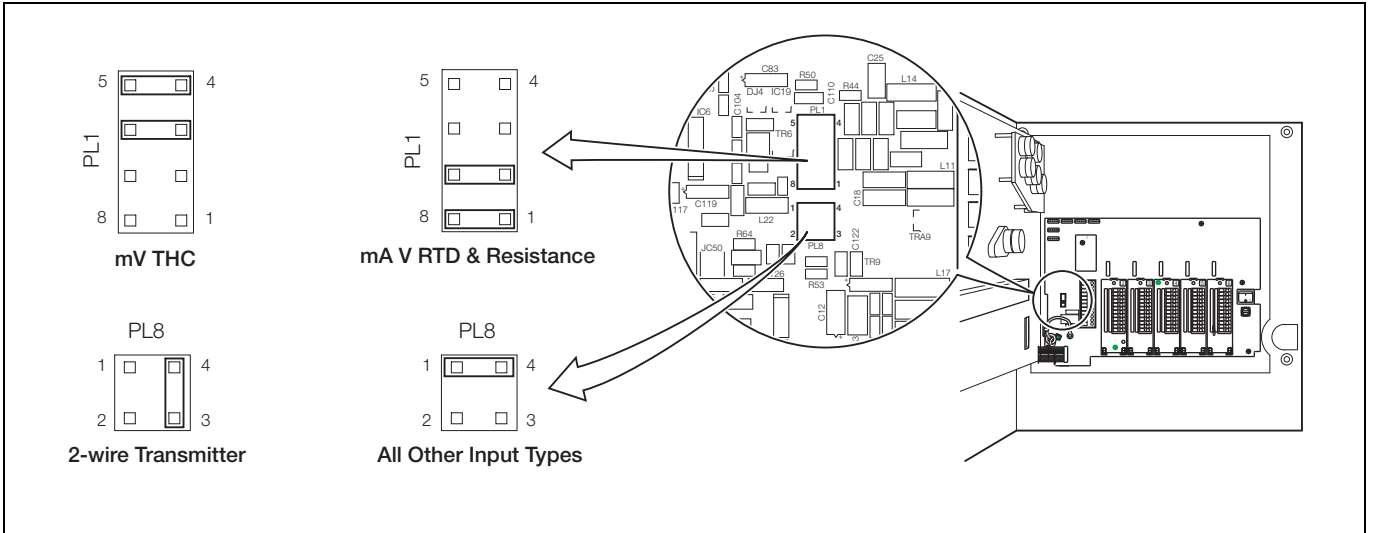

Fig. 5.3 Selecting the Input Type (Main Board)

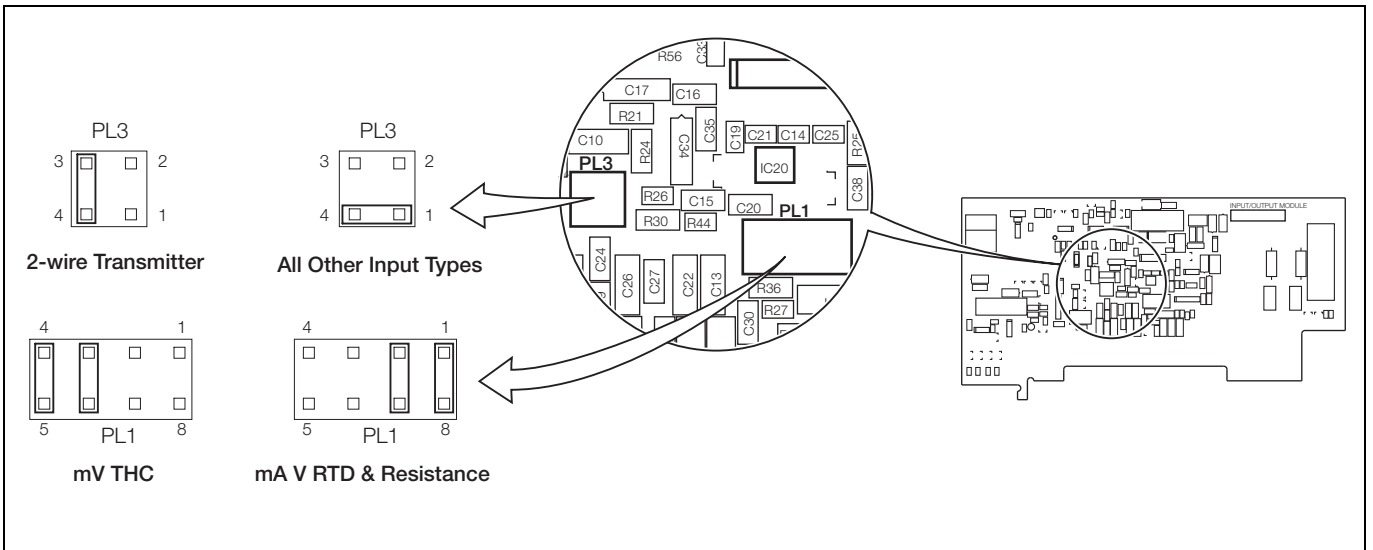

Fig. 5.4 Selecting the Input Type (I/O Modules)

Type of Thermocouple	Compensating Cable											
	BS1843			ANSI MC 96.1			DIN 43714			BS4937 Part No.30		
	+	-	Case	+	-	Case	+	-	Case	+	-	Case
Ni-Cr/Ni-Al (K)	Brown	Blue	Red	Yellow	Red	Yellow	Red	Green	Green	Green	White	Green*
Ni-Cr/Cu-Ni (E)		—			—			—		Violet	White	Violet*
Nicrisil/Nisil (N)	Orange	Blue	Orange	Orange	Red	Orange		—		Pink	White	Pink
Pt/Pt-Rh (R and S)	White	Blue	Green	Black	Red	Green	Red	White	White	Orange	White	Orange*
Pt-Rh/Pt-Rh (B)		—			—			—		Grey	White	Grey*
Cu/Cu-Ni (T)	White	Blue	Blue	Blue	Red	Blue	Red	Brown	Brown	Brown	White	Brown*
Fe/Con (J)	Yellow	Blue	Black	White	Red	Black	Red	Blue	Blue	Black	White	Black*
* Case Blue for intrinsically safe circuits												
Fe/Con (DIN 43710)		—			—		DIN 43710 Blue/Red Blue Blue				—	

Table 5.1 Thermocouple Compensating Cable

5.2.2 Voltage and Current

Note. Input impedances:

Low voltage (mV)	>10MΩ
Voltage	>10MΩ
Current (mA)	100Ω

5.2.3 2-wire Transmitter Input

Power for the transmitter is supplied by terminal 6.

Note. The voltage across terminals 4 and 6 is 20V (nominal). This is due to internal voltage drops across a shunt resistor and measurement circuitry.

5.2.4 Thermocouple

Use the correct compensating cable between the thermocouple and the terminals – see Table 5.1 on page 68.

An automatic cold junction (ACJC) is incorporated but an independent cold (reference) junction may be used.

5.2.5 Resistance Thermometer (RTD)

If long leads are necessary it is preferable to use a 3-lead resistance thermometer.

If 2-lead resistance thermometers are used each input must be calibrated to take account of the lead resistance.

5.2.6 Logic Inputs

The two logic inputs accept either volt-free (switch) or TTL (5V) input types and can be used for remote switching of many recorder functions, e.g. chart stop/go, alarm acknowledgment, totalizer reset etc. – see Section 3.11, page 47.

5.2.7 Analog Output

5.2.8 Relay Output

Note. Relay specification:

Type	single pole changeover	
Voltage	250V AC	250V DC
Current	5A AC	5A DC
Loading (non inductive)	1250VA	50W
Isolation, contacts to earth	2kV RMS	

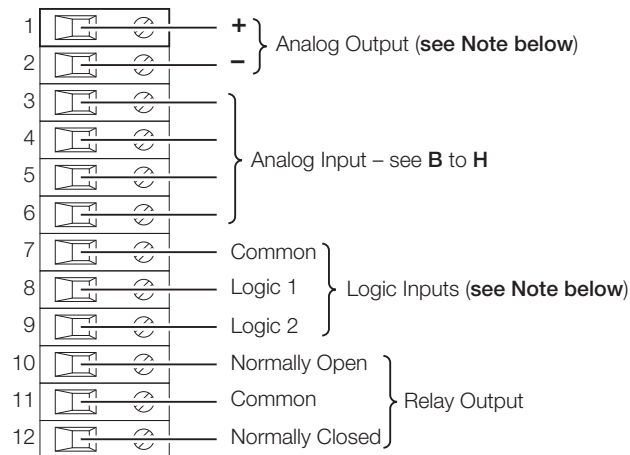

Note. Not applicable on Type 2 Modules.

A – Summary of Connections

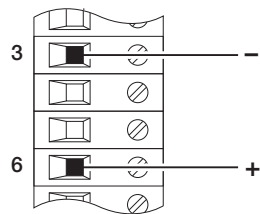

B – Voltage

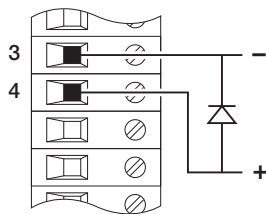

C – Current
(non 2-wire transmitters) *



D – 2-wire Transmitter

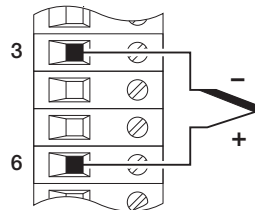

E – Thermocouple

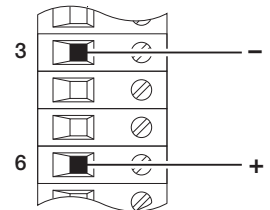

F – Low Voltage (mV)

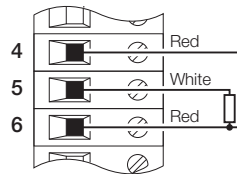

G – 3-wire RTD

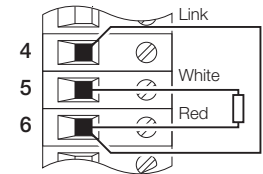

H – 2-wire RTD & Resistance

* Recommended diode:
Diode forward voltage must be > 0.8 V @ 20 mA or use 2 x 1N4001 general purpose diodes in series.

Fig. 5.5 Channel Connections

5.3 Module Connections

5.3.1 Standard I/O or Analog + Relay (Module Types 1, 2 and 7)

The connections are the same as Channel connections to the main board. Refer to Section 5.2.

5.3.2 Four Relay Module (Module Type 3)

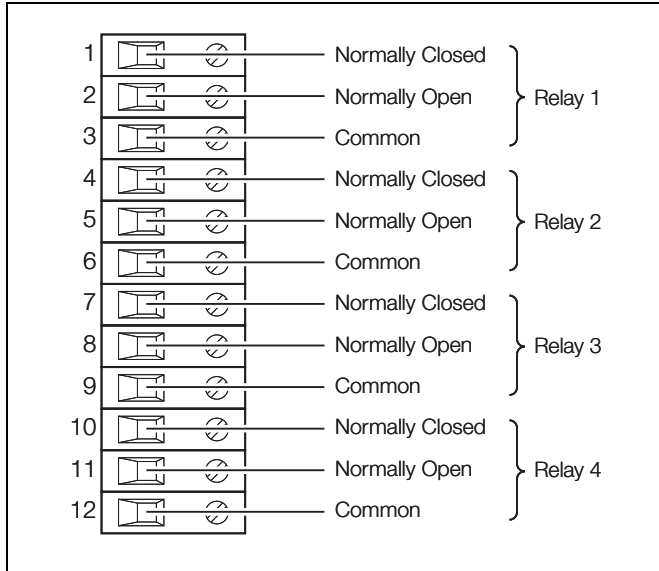

Fig. 5.6 Four Relay Module Connections (Module Type 3)

5.3.3 Eight Digital Inputs or Outputs (Module Types 4 and 5 respectively)

A plug-in link is used to select the board's function; digital inputs or digital outputs – see Fig. 5.7. The maximum current drain from each TTL output must not exceed 5mA.

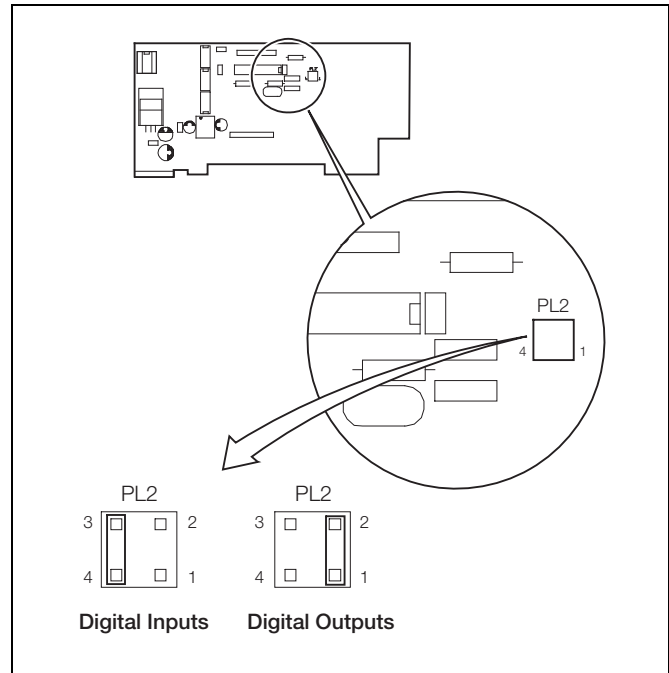

Fig. 5.7 Selecting the Digital Module Function (Module Types 4 and 5)

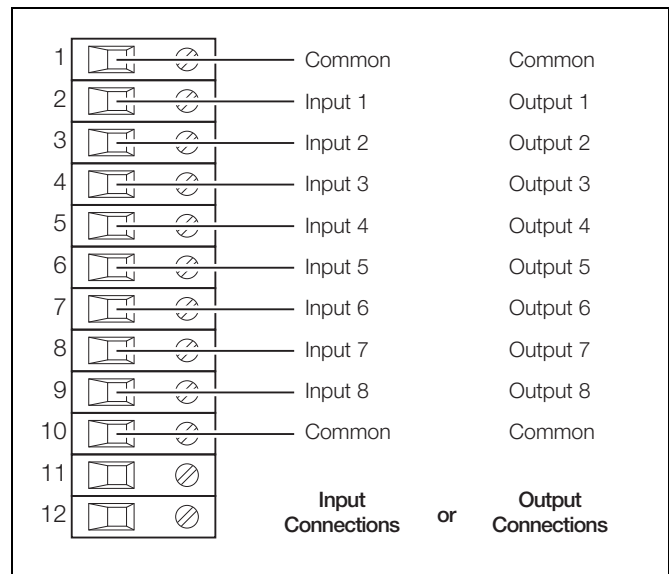

Fig. 5.8 Eight Digital Inputs or Outputs Connections (Module Types 4 and 5)

Notes.

1. Fuse rating – 500mA (20 X 5mm) Type T.
2. Ensure that the Earth (Ground) lead is longer than the Line and Neutral leads.

5.4 Power Supply Selection and AC Connections

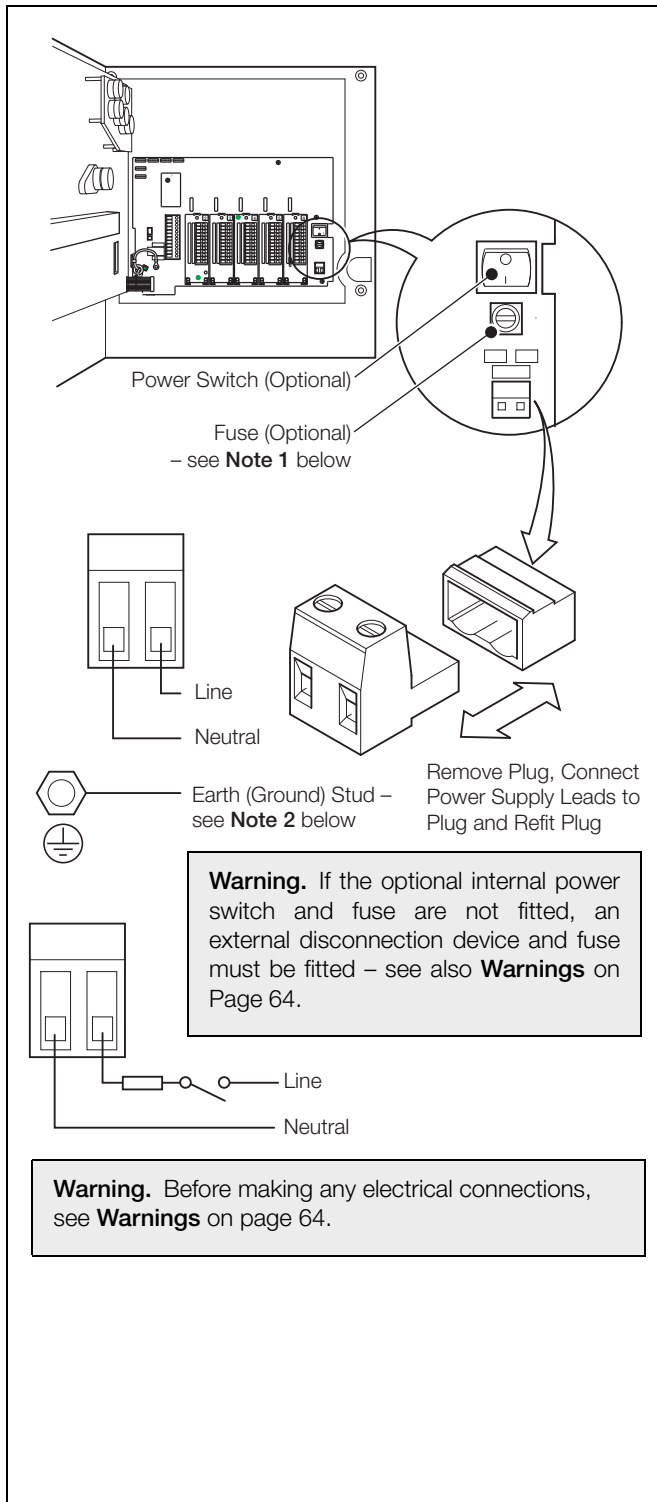

Fig. 5.9 Power Supply Selection and AC Connections

6 Fault Diagnosis

Symptom	Possible Cause	Action
Recorder does not power up	a) Internal fuse (if fitted) is blown b) Internal power switch (if fitted) is OFF c) Power supply connections are incorrect	a) Check wiring, rectify fault and replace fuse b) Turn power switch ON c) Check connections
Chart does not appear to move	a) Very slow chart duration selected – see Section 3.4, page 20 b) Stop Chart Source selected – see Section 3.4, page 20	a) Select required chart duration in Common Configuration – see Section 3.4, page 20 b) Set Stop Chart Source to None – see Section 3.4, page 20
Pens in recording position but do not drop onto paper	Stop Chart Source selected – see Section 3.4, page 20	Set Stop Chart Source to None – see Section 3.4, page 20
Red pen does not move beyond 94% position on chart	When real-time event pen is fitted the red pen cannot go beyond 94% to prevent pens clashing	Use chart range that prevents the need to go beyond 94% of maximum on chart
Pen lift key on front panel does not work	Pen lift key is disabled	Set Pen Lift Enable to YES – see Section 3.4, page 20
Pens do not remain lifted when pen lift key is used	Auto pen drop feature is enabled	Set Auto Pen Drop to NO – see Section 3.4, page 20
Analog inputs are slow to respond	A large filter time has been set	Set Pen X Filter to a value that gives the required response – see Section 3.5, page 24
Time or date incorrect	Not set for correct local time	Set correct time and date – see Section 3.12, page 50
Totalizers cannot be reset by the Operator	Totalizer reset function is not enabled	Set Totalizer Reset to YES – see Section 3.4, page 20
External relays connected to relays in instrument fail to de-energize	Arc suppression capacitors are provided across the relay contacts and capacitor leakage current may be sufficient to prevent an external relay from de-energizing	Remove the arc suppression components: <ul style="list-style-type: none"> ■ R13 and R14 on mainboard ■ R1 and R7 on standard I/O and analog relay module ■ IC3 to IC10 on 4 relay module

Table 6.1 Fault Diagnosis

7 Spares and Accessories

Item	Part No.
Pen Capsules (pack of 3)	
Black	C1900/0119
Blue	C1900/0120
Red	C1900/0121
Green	C1900/0122
Violet*	C1900/0123
Pen Arm Assemblies	
ER/C Type Chart (J or R in Code Number) – Standard Pen	C1900/0076
ER/C Type Chart (J or R in Code Number) – Event Pen	C1900/0078
PX105 and PXR105 Type Chart (K or S in Code Number) – Standard Pen	C1900/0075
PX105 and PXR105 Type Chart (K or S in Code Number) – Event Pen	C1900/0077
Fuses	
100 to 240V	B11069 (500mA)

*True time line event option only.

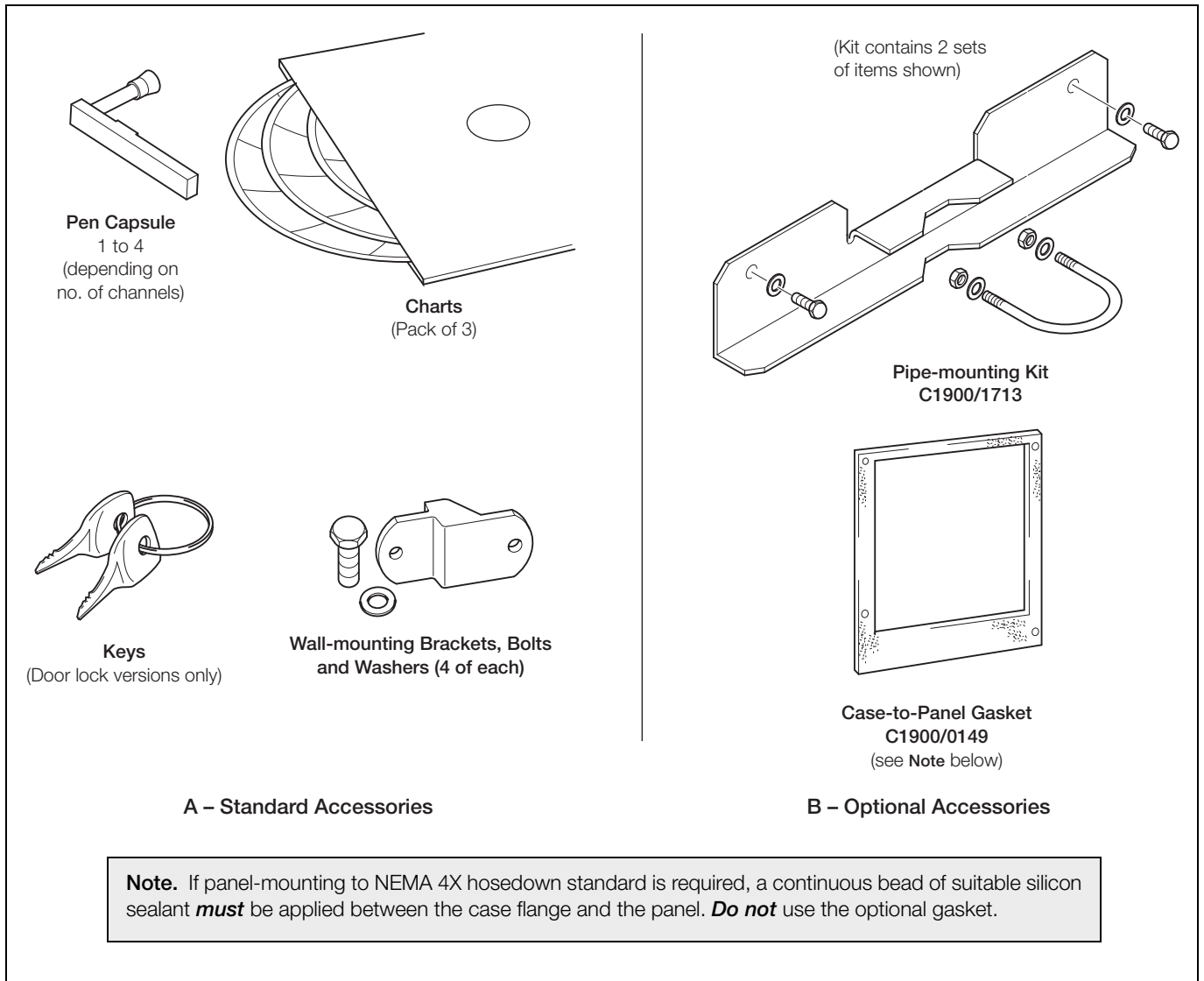

Fig. 7.1 Accessories

8 Specification

Construction

Size	15.23 in. (h) x 15.04 in. (w) x 5.57 in. (d) (386.8 x 382.0 x 135mm)
Weight	18lb (8.2kg)
Case material	Glassfiber-filled reinforced polyester
Window material	Polycarbonate or glass
Door latch	High-compression with optional lock

Environmental

Operational temperature range	0° to 55°C (32° to 130°F)
Operational humidity range	5 to 95%RH (non-condensing) 5 to 80%RH (chart only)
Case sealing	NEMA 3 (IP54) NEMA 4X (IP66) (optional)

Installation

Mounting options	Panel, wall or pipe
Terminal type	Screw
Wire size (max)	14 AWG (I/O), 12 AWG (power)

Operation and Configuration

Programming method	Via front panel keys
Security	Password-protected menus

Safety

General safety	EN61010
Installation category	II
Pollution degree	2
Dielectric	500V DC (channel/channel) 2kV DC (channel/ground)
Memory protection	Nonvolatile FRAM
Approvals	CE CSA General Safety (option) UL General Safety (option)

Power Supply

Voltage	100 to 240V AC \pm 10% (90V min. to 264V AC max.), 50/60Hz
Consumption	<30 VA (typical for full spec. unit)
Line interruption	Up to 60ms

Process Inputs and Outputs

General

Noise Rejection	Common mode >120dB at 50/60Hz Normal (series) mode >60dB at 50/60Hz
CJC rejection ratio	<0.05°C/°C (0.1°F/°F)
Sensor break protection	Upscale or downscale drive
Out of range detection	0 to 100% of engineering span
Temperature stability	<0.02% of reading/°C (0.04% of reading/°F) or 1 μ V/°C
Long-term drift	<0.01% of reading or 10 μ V annually
Input impedance	>10MW (mV and V inputs) 39W (mA input)

Analog Inputs

Signal types	mV, V, mA, W
Thermocouple types	B, E, J, K, N, R, S, T
Resistance thermometer	Pt 100
Other linearizations	$x^{1/2}$, $x^{3/2}$, $x^{5/2}$, linear
Sample interval	250ms per channel
Dielectric	500V DC channel/channel
Digital filter	0 to 60s (programmable)
Engineering range	-999 to 9999

Type	Range Low	Range High	Minimum Span	Accuracy
mV	0	150	5	\pm 0.1% reading or 10 μ V
V	0	5	0.1	\pm 0.1% reading or 20mV
mA	0	50	1	\pm 0.2% reading or 0.2 μ A
Ohms (low)	0	750	20	\pm 0.2% reading or 0.1W
Ohms (high)	0	10k	400	\pm 0.5% reading or 10 Ω

Table 8.1 Analog Input Performance

Type	°C		°F		Accuracy (excluding CJC)
	Range Low	Range High	Range Low	Range High	
B	-18	1800	0	3270	±2.0°C (above 200°C) (3.6°F [above 434°F])
E	-100	900	-140	1650	±0.5°C (0.9°F)
J	-100	900	-140	1650	±0.5°C (0.9°F)
K	-100	1300	-140	2350	±0.5°C (0.9°F)
N	-200	1300	-325	2350	±0.5°C (0.9°F)
R	-18	1700	0	3000	±1.0°C (above 300°) (1.8°F [above 572°F])
S	-18	1700	0	3000	±1.0°C (above 200°C) (1.8°F [above 434°F])
T	-250	300	-400	550	±0.5°C (0.9°F)
PT100	-200	600	-325	1100	±0.5°C (0.9°F)

Table 8.2 Thermocouple Performance

2-Wire Transmitter Power Supplies

Number	1 per channel
Voltage	24V DC nominal
Drive	Up to 25mA
Isolation	500V DC channel-to-channel

Analog Outputs

Type	4 to 20mA
Accuracy	±0.1%
Maximum load	750W
Dielectric	500V DC

Relay Outputs

Type	SPDT
Rating (with non-inductive load)	5A at 115/230V AC

Digital Inputs

Type	TTL or volt-free
Minimum pulse	250ms
Dielectric	500V DC between modules, no isolation within module

Digital Outputs

Type	5V TTL
Rating	5mA per output
Dielectric	500V DC between modules, no isolation within module

Serial Communications

Connections	RS485, 4-wire
Protocol	Modbus RTU

Recording System

Pens

Number	1, 2, 3, or 4 (red, green, blue, black)
Response	7 seconds (full scale)
Resolution	0.1% steps
Pen lift	Motor-driven, with optional autodrop

Event Pens

Standard	3-position event recording on any channel
Real time	3-position event recording on the same time line as Pen 1

Chart

Chart size	10 in. or 105mm
Chart speed	1 to 167 hours or 7 to 32 days per revolution
Rotation accuracy	<0.5% of rotation time

Graphical Display Panels

Displays

Number	1 (1 or 2 pens) or 2 (3 or 4 pens)
Type	High contrast 128 x 64 STN dot matrix LCD (graphics) module
Status indicators	Indicate channel number on display
Alarm indicators	Indicate channel with active alarms

Panel keys

Function	Programming access, increment/decrement, pen lift and menu key
----------	--

Alarms and Logic

Alarms

Number	4 per channel
Type	High/low process, fast/slow rate of change, time delay
Adjustments	Hysteresis, time delay
Alarm indicators	Indicate channel with active alarms

Logic Equations

Number	4
Function	OR, AND
Inputs	Alarm states, digital inputs, totalizers, logic
Outputs	Relays, digital outputs, chart stop, alarm acknowledge

Advanced Software Functions

Totalizers

Number	Up to 4
Size	999,999,999 max.
Output	External counter driver, 'wrap' pulse signal
Totalizer log	Max. 21 entries per totalizer

Math

Number of equations	4
Type	+, -, x, ÷, low & high select, maximum, minimum, average, mass flow, RH

Timers

Number	2
Type	Real-time clock driven event, adjustable duration
Output	Relay, digital output, logic equation

EMC

Emissions and Immunity

Meets requirements of:

- EN50081-2
- EN50082-2
- EN61326 for an industrial environment
- CE Mark

Module Type	I/O Per Module							Max. No. Per Instrument
	Analog I/P	Analog O/P	Trans. PSU	Relays	Digital I/P	Digital O/P	Comms.	
Standard I/O	1	1	1	1	2			4
4 relays				4				2
8 digital I/P					8			3
8 digital O/P						8		3
RS485 comms.							1	1

Table 8.3 Option Module Types

Appendix A – Signal Sources

Source	Description
None	No source required
Pen 1 to Pen 4	Process variable assigned to Pen 1 Process variable assigned to Pen 2 Process variable assigned to Pen 3 Process variable assigned to Pen 4
Math Block 1 to Math Block 4	Result of Math Block 1 Result of Math Block 2 Result of Math Block 3 Result of Math Block 4 } Available only if Math software option enabled by installation of appropriate software key
Constant 1 to Constant 8	} Available only if Math software option enabled by installation of appropriate software key
Input 1 to Input 6	} Analog inputs 1 to 6
Alarm A1 to Alarm D1	Alarm A Alarm B Alarm C Alarm D } Channel 1 Alarms (if applicable)
Alarm A2 to Alarm D2	Alarm A Alarm B Alarm C Alarm D } Channel 2 Alarms (if applicable)
Alarm A3 to Alarm D3	Alarm A Alarm B Alarm C Alarm D } Channel 3 Alarms (if applicable)
Alarm A4 to Alarm D4	Alarm A Alarm B Alarm C Alarm D } Channel 4 Alarms (if applicable)
Dig Input Main 1 to Dig Input Mod6 8	Digital input module 1 input 1 Digital input module 6 input 8 Available only if digital input module fitted
Tot 1 Count Tot 1 Wrap to Tot 4 Count Tot 4 Wrap	Totalizer 1 external counter drive Wrap around on totalizer 1 Totalizer 4 external counter drive Wrap around on totalizer 4 } Available only if Totalizer software option enabled by installation of appropriate software key
Equation 1 to Equation 8	Programmable logic equation 1 Programmable logic equation 8
Timer 1 to Timer 2	Real time event 1 Real time event 2 } Available only if Timers software option enabled by installation of appropriate software key

Table A.1 Signal Sources

Appendix B – Units

Number	Unit	Description
1	deg C	Degrees Celsius
2	deg F	Degrees Fahrenheit
3	Kelvin	Degrees Kelvin
4	%RH	% Relative Humidity
5	%	%
6	ppm	parts per million
7	ppb	parts per billion
8	pH	potential Hydrogen
9	l/d	liters per day
10	l/h	liters per hour
11	l/m	liters per minute
12	l/s	liters per second
13	Ml/d	megaliters per day
14	Ml/h	megaliters per hour
15	Ml/m	megaliters per minute
16	Ml/s	megaliters per second
17	gal/d (Imp)	imperial gallons per day
18	gal/h (Imp)	imperial gallons per hour
19	gal/m (Imp)	imperial gallons per minute
20	gal/s (Imp)	imperial gallons per second
21	Mgal/d (Imp)	imperial mega gallons per day
22	gal/d (US)	US gallons per day
23	gal/h (US)	US gallons per hour
24	gal/m (US)	US gallons per minute
25	gal/s (US)	US gallons per second
26	Mgal/d (US)	US mega gallons
27	m ³ /d	cubic meters per day
28	m ³ /h	cubic meters per hour
29	m ³ /m	cubic meters per minute
30	m ³ /s	cubic meters per second
31	ft ³ /d	cubic feet per day
32	ft ³ /h	cubic feet per hour
33	ft ³ /m	cubic feet per minute
34	ft ³ /s	cubic feet per second
35	SCFM	standard cubic feet per minute
36	kg/d	kilograms per day
37	kg/h	kilograms per hour
38	kg/m	kilograms per minute
39	kg/s	kilograms per second
40	T/d	metric tonnes per day
41	T/h	metric tonnes per hour
42	T/m	metric tonnes per minute

Table B.1 Units

Number	Unit	Description
43	T/s	metric tonnes per second
44	lb/d	pounds per day
45	lb/h	pounds per hour
46	lb/m	pounds per minute
47	lb/s	pounds per second
48	ton/d	imperial tons per day
49	ton/h	imperial tons per hour
50	ton/m	imperial tons per minute
51	ton/s	imperial tons per second
52	ug/kg	micrograms per kilogram
53	mg/kg	milligrams per kilogram
54	l	liters
55	ml	milliliters
56	kl	kiloliters
57	Ml	megaliters
58	m	meters
59	gal	imperial gallons
60	g x 10	imperial gallons x 10
61	g x100	imperial gallons x 100
62	kgal	imperial kilo gallons
63	Mgal	imperial mega gallons
64	gal	us gallons
65	g x 10	us gallons x 10
66	g x100	us gallons x 100
67	kgal	us kilo gallons
68	Mgal	us mega gallons
69	m ³	cubic meters
70	km ³	kilo cubic meters
71	Mm ³	mega cubic meters
72	CUMEC	cubic meter of water per second
73	kg	kilograms
74	T	tons
75	kT	kilotons
76	lb	pounds
77	ton	imperial tons
78	mbar	millibar
79	bar	bar
80	m WG	meters water gauge
81	Hz	hertz
82	kHz	kilohertz
83	% sat	% saturation
84	%O ₂	% oxygen

Table B.1 Units (Continued)

Number	Unit	Description
85	%N2	% nitrogen
86	%HCI	% hydrochloric acid
87	NTU	nephelometric turbidity units
88	FTU	formazine turbidity units
89	%OBS	% obscuration
90	btu	british thermal units
91	ft3	cubic feet
92	kft3	kilo cubic feet
93	Mft3	mega cubic feet
94	g/l	grams per liter
95	g/h	grams per hour
96	g/d	grams per day
97	mL/m	milliliters per minute
98	mL/h	milliliters per hour
99	%dO2	% dissolved oxygen
100	uV	microvolts
101	mV	millivolts
102	MV	megavolts
103	A	amps
104	mho	conductance
105	S	Siemens
106	uS/cm	microSiemens per centimeter
107	mS/cm	milliSiemens per centimeter
108	uS/m	microSiemens per meter
109	mS/m	milliSiemens per meter
110	Feet	imperial feet
111	AcreFt	volume of water, 1ft deep, covering an area of 1 acre
112	Inches	imperial inches
113	Custom	user defined units

Table B.1 Units (Continued)

Appendix C – Installation Record

Position 3 **Module Type (Tick Box)** 1 2

1	+	
2	-	
3		
4		
5		
6		
7	C	
8	L1	
9	L2	
10	NO	
1	C	
12	NC	

* Not applicable on Module Type 2

Position 2 **Module Type (Tick Box)** 1 2

1	+	
2	-	
3		
4		
5		
6		
7	C	
8	L1	
9	L2	
10	NO	
1	C	
12	NC	

* Not applicable on Module Type 2

Position 1 **Module Type** 1

1	+	
2	-	
3		
4		
5		
6		
7	C	
8	L1	
9	L2	
10	NO	
1	C	
12	NC	

Position 4 **Module Type (Tick Box)** 1 2 3 4 5

1	C	
2	1	
3	2	
4	3	
5	4	
6	5	
7	6	
8	7	
9	8	
10	C	

Logic I/Ps (Type 4) or Logic O/Ps (Type 5)

1	NC
2	NO
3	C
4	NC
5	NO
6	C
7	NC
8	NO
9	C
10	NC
1	NO
12	C

Link Positions (Tick Box) Type 4 Type 5

Position 3

1	NC
2	NO
3	C
4	NC
5	NO
6	C
7	NC
8	NO
9	C
10	NC
1	NO
12	C

Position 4 **Module Type (Tick Box)** 1 2 3 4 5 6 7

1	+	
2	-	
3		
4		
5		
6		
7	C	
8	L1	
9	L2	
10	NO	
1	C	
12	NC	

* Not available on Module Type 2

Position 5

Module Type (Tick Box) 2

1	+	
2	-	
3		<p>Link Positions (Tick Boxes)</p>
4		
5		
6		
7	C	
8	L1	
9	L2	
10	NO	
1	C	
12	NC	

3

1	NC	
2	NO	
3	C	
4	NC	
5	NO	
6	C	
7	NC	
8	NO	
9	C	
10	NC	
1	NO	
12	C	

4 5

1	C	
2	1	
3	2	
4	3	
5	4	
6	5	
7	6	
8	7	
9	8	
10	C	

Logic I/Ps (Type 4) or Logic O/Ps (Type 5)

Link Positions (Tick Box) Type 4 Type 5

* Not available on Module Type 2

Position 6

Module Type (Tick Box) 2

1	+	
2	-	
3		<p>Link Positions (Tick Boxes)</p>
4		
5		
6		
7	C	
8	L1	
9	L2	
10	NO	
1	C	
12	NC	

4 5

1	C	
2	1	
3	2	
4	3	
5	4	
6	5	
7	6	
8	7	
9	8	
10	C	

Logic I/Ps (Type 4) or Logic O/Ps (Type 5)

Link Positions (Tick Box) Type 4 Type 5

* Not available on Module Type 2

Index

- A**
- AC Connections71
 - Accessories73
 - Adjusting and Storing a Parameter Value6
 - Alarms
 - Configuration31
 - Fast Rate32, 33, 34
 - High and Low Process31, 33, 34
 - Icons7
 - Set Point Adjustment18
 - Enable22
 - Slow Rate32, 33, 34
 - Time Hysteresis31, 34
 - Trip Level34
 - Type33
 - Analog Output
 - Configuration45
 - Electrical Range High46
 - Electrical Range Low46
 - Range High46
 - Range Low46
 - Source45
 - Auto Pen Drop20, 72
 - Autoscroll9
- B**
- Broken Sensor Protection Drive29
- C**
- Calibration
 - Offset56
 - Pen High Value57
 - Pen Low Value57
 - Span56
 - Channel (Pen)
 - Tag26
 - Units27, 78
 - Channel Connections66
 - Chart
 - Duration20
 - Fitting – See Fitting a Chart
 - Range High28
 - Range Low28
 - Stop Source20
 - Configuration
 - Analog Output 45 to 46
 - Backing Up58
 - Channels 24 to 30
 - Common 20 to 23
 - Digital I/O 43 to 44
 - Logic Equation 47 to 49
 - Other Channels Display22
 - Password (Security Code)20
 - Relay42
 - Restoring59
 - System Clock54
- D**
- Data Logging 8, 15
 - Configuration 50 to 53
 - Data Verification and Integrity 50
 - File Names 50
 - File Types 50
 - Filter Type 52
 - Instrument Tag 52
 - New File Creation 52
 - Sample Rate 52
 - Status 15
 - Date and Time – See Configuration: System Clock
 - Decimal Point 27
 - Digital Input and Output
 - Configuration 43 to 44
 - Input Polarity 44
 - Output Polarity 44
 - Output Source 44
 - Dimensions 61
 - Display Screen 6
 - Brightness 23
 - Contrast 23
- E**
- Electrical Input Range
 - High 27
 - Low 27
 - Engineering Range 29, 34, 35, 46
 - High 28
 - Low 28
 - Enter/Edit User-Defined Information 6
 - Environmental Requirements 60
- F**
- Fault Detection Level Percentage 29
 - Fault Diagnosis 72
 - Fitting a Chart 3
 - Fitting the Pen Capsule(s) 2
- H**
- Hysteresis 31, 32, 34
- I**
- Input (Pen) Channel
 - Display
 - Configure 21
 - Dual 11
 - Separate 10
 - Separate and Dual 12
 - Input Error Messages 7
 - Input Type 26
 - Selecting 67
 - Input/Output Modules
 - Identification 66
 - Installation Record 80

L

Line Rejection	21
Linearizer Type	26
Logic Equation Configuration – See Configuration: Logic Equation	

M

Making a Selection	6
Module Positions and Functions	66
Mounting	61

O

Operator Keys	6
Overall Dimensions – See Dimensions	

P

Panel Mounting	63
Pen	
Auto Drop – See Auto Pen Drop	
Capsule Fitting – See Fitting the Pen Capsule(s)	
Filter	29
Function	55
In Source	30
In Tag	30
Lift Enable	20
Out Source	30
Out Tag	30
Select	55
Source	55
Pipe Mounting	62
Power Supply Selection	71

R

Raise/Lower Pens	6
Relay	
Configuration – See Configuration; Relay	
Polarity	42
Select	42
Source	42

S

Security Code	19
Configuration – See Configuration: Password (Security Code)	
Signal Sources	77
Siting	60
Software Key	5, 16, 17, 22, 35, 47, 50, 54, 64
Start-up Error Messages	5
System Clock Configuration – See Configuration: System Clock	

T

Terminal Block	
Removing	65
Thermocouple Compensating Cable	68
Time Hysteresis	31, 34
Totalizer	
Log	
Enable Source	41
Predetermined Value	39
Preset Value	39
Reset	
Day	40
Source	40
Time	40
Run Source	41
Secure Total Reset	41
Wrap	40
Totalizers	
Configuration	35 to 41
Control	17
Reset	17
Count Direction	38
Count Rate	35
Calculating Manually	36
Cut Off	39
Display	
Configure	22
Dual + Flow Rate	15
Dual Total	14
Rate with Total	13
Separate	13
Total with Rate	14
Log	16
Tag	38
Units	38, 78

U

Units	78
See also Channel (Pen) Units; Totalizers: Units	

W

Wall Mounting	62
---------------------	----

Acknowledgments

Modbus™ is a registered trademark of the Modbus-IDA organization

Microsoft is a registered trademark of Microsoft Corporation in the United States and/or other countries

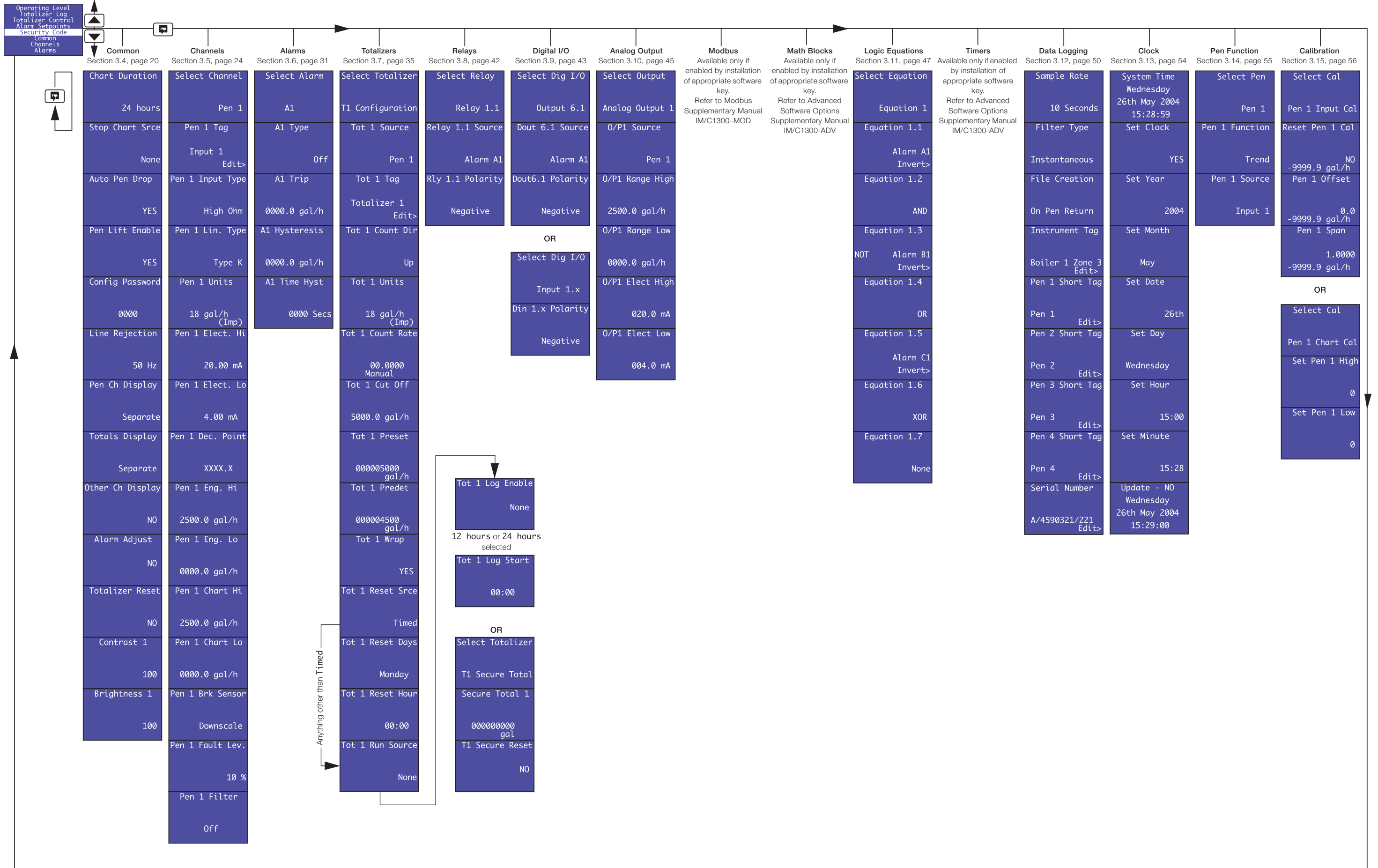

Sales



Service



Software



ABB Limited
Measurement & Analytics
Howard Road, St. Neots
Cambridgeshire, PE19 8EU
UK
Tel: +44 (0) 870 600 6122
Fax: +44 (0)1480 217948
Email: enquiries.mp.uk@gb.abb.com

ABB Inc.
Measurement & Analytics
125 E County Line Road
Warminster, PA 18974
USA
Tel: +1 215 6746000
Fax: +1 215 6747183

abb.com/measurement

We reserve the right to make technical changes or modify the contents of this document without prior notice. With regard to purchase orders, the agreed particulars shall prevail. ABB does not accept any responsibility whatsoever for potential errors or possible lack of information in this document.

We reserve all rights in this document and in the subject matter and illustrations contained therein. Any reproduction, disclosure to third parties or utilization of its contents – in whole or in parts – is forbidden without prior written consent of ABB.

© ABB 2018