

Technical Information

Proline Promass A 200

Coriolis flowmeter



Flowmeter with genuine two-wire technology for accurate measurement of smallest flow quantities

Application

- Measuring principle operates independently of physical fluid properties such as viscosity or density
- Suitable for applications with the smallest flow quantities in the chemical industry

Device properties

- Nominal diameter: DN 1 to 4 ($\frac{1}{24}$ to $\frac{1}{8}$ ")
- Process pressure: up to 430.9 bar (6 250 psi)
- Medium temperature up to +205 °C (+401 °F)
- Loop-powered technology
- Robust dual-compartment housing
- Plant safety: worldwide approvals (SIL, Haz. area)

Your benefits

- Space-saving installation – compact, lightweight sensor
- Highest product quality – self-drainable measuring tube design available in all line sizes
- Optimum process safety – resistant to corrosive ambient conditions and internal clogging
- Convenient device wiring – separate connection compartment
- Safe operation – no need to open the device due to display with touch control, background lighting
- Integrated verification – Heartbeat Technology

Table of contents





About this document	4	Climate class	36
Symbols used	4	Degree of protection	37
Function and system design	5	Vibration resistance	37
Measuring principle	5	Shock resistance	37
Measuring system	7	Shock resistance	37
Safety	7	Interior cleaning	37
		Electromagnetic compatibility (EMC)	37
Input	9	Process	37
Measured variable	9	Medium temperature range	37
Measuring range	9	Density	37
Operable flow range	10	Pressure-temperature ratings	37
Input signal	10	Sensor housing	41
		Rupture disk	42
Output	10	Flow limit	42
Output signal	10	Pressure loss	42
Signal on alarm	12	System pressure	42
Load	13	Thermal insulation	42
Ex connection data	14	Heating	43
Low flow cut off	17	Vibrations	43
Galvanic isolation	18	Mechanical construction	44
Protocol-specific data	18	Dimensions in SI units	44
		Dimensions in US units	54
Power supply	19	Weight	61
Terminal assignment	19	Materials	61
Pin assignment, device plug	20	Process connections	64
Supply voltage	20	Surface roughness	64
Power consumption	21	Operability	64
Current consumption	21	Operating concept	64
Power supply failure	21	Languages	65
Electrical connection	22	Local operation	65
Electrical connection	25	Remote operation	66
Potential equalization	28	Service interface	68
Terminals	28	Certificates and approvals	68
Cable entries	28	CE mark	69
Cable specification	28	C-Tick symbol	69
Overvoltage protection	28	Functional safety	69
		Ex approval	69
Performance characteristics	29	Sanitary compatibility	70
Reference operating conditions	29	Pharmaceutical compatibility	70
Maximum measured error	29	Functional safety	70
Repeatability	30	HART certification	70
Response time	31	FOUNDATION Fieldbus certification	70
Influence of ambient temperature	31	Certification PROFIBUS	70
Influence of medium temperature	31	Additional certification	70
Influence of medium pressure	32	Other standards and guidelines	71
Design fundamentals	32	Ordering information	72
		Application packages	72
Installation	33	Diagnostics functions	72
Mounting location	33	Heartbeat Technology	72
Orientation	34	Special density	72
Inlet and outlet runs	34		
Special mounting instructions	34		
Environment	36		
Ambient temperature range	36		
Storage temperature	36		

Accessories	73
Device-specific accessories	73
Communication-specific accessories	74
Service-specific accessories	75
System components	75
Documentation	76
Standard documentation	76
Supplementary device-dependent documentation	76
Registered trademarks	77

About this document

Symbols used









Electrical symbols

Symbol	Meaning
	Direct current
	Alternating current
	Direct current and alternating current
	Ground connection A grounded terminal which, as far as the operator is concerned, is grounded via a grounding system.
	Protective Earth (PE) A terminal which must be connected to ground prior to establishing any other connections. The ground terminals are situated inside and outside the device: <ul style="list-style-type: none"> ▪ Inner ground terminal: Connects the protective earth to the mains supply. ▪ Outer ground terminal: Connects the device to the plant grounding system.

Communication symbols



Symbol	Meaning
	Wireless Local Area Network (WLAN) Communication via a wireless, local network.

Symbols for certain types of information

Symbol	Meaning
	Permitted Procedures, processes or actions that are permitted.
	Preferred Procedures, processes or actions that are preferred.
	Forbidden Procedures, processes or actions that are forbidden.
	Tip Indicates additional information.
	Reference to documentation.
	Reference to page.
	Reference to graphic.
	Visual inspection.

Symbols in graphics

Symbol	Meaning
1, 2, 3, ...	Item numbers
1 , 2 , 3 , ...	Series of steps
A, B, C, ...	Views
A-A, B-B, C-C, ...	Sections

Symbol	Meaning
	Hazardous area
	Safe area (non-hazardous area)
	Flow direction

Function and system design

Measuring principle

The measuring principle is based on the controlled generation of Coriolis forces. These forces are always present in a system when both translational and rotational movements are superimposed.

$$F_c = 2 \cdot \Delta m (v \cdot \omega)$$

F_c = Coriolis force

Δm = moving mass

ω = rotational velocity

v = radial velocity in rotating or oscillating system

The amplitude of the Coriolis force depends on the moving mass Δm , its velocity v in the system and thus on the mass flow. Instead of a constant rotational velocity ω , the sensor uses oscillation.

In the sensor, an oscillation is produced in the measuring tube. The Coriolis forces produced at the measuring tube cause a phase shift in the tube oscillations (see illustration):

- If there is zero flow (i.e. when the fluid stands still), the oscillation measured at points A and B has the same phase (no phase difference) (1).
- Mass flow causes deceleration of the oscillation at the inlet of the tubes (2) and acceleration at the outlet (3).

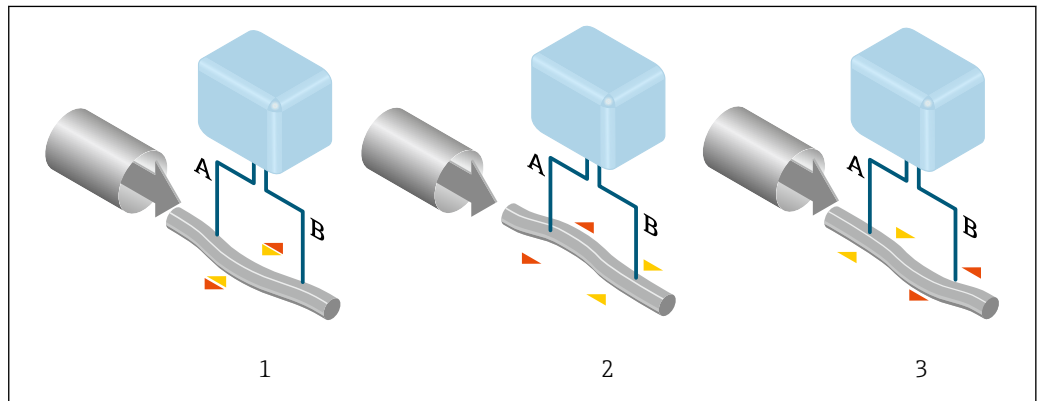

A0029932

The phase difference (A-B) increases with increasing mass flow. Electrodynamic sensors register the tube oscillations at the inlet and outlet. The measuring principle operates independently of temperature, pressure, viscosity, conductivity and flow profile.

Density measurement

The measuring tube is continuously excited at its resonance frequency. A change in the mass and thus the density of the oscillating system (comprising measuring tube and fluid) results in a corresponding, automatic adjustment in the oscillation frequency. Resonance frequency is thus a function of medium density. The microprocessor utilizes this relationship to obtain a density signal.

Volume measurement

Together with the measured mass flow, this is used to calculate the volume flow.

Temperature measurement

The temperature of the measuring tube is determined in order to calculate the compensation factor due to temperature effects. This signal corresponds to the process temperature and is also available as an output signal.

Measuring system

The device consists of a transmitter and a sensor.
 The device is available as a compact version:
 The transmitter and sensor form a mechanical unit.

Transmitter

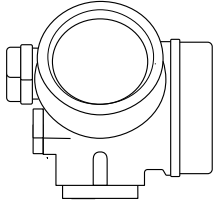
<p>Promass 200</p>  <p style="text-align: right; font-size: small;">A0013471</p>	<p>Device versions and materials:</p> <ul style="list-style-type: none"> ■ Compact, aluminum coated: Aluminum, AlSi10Mg, coated ■ Compact or remote version, stainless: For maximum corrosion resistance: stainless steel CF3M <p>Configuration:</p> <ul style="list-style-type: none"> ■ External operation via four-line, illuminated local display with touch control and guided menus ("Make-it-run" wizards) for applications ■ Via operating tools (e.g. FieldCare)
--	---

Sensor

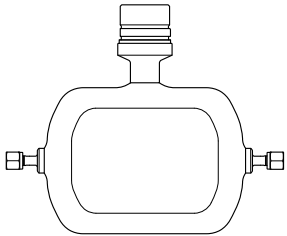
<p>Promass A</p>  <p style="text-align: right; font-size: small;">A0036494</p>	<ul style="list-style-type: none"> ■ Single-tube system for high-precision measurement of minimum flow rates ■ Simultaneous measurement of flow, volume flow, density and temperature (multivariable) ■ Immune to process influences ■ Nominal diameter range: DN 1 to 4 (1/24 to 1/8 ") ■ Materials: <ul style="list-style-type: none"> - Sensor: stainless steel, 1.4404 (316/316L) - Measuring tube: stainless steel, 1.4435 (316/316L); Alloy C22, 2.4602 (UNS N06022) - Process connections: stainless steel, 1.4404 (316/316L); 1.4435 (316L); Alloy C22, 2.4602 (UNS N06022)
---	--

Safety

IT security

Our warranty is valid only if the device is installed and used as described in the Operating Instructions. The device is equipped with security mechanisms to protect it against any inadvertent changes to the settings.

IT security measures, which provide additional protection for the device and associated data transfer, must be implemented by the operators themselves in line with their security standards.

Device-specific IT security

The device offers a range of specific functions to support protective measures on the operator's side. These functions can be configured by the user and guarantee greater in-operation safety if used correctly. An overview of the most important functions is provided in the following section.

Protecting access via hardware write protection

Write access to the device parameters via the local display or operating tool (e.g. FieldCare, DeviceCare) can be disabled via a write protection switch (DIP switch on the motherboard). When hardware write protection is enabled, only read access to the parameters is possible.

Hardware write protection is disabled when the device is delivered.

Protecting access via a password

A password can be used to protect against write access to the device parameters.

This password locks write access to the device parameters via the local display or another operating tool (e.g. FieldCare, DeviceCare) and, in terms of functionality, is equivalent to hardware write protection. If the service interface CDI RJ-45 is used, read access is only possible if the password is entered.

User-specific access code

Write access to the device parameters via the local display or operating tool (e.g. FieldCare, DeviceCare) can be protected by the modifiable, user-specific access code.

Access via fieldbus

Cyclic fieldbus communication (read and write, e.g. measured value transmission) with a higher-order system is not affected by the restrictions mentioned above.

Input

Measured variable

Direct measured variables

- Mass flow
- Density
- Temperature

Calculated measured variables

- Volume flow
- Corrected volume flow
- Reference density

Measuring range

Measuring ranges for liquids

DN		Measuring range full scale values $\dot{m}_{\min(F)}$ to $\dot{m}_{\max(F)}$	
[mm]	[in]	[kg/h]	[lb/min]
1	1/24	0 to 20	0 to 0.735
2	1/12	0 to 100	0 to 3.675
4	1/8	0 to 450	0 to 16.54



Measuring range for gases

The full scale value depends on the density and the sound velocity of the gas used and can be calculated with the formula below:

$$\dot{m}_{\max(G)} = \text{minimum} (\dot{m}_{\max(F)} \cdot \rho_G : x ; \rho_G \cdot c_G \cdot \pi/2 \cdot (d_i)^2 \cdot 3600)$$

$\dot{m}_{\max(G)}$	Maximum full scale value for gas [kg/h]
$\dot{m}_{\max(F)}$	Maximum full scale value for liquid [kg/h]
$\dot{m}_{\max(G)} < \dot{m}_{\max(F)}$	$\dot{m}_{\max(G)}$ can never be greater than $\dot{m}_{\max(F)}$
ρ_G	Gas density in [kg/m ³] at operating conditions
x	Constant dependent on nominal diameter
c_G	Sound velocity (gas) [m/s]
d_i	Measuring tube internal diameter [m]

DN		x
[mm]	[in]	[kg/m ³]
1	1/24	32
2	1/12	32
4	1/8	32

 To calculate the measuring range, use the *Applicator* sizing tool →  75

Calculation example for gas

- Sensor: Promass A, DN 2
- Gas: Air with a density of 11.9 kg/m³ (at 20 °C and 10 bar)
- Measuring range (liquid): 100 kg/h
- $x = 32 \text{ kg/m}^3$ (for Promass A DN 2)

Maximum possible full scale value:

$$\dot{m}_{\max(G)} = \dot{m}_{\max(F)} \cdot \rho_G : x = 100 \text{ kg/h} \cdot 11.9 \text{ kg/m}^3 : 32 \text{ kg/m}^3 = 37.2 \text{ kg/h}$$

Recommended measuring range

"Flow limit" section →  42

Operable flow range

Over 1000 : 1.

Flow rates above the preset full scale value do not override the electronics unit, with the result that the totalizer values are registered correctly.

Input signal**External measured values**

To increase the accuracy of certain measured variables or to calculate the corrected volume flow for gases, the automation system can continuously write the operating pressure to the measuring device. Endress+Hauser recommends the use of a pressure measuring device for absolute pressure, e.g. Cerabar M or Cerabar S.

 Various pressure transmitters and temperature measuring devices can be ordered from Endress +Hauser: see "Accessories" section →  75

It is recommended to read in external measured values to calculate the following measured variables:

- Mass flow
- Corrected volume flow

HART protocol

The measured values are written from the automation system to the measuring device via the HART protocol. The pressure transmitter must support the following protocol-specific functions:

- HART protocol
- Burst mode

Digital communication

The measured values can be written from the automation system to the measuring via:



- FOUNDATION Fieldbus
- PROFIBUS PA

Output

Output signal**Current output**

Current output 1	4-20 mA HART (passive)
Current output 2	4-20 mA (passive)
Resolution	< 1 µA
Damping	Adjustable: 0.0 to 999.9 s
Assignable measured variables	<ul style="list-style-type: none"> ▪ Mass flow ▪ Volume flow ▪ Corrected volume flow ▪ Density ▪ Reference density ▪ Temperature

Pulse/frequency/switch output

Function	Can be set to pulse, frequency or switch output
Version	Passive, open collector
Maximum input values	<ul style="list-style-type: none"> ▪ DC 35 V ▪ 50 mA  For information on the Ex connection values →  14

Voltage drop	<ul style="list-style-type: none"> ▪ For ≤ 2 mA: 2 V ▪ For 10 mA: 8 V
Residual current	≤ 0.05 mA
Pulse output	
Pulse width	Adjustable: 5 to 2 000 ms
Maximum pulse rate	100 Impulse/s
Pulse value	Adjustable
Assignable measured variables	<ul style="list-style-type: none"> ▪ Mass flow ▪ Volume flow ▪ Corrected volume flow
Frequency output	
Output frequency	Adjustable: 0 to 1 000 Hz
Damping	Adjustable: 0 to 999 s
Pulse/pause ratio	1:1
Assignable measured variables	<ul style="list-style-type: none"> ▪ Mass flow ▪ Volume flow ▪ Corrected volume flow ▪ Density ▪ Reference density ▪ Temperature
Switch output	
Switching behavior	Binary, conductive or non-conductive
Switching delay	Adjustable: 0 to 100 s
Number of switching cycles	Unlimited
Assignable functions	<ul style="list-style-type: none"> ▪ Off ▪ On ▪ Diagnostic behavior ▪ Limit value <ul style="list-style-type: none"> - Mass flow - Volume flow - Corrected volume flow - Density - Reference density - Temperature - Totalizer 1-3 ▪ Flow direction monitoring ▪ Status <ul style="list-style-type: none"> - Partially filled pipe detection - Low flow cut off

FOUNDATION Fieldbus

FOUNDATION Fieldbus	H1, IEC 61158-2, galvanically isolated
Data transfer	31.25 kbit/s
Current consumption	18 mA
Permitted supply voltage	9 to 32 V
Bus connection	With integrated reverse polarity protection

PROFIBUS PA

PROFIBUS PA	In accordance with EN 50170 Volume 2, IEC 61158-2 (MBP), galvanically isolated
Data transmission	31.25 kbit/s

Current consumption	16 mA
Permitted supply voltage	9 to 32 V
Bus connection	With integrated reverse polarity protection

Signal on alarm

Depending on the interface, failure information is displayed as follows:

Current output 4 to 20 mA

4 to 20 mA

Failure mode	Choose from: <ul style="list-style-type: none"> ▪ 4 to 20 mA in accordance with NAMUR recommendation NE 43 ▪ 4 to 20 mA in accordance with US ▪ Min. value: 3.59 mA ▪ Max. value: 22.5 mA ▪ Freely definable value between: 3.59 to 22.5 mA ▪ Actual value ▪ Last valid value
---------------------	--

Pulse/frequency/switch output

Pulse output	
Failure mode	Choose from: <ul style="list-style-type: none"> ▪ Actual value ▪ No pulses
Frequency output	
Failure mode	Choose from: <ul style="list-style-type: none"> ▪ Actual value ▪ 0 Hz ▪ Defined value: 0 to 1250 Hz
Switch output	
Failure mode	Choose from: <ul style="list-style-type: none"> ▪ Current status ▪ Open ▪ Closed

FOUNDATION Fieldbus

Status and alarm messages	Diagnostics in accordance with FF-891
Failure current FDE (Fault Disconnection Electronic)	0 mA

PROFIBUS PA

Status and alarm messages	Diagnostics in accordance with PROFIBUS PA Profile 3.02
Failure current FDE (Fault Disconnection Electronic)	0 mA

Local display



Plain text display	With information on cause and remedial measures
Backlight	Additionally for device version with SD03 local display: red lighting indicates a device error.

 Status signal as per NAMUR recommendation NE 107

Interface/protocol

- Via digital communication:
 - HART protocol
 - FOUNDATION Fieldbus
 - PROFIBUS PA
- Via service interface
 - CDI service interface

Plain text display	With information on cause and remedial measures
---------------------------	---

 Additional information on remote operation →  66

Load

Load for current output: 0 to 500 Ω, depending on the external supply voltage of the power supply unit

Calculation of the maximum load

Depending on the supply voltage of the power supply unit (U_S), the maximum load (R_B) including line resistance must be observed to ensure adequate terminal voltage at the device. In doing so, observe the minimum terminal voltage

- For $U_S = 17.9$ to 18.9 V: $R_B \leq (U_S - 17.9$ V): 0.0036 A
- For $U_S = 18.9$ to 24 V: $R_B \leq (U_S - 13$ V): 0.022 A
- For $U_S = \geq 24$ V: $R_B \leq 500$ Ω

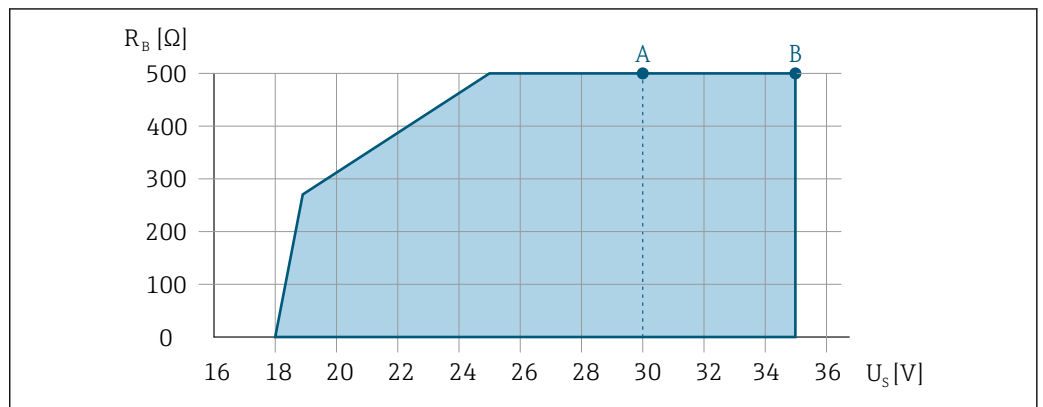

- A Operating range for order code for "Output", option A "4-20 mA HART"/option B "4-20 mA HART, pulse/frequency/switch output" with Ex i and option C "4-20 mA HART + 4-20 mA analog"
- B Operating range for order code for "Output", option A "4-20 mA HART"/option B "4-20 mA HART, pulse/frequency/switch output" with non-Ex and Ex d

Sample calculation

Supply voltage of power supply unit: $U_S = 19$ V
 Maximum load: $R_B \leq (19$ V - 13 V): 0.022 A = 273 Ω

Ex connection data

Safety-related values

Type of protection Ex d

Order code for "Output"	Output type	Safety-related values
Option A	4-20mA HART	$U_{nom} = DC 35 V$ $U_{max} = 250 V$
Option B	4-20mA HART	$U_{nom} = DC 35 V$ $U_{max} = 250 V$
	Pulse/frequency/switch output	$U_{nom} = DC 35 V$ $U_{max} = 250 V$ $P_{max} = 1 W^{1)}$
Option C	4-20mA HART	$U_{nom} = DC 30 V$ $U_{max} = 250 V$
	4-20mA analog	
Option E	FOUNDATION Fieldbus	$U_{nom} = DC 32 V$ $U_{max} = 250 V$ $P_{max} = 0.88 W$
	Pulse/frequency/switch output	$U_{nom} = DC 35 V$ $U_{max} = 250 V$ $P_{max} = 1 W^{1)}$
Option G	PROFIBUS PA	$U_{nom} = DC 32 V$ $U_{max} = 250 V$ $P_{max} = 0.88 W$
	Pulse/frequency/switch output	$U_{nom} = DC 35 V$ $U_{max} = 250 V$ $P_{max} = 1 W^{1)}$

1) Internal circuit limited by $R_i = 760.5 \Omega$

Type of protection Ex ec

Order code for "Output"	Output type	Safety-related values
Option A	4-20mA HART	$U_{nom} = DC 35 V$ $U_{max} = 250 V$
Option B	4-20mA HART	$U_{nom} = DC 35 V$ $U_{max} = 250 V$
	Pulse/frequency/switch output	$U_{nom} = DC 35 V$ $U_{max} = 250 V$ $P_{max} = 1 W^{1)}$
Option C	4-20mA HART	$U_{nom} = DC 30 V$ $U_{max} = 250 V$
	4-20mA analog	
Option E	FOUNDATION Fieldbus	$U_{nom} = DC 32 V$ $U_{max} = 250 V$ $P_{max} = 0.88 W$
	Pulse/frequency/switch output	$U_{nom} = DC 35 V$ $U_{max} = 250 V$ $P_{max} = 1 W^{1)}$
Option G	PROFIBUS PA	$U_{nom} = DC 32 V$ $U_{max} = 250 V$ $P_{max} = 0.88 W$
	Pulse/frequency/switch output	$U_{nom} = DC 35 V$ $U_{max} = 250 V$ $P_{max} = 1 W^{1)}$

1) Internal circuit limited by $R_i = 760.5 \Omega$

Type of protection *XP*

Order code for "Output"	Output type	Safety-related values
Option A	4-20mA HART	$U_{nom} = DC 35 V$ $U_{max} = 250 V$
Option B	4-20mA HART	$U_{nom} = DC 35 V$ $U_{max} = 250 V$
	Pulse/frequency/switch output	$U_{nom} = DC 35 V$ $U_{max} = 250 V$ $P_{max} = 1 W^{1)}$
Option C	4-20mA HART	$U_{nom} = DC 30 V$ $U_{max} = 250 V$
	4-20mA analog	
Option E	FOUNDATION Fieldbus	$U_{nom} = DC 32 V$ $U_{max} = 250 V$ $P_{max} = 0.88 W$
	Pulse/frequency/switch output	$U_{nom} = DC 35 V$ $U_{max} = 250 V$ $P_{max} = 1 W^{1)}$
Option G	PROFIBUS PA	$U_{nom} = DC 32 V$ $U_{max} = 250 V$ $P_{max} = 0.88 W$
	Pulse/frequency/switch output	$U_{nom} = DC 35 V$ $U_{max} = 250 V$ $P_{max} = 1 W^{1)}$

1) Internal circuit limited by $R_i = 760.5 \Omega$

Intrinsically safe values

Type of protection *Ex ia*

Order code for "Output"	Output type	Intrinsically safe values	
Option A	4-20mA HART	$U_i = DC 30 V$ $I_i = 300 mA$ $P_i = 1 W$ $L_i = 0 \mu H$ $C_i = 5 nF$	
Option B	4-20mA HART	$U_i = DC 30 V$ $I_i = 300 mA$ $P_i = 1 W$ $L_i = 0 \mu H$ $C_i = 5 nF$	
	Pulse/frequency/switch output	$U_i = DC 30 V$ $I_i = 300 mA$ $P_i = 1 W$ $L_i = 0 \mu H$ $C_i = 6 nF$	
Option C	4-20mA HART	$U_i = DC 30 V$ $I_i = 300 mA$ $P_i = 1 W$ $L_i = 0 \mu H$ $C_i = 30 nF$	
	4-20mA analog		
Option E	FOUNDATION Fieldbus	STANDARD $U_i = 30 V$ $I_i = 300 mA$ $P_i = 1.2 W$ $L_i = 10 \mu H$ $C_i = 5 nF$	FISCO $U_i = 17.5 V$ $I_i = 550 mA$ $P_i = 5.5 W$ $L_i = 10 \mu H$ $C_i = 5 nF$

Order code for "Output"	Output type	Intrinsically safe values	
	Pulse/frequency/switch output	$U_i = 30 \text{ V}$ $I_i = 300 \text{ mA}$ $P_i = 1 \text{ W}$ $L_i = 0 \text{ } \mu\text{H}$ $C_i = 6 \text{ nF}$	
Option G	PROFIBUS PA	STANDARD $U_i = 30 \text{ V}$ $I_i = 300 \text{ mA}$ $P_i = 1.2 \text{ W}$ $L_i = 10 \text{ } \mu\text{H}$ $C_i = 5 \text{ nF}$	FISCO $U_i = 17.5 \text{ V}$ $I_i = 550 \text{ mA}$ $P_i = 5.5 \text{ W}$ $L_i = 10 \text{ } \mu\text{H}$ $C_i = 5 \text{ nF}$
	Pulse/frequency/switch output	$U_i = 30 \text{ V}$ $I_i = 300 \text{ mA}$ $P_i = 1 \text{ W}$ $L_i = 0 \text{ } \mu\text{H}$ $C_i = 6 \text{ nF}$	

Type of protection Ex ic

Order code for "Output"	Output type	Intrinsically safe values	
Option A	4-20mA HART	$U_i = \text{DC } 35 \text{ V}$ $I_i = \text{n.a.}$ $P_i = 1 \text{ W}$ $L_i = 0 \text{ } \mu\text{H}$ $C_i = 5 \text{ nF}$	
Option B	4-20mA HART	$U_i = \text{DC } 35 \text{ V}$ $I_i = \text{n.a.}$ $P_i = 1 \text{ W}$ $L_i = 0 \text{ } \mu\text{H}$ $C_i = 5 \text{ nF}$	
	Pulse/frequency/switch output	$U_i = \text{DC } 35 \text{ V}$ $I_i = \text{n.a.}$ $P_i = 1 \text{ W}$ $L_i = 0 \text{ } \mu\text{H}$ $C_i = 6 \text{ nF}$	
Option C	4-20mA HART	$U_i = \text{DC } 30 \text{ V}$ $I_i = \text{n.a.}$ $P_i = 1 \text{ W}$ $L_i = 0 \text{ } \mu\text{H}$ $C_i = 30 \text{ nF}$	
	4-20mA analog		
Option E	FOUNDATION Fieldbus	STANDARD $U_i = 32 \text{ V}$ $I_i = 300 \text{ mA}$ $P_i = \text{n.a.}$ $L_i = 10 \text{ } \mu\text{H}$ $C_i = 5 \text{ nF}$	FISCO $U_i = 17.5 \text{ V}$ $I_i = \text{n.a.}$ $P_i = \text{n.a.}$ $L_i = 10 \text{ } \mu\text{H}$ $C_i = 5 \text{ nF}$
	Pulse/frequency/switch output	$U_i = 35 \text{ V}$ $I_i = 300 \text{ mA}$ $P_i = 1 \text{ W}$ $L_i = 0 \text{ } \mu\text{H}$ $C_i = 6 \text{ nF}$	

Order code for "Output"	Output type	Intrinsically safe values	
Option G	PROFIBUS PA	STANDARD U _i = 32 V I _i = 300 mA P _i = n.a. L _i = 10 µH C _i = 5 nF	FISCO U _i = 17.5 V I _i = n.a. P _i = n.a. L _i = 10 µH C _i = 5 nF
	Pulse/frequency/switch output	U _i = 35 V I _i = 300 mA P _i = 1 W L _i = 0 µH C _i = 6 nF	

Type of protection IS

Order code for "Output"	Output type	Intrinsically safe values	
Option A	4-20mA HART	U _i = DC 30 V I _i = 300 mA P _i = 1 W L _i = 0 µH C _i = 5 nF	
Option B	4-20mA HART	U _i = DC 30 V I _i = 300 mA P _i = 1 W L _i = 0 µH C _i = 5 nF	
	Pulse/frequency/switch output	U _i = DC 30 V I _i = 300 mA P _i = 1 W L _i = 0 µH C _i = 6 nF	
Option C	4-20mA HART	U _i = DC 30 V I _i = 300 mA P _i = 1 W L _i = 0 µH C _i = 30 nF	
	4-20mA analog		
Option E	FOUNDATION Fieldbus	STANDARD U _i = 30 V I _i = 300 mA P _i = 1.2 W L _i = 10 µH C _i = 5 nF	FISCO U _i = 17.5 V I _i = 550 mA P _i = 5.5 W L _i = 10 µH C _i = 5 nF
	Pulse/frequency/switch output	U _i = 30 V I _i = 300 mA P _i = 1 W L _i = 0 µH C _i = 6 nF	
Option G	PROFIBUS PA	STANDARD U _i = 30 V I _i = 300 mA P _i = 1.2 W L _i = 10 µH C _i = 5 nF	FISCO U _i = 17.5 V I _i = 550 mA P _i = 5.5 W L _i = 10 µH C _i = 5 nF
	Pulse/frequency/switch output	U _i = 30 V I _i = 300 mA P _i = 1 W L _i = 0 µH C _i = 6 nF	

Low flow cut off

The switch points for low flow cut off are user-selectable.

Galvanic isolation

All outputs are galvanically isolated from one another.

Protocol-specific data**HART**

Manufacturer ID	0x11
Device type ID	0x54
HART protocol revision	7
Device description files (DTM, DD)	Information and files under: www.endress.com
HART load	<ul style="list-style-type: none"> ▪ Min. 250 Ω ▪ Max. 500 Ω
System integration	For information on system integration, see Operating Instructions. <ul style="list-style-type: none"> ▪ Measured variables via HART protocol ▪ Burst Mode functionality

FOUNDATION Fieldbus

Manufacturer ID	0x452B48
Ident number	0x1054
Device revision	1
DD revision	Information and files under:
CFF revision	<ul style="list-style-type: none"> ▪ www.endress.com ▪ www.fieldbus.org
Device Tester Version (ITK version)	6.1.1
ITK Test Campaign Number	IT094200
Link Master capability (LAS)	Yes
Choice of "Link Master" and "Basic Device"	Yes Factory setting: Basic Device
Node address	Factory setting: 247 (0xF7)
Supported functions	The following methods are supported: <ul style="list-style-type: none"> ▪ Restart ▪ ENP Restart ▪ Diagnostic
Virtual Communication Relationships (VCRs)	
Number of VCRs	44
Number of link objects in VFD	50
Permanent entries	1
Client VCRs	0
Server VCRs	10
Source VCRs	43
Sink VCRs	0
Subscriber VCRs	43
Publisher VCRs	43
Device Link Capabilities	
Slot time	4
Min. delay between PDU	8

Max. response delay	Min. 5
System integration	For information on system integration, see Operating Instructions. <ul style="list-style-type: none"> ▪ Cyclic data transmission ▪ Description of the modules ▪ Execution times ▪ Methods

PROFIBUS PA

Manufacturer ID	0x11
Ident number	0x155F
Profile version	3.02
Device description files (GSD, DTM, DD)	Information and files under: <ul style="list-style-type: none"> ▪ www.endress.com ▪ www.profibus.org
Supported functions	<ul style="list-style-type: none"> ▪ Identification & Maintenance Simple device identification via control system and nameplate ▪ PROFIBUS upload/download Reading and writing parameters is up to ten times faster with PROFIBUS upload/download ▪ Condensed status Simplest and self-explanatory diagnostic information by categorizing diagnostic messages that occur
Configuration of the device address	<ul style="list-style-type: none"> ▪ DIP switches on the I/O electronics module ▪ Local display ▪ Via operating tools (e. g. FieldCare)
System integration	For information on system integration, see Operating Instructions. <ul style="list-style-type: none"> ▪ Cyclic data transmission ▪ Block model ▪ Description of the modules

Power supply

Terminal assignment

Transmitter

Connection versions

<p style="text-align: right; font-size: small;">A0013570</p>	<p style="text-align: right; font-size: small;">A0018161</p>
<i>Maximum number of terminals, without integrated overvoltage protection</i>	<i>Maximum number of terminals, with integrated overvoltage protection</i>
<p>1 Output 1 (passive): supply voltage and signal transmission</p> <p>2 Output 2 (passive): supply voltage and signal transmission</p> <p>3 Ground terminal for cable shield</p>	

Order code for "Output"	Terminal numbers			
	Output 1		Output 2	
	1 (+)	2 (-)	3 (+)	4 (-)
Option A	4-20 mA HART (passive)		-	
Option B ¹⁾	4-20 mA HART (passive)		Pulse/frequency/switch output (passive)	
Option C ¹⁾	4-20 mA HART (passive)		4-20 mA analog (passive)	
Option E ^{1) 2)}	FOUNDATION Fieldbus		Pulse/frequency/switch output (passive)	
Option G ^{1) 3)}	PROFIBUS PA		Pulse/frequency/switch output (passive)	

- 1) Output 1 must always be used; output 2 is optional.
 2) FOUNDATION Fieldbus with integrated reverse polarity protection.
 3) PROFIBUS PA with integrated reverse polarity protection.

Pin assignment, device plug

PROFIBUS PA

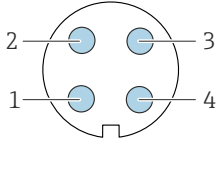
	Pin	Assignment	Coding	Plug/socket	
	1	+	PROFIBUS PA +	A	Plug
	2		Grounding		
	3	-	PROFIBUS PA -		
	4		Not assigned		

FOUNDATION Fieldbus

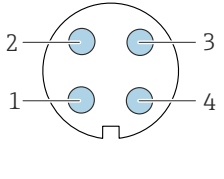
	Pin	Assignment	Coding	Plug/socket	
	1	+	Signal +	A	Plug
	2	-	Signal -		
	3		Grounding		
	4		Not assigned		

Supply voltage



Transmitter



An external power supply is required for each output.



Order code for "Output"	Minimum terminal voltage	Maximum terminal voltage
Option A ^{1) 2)} : 4-20 mA HART	<ul style="list-style-type: none"> ■ For 4 mA: ≥ DC 17.9 V ■ For 20 mA: ≥ DC 13.5 V 	DC 35 V
Option B ^{1) 2)} : 4-20 mA HART, pulse/frequency/switch output	<ul style="list-style-type: none"> ■ For 4 mA: ≥ DC 17.9 V ■ For 20 mA: ≥ DC 13.5 V 	DC 35 V
Option C ^{1) 2)} : 4-20 mA HART + 4-20 mA analog	<ul style="list-style-type: none"> ■ For 4 mA: ≥ DC 17.9 V ■ For 20 mA: ≥ DC 13.5 V 	DC 30 V

Order code for "Output"	Minimum terminal voltage	Maximum terminal voltage
Option E ³⁾ : FOUNDATION Fieldbus, pulse/frequency/switch output	≥ DC 9 V	DC 32 V
Option G ³⁾ : PROFIBUS PA, pulse/frequency/switch output	≥ DC 9 V	DC 32 V

- 1) External supply voltage of the power supply unit with load.
- 2) For device versions with SD03 local display: The terminal voltage must be increased by DC 2 V if backlighting is used.
- 3) For device version with SD03 local display: The terminal voltage must be increased by DC 0.5 V if backlighting is used.

 For information about the load see →  13

 Various power supply units can be ordered from Endress+Hauser: →  75

 For information on the Ex connection values →  14

Power consumption

Transmitter

Order code for "Output; input"	Maximum power consumption
Option A: 4-20 mA HART	770 mW
Option B: 4-20 mA HART, pulse/frequency/switch output	<ul style="list-style-type: none"> ▪ Operation with output 1: 770 mW ▪ Operation with output 1 and 2: 2 770 mW
Option C: 4-20 mA HART + 4-20 mA analog	<ul style="list-style-type: none"> ▪ Operation with output 1: 660 mW ▪ Operation with output 1 and 2: 1 320 mW
Option E: FOUNDATION Fieldbus, pulse/frequency/switch output	<ul style="list-style-type: none"> ▪ Operation with output 1: 576 mW ▪ Operation with output 1 and 2: 2 576 mW
Option G: PROFIBUS PA, pulse/frequency/switch output	<ul style="list-style-type: none"> ▪ Operation with output 1: 512 mW ▪ Operation with output 1 and 2: 2 512 mW

 For information on the Ex connection values →  14

Current consumption

Current output

For every 4-20 mA or 4-20 mA HART current output: 3.6 to 22.5 mA

 If the option **Defined value** is selected in the **Failure mode** parameter : 3.59 to 22.5 mA

FOUNDATION Fieldbus

18 mA

PROFIBUS PA

16 mA

Power supply failure

Depending on the device version, the configuration is retained in the device memory or in the pluggable data memory (HistoROM DAT).

Electrical connection

Connecting the transmitter

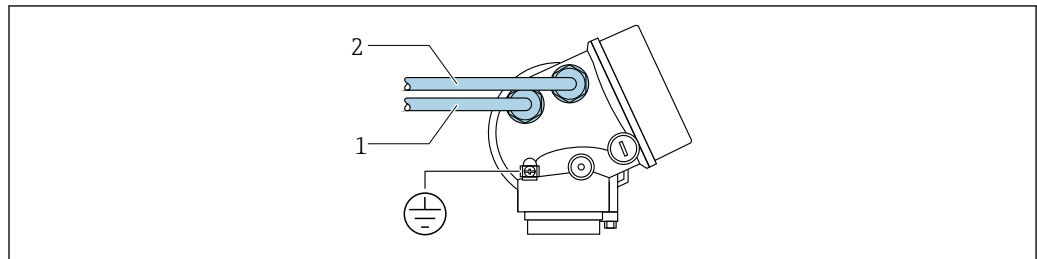

A0015510

- 1 Cable entry for output 1
- 2 Cable entry for output 2

Connection examples

Current output 4-20 mA HART

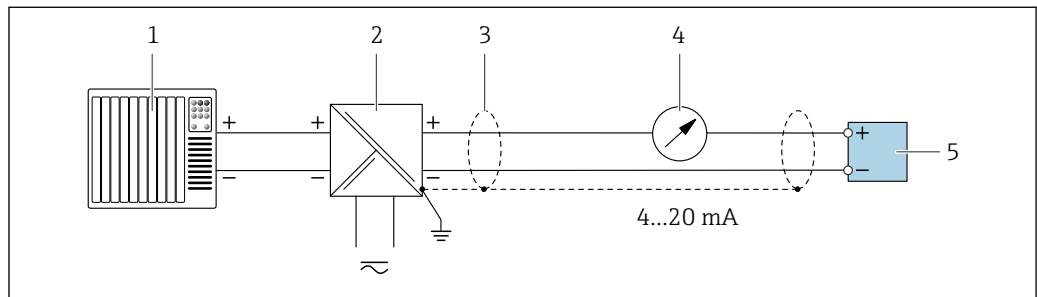

A0028762

1 Connection example for 4 to 20 mA HART current output (passive)

- 1 Automation system with current input (e.g. PLC)
- 2 Power supply
- 3 Cable shield: the cable shield must be grounded at both ends to comply with EMC requirements; observe cable specifications
- 4 Analog display unit: observe maximum load
- 5 Transmitter

Pulse/frequency output

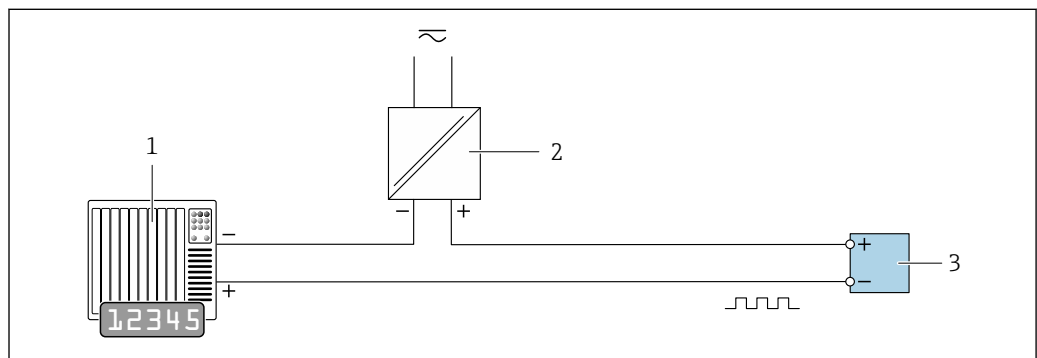

A0028761

2 Connection example for pulse/frequency output (passive)

- 1 Automation system with pulse/frequency input (e.g. PLC)
- 2 Power supply
- 3 Transmitter: Observe input values

Switch output

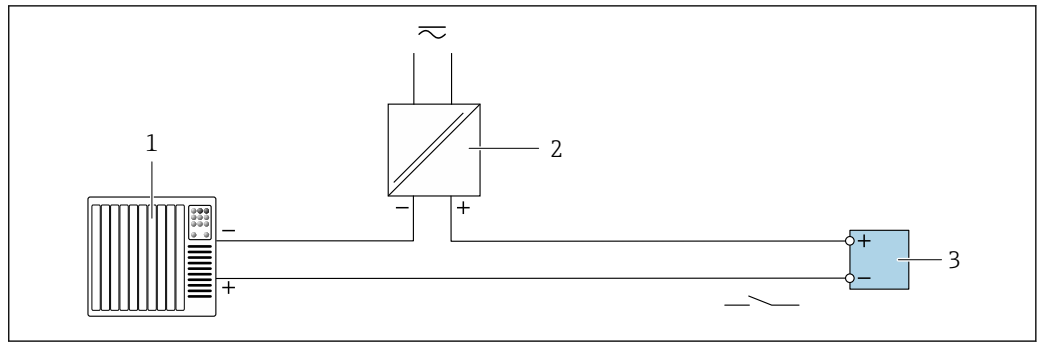

A0028760

3 Connection example for switch output (passive)

- 1 Automation system with switch input (e.g. PLC)
- 2 Power supply
- 3 Transmitter: Observe input values

FOUNDATION Fieldbus

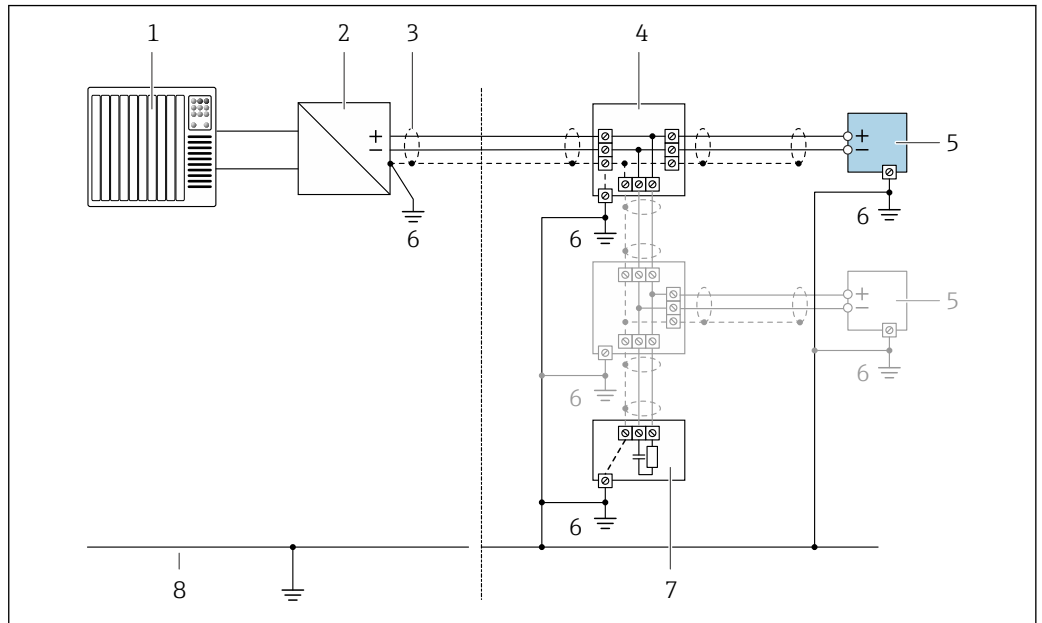

A0028768

4 Connection example for FOUNDATION Fieldbus

- 1 Control system (e.g. PLC)
- 2 Power Conditioner (FOUNDATION Fieldbus)
- 3 Cable shield: the cable shield must be grounded at both ends to comply with EMC requirements; observe cable specifications
- 4 T-box
- 5 Measuring device
- 6 Local grounding
- 7 Bus terminator
- 8 Potential matching line

PROFIBUS PA

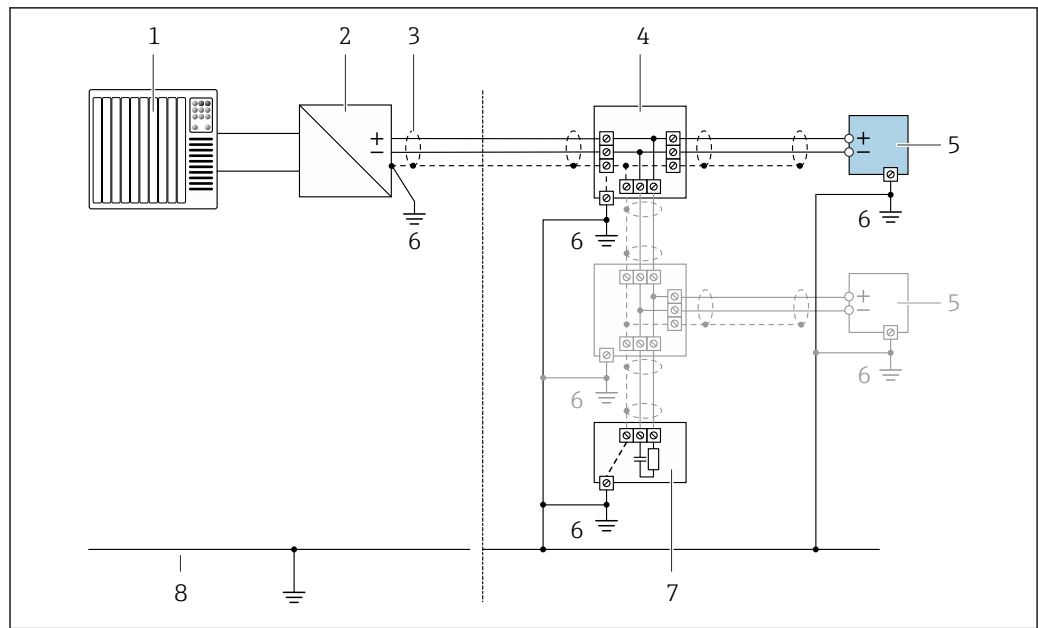

A0028768

5 Connection example for PROFIBUS PA

- 1 Control system (e.g. PLC)
- 2 PROFIBUS PA segment coupler
- 3 Cable shield: the cable shield must be grounded at both ends to comply with EMC requirements; observe cable specifications
- 4 T-box
- 5 Measuring device
- 6 Local grounding
- 7 Bus terminator
- 8 Potential matching line

HART input

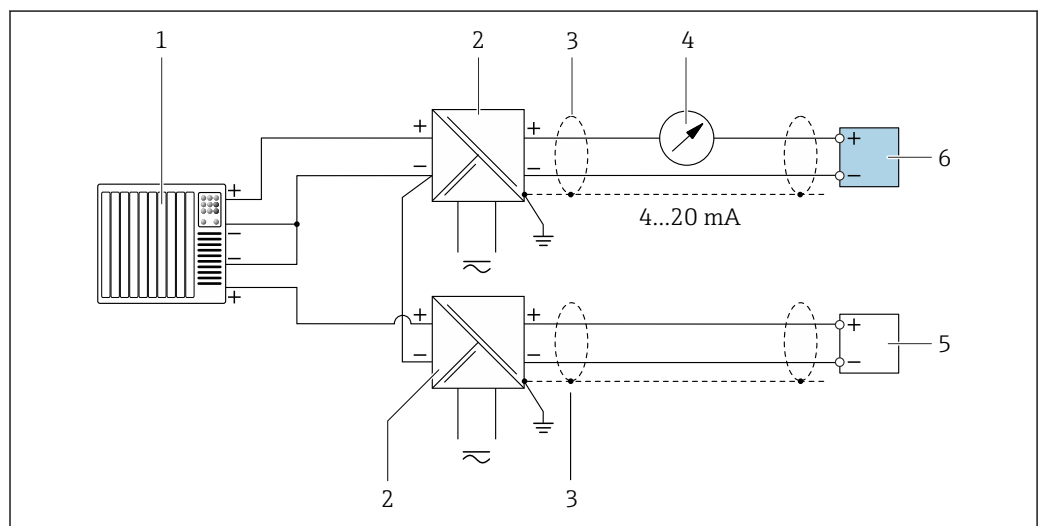

A0028763

6 Connection example for HART input with a common negative (passive)

- 1 Automation system with HART output (e.g. PLC)
- 2 Active barrier for power supply (e.g. RN22 1N)
- 3 Cable shield: the cable shield must be grounded at both ends to comply with EMC requirements; observe cable specifications
- 4 Analog display unit: observe maximum load
- 5 Pressure measuring device (e.g. Cerabar M, Cerabar S): see requirements
- 6 Transmitter

Electrical connection

Connecting the transmitter

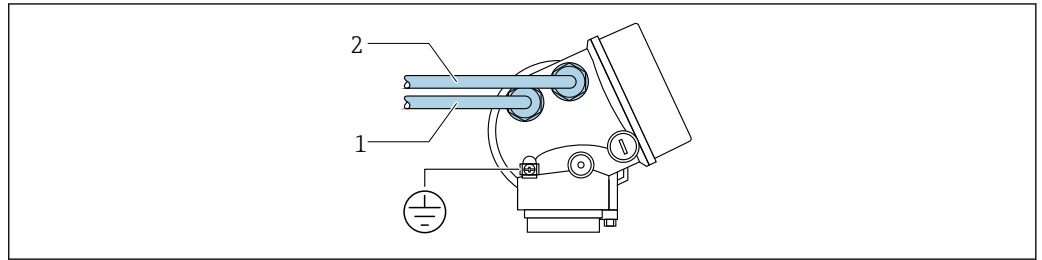

A0015510

- 1 Cable entry for output 1
- 2 Cable entry for output 2

Connection examples

Current output 4-20 mA HART

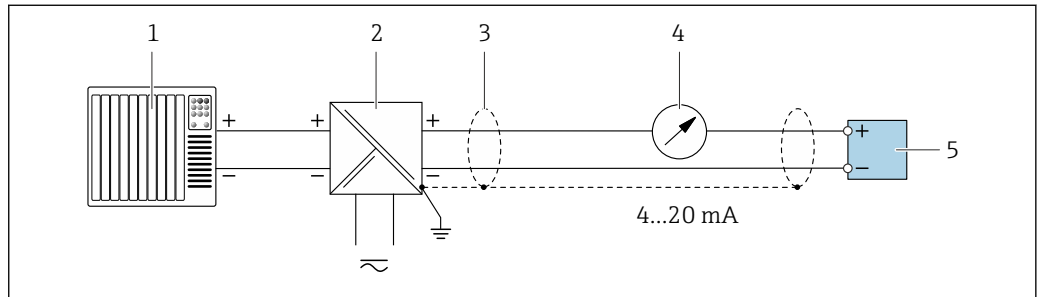

A0028762

7 Connection example for 4 to 20 mA HART current output (passive)

- 1 Automation system with current input (e.g. PLC)
- 2 Power supply
- 3 Cable shield: the cable shield must be grounded at both ends to comply with EMC requirements; observe cable specifications
- 4 Analog display unit: observe maximum load
- 5 Transmitter

Pulse/frequency output

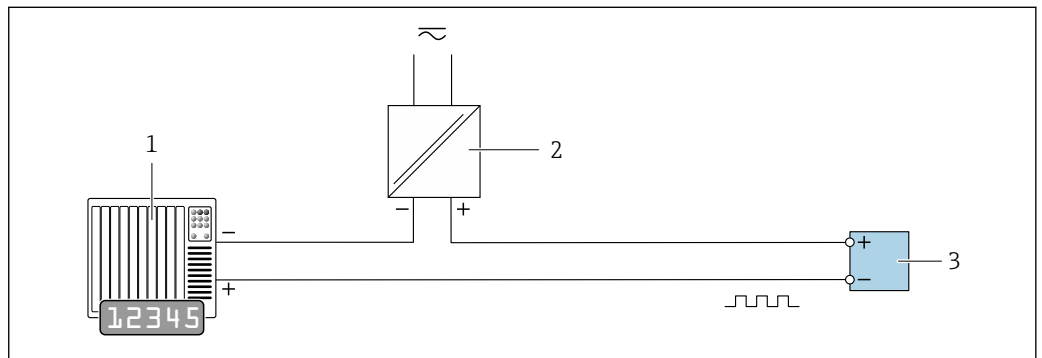

A0028761

8 Connection example for pulse/frequency output (passive)

- 1 Automation system with pulse/frequency input (e.g. PLC)
- 2 Power supply
- 3 Transmitter: Observe input values

Switch output

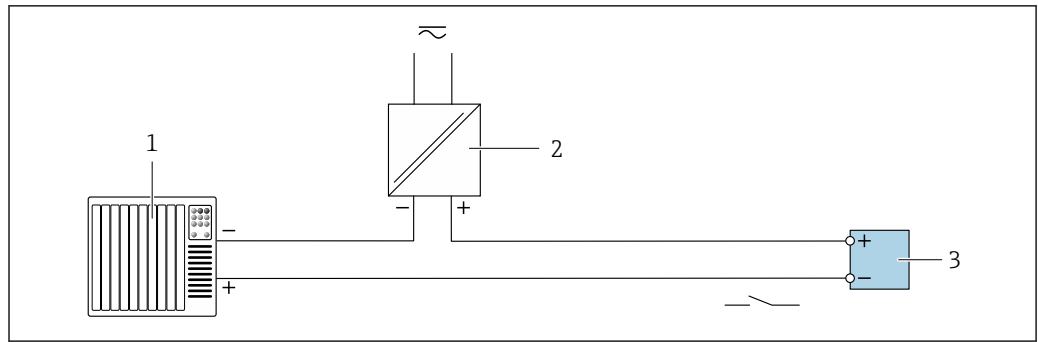

A0028760

9 Connection example for switch output (passive)

- 1 Automation system with switch input (e.g. PLC)
- 2 Power supply
- 3 Transmitter: Observe input values

FOUNDATION Fieldbus

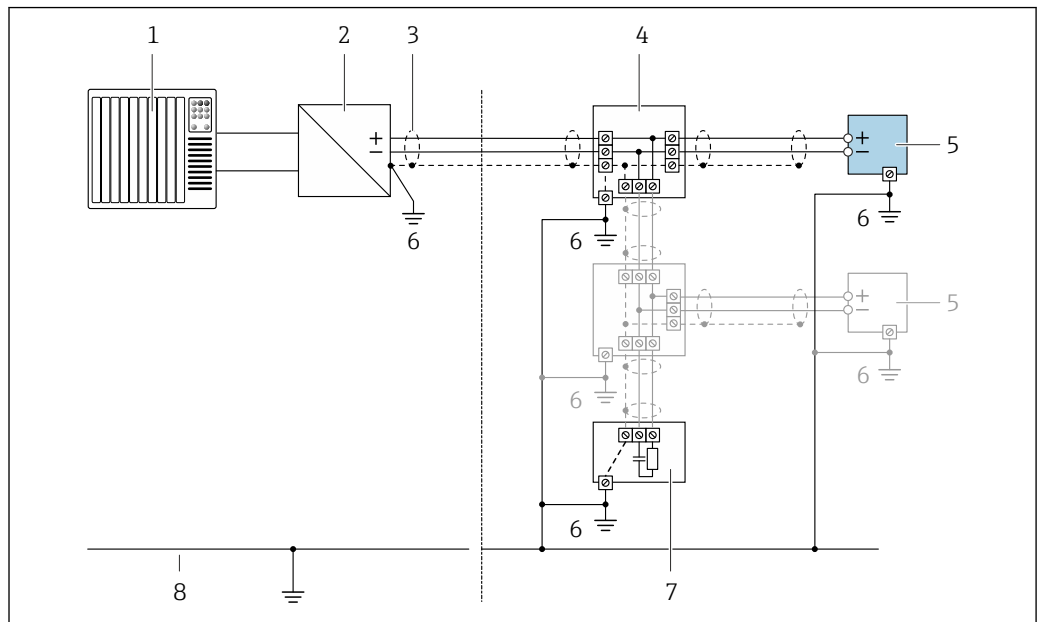

A0028768

10 Connection example for FOUNDATION Fieldbus

- 1 Control system (e.g. PLC)
- 2 Power Conditioner (FOUNDATION Fieldbus)
- 3 Cable shield: the cable shield must be grounded at both ends to comply with EMC requirements; observe cable specifications
- 4 T-box
- 5 Measuring device
- 6 Local grounding
- 7 Bus terminator
- 8 Potential matching line

PROFIBUS PA

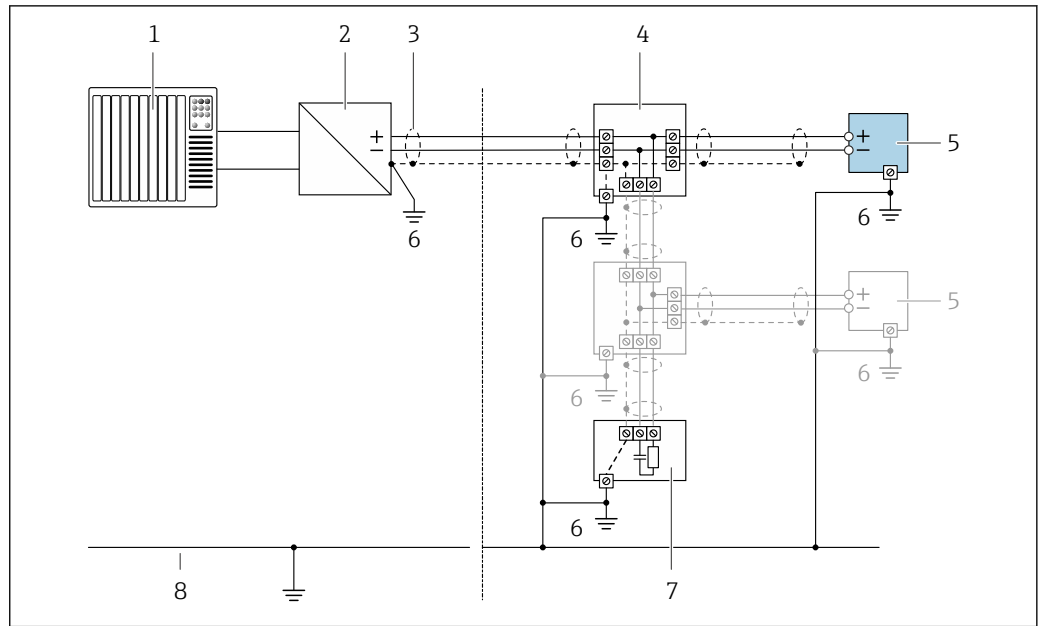

A0028768

11 Connection example for PROFIBUS PA

- 1 Control system (e.g. PLC)
- 2 PROFIBUS PA segment coupler
- 3 Cable shield: the cable shield must be grounded at both ends to comply with EMC requirements; observe cable specifications
- 4 T-box
- 5 Measuring device
- 6 Local grounding
- 7 Bus terminator
- 8 Potential matching line

HART input

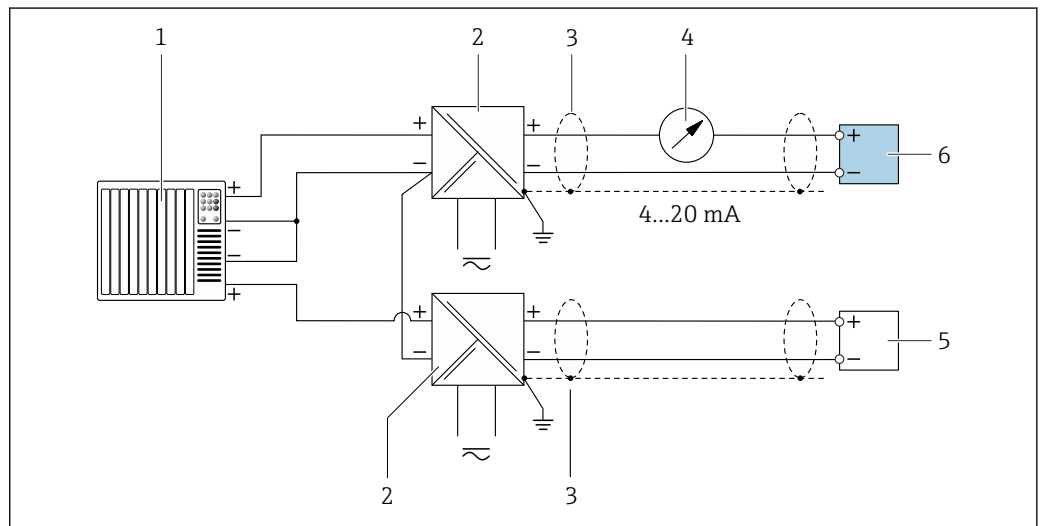

A0028763

12 Connection example for HART input with a common negative (passive)

- 1 Automation system with HART output (e.g. PLC)
- 2 Active barrier for power supply (e.g. RN221N)
- 3 Cable shield: the cable shield must be grounded at both ends to comply with EMC requirements; observe cable specifications
- 4 Analog display unit: observe maximum load
- 5 Pressure measuring device (e.g. Cerabar M, Cerabar S): see requirements
- 6 Transmitter

Potential equalization**Requirements**

No special measures for potential equalization are required.



For devices intended for use in hazardous locations, please observe the guidelines in the Ex documentation (XA).

Terminals

- For device version without integrated overvoltage protection: plug-in spring terminals for wire cross-sections 0.5 to 2.5 mm² (20 to 14 AWG)
- For device version with integrated overvoltage protection: screw terminals for wire cross-sections 0.2 to 2.5 mm² (24 to 14 AWG)

Cable entries

- Cable gland (not for Ex d): M20 × 1.5 with cable \varnothing 6 to 12 mm (0.24 to 0.47 in)
- Thread for cable entry:
 - For non-hazardous and hazardous areas: NPT 1/2"
 - For non-hazardous and hazardous areas (not for XP): G 1/2"
 - For Ex d: M20 × 1.5

Cable specification**Permitted temperature range**

- The installation guidelines that apply in the country of installation must be observed.
- The cables must be suitable for the minimum and maximum temperatures to be expected.

Signal cable

Current output 4 to 20 mA HART

A shielded cable is recommended. Observe grounding concept of the plant.

Current output 4 to 20 mA

Standard installation cable is sufficient.

Pulse/frequency/switch output

Standard installation cable is sufficient.

FOUNDATION Fieldbus

Twisted, shielded two-wire cable.



For further information on planning and installing FOUNDATION Fieldbus networks see:

- Operating Instructions for "FOUNDATION Fieldbus Overview" (BA00013S)
- FOUNDATION Fieldbus Guideline
- IEC 61158-2 (MBP)

PROFIBUS PA

Twisted, shielded two-wire cable. Cable type A is recommended .



For further information on planning and installing PROFIBUS networks see:

- Operating Instructions "PROFIBUS DP/PA: Guidelines for planning and commissioning" (BA00034S)
- PNO Directive 2.092 "PROFIBUS PA User and Installation Guideline"
- IEC 61158-2 (MBP)

Overvoltage protection

The device can be ordered with integrated overvoltage protection for diverse approvals:

Order code for "Accessory mounted", option NA "Overvoltage protection"

Input voltage range	Values correspond to supply voltage specifications → 20 ¹⁾
Resistance per channel	2 · 0.5 Ω max.
DC sparkover voltage	400 to 700 V
Trip surge voltage	< 800 V
Capacitance at 1 MHz	< 1.5 pF

Nominal discharge current (8/20 µs)	10 kA
Temperature range	-40 to +85 °C (-40 to +185 °F)

1) The voltage is reduced by the amount of the internal resistance $I_{min} \cdot R_i$



 Depending on the temperature class, restrictions apply to the ambient temperature for device versions with overvoltage protection .

 For detailed information on the temperature tables, see the "Safety Instructions" (XA) for the device.

Performance characteristics

Reference operating conditions

- Error limits based on ISO 11631
- Water with +15 to +45 °C (+59 to +113 °F) at 2 to 6 bar (29 to 87 psi)
- Specifications as per calibration protocol
- Accuracy based on accredited calibration rigs that are traced to ISO 17025.

 To obtain measured errors, use the *Applicator* sizing tool →  75

Maximum measured error

o.r. = of reading; 1 g/cm³ = 1 kg/l; T = medium temperature

Base accuracy

 Design fundamentals →  32

Mass flow and volume flow (liquids)

±0.10 % o.r.

Mass flow (gases)

±0.35 % o.r.

Density (liquids)

Under reference operating conditions [g/cm ³]	Standard density calibration ¹⁾ [g/cm ³]	Wide-range Density specification ^{2) 3)} [g/cm ³]
±0.0005	±0.02	±0.002

1) Valid over the entire temperature and density range

2) Valid range for special density calibration: 0 to 2 g/cm³, +5 to +80 °C (+41 to +176 °F)

3) Order code for "Application package", option EE "Special density" only in combination with the order code for "Measuring tube mat., wetted surface", option BB, BF, HA, SA

Temperature

±0.5 °C ± 0.005 · T °C (±0.9 °F ± 0.003 · (T - 32) °F)

Zero point stability

Standard version: order code for "Measuring tube mat., wetted surface", option BB, BF, HA, SA

DN		Zero point stability	
[mm]	[in]	[kg/h]	[lb/min]
1	1/24	0.0010	0.000036
2	1/12	0.0050	0.00018
4	1/8	0.0200	0.00072

High-pressure version: order code for "Measuring tube mat., wetted surface", option HB

DN		Zero point stability	
[mm]	[in]	[kg/h]	[lb/min]
1	1/24	0.0016	0.0000576
2	1/12	0.0080	0.000288
4	1/8	0.0320	0.001152

Flow values

Flow values as turndown parameter depending on nominal diameter.

SI units

DN [mm]	1:1	1:10	1:20	1:50	1:100	1:500
	[kg/h]	[kg/h]	[kg/h]	[kg/h]	[kg/h]	[kg/h]
1	20	2	1	0.4	0.2	0.04
2	100	10	5	2	1	0.2
4	450	45	22.5	9	4.5	0.9

US units

DN [inch]	1:1	1:10	1:20	1:50	1:100	1:500
	[lb/min]	[lb/min]	[lb/min]	[lb/min]	[lb/min]	[lb/min]
1/24	0.735	0.074	0.037	0.015	0.007	0.001
1/12	3.675	0.368	0.184	0.074	0.037	0.007
1/8	16.54	1.654	0.827	0.331	0.165	0.033

Accuracy of outputs

The outputs have the following base accuracy specifications.

Current output

Accuracy	±10 µA
----------	--------

Pulse/frequency output

o.r. = of reading

Accuracy	Max. ±100 ppm o.r.
----------	--------------------

Repeatability

o.r. = of reading; 1 g/cm³ = 1 kg/l; T = medium temperature

Base repeatability

 Design fundamentals →  32

Mass flow and volume flow (liquids)

±0.05 % o.r.

Mass flow (gases)

±0.15 % o.r.

Density (liquids)

±0.00025 g/cm³

Temperature

±0.25 °C ± 0.0025 · T °C (±0.45 °F ± 0.0015 · (T-32) °F)

Response time

- The response time depends on the configuration (damping).
- Response time in the event of erratic changes in the measured variable: After 500 ms → 95 % of full scale value

Influence of ambient temperature

Current output

o.r. = of reading

Additional error, in relation to the span of 16 mA:

Temperature coefficient at zero point (4 mA)	0.02 %/10 K
Temperature coefficient with span (20 mA)	0.05 %/10 K

Pulse/frequency output

o.r. = of reading

Temperature coefficient	Max. ±100 ppm o.r.
-------------------------	--------------------

Influence of medium temperature

Mass flow and volume flow

o.f.s. = of full scale value

When there is a difference between the temperature for zero point adjustment and the process temperature, the additional measured error of the sensor is typically ±0.0002 % o.f.s./°C (±0.0001 % o. f.s./°F).

The effect is reduced if zero point adjustment is performed at process temperature.

Density

When there is a difference between the density calibration temperature and the process temperature, the typical measured error of the sensor is ±0.00005 g/cm³ /°C (±0.000025 g/cm³ /°F). Field density calibration is possible.

Wide-range density specification (special density calibration)

If the process temperature is outside the valid range (→  29) the measured error is ±0.00005 g/cm³ /°C (±0.000025 g/cm³ /°F)

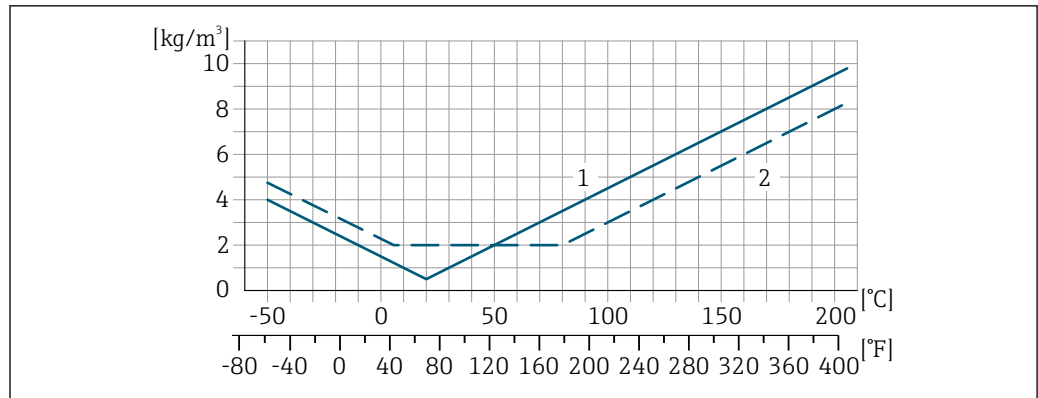

A0016616

- 1 Field density calibration, for example at +20 °C (+68 °F)
- 2 Special density calibration

Influence of medium pressure

A difference between the calibration pressure and process pressure does not affect accuracy.

Design fundamentals

o.r. = of reading, o.f.s. = of full scale value

BaseAccu = base accuracy in % o.r., BaseRepeat = base repeatability in % o.r.

MeasValue = measured value; ZeroPoint = zero point stability

Calculation of the maximum measured error as a function of the flow rate

Flow rate	Maximum measured error in % o.r.
$\geq \frac{\text{ZeroPoint}}{\text{BaseAccu}} \cdot 100$ <small>A0021332</small>	$\pm \text{BaseAccu}$ <small>A0021339</small>
$< \frac{\text{ZeroPoint}}{\text{BaseAccu}} \cdot 100$ <small>A0021333</small>	$\pm \frac{\text{ZeroPoint}}{\text{MeasValue}} \cdot 100$ <small>A0021334</small>

Calculation of the maximum repeatability as a function of the flow rate

Flow rate	Maximum repeatability in % o.r.
$\geq \frac{4/3 \cdot \text{ZeroPoint}}{\text{BaseAccu}} \cdot 100$ <small>A0021341</small>	$\pm 1/2 \cdot \text{BaseAccu}$ <small>A0021343</small>
$< \frac{4/3 \cdot \text{ZeroPoint}}{\text{BaseAccu}} \cdot 100$ <small>A0021342</small>	$\pm 2/3 \cdot \frac{\text{ZeroPoint}}{\text{MeasValue}} \cdot 100$ <small>A0021344</small>

Example for maximum measured error

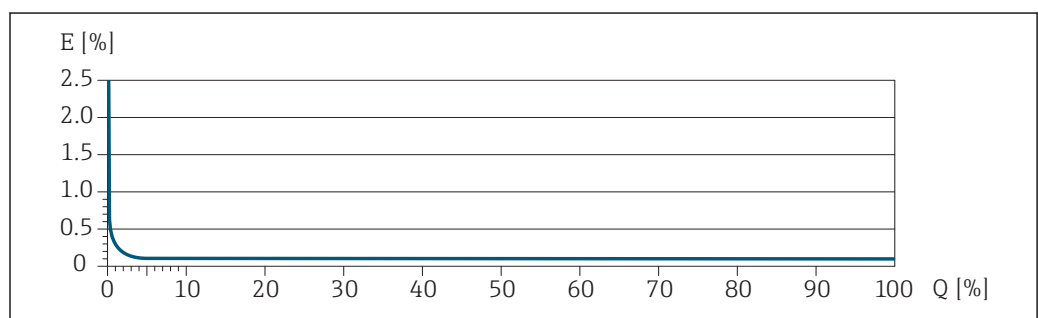



A0030378

- E Maximum measured error in % o.r. (example)
- Q Flow rate in % of maximum full scale value

Installation

No special measures such as supports etc. are necessary. External forces are absorbed by the construction of the device.

 Use a sensor holder for additional stability in the process pipe and for non-flanged process connections. →  35

Mounting location

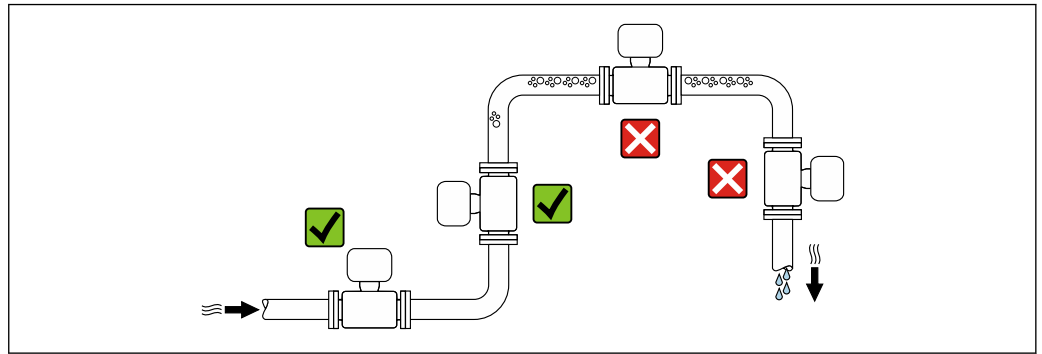

A0028772

To prevent measuring errors arising from accumulation of gas bubbles in the measuring tube, avoid the following mounting locations in the pipe:

- Highest point of a pipeline.
- Directly upstream of a free pipe outlet in a down pipe.

Installation in down pipes

However, the following installation suggestion allows for installation in an open vertical pipeline. Pipe restrictions or the use of an orifice with a smaller cross-section than the nominal diameter prevent the sensor running empty while measurement is in progress.

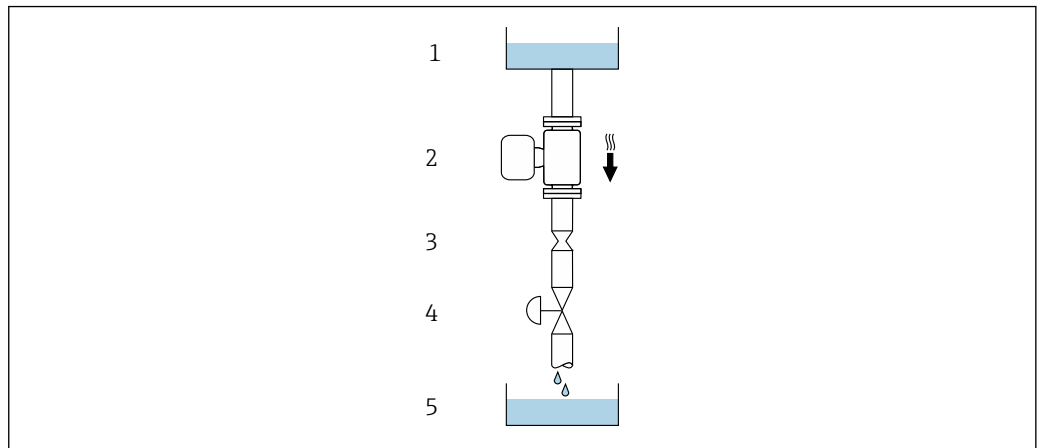

A0028773



 13 Installation in a down pipe (e.g. for batching applications)

- 1 Supply tank
- 2 Sensor
- 3 Orifice plate, pipe restriction
- 4 Valve
- 5 Batching tank

DN		Ø orifice plate, pipe restriction	
[mm]	[in]	[mm]	[in]
1	1/24	0.8	0.03
2	1/12	1.5	0.06
4	1/8	3.0	0.12

Orientation

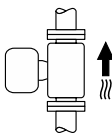
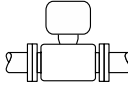
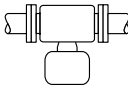
The direction of the arrow on the sensor nameplate helps you to install the sensor according to the flow direction (direction of medium flow through the piping).

Orientation		Recommendation	
A	Vertical orientation	 A0015591	☑☑ ¹⁾
B	Horizontal orientation, transmitter at top	 A0015589	☑ ²⁾
C	Horizontal orientation, transmitter at bottom	 A0015590	☑ ³⁾
D	Horizontal orientation, transmitter at side	 A0015592	☑

- 1) This orientation is recommended to ensure self-draining.
- 2) Applications with low process temperatures may decrease the ambient temperature. To maintain the minimum ambient temperature for the transmitter, this orientation is recommended.
- 3) Applications with high process temperatures may increase the ambient temperature. To maintain the maximum ambient temperature for the transmitter, this orientation is recommended.

Inlet and outlet runs

No special precautions need to be taken for fittings which create turbulence, such as valves, elbows or T-pieces, as long as no cavitation occurs → 42.

Special mounting instructions**Drainability**

When the device is installed in a vertical position, the measuring tube can be drained completely and protected against deposit buildup if the properties of the measured liquid allow this. Furthermore, as only one measuring tube is used the flow is not impeded and the risk of product being retained in the measuring device is reduced to a minimum. The larger internal diameter of the measuring tube¹⁾ also reduces the risk of particles getting trapped in the measuring system. Due to the larger cross-section of the individual measuring tube, the tube is also generally less susceptible to clogging.

Rupture disk

Information that is relevant to the process: → 42.

⚠ WARNING**Danger from medium escaping!**

Medium escaping under pressure can cause injury or material damage.

- ▶ Take precautions to prevent danger to persons and damage if the rupture disk is actuated.
- ▶ Observe information on the rupture disk sticker.
- ▶ Make sure that the function and operation of the rupture disk is not impeded through the installation of the device.
- ▶ Do not remove or damage the rupture disk.

The position of the rupture disk is indicated on a sticker applied over it. If the rupture disk is triggered, the sticker is destroyed. The disk can therefore be visually monitored.

If the sensor holder is used with a measuring device fitted with a rupture disk, it is important to ensure that the opening in the neck is not covered over and that the cover of the rupture disk is not damaged.

1) Compared with the double-tube design with a similar flow capacity with measuring tubes and a smaller internal diameter

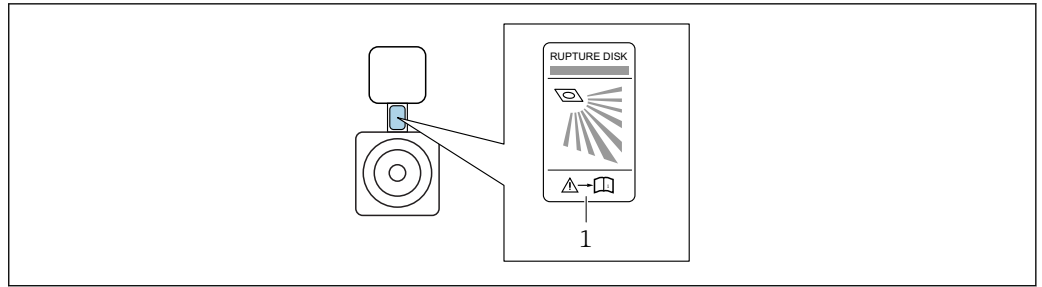

A0032051

1 Rupture disk label

For information on the dimensions: see the "Mechanical construction" section (accessories)

Sensor holder

The sensor holder is used to secure the device to a wall, tabletop or pipe (order code for "Enclosed accessories", option PR).

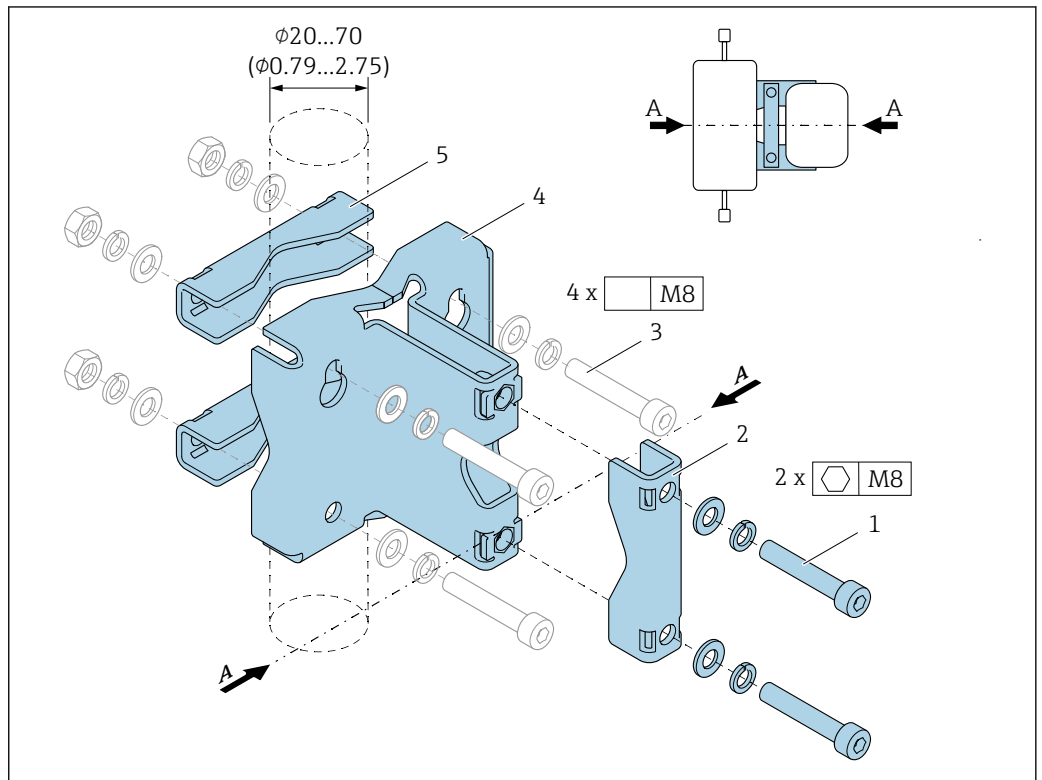

A0036471

- 1 2 x Allen screw M8 x 50, washer and spring washer A4
- 2 1 x clamp (measuring device neck)
- 3 4 x securing screw for wall, tabletop or pipe mounting (not supplied)
- 4 1 x base profile
- 5 2 x clamp (pipe mounting)
- A Measuring device central line

If the holder is used with a measuring device fitted with a rupture disk, it is important to ensure that the rupture disk in the neck is not covered over and that the cover of the rupture disk is not damaged.

i Lubricate all threaded joints prior to mounting. The screws for wall, tabletop or pipe mounting are not supplied with the device and must be chosen to suit the individual installation position.

⚠ WARNING**Strain on pipes!**

Excessive strain on unsupported pipes can cause the pipe to break.

- Install the sensor in a pipe that is adequately supported.

The following mounting versions are recommended for the installation:

Using the sensor holder.

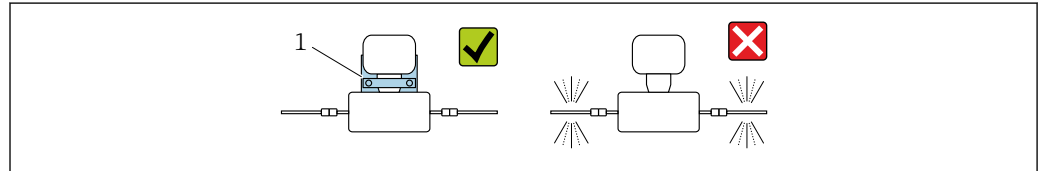

A0036492

1 Sensor holder (order code for "Enclosed accessories", option PR)

Mounting on a wall

Screw the sensor holder to the wall with four screws. Two of the four holes to secure the holder are designed to hook into the screws.

Mounting on a table

Screw the sensor holder onto the tabletop with four screws.

Mounting on a pipe

Secure the sensor holder to the pipe with two clamps.

Zero point adjustment

All measuring devices are calibrated in accordance with state-of-the-art technology. Calibration takes place under reference conditions → 29. Therefore, a zero point adjustment in the field is generally not required.

Experience shows that zero point adjustment is advisable only in special cases:

- To achieve maximum measuring accuracy even with low flow rates.
- Under extreme process or operating conditions (e.g. very high process temperatures or very high-viscosity fluids).

Environment

Ambient temperature range	Measuring device	-40 to +60 °C (-40 to +140 °F)
	Readability of the local display	-20 to +60 °C (-4 to +140 °F) The readability of the display may be impaired at temperatures outside the temperature range.

- If operating outdoors:
Avoid direct sunlight, particularly in warm climatic regions.

i You can order a weather protection cover from Endress+Hauser. → 73.

Storage temperature	-40 to +80 °C (-40 to +176 °F), preferably at +20 °C (+68 °F)
----------------------------	---

Climate class	DIN EN 60068-2-38 (test Z/AD)
----------------------	-------------------------------

Degree of protection	<p>Transmitter</p> <ul style="list-style-type: none"> ■ As standard: IP66/67, type 4X enclosure ■ When housing is open: IP20, type 1 enclosure ■ Display module: IP20, type 1 enclosure <p>Sensor IP66/67, type 4X enclosure</p> <p>Connector IP67, only in screwed situation</p>
Vibration resistance	<ul style="list-style-type: none"> ■ Oscillation, sinusoidal, following IEC 60068-2-6 <ul style="list-style-type: none"> - 2 to 8.4 Hz, 3.5 mm peak - 8.4 to 2 000 Hz, 1 g peak ■ Oscillation, broadband noise following IEC 60068-2-64 <ul style="list-style-type: none"> - 10 to 200 Hz, 0.003 g²/Hz - 200 to 2 000 Hz, 0.001 g²/Hz - Total: 1.54 g rms
Shock resistance	Shock, half-sine according to IEC 60068-2-27 6 ms 30 g
Shock resistance	Shock due to rough handling following IEC 60068-2-31
Interior cleaning	<ul style="list-style-type: none"> ■ Cleaning in place (CIP) ■ Sterilization in place (SIP) <p>Options Oil- and grease-free version for wetted parts, without declaration Order code for "Service", option HA</p>
Electromagnetic compatibility (EMC)	<p>As per IEC/EN 61326 and NAMUR Recommendation 21 (NE 21)</p> <p> Details are provided in the Declaration of Conformity.</p>

Process

Medium temperature range	-50 to +205 °C (-58 to +401 °F)
Density	0 to 2 000 kg/m ³ (0 to 125 lb/cf)
Pressure-temperature ratings	The following pressure/temperature diagrams apply to all pressure-bearing parts of the device and not just the process connection. The diagrams show the maximum permissible medium pressure depending on the specific medium temperature.

Flange connection according to EN 1092-1 (DIN 2501)

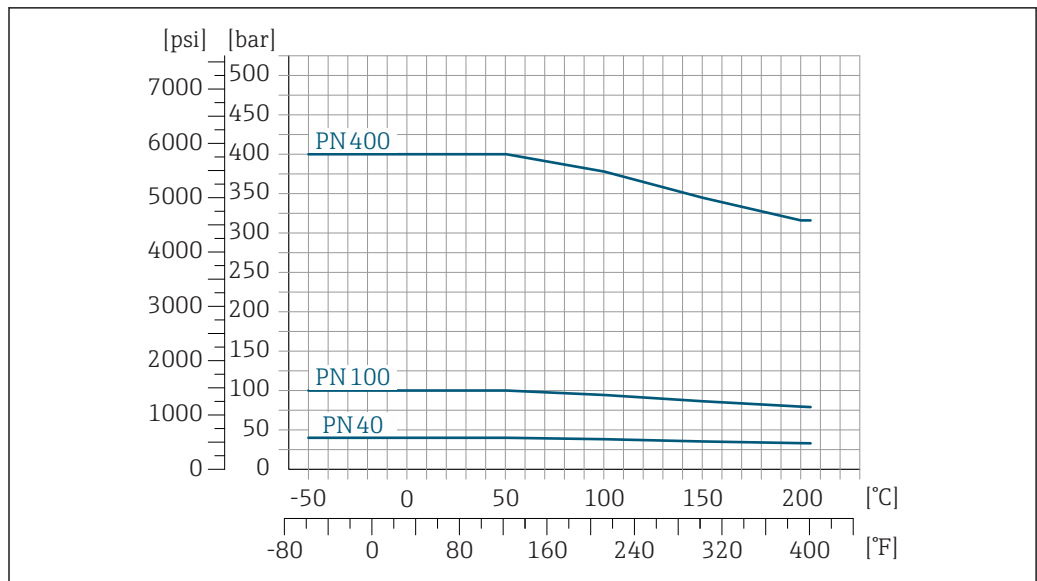

14 With flange material: 1.4404 (316/316L)

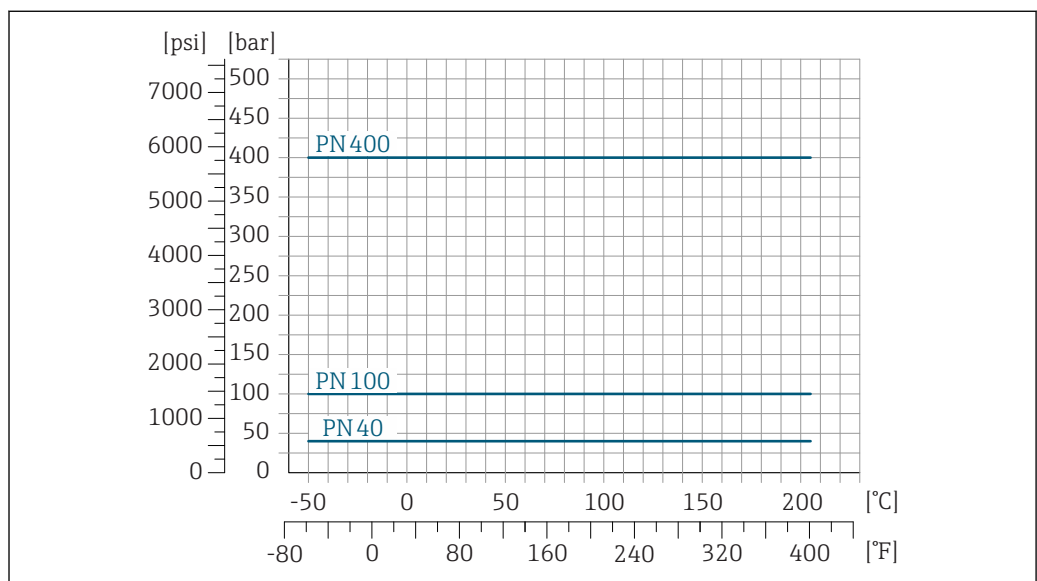

15 With flange material: Alloy C22, 2.4602 (UNS N06022)

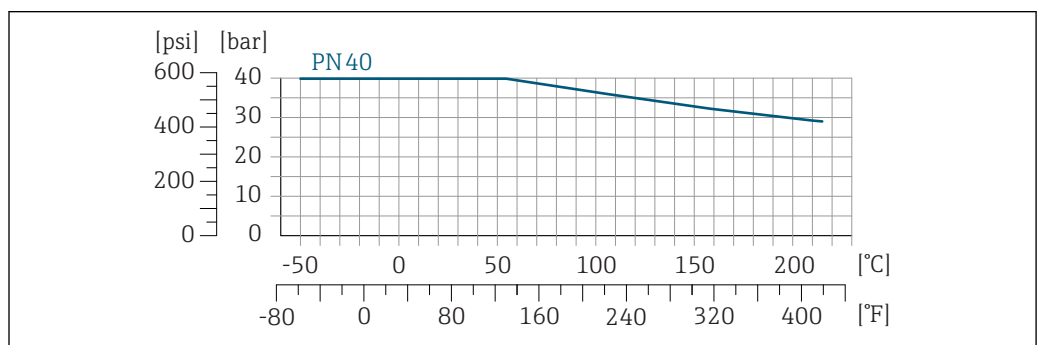

16 Lap joint flange with flange material: 1.4301 (F304), wetted parts Alloy C22: 2.4602 (UNS N06022)

Flange connection according to ASME B16.5

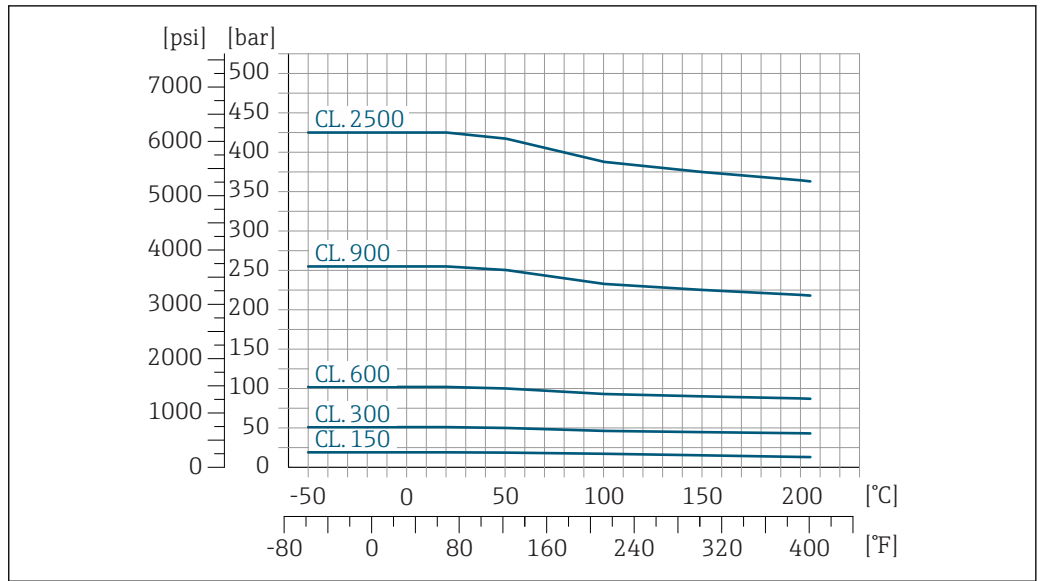

17 With flange material: 1.4404 (316/316L)

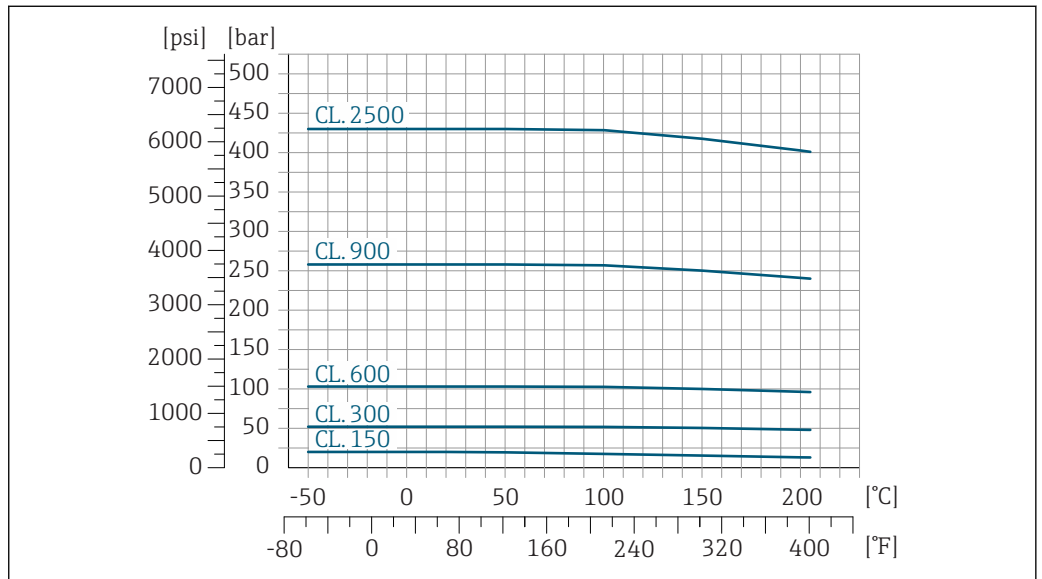

18 With flange material: Alloy C22, 2.4602 (UNS N06022)

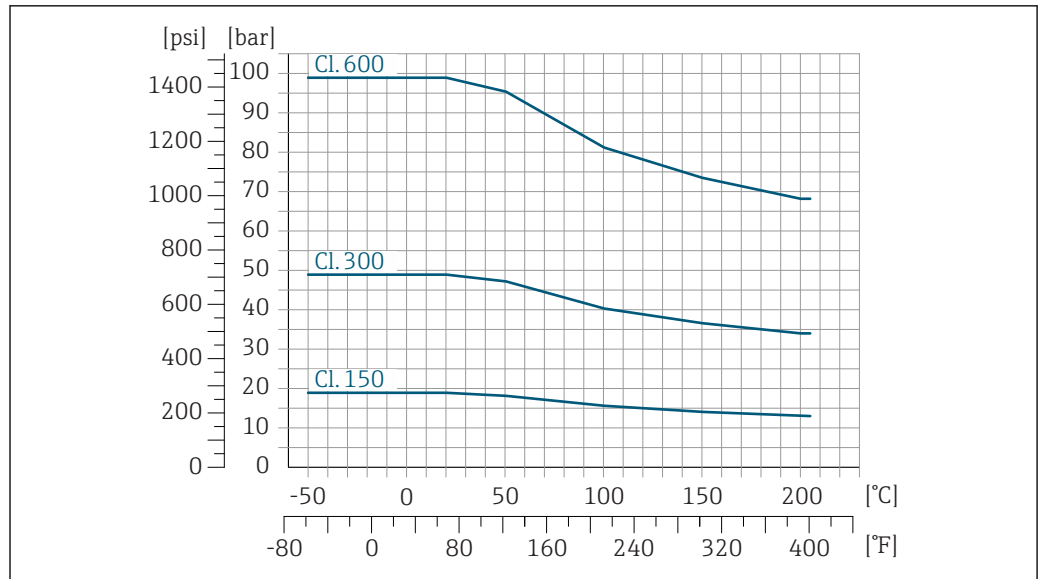

A0036202-EN

19 Lap joint flange with flange material: 1.4301 (F304), wetted parts Alloy C22: 2.4602 (UNS N06022)

Flange connection according to JIS B2220

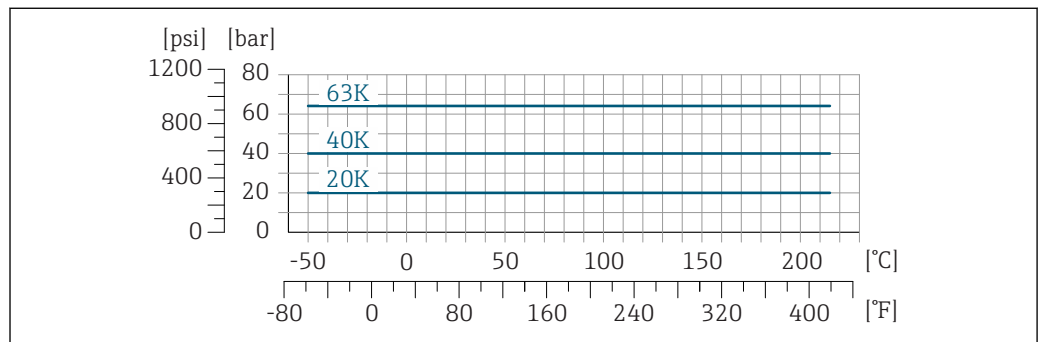

A0036204-EN

20 With flange material: 1.4404 (316/316L) or Alloy C22, 2.4602 (UNS N06022)

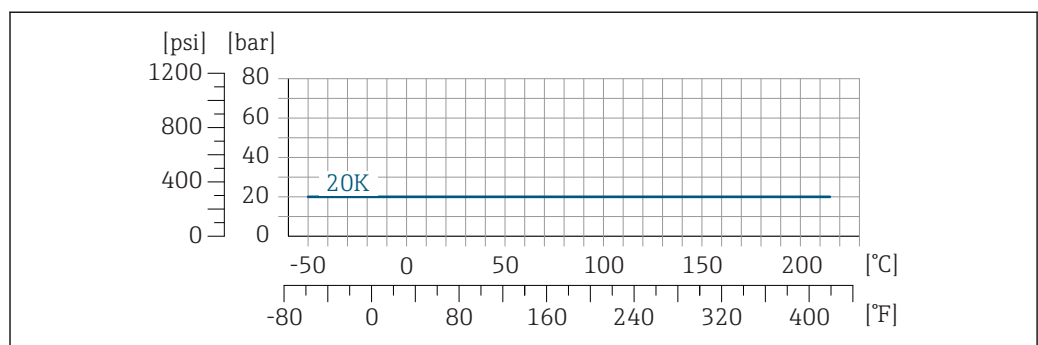

A0036206-EN

21 Lap joint flange with flange material: 1.4301 (F304), wetted parts Alloy C22: 2.4602 (UNS N06022)

Tri-Clamp process connection

The clamp connections are suitable up to a maximum pressure of 40 bar (580 psi). Please observe the operating limits of the clamp and seal used as they could be under 40 bar (580 psi). The clamp and seal are not included in the scope of supply.

Process connection 4-VCO-4, NPT 1/4", G 1/4"

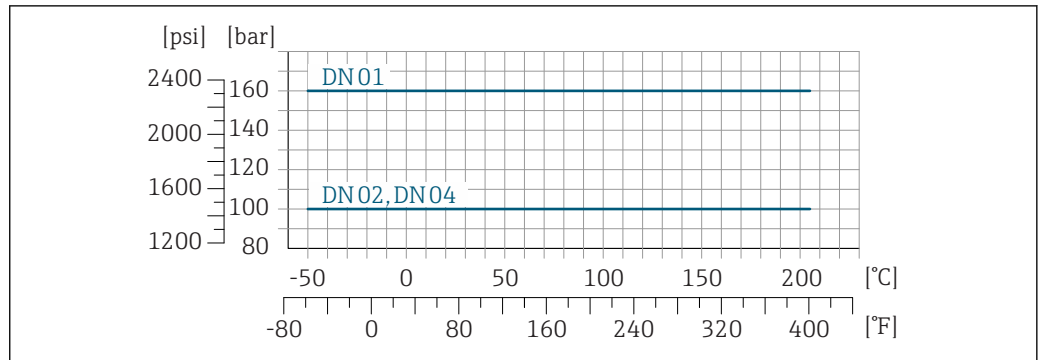

22 With flange material: 1.4404 (316/316L)

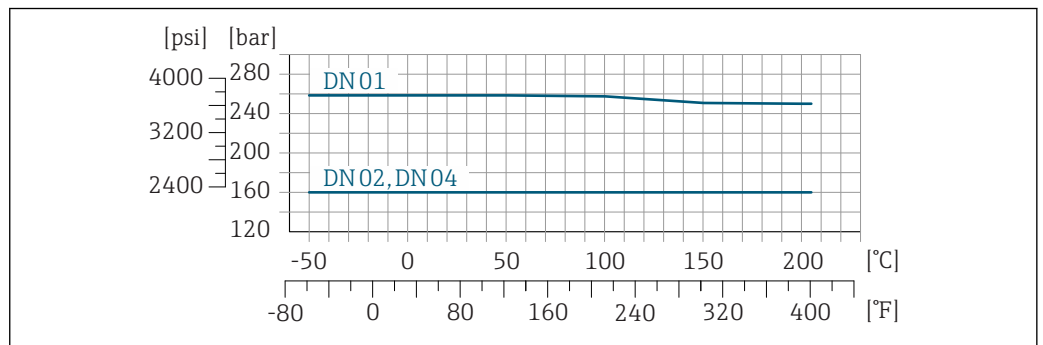

23 With flange material: Alloy C22, 2.4602 (UNS N06022)

Order code for "Measuring tube mat., wetted surface", option HB

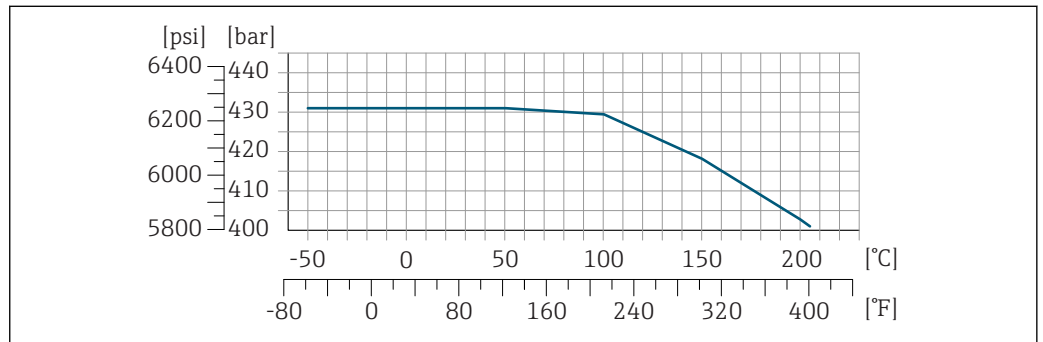

24 With flange material: Alloy C22, 2.4602 (UNS N06022)

Sensor housing

The sensor housing is filled with dry nitrogen gas and protects the electronics and mechanics inside.

i If a measuring tube fails (e.g. due to process characteristics like corrosive or abrasive fluids), the fluid will initially be contained by the sensor housing.

In the event of a tube failure, the pressure level inside the sensor housing will rise according to the operating process pressure. If the user judges that the sensor housing pressure rating/burst pressure does not provide an adequate safety margin, the device can be fitted with a rupture disk. This prevents excessively high pressure from forming inside the sensor housing. Therefore, the use of a rupture disk is strongly recommended in applications involving high gas pressures, and particularly in applications in which the process pressure is greater than 2/3 of the sensor housing burst pressure.

i High-pressure devices are always fitted with a rupture disk: order code for "Measuring tube mat., wetted surface", option HB

Sensor housing nominal pressure rating and burst pressure

If the device is fitted with a rupture disk (order code for "Sensor option", option CA "Rupture disk"), the rupture disk trigger pressure is decisive for the maximum nominal pressure.

The sensor housing burst pressure refers to a typical internal pressure which is reached prior to mechanical failure of the sensor housing and which was determined during type testing. The corresponding type test declaration can be ordered with the device (order code for "Additional approval", option LN "Sensor housing burst pressure, type test").

DN		Sensor housing nominal pressure (designed with a safety factor ≥ 4)		Sensor housing burst pressure	
[mm]	[in]	[bar]	[psi]	[bar]	[psi]
1	$\frac{1}{24}$	25	362	100	1450
2	$\frac{1}{12}$	25	362	100	1450
4	$\frac{1}{6}$	25	362	100	1450

Rupture disk

To increase the level of safety, a device version with a rupture disk with a trigger pressure of 10 to 15 bar (145 to 217.5 psi) can be used (order code for "Sensor option", option CA "rupture disk").

 High-pressure devices are always fitted with a rupture disk: order code for "Measuring tube mat., wetted surface", option HB

Flow limit



Select the nominal diameter by optimizing between the required flow range and permissible pressure loss.

 For an overview of the full scale values for the measuring range, see the "Measuring range" section →  9

- The minimum recommended full scale value is approx. 1/20 of the maximum full scale value
- In most applications, 20 to 50 % of the maximum full scale value can be considered ideal
- A low full scale value must be selected for abrasive media (such as liquids with entrained solids): flow velocity < 1 m/s (< 3 ft/s).
- For gas measurement the following rules apply:
 - The flow velocity in the measuring tubes should not exceed half the sound velocity (0.5 Mach).
 - The maximum mass flow depends on the density of the gas: formula →  9

 To calculate the flow limit, use the *Applicator* sizing tool →  75

Pressure loss

 To calculate the pressure loss, use the *Applicator* sizing tool →  75

System pressure

It is important that cavitation does not occur, or that gases entrained in the liquids do not outgas. This is prevented by means of a sufficiently high system pressure.

For this reason, the following mounting locations are recommended:

- At the lowest point in a vertical pipe
- Downstream from pumps (no danger of vacuum)

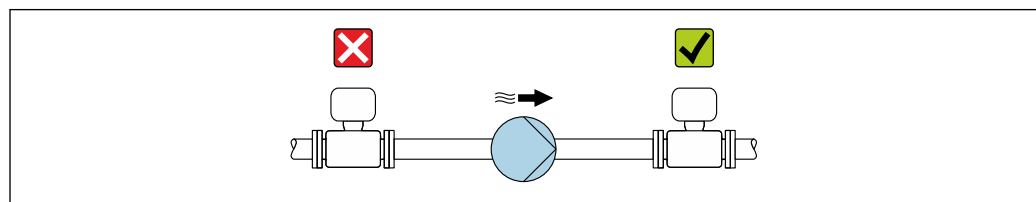

A0028777

Thermal insulation

In the case of some fluids, it is important to keep the heat radiated from the sensor to the transmitter to a low level. A wide range of materials can be used for the required insulation.

NOTICE

Electronics overheating on account of thermal insulation!

- ▶ Recommended orientation: horizontal orientation, transmitter housing pointing downwards.
- ▶ Do not insulate the transmitter housing .
- ▶ Maximum permissible temperature at the lower end of the transmitter housing: 80 °C (176 °F)
- ▶ Thermal insulation with extended neck free: the insulation is omitted around the extended neck. We recommend that you do not insulate the extended neck in order to ensure optimum dissipation of heat.

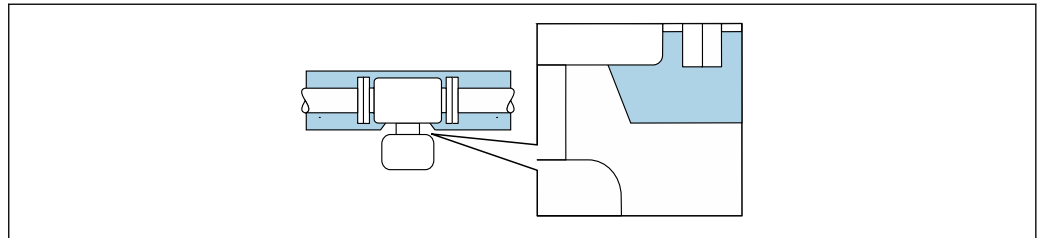

A0034391

25 Thermal insulation with extended neck free

Heating

Some fluids require suitable measures to avoid loss of heat at the sensor.

Heating options

- Electrical heating, e.g. with electric band heaters
- Via pipes carrying hot water or steam
- Via heating jackets

i Heating jackets for the sensors can be ordered as accessories from Endress+Hauser . → 74

NOTICE

Danger of overheating when heating

- ▶ Ensure that the temperature at the lower end of the transmitter housing does not exceed 80 °C (176 °F).
- ▶ Ensure that sufficient convection takes place at the transmitter neck.
- ▶ Ensure that a sufficiently large area of the transmitted neck remains exposed. The uncovered part serves as a radiator and protects the electronics from overheating and excessive cooling.

Vibrations

The high oscillation frequency of the measuring tubes ensures that the correct operation of the measuring system is not influenced by plant vibrations.

Mechanical construction

Dimensions in SI units

Compact version

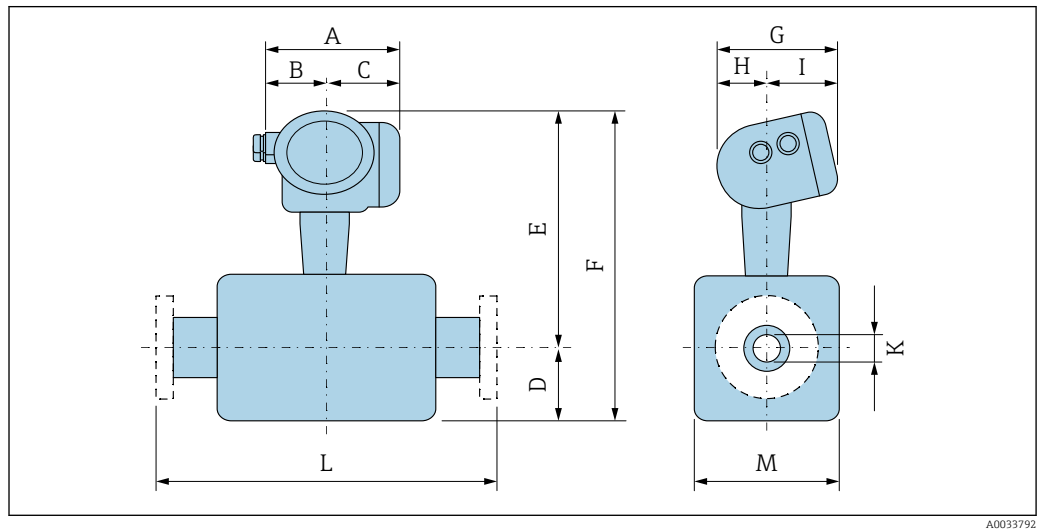

A0033792

Dimensions for version without overvoltage protection

Order code for "Housing", options B "GT18 dual compartment, 316L", C "GT20 dual compartment aluminum coated"

DN [mm]	A ¹⁾ [mm]	B [mm]	C ¹⁾ [mm]	D [mm]	E ²⁾ [mm]	F ²⁾ [mm]	G ³⁾ [mm]	H ³⁾ [mm]	I [mm]	K [mm]	L [mm]	M [mm]
1	165	75	90	54	279	333	162	102	60	9.1	⁴⁾	34
2	165	75	90	74	301	375	162	102	60	9.1	⁴⁾	48
4	165	75	90	90	316	406	162	102	60	9.1	⁴⁾	51

- 1) For versions with overvoltage protection (OVP): values + 8 mm
- 2) For version without local display: values - 3 mm
- 3) For version without local display: values - 7 mm
- 4) Dependent on the respective process connection

Threaded glands

VCO coupling

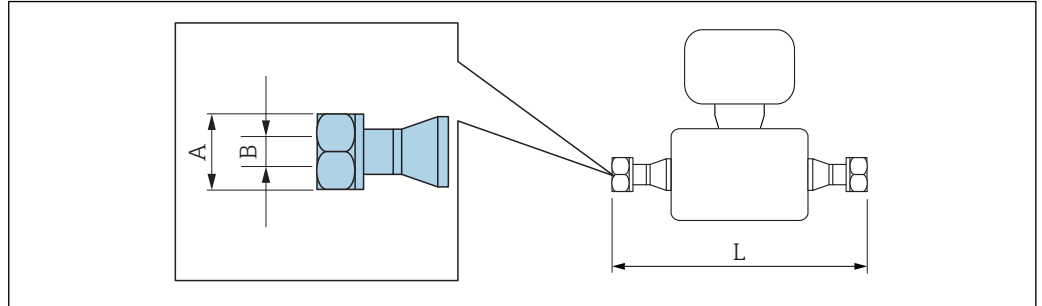

A0015624

i Length tolerance for dimension L in mm:
+1.5 / -2.0

4-VCO-4

Order code for "Process connection", option HAW

1.4435 (316/316L): order code for "Measuring tube mat., wetted surface", option BB, BF, SA

Alloy C22: order code for "Measuring tube mat., wetted surface", option HA

Alloy C22, high pressure: order code for "Measuring tube mat., wetted surface", option HB

DN [mm]	A [in]	B [mm]		L [mm]
		Option BB, BF, HA, SA	Option HB	
1	AF 1 ¹ / ₁₆	1.1	1	187
2	AF 1 ¹ / ₁₆	2.5	2.1	264
4	AF 1 ¹ / ₁₆	3.9	3.2	310

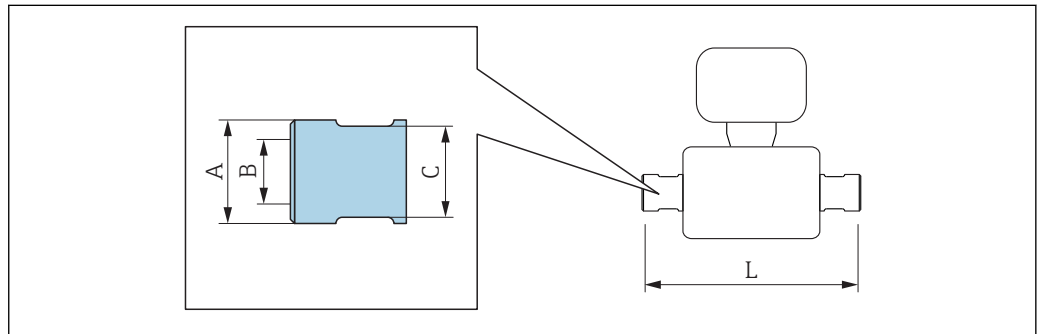

A0036429

G 1/4 "

Order code for "Process connection", option G06

1.4404 (316L): order code for "Measuring tube mat., wetted surface", option SA

Alloy C22: order code for "Measuring tube mat., wetted surface", option HA

Alloy C22, high pressure: order code for "Measuring tube mat., wetted surface", option HB

DN [mm]	A [mm]		B [in]	C [mm]	L [mm]
	Option HA, SA	Option HB			
1	22.5	25	G 1/4 "	AF 21	257
2	22.5	25	G 1/4 "	AF 21	334
4	22.5	25	G 1/4 "	AF 21	380

NPT 1/4 "					
Order code for "Process connection", option P06					
1.4404 (316L): order code for "Measuring tube mat., wetted surface", option SA					
Alloy C22: order code for "Measuring tube mat., wetted surface", option HA					
Alloy C22, high pressure: order code for "Measuring tube mat., wetted surface", option HB					
DN [mm]	A [mm]		B [in]	C [mm]	L [mm]
	Option HA, SA	Option HB			
1	22.5	25	NPT 1/4 "	AF 19	257
2	22.5	25	NPT 1/4 "	AF 19	334
4	22.5	25	NPT 1/4 "	AF 19	380

Clamp connections

Tri-Clamp

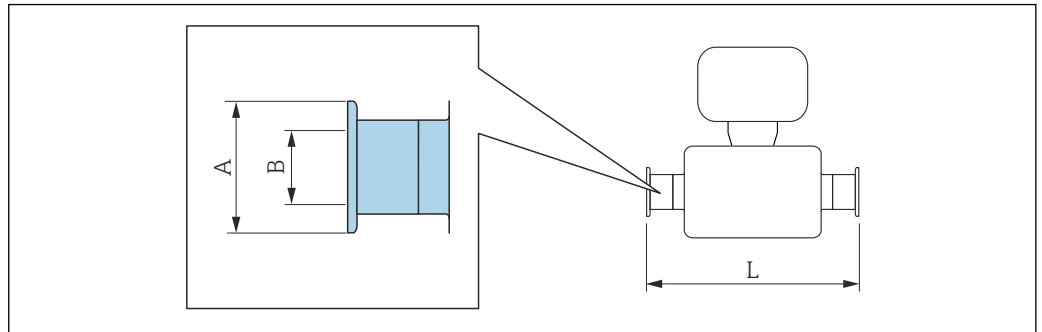

A0015625

 Length tolerance for dimension L in mm:
+1.5 / -2.0

½" Tri-Clamp Order code for "Process connection", option FBW 1.4435 (316L): order code for "Measuring tube mat., wetted surface", option BB, BF, SA			
DN [mm]	A [mm]	B [mm]	L [mm]
1	25	9.5	193
2	25	9.5	270
4	25	9.5	316

3-A version ($Ra \leq 0.76 \mu\text{m}/30 \mu\text{in}$, $Ra \leq 0.38 \mu\text{m}/15 \mu\text{in}$) available:
 Order code for "Measuring tube mat., wetted surface", option BB, BF in conjunction with order code for "Additional approval" . option LP

Flange connections

Fixed flange EN 1092-1, ASME B16.5, JIS B2220

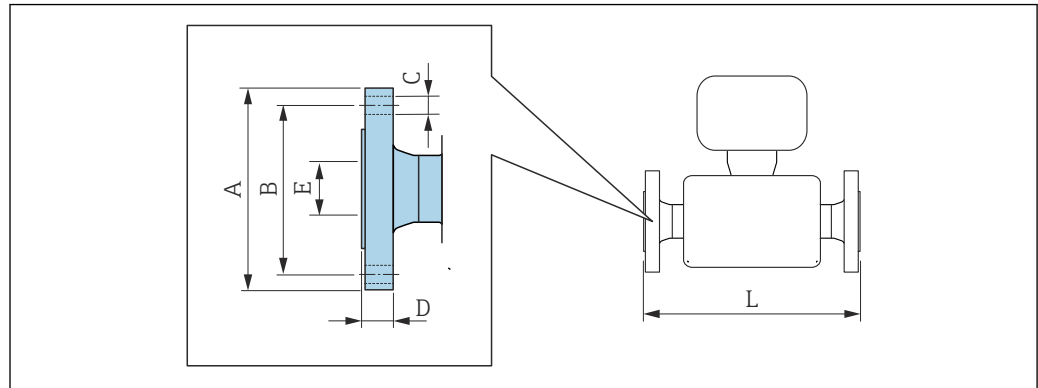

A0015621

i Length tolerance for dimension L in mm:
+1.5 / -2.0

Flange according to EN 1092-1 (DIN 2501 / DIN 2512N), PN 40
1.4404 (F316/F316L): order code for "Process connection", option D2S
Alloy C22: order code for "Process connection", option D2C

Flange with groove according to EN 1092-1 Form D (DIN 2512N), PN 40
1.4404 (F316/F316L): order code for "Process connection", option D6S
Alloy C22: order code for "Process connection", option D6C

DN [mm]	A [mm]	B [mm]	C [mm]	D [mm]	E [mm]	L [mm]
1	95	65	4 × Ø14	16	17.3	262
2	95	65	4 × Ø14	16	17.3	339
4	95	65	4 × Ø14	16	17.3	385

Surface roughness (flange): EN 1092-1 Form B1 (DIN 2526 Form C), Ra 3.2 to 12.5 µm

Flange according to EN 1092-1 (DIN 2501 / DIN 2512N), PN 100
1.4404 (F316/F316L): order code for "Process connection", option D4S
Alloy C22: order code for "Process connection", option D4C

Flange with groove according to EN 1092-1 Form D (DIN 2512N), PN 100
1.4404 (F316/F316L): order code for "Process connection", option D8S
Alloy C22: order code for "Process connection", option D8C

DN [mm]	A [mm]	B [mm]	C [mm]	D [mm]	E [mm]	L [mm]
1	105	75	4 × Ø14	20	17.3	292
2	105	75	4 × Ø14	20	17.3	369
4	105	75	4 × Ø14	20	17.3	415

Surface roughness (flange): EN 1092-1 Form B1 (DIN 2526 Form C), Ra 3.2 to 12.5 µm

Flange according to EN 1092-1 (DIN 2501 / DIN 2512N), PN 400
1.4404 (F316/F316L): order code for "Process connection", option DNS
Alloy C22: order code for "Process connection", option DNC

Flange with groove according to EN 1092-1 Form D (DIN 2512N), PN 400
1.4404 (F316/F316L): order code for "Process connection", option DPS
Alloy C22: order code for "Process connection", option DPC

DN [mm]	A [mm]	B [mm]	C [mm]	D [mm]	E [mm]	L [mm]
1	145	100	4 × Ø22	30	17.3	336
2	145	100	4 × Ø22	30	17.3	413
4	145	100	4 × Ø22	30	17.3	459

Surface roughness (flange): EN 1092-1 Form B1 (DIN 2526 Form C), Ra 3.2 to 12.5 µm

Flange according to ASME B16.5, Class 150 RF, Schedule 40
1.4404 (F316/F316L): order code for "Process connection", option AAS
Alloy C22: order code for "Process connection", option AAC

DN [mm]	A [mm]	B [mm]	C [mm]	D [mm]	E [mm]	L [mm]
1	90	60.3	4 × Ø15.9	11.6	15.7	262
2	90	60.3	4 × Ø15.9	11.6	15.7	339
4	90	60.3	4 × Ø15.9	11.6	15.7	385

Surface roughness (flange): Ra 3.2 to 6.3 µm

Flange according to ASME B16.5, Class 300 RF, Schedule 40
1.4404 (F316/F316L): order code for "Process connection", option ABS
Alloy C22: order code for "Process connection", option ABC

DN [mm]	A [mm]	B [mm]	C [mm]	D [mm]	E [mm]	L [mm]
1	95	66.7	4 × Ø15.9	14.7	15.7	262
2	95	66.7	4 × Ø15.9	14.7	15.7	339
4	95	66.7	4 × Ø15.9	14.7	15.7	385

Surface roughness (flange): Ra 3.2 to 6.3 µm

Flange according to ASME B16.5, Class 600 RF, Schedule 80
1.4404 (F316/F316L): order code for "Process connection", option ACS
Alloy C22: order code for "Process connection", option ACC

DN [mm]	A [mm]	B [mm]	C [mm]	D [mm]	E [mm]	L [mm]
1	95	66.7	4 × Ø15.9	21.3	13.9	292
2	95	66.7	4 × Ø15.9	21.3	13.9	369
4	95	66.7	4 × Ø15.9	21.3	13.9	415

Surface roughness (flange): Ra 3.2 to 6.3 µm

Flange according to ASME B16.5, Class 900/1500 RF, Schedule 80 1.4404 (F316/F316L): order code for "Process connection", option ARS Alloy C22: order code for "Process connection", option ARC						
Flange according to ASME B16.5, Class 900/1500 RTJ, Schedule 80 1.4404 (F316/F316L): order code for "Process connection", option ASS Alloy C22: order code for "Process connection", option ASC						
DN [mm]	A [mm]	B [mm]	C [mm]	D [mm]	E [mm]	L [mm]
1	120	82.6	4 × Ø22 ¹⁾	29.3	14	324
2	120	82.6	4 × Ø22 ¹⁾	29.3	14	401
4	120	82.6	4 × Ø22 ¹⁾	29.3	14	447
Surface roughness (flange): Ra 3.2 to 6.3 µm						

1) option ARC/ARS: 4 × Ø22.2

Flange according to ASME B16.5, Class 2500 RF, Schedule 80 1.4404 (F316/F316L): order code for "Process connection", option ATS Alloy C22: order code for "Process connection", option ATC						
Flange according to ASME B16.5, Class 2500 RTJ, Schedule 80 1.4404 (F316/F316L): order code for "Process connection", option AUS Alloy C22: order code for "Process connection", option AUC						
DN [mm]	A [mm]	B [mm]	C [mm]	D [mm]	E [mm]	L [mm]
1	135	88.9	4 × Ø22.2	37.2	14	351
2	135	88.9	4 × Ø22.2	37.2	14	428
4	135	88.9	4 × Ø22.2	37.2	14	474
Surface roughness (flange): Ra 3.2 to 6.3 µm						

Flange JIS B2220, 20K 1.4404 (F316/F316L): order code for "Process connection", option NES Alloy C22: order code for "Process connection", option NEC						
DN [mm]	A [mm]	B [mm]	C [mm]	D [mm]	E [mm]	L [mm]
1	95	70	4 × Ø15	14	15	262
2	95	70	4 × Ø15	14	15	339
4	95	70	4 × Ø15	14	15	385
Surface roughness (flange): Ra 3.2 to 6.3 µm						

Flange JIS B2220, 40K 1.4404 (F316/F316L): order code for "Process connection", option NGS Alloy C22: order code for "Process connection", option NGC						
DN [mm]	A [mm]	B [mm]	C [mm]	D [mm]	E [mm]	L [mm]
1	115	80	4 × Ø19	20	15	292
2	115	80	4 × Ø19	20	15	369
4	115	80	4 × Ø19	20	15	415
Surface roughness (flange): Ra 3.2 to 6.3 µm						

Flange JIS B2220, 63K 1.4404 (F316/F316L): order code for "Process connection", option NHS Alloy C22: order code for "Process connection", option NHC						
DN [mm]	A [mm]	B [mm]	C [mm]	D [mm]	E [mm]	L [mm]
1	120	85	4 × Ø19	23	12	312
2	120	85	4 × Ø19	23	12	389
4	120	85	4 × Ø19	23	12	435
Surface roughness (flange): Ra 3.2 to 6.3 µm						

Lap joint flange EN 1092-1, ASME B16.5, JIS B2220

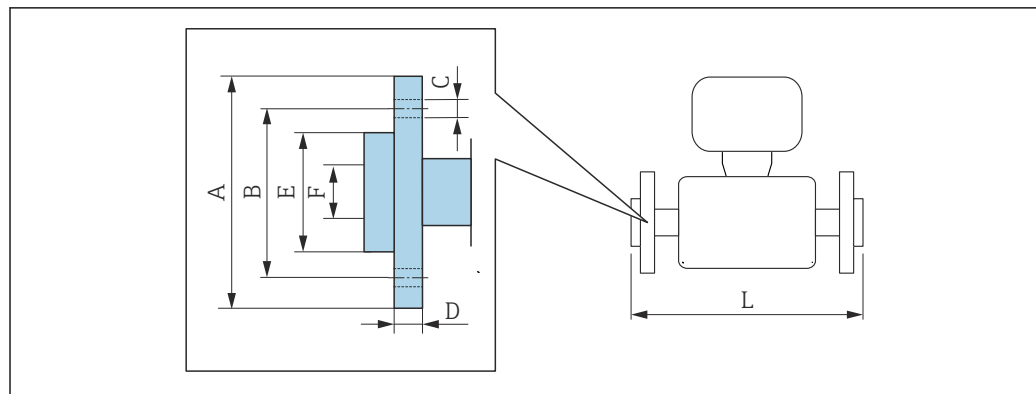

A002221

i Length tolerance for dimension L in mm:
+1.5 / -2.0

Lap joint flange according to EN 1092-1 Form D: PN 40 1.4301 (F304), wetted parts Alloy C22: order code for "Process connection", option DAC							
DN [mm]	A [mm]	B [mm]	C [mm]	D [mm]	E [mm]	F [mm]	L [mm]
1	95	65	4 × Ø14	14.5	45	17.3	262
2	95	65	4 × Ø14	14.5	45	17.3	339
4	95	65	4 × Ø14	14.5	45	17.3	385

Surface roughness (flange): Ra 3.2 to 12.5 µm

Lap joint flange according to ASME B16.5: Class 150, Schedule 40 1.4301 (F304), wetted parts Alloy C22: order code for "Process connection", option ADC							
DN [mm]	A [mm]	B [mm]	C [mm]	D [mm]	E [mm]	F [mm]	L [mm]
1	90	60.3	4 × Ø15.9	15	35.1	15.7	262
2	90	60.3	4 × Ø15.9	15	35.1	15.7	339
4	90	60.3	4 × Ø15.9	15	35.1	15.7	385

Surface roughness (flange): Ra 3.2 to 12.5 µm

Lap joint flange according to ASME B16.5: Class 300, Schedule 40 1.4301 (F304), wetted parts Alloy C22: order code for "Process connection", option AEC								
DN [mm]	A [mm]	B [mm]	C [mm]	D [mm]	E [mm]	F [mm]	L [mm]	L _{diff} ¹⁾ [mm]
1	95	66.7	4 × Ø15.9	16.5	35.1	15.7	268	+6
2	95	66.7	4 × Ø15.9	16.5	35.1	15.7	245	+6
4	95	66.7	4 × Ø15.9	16.5	35.1	15.7	391	+6

Surface roughness (flange): Ra 3.2 to 12.5 µm

1) Difference to installation length of the welding neck flange (order code for "Process connection", option AAC)

Lap joint flange according to ASME B16.5: Class 600, Schedule 80
1.4301 (F304), wetted parts Alloy C22: order code for "Process connection", option AFC

DN [mm]	A [mm]	B [mm]	C [mm]	D [mm]	E [mm]	F [mm]	L [mm]
1	95	66.7	4 × Ø15.9	17	35.1	13.9	292
2	95	66.7	4 × Ø15.9	17	35.1	13.9	369
4	95	66.7	4 × Ø15.9	17	35.1	13.9	415

Surface roughness (flange): Ra 3.2 to 12.5 µm

Lap joint flange JIS B2220: 20K
1.4301 (F304), wetted parts Alloy C22: order code for "Process connection", option NIC

DN [mm]	A [mm]	B [mm]	C [mm]	D [mm]	E [mm]	F [mm]	L [mm]
1	95	70	4 × Ø15	14	51	15	262
2	95	70	4 × Ø15	14	51	15	339
4	95	70	4 × Ø15	14	51	15	385

Surface roughness (flange): Ra 3.2 to 12.5 µm

Accessories

Sensor holder

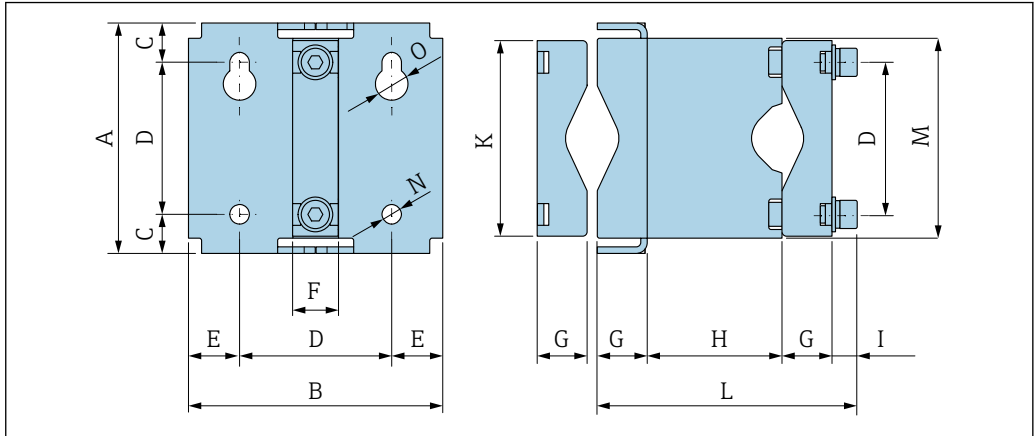

A0036633

A [mm]	B [mm]	C [mm]	D [mm]	E [mm]	F [mm]	G [mm]
106	117	18	70	23.5	21	23

H [mm]	I [mm]	K [mm]	L [mm]	M [mm]	N [mm]	O [mm]
62	12	90	120	92	9	15

Dimensions in US units

Compact version

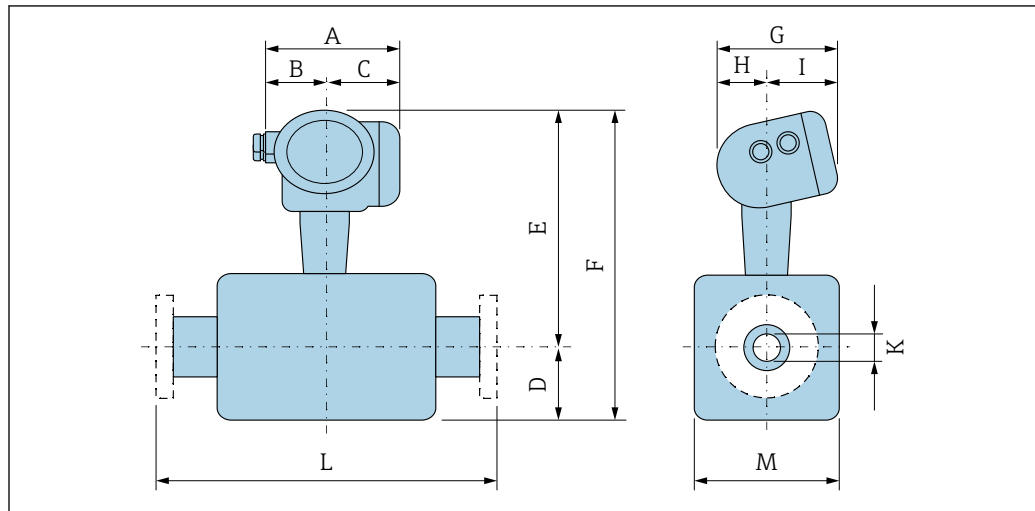

A0033792

Dimensions for version without overvoltage protection

Order code for "Housing", options B "GT18 dual compartment, 316L", C "GT20 dual compartment aluminum coated"

DN [in]	A ¹⁾ [in]	B [in]	C ¹⁾ [in]	D [in]	E ²⁾ [in]	F ²⁾ [mm]	G ³⁾ [in]	H ³⁾ [in]	I [in]	K [in]	L [in]	M [in]
1/24	6.5	2.95	3.54	2.13	10.98	13.11	6.38	4.02	2.36	0.36	⁴⁾	1.34
1/12	6.5	2.95	3.54	2.91	11.85	14.76	6.38	4.02	2.36	0.36	⁴⁾	1.89
1/8	6.5	2.95	3.54	3.54	12.44	15.98	6.38	4.02	2.36	0.36	⁴⁾	2.01

- 1) For versions with overvoltage protection (OVP): values + 0.31 in
- 2) For version without local display: values - 0.11 in
- 3) For version without local display: values - 0.28 in
- 4) Dependent on the respective process connection

Threaded glands

VCO coupling

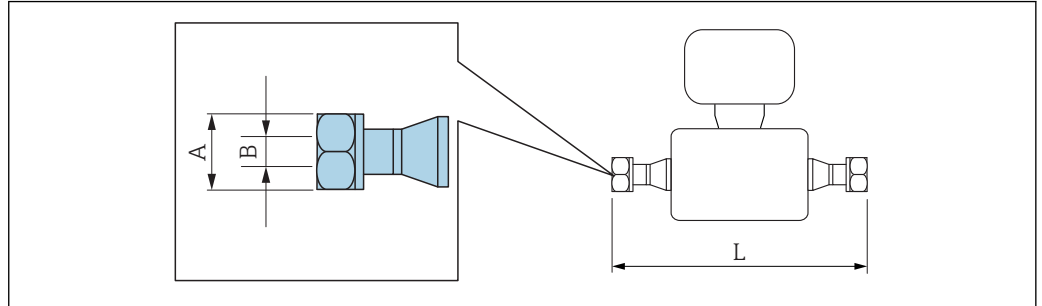

A0015624

i Length tolerance for dimension L in inch:
+0.06 / -0.08

4-VCO-4
 Order code for "Process connection", option HAW
 1.4435 (316/316L): order code for "Measuring tube mat., wetted surface", option BB, BF, SA
 Alloy C22: order code for "Measuring tube mat., wetted surface", option HA
 Alloy C22, high pressure: order code for "Measuring tube mat., wetted surface", option HB

DN [in]	A [in]	B [in]		L [in]
		Option BB, BF, HA, SA	Option HB	
1/24	AF 11/16	0.04	0.04	7.36
1/12	AF 11/16	0.1	0.08	10.39
1/8	AF 11/16	0.15	0.13	12.2

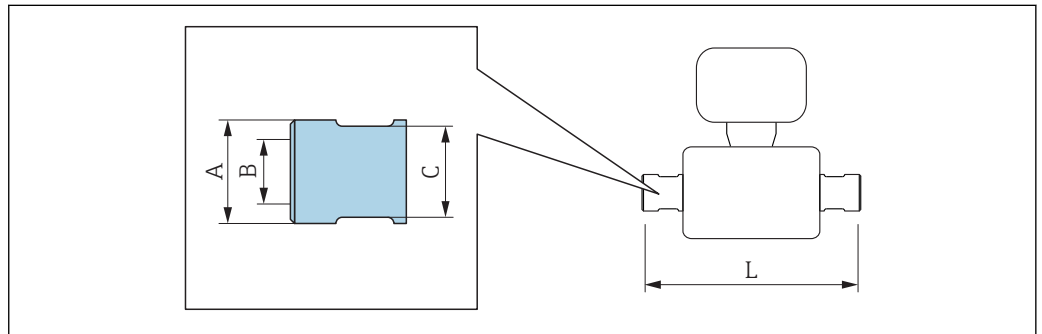

A0036429

G 1/4 "
 Order code for "Process connection", option G06
 1.4404 (316L): order code for "Measuring tube mat., wetted surface", option SA
 Alloy C22: order code for "Measuring tube mat., wetted surface", option HA
 Alloy C22, high pressure: order code for "Measuring tube mat., wetted surface", option HB

DN [in]	A [in]		B [in]	C [in]	L [in]
	Option HA, SA	Option HB			
1/24	0.89	0.98	G 1/4 "	AF 13/16 "	10.12
1/12	0.89	0.98	G 1/4 "	AF 13/16 "	13.15
1/8	0.89	0.98	G 1/4 "	AF 13/16 "	14.96

NPT 1/4 "					
Order code for "Process connection", option P06					
1.4404 (316L): order code for "Measuring tube mat., wetted surface", option SA					
Alloy C22: order code for "Measuring tube mat., wetted surface", option HA					
Alloy C22, high pressure: order code for "Measuring tube mat., wetted surface", option HB					
DN [in]	A [in]		B [in]	C [in]	L [in]
	Option HA, SA	Option HB			
1/24	0.89	0.98	NPT 1/4 "	AF 3/4 "	10.12
1/12	0.89	0.98	NPT 1/4 "	AF 3/4 "	13.15
1/8	0.89	0.98	NPT 1/4 "	AF 3/4 "	14.96

Clamp connections

Tri-Clamp

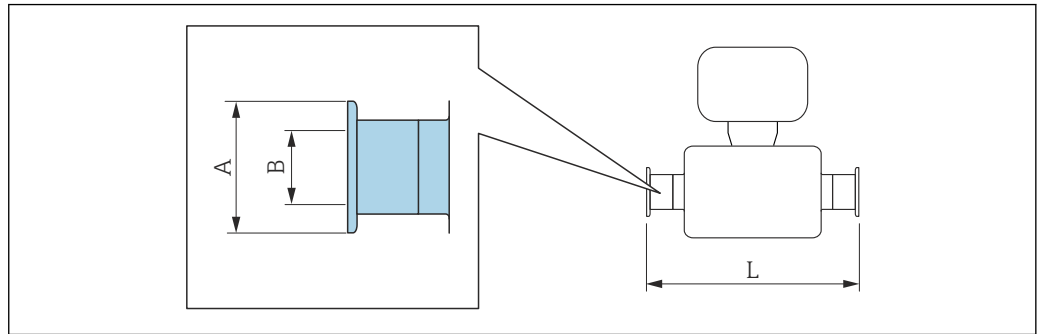

A0015625

 Length tolerance for dimension L in inch:
+0.06 / -0.08

½" Tri-Clamp Order code for "Process connection", option FBW 1.4435 (316L): order code for "Measuring tube mat., wetted surface", option BB, BF, SA			
DN [in]	A [in]	B [in]	L [in]
1/24	0.98	0.37	7.6
1/12	0.98	0.37	10.63
1/8	0.98	0.37	12.44

3-A version (Ra ≤ 0.76 µm/30 µin, Ra ≤ 0.38 µm/15 µin) available:
Order code for "Measuring tube mat., wetted surface", option BB, BF in conjunction with order code for "Additional approval" , option LP

Flange connections

Fixed flange ASME B16.5

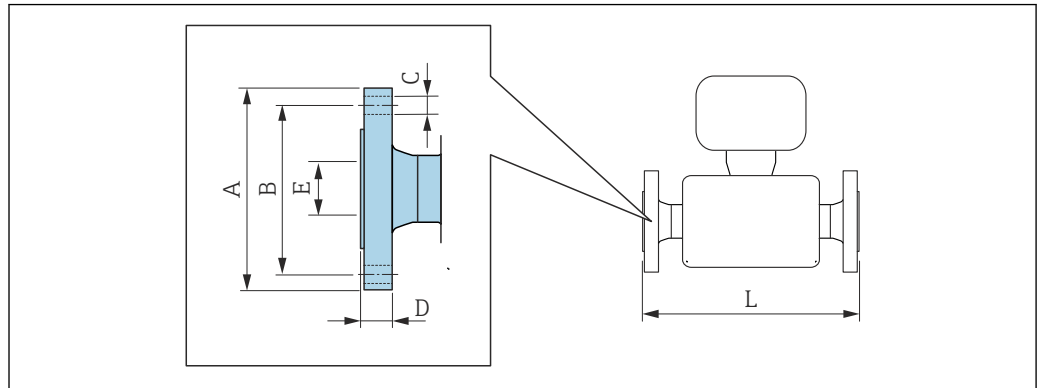

A0015621

i Length tolerance for dimension L in inch:
+0.06 / -0.08

Flange according to ASME B16.5, Class 150 RF, Schedule 40 1.4404 (F316/F316L): order code for "Process connection", option AAS Alloy C22: order code for "Process connection", option AAC						
DN [in]	A [in]	B [in]	C [in]	D [in]	E [in]	L [in]
1/24	3.54	2.37	4 × Ø0.63	0.46	0.62	10.31
1/12	3.54	2.37	4 × Ø0.63	0.46	0.62	13.35
1/8	3.54	2.37	4 × Ø0.63	0.46	0.62	15.16

Surface roughness (flange): Ra 3.2 to 6.3 µm

Flange according to ASME B16.5, Class 300 RF, Schedule 40 1.4404 (F316/F316L): order code for "Process connection", option ABS Alloy C22: order code for "Process connection", option ABC						
DN [in]	A [in]	B [in]	C [in]	D [in]	E [in]	L [in]
1/24	3.74	2.63	4 × Ø0.63	0.58	0.62	10.31
1/12	3.74	2.63	4 × Ø0.63	0.58	0.62	13.35
1/8	3.74	2.63	4 × Ø0.63	0.58	0.62	15.16

Surface roughness (flange): Ra 3.2 to 6.3 µm

Flange according to ASME B16.5, Class 600 RF, Schedule 80 1.4404 (F316/F316L): order code for "Process connection", option ACS Alloy C22: order code for "Process connection", option ACC						
DN [in]	A [in]	B [in]	C [in]	D [in]	E [in]	L [in]
1/24	3.74	2.63	4 × Ø0.63	0.84	0.55	11.5
1/12	3.74	2.63	4 × Ø0.63	0.84	0.55	14.53
1/8	3.74	2.63	4 × Ø0.63	0.84	0.55	16.34

Surface roughness (flange): Ra 3.2 to 6.3 µm

Flange according to ASME B16.5, Class 900/1500 RF, Schedule 80 1.4404 (F316/F316L): order code for "Process connection", option ARS Alloy C22: order code for "Process connection", option ARC						
Flange according to ASME B16.5, Class 900/1500 RTJ, Schedule 80 1.4404 (F316/F316L): order code for "Process connection", option ASS Alloy C22: order code for "Process connection", option ASC						
DN [in]	A [in]	B [in]	C [in]	D [in]	E [in]	L [in]
1/24	4.72	3.25	4 × Ø0.87	1.15	0.55	12.76
1/12	4.72	3.25	4 × Ø0.87	1.15	0.55	15.79
1/8	4.72	3.25	4 × Ø0.87	1.15	0.55	17.6
Surface roughness (flange): Ra 3.2 to 6.3 µm						

Flange according to ASME B16.5, Class 2500 RF, Schedule 80 1.4404 (F316/F316L): order code for "Process connection", option ATS Alloy C22: order code for "Process connection", option ATC						
Flange according to ASME B16.5, Class 2500 RTJ, Schedule 80 1.4404 (F316/F316L): order code for "Process connection", option AUS Alloy C22: order code for "Process connection", option AUC						
DN [in]	A [in]	B [in]	C [in]	D [in]	E [in]	L [in]
1/24	5.31	3.5	4 × Ø0.87	1.46	0.55	13.82
1/12	5.31	3.5	4 × Ø0.87	1.46	0.55	16.85
1/8	5.31	3.5	4 × Ø0.87	1.46	0.55	18.66
Surface roughness (flange): Ra 3.2 to 6.3 µm						

Lap joint flange ASME B16.5

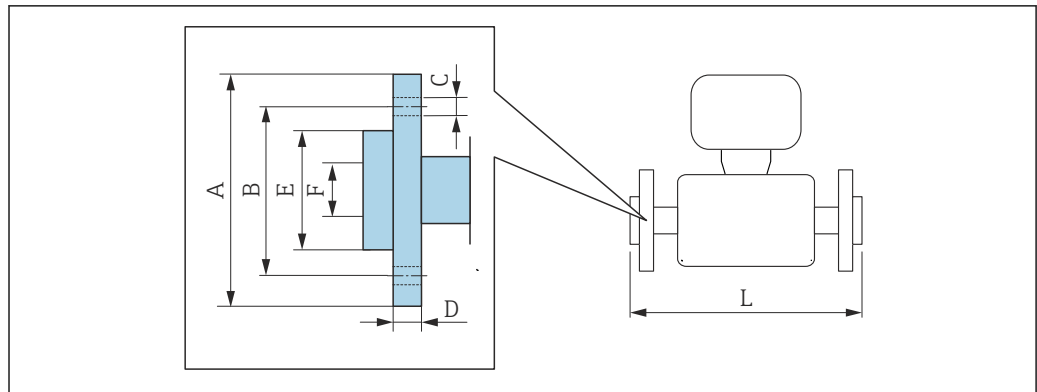

A0022221

i Length tolerance for dimension L in mm:
+1.5 / -2.0

Lap joint flange according to ASME B16.5: Class 150, Schedule 40 1.4301 (F304), wetted parts Alloy C22: order code for "Process connection", option ADC							
DN [in]	A [in]	B [in]	C [in]	D [in]	E [in]	F [in]	L [in]
1/24	3.54	2.37	4 × Ø0.63	0.59	1.65	0.62	10.31
1/12	3.54	2.37	4 × Ø0.63	0.59	1.65	0.62	13.35
1/8	3.54	2.37	4 × Ø0.63	0.59	1.65	0.62	15.16

Surface roughness (flange): Ra 3.2 to 12.5 µm

Lap joint flange according to ASME B16.5: Class 300, Schedule 40 1.4301 (F304), wetted parts Alloy C22: order code for "Process connection", option AEC								
DN [in]	A [in]	B [in]	C [in]	D [in]	E [in]	F [in]	L [in]	L _{diff} ¹⁾ [in]
1/24	3.74	2.63	4 × Ø0.63	0.65	1.77	0.62	10.55	0.24
1/12	3.74	2.63	4 × Ø0.63	0.65	1.77	0.62	9.65	0.24
1/8	3.74	2.63	4 × Ø0.63	0.65	1.77	0.62	15.39	0.24

Surface roughness (flange): Ra 3.2 to 12.5 µm

1) Difference to installation length of the welding neck flange (order code for "Process connection", option AAC)

Lap joint flange according to ASME B16.5: Class 600, Schedule 80 1.4301 (F304), wetted parts Alloy C22: order code for "Process connection", option AFC							
DN [in]	A [in]	B [in]	C [in]	D [in]	E [in]	F [in]	L [in]
1/24	3.74	2.63	4 × Ø15.9	0.67	1.89	0.55	11.5
1/12	3.74	2.63	4 × Ø15.9	0.67	1.89	0.55	14.53
1/8	3.74	2.63	4 × Ø15.9	0.67	1.89	0.55	16.34

Surface roughness (flange): Ra 3.2 to 12.5 µm

Accessories

Sensor holder

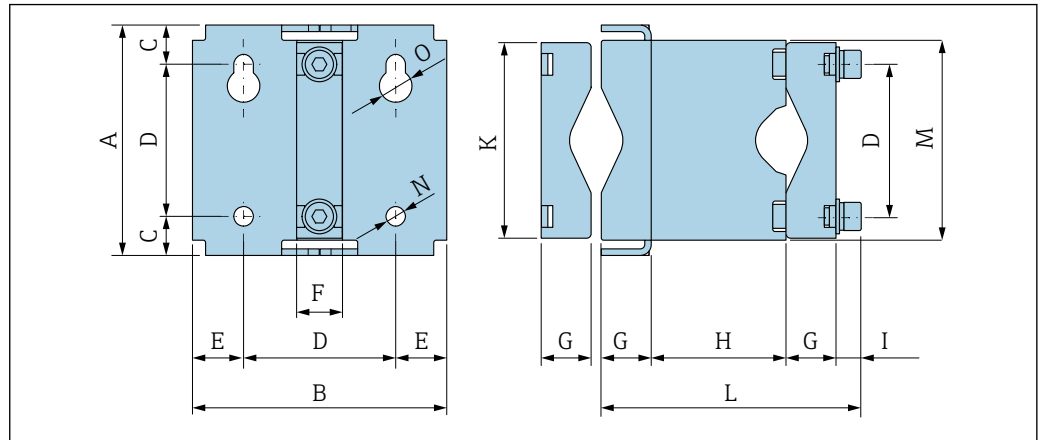

A [in]	B [in]	C [in]	D [in]	E [in]	F [in]	G [in]
4.17	4.6	0.7	2.4	0.9	0.83	0.9

H [in]	I [in]	K [in]	L [in]	M [in]	N [in]	O [in]
2.4	0.5	3.54	4.7	3.6	0.35	0.6

Weight

All values (weight exclusive of packaging material) refer to devices with EN/DIN PN 40 flanges.

Weight in SI units

DN [mm]	Weight [kg]	
	Order code for "Housing", option C "GT20 dual compartment, aluminum, coated, compact"	Order code for "Housing", option B "GT18 dual compartment, 316L, compact"
1	5.5	8.2
2	7.1	9.8
4	9	11.7

Weight in US units

DN [in]	Weight [lbs]	
	Order code for "Housing", option C "GT20 dual compartment, aluminum, coated, compact"	Order code for "Housing", option B "GT18 dual compartment, 316L, compact"
1/24	12	18
1/12	16	22
1/8	20	26

Materials

Transmitter housing

- Order code for "Housing", option B "Compact, stainless":
Stainless steel CF-3M (316L, 1.4404)
- Order code for "Housing", option C "Compact, aluminum coated":
Aluminum, AlSi10Mg, coated
- Window material: glass

Cable entries/cable glands

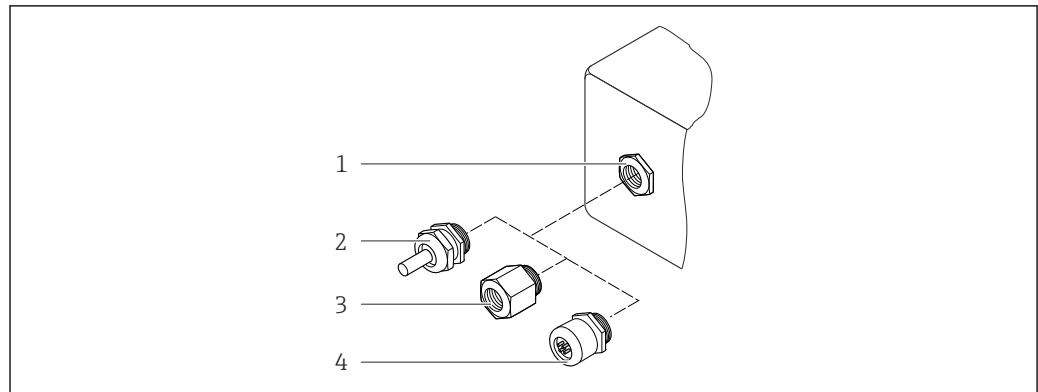

A0028352

26 Possible cable entries/cable glands

- 1 Female thread M20 × 1.5
- 2 Cable gland M20 × 1.5
- 3 Adapter for cable entry with internal thread G ½" or NPT ½"
- 4 Device plugs

Order code for "Housing", option B "GT18 dual compartment, 316L"

Cable entry/cable gland	Type of protection	Material
Cable gland M20 × 1.5	<ul style="list-style-type: none"> ■ Non-Ex ■ Ex ia ■ Ex ic ■ Ex nA ■ Ex tb 	Stainless steel ,1.4404
Adapter for cable entry with internal thread G ½"	For non-Ex and Ex (except for CSA Ex d/XP)	Stainless steel, 1.4404 (316L)
Adapter for cable entry with internal thread NPT ½"	For non-Ex and Ex	

Order code for "Housing", option C "GT20 dual compartment, aluminum coated"

Cable entry/cable gland	Type of protection	Material
Cable gland M20 × 1.5	<ul style="list-style-type: none"> ■ Non-Ex ■ Ex ia ■ Ex ic 	Plastic
	Adapter for cable entry with internal thread G ½"	Nickel-plated brass
Adapter for cable entry with internal thread NPT ½"	For non-Ex and Ex (except for CSA Ex d/XP)	Nickel-plated brass
Thread NPT ½" via adapter	For non-Ex and Ex	

Device plug

Electrical connection	Material
Plug M12x1	<ul style="list-style-type: none"> ■ Socket: stainless steel, 1.4401/316 ■ Contact housing: plastic, PUR, black ■ Contacts: metal, CuZn, gold-plated ■ Threaded connection seal: NBR

Sensor housing

- Acid and alkali-resistant outer surface
- Stainless steel, 1.4404 (316L)

Measuring tubes

Order code for "Measuring tube mat., wetted surface", option BB, BF, SA

Stainless steel, 1.4435 (316/316L)

Order code for "Measuring tube mat., wetted surface", option HA, HB

Alloy C22, 2.4602 (UNS N06022)

Process connections

Order code for "Measuring tube mat., wetted surface", option SA

VCO coupling	Stainless steel, 1.4404 (316/316L)
G³/₄" internal thread	Stainless steel, 1.4404 (316/316L)
NPT¹/₄" internal thread	Stainless steel, 1.4404 (316/316L)
Tri-Clamp¹/₂"	Stainless steel, 1.4435 (316L)
Fixed flange EN 1092-1, ASME B16.5, JIS B2220	Stainless steel, 1.4404 (316/316L)

Order code for "Measuring tube mat., wetted surface", option BB, BF



Tri-Clamp¹/₂"	Stainless steel, 1.4435 (316L)
--	--------------------------------

Order code for "Measuring tube mat., wetted surface", option HA

VCO coupling	Alloy C22, 2.4602 (UNS N06022)
G³/₄" internal thread	Alloy C22, 2.4602 (UNS N06022)
NPT¹/₄" internal thread	Alloy C22, 2.4602 (UNS N06022)
Fixed flange EN 1092-1, ASME B16.5, JIS B2220	Alloy C22, 2.4602 (UNS N06022)
Lap joint flange EN 1092-1, ASME B16.5, JIS B2220	Stainless steel, 1.4301 (F304), wetted parts Alloy C22, 2.4602 (UNS N06022)

Order code for "Measuring tube mat., wetted surface", option HB (high-pressure option)

VCO coupling	Alloy C22, 2.4602 (UNS N06022)
G³/₄" internal thread	Alloy C22, 2.4602 (UNS N06022)
NPT¹/₄" internal thread	Alloy C22, 2.4602 (UNS N06022)
Fixed flange EN 1092-1, ASME B16.5, JIS B2220	Stainless steel, 1.4404 (316/316L); Alloy C22, 2.4602 (UNS N06022)

 Available process connections →  64

Seals

Welded process connections without internal seals

Accessories

Sensor holder

Stainless steel, 1.4404 (316L)

Heating jacket

- Heating jacket housing: stainless steel, 1.4571 (316Ti)
- NPT adapter ½": stainless steel, 1.4404 (316)
- G½" adapter: stainless steel, 1.4404

Protective cover

Stainless steel, 1.4404 (316L)

Remote display FHX50

Housing material:

- Plastic PBT
- Stainless steel CF-3M (316L, 1.4404)

Process connections

- Fixed flange connections:
 - EN 1092-1 (DIN 2501) flange
 - EN 1092-1 (DIN 2512N) flange
 - ASME B16.5 flange
 - JIS B2220 flange
- Clamp connections:
 - Tri-Clamp (OD tubes), DIN 11866 series C
- VCO connections:
 - 4-VCO-4
- Internal thread:
 - Cylindrical internal thread BSPP (G) in accordance with ISO 228-1 with sealing surfaces in accordance with DIN 3852-2/ISO 1179-1
 - NPT



Process connection materials → 63

Surface roughness

All data relate to parts in contact with fluid. The following surface roughness quality can be ordered.

- Not polished
- $Ra_{max} = 0.76 \mu\text{m}$ (30 μin) mechanically polished
- $Ra_{max} = 0.38 \mu\text{m}$ (15 μin) mechanically polished

Operability

Operating concept

Operator-oriented menu structure for user-specific tasks

- Commissioning
- Operation
- Diagnostics
- Expert level

Quick and safe commissioning

- Guided menus ("Make-it-run" wizards) for applications
- Menu guidance with brief explanations of the individual parameter functions

Reliable operation

- Operation in the following languages:
 - Via local display: English, German, French, Spanish, Italian, Dutch, Portuguese, Polish, Russian, Swedish, Turkish, Chinese, Japanese, Bahasa (Indonesian), Vietnamese, Czech
 - Via "FieldCare" operating tool: English, German, French, Spanish, Italian, Chinese, Japanese
- Uniform operating philosophy applied to device and operating tools
- If replacing the electronic module, transfer the device configuration via the integrated memory (integrated HistoROM) which contains the process and measuring device data and the event logbook. No need to reconfigure.

Efficient diagnostics increase measurement availability

- Troubleshooting measures can be called up via the device and in the operating tools
- Diverse simulation options, logbook for events that occur and optional line recorder functions

Languages

Can be operated in the following languages:

- Via local display: English, German, French, Spanish, Italian, Dutch, Portuguese, Polish, Russian, Swedish, Turkish, Chinese, Japanese, Bahasa (Indonesian), Vietnamese, Czech
- Via "FieldCare" operating tool: English, German, French, Spanish, Italian, Chinese, Japanese

Local operation

Via display module

Two display modules are available:

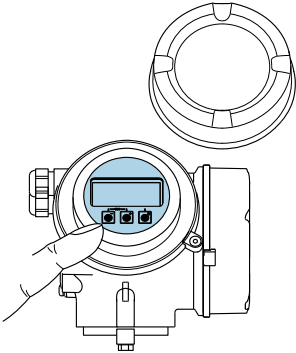
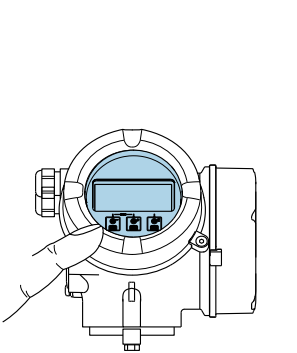
Order code for "Display; Operation", option C "SD02"	Order code for "Display; Operation", option E "SD03"
	
1 Operation with pushbuttons	1 Operation with touch control

Display elements

- 4-line, illuminated, graphic display
- White background lighting; switches to red in event of device errors
- Format for displaying measured variables and status variables can be individually configured
- Permitted ambient temperature for the display: -20 to +60 °C (-4 to +140 °F)
The readability of the display may be impaired at temperatures outside the temperature range.



Operating elements

- Operation with 3 push buttons with open housing: ⊕, ⊖, ⊞
or
- External operation via touch control (3 optical keys) without opening the housing: ⊕, ⊖, ⊞
- Operating elements also accessible in the various zones of the hazardous area

Additional functionality

- Data backup function
The device configuration can be saved in the display module.
- Data comparison function
The device configuration saved in the display module can be compared to the current device configuration.
- Data transfer function
The transmitter configuration can be transmitted to another device using the display module.

Via remote display FHX50

 The remote display FHX50 can be ordered as an optional extra →  73.

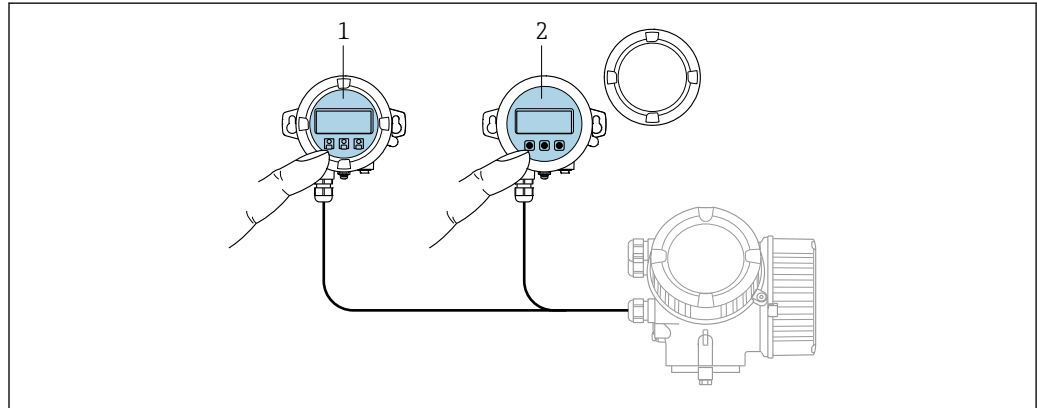

 27 *FHX50 operating options*

- 1 *SD02 display and operating module, push buttons: cover must be opened for operation*
- 2 *SD03 display and operating module, optical buttons: operation possible through cover glass*

Display and operating elements

The display and operating elements correspond to those of the display module .

Remote operation**Via HART protocol**

This communication interface is available in device versions with a HART output.

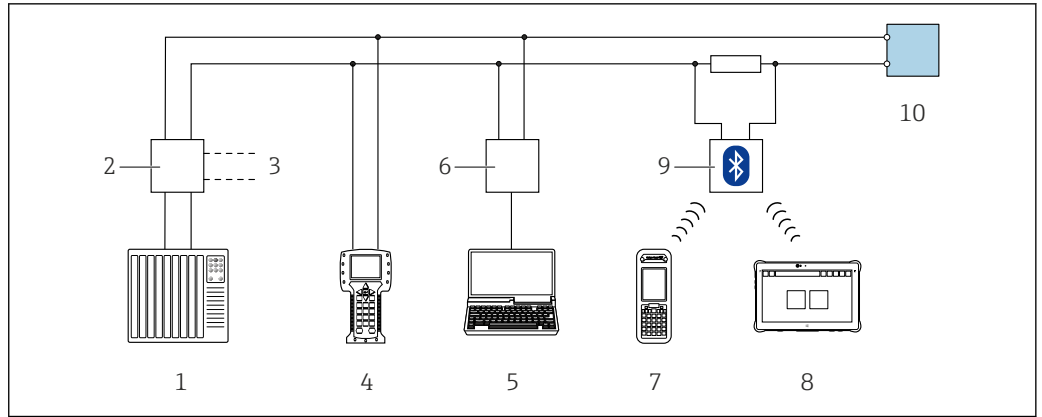

A0028746

28 Options for remote operation via HART protocol (passive)

- 1 Control system (e.g. PLC)
- 2 Transmitter power supply unit, e.g. RN221N (with communication resistor)
- 3 Connection for Commubox FXA195 and Field Communicator 475
- 4 Field Communicator 475
- 5 Computer with web browser (e.g. Internet Explorer) for accessing computers with operating tool (e.g. FieldCare, DeviceCare, AMS Device Manager, SIMATIC PDM) with COM DTM "CDI Communication TCP/IP"
- 6 Commubox FXA195 (USB)
- 7 Field Xpert SFX350 or SFX370
- 8 VIATOR Bluetooth modem with connecting cable
- 9 Transmitter

Via PROFIBUS PA network

This communication interface is available in device versions with PROFIBUS PA.

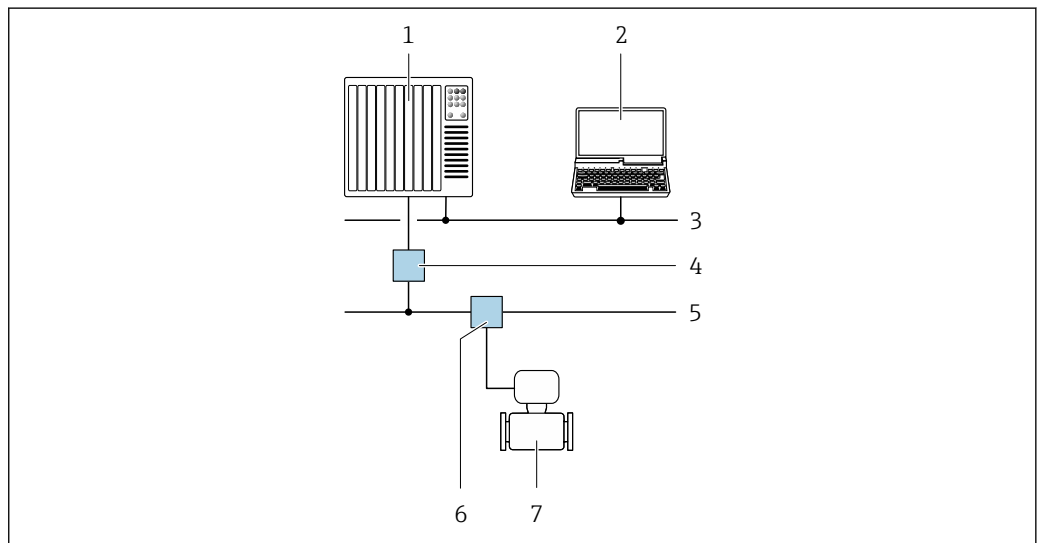

A0028838

29 Options for remote operation via PROFIBUS PA network

- 1 Automation system
- 2 Computer with PROFIBUS network card
- 3 PROFIBUS DP network
- 4 Segment coupler PROFIBUS DP/PA
- 5 PROFIBUS PA network
- 6 T-box
- 7 Measuring device

Via FOUNDATION Fieldbus network

This communication interface is available in device versions with FOUNDATION Fieldbus.

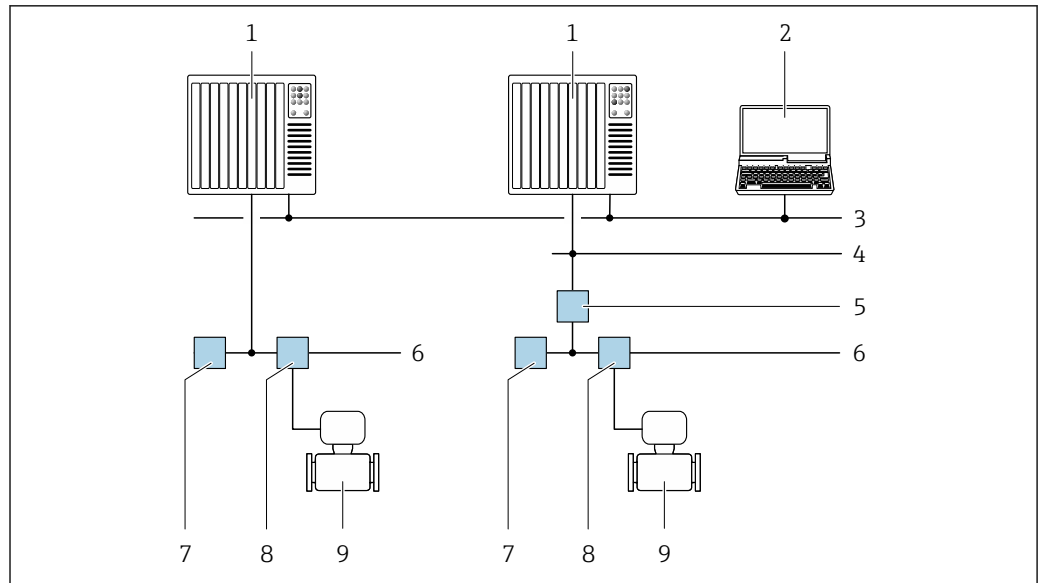

A0028837

30 Options for remote operation via FOUNDATION Fieldbus network

- 1 Automation system
- 2 Computer with FOUNDATION Fieldbus network card
- 3 Industry network
- 4 High Speed Ethernet FF-HSE network
- 5 Segment coupler FF-HSE/FF-H1
- 6 FOUNDATION Fieldbus FF-H1 network
- 7 Power supply FF-H1 network
- 8 T-box
- 9 Measuring device

Service interface

Via service interface (CDI)

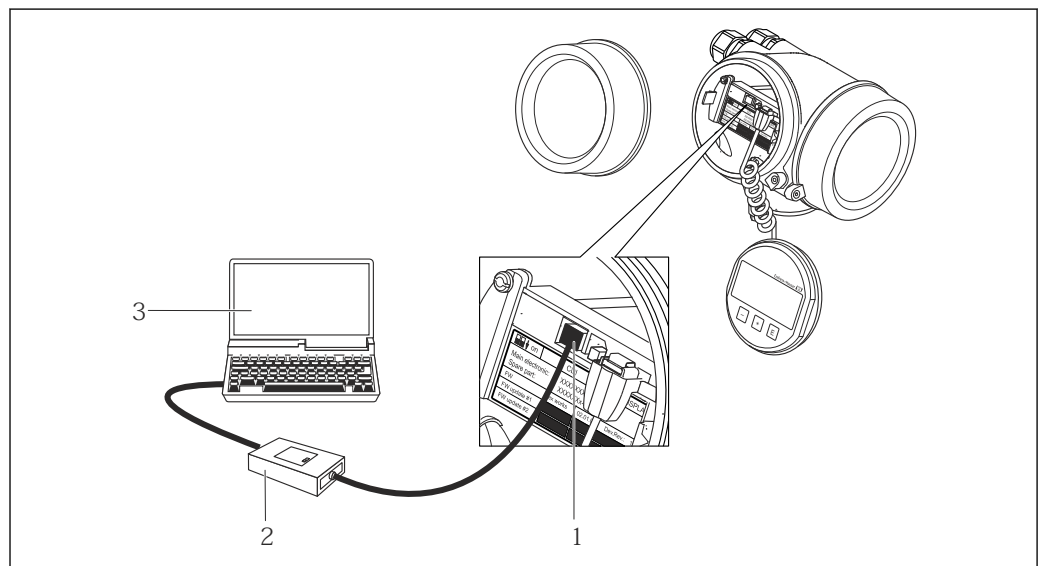



A0014019

- 1 Service interface (CDI = Endress+Hauser Common Data Interface) of the measuring device
- 2 Commubox FXA291
- 3 Computer with FieldCare operating tool with COM DTM CDI Communication FXA291

Certificates and approvals

 Currently available certificates and approvals can be called up via the product configurator.

CE mark	The device meets the legal requirements of the applicable EU Directives. These are listed in the corresponding EU Declaration of Conformity along with the standards applied. Endress+Hauser confirms successful testing of the device by affixing to it the CE mark.
C-Tick symbol	The measuring system meets the EMC requirements of the "Australian Communications and Media Authority (ACMA)".
Functional safety	The measuring device can be used for flow monitoring systems (min., max., range) up to SIL 2 (single-channel architecture; order code for "Additional approval", option LA) and SIL 3 (multichannel architecture with homogeneous redundancy) and is independently evaluated and certified by the TÜV in accordance with IEC 61508. The following types of monitoring in safety equipment are possible: <ul style="list-style-type: none"> ■ Mass flow ■ Volume flow ■ Density  Functional Safety Manual with information on the SIL device →  76

Ex approval	The measuring device is certified for use in hazardous areas and the relevant safety instructions are provided in the separate "Safety Instructions" (XA) document. Reference is made to this document on the nameplate.  The separate Ex documentation (XA) containing all the relevant explosion protection data is available from your Endress+Hauser sales center.
--------------------	--

ATEX/IECEx

Currently, the following versions for use in hazardous areas are available:

Ex d

Category (ATEX)	Type of protection
II2G	Ex d ia IIC T6...T1 Gb
II1/2G	Ex d ia IIC T6...T1 Ga/Gb ¹⁾
II1/2G, II2D	Ex d ia IIC T6...T1 Ga/Gb ¹⁾ Ex tb IIIC Txx °C Db

1) The following applies for sensors with nominal diameter DN 01: Ex db eb ia IIC T6...T1 Gb

Ex ia

Category (ATEX)	Type of protection
II2G	Ex ia IIC T6...T1 Gb
II1/2G	Ex ia IIC T6...T1 Ga/Gb ¹⁾
II1/2G, II2D	Ex ia IIC T6...T1 Ga/Gb ¹⁾ Ex tb IIIC Txx °C Db

1) The following applies for sensors with nominal diameter DN 01: Ex db eb ia IIC T6...T1 Gb

Ex nA

Category (ATEX)	Type of protection
II3G	Ex nA IIC T6...T1 Gc

Ex ic

Category (ATEX)	Type of protection
II3G	Ex ic IIC T6...T1 Gc
II1/3G	Ex ic ia IIC T6...T1 Ga/Gc

cCSA_{US}

Currently, the following versions for use in hazardous areas are available:

IS (Ex i) and XP (Ex d)

Class I, II, III Division 1 Groups ABCDEFG

NI (Ex nA, Ex nL)

- Class I Division 2 Groups ABCD
- Class II, III Division 1 Groups EFG

Sanitary compatibility

- 3-A approval
Only devices with the order code for "Additional approval", option LP "3A" have 3-A approval.
- FDA
- Food Contact Materials Regulation (EC) 1935/2004

Pharmaceutical compatibility

- FDA
- USP Class VI
- TSE/BSE Certificate of Suitability

Functional safety

The measuring device can be used for flow monitoring systems (min., max., range) up to SIL 2 (single-channel architecture; order code for "Additional approval", option LA) and SIL 3 (multichannel architecture with homogeneous redundancy) and is independently evaluated and certified by the TÜV in accordance with IEC 61508.

The following types of monitoring in safety equipment are possible:

- Mass flow
- Volume flow
- Density



Functional Safety Manual with information on the SIL device → 76

HART certification

HART interface

The measuring device is certified and registered by the FieldComm Group. The measuring system meets all the requirements of the following specifications:

- Certified according to HART 7
- The device can also be operated with certified devices of other manufacturers (interoperability)

FOUNDATION Fieldbus certification

FOUNDATION Fieldbus interface

The measuring device is certified and registered by the FieldComm Group. The measuring system meets all the requirements of the following specifications:

- Certified in accordance with FOUNDATION Fieldbus H1
- Interoperability Test Kit (ITK), revision version 6.1.1 (certificate available on request)
- Physical Layer Conformance Test
- The device can also be operated with certified devices of other manufacturers (interoperability)

Certification PROFIBUS

PROFIBUS interface

The measuring device is certified and registered by the PNO (PROFIBUS User Organization Organization). The measuring system meets all the requirements of the following specifications:

- Certified in accordance with PROFIBUS PA Profile 3.02
- The device can also be operated with certified devices of other manufacturers (interoperability)

Additional certification

CRN approval

Some device versions have CRN approval. A CRN-approved process connection with a CSA approval must be ordered for a CRN-approved device.

Tests and certificates

- Pressure test, internal procedure, inspection certificate
- EN10204-3.1 material certificate, wetted parts and sensor housing
- PMI test (XRF), internal procedure, wetted parts, test report
- NACE MR0175 / ISO 15156
- NACE MR0103 / ISO 17945

Testing of welded connections

Option	Test standard				Process connection
	ISO 10675-1 AL1	ASME B31.3 NFS	ASME VIII Div.1	NORSOK M-601	
KE	x				RT
KI		x			RT
KN			x		RT
KS				x	RT
K5	x				DR
K6		x			DR
K7			x		DR
K8				x	DR
RT = Radiographic testing, DR = Digital radiography All options with test report					

Other standards and guidelines

- EN 60529
Degrees of protection provided by enclosures (IP code)
- IEC/EN 60068-2-6
Environmental influences: Test procedure - Test Fc: vibrate (sinusoidal).
- IEC/EN 60068-2-31
Environmental influences: Test procedure - Test Ec: shocks due to rough handling, primarily for devices.
- EN 61010-1
Safety requirements for electrical equipment for measurement, control and laboratory use - general requirements
- IEC/EN 61326
Emission in accordance with Class A requirements. Electromagnetic compatibility (EMC requirements).
- IEC 61508
Functional safety of electrical/electronic/programmable electronic safety-related systems
- NAMUR NE 21
Electromagnetic compatibility (EMC) of industrial process and laboratory control equipment
- NAMUR NE 32
Data retention in the event of a power failure in field and control instruments with microprocessors
- NAMUR NE 43
Standardization of the signal level for the breakdown information of digital transmitters with analog output signal.
- NAMUR NE 53
Software of field devices and signal-processing devices with digital electronics
- NAMUR NE 105
Specifications for integrating fieldbus devices in engineering tools for field devices
- NAMUR NE 107
Self-monitoring and diagnosis of field devices
- NAMUR NE 131
Requirements for field devices for standard applications
- NAMUR NE 132
Coriolis mass meter

Ordering information

Detailed ordering information is available from the following sources:

- In the Product Configurator on the Endress+Hauser website: www.endress.com -> Click "Corporate" -> Select your country -> Click "Products" -> Select the product using the filters and search field -> Open product page -> The "Configure" button to the right of the product image opens the Product Configurator.
- From your Endress+Hauser Sales Center: www.addresses.endress.com



Product Configurator - the tool for individual product configuration

- Up-to-the-minute configuration data
- Depending on the device: Direct input of measuring point-specific information such as measuring range or operating language
- Automatic verification of exclusion criteria
- Automatic creation of the order code and its breakdown in PDF or Excel output format
- Ability to order directly in the Endress+Hauser Online Shop

Application packages

Many different application packages are available to enhance the functionality of the device. Such packages might be needed to address safety aspects or specific application requirements.

The application packages can be ordered with the device or subsequently from Endress+Hauser. Detailed information on the order code in question is available from your local Endress+Hauser sales center or on the product page of the Endress+Hauser website: www.endress.com.



Detailed information on the application packages:
Special Documentation for the device → 76

Diagnostics functions

Package	Description
Extended HistoROM	<p>Comprises extended functions concerning the event log and the activation of the measured value memory.</p> <p>Event log: Memory volume is extended from 20 message entries (standard version) to up to 100 entries.</p> <p>Data logging (line recorder):</p> <ul style="list-style-type: none"> ▪ Memory capacity for up to 1000 measured values is activated. ▪ 250 measured values can be output via each of the 4 memory channels. The recording interval can be defined and configured by the user. ▪ Measured value logs can be accessed via the local display or operating tool e.g. FieldCare, DeviceCare or Web server.

Heartbeat Technology

Package	Description
Heartbeat Verification	<p>Heartbeat Verification Meets the requirement for traceable verification to DIN ISO 9001:2008 Chapter 7.6 a) "Control of monitoring and measuring equipment".</p> <ul style="list-style-type: none"> ▪ Functional testing in the installed state without interrupting the process. ▪ Traceable verification results on request, including a report. ▪ Simple testing process via local operation or other operating interfaces. ▪ Clear measuring point assessment (pass/fail) with high test coverage within the framework of manufacturer specifications. ▪ Extension of calibration intervals according to operator's risk assessment.

Special density





Package	Description
Special density	<p>Many applications use density as a key measured value for monitoring quality or controlling processes. The device measures the density of the fluid as standard and makes this value available to the control system.</p> <p>The "Special Density" application package offers high-precision density measurement over a wide density and temperature range particularly for applications subject to varying process conditions.</p>

Accessories



Various accessories, which can be ordered with the device or subsequently from Endress+Hauser, are available for the device. Detailed information on the order code in question is available from your local Endress+Hauser sales center or on the product page of the Endress+Hauser website: www.endress.com.

Device-specific accessories









For the transmitter

Accessories	Description
Promass 200 transmitter	<p>Transmitter for replacement or storage. Use the order code to define the following specifications:</p> <ul style="list-style-type: none"> ▪ Approvals ▪ Output ▪ Display/operation ▪ Housing ▪ Software <p> Installation Instructions EA00104D</p> <p> (Order number: 8X2CXX)</p>
Remote display FHX50	<p>FHX50 housing for accommodating a display module .</p> <ul style="list-style-type: none"> ▪ FHX50 housing suitable for: <ul style="list-style-type: none"> - SD02 display module (push buttons) - SD03 display module (touch control) ▪ Length of connecting cable: up to max. 60 m (196 ft) (cable lengths available for order: 5 m (16 ft), 10 m (32 ft), 20 m (65 ft), 30 m (98 ft)) <p>The measuring device can be ordered with the FHX50 housing and a display module. The following options must be selected in the separate order codes:</p> <ul style="list-style-type: none"> ▪ Order code for measuring device, feature 030: <ul style="list-style-type: none"> Option L or M "Prepared for FHX50 display" ▪ Order code for FHX50 housing, feature 050 (device version): <ul style="list-style-type: none"> Option A "Prepared for FHX50 display" ▪ Order code for FHX50 housing, depends on the desired display module in feature 020 (display, operation): <ul style="list-style-type: none"> - Option C: for an SD02 display module (push buttons) - Option E: for an SD03 display module (touch control) <p>The FHX50 housing can also be ordered as a retrofit kit. The measuring device display module is used in the FHX50 housing. The following options must be selected in the order code for the FHX50 housing:</p> <ul style="list-style-type: none"> ▪ Feature 050 (measuring device version): option B "Not prepared for FHX50 display" ▪ Feature 020 (display, operation): option A "None, existing displayed used" <p> Special Documentation SD01007F</p> <p>(Order number: FHX50)</p>
Overvoltage protection for 2-wire devices	<p>Ideally, the overvoltage protection module should be ordered directly with the device. See product structure, feature 610 "Accessory mounted", option NA "Overvoltage protection". Separate order necessary only if retrofitting.</p> <ul style="list-style-type: none"> ▪ OVP10: For 1-channel devices (feature 020, option A): ▪ OVP20: For 2-channel devices (feature 020, options B, C, E or G) <p> Special Documentation SD01090F</p> <p>(Order number OVP10: 71128617) (Order number OVP20: 71128619)</p>
Protective cover	<p>Is used to protect the measuring device from the effects of the weather: e.g. rainwater, excess heating from direct sunlight or extreme cold in winter.</p> <p> Special Documentation SD00333F</p> <p>(Order number: 71162242)</p>



For the sensor

Accessories	Description
Heating jacket	<p>Is used to stabilize the temperature of the fluids in the sensor. Water, water vapor and other non-corrosive liquids are permitted for use as fluids.</p> <p> If using oil as a heating medium, please consult with Endress+Hauser.</p> <ul style="list-style-type: none"> ▪ If ordered together with the measuring device: order code for "Enclosed accessories" <ul style="list-style-type: none"> – Option RB "heating jacket, G 1/2" internal thread" – Option RD "Heating jacket, NPT 1/2" internal thread" ▪ If ordered subsequently: Use the order code with the product root DK8003. <p> Special Documentation SD02173D</p>
Sensor holder	<p>For wall, tabletop and pipe mounting.</p> <p> Order number: 71392563</p>





Communication-specific accessories

Accessories	Description
Commubox FXA195 HART	<p>For intrinsically safe HART communication with FieldCare via the USB interface.</p> <p> Technical Information TI00404F</p>
Commubox FXA291	<p>Connects Endress+Hauser field devices with a CDI interface (= Endress+Hauser Common Data Interface) and the USB port of a computer or laptop.</p> <p> Technical Information TI405C/07</p>
HART Loop Converter HMX50	<p>Is used to evaluate and convert dynamic HART process variables to analog current signals or limit values.</p> <p> <ul style="list-style-type: none"> ▪ Technical Information TI00429F ▪ Operating Instructions BA00371F </p>
Wireless HART adapter SWA70	<p>Is used for the wireless connection of field devices. The WirelessHART adapter can be easily integrated into field devices and existing infrastructures, offers data protection and transmission safety and can be operated in parallel with other wireless networks with minimum cabling complexity.</p> <p> Operating Instructions BA00061S</p>
Fieldgate FXA320	<p>Gateway for the remote monitoring of connected 4-20 mA measuring devices via a Web browser.</p> <p> Technical Information TI00025S Operating Instructions BA00053S</p>
Fieldgate FXA520	<p>Gateway for the remote diagnostics and remote configuration of connected HART measuring devices via a Web browser.</p> <p> Technical Information TI00025S Operating Instructions BA00051S</p>
Field Xpert SFX350	<p>Field Xpert SFX350 is a mobile computer for commissioning and maintenance. It enables efficient device configuration and diagnostics for HART and FOUNDATION Fieldbus devices and can be used in non-hazardous areas.</p> <p> Operating Instructions BA01202S</p>
Field Xpert SFX370	<p>Field Xpert SFX370 is a mobile computer for commissioning and maintenance. It enables efficient device configuration and diagnostics for HART and FOUNDATION Fieldbus devices and can be used in the non-hazardous area and in the hazardous area.</p> <p> Operating Instructions BA01202S</p>

Service-specific accessories

Accessories	Description
Applicator	<p>Software for selecting and sizing Endress+Hauser measuring devices:</p> <ul style="list-style-type: none"> Choice of measuring devices for industrial requirements Calculation of all the necessary data for identifying the optimum flowmeter: e.g. nominal diameter, pressure loss, flow velocity and accuracy. Graphic illustration of the calculation results Determination of the partial order code, administration, documentation and access to all project-related data and parameters over the entire life cycle of a project. <p>Applicator is available:</p> <ul style="list-style-type: none"> Via the Internet: https://portal.endress.com/webapp/applicator As a downloadable DVD for local PC installation.
W@M	<p>W@M Life Cycle Management Improved productivity with information at your fingertips. Data relevant to a plant and its components is generated from the first stages of planning and during the asset's complete life cycle.</p> <p>W@M Life Cycle Management is an open and flexible information platform with online and on-site tools. Instant access for your staff to current, in-depth data shortens your plant's engineering time, speeds up procurement processes and increases plant uptime.</p> <p>Combined with the right services, W@M Life Cycle Management boosts productivity in every phase. For more information, visit www.endress.com/lifecyclemanagement</p>
FieldCare	<p>FDT-based plant asset management tool from Endress+Hauser. It can configure all smart field units in your system and helps you manage them. By using the status information, it is also a simple but effective way of checking their status and condition.</p> <p> Operating Instructions BA00027S and BA00059S</p>
DeviceCare	<p>Tool to connect and configure Endress+Hauser field devices.</p> <p> Innovation brochure IN01047S</p>

System components

Accessories	Description
Memograph M graphic data manager	<p>The Memograph M graphic data manager provides information on all the relevant measured variables. Measured values are recorded correctly, limit values are monitored and measuring points analyzed. The data are stored in the 256 MB internal memory and also on a SD card or USB stick.</p> <p> <ul style="list-style-type: none"> Technical Information TI00133R Operating Instructions BA00247R </p>
RN221N	<p>Active barrier with power supply for safe separation of 4-20 mA standard signal circuits. Offers bidirectional HART transmission.</p> <p> <ul style="list-style-type: none"> Technical Information TI00073R Operating Instructions BA00202R </p>
RNS221	<p>Supply unit for powering two 2-wire measuring devices solely in the non-hazardous area. Bidirectional communication is possible via the HART communication jacks.</p> <p> <ul style="list-style-type: none"> Technical Information TI00081R Brief Operating Instructions KA00110R </p>
Cerabar M	<p>The pressure transmitter for measuring the absolute and gauge pressure of gases, steam and liquids. It can be used to read in the operating pressure value.</p> <p> <ul style="list-style-type: none"> Technical Information TI00426P and TI00436P Operating Instructions BA00200P and BA00382P </p>
Cerabar S	<p>The pressure transmitter for measuring the absolute and gauge pressure of gases, steam and liquids. It can be used to read in the operating pressure value.</p> <p> <ul style="list-style-type: none"> Technical Information TI00383P Operating Instructions BA00271P </p>

Documentation



For an overview of the scope of the associated Technical Documentation, refer to the following:

- The *W@M Device Viewer* (www.endress.com/deviceviewer): Enter serial number from nameplate
- The *Endress+Hauser Operations App*: Enter the serial number from the nameplate or scan the 2-D matrix code (QR code) on the nameplate.

Standard documentation Brief Operating Instructions

Brief Operating Instructions for the sensor

Measuring device	Documentation code
Proline Promass A	KA01282D

Brief Operating Instructions for transmitter

Measuring device	Documentation code		
	HART	FOUNDATION Fieldbus	PROFIBUS PA
Proline Promass 200	KA012268	KA01267D	KA01269D

Operating Instructions

Measuring device	Documentation code		
	HART	FOUNDATION Fieldbus	PROFIBUS PA
Proline Promass A 200	BA01821D	BA01827D	BA01828D

Description of Device Parameters

Measuring device	Documentation code		
	HART	FOUNDATION Fieldbus	PROFIBUS PA
Proline Promass 200	GP01010D	GP01030D	GP01029D

Supplementary device-dependent documentation Safety instructions

Contents	Documentation code
ATEX/IECEX Ex i	XA00144D
ATEX/IECEX Ex d	XA00143D
ATEX/IECEX Ex nA	XA00145D
cCSAus IS	XA00151D
cCSAus XP	XA00152D
INMETRO Ex i	XA01300D
INMETRO Ex d	XA01305D
INMETRO Ex nA	XA01306D
NEPSI Ex i	XA00156D
NEPSI Ex d	XA00155D
NEPSI Ex nA	XA00157D

Special Documentation

Contents	Documentation code
Information on the Pressure Equipment Directive	SD01614D
Functional Safety Manual	SD00147D
Display and operating module FHX50	SD01007F

Contents	Documentation		
	HART	FOUNDATION Fieldbus	PROFIBUS PA
Heartbeat Technology	SD01849D	SD01848D	SD01850D

Installation Instructions

Contents	Comment
Installation instructions for spare part sets and accessories	Documentation code: specified for each individual accessory .

Registered trademarks

HART®

Registered trademark of the FieldComm Group, Austin, Texas, USA

PROFIBUS®

Registered trademark of the PROFIBUS User Organization, Karlsruhe, Germany

FOUNDATION™ Fieldbus

Registration-pending trademark of the FieldComm Group, Austin, Texas, USA

TRI-CLAMP®

Registered trademark of Ladish & Co., Inc., Kenosha, USA

SWAGELOK®

Registered trademark of Swagelok & Co., Solon, USA

www.addresses.endress.com
