

Flow

OptiSonde™

User's Manual



Flow



OptiSonde™

General Eastern Chilled Mirror Hygrometer User's Manual

910-282 Rev. B
AUG 2021

panametrics.com

Copyright 2021 Baker Hughes company.

This material contains one or more registered trademarks of Baker Hughes Company and its subsidiaries in one or more countries. All third-party product and company names are trademarks of their respective holders.

[no content intended for this page]

Chapter 1. Features and Capabilities

1.1 Introduction1

1.2 Electronics Enclosure 2

 1.2.1 Front Panel 2

 1.2.2 Input/Output Capability 3

1.3 The System 3

 1.3.1 System Components 3

1.4 Sensors 4

 1.4.1 Dew Point Sensors 4

 1.4.2 Temperature Sensor 4

Chapter 2. Installation

2.1 Introduction 5

2.2 Benchtop Installation 5

 2.2.1 Mounting the Benchtop 5

 2.2.2 Wiring the Benchtop 5

2.3 Wall-Mount Installation 7

 2.3.1 Installing the Wall-Mount 7

 2.3.2 Wiring the Wall-Mount 8

2.4 Input Power 9

2.5 Output Wiring 10

 2.5.1 Analog Outputs 11

 2.5.2 Alarm Outputs 11

 2.5.3 Serial Output 13

2.6 Sensor Information 14

 2.6.1 Sampling Lines 15

 2.6.2 Ensuring Heat Transfer 15

 2.6.3 Filter Requirements 16

 2.6.4 Flow Rate 17

2.7 Sensor Installation 17

 2.7.1 Model 1111H Sensor 17

 2.7.2 Model D-2 Sensor 18

 2.7.3 Model 1211H Sensor 18

 2.7.4 Model 1311DR Sensor 18

 2.7.5 Model SIM-12H Heated Sensor and Components 19

 2.7.6 Connecting the Sensors 20

Chapter 3. Operation

3.1 Introduction 21

3.2 Normal Operation 21

3.3 Operating the OptiSonde 22

3.4 Status Line Indications 23

 3.4.1 Factory Default Settings 24

3.5 Sensor Balancing 25

3.6 Helpful Hints For Operating the Unit 25

 3.6.1 Supercooled Dew Points 26

 3.6.2 Contamination 26

Chapter 4. Programming the OptiSonde

4.1 Introduction 29

4.2 Programming Technique 30

4.3 Programmable Functions..... 31

4.3.1 Display..... 31

4.3.2 Analog Outputs..... 32

4.3.3 Alarms..... 33

4.3.4 Logging OptiSonde Data..... 33

4.3.5 OptiSonde Settings..... 35

4.3.6 Automatic Cleaning and Balance Function..... 35

4.3.7 Service Options..... 36

4.3.8 System Information..... 37

4.3.9 Locking the System Keys..... 37

Chapter 5. Maintenance

5.1 Minor Maintenance of Sensor Optics..... 39

5.1.1 Cleaning and Balancing the Sensor Mirror..... 39

5.1.2 Procedure for Cleaning and Balancing the Sensor Mirror..... 40

5.2 Field Replacement of Sensor Mirrors..... 42

5.2.1 Replacing the Sensor Mirror..... 43

5.3 Test and Calibration..... 43

5.4 Troubleshooting..... 43

5.4.1 The Display Doesn't Light Up..... 43

5.4.2 "Service" Appears on the STATUS Display Line..... 43

5.4.3 Incorrect Dew Point Display..... 44

5.4.4 "Balance" Remains on the Status Line..... 45

5.4.5 No Analog Output..... 45

5.4.6 No Serial Output..... 45

Appendix A. Specifications

A.1 Performance..... 47

A.1.1 Accuracy..... 47

A.1.2 Measurement Ranges..... 47

A.1.3 Response Time..... 47

A.1.4 Update Time..... 47

A.2 Functionality..... 48

A.2.1 Outputs..... 48

A.2.2 Digital Interface..... 48

A.2.3 Alarms..... 48

A.2.4 Display..... 48

A.2.5 Power..... 48

A.2.6 Operating Ranges..... 48

A.2.7 Electronics..... 48

A.3 Physical (Bench Mount)..... 49

A.3.1 Dimensions..... 49

A.3.2 Weight..... 49

A.3.3 Environmental..... 49

A.4 Physical (Wall Mount)..... 49

A.4.1 Dimensions..... 49

A.4.2 Weight..... 49

A.4.3 Environmental..... 49

A.5 Optional Accessories..... 49

A.5.1 PTFE-Panametrics..... 49

A.5.2 FM-1..... 49

A.5.3 BF12SS..... 49

Appendix B. Humidity Equations and Conversion Chart

B.1 Introduction..... 51

B.2 Vapor Pressure..... 51

B.2.1 Humidity..... 52

Appendix C. Configuring the Serial Interface

C.1	Wiring to a Personal Computer	55
Appendix D. Chilled Mirror Sensors		
D.1	Introduction	57
D.2	Depression	57
D.3	Measurement Range	58
D.4	Comparing OptiSonde Models	59
Appendix E. Theory of Operation and Glossary		
E.1	Theory of Operation	61
	E.1.1 Hygrometer Function	61
	E.1.2 Hygrometer Calibration	62
	E.1.3 Other Hygrometer Applications	63
E.2	The PACER Cycle	64
E.3	Glossary	65
	E.3.1 Depression Capability	65
	E.3.2 PACER	65
	E.3.3 Parameter	65
	E.3.4 Process Pressure	65
	E.3.5 Scaling	65

Chapter 1. Features and Capabilities

1.1 Introduction

The Panametrics *OptiSonde™* is a multi-purpose chilled-mirror hygrometer, suitable for use in a wide variety of applications. The *OptiSonde* can function with the Panametrics one and two-stage chilled-mirror sensors to provide the following measurement ranges (depending on the sensor selected):

- one-stage 45° depression @25°C and 1 ATM
two-stage 65° depression @25°C and 1 ATM
(depending on sensor, as shown in Figure 1 below)
- relative humidity from 0.02% to 100%
- moisture content from 0.9 ppm_v to over 5.8×10^5 ppm_v
- temperature from -100° to +100°C (-148°F to +212°F)

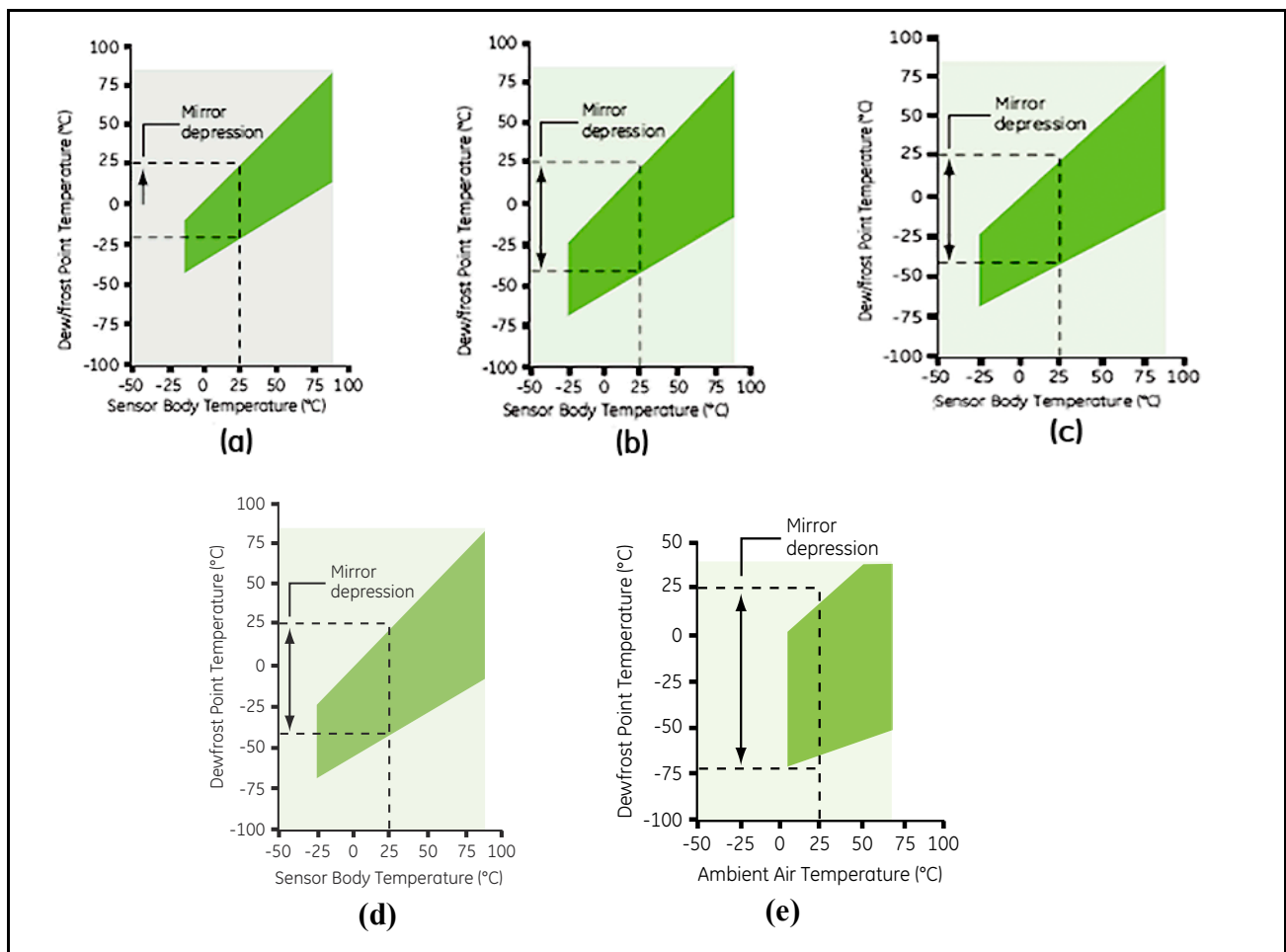

Figure 1: Mirror Depressions at Various Temperatures for 1111H (a), D2 (b), 1211H (c), SIM-12H (d) and 1311-DR (e) Sensors

1.1 Introduction (cont.)

The *OptiSonde* simultaneously measures and displays any two parameters with a wide variety of units of measurement. You can use the data logging function to record and upload weeks of data. When the data is uploaded to a PC, PanaView software enables graphing and data reduction. You can also export the data in ASCII text file format for use in spreadsheets such as Excel, or view screen captures in HyperTerminal.

1.2 Electronics Enclosure

The *OptiSonde* is available in two configurations:

- a benchtop model, AC powered with DC option
- a wall-mount unit, housed in an IP65 enclosure

See Chapter 2, *Installation*, for details on how to mount the *OptiSonde*.

1.2.1 Front Panel

The *OptiSonde*'s front panel is shown in Figure 2 below. The panel includes: a 128 X 64 graphical display, **ENTER** and **ESC** keys, and four arrow keys to the right of the display screen.

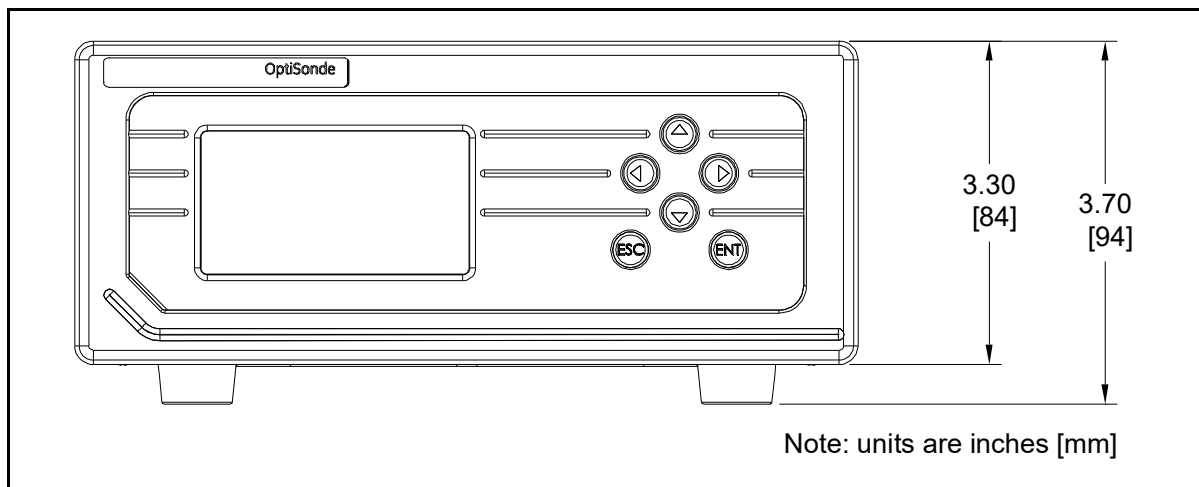

Figure 2: *OptiSonde* Benchtop Version

1.2.2 Input/Output Capability

Available inputs and outputs include the following:

- 1111H, 1111H-Panometrics, D2, 1211H, SIM-12H, and 1311-DR chilled mirror sensor input
- 4-wire Resistance Temperature Detector (RTD) input
- two simultaneous analog outputs, each with a programmable 0-20 mA or 4-20 mA DC signal
- one independent alarm relay (7 A, 30 VDC)
- RS-232 serial communications port

The *OptiSonde* uses the Panometrics patented Programmable Automatic Contaminant Error Reduction (PACER) system for automated self-cleaning and optics rebalancing.

Detailed specifications for the *OptiSonde* are given in *Appendix A*.

1.3 The System

1.3.1 System Components

A complete *OptiSonde* system consists of the following items:

- Electronic monitor
- Dew point sensor
- Interconnecting sensor cable
- AC line cord (for benchtop)
- Certification that the unit is traceable to the National Institute of Standards and Technology (Certificate of Conformance)
- Temperature sensor
- Maintenance kit
- User's Manual

1.4 Sensors

The *OptiSonde* is configured with a chilled-mirror dew point sensor. The specific sensor is chosen according to the expected dew point range and the environment in which the dew point is to be determined. In addition, the *OptiSonde* is supplied with a temperature sensor. Panametrics provides the following sensors for various applications:

1.4.1 Dew Point Sensors

- Model 1111H – Dew point single-stage sensor with 1" M-NDT
- Model 1111H-Panametrics – Dew point single-stage sensor with flange for duct mounting
- Model 1211H – Two-stage sensor; high pressure and temperature
- Model D-2 – Two-stage sensor
- Model SIM-12H – Two-stage heated sensor
- Model 1311DR – Four-stage, liquid or air cooled sensor

1.4.2 Temperature Sensor

- Model T-100E

Chapter 2. Installation

2.1 Introduction

This chapter explains the installation of the benchtop and wall-mount versions of the *OptiSonde*, the various sensors used with the system, and the I/O and power wiring.

2.2 Benchtop Installation

2.2.1 Mounting the Benchtop

The *OptiSonde* benchtop dimensions are shown in Figure 3 below. A metal stand on the bottom of the case can be unfolded to elevate the front of the instrument for easier viewing, if desired.

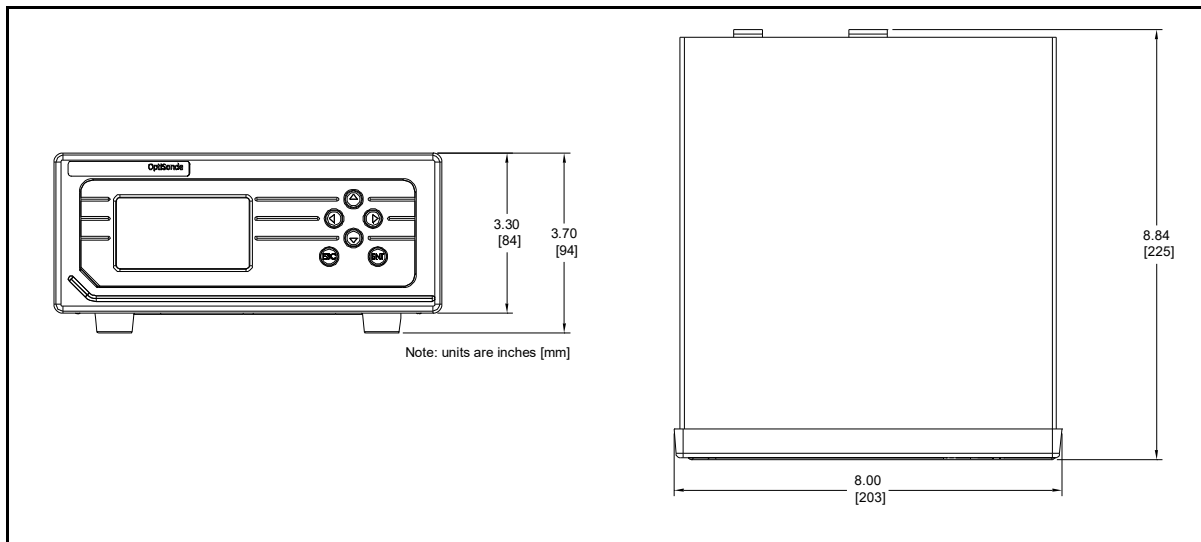

Figure 3: *OptiSonde* Benchtop Dimensions

2.2.2 Wiring the Benchtop

2.2.2.1 Input Power

The *OptiSonde* operates with input power from 100 to 240 VAC $\pm 10\%$. (See Figure 4 on the next page.) The *OptiSonde*'s voltage and frequency rating are listed on the product label. A DC option offers a minimum of 18 to a maximum of 32 VDC operation (See Figure 5 on the next page.)

2.2.2.2 Sensors

Connect the dew point sensor cable to the 25-pin connector on the *OptiSonde's* rear panel (see Figure 4 below). Connect the optional temperature sensor cable to the 9-pin temperature connector on the rear panel. Other I/O wiring connects to the appropriate terminal block. Tighten all connector thumbscrews to prevent disconnections.

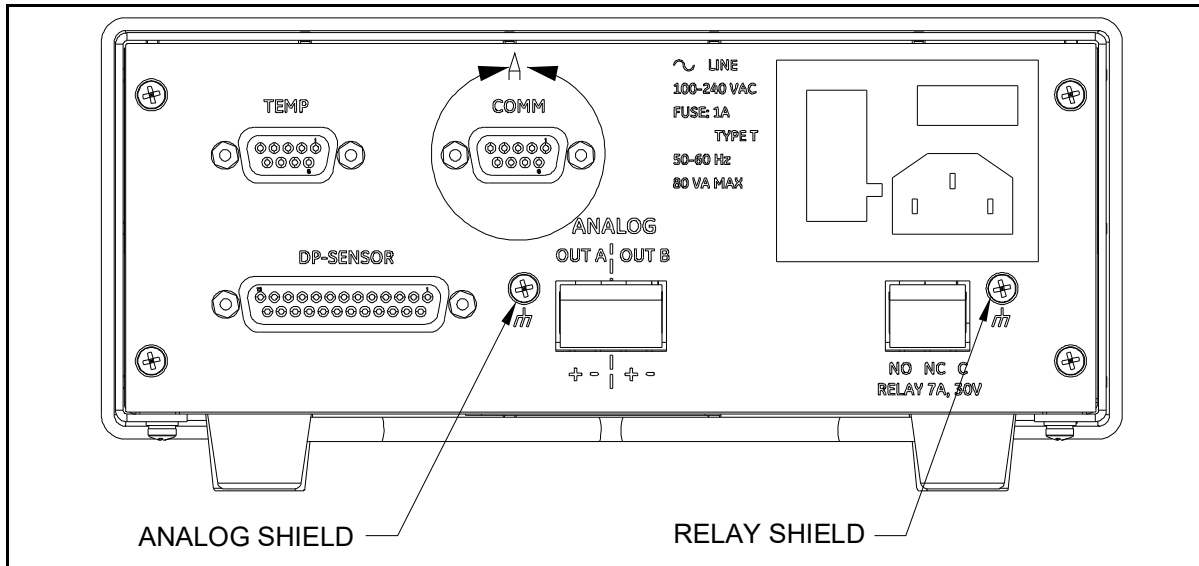

Figure 4: *OptiSonde* Benchtop Rear Panel

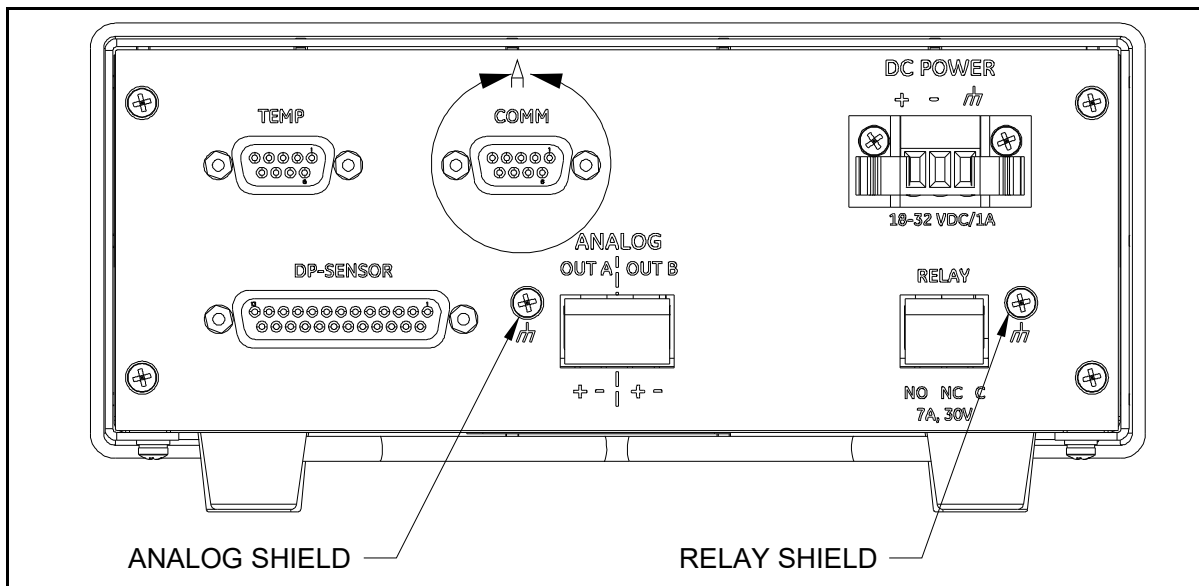

Figure 5: *OptiSonde* DC Option Rear Panel

2.3 Wall-Mount Installation

The *OptiSonde* Wall-Mount unit is designed to mount on a flat, vertical surface, such as a wall or panel. To mount the wall-mount version, see Figure 6 and Figure 7 below.

2.3.1 Installing the Wall-Mount

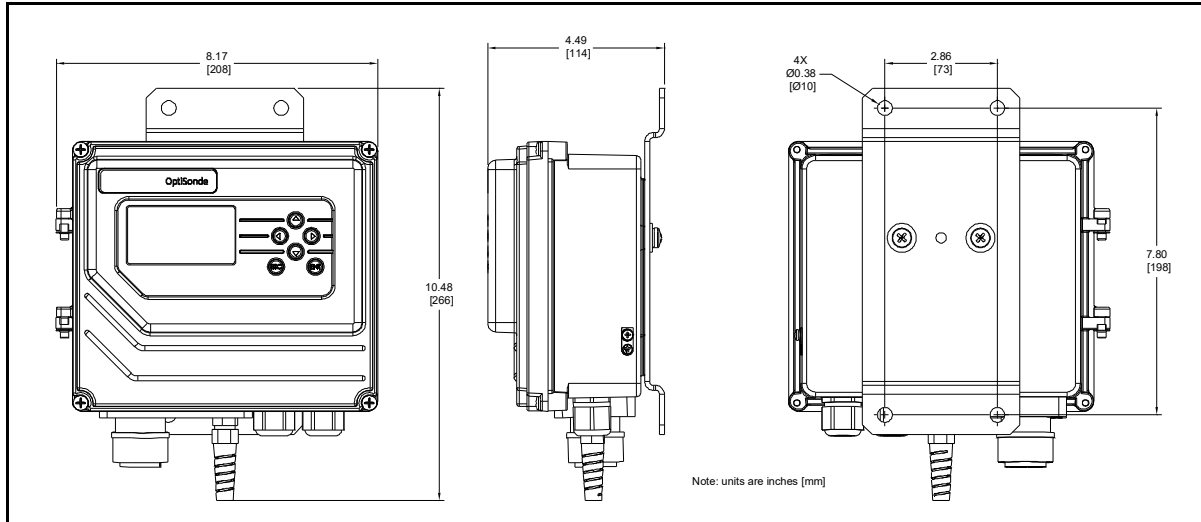

Figure 6: *OptiSonde* Wall-Mount Dimensions

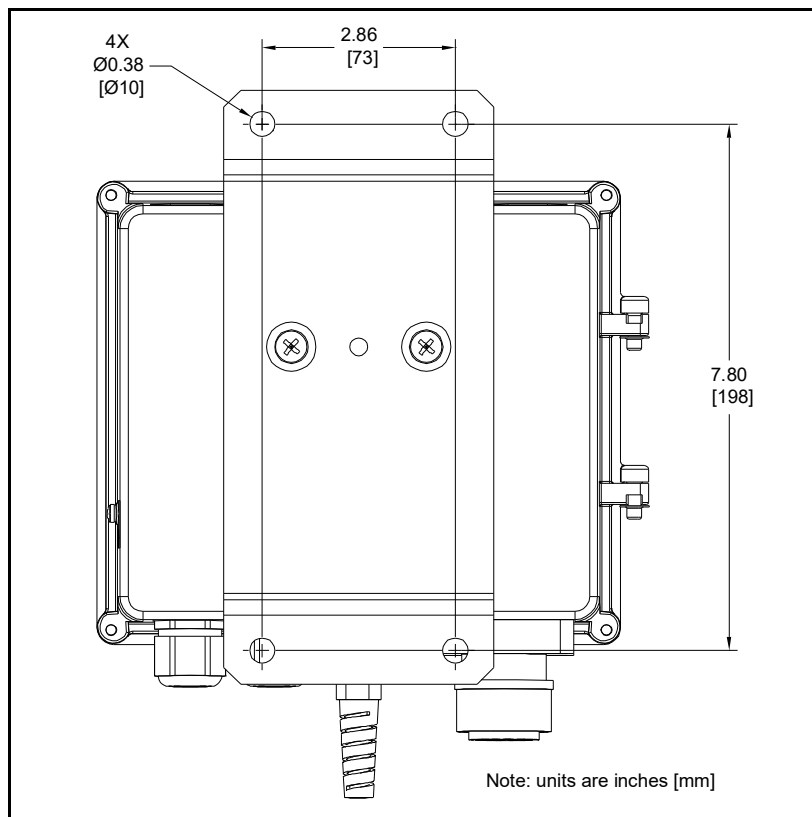

Figure 7: *OptiSonde* Wall-Mount - Mounting Hole Locations

2.3.1 Installing the Wall-Mount (cont.)

For mounting, secure the unit to a wall or panel using all four mounting holes. Use stainless hardware, a minimum of 2 inches long, #8 screws with washers. Screws should go directly into wood studs. If no stud is available, use suitable hardware for the application, such as with plasterboard or cement.

2.3.2 Wiring the Wall-Mount

CAUTION! The wall-mount unit meets IP65 rating for water ingress when tested with solid plugs. In order to maintain this rating, installation personnel must ensure that each of the two wiring ports use a single cable with a minimum diameter of 0.24 in (6 mm) and a maximum diameter of 0.47 in (12 mm). Recommended wire nuts torque is 37 in-lbs (4.2 Nm). Any unused wiring port shall be plugged with a supplied solid plug.

All connections to the wall-mount unit are made through the panel at the bottom of the case as shown in Figure 8 below. Any I/O cabling is brought into the unit through glands at the lower right of the case and connects to the terminal blocks inside the case. Wiring for these connections is shown below and in Figure 10 on page 10. The dew point sensor and temperature sensor cable connectors are located on the black mounting block.

IMPORTANT: AC and signal wiring must be done in accordance with local codes. Wire size cannot exceed 14 AWG (2.08 mm²). Insulation shall be stripped 6 mm prior to being inserted into the connection block.

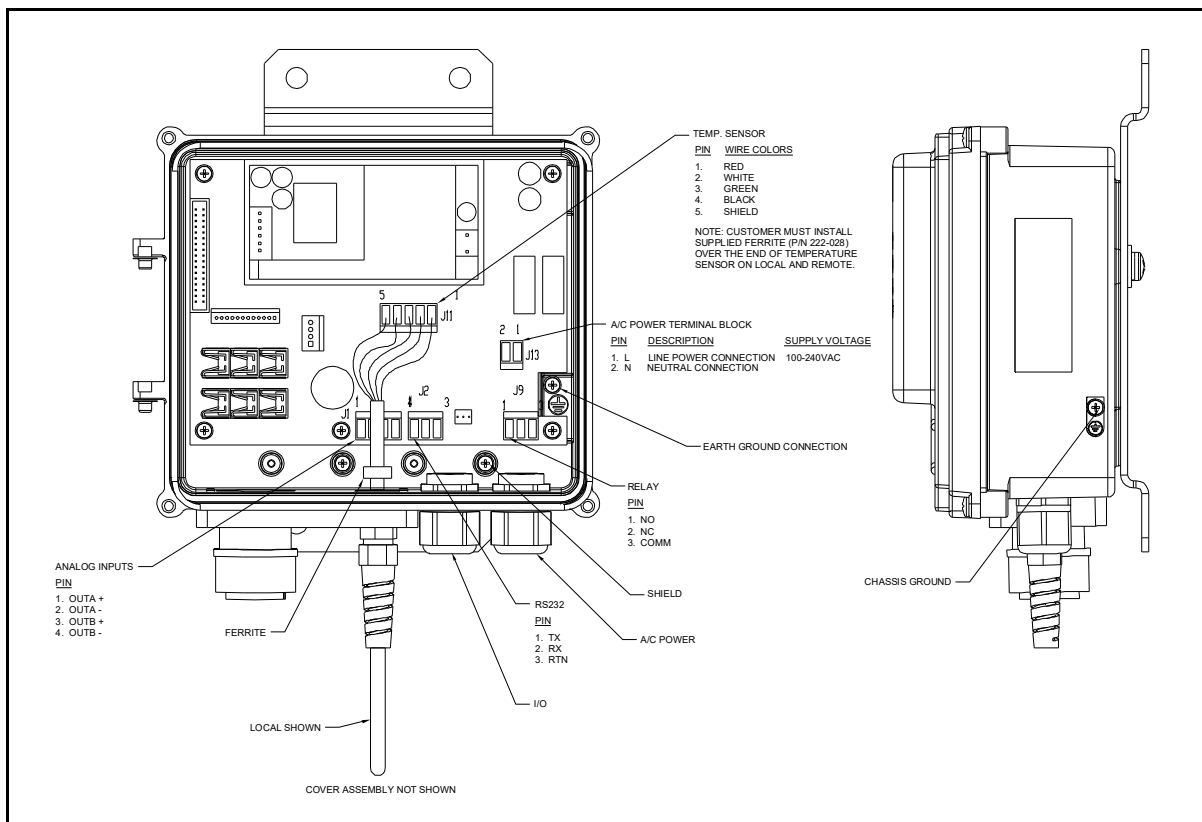

Figure 8: Wall-Mount Wiring Entrance Locations

2.4 Input Power

Power wiring enters the case through a gland fitting at the lower right of the unit and connects to a screw terminal block mounted on the right side of the case. The voltage, frequency and power ratings are listed on the bottom of the unit. Wiring of this terminal block is shown in Figure 9 below. The external ground screw must connect the unit to protective earth using a wire that is sized equal to or greater than the wire used for input power connections. Grounding should be done in accordance with local codes.

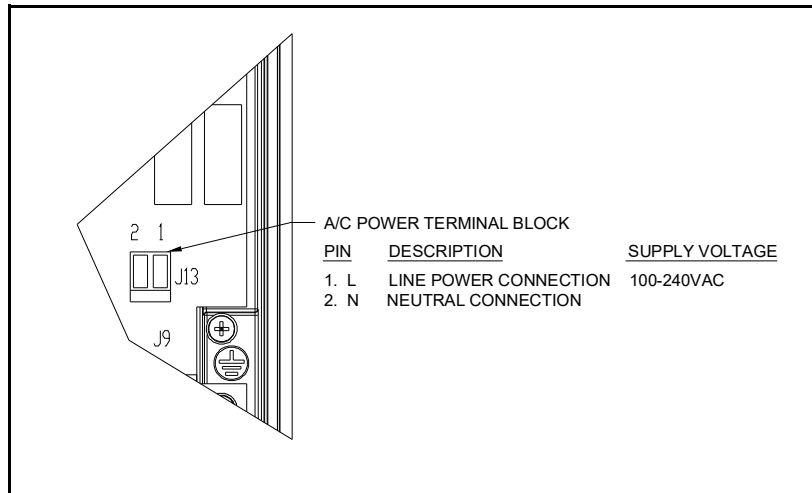

Figure 9: Wall-Mount AC Power Wiring

2.5 Output Wiring

The **benchtop** outputs are connected to removable terminal blocks on the rear panel. Figure 4 on page 6 shows the location of the benchtop terminal blocks and Figure 10 below shows the wall-mount connections.

The **Wall-Mount OptiSonde** input/output terminal blocks are located inside the front door as shown in Figure 8 on page 8. Cabling is brought in through the glands on the bottom of the unit and wired to the terminal blocks shown in Figure 10 below. Terminal block screws must be torqued between 0.4 - 0.5 Nm.

Note: Output programming is described in Chapter 4.

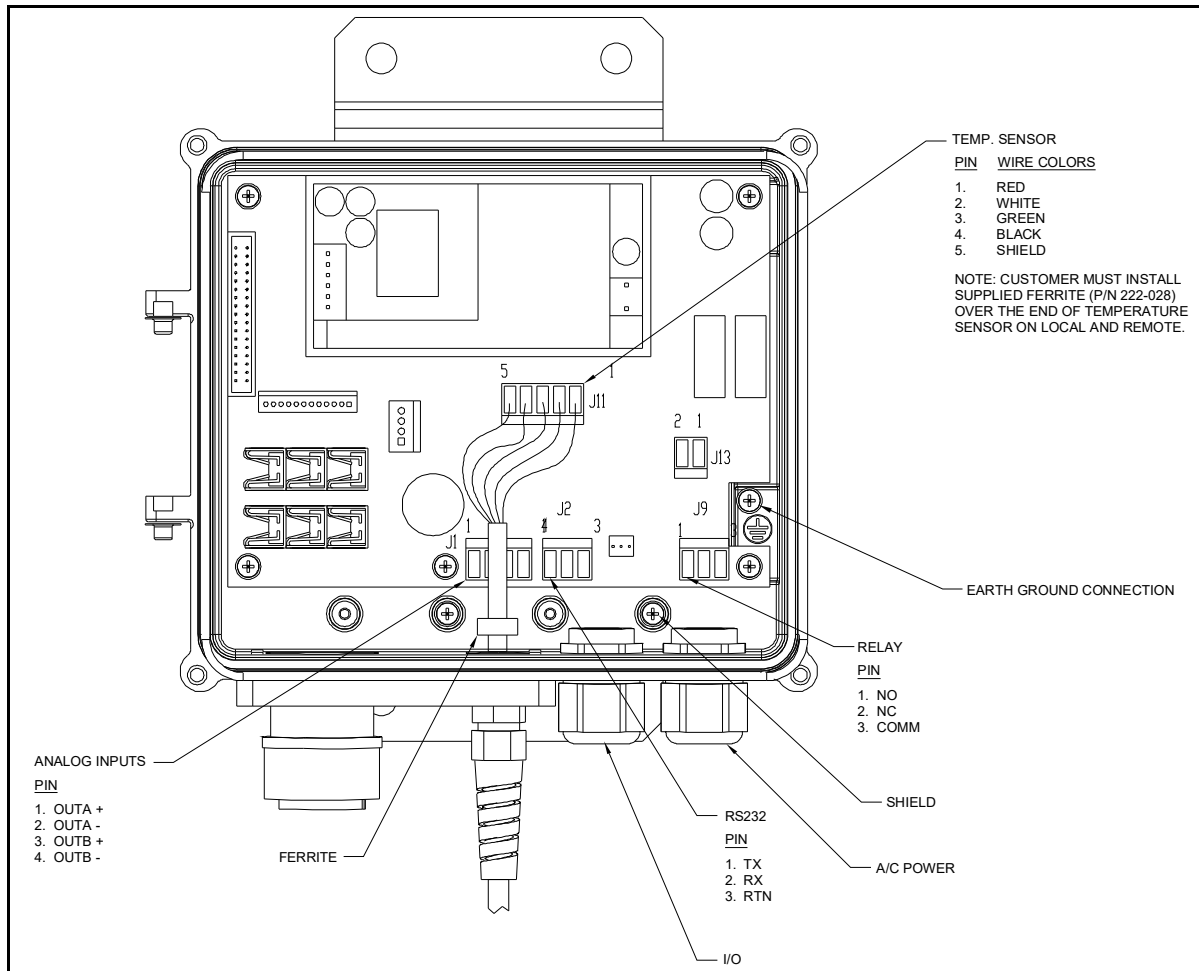

Figure 10: Wall-Mount Input/Output Terminal Blocks

2.5.1 Analog Outputs

Note: When the OptiSonde is being programmed, the analog outputs provide 4–20 mA signals representing the designated parameters.

- For 4–20mA output, connect to terminals labelled 4–20 (+) and RTN (–).

Note: The maximum load allowed for current output is 500 Ohms.

Example: Assume a temperature output, scaled to range from 0°C (T_{lower}) to 100°C (T_{upper}), with a measured actual temperature of 23°C (T_{actual}): The current output is calculated by:

$$I_{\text{out}} = \frac{(T_{\text{actual}} - T_{\text{lower}})}{(T_{\text{upper}} - T_{\text{lower}})} \times (20 - 4) + 4$$

yielding an output current of 7.68 mA.

$$\frac{(23 - 0)}{(100 - 0)} \times (16) + 4 = 7.68\text{mA}$$

2.5.2 Alarm Outputs

The alarm output connects to the contacts of a 7-Amp, Form C (SPDT) relay.

Make connections as follows:

- For normally open contacts, connect to NO and COMM.
- For normally closed contacts, connect to NC and COMM.

Any available parameter can be used to control an alarm relay by programming the parameter name and its threshold values. An alarm can also be programmed to monitor the state of the Control, PACER Balance, or Service indicators. (See Chapter 4 for programming instructions.)

Two threshold values are programmed for each parameter—an upper and a lower value. These values designate an alarm band. How they are used depends on the alarm type programmed. Details of the alarm bands are shown on the following pages.

2.5.2.1 Set Point Alarm

For the **Set Point** alarm type, the alarm band provides hysteresis to prevent frequent operation of the alarm relay when the parameter is near the specified value. The relay is **activated** when the parameter **exceeds** the upper limit, and **deactivated** when the parameter goes **below** the lower limit.

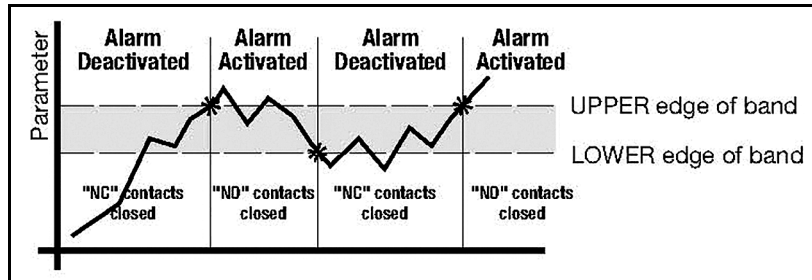

Figure 11: Set Point Alarm

2.5.2.2 Inner Band Alarm

For the **Inner Band** alarm type, the alarm relay activates whenever the parameter value is **between** the lower and upper limits.

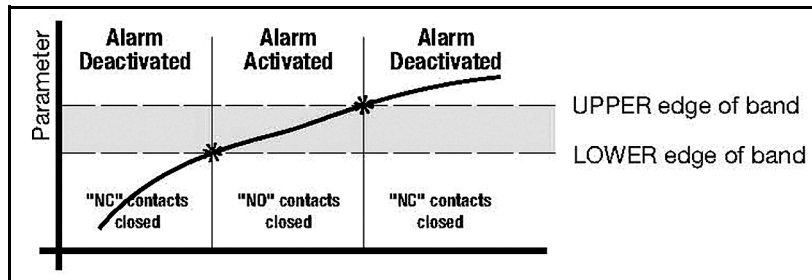

Figure 12: Inner Band Alarm

2.5.2.3 Outer Band Alarm

For the **Outer Band** alarm, the alarm relay activates whenever the parameter value is **greater** than the upper limit or less than the lower limit.

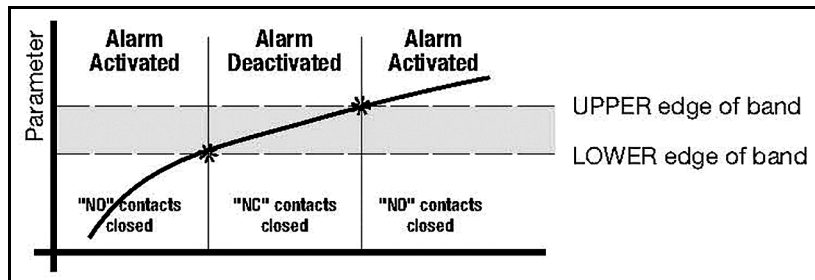

Figure 13: Outer Band Alarm

2.5.3 Serial Output

The Serial Output connector is located on the rear panel of the benchtop unit (see Figure 4 on page 6), and inside the wall-mount unit (Figure 8 on page 8). The output provides RS-232C serial communications between the unit and a terminal or a PC running in terminal emulation mode.

The benchtop connector is a standard 9-pin D connector. For connection to a serial device, the wallmount cable is wired as shown in Figure 10 on page 10. The baud rate can be programmed using the Comms menu (see page 36). The data format is 8 bits, 1 stop bit, no parity.

2.6 Sensor Information

Panametrics produces a variety of sensors compatible with the OptiSonde, ranging from one to two stages of thermoelectric cooling. A comparison chart listing specifications of each sensor appears in Appendix D. The following sections provide information on installing the following Panametrics dew point sensors:

- Model 1111H – Single-stage sensor with 1" M-NDT
- Model 1111H-Panametrics – Dew point single-stage sensor with flange
- Model 1211H – Two-stage sensor; for high pressure and temp.
- Model D-2 – Two-stage sensor
- Model SIM-12H – Two-stage heated sensor
- Model 1311DR – Four-stage heated sensor

When selecting a location for installing a sensor, consider the following criteria:

- Locate the sensor as close as is practical to the source of the gas to be measured, to keep the sampling lines as short as possible. This minimizes the system response time and reduces the error rate at low frost points due to sample line outgassing.

CAUTION! The OptiSonde electronics and sensors are for General Purpose Locations only. They are not for use in hazardous (classified) locations. Sample air/gas shall be non-combustible only.

- Choose a sensor location that provides access to the dewpoint sample cavity cover, to facilitate periodic mirror cleaning.

CAUTION! Never place the sensor in a location where temperatures rise above the maximum rated temperature for the device. See Appendix D for complete sensor specifications.

2.6.1 Sampling Lines

Keep the length of sample tubing between the source and the sensor short, for quick response and highest accuracy. All sampling line compression fittings provided with the sensor are for ¼-inch diameter tubing, unless otherwise specified at the time of order. The material used for the inlet lines can have an important effect on the validity of the readings. Do not use rubber hose or plastic tubing such as PVC or Tygon, because of their hygroscopic nature.

When measuring frost points below -30°C , sample gas leaving the sensor outlet should be vented through a coil approximately two feet long, since backflow of ambient moisture into the sensor can take place even under positive pressure. Use stainless steel tubing and fittings, and ensure that all plumbing is completely free from leaks.

Stainless steel is the material of choice. The sampling system should allow for periodic cleaning. It may be helpful to install a tee and closing valve on the inlet side, to permit the sensor to be shut off while the sampling lines are flushed. At very low humidities, even a trace amount of contamination can alter measured frost point, so cleanliness is particularly important.

2.6.2 Ensuring Heat Transfer

Be sure the sensor has an adequate heat sink when operating in hot environments. The sensor must never be allowed to reach a temperature above its rated limit. It is not sufficient merely to ensure that the sensor is in an environment whose temperature is below the rated limit; a means must be supplied to remove heat from the sensor.

When the Model 1111H, 1211H or D-2 sensors are used at ambient temperatures of 20° to 24°C , full rated depression can be achieved by mounting the sensor on a smooth, thermally conductive surface (such as metal), which tends to remain at the ambient temperature.

If possible, do not operate the sensor continuously at or near full depression. Doing so may decrease the anticipated life of the thermoelectric heat pump.

2.6.2 Ensuring Heat Transfer (cont.)

When measuring dew points at or above the ambient temperature, the sensor must be heated to a temperature of at least 5 to 10°C above the highest anticipated dew point (but not higher than the sensor temperature rating). Some sensors can be mounted on a liquid heat exchanger, or a temperature-controlled electric hot plate, or installed in a heated enclosure. Panametrics recommends closed-loop active control of the elevated sensor body temperature.

The sensor base should be coated with zinc-oxide-filled silicone thermal grease and securely anchored to the heat sink with suitable fasteners. Allow ½ hour for the sensor to reach thermal equilibrium after adjusting the temperature of the heat sink.

2.6.2.1 Sample Lines for High Dew Point Measurements

Sampling lines carrying gas to the sensor must be heated and insulated when the dew point of the gas is above the sample line's ambient temperature. The simplest way to achieve this is to use heater tape (either thermostatically controlled, or continuously operating, and sized to provide the required temperature rise). At high temperatures, use stainless steel tubing with adequate insulation to avoid hot and cold sections in the line and to avoid water absorption/desorption cycling as the heater is thermostatically controlled. Panametrics Sensing can provide custom heated systems. Please contact our application engineers.

2.6.3 Filter Requirements

If the gas to be monitored is free from particulates and hydrocarbon liquids or vapor, filtering is not necessary. However, most sample gas streams contain some particulates, and using a filter reduces the need for frequent mirror cleaning. On the other hand, filtering tends to slow the system's response, particularly at low frost points.

The model BF12-SS filter may be used inline; Panametrics's application engineers would be pleased to review your application and recommend an appropriate sampling system.

Avoid using glass wool, cellulose, and other hygroscopic materials as a filter medium.

2.6.4 Flow Rate

It is important to have adequate flow through the sensor. Too little flow can slow the response (particularly at very low frost points). Too much flow can cause instability of the control system at high dew points and can reduce the depression capability of the thermoelectric cooler at very low dew points. Too much flow also accelerates the rate of system contamination. A flow rate of 0.5 to 2.5 SCFH (0.25 to 1.25 LPM) is ideal for most applications.

2.7 Sensor Installation

This section provides installation details for the Panametrics line of chilled-mirror humidity sensors.

2.7.1 Model 1111H Sensor

The Model 1111H is an open-type sensor (see Figure 14 below) with 45°C depression capability at 25°C @ 1 ATM. It can be threaded into standard pipe fittings or mounted in a type 0111D pressure boss, which encloses it and adapts it for ¼-inch compression fittings. When installing the sensor in the pressure boss, remove the black aluminum sensor cover. A second version, the 1111H-Panametrics, extends 9 in. and includes a duct-mounted flange and a removable PTFE filter.

For maximum thermal conductivity, the base of the Model 0111D pressure boss should be coated with heat-conducting grease. When so installed on a surface suitable for dissipating heat, the sensor will achieve its maximum rated depression. See the *Chilled Mirror Sensor Comparison Chart* in Appendix D.



Figure 14: Model 1111H Sensor for Duct Mounting

2.7.2 Model D-2 Sensor

The Model D-2 is a general purpose, two-stage sensor with 65°C (117°F) of depression capability at 25°C @ 1 ATM. It features wetted parts of stainless steel and glass, for durability in demanding industrial applications. The Model D-2 can be used as a benchtop sensor, mounted to a heat sink, or mounted to a cooling fan for maximum operating range. Advanced features include field-replaceable optics and cooler assemblies, and auxiliary visible light optics with a viewing window for inspecting the mirror during operation (see Figure 15 below).

For maximum thermal conductivity, the base of the Model D-2 sensor should be coated with heat-conducting grease. When so installed on a surface suitable for dissipating heat, the sensor will achieve its maximum rated depression. See the *Chilled Mirror Sensor Comparison Chart* in Appendix D.

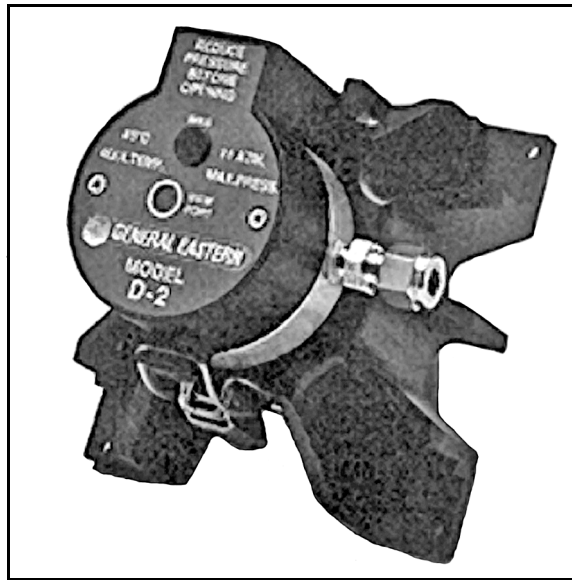

Figure 15: Model D-2 Sensor

2.7.3 Model 1211H Sensor

The Model 1211H is a two-stage sensor with 65°C (117°F) of depression capability at 25°C @ 1 ATM. It features wetted parts of stainless steel and may be used at higher temperature and pressure than the D2 sensor. The Model 1211H can be used as a benchtop sensor, mounted to a heat sink. Features include a field-replaceable mirror, optics and cooler assembly. See the *Chilled Mirror Sensor Comparison Chart* in Appendix D.

2.7.4 Model 1311DR Sensor

The 1311DR is a stainless steel, liquid cooled, four-stage sensor suitable for measuring dew points between -75°C and +25°C.

Mount the 1311DR sensor so that the air inlet and exhaust openings are free from obstruction (see Figure 16 on the next page). If the sensor is liquid cooled, vertical wall mounting is recommended, observing the "UP" arrow on the case. This ensures that condensation forming on cold portions of the 1311DR will drain from the enclosure.

At room temperatures (25°C) with air cooling, dew points from -65°C to +25°C can be measured. When operating it without liquid cooling, switch on the built-in fan. For lower frost point measurements, a chilled-water coolant loop can be used for cooling. Make sure the fan switch is off when using liquid cooling.

2.7.4 Model 1311DR Sensor (cont.)

Sample flow rates from 0.5 to 5 standard cubic feet per hour (0.25 to 2.5 liters per minute) should be used.

CAUTION! If it can be avoided, do not operate the sensor continuously at or near full depression. Doing so may decrease the life of the thermoelectric heat pump.

Liquid cooling is required for measuring frost points below -65°C (at 25°C ambient), and may be used to create faster response at higher dew point temperatures. If a recirculating chiller is used, it should have a capacity of at least 300 watts at the coolant temperature. Switch the internal fan ON if air cooling is used; leave it OFF for liquid cooling. Install the gas sampling lines according to the instructions listed in the section *Sampling Lines* on page 15.



Figure 16: Model 1311DR Sensor

2.7.5 Model SIM-12H Heated Sensor and Components

The SIM-12H heated sensor module is suitable for measuring dew/ frost points between -10°C and $+85^{\circ}\text{C}$. It contains precision heating, as well as cooling, capability. Three separate heaters are located in the sensor walls, 120 degrees apart. Three temperature sensors measure the body temperature at those points, and three control circuits precisely adjust the temperature of each heater. Any detected temperature gradient across the sensor cavity is immediately eliminated, resulting in very even control. All three heaters are controlled by the temperature set by the front panel selector knob. The sensor is a two-stage unit, providing 65°C of depression capability, and 60°C actual measurement range.



Figure 17: SIM-12H Heated Sensor Module

2.7.5.1 Type SIM-HFT Heated Filter Module

The SIM-HFT heated filter module allows the sample gas to be purged of particulate contaminants prior to entering the sensor. The incoming gas is first passed through a 90-micron prefilter, then a 15-micron final filter. All parts in contact with the sample are heated to a constant 105°C , eliminating any possibility of condensation. The sintered filters are easily removed for cleaning or replacing if required.

2.7.5.2 Type SIM-HFM Heated Flow Meter

The SIM-HFM heated flow meter module allows the sample gas flow rate to be both measured and controlled at a rate that is optimum for the sensor. A metering valve mounted on the front panel allows control over a range of 0 to 2

ft³/h. All parts in contact with the sample gas are heated to a constant 105°C, so that no condensation occurs. The flow meter is normally mounted downstream from the heated sensor.

2.7.5.3 Type SIM-HSL Heated Sampling Line

The SIM-HSL heated sampling line is self-regulated at a temperature high enough to ensure that no condensation occurs. The line is made of ¼-inch outside diameter PTFE, with stainless steel fittings.

2.7.5.4 Type SIM-MPL Mounting Plate

The SIM-MPL mounting plate is designed to accept one, two or three heated modules: the heated sensor, the heated filter, and the heated flow meter. The mounting plate provides a convenient method of wall-mounting the entire heated sampling system. When ordered with one or more modules, the factory performs all mounting, plumbing and wiring work, thus providing a complete system ready for installation.

2.7.6 Connecting the Sensors

Dew point and temperature sensors provided by Panametrics for the OptiSonde monitor are pre-wired with connectors installed. Plug these connectors into their corresponding sockets as shown in Figure 4 on page 6 for the benchtop unit, or Figure 8 on page 8 for the wall-mount unit. The 1111H sensor can be mounted directly to the wall-mount enclosure to facilitate room monitoring. Ensure that the sensor or cable is fully inserted, and the ring coupler fully hand-tightened for reliable operation. Tighten dome nut to 22 in-lb (2.5 Nm) to assure a proper seal for IP65 rating.

Chapter 3. Operation

3.1 Introduction

Operating instructions fall into three categories:

- Normal Operation - Using the unit's controls.
- Setup and Programming - Customizing the unit for specialized applications (not required for many conventional applications).

Note: *The unit is shipped pre-programmed to meet typical requirements. The factory default settings are listed in Table 2 on page 4. Complete programming instructions are given in Chapter 4.*

- Maintenance - Manually testing the unit's cooling capacity, cleaning the mirror, and other operations that might be required on a regular basis, or when a problem is suspected, depending on the application. Details are given in Chapter 5, *Maintenance*.

3.2 Normal Operation

Normal operation of the OptiSonde is very simple. First, apply power to the wall-mount unit. For the benchtop unit, switch the main power switch on the rear to **ON (I)**.

The OptiSonde begins its power-up sequence, which lasts about a minute. The unit's software version is displayed on the initial screen, "Initializing". Next, the OptiSonde performs an **AUTO** or a PACER balance. The PACER balance typically requires five to fifteen minutes, depending on the sensor chosen and the humidity of the sample gas during the balance cycle. "AUTO CYCLE" or "PACER" appears on the status line.

Once the balance cycle is completed, the unit displays "Acquiring" until it reaches steady state. The word Control appears on the status bar at the top of the screen.

The sensor can be controlled using the keys to the right of the display, shown on the screen in Figure 18 on the next page. The operator can manually heat or cool the sensor, or initiate a PACER balance cycle. To control the sensor, press the **ENT** key. (If the OptiSonde keys are locked, press the **ESC** key, followed by the **ENT** key, and then press the **ESC** key again.)

3.3 Operating the OptiSonde

The parameters chosen during programming are displayed numerically in the middle of the screen. For programming, see Chapter 4. A typical OptiSonde display screen is shown in Figure 18 below. The system status and heating/cooling indicator (small arrow) are shown in the upper right, and the balance indicator is shown in the lower left.

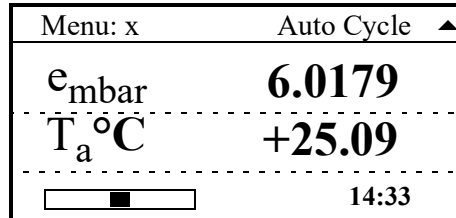

Figure 18: Typical OptiSonde Display Screen

To control the sensor, press the **ENT** key. (If the OptiSonde keys are locked, press the **ESC** key, followed by the **ENT** key, and then press the **ESC** key again.) The Function Control screen appears, as shown in Figure 19 below. Use the four arrow keys to select the desired function

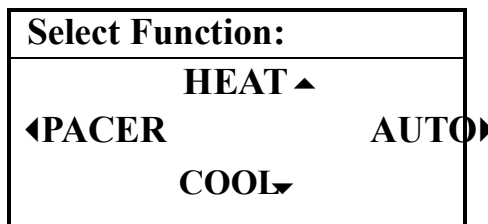

Figure 19: Function Control Screen

3.4 Status Line Indications

The status line at the top of the display shows whether the unit is ready for normal operation, or is still in its start-up phase, or needs service. The following is a complete list of status indications:

Indication	Meaning
Initializing	The unit is initializing.
Acquiring	The unit is acquiring stable mirror temperature.
Service Req.	The sensor optics require service, cleaning or adjustment.
Tracking	The unit is responding to a changing dew point.
Control	The unit is actively controlling the mirror temperature at a stable dew point.
Alarm*	The alarm has been activated.
Auto Cycle	The Auto Cycle cleaning and balancing cycle is active.
PACER	The PACER cleaning and balancing cycle is active.
Heating	Sensor Heating is active.
Cooling	Sensor Cooling is active.
Flooded	The sensor detected a major upset, and attempts to remove excess water.
*located at bottom center of display.	

3.4.1 Factory Default Settings

As shipped from the factory, the OptiSonde is normally programmed with the configuration shown in Table 2 below.

Function	Setting
Analog Output A Analog Output B	Humidity, <i>Units: Tdew °C, Range: -40°C to +60°C</i> Temperature, <i>Units: Tmp °C, Range: 0 to 100°C</i>
Alarm	Disabled, Humidity, <i>Units: Tdew °C, Set Point: Upper: 0.000, Lower:0.000</i>
Auto Balance	<i>Interval: Daily at 12:00 noon, Auto Cycle, Enabled.</i>
Data Field 1 Data Field 2	Humidity, <i>Units: Tdew °C</i> Temperature, <i>Units: Tmp °C (Dry bulb)</i>
Sound	On
Gas	<i>Molecular Weight of Gas: 28.9645 (typical for air)</i>
Communication Parameters	<i>Baud rate: 38,400</i>
Serial Outputs	Humidity, <i>Units: Tdew °C</i> Humidity, <i>Units: % RH</i> Temperature, <i>Units: Tmp °C</i>
Data Log [COMM]	<i>Status: Stopped, Interval: 60 second, Separator: tab, Parameters: Td °C, Ta°C, %RH; Flags: enabled*</i>
Data Log [FILE]	<i>Status: None/Stopped, Interval: 60 second, Separator: tab, Parameters: Td °C, Ta°C, %RH; Flags: enabled*</i>
Pressure	101.325 kPa (typical atmospheric pressure @ sea level).
*A status flag gives an indication, via the RS-232 interface, of the OptiSonde status, such as "Control" and "PACER," as well as the state of the alarm ("ALARM" or "_____").	

3.5 Sensor Balancing

During normal operation, the sensor mirror surface may become partially obscured with salts or other contaminants from the sample gas. The balance indicator displayed on the screen shows whether the system is operating near the center of its normal range, or has been forced away from the center by mirror contamination. In general, it is recommended to start with an **AUTO** balance cycle, provided relatively clean gases are being used. If the Service status indicator is displayed after an **AUTO** cycle, the mirror is likely still dirty and may require use of a **PACER** cycle (described in detail on page 64). In most applications, it is desirable to perform a balance operation periodically to maintain optimum performance. The interval and type of balance are configurable as described in the OptiSonde programming chapters.

If the Service indicator is displayed after a balance operation, the sensor may need to be adjusted (see *Minor Maintenance of Sensor Optics* on page 39).

3.6 Helpful Hints For Operating the Unit

Time response: At dew points above 0°C, the system stabilizes within a few minutes at a consistent dew layer. The status **Control** is displayed when the system is stable and readings are valid.

When the system is operating at low frost points (below 0°C), extra care may be required when interpreting readings because of the longer response times of the system. Time response depends on a number of factors including dew/frost point, slew rate, upstream filtering, and flow rate.

- As the dew/frost point becomes lower, water molecules in the air sample become scarcer, and it takes longer to condense a frost layer on the mirror thick enough to establish an equilibrium condition.
- Mirror temperature slew rate depends on dew point and depression (the temperature difference between the mirror and the sensor body); at higher dew points and moderate depressions, it is typically 1.5°C/second. At lower dew points and/or larger depressions, the slew rate is slower.
- Flow rate affects response by determining the rate at which water vapor is supplied or carried off.

There is, of course, a trade-off between response time, control system stability, and sensitivity to contamination.

3.6.1 Supercooled Dew Points

Slightly below the freezing point, water can exist in a supercooled liquid state for extended periods of time. Extra care may be needed when making measurements in the frost point region of 0 to -20°C , because the mirror temperature may temporarily stabilize at the supercooled dew point, 0.5 to 1°C below the actual frost point.

To assure that the unit is operating in the ice phase within this temperature range, allow the instrument to operate continuously. Before manually clearing a frost layer, take a reading, and afterwards allow sufficient time to reform a stable frost layer before taking further readings. The D2 has a viewport to enable viewing the mirror surface.

3.6.2 Contamination

3.6.2.1 Mirror Cleanliness

Proper operation of a condensation hygrometer depends on the condition of the mirror surface. In general, accuracy is reduced when contaminants accumulate on the mirror.

However, the mirror does not have to be microscopically clean. In fact, the mirror performs best a few hours after cleaning, when nucleation sites have formed. On an unscratched, freshly cleaned mirror, there are relatively few nucleation sites on which dew or frost deposits can form, and more time is required to collect a condensation layer at low frost points. Also, overshoot may occur, which can cause oscillations as the temperature stabilizes.

3.6.2.2 Particulate Contaminants

Particulate matter that is insoluble in water may accumulate on the mirror surface, but does not affect the instrument accuracy until the mirror reflectance is reduced substantially. In many cases, particulates improve instrument response by providing condensation sites.

3.6.2.3 Water-Soluble Contaminants

Contaminants which readily dissolve in water, such as naturally occurring salts, are detrimental to accurate vapor concentration measurement by any condensation method. These materials readily go into solution with the water condensate on the mirror surface, and then reduce the vapor pressure in accordance with Raoult's Law. As the concentration increases with time, the saturation vapor pressure of the liquid solution decreases.

The unit responds to this lower vapor pressure by elevating the mirror temperature in order to maintain a vapor pressure that is in equilibrium with the partial pressure of atmospheric water vapor. The displayed dew point, therefore, drifts upward above the true dew point. Because the measurement error increases gradually, it often goes undetected.

To determine whether dissolved contaminants are affecting dew point measurement, perform the following steps:

1. Note the indicated dew point.
2. Clean the mirror.
3. Balance the detector by initiating a **PACER** cycle.
4. Measure the dew point again.

If the new reading is lower than the first reading, it is likely that soluble material was present in sufficient quantity to cause a measurement error.

3.6.2.4 Gaseous Contaminants

When a gaseous material that has a higher condensation temperature than that of water is present (even in very low concentrations), the unit will eventually control on that material, rather than on water. The system then displays the condensation temperature of the contaminant, not of water. Such material accumulates on the mirror only when chilled. In the normal atmosphere, gaseous contaminants do not have a detectable effect.

3.6.2.5 Minimizing the Effects of Contaminants

The following steps are suggested for maintaining optimum performance:

- Use the **PACER** feature to reduce the effect of contaminants on the unit's performance (see *The PACER Cycle* on page 64).
- Reduce the gas flow rate to reduce the rate of accumulation of contaminants on the mirror.

- Clean the mirror according to the recommended optics cleaning procedure (see *Minor Maintenance of Sensor Optics* on page 39). To determine the proper cleaning interval for a given set of conditions, take a dew point reading before and after the cleaning. Any appreciable shift indicates that under these conditions, the mirror should be cleaned more often.

3.6.2.6 Mirror Flooding

If there is an abrupt transition from dry to moist conditions (particularly when accompanied by a transition from cold to warm temperatures), the mirror may accumulate an overload of moisture. It then may take several minutes before the sensor dries out and valid readings can be obtained. The drying process can be accelerated by heating the sensor.

3.6.2.7 Sample Line Maintenance

Contaminated sample lines slow the unit's response time and can cause erroneous readings, usually on the high side. Clean the sample lines as often as necessary. To determine the required cleaning frequency, take dew point readings before and after cleaning the lines, sensor cavity, and mirror. If the two readings differ appreciably, the sampling lines should be cleaned more often. To reduce the rate of contamination, reduce flow and/or install a filter upstream.

3.6.2.8 Pressure Effects

If the pressure of the gas is increased or reduced from atmospheric pressure, but the mixing ratio (moisture content) stays constant, the dew point is correspondingly increased or decreased. The OptiSonde displays the dew/frost point at the pressure to which it has been programmed. The sensor location and hookup arrangement can influence the pressure.

The dew point change due to pressure change can be calculated by using psychrometric equations. Appendix C contains basic data for these calculations.

Chapter 4. Programming the OptiSonde

4.1 Introduction

The OptiSonde can be easily programmed to choose the data to be displayed, the data to be output on the analog or serial outputs, and the alarm settings. A typical data display appears in Figure 20 below:

Menu: ESC	Control ▲
e_{mbar}	6.0179
$T_a^{\circ\text{C}}$	+25.09
	14:33

Figure 20: OptiSonde Typical Data Display

Table 3 below lists the OptiSonde's programmable functions. Each function has a number of settings (listed on the following pages). Values for some settings are selected from a list of choices; others are entered as numeric or alphanumeric data using the keypad.

Function	Settings
Display	Select units for parameter display
Outputs	Select units and scaling, test and trim values
Alarms	Alarm type and alarm limits
Logs	Selection of logging card or PC logs, parameter choice, units/data format
Settings	Automatic balance, sound, communications, offset values, gas molecular weight, clock, line pressure, recalibration reminder
Service	(Service personnel only.)
About	Displays ID number, system status and software version
LOCK	Locks keys.

4.2 Programming Technique

The functions of the six keys to the right of the display change according to the current state of the unit.

Below is the general method for programming the unit:

1. To access the programming menus, press the **ESC** key. If the OptiSonde keys are locked, press the **ESC** key, followed by the **ENT** key, and then press the **ESC** key again. Then press **ESC** again to enter the Main Menu.
2. Press the [▲] and [▼] keys to step through the functions that can be programmed (shown in Table 3 on page 1). You can also use the [◀] and [▶] keys for adjacent choices.
3. For a particular function, press the **ENT** key to display the first setting for the function. Press the [▼] key to step through its available settings.
4. For a particular setting, press the **ENT** key to open the setting for editing.

If the setting uses a list of specific choices, the [▼] key and/or [▲] key are shown. Press them to step through the choices.

Note: To enter numeric data, use the arrow keys to scroll to the appropriate column; then use the [▲] and [▼] keys to scroll to the desired numeric value. Note that certain settings have numeric values that are restricted to certain ranges.

5. After choosing a value for a setting, press **ENT** to lock it in.

Or, you can press the **ESC** key to cancel the entry (restoring the original value) and return to choose another setting.

To return to the function choice, press the **ESC** key.

A typical programming screen (for setting the Analog Outputs) is shown in Figure 21 below.

Output Menu	[Out A]
Select	Tracking
Units	Test
Upper	Trim
Lower	

Figure 21: Typical Analog Outputs Programming Screen

4.3 Programmable Functions

4.3.1 Display

For display, the menu first requires that you select Line 1 or Line 2. You can then select from the display parameter units listed in Table 4 below.

Units	Description
Td °C	Dew/frost point temperature in degrees Celsius
Td °F	Dew/frost point temperature in degrees Fahrenheit
% RH	Percentage of relative humidity
Ta °C	Temperature in degrees Celsius (dry bulb)
Ta °F	Temperature in degrees Fahrenheit (dry bulb)
e mbar	Water vapor pressure in millibars
Tw °C	Wet bulb temperature in degrees Celsius
Tw °F	Wet bulb temperature in degrees Fahrenheit
PPMv	Parts per million by volume
ΔT °C	Delta temperature (Ta-Td, or the difference between temperature and dewpoint) in degrees Celsius
ΔT °F	Delta temperature (Ta-Td, or the difference between temperature and dewpoint) in degrees Fahrenheit
PPMw	Parts per million by weight
AH g/m ³	Absolute humidity in grams per cubic meter
AH gr/f ³	Absolute humidity in grains per cubic foot

Under **Decimal**, you can select the number of decimal places (up to three) for the parameter shown in each line. You can also select **Reverse** to change the screen display from the default of blue letters on a white background to white letters on a blue background.

4.3.2 Analog Outputs

Setting	Description	Available Options
Select	Choose which output channel you will program.	A or B
Units	Choose the units for scaling the parameter on the selected channel	See Table 4 on the previous page for the available units.
Type	Choose the type of output.	4-20 mA, 0-20 mA
Upper	Set the parameter value that will produce full-scale output (span) for the selected channel.	Enter a number.
Lower	Set the parameter value that will produce zero output for the selected channel.	Enter a number.
Tracking	Determine how to handle analog output	Track (transmits actual temperature of the mirror), Hold (transmits the last prevailing dew point before balance cycle)
Test	Set the parameter value to test the output channel for proper operation.	Enter a number as a percent of scale.
Trim	Set values (in zero and span) to compensate for variation in outputs.	Enter a number.

4.3.2.1 Trimming the Output:

1. Attach a precision DVM (digital voltmeter) or mA calibrator to the 4-20 mA output.
2. Select **RESET TRIM**. The options available are **TRIM ZERO** and **TRIM SPAN**.
3. Select **TRIM ZERO**. The output changes to 4.00 mA.
4. Enter the actual value *as read* from the DVM/calibrator.
5. Select **TRIM SPAN**. The output changes to 20.00 mA.
6. Enter the actual value *as read* from the DVM/calibrator.
7. Exit the **TRIM** setting. You have completed output calibration.

4.3.3 Alarms

For more information on using the alarms, see *Alarm Outputs* on page 11.

Setting	Description	Available Options
Status	Enable or disable the alarm.	Off/On
Units	Set the units for the parameter.	See Table 4 on page 3.
Type	Set the type of condition that will activate the alarm.	Set Point, Inner Band, Outer Band, Control, Service, PACER
Upper	The maximum alarm value.	Enter a number.
Lower	The minimum alarm value.	Enter a number.
Tracking	Determine how to handle alarm	Track (responds to actual temperature of the mirror), Hold (responds to the last prevailing dew point before balance cycle)

The Upper and Lower limits set the alarm thresholds. Alarm types are listed below (see details on page 11):

- SetPoint: Alarm activates when parameter exceeds upper limit; deactivates when parameter is less than lower limit.
- Inner Band: Alarm activates when parameter is between upper and lower limits.
- Outer band: Alarm activates when parameter is outside upper and lower limits.
- Control: Alarm activates when the OptiSonde is actively controlling mirror temperature.
- Service: Alarm activates when the Service indicator is activated.
- PACER: Alarm activates when the **PACER or AUTO** balance is active.

4.3.4 Logging OptiSonde Data

Logging OptiSonde data requires use of either the supplied secure digital (SD) card (installed internally), or Panametrics's PanaView program.

- To use PanaView to log data, refer to the *PanaView User's Guide*.
- To create OptiSonde logs, complete the steps below:
 1. From the Main Menu, enter **Logs**.
 2. Enter **Select** and enter either **File** (for a log stored on the internal SD card) or **Comm** (for a log stored on the PC). Press **ENT**. The current selection is part of the Logging menu header.

OptiSonde can run two logs at any one time, one for the SD card and one for the PC. (The two logs can measure different parameters.) To switch between the logs, return to **Select** and enter either **File** or **Comm**. If you start another log on either **File** or **Comm**, OptiSonde automatically closes the previous log.

3. To enter logging parameters, enter **Units**. You can select any combination of the units available in Table 4 on page 3 for up to eight units. Press **ENT** to confirm your selections.
4. To select the logging interval, enter **Interval**. You can then enter the output interval in seconds (up to 86400). Press **ENT**.
5. To select the output format, enter **Format**. You can then choose from three output formats.
 - x = #.# will display as "TdewC = -12.345"
 - #.# () will display as "-12.345 (TdewC)"
 - #.# will display as "-12.345"
6. To select the field separator, enter **FieldSep**. You can then choose from **CR-LF**, **Comma**, and **Tab**.
7. You can now start the log:
 - To start a new internal (File) log with these parameters, enter **Manage>New Log>Start**. OptiSonde begins to log data. (The log name is always the current date and time when logging begins.)

Note: The **Manage** option is only available for internal (File) logs.

- To start a PC (Comm) log, enter **Status>Start**.

4.3.4.1 Managing Current or Completed Logs

Once the log is running, you can either stop or close it. If you are running both File and Comm logs, enter **Select** and be sure you have chosen the log you want to stop. Then enter the **Status** option.

- Enter **Stop** to stop the log from recording further data. Once you have stopped it, you can restart it by selecting **Start**.
- Enter **Close** to permanently stop and complete the log. Only closed logs can be erased.

You can retain an internal (File) log in the SD, transfer it to the PC, or erase it.

- To transfer a log to the PC, enter **Manage>Transfer**. Then select the log from the list of logs, and press **ENT**.
- To erase a log from the SD, enter **Manage>Erase**. Then select the log from the list of logs, and press **ENT**.
- The OptiSonde will display up to 8 log files for management. However, up to 512 log files can be stored on the SD card. You should erase logs from the SD card when they have been safely transferred to a PC for storage.

4.3.4.2 Logging Parameters

Setting	Description	Available Options
Status	Select whether to start or stop transmitting data.	Start (start new or currently running log), Stop (stop currently running log), Close (stop and complete log; once closed, the log cannot be reopened).
Select	Select logging on PC or SD (secure data) card	File (log on internal SD card), Comm (log on PC)
Manage (Internal or File logs only)	Handle individual logs.	Details (displays file name, interval and size), Transfer (transfer closed log to PC), New Log (set up new log), Erase (delete log from OptiSonde)
Units	Set up to eight units to log.	See Table 4 on page 3.
Interval	Enter the output interval in seconds (for Serial Mode: All).	Enter a number (up to 86400).
Format	Choose the output format.	X=#.#, #.#(), #.#
Field Separator	Choose the separator to be used between parameters.	CR-LF, Comma, Tab
Flags	Enable logging of status (Control, PACER, Flooded, etc.) and alarm state (Alarm/-----)	On, Off

4.3.5 OptiSonde Settings

Setting	Description	Available Options
Balance	Set up type and interval of mirror cleaning and balancing	See <i>Automatic Cleaning and Balancing</i> on page 35.
Comms	Set up baud rate and node ID for RS232 communications.	Baud Rate (from 1200 to 115,200), Node ID (from 1 to 239, with default of 16), Test (small check confirms RS232 communications are working)
Sound	Select whether the OptiSonde produces a sound when users press the keypad.	Off/On
Adjust	Enter the offset values for the Dew Point, Temperature and Filter parameters.	Enter the values by which the parameters will be offset.
Gas	The molecular weight of the gas being analyzed. (The default value is the molecular weight of air: 28.9645 g/mole)	Enter a number.
Clock	Enter the current time and date.	Enter the time (hours and minutes) and the numeric date (month, date and year).
Pressure	Pressure value to be used.	Enter line pressure in kPA.
Notify	Enter a time at which the OptiSonde should be recalibrated.	Off, 6 Months, 12 Months, 18 Months, 24 Months

4.3.6 Automatic Cleaning and Balance Function

OptiSonde analyzers can run the **Auto** or **PACER** self-cleaning and rebalancing cycles at a preset time after the last cycle was run. The automatic balance cycle will always run upon power up of the analyzers. To program the *Automatic Cleaning & Balance Function* on the OptiSonde:

1. From the main screen:
 - a. Press the **ESC** key to enter the Main Menu.
 - b. Scroll to **Settings** and press **ENT**.
 - c. Enter the **Balance** option.
2. Set the Balance **Type**:
 - a. Enter **Type**.
 - b. Enter either **AUTO** or **PACER**. Table 9 below explains the difference between the options.

Item	Function
AUTO	Heats the mirror and balances the optics.
PACER	First cools the mirror to develop a thick dew/frost layer, then heats and balances the optics.

4.3.6 Automatic Cleaning and Balance Function (cont.)

Note: The **PACER** function will provide more thorough cleaning than the **AUTO** function because it first develops a thick dew/frost layer into which soluble contaminants dissolve. When heated, some of the contaminants are flash evaporated and the remaining residue accumulates in clusters, resulting in the cleaning of much of the mirror's surface. The **PACER** cycle generally takes longer to complete.

3. Select whether or not you will use **Auto Balance**.
 - a. From the **Balance** menu, enter **Status**.
 - b. Enter **Off** or **On**
4. Determine the **Interval** at which the OptiSonde will perform cleaning and balancing.
 - a. From the **Balance** menu, enter **Interval**.
 - b. Use the arrow keys to enter the interval time in days (or decimal fractions of days), up to 90 days. Press **ENT**.
 - c. If using an interval of whole days (e.g., 1.000, 3.000), use **Time** to specify the time of day to perform the balance. Enter time in 24-hour format (e.g., 8:00 p.m. = 2000, 10:30 a.m. = 1030).
5. To view the most recent and next cleaning and balance times, enter **Schedule**.
6. Press **ESC** to exit the Balance Menu and the Main Menu for the settings to take effect.

IMPORTANT: For environments or a gas sample where the mirror accumulates contamination rapidly, the use of an inline filter is recommended. Lower flow rates will also reduce the accumulation of contaminants.

4.3.6.1 Cleaning and Balancing Options

Setting	Description	Available Options
Type	Select type of mirror cleaning and balancing	Auto (Automatic), PACER
Status	Select whether or not to use Auto Balance	Off, On
Interval	Enter time to balance mirror (in days or decimal fractions of days).	Enter value (up to 90.0 days).
Time	Enter time of day to balance (whole day intervals only).	0000 = midnight, 1200 = noon 2359 = 11:59 p.m.
Schedule	Lists last day and time of balance and next scheduled time and day of balance.	(None)

4.3.6.2 Communications Parameters

Setting	Description	Available Options
Baud	Set the baud rate to be compatible with the receiving device.	1200, 2400, 4800, 9600, 19200, 38400, 57600, 115,200 (Note: 38400 is the default value for PC communications.)
Node ID	Select Node ID number for PanaView transmission	1 to 239 (Note: The default PanaView node ID is 16.)
Test	Run test of RS-232 communications.	(After test, a check in lower right corner of screen indicates correct operation; a short message will be transmitted.)

4.3.7 Service Options

IMPORTANT: The Service menu is intended for factory-trained personnel only, and access is limited by requiring a service passcode. This menu allows the factory default data, including calibration data and sensor parameters, to be adjusted. Please contact an applications or service engineer at Panametrics if access to these menus is required. Normal operation of the OptiSonde does not require access to the information contained in the Service menu.

4.3.8 System Information

Setting	Description	Available Options
ID	Lists unit and sensor ID numbers.	(None)
System Status	Lists current uptime, last calibration date, last balance date and time.	(None)
Software Versions	Lists current boot and program versions.	(None)

4.3.9 Locking the System Keys

If you press **ENT** when **LOCK** is highlighted, the OptiSonde keys will be locked, preventing access to the Main Menu. To unlock the keys, press **ESC**, **ENT**, and **ESC**. (Press **ESC** again to reenter the Main Menu.)

[no content intended for this page]

Chapter 5. Maintenance

5.1 Minor Maintenance of Sensor Optics

Periodically inspect and maintain the sensor optics as described in the following chapter. These procedures can be performed at any time, but are only necessary when the **Service** indicator appears on the status display, indicating that service is required.

5.1.1 Cleaning and Balancing the Sensor Mirror

Under normal conditions, the system is self-checking and self-balancing. However, there are occasions when particulate matter and water-soluble contaminants reduce sensor mirror reflectance and system accuracy (see *Contamination* on page 26). Three features of the OptiSonde system allow users to monitor and adjust the mirror:

- The balance indicator (shown in Figure 22 below) provides a graphic display of how much light is received by the mirror's photodetector. It is also an indicator of the dew layer thickness. This indicator increases and decreases in digital steps.
- The bias screw adjusts the light signal received by the reference photodetector and is used as a "coarse adjustment."
- The automatic balance, or PACER cycle (discussed on page 3), electronically fine tunes the optical balance between the IR emitters and reference photodetectors.

In operation, the position of the balance indicator will depend on the level of humidity and the sensor used. As the humidity changes, the chilled mirror system will seek to establish control.

As contaminants deposit on the mirror, the balance indicator will increase, as will the dew point readings. The **PACER** cycle or manual cleaning and balancing (followed by the **PACER** cycle) will mitigate the contamination.

Note: *If the mirror is severely scratched or pitted, you may not be able to balance it. It may be replaced in the field, as discussed on page 42. For industrial applications, Panametrics recommends the solid platinum mirror.*

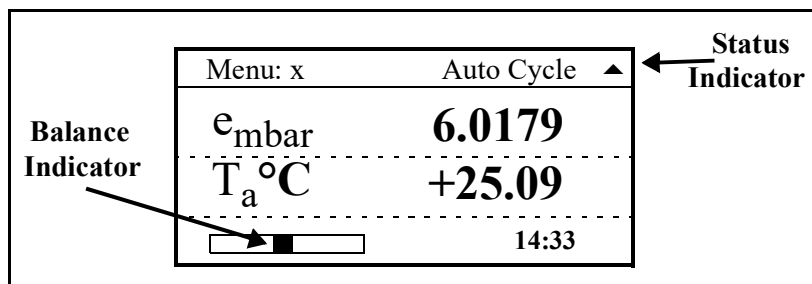

Figure 22: Balance and Status Indicator on OptiSonde Display

5.1.2 Procedure for Cleaning and Balancing the Sensor Mirror

When necessary, use the procedure below to clean and balance the sensor mirror. To clean the mirror, you will require the MSK-2 Maintenance Kit, which includes essential supplies:

- Cotton swabs
 - Screwdriver or hex driver for some sensors
 - Cleaning solution
1. From the OptiSonde analyzer, press the **ENT** key. The Select Function window appears. Press the up arrow key to reach **HEAT**.
 2. Allow the dew point temperature (mirror temperature) to attain the maximum value.
 3. To clean the mirror:
 - a. Remove the cap or open the cover of the chilled mirror sensor.
 - b. Put one drop of cleaning solution on a cotton swab.
 - c. Gently rub the cotton swab on the mirror in a circular motion (spiral outwards) to clean the mirror.
 - d. Use a dry swab to dry and buff the mirror. The mirror should be bright and shiny.
 - e. Discard the used swabs.

IMPORTANT: If the contamination is severe, then solvents such as alcohol, acetone or hexane may be used, followed by a rinse of the cleaning solution then distilled water. Be sure to dry and buff the mirror with a dry swab.

4. Observe the balance indicator. For a dry, clean, balanced mirror, the bar should be at the midpoint of the scale, as shown in Figure 23a below. A wet mirror will have a bar similar to Figure 23b, and a mirror requiring bias adjustment will appear similar to Figure 23c below. Adjust the bias screw to move the gray block as close as possible to the solid center block.

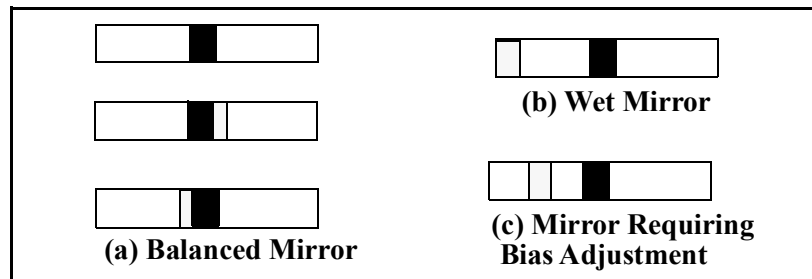

Figure 23: Balance Indicator for Various Mirror Conditions

5.1.2 Procedure for Cleaning and Balancing the Sensor Mirror (cont.)

5. If the square is not in the center of the balance bar, use the screw or hex driver to adjust the optical bias screw (shown in Figure 24 below) on the sensor until the marker is in the center of the bar. You are performing a coarse balance adjustment.

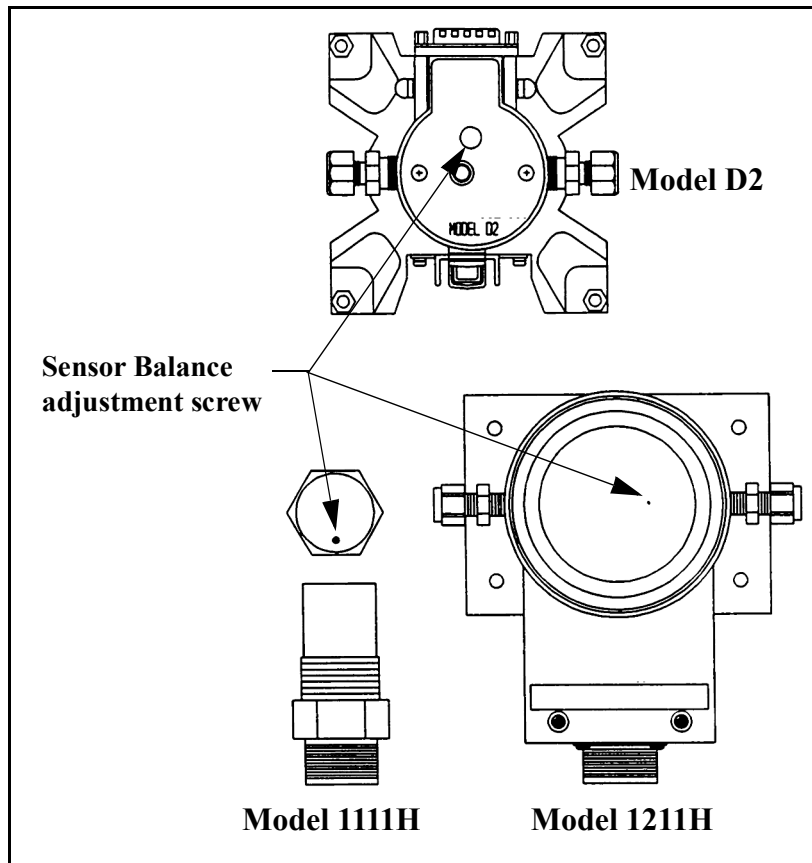

Figure 24: Balance Adjustment Screw Locations

IMPORTANT: This adjustment is made while the cap or cover is on the 1111H & D2 sensors. For the 1211H, SIM-12H, and 1311-DR, the adjustment is made with the cap removed. In these cases the adjustment should not be made in sunlight, bright incandescent or infrared light. It might be useful to shade the sensor cavity with your hand or place a coin over the sensor cavity.

5.1.2 Procedure for Cleaning and Balancing the Sensor Mirror (cont.)

6. Once balanced, replace the sensor cap and make sure the balance indicator does not change.
7. On the OptiSonde analyzer, enter the Function Control screen to reach AUTO.

If the "Automatic Balance" is set for "Pacer," the system will first cool, then heat. If the unit is set for "Auto," it will only heat. The system will then automatically fine tune the optical balance. The word **Balance** will appear in the lower left of the display, followed by the phrase **Acquiring**.

The unit will then cool to the dew point and the balance indicator will increase when dew or frost condenses on the mirror. The dew point reading might overshoot, then it will stabilize (assuming the sensor is exposed to constant humidity).

When a stable dew or frost layer is attained, you will see the word **Control** in the lower left. The OptiSonde is now reading the correct dew/frost point and a stable dew or frost layer has been established. When the OptiSonde is exposed to typical room humidity, this process takes 5-6 minutes. For very dry conditions, the unit may not display **Control** for several hours; however, the PACER indicator will go out. The sensor must first accumulate a dew or frost layer on the mirror before it can display **Control**.

During large changes in moisture, the **Control** indicator may change to **Tracking**. This is normal, and indicates that the OptiSonde is tracking the moisture level. When the moisture level stabilizes, the control indicator will reappear.

8. If you see the word **Service Req** displayed in the lower left, repeat steps 1-7.

5.2 Field Replacement of Sensor Mirrors

One advantage of using a Panametrics chilled mirror dew point sensor is that the mirror is user-replaceable. The sensor does not have to be returned to the factory for replacement of the reflective surface, unless that is desired.

A mirror may require replacement for any of the following reasons:

The mirror is constructed of silver/rhodium plated copper. Copper provides excellent thermal conductivity to the platinum thermometer. However, some gas constituents, such as sulfur dioxide (SO₂) may react with the copper and eventually pit the surface or form a copper sulfate coating.

The reflective surface may be gradually abraded by sharp dirt particles in the gas being measured.

The mirror surface may be accidentally scratched or gouged during use or cleaning.

If the sensor mirror has reacted with a corrosive material in the gas sample, such as an acid or sulfur compound, it should be replaced with a solid platinum mirror to remove any possibility of copper corrosion.

In extreme cases, a solid platinum mirror can make possible a successful application of chilled mirror technology. For example, measurements in tobacco factories and malting houses have drastically improved after this change, since both locations have sample gas constituents that attack copper.

5.2.1 Replacing the Sensor Mirror

Required equipment: torque driver, set to 20–30 inch-ounces of torque. Panametrics Measurement & Control Solutions type TW-1 is recommended.

The kit supplied by the factory contains the replacement mirror, a container of white thermal compound for proper heat transfer, and (in some models) a mylar washer that is to be placed under the mirror.

1. Deactivate the sensor cooler, using one of the following actions:
 - Turn the sensor power off, or
 - Place the sensor switch to heat, or
 - Disconnect the sensor cable
2. Turn off the sample gas. Make sure the sensor cavity is depressurized before continuing with the next step.
3. Open the sensor by removing the sensor cover.
4. Unscrew and discard the old mirror, using a 3/16-inch (0.187) hex socket.
5. Use a toothpick or similar tool to place a small amount of thermal compound in the hole supporting the mirror.

CAUTION! Do not apply thermal compound to the mirror stem.
Do not use an amount large enough to leak out when the mirror is tightened.
Do not allow any compound to get on the mirror surface, as it is very difficult to remove completely.

6. Carefully screw in the new mirror and tighten to the proper torque as specified for the particular sensor.
7. Carefully clean the mirror surface, using a cotton swab and the Panametrics cleaning solution supplied with the maintenance kit. Distilled alcohol or diluted alcohol is also acceptable.
8. Replace the cover and return the sensor to normal operation. Under some circumstances, a new mirror may operate in a somewhat unstable manner for the first hour or two.

5.3 Test and Calibration

The procedures in this section effectively test and/or calibrate the following aspects of the OptiSonde:

- Startup and power supply voltage
- Normal sensor operation
- Front panel display
- Digital and analog outputs.

The unit has been completely tested and calibrated at the factory, and is ready to plug in and operate. As shipped, it meets all of our published specifications. When ordered as a complete hygrometer system with a chilled mirror sensor and cable, it is verified at a number of points against a dew point system that has been certified by the U.S. National Institute of Standards and Technology (NIST). A Certificate of Compliance is supplied with the unit to indicate traceability.

5.4 Troubleshooting

5.4.1 The Display Doesn't Light Up

1. On the benchtop model, check the **POWER** switch on the rear panel. Make sure it's **ON**.
2. Check the line cord. Make sure both ends are plugged in and that it is plugged into a proper source of AC voltage.
3. Check the power supply. Make sure it is connected and has the proper output voltage.
4. Check the fuse. Make sure the proper fuse size is installed. Make sure the fuse is not open.

5.4.2 "Service" Appears on the STATUS Display Line

The text "**Service Req**" displayed on the **STATUS** line means service is required. The most frequent problem requiring service is that the mirror surface is contaminated and should be cleaned.

Clean and balance the sensor mirror (refer to *Minor Maintenance of Sensor Optics* on page 39). Next, run the instrument through a PACER cycle. If, at the end of the cycle, the **Service Req** status appears again, repeat the cleaning and balancing procedure, or contact the factory.

5.4.3 Incorrect Dew Point Display

If the dew/frost point reads incorrectly, first check the standard preventive maintenance items:

Clean and balance the sensor mirror (refer to page 39).

An alternative method for checking the accuracy of the unit's electronics is to use a precision resistance decade box in place of the platinum thermometer. Wire the decade box to the unit's sensor connector as shown in Figure 25 on the next page, and verify that the resistance settings shown in the table produce the temperatures shown.

5.4.3 Incorrect Dew Point Display (cont.)

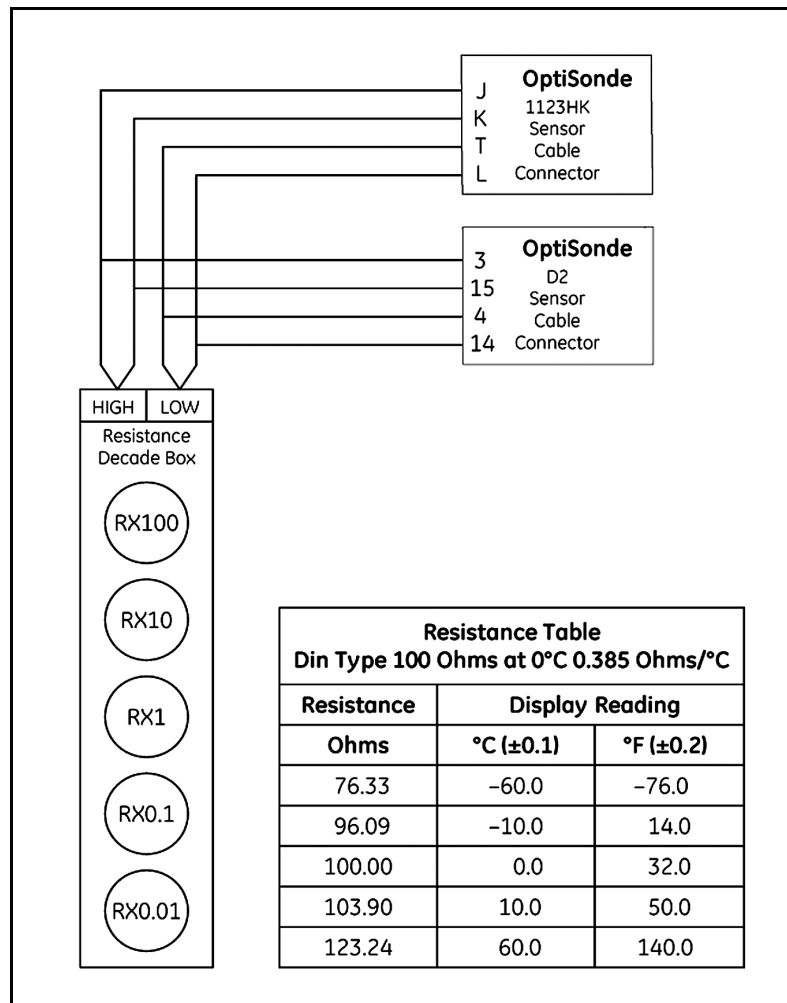

Figure 25: Using a Resistance Decade Box

5.4.4 "Balance" Remains on the Status Line

Check that the sensor and sensor cable are connected. If necessary, connect them, and the unit will complete the PACER cycle after a short time (5 to 15 minutes).

The sensor bridge may be out of balance (refer to page 39).

5.4.5 No Analog Output

If there is no analog output, but the digital display indicates correctly, check the analog output scaling.

5.4.6 No Serial Output

Check the serial port programming for proper settings.

[no content intended for this page]

Appendix A. Specifications

A.1 Performance

A.1.1 Accuracy

[complete system at 25°C (77°F)]

A.1.1a Dew/Frost Point:

±0.2°C (±0.36°F)

A.1.1b Temperature:

±0.15°C (±0.27°F)

A.1.1c Relative Humidity:

Governed by accuracy of dew point and temperature sensors

A.1.1d Other Humidity Parameters:

Governed by accuracy of dew point, temperature and pressure sensors

Sensitivity. 0.05°C (0.09°F)

Repeatability. ±0.1°C (±0.18°F)

A.1.2 Measurement Ranges

A.1.2a Chilled Mirror Sensors: (available)

1111H, 1111H-Panametrics, 1211H, D-2, SIM-12H, 1311DR

A.1.2b Range:

one-stage 45° depression @25°C and 1 ATM
 two-stage 65° depression @25°C and 1 ATM
 dew/frost point, depending on sensor used
 Heated Two Stage: 85°C at 75°C Body Temperature and 1 Bar
 Four Stage: 95°C at 25°C and 1 Bar (Air Cooled)
 Four Stage: 105°C with 15°C Coolant at 25°C and 1 Bar (Liquid Cooled)

A.1.2c Temperature Sensor:

T-100E: -100°C to +100°C (-148°F to +212°F)

Recommended Sample Flow. 0.5 to 2.5 scfh (0.25 to 1.25 L/min)

A.1.3 Response Time

A.1.3a Dew/Frost Point Cooling Rate:

1.5°C (2.7°F)/sec [typical, above 0°C (32°F)]

A.1.3b Temperature Response:

< 7 sec for step change within +25°C to +70°C (+77°F to +158°F)

A.1.4 Update Time

1 sec

A.2 Functionality

A.2.1 Outputs

Two linear simultaneous parameters, 0/4–20 mA (isolated) with 250 Ω or 500 Ω maximum load resistance

A.2.2 Digital Interface

RS-232

A.2.3 Alarms

A.2.3a Relay (optional):

Form C (SPDT) 7 A, 30 VDC (resistive load)

A.2.4 Display

128 X 64 pixel monochrome LCD

A.2.5 Power

100–240 VAC (+/-10%), 50–60 Hz

18 (minimum) –32 (maximum) VDC (benchtop only on special order)

A.2.6 Operating Ranges

A.2.6a Dew Point Sensors

Ambient Temperature: –15°C to +80°C (+5°F to + 176°F), depending on sensor

Pressure: 0 to 300 psig (0 to 22 bar), depending on sensor)

A.2.7 Electronics

A.2.7a Temperature:

–10°C to +60°C (+14°F to +140°F)

A.2.7b Relative Humidity:

85% maximum

A.3 Physical (Bench Mount)

A.3.1 Dimensions

3.7" H × 8.0" W × 8.8" D (9.4 cm × 20.3 cm × 22.4 cm)

A.3.2 Weight

3 lb (1.4 kg)

A.3.3 Environmental

IP-20

A.4 Physical (Wall Mount)

A.4.1 Dimensions

10.48" H × 8.2" W × 4.5" D (26.6 cm × 20.8 cm × 11.4 cm)

A.4.2 Weight

5.3 lb (2.4 kg)

A.4.3 Environmental

IP-65

A.5 Optional Accessories

A.5.1 PTFE-Panametrics

Filter for 1111H-Panametrics PTFE

A.5.2 FM-1

Rotameter

A.5.3 BF12SS

Inline filter

Specifications subject to change without notice.

[no content intended for this page]

Appendix B. Humidity Equations and Conversion Chart

B.1 Introduction

The following symbols appear in the equations below:

e = Vapor Pressure, millibars

e_i = Vapor Pressure with respect to ice, millibars

e_w = Vapor Pressure with respect to water, millibars

e_{is} = Saturation vapor pressure, ice, millibars

e_{ws} = Saturation vapor pressure, water, millibars

P = Total Pressure, millibars

T = Temperature, °C

T_a = Ambient temperature, °C

T_d = Dew point temperature, °C

T_f = Frost point temperature, °C

B.2 Vapor Pressure

Saturation vapor pressure with respect to water is a function of temperature only and is given by the following:

$$E_{WS} = 6.1121 \text{EXP} \left[\frac{17.502T}{240.97 + T} \right]$$

Saturation vapor pressure with respect to ice requires a minor adjustment of the constants as given by the following:

$$E_{IS} = 6.1115 \text{EXP} \left[\frac{22.452T}{272.55 + T} \right]$$

In addition to yielding saturation vapor pressure as a function of ambient temperature, the above equations also yield ambient vapor pressure as a function of dew/frost point.

The total pressure of a gas mixture is equal to the sum of the partial pressure each gas would exert, were it to occupy the same total volume, according to Dalton's law.

B.2.1 Humidity

Relative Humidity is defined as the ratio of the water vapor pressure (e) to the saturation vapor pressure (e_s) at the prevailing ambient or dry bulb temperature (T_a):

$$\%RH = 100 \left(\frac{E}{E_S} \right) = 100 \left[\frac{E_W(T_D)}{E_{WS}(T_A)} \right]$$

Absolute humidity is expressed as water vapor density: water vapor mass per unit volume of dry air, according to the following:

$$\frac{G}{M^3} = \frac{216.7E(T_D)}{T + 273.16}$$

Water vapor content expressed as parts per million by volume is given by the following:

$$PPM_V = 10^6 \frac{E(T_D)}{P}$$

Expressing water vapor content as parts per million by weight (or mixing ratio) requires multiplication of the above by the ratio of the molecular weight of water to that of air as given by the following:

$$PPM_W = 10^6 \frac{E}{P - E} \times \frac{18}{\text{mw of carrier gas for air (24 g/mole)}}$$

See Figure 26 on page 53 for a graphical humidity conversion chart.

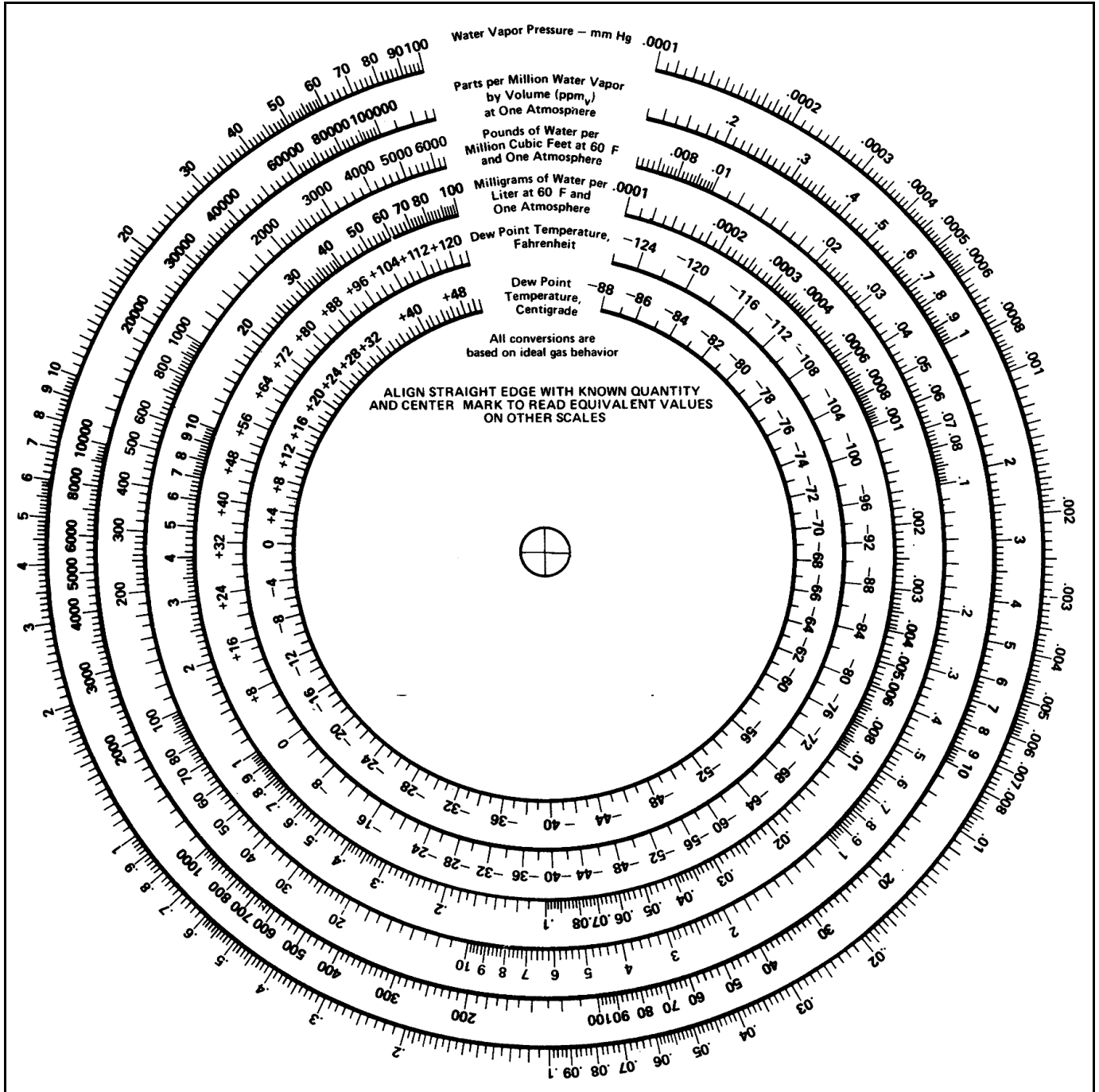

Figure 26: Graphical Humidity Conversion Chart

[no content intended for this page]

Appendix C. Configuring the Serial Interface

C.1 Wiring to a Personal Computer

The OptiSonde is configured as Data Terminal Equipment (DTE). The following pins are used in the serial interface:

- 2 - Transmitted data (**TXD**)
- 3 - Received data (**RXD**)
- 5 - Signal ground (**GND**)

To send the output of a benchtop OptiSonde to a personal computer, use the cable arrangement shown in Figure 27 below. For a wall-mount OptiSonde, use the wiring shown in Figure C-2 on the next page.

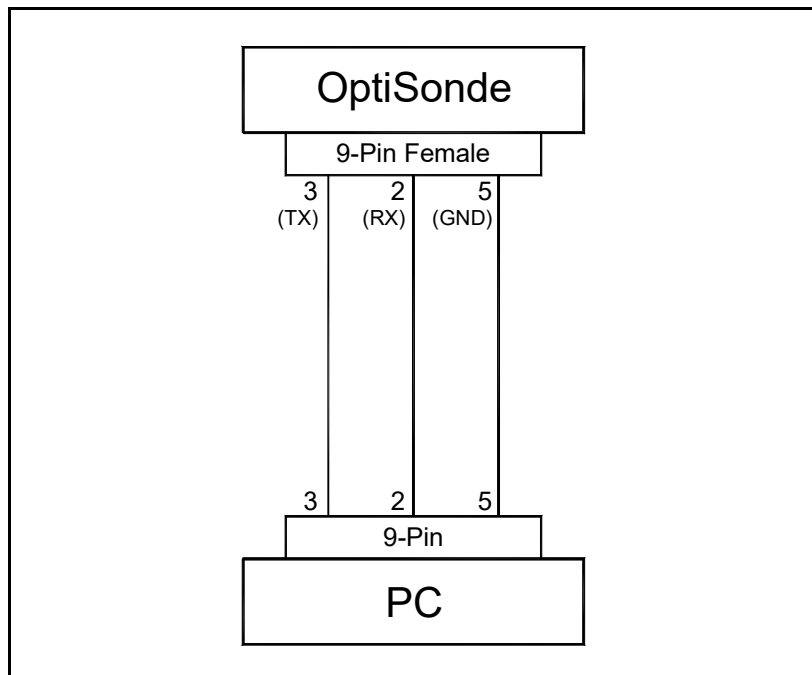

Figure 27: Wiring Diagram - Benchtop OptiSonde to PC

C.1 Wiring to a Personal Computer (cont.)

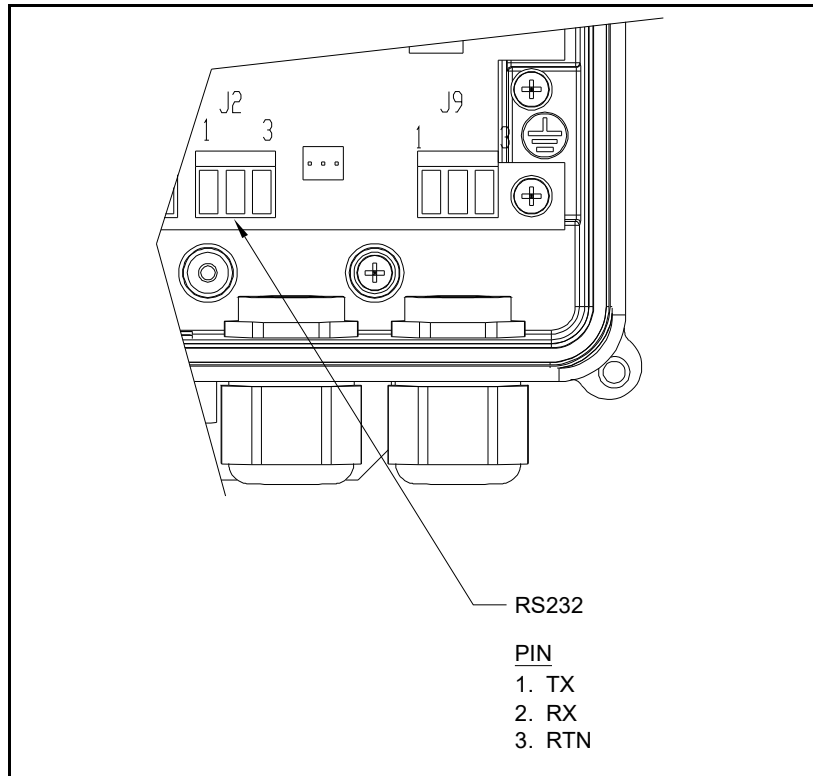

Figure 28: Wiring Diagram - Wall-Mount OptiSonde to PC

Appendix D. Chilled Mirror Sensors

D.1 Introduction

Panametrics Measurement & Control Solutions offers a choice of six, fully interchangeable, chilled mirror sensors which differ primarily in their depression (cooling) capability. Depression capacity determines the minimum dew point that can be measured. All of the sensors feature low-noise, infrared optics, a field-replaceable mirror, and can be located up to 300 ft (91 m) from the electronics. Other advanced features—depending on the sensor selected—include heating capability, four- or five-stage thermoelectric cooling, air and water cooling for additional depression, and modular, field-replaceable optics and cooling assemblies.

Many of these features were pioneered by Panametrics, and are available only on Panametrics Measurement & Control products.

A chilled mirror sensor is generally selected so that its depression capability will allow it to measure the lowest dew/frost point anticipated for the application.

D.2 Depression

A Peltier device is a solid-state heat pump. It has one surface thermally bonded to the body (base) of a dew point sensor and the other surface bonded to the mirror block. When current is supplied to the Peltier device, heat is “pumped” from the mirror block to the sensor body where it is dissipated. With full cooling current, the mirror block will eventually cool to its minimum temperature. The difference between the temperatures of the mirror block and the sensor body when the mirror block is at this minimum temperature is defined as the depression capability of the sensor.

Depression capability is a function of how many “stages” the Peltier device has stacked in series. Thus, a two-stage sensor typically has 60°C to 65°C (108°F to 117°F) of depression capability, and can measure lower dew/frost points than a one-stage sensor which has 45°C (81°F) of depression capability. Depression is normally specified at 25°C (77°F) ambient temperature. For liquid-cooled sensors, it is specified at the coolant temperature. As ambient temperature (and, therefore, sensor body temperature) is decreased, depression capability also decreases, due to the drop-off in efficiency of the thermoelectric cooler.

Therefore, there are limitations to using liquid-cooled sensors to increase low-end measurement range. At nominal dew/frost points, approximately one third of the additional cooling is lost due to cooler inefficiency, and does not result in additional measurement range. At low dew/frost points, as much as one half may be lost. As ambient temperature is increased, depression capability increases, resulting in a wider measurement range.

D.3 Measurement Range

The measurement range of a chilled mirror sensor is defined as the temperature range over which a stable dew or frost layer can be maintained on the mirror. Note that in order to acquire a dew or frost layer on the mirror, the depression capability of a sensor must extend below its measurement range. The minimum required differential between depression range and measurement range is 5°C (9°F) at nominal dew/frost points, and increases to 10°C to 12°C (18°F to 22°F) at very low frost points.

Measurement range is normally specified at 25°C (77°F) ambient temperature in air at atmospheric pressure. For sensor body temperatures other than 25°C (77°F), measurement range can be estimated by first estimating depression capability, and then decreasing this range according to the minimum required differential. For most gases other than air, the effect on measurement range is negligible. However, gases such as hydrogen or helium, which are more thermally conductive than air, will result in a decrease of several degrees in the measurement range. Measurement range will decrease as gas pressure is increased, because the increased density (and, therefore, increased thermal conductivity) of the gas results in an increased heat load. For air or nitrogen, each 50 psi (3 bar) increase above atmospheric pressure will result in a loss of approximately 2°C (4°F) of depression capability. Conversely, operating under vacuum may result in a small increase.

Other factors influencing sensor selection include temperature and pressure ratings, and whether anticipated dew points will be higher than ambient temperature.

D.4 Comparing OptiSonde Models

	Model 1111H	Model D-2	Model 1211H	Model SIM-12H	Model 1311DR
System Performance					
Standard Accuracy*	0.2°C	0.2°C	0.2°C	0.2°C	0.2°C
Optical Accuracy*	0.15°C	0.15°C	0.15°C	0.15°C	0.15°C
Cooling Stages	1	2	2	2	4
Depression (at 25°C (77°F), 1 atm, in air)	45°C	65°C	65°C	65°C	95°C, air; 105°C with 15°C coolant
Typical Measurement Range (at given ambient, 1 atm)	at 25°C ambient	at 25°C ambient	at 25°C ambient	at 85°C ambient	at 25°C ambient
Dew/Frost Point	-15° to +25°C	-35° to +25°C	-35° to +25°C	-10° to +85°C	-60° to +25°C, air -70°C to +25°C, liquid
RH (equivalent)	6% to 100%	1.5% to 100%	1.5% to 100%	1% to 100%	0.03% to 100%, air 0.007% to 100%, liq.
Functional Characteristics:					
Power	From Optica	From Optica	From Optica	115/230V AC 75 watts	115/230VAC 300 watts
Ambient Temperature Range	-15° to +80°C	-25° to +85°C	-15° to +100°C	-15° to +50°C	0° to +35°C
Pressure Range (psig)	-3 to +200	-14.7 to +150	0 to +300	-3 to +50	0 to +300
Auxiliary Cooling	No	No	No	No	Standard: air or liquid
Sensor Cavity Material	Epoxy-coated Aluminum	Stainless Steel	Stainless Steel	Anodized Aluminum	Stainless Steel

*Complete system at 25°C (77°F)

[no content intended for this page]

Appendix E. Theory of Operation and Glossary

E.1 Theory of Operation

The OptiSonde utilizes condensation hygrometry, which is a precise technique for determining the water vapor content in gases by directly measuring dew point or frost temperatures. Using this technique, a metal mirror is cooled until it reaches a temperature at which a thin layer of condensation begins to form on it. The dew layer is detected optically; the temperature of the mirror is regulated such that the condensed mass is constant. The mirror temperature, measured with a platinum resistance thermometer, is an accurate indicator of the dew or frost point. These hygrometers are widely used as reference standards in many of the world's metrology laboratories, because the measurement is highly accurate and repeatable.

E.1.1 Hygrometer Function

Figure 29 on page 62 illustrates how Panametrics hygrometers detect and measure dew point. The condensate mirror is illuminated with a solid state, infrared emitter (IR). A photodetector monitors the IR light reflected from the mirror. The photodetector is fully illuminated when the mirror is clear of dew, and it receives less light as dew forms. A separate LED and photodetector pair are used as a known reference to compensate for any thermally induced changes in the OptiSonde components. The photodetectors are arranged in an electrical bridge circuit, the output current of which is proportional to the light reflected from the mirror. The bridge output controls the electrical current to the thermoelectric cooler.

A large bridge current develops when the mirror is dry, causing the mirror to cool toward the dew point. As dew begins to form on the mirror, less light is reflected, and the bridge output decreases. This, in turn, causes a decrease in cooling current. A rate feedback loop within the amplifier ensures critical response, causing the mirror to stabilize at constant mass at a temperature that maintains a thin dew or frost layer on the mirror surface. A precision thermometer element embedded within the mirror directly monitors this dew point temperature.

E.1.2 Hygrometer Calibration

The *OptiSonde* unit can be sent to the National Institute of Standards and Technology (NIST) in Gaithersburg, Maryland for certification or to any National Standards lab for calibration against their primary humidity standards. A calibrated instrument can then be used as a transfer standard in local laboratories to calibrate lower echelon instruments.

CAUTION! Field calibration is not recommended.

Hygrometers used as calibration standards must have the following characteristics:

- The mirror thermometer must have suitable long-term accuracy (such as that obtained with a platinum resistance thermometer).

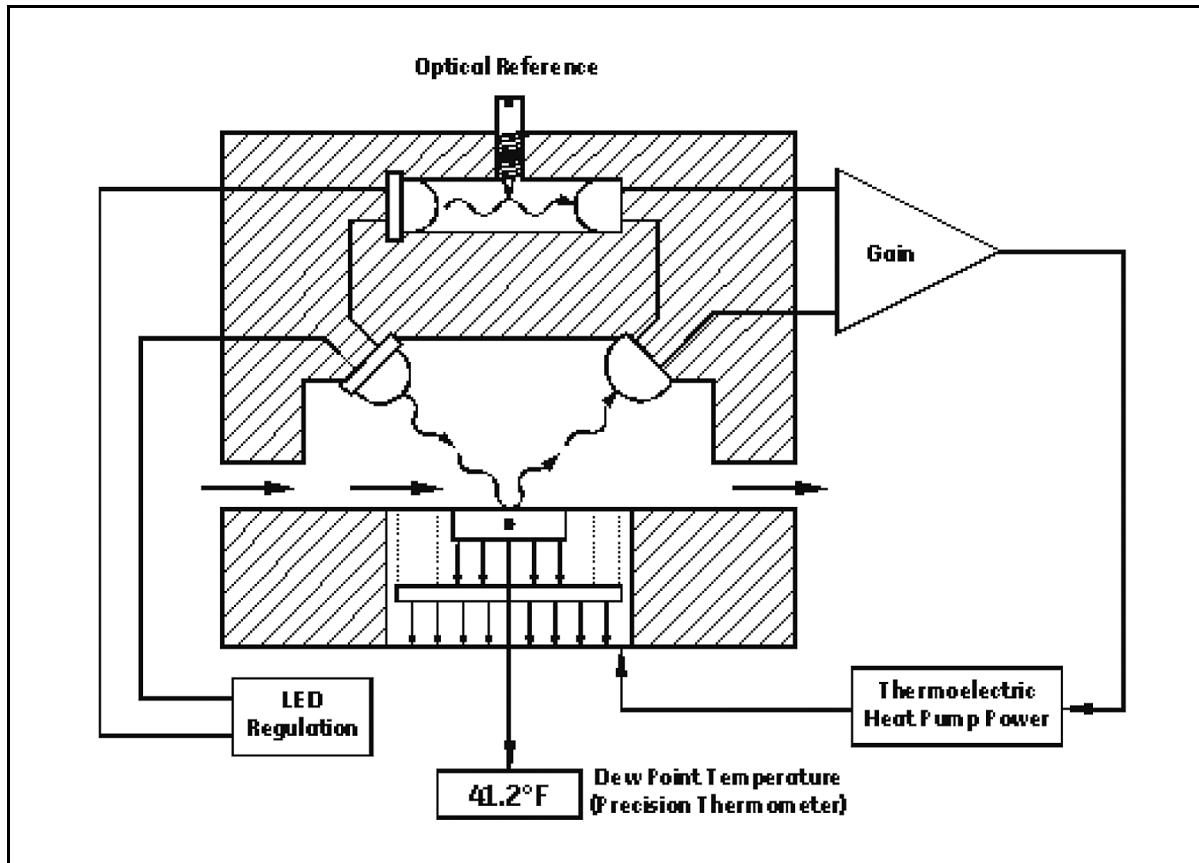

Figure 29: Chilled-Mirror Hygrometer Diagram

E.1.3 Other Hygrometer Applications

Many Panametrics chilled mirror hygrometers are used in industrial applications in addition to metrology. The OptiSonde condensation hygrometer is not readily damaged or contaminated by industrial process gases that can degrade other secondary measurement schemes such as saturated salt and polymer-based sensors. If the sensor or sampling components should become contaminated with oils, salts, etc., they can be cleaned without harm to the sensor or impairment to the system accuracy. The performance of the hygrometer can be checked at any time by heating the mirror above the dew point, causing the dew deposit to evaporate, then reclosing the servoloop and checking to see that the system cools and returns to the same dew point.

The Panametrics OptiSonde condensation sensors cover a wide range of applications limited only by the heat pumping capabilities of the thermoelectrically-cooled mirror.

At high dew points (up to 100°C), the sensor is limited by the thermal properties of the solid state OptiSonde components as well as the thermoelectric heat pump capacity.

In a typical application measuring sub-ambient dew points, a two-stage thermoelectrically-cooled mirror can reach a temperature approximately 65°C lower than an ambient (heat sink) temperature of +25°C. The thermoelectric cooler pumps heat from the mirror into the heat sink. By reducing the temperature of the heat sink, even lower dew points can be measured. In meteorological applications where the heat sink temperature is considerably lower, frost points down to -40°C can be monitored.

E.2 The PACER Cycle

Panametrics has developed and patented a compensation technique called PACER (Programmable Automatic Contaminant Error Reduction) that is very effective in reducing the Raoult Effect error associated with soluble contaminants, particularly for near-ambient dew points. The OptiSonde is equipped with the PACER cycle as well as AUTO balance as found on earlier models. The user can choose which self-cleaning and balancing routine to run depending on the severity of contamination.

The PACER cycle, diagrammed in Figure 30 below, begins with a coalescence period, during which the mirror is cooled well below the dew point of the sample gas, condensing out a large amount of water.

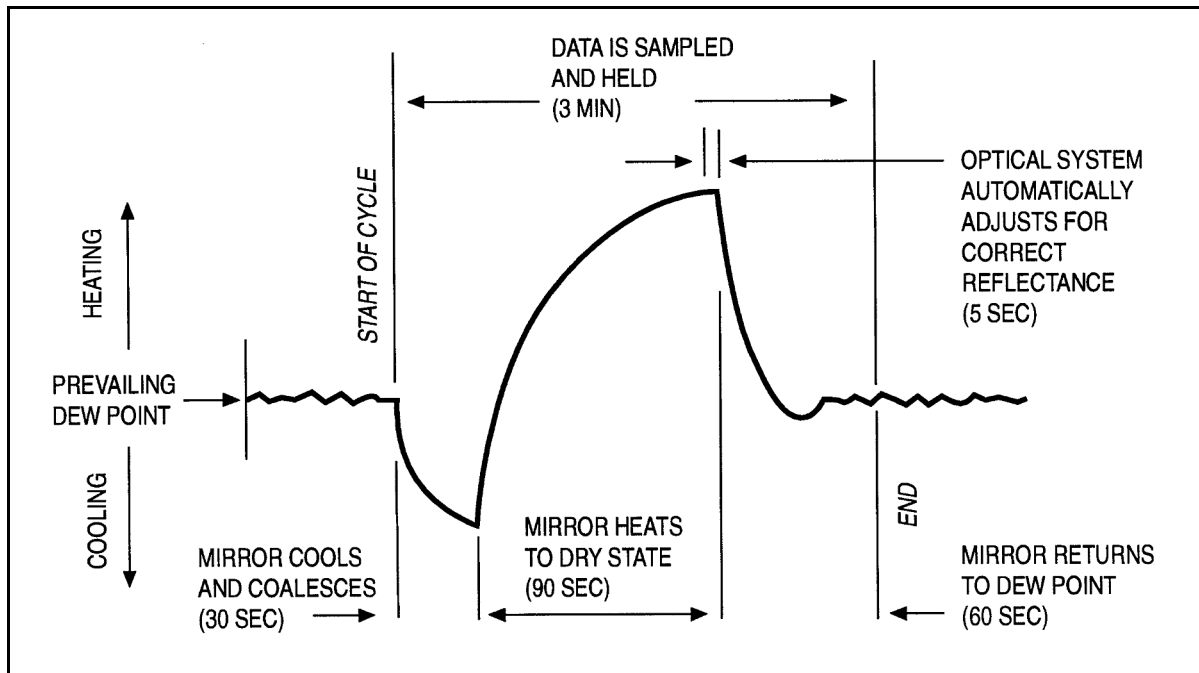

Figure 30: A Typical PACER Cycle

E.2 The PACER Cycle (cont.)

This excess water easily dissolves any water-soluble contaminants. The mirror is then heated. During the heating phase, due to surface tension, the remaining contaminants aggregate into dry “islands”. Empirically, this yields about 80 to 85% clean surface. The reflected light signal is then electronically balanced against the reference. Figure 31 below illustrates the results.

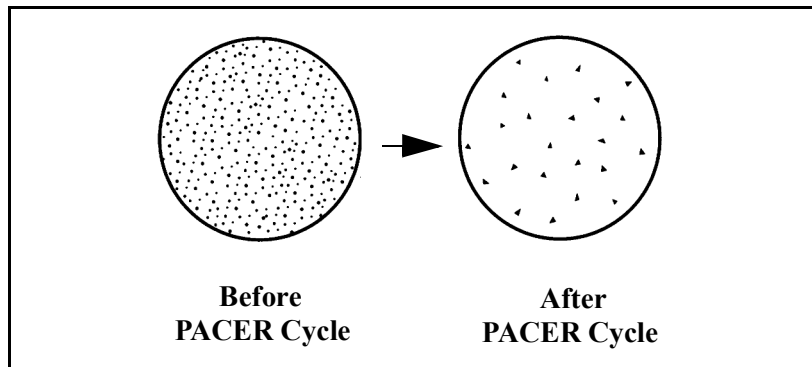

Figure 31: Results of the PACER Cycle

E.3 Glossary

E.3.1 Depression Capability

The temperature difference by which the chilled mirror can be lowered from the ambient temperature.

E.3.2 PACER

Panametrics patented Programmable Automatic Contaminant Error Reduction system, which consolidates soluble contaminants to reduce their effect on system accuracy (see *The PACER Cycle* on page 64).

E.3.3 Parameter

A measured quantity available for display by the unit, such as Dew Point in °C, Humidity in Grams/Kilograms, or Pressure in Bar.

E.3.4 Process Pressure

The gas pressure of the system under test. In some applications, humidity of this gas may be measured at a lower pressure.

E.3.5 Scaling

The process of selecting the maximum and minimum output values of a chosen parameter.

[no content intended for this page]

A		Enclosure
Accessory Specifications	49	Benchtop, Installation
Alarm Outputs		Benchtop, Wiring
Inner Band Alarm	12	
Outer Band Alarm	13	F
Set Point Alarm	12	Filters
Wiring	11	Flow Rate
Alarms		Functional Specifications
OptiSonde	33	
Analog Outputs		G
OptiSonde	31	Gaseous Contaminants
Troubleshooting	45	Glossary
Wiring	11	
Automatic Cleaning and Balancing		H
OptiSonde	35	Humidity
B		Conversion Chart
Balancing a Sensor	25	Equations
Balancing, Automatic		Symbols
OptiSonde	35	Humidity Equations
Benchtop		Vapor Pressure
Specifications	49	Hygrometer
Wiring Input Power	5	Applications
Wiring Outputs	10	Calibration
Wiring Sensors	6	Diagram
C		Function
Calibration	43	
Chilled Mirror Sensors	57	I
Cleaning Sensor Mirror	39	Inner Band Alarm
Cleaning, Automatic		Inputs
OptiSonde	35	Installation
Communication Parameters		Benchtop
OptiSonde	34	Sampling Lines
Contamination		Sensors
Gaseous Contaminants	26	Wall-Mount
Minimizing the Effects	26	Wall-Mount Wiring
Mirror Cleanliness	26	
Particulate Matter	26	L
Water-Soluble Contaminants	26	Logging Data
D		
Date of Publication	i	M
Default Settings	24	Maintenance
Definitions	65	Calibration
Depression Capability	57, 65	Cleaning the Sensor Mirror
Dew Point		Replacing Sensor Mirrors
Sampling Lines	16	Sample Line
Supercooled	26	Sensor Optics
Display		Testing
"Balance" Displayed	45	Troubleshooting
Incorrect Dew Point	44, 45	Measurement
Troubleshooting	43	Range
Document Number	i	Ranges
E		Mirror
Electronics Enclosure		Cleaning
Benchtop	2	Flooding
Wall-Mount	2	Mirror, Cleaning and Balancing
		O
		Operation
		Helpful Hints
		Normal
		OptiSonde
		Theory of

OptiSonde		
Alarms	33	
Analog Outputs	31	
Communication Parameters	34	
Display Screen	22	
Operation	22	
Programmable Functions	31	
Programming	29	
Outer Band Alarm	13	
Outputs	3	
		P
PACER		
Cycle	64	
Definition	65	
Parameter Definition	65	
Particulate Contaminants	26	
Performance	47	
Pressure		
Effects	27	
Vapor	51	
Process Pressure		
Definition	65	
Programming		
OptiSonde	29	
		S
Sample Line Maintenance	27	
Sampling Lines	15, 16	
Scaling, Definition	65	
Sensor Mirror, Cleaning and Balancing	39	
Sensors	4	
Balancing	25	
Chilled Mirror	57	
Cleaning the Mirror	39	
Connecting	20	
Dew Point	4	
Heat Transfer	15	
Information	14	
Installation	14, 17	
Maintenance	39, 42	
Model 1111H	17	
Model 1211H	18	
Model D-2	18	
Pressure	4	
Replacing Mirrors	42	
Temperature	4	
Serial Outputs		
Troubleshooting	45	
Wiring	13	
Service Required	43	
Set Point Alarm	12	
Specifications		
Functional	48	
Optional Accessories	49	
Performance	47	
Physical (Benchtop)	49	
Physical (Wall-Mount)	49	
Status Line Indications	23	
Supercooled Dew Points	26	
		T
System		
Components	3	
		T
Testing	43	
Troubleshooting	43	
"Balance" on Display	45	
"Service" Required	43	
Incorrect Dew Point Display	44, 45	
No Analog Output	45	
No Display	43	
No Serial Output	45	
		V
Vapor Pressure	51	
		W
Wall-Mount		
Installation	7	
Specifications	49	
Wiring Input Power	9	
Wiring Outputs	10	
Water-Soluble Contaminants	26	
Wiring		
Alarm Outputs	11	
Analog Outputs	11	
Outputs	10	
Serial Output	13	
Wall-Mount	8	

Warranty

Each instrument manufactured by Panametrics Sensing is warranted to be free from defects in material and workmanship. Liability under this warranty is limited to restoring the instrument to normal operation or replacing the instrument, at the sole discretion of Panametrics Sensing. Fuses and batteries are specifically excluded from any liability. This warranty is effective from the date of delivery to the original purchaser. If Panametrics Sensing determines that the equipment was defective, the warranty period is:

- one year for general electronic failures of the instrument
- one year for mechanical failures of the sensor

If Panametrics Sensing determines that the equipment was damaged by misuse, improper installation, the use of unauthorized replacement parts, or operating conditions outside the guidelines specified by Panametrics Sensing, the repairs are not covered under this warranty.

The warranties set forth herein are exclusive and are in lieu of all other warranties whether statutory, express or implied (including warranties of merchantability and fitness for a particular purpose, and warranties arising from course of dealing or usage or trade).

Return Policy

If a Panametrics Sensing instrument malfunctions within the warranty period, the following procedure must be completed:

1. Notify Panametrics Sensing, giving full details of the problem, and provide the model number and serial number of the instrument. If the nature of the problem indicates the need for factory service, Panametrics Sensing will issue a RETURN AUTHORIZATION number (RA), and shipping instructions for the return of the instrument to a service center will be provided.
2. If Panametrics Sensing instructs you to send your instrument to a service center, it must be shipped prepaid to the authorized repair station indicated in the shipping instructions.
3. Upon receipt, Panametrics Sensing will evaluate the instrument to determine the cause of the malfunction.

Then, one of the following courses of action will then be taken:

- If the damage is covered under the terms of the warranty, the instrument will be repaired at no cost to the owner and returned.
- If Panametrics Sensing determines that the damage is not covered under the terms of the warranty, or if the warranty has expired, an estimate for the cost of the repairs at standard rates will be provided. Upon receipt of the owner's approval to proceed, the instrument will be repaired and returned.

[no content intended for this page]

**DECLARATION
OF
CONFORMITY**

DOC-0033, Rev. A

We,

**Panametrics Sensing
1100 Technology Park Drive
Billerica, MA 01821
USA**

declare under our sole responsibility that the

OptiSonde Chilled Mirror Hygrometer

to which this declaration relates, is in conformity with the following standards:

- EN 61326-1: 2006, Class A, Table 2, Industrial Locations
- EN 61326-2-3: 2006
- EN 61010-1: 2001, Overvoltage Category II, Pollution Degree 2

following the provisions of the 2004/108/EC EMC and 2006/95/EC Low Voltage Directives.

The unit listed above and any ancillary equipment supplied with it do not bear CE marking for the Pressure Equipment Directive, as they are supplied in accordance with Article 3, Section 3 (sound engineering practices and codes of good workmanship) of the Pressure Equipment Directive 97/23/EC for DN<25.

Billerica - August 2010

Issued



Mr. Gary Kozinski
Certification & Standards, Lead Engineer



Customer Support Centers

U.S.A.

The Boston Center
1100 Technology Park Drive
Billerica, MA 01821

U.S.A.

Tel: 800 833 9438 (toll-free)
978 437 1000

E-mail: mstechsupport@bakerhughes.com

Ireland

Sensing House
Shannon Free Zone East
Shannon, County Clare
Ireland

Tel: +353 (0)61 470291

E-mail: mstechsupport@bakerhughes.com

Copyright 2021 Baker Hughes company.

This material contains one or more registered trademarks of Baker Hughes Company and its subsidiaries in one or more countries. All third-party product and company names are trademarks of their respective holders.

910-282 B

Baker Hughes 