



3-8750.090-3 Rev. J 11/12 English



CAUTION!

- Remove power to unit before wiring input and output connections.
- Follow instructions carefully to avoid personal injury.

Contents

1. Installation
2. Specifications
3. Electrical Connections
4. Menu Functions



1. Installation

ProcessPro transmitters are available in two styles: panel mount and field mount. The panel mount is supplied with the necessary hardware to install the transmitter. This manual includes complete panel mounting instructions.

Field mounting requires a separate mounting kit. The 3-8050 Universal kit enables the transmitter to be installed virtually anywhere. Detailed instructions for field installation options are included with the 3-8050 Universal kit.

1.1 Panel Installation

1. The panel mount transmitter is designed for installation using a 1/4 DIN Punch. For manual panel cutout, an adhesive template is provided as an installation guide. Recommended clearance on all sides between instruments is 1 inch.
2. Place gasket on instrument, and install in panel.
3. Slide mounting bracket over back of instrument until quick-clips snap into latches on side of instrument.
4. To remove, secure instrument temporarily with tape from front or grip from rear of instrument. **DO NOT RELEASE.** Press quick-clips outward and remove.

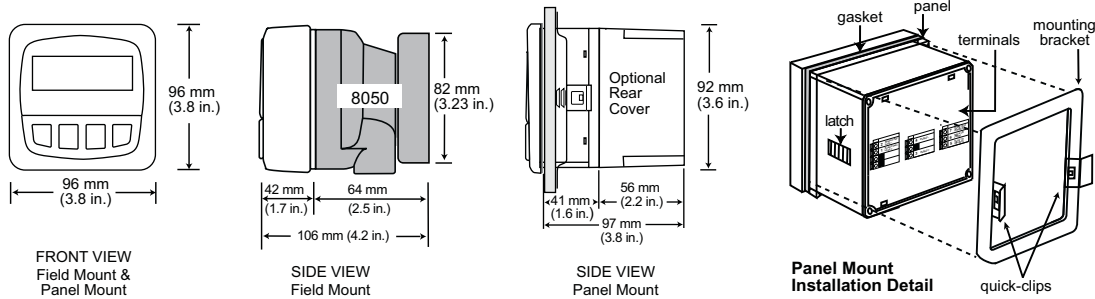

2. Specifications

General

Compatible electrodes: Signet 2724-2726, 2756, 2757 WTP, 2764-2767 and 2774-2777 Electrodes with 2760-1, -2, -11 and -21 pH/ORP Pre-amplifier

- Accuracy: ± 0.03 pH, ± 2 mV ORP
- Case: PBT
- Panel case gasket: Neoprene
- Window: Polyurethane coated polycarbonate
- Keypad: Sealed 4-key silicone rubber
- Weight: Approx. 325 g (12 oz.)
- Display:
 - Alphanumeric: 2 x 16 LCD
 - Contrast: User selected, 5 levels
 - Update rate: 1 second

Electrical

Power: 12 to 24 VDC $\pm 10\%$, regulated, 60 mA max.

Sensor input range:

- pH: 0.00 to 14.00 pH
- Temp. (pH only) 3K Balco, -25 to 120 °C (-13 to 248 °F)
- ORP: -1000 to +2000 mV, isolated (10K Ω I.D. resistance T+, T-)

Current output:

- 4 to 20 mA, isolated, fully adjustable and reversible
- Max loop impedance:
 - 50 Ω max. @ 12 V
 - 325 Ω max. @ 18 V
 - 600 Ω max. @ 24 V
- Update rate: 0.5 seconds
- Accuracy: ± 0.03 mA @ 25 °C, 24 V

Two Open-collector outputs:

- Isolated, 50 mA sink or source, 30 VDC max. pull-up voltage
- High or Low programmable with adjustable hysteresis
- Proportional Pulse operation (maximum 400 pulses/minute)

Environmental

- Operating temperature: -10 to 70 °C (14 to 158 °F)
- Storage temperature: -15 to 80 °C (5 to 176 °F)
- Relative humidity: 0 to 95%, non-condensing
- Maximum altitude: 2000 m (6562 ft)
- Insulation category: II
- Pollution degree: 2
- Enclosure Rating: NEMA 4X/IP65 front

Standards and Approvals

- CE, UL, CUL listed
- RoHS Compliant
- Standards & Approvals
- Manufactured under ISO 9001 for Quality, ISO 14001 for Environmental Management and OHSAS 18001 for Occupational Health and Safety.
- China RoHS (Go to www.gfsignet.com for details)



Declaration of Conformity according to FCC Part 15

This device complies with Part 15 of the FCC rules. Operation is subject to the following two conditions:

- (1) This device may not cause harmful interference, and,
- (2) This device must accept any interference received, including interference that may cause undesired operation.

3. Electrical Connections

Caution: Failure to fully open terminal jaws before removing wire may permanently damage instrument.

Wiring Procedure

NOTE: Use 14 to 26 AWG wire. Use of larger gauge wires will damage the connectors.

1. Remove 13 to 16 mm (0.5 to 0.625 in.) of insulation from wire end.
2. Press the orange terminal lever downward with a small screwdriver to open terminal jaws.
3. Insert exposed (non-insulated) wire end in terminal hole until it bottoms out.
4. Release orange terminal lever to secure wire in place. Gently pull on each wire to ensure a good connection.

Wiring Removal Procedure

1. Press the orange terminal lever downward with a small screwdriver to open terminal jaws.
2. When fully open, remove wire from terminal. Do not forcibly pull the wire out of the terminal.

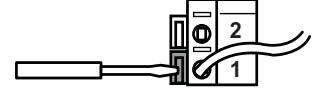

Wiring Tips:

- Do not route sensor cable in conduit containing AC power wiring. Electrical noise may interfere with sensor signal.
- Routing sensor cable in grounded metal conduit will help prevent electrical noise and mechanical damage.
- Seal cable entry points to prevent moisture damage.
- Only one wire should be inserted into a terminal. Splice double wires outside the terminal.

Terminals 1-4: Passive current loop

- 12 to 24 VDC $\pm 10\%$ required for system power and current loop output.

Max. loop impedance:

- 50 Ω max. @ 12 V
- 325 Ω max. @ 18 V
- 600 Ω max. @ 24 V

Terminals 13-16: Sensor connections

13-14 are mV (pH or ORP) input from the electrode.
15-16 are Temperature input from the pH electrode or 10K ID resistor from ORP electrode.

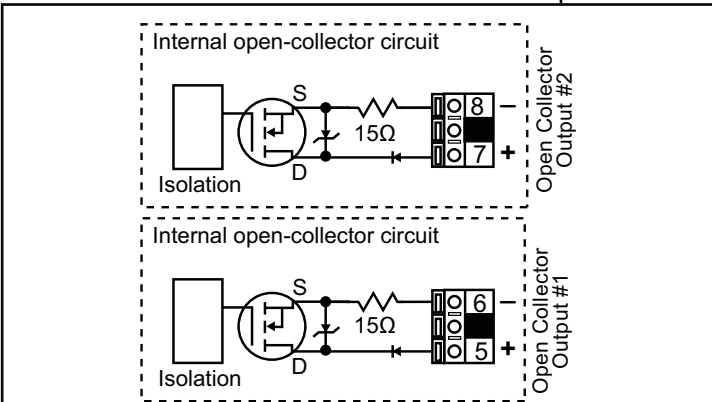
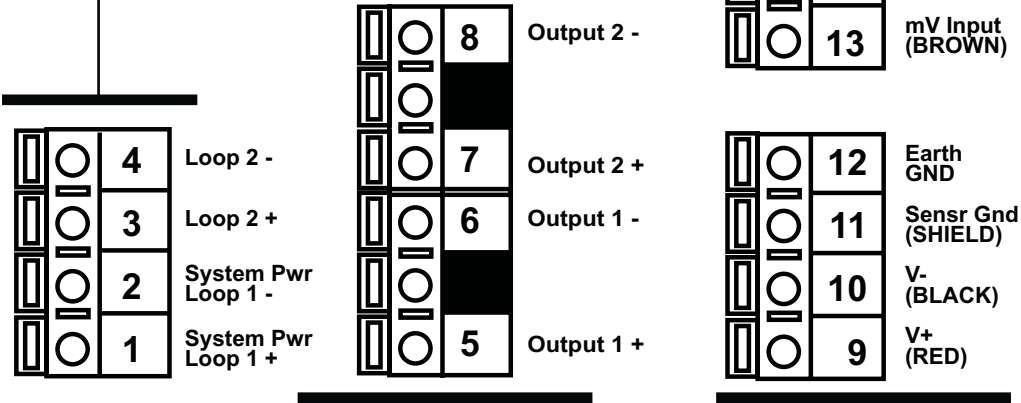

Terminals 9-12: Preamplifier power and grounds

9-10 are DC voltages from the 8750 to power the preamplifier.
11-12 are ground terminals for the sensor and for earth ground.

Terminals 5-8: Open-Collector Outputs

Two transistor outputs, programmable in CALIBRATE menu as:

- High or Low setpoint with adjustable hysteresis
- Proportional pulse up to 400 pulses per minute
- May be disabled (Off) if not used.

3.1 Sensor Input Connections

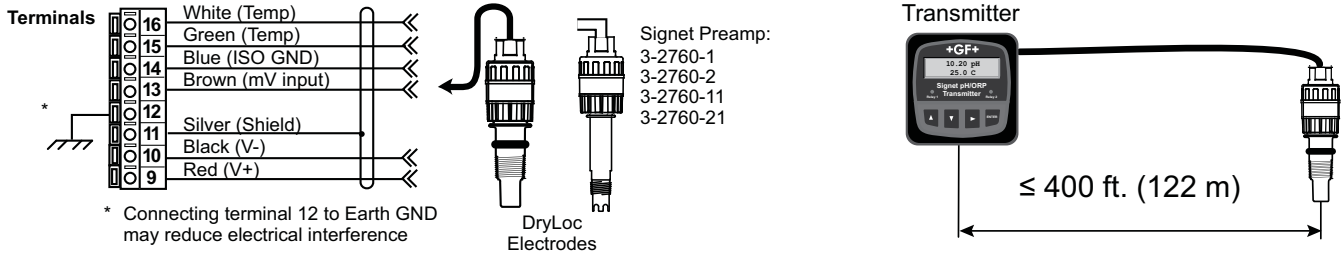

3.2 System Power/Loop Connections

Stand-alone application, no current loop used

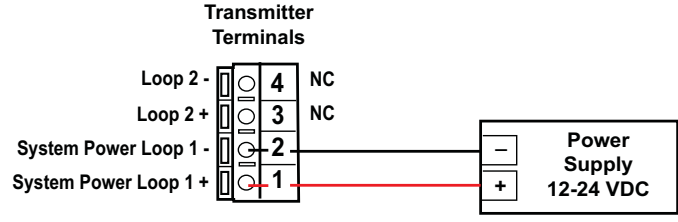

Connection to a PLC/Recorder separate supply

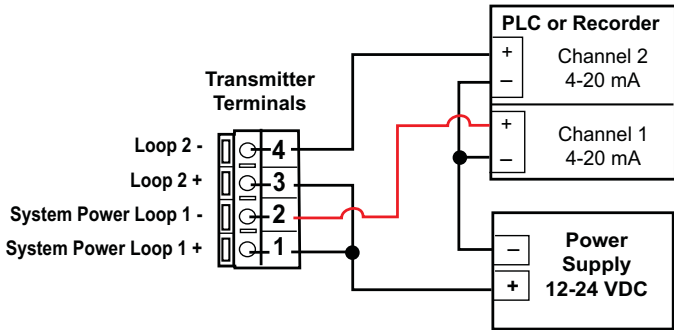

The current loop is a passive circuit.
 12-24 VDC must be provided from an external source.

Connection to a PLC with built-in power supply

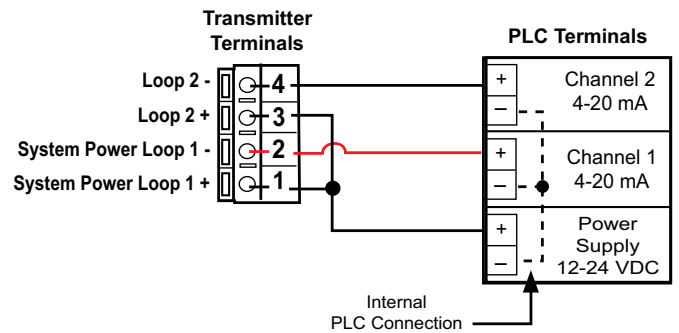

Example: Two transmitters connected to PLC/Recorder with separate power supply

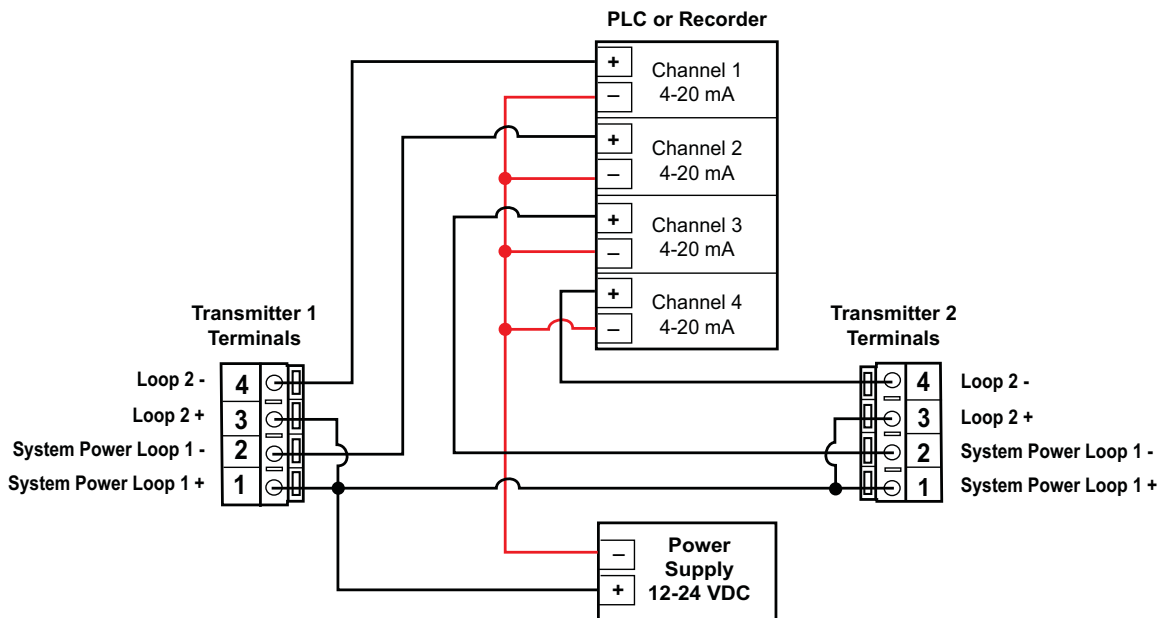

3.3 Open Collector Output

The Open Collector output can be used as a switch that responds when the process value moves above or below a setpoint, or it can be used to generate a pulsing signal with a rate proportional to the process value.

- **Low:**
Output energizes when process variable is less than the setpoint. The output de-energizes when the process moves above the setpoint plus the hysteresis value.

- **High:**
Output energizes when process variable is greater than the setpoint. The output de-energizes when the process variable moves below the setpoint minus the hysteresis value.

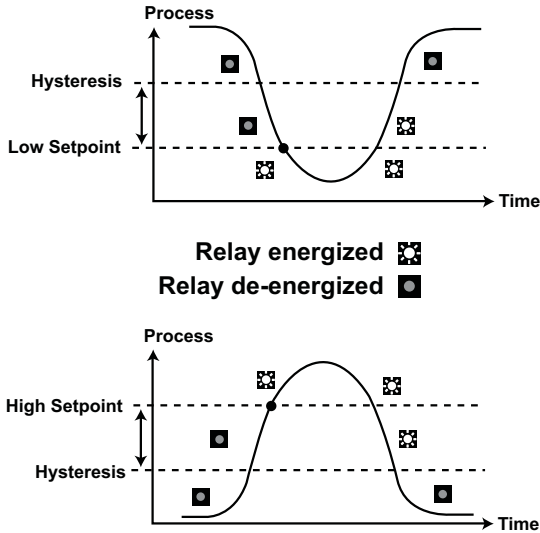

- **Proportional Pulsing**

The Open Collector output will generate a 100 mS pulse at the rate defined by settings in the CALIBRATE menu (see page 6)

In the example below:

- The output will be 0 pulses/min. at pH values less than 5.0.
- The output will be 50 pulses/min. at 7.5 pH.
- The output will be 100 pulses/min. at pH values above 10 pH.

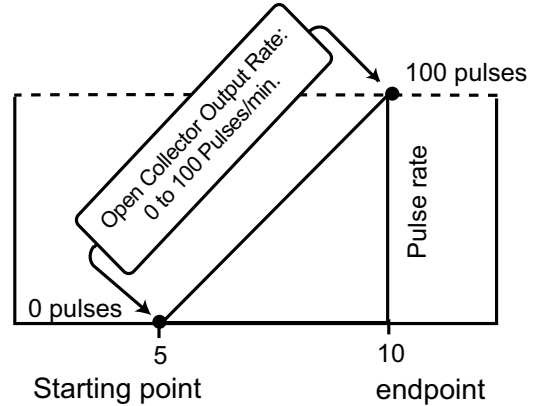

VIEW Menu

- During normal operation, ProcessPro displays the VIEW menu.
- When using the CALIBRATE or OPTIONS menus, ProcessPro will return to the VIEW menu if no activity occurs for 10 minutes.
- To select the item you want displayed, press the ▲ or ▼ arrow keys. The items will scroll in a continuous loop. Changing the display selection does not interrupt system operations.
- No key code is necessary to change display selection.
- Output settings cannot be edited from the VIEW menu.



View Menu for pH

Display	Description
7.00 pH 12.6 °C	Monitor the pH and the Temperature input from the sensor. This is the Permanent display.
All of the displays below are temporary. After 10 minutes the display returns to the permanent display.	
Input 307 mV	Monitor the millivolt input from the electrode. Use this display to determine the relative condition of your electrode during periodic calibration.
Loop1 Output 14.16 mA	Monitor the 4 to 20 mA Loop output.
Last CAL: 02-10-09	Monitor date for scheduled maintenance or date of last calibration. (See description in Calibrate Menu.)
EASY CAL	Easy Cal is the fastest and simplest periodic calibration method. Requires 4 pH, 7 pH and/or 10 pH buffers (any two).

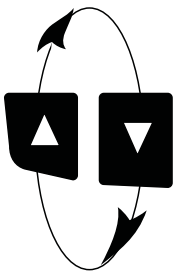

ProcessPro Editing Procedure:

Step 1. Press and hold ENTER key:

- 2 seconds to select the CALIBRATE menu
- 5 seconds to select the OPTIONS menu.

Step 2. The Key Code is ▲-▲-▲-▼ keys in sequence.

- After entering the Key Code, the display will show the first item in the selected menu.

Step 3. Scroll menu with ▲ or ▼ keys.

Step 4. Press ► key to select menu item to be edited.

- The first display element will begin flashing.

Step 5. Press ▲ or ▼ keys to edit the flashing element.

- ► key advances the flashing element.

Step 6. Press ENTER key to save the new setting and return to Step 3.

Notes on Step 1:

- The View Menu is normally displayed.
- The CALIBRATE and OPTIONS menus require a KEY CODE.

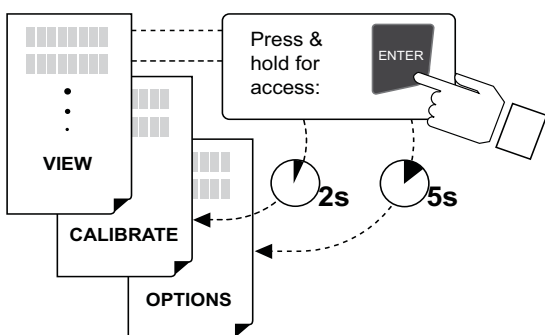

Notes on Step 2:

If no key is pressed for 5 minutes while display is showing "Enter Key Code", the display will return to the VIEW menu.

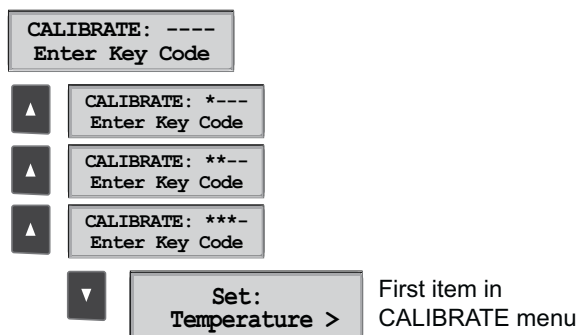

Notes on Steps 3 and 4:

- Refer to pages 6 and 7 for complete listing of menu items and their use.
- From the Step 3 display, pressing the ▲ and ▼ keys simultaneously will return the display to the VIEW menu.
- If no key is pressed for 10 minutes, display will also return to the VIEW menu.

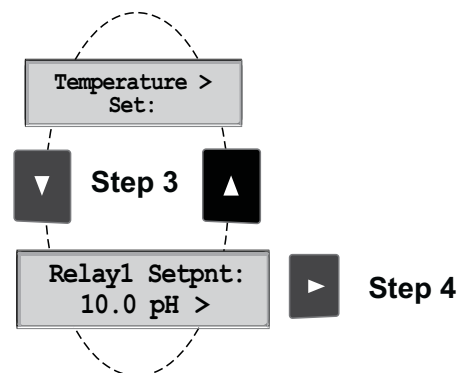



Step 3: Finished Editing?

Press the ▲ and ▼ keys simultaneously after saving the last setting to return to normal operation.

Notes on Steps 5 and 6:

- All output functions remain active during editing.
- Only the flashing element can be edited.
- ► key advances the flashing element in a continuous loop.
- Edited value is effective immediately after pressing ENTER key.
- If no key is pressed for 10 minutes unit will restore the last saved value and return to step 3.
- Step 6 (pressing ENTER key) always returns you to Step 3.
- Repeat steps 3-6 until all editing is completed.

Step 5: Made an Error?

Press the ▲ and ▼ keys simultaneously while any element is flashing. This will recall the last saved value of the item being edited and return you to Step 3.



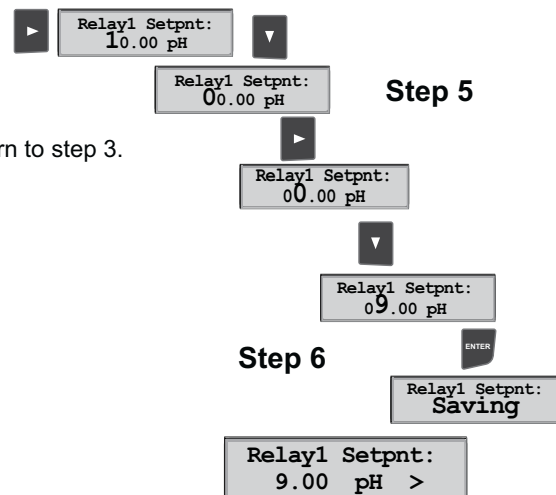

Calibrate Menu for pH

Display (Factory settings shown)	Description
Set: Temperature >	Provides a maximum 25 °C offset to match temperature measurement to external reference.
Set: Standard >	Applies a linear offset to the pH measurement. The ideal value is the average pH of your application. (A sample of your application at process temperature is recommended.)
Set: Slope >	Applies a slope to the pH measurement. The slope value and the standard value must be at least 2 pH units apart. The ideal values are the minimum and maximum values of your process.
Loop1 Range: pH 0.00 > 14.00 >	Select the minimum and maximum values for the 4 to 20 mA current loop output.
Loop1 Source: pH >	Select pH or Temperature as the source for open collector 1.
Output1 Mode: Off >	Select the mode of operation for open collector 1: High, Low or Proportional Pulse. The signal may be disabled (Off) if not in use.
Output1 Setpnt: 4.00 pH >	In Low or High Mode, the open collector will be energized when the pH reaches this value.
Output1 Hys: 0.51 pH >	In Low or High mode, the open collector will be de-energized at Setpoint ± Hysteresis, depending on High or Low Setpoint selection. (See details on page 4.)
Output1 Range: 4.00 > 8.00 >	If Output is in PULSE mode, set the start and end point of the range and also set the maximum pulse rate. (The maximum PULSE rate setting is 400 pulses per minute.)
Output1 PlsRate: 120 Pulses/min >	The combined Output Range and Output Pulse rate settings shown here indicate: "Start pulsing when the pH value is 4 and increase the pulse rate up to the maximum of 120 pulses per minute when the pH value reaches 8".
Last CAL: 02-10-09 >	Use this "note pad" to record important dates, such as annual recertification or scheduled maintenance.





All Output 1 functions will repeat for Output 2; All Loop 1 functions will repeat for Loop 2.

EASY CAL Procedure - pH

- This procedure simplifies system calibration using standard 4.0, 7.0, or 10.0 pH buffers only. If these pH buffers are not available, calibrate the system via the CALIBRATE menu using the STANDARD and SLOPE settings.
- Access the CALIBRATE menu and set sensor temperature before performing EASY CAL for new electrode installations.
- Access EASY CAL menu from the View menu by pressing the ▲ key.

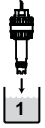
EASY CAL: ----
Enter Key Code

Press ▲, ▲, ▲, ▼ keys in sequence to enter menu,
**** will appear during code entry.

To Calibrate:	Response:	To Accept:
<p>Place Sensor in pH Buffer #1</p>  <p>Place electrode tip in first pH buffer pH 7.0 = 0 mV pH 4.0 = 177 mV pH 10 = -177 mV Limit ± 50 mV</p>	<p>6.90 pH -005 mV</p> <p>Allow for stabilization</p>  <p>30 seconds</p>	<p>6.90 pH -005 mV</p> <p>ENTER to accept</p> <p>7.00 pH -005 mV</p>
<p>Place Sensor in pH Buffer #2</p>  <p>Place electrode tip in second pH buffer.</p>	<p>3.93 pH +179 mV</p> <p>Allow for stabilization</p>  <p>30 seconds</p>	<p>3.93 pH +179 mV</p> <p>Press ENTER to accept second buffer calibration.</p> <p>4.00 pH +179 mV</p>
<p>To exit menus and return to VIEW press ▲ and ▼ keys at the same time</p> 	<p>Display returns to VIEW Menu in 10 minutes or when ENTER is pressed</p>	<p>Good Easy Cal Press <ENTER></p>

Theoretical mV values	
pH @ 25 °C	mV
2	+296
3	+237
4	+177
5	+118
6	+59
7	0
8	-59
9	-118
10	-177
11	-237
12	-296

Options Menu for pH

Display (Factory settings shown)	Description
<p>Contrast: 3 ></p>	Adjust the LCD contrast for best viewing. A setting of 1 is lowest contrast, 5 is highest. Select lower contrast if the display is in warmer ambient surroundings.
<p>Averaging Off ></p>	OFF provides the quickest output response to changes in pH. Longer averaging period produces more stable display and output response.
<p>Output1 Active Low ></p>	Active HIGH: This setting is used to turn a device (pump, valve) ON at the setpoint. Active LOW: This setting is used to turn a device (pump, valve) OFF at the setpoint.
<p>Temp Display °C ></p>	Select temperature units: °C or °F.
<p>Loop1 Adjust 4.00 mA ></p>	Adjust the minimum and maximum current output. Use this setting to match the system output to any external device. The display value represents the precise current output. Adjustment limits: • 3.80 mA < 4.00 mA > 5.00 mA • 19.00 mA < 20.00 mA > 21.00 mA
<p>Loop1 Adjust 20.00 mA ></p>	
<p>Test Loop: ></p>	Press ▲ or ▼ keys to manually order any output current value from 3.6 mA to 21.00 mA to test current loop output.
<p>Test Output1: ></p>	Press ▲ or ▼ keys to manually toggle the state of Relay 1.

Calibrate Menu for ORP





Display (Factory settings shown)	Description
Set: Standard >	Applies a linear offset to the ORP measurement. If you are using a single-point calibration, use this function. The ideal value is the average ORP of your application. (A sample of your application at process temperature is recommended.)
Set: Slope >	Applies a slope to the ORP measurement. This function should only be used in a two-point calibration. The slope value and the standard value must be at least 120 mV apart. The ideal values are the minimum and maximum values of your application.
Loop1 Range: mV -1000 > +1000 >	Select the minimum and maximum ORP values for the 4 to 20 mA current loop output. Maximum settings are -1000 mV to +2000 mV.
Output1 Mode: Off >	Select the mode of operation for open collector output: High, Low or Proportional Pulse. The signal may be disabled (Off) if not in use.
Output1 Setpnt: -500 mV >	In Low or High Mode, the open collector output will be activated when the ORP reaches this value.
Output1 Hys: 10 mV >	In Low or High mode, the open collector output will be deactivated at Setpoint \pm Hysteresis, depending on High or Low Setpoint selection. (See details on page 4.)
Output1 Range: -500 > +500 >	If Output 1 is in PULSE mode, set the start and end point of the range and also set the maximum pulse rate. (The maximum PULSE rate setting is 400 pulses per minute.)
Output1 PlsRate: 120 Pulses/min >	The combined Output1 Range and Output1 Pulse Rate settings shown here indicate: "Start pulsing when the ORP value is -500 and increase the pulse rate up to the maximum of 120 pulses per minute when the ORP value reaches +500"
Last CAL: 02-10-09 >	Use this "note pad" to record important dates, such as annual recertification or scheduled maintenance.

EASY CAL Procedure - ORP

- This procedure simplifies system calibration using standard 4.0 pH and 7.0 pH buffers **saturated with Quinhydrone** (saturate 50 mL of pH 4 and pH 7 buffers with 1/8 g quinhydrone). To calibrate using any other ORP buffer solutions, use the Standard and Slope functions in the CALIBRATE menu.
- Access EASY CAL menu from the View menu.

EASY CAL: ----
Enter Key Code

Press ▲, ▲, ▲, ▼ keys in sequence to enter menu,
**** will appear during code entry.

To Calibrate:	Response:	To Accept:
<p>Place Sensor in ORP Buffer #1</p>  <p>Place electrode tip in first pH buffer;</p> <p>pH 7.0 = 87 mV pH 4.0 = 246 mV</p>	<p>* ORP: + 84 mV Input: + 82 mV</p> <p>Allow for stabilization</p>  <p>30 seconds</p>	<p>* ORP: + 84 mV Input: + 82 mV</p> <p>ENTER to accept</p> <p>* ORP: + 87 mV Input: + 82 mV</p>
<p>Place Sensor in ORP Buffer #2</p>  <p>Place electrode tip in second (different) pH buffer.</p> <p>pH 4.0 = 246 mV pH 7.0 = 87 mV</p>	<p>* ORP: +262 mV Input: +260 mV</p> <p>Allow for stabilization</p>  <p>30 seconds</p>	<p>* ORP: +262 mV Input: +260 mV</p> <p>Press ENTER to accept second buffer calibration.</p> <p>* ORP: +264 mV Input: +260 mV</p>
<p>To exit menus and return to VIEW press ▲ and ▼ keys at the same time</p> 	<p>Display returns to VIEW Menu in 10 minutes or when ENTER is pressed</p>	<p>Good Easy Cal Press <ENTER></p>

- For best results, gently stir the submerged electrode for approximately 5 seconds during the stabilization period.
- Large temperature differences from process fluids to buffers may require longer stabilization time.

Technical notes:

The difference between the actual mV and value shown is a good indication of the condition of the electrode. Differences in excess of 50 mV may indicate a need to service the electrode.

Options Menu for ORP

Display (Factory settings shown)	Description
<p>Contrast: 3 ></p>	Adjust the LCD contrast for best viewing. A setting of 1 is lowest contrast, 5 is highest. Select lower contrast if the display is in warmer ambient surroundings.
<p>Averaging Off ></p>	OFF provides the quickest output response to changes in ORP. Longer averaging period produces more stable display and output response.
<p>Output1 Active Low ></p>	HIGH: This setting is used to turn a device (pump, valve) ON at the setpoint. LOW: This setting is used to turn a device (pump, valve) OFF at the setpoint.
<p>Loop1 Adjust 4.00 mA ></p>	Adjust the minimum and maximum current output. Use this setting to match the system output to any external device. The display value represents the precise current output. Adjustment limits: • 3.80 mA < 4.00 mA > 5.00 mA • 19.00 mA < 20.00 mA > 21.00 mA
<p>Loop1 Adjust 20.00 mA ></p>	
<p>Test Loop: ></p>	Press ▲ or ▼ keys to manually order any output current value from 3.6 mA to 21.00 mA to test current loop output.
<p>Test Output: ></p>	Press ▲ or ▼ keys to manually toggle the state of the open collector output.

Troubleshooting - pH

Display Condition	Possible Causes	Suggested Solutions
"Out of Range Use Manual Cal"	<ol style="list-style-type: none"> 1. Required 4, 7 or 10 buffers not used. 2. Sensor is too depleted to use EasyCal. 	<ol style="list-style-type: none"> 1. Use pH 4, 7, 10 buffers. 2. Clean probe and retry EASY CAL. 3. Use Manual calibration for Standard and Slope if mV offset exceeds 50 mV.
"Same Buffer"	<ol style="list-style-type: none"> 1. Sensor was not moved from buffer #1 to buffer #2. 2. Buffer is contaminated. 	<ol style="list-style-type: none"> 1. Place sensor in correct buffer solution. 2. Use fresh buffer.
"Standard too close to Slope!"	<ol style="list-style-type: none"> 1. pH Standard value within 2 pH units of Slope value. 2. pH Sensor efficiency is inadequate. 	<ol style="list-style-type: none"> 1. Use pH values at least 2 pH units apart. 2. Clean pH sensor; replace if necessary. 3. Use fresh buffer.
"Slope too close to Standard!"	<ol style="list-style-type: none"> 1. pH Slope value within 2 pH units of Standard value. 2. pH Sensor efficiency is inadequate. 	<ol style="list-style-type: none"> 1. Use pH values at least 2 pH units apart. 2. Clean pH sensor; replace if necessary. 3. Use fresh buffer.
"Out of Range Check Sensor"	<ol style="list-style-type: none"> 1. No temperature or mV signal detected from sensor.* 2. No connection between sensor and preamplifier. 	<ol style="list-style-type: none"> 1. Check all wiring, contacts in preamplifier. 2. Verify sensor is securely installed. 3. Replace electrode.
Constant "15.00 pH" or "0.00 pH" with good temp value	Input is less than 0 pH or greater than 15 pH.	<ol style="list-style-type: none"> 1. Recalibrate system. 2. Replace pH sensor. 3. Replace preamplifier.
"Check Sensor?"	<ol style="list-style-type: none"> 1. No temperature or mV signal from sensor detected. 2. No connection between pH sensor and preamplifier. 	<ol style="list-style-type: none"> 1. Check all wiring, contacts in preamplifier. 2. Verify sensor is securely installed. 3. Replace pH sensor.

The mV value from the sensor when placed in a 7 pH buffer represents the sensor offset. Signet recommends servicing/replacing the sensor when the offset exceeds 50 mV.

The 3-2759 pH/ORP system tester allows simple system troubleshooting.

Troubleshooting - ORP

Display Condition	Possible Causes	Suggested Solutions
"Out of Range Use Manual Cal"	<ol style="list-style-type: none"> Required 4, 7 buffers with quinhydrone not being used. Sensor is too depleted to use EasyCal. 	<ol style="list-style-type: none"> Use pH 4, 7 buffers saturated with quinhydrone. Clean probe and retry EASY CAL. Use Manual calibration for Standard and Slope if mV offset exceeds 50 mV.
"Same Buffer"	<ol style="list-style-type: none"> Sensor was not moved from buffer #1 to buffer #2. Buffer is contaminated. 	<ol style="list-style-type: none"> Place sensor in correct buffer solution. Use fresh buffer.
"Standard too close to Slope!"	<ol style="list-style-type: none"> ORP Standard value within 120 mV of Slope value. ORP Sensor efficiency is inadequate. 	<ol style="list-style-type: none"> Use ORP values at least 120 mV apart. Clean ORP sensor; replace if necessary. Use fresh buffer.
"Slope too close to Standard!"	<ol style="list-style-type: none"> ORP Slope value within 120 mV units of Standard value. ORP Sensor efficiency is inadequate. 	<ol style="list-style-type: none"> Use ORP values at least 120 mV apart. Clean ORP sensor; replace if necessary. Use fresh buffer.
"Out of Range Check Sensor"	<ol style="list-style-type: none"> No mV signal or sensor ID detected from sensor. No connection between ORP sensor and preamplifier.. 	<ol style="list-style-type: none"> Check all wiring, contacts in preamplifier. Verify sensor is securely installed. Replace ORP sensor.
Constant "-1000" or "+2000" with good temp value	mV input is less than -999 or greater than +1999.	<ol style="list-style-type: none"> Recalibrate system. Replace ORP sensor. Replace preamplifier.
"Check Sensor?"	<ol style="list-style-type: none"> No mV signal or sensor ID detected from sensor. No connection between ORP sensor and preamplifier. 	<ol style="list-style-type: none"> Check all wiring, contacts in preamplifier. Verify sensor is securely installed. Replace ORP sensor.

Ordering Information

Mfr. Part No.	Code	Description
3-8750-1	159 000 053	pH/ORP Transmitter Field mount
3-8750-1P	159 000 054	pH/ORP Transmitter Panel mount
3-8750-2	159 000 055	pH/ORP Transmitter Field mount with relays
3-8750-2P	159 000 056	pH/ORP Transmitter Panel mount with relays
3-8750-3	159 000 057	pH/ORP Transmitter Field mount with single input/dual output
3-8750-3P	159 000 058	pH/ORP Transmitter Panel mount with single input/dual output

Accessories

Mfr. Part No.	Code	Description
3-2724-10	159 001 547	pH Electrode, Flat, 3/4" MNPT, thread
3-2724-11	159 001 548	pH Electrode, Flat, ISO 7/1-R 3/4 thread
3-2725-60	159 001 561	ORP Electrode, Flat, 3/4" MNPT, thread
3-2725-61	159 001 562	ORP Electrode, Flat, ISO 7/1-R 3/4 thread
3-2726-10	159 001 555	pH Electrode, Bulb, 3/4" MNPT, thread
3-2726-11	159 001 556	pH Electrode, Bulb, ISO 7/1-R 3/4 thread
3-2726-HF-10	159 001 551	pH Electrode, Bulb, HF resistant, 3/4" MNPT, thread
3-2726-HF-11	159 001 552	pH Electrode, Bulb, HF resistant, ISO 7/1-R 3/4 thread
3-2726-LC-10	159 001 559	pH Electrode, Bulb, Low Conductivity, 3/4" MNPT, thread
3-2726-LC-11	159 001 560	pH Electrode, Bulb, Low Conductivity, ISO 7/1-R 3/4 thread
3-2756-WTP-1	159 001 384	pH Electrode, DryLoc, plastic, 3 KΩ Balco
3-2757-WTP	159 001 391	ORP Electrode, DryLoc, plastic, no temperature

Accessories (cont.)

Mfr. Part No.	Code	Description
3-2760-1	159 000 939	pH/ORP Preamplifier, DryLoc,submersible, 3/4" NPT threads with cable
3-2760-2	159 000 940	pH/ORP Preamplifier, DryLoc,submersible, 3/4" ISO threads with cable
3-2760-11	159 001 367	pH/ORP Preamplifier, DryLoc, in-line, 3/4" NPT threads and cable
3-2760-21	159 001 368	pH/ORP Preamplifier, DryLoc, in-line, 3/4" ISO threads and cable
3-2764-1	159 000 943	pH Differential Electrode, Flat, 3 K Ω Balco
3-2765-1	159 000 946	ORP Differential Electrode, Flat, 10 K Ω ID
3-2766-1	159 000 949	pH Differential Electrode, Bulb with protection, 3 K Ω Balco
3-2767-1	159 000 952	ORP Differential Electrode, Bulb with protection, 10 K Ω ID
3-2774	159 000 955	pH Electrode, DryLoc, Flat, 3 K Ω RTD
3-2775	159 000 957	ORP Electrode, DryLoc, Flat, 10 K Ω ID resistor
3-2776	159 000 959	pH Electrode, DryLoc, Bulb with protection, 3 K Ω RTD
3-2777	159 000 961	ORP Electrode, DryLoc, Bulb with protection, 10 K Ω ID resistor
3-2759	159 000 762	pH/ORP system tester (includes bypass adapter)
3-2759.391	159 000 764	Adapter Cable for use with the 2760 preamplifier
3-3719-11	159 000 804	pH/ORP Wet-Tap, 1½ in. NPT
3-3719-12	159 000 806	pH/ORP Wet-Tap, ISO 7/1-R 1.5
3-3719-21	159 000 805	pH/ORP Wet-Tap, 2 in. NPT
3-3719-22	159 000 807	pH/ORP Wet-Tap Assembly, ISO 7/1-R 2
P31515-0P200	159 000 630	PVC Pipe Adapter
P31515-0C200	159 000 631	CPVC Pipe Adapter
P31515-0V200	159 000 459	PVDF Pipe Adapter
1220-0021	198 801 186	O-ring, FPM (standard)
1224-0021	198 820 006	O-ring, EPR
1228-0021	198 820 007	O-ring, FFPM
3-8050	159 000 184	Universal mounting kit
3-8050.392	159 000 640	Model 200 retrofit adapter
3-8050.395	159 000 186	Splashproof rear cover
3-8052	159 000 188	3/4" Integral mounting kit
3-8052-1	159 000 755	3/4" NPT mount junction box
3-0000.596	159 000 641	Heavy duty wall mount bracket
3-0700.390	198 864 403	pH buffer kit
3-5000.598	198 840 225	Surface mount bracket
3-5000.399	198 840 224	5 x 5 inch adapter plate for Signet retrofit
3-9000.392	159 000 368	Liquid-tight connector kit, 3 sets, 1/2 in. NPT
3-9000.392-1	159 000 839	Liquid-tight connector kit, 1 set, 1/2 in. NPT
3-9000.392-2	159 000 841	Liquid-tight connector kit, 1 set, PG 13.5
7300-7524	159 000 687	24 VDC Power Supply 7.5 Ω , 300mA
7300-1524	159 000 688	24 VDC Power Supply 15 Ω , 600mA
7300-3024	159 000 689	24 VDC Power Supply 30 Ω , 1.3 A
7300-5024	159 000 690	24 VDC Power Supply 50 Ω , 2.1 A
7300-1024	159 000 691	24 VDC Power Supply 100 Ω , 4.2 A



Georg Fischer Signet LLC, 3401 Aero Jet Avenue, El Monte, CA 91731-2882 U.S.A. • Tel. (626) 571-2770 • Fax (626) 573-2057
For Worldwide Sales and Service, visit our website: www.gfsignet.com • Or call (in the U.S.): (800) 854-4090
For the most up-to-date information, please refer to our website at www.gfsignet.com