

Emerson™ Wireless 1410D Gateway with 781 Field Link



- Gateway connects the *WirelessHART*® self-organizing networks with any host system
- Easy configuration and management of self-organizing networks
- Easy integration into control systems and data applications through serial and Ethernet connections
- Seamless integration into AMS Device Manager
- Greater than 99 percent data reliability with industry proven security
- Wireless capabilities extend the full benefits of Plantweb™ architecture to previously inaccessible locations

Emerson Wireless Solution

IEC 62591 (WirelessHART)... the industry standard

Self-organizing, adaptive mesh routing

- No wireless expertise required, network automatically finds the best communication paths
- The self-organizing, self-healing network manages multiple communication paths for any given device. If an obstruction is introduced into the network, data will continue to flow because the device already has other established paths. The network will then lay in more communication paths as needed for that device

Reliable wireless architecture

- Standard IEEE 802.15.4 radios
- 2.4 GHz ISM band sliced into 15 radio-channels
- Time Synchronized Channel Hopping to avoid interference from other radios, Wi-Fi®, and EMC sources and increase reliability
- Direct sequence spread spectrum (DSSS) technology delivers high reliability in challenging radio environment

Emerson Wireless

Seamless integration via LAN to all existing host systems

- Native integration into Ovation™ is transparent and seamless
- Gateways interface with existing host systems via LAN using industry standard protocols including OPC, Modbus® TCP/IP, and Modbus RTU

Layered security keeps your network safe

- All wireless data is encrypted so your data is kept safe
- All wireless devices are authenticated so you know exactly what is on your network
- Third party security certifications including Achilles and FIPS-197 certification demonstrate Emerson's commitment to security
- Complete control of your network using the Gateway secure web interface

SmartPower™ solutions

- Optimized Emerson instrumentation, both hardware and software, to extend power module life
- SmartPower technologies enable predictable power life

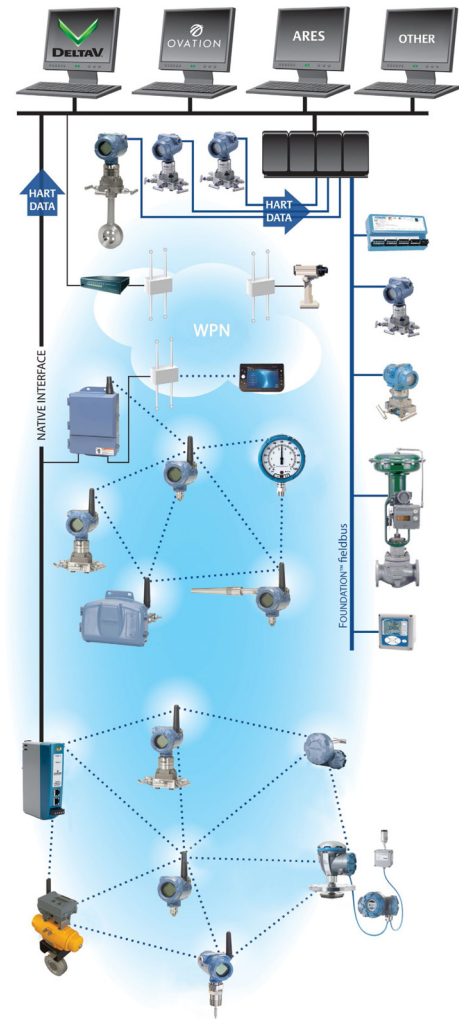

Contents

Emerson Wireless 1410D Gateway and 781 Field Link	...3	Specifications 8
Emerson Wireless 1410D Gateway4	Product certifications 11
Emerson Wireless 781 Field Link6	Dimensional drawings 15

Emerson Wireless 1410D Gateway and 781 Field Link

Gain real-time process information with greater than 99 percent wireless data reliability

- The Emerson Wireless 1410D Gateway with 781 Field Link automatically manages wireless communications in constantly changing environments
- Native integration with DeltaV™ and Ovation automation systems provides simple and fast commissioning for wireless field networks
- Connect to data historians, legacy host systems, and other applications through EtherNet, Modbus TCP, Modbus RTU, OPC, EtherNet/IP™, and HART® outputs



Guarantee system availability with redundant Wireless Gateways

- Never lose the wireless network with hot standby capability and automatic fault detection
- Wireless Gateways function as a single system, eliminating the need for duplicate host integration
- One-click configuration and plug-and-play architecture

Complete wireless network configuration tools provided with each Gateway

- The integrated web interface allows easy configuration of the wireless network and data integration without the need to install additional software
- Complimentary AMS Wireless Configurator software provides Emerson Device Dashboards to configure devices and view diagnostic data
- Drag and drop device provisioning enables a secure method to add new wireless devices to the wireless field network



Emerson Wireless 1410D Gateway

Specification and selection of product materials, options, or components must be made by the purchaser of the equipment. See [page 8](#) for more information on material selection

Table 1. Emerson Wireless 1410D Gateway Ordering Information

The starred offerings (★) represent the most common options and should be selected for best delivery. The non-starred offerings are subject to additional delivery lead time.

Model	Product description	
1410	Wireless Gateway, 2.4 GHz DSSS, <i>Wireless</i> HART, Webserver, AMS Ready, HART-IP™	★
Wireless configuration		
D ⁽¹⁾	100 Device Network with Emerson 781 Field Link (10.5 to 30 Vdc)	★
EtherNet communications - physical connection		
1 ⁽²⁾⁽³⁾	Single EtherNet connection	★
2 ⁽⁴⁾⁽⁵⁾⁽⁶⁾	Dual EtherNet connection	★
Serial communication		
N	None	★
A ⁽⁷⁾	Modbus RTU via RS-485	★
EtherNet communication - data protocols		
D1	Modbus TCP/IP	★
D2	OPC	★
D3	EtherNet/IP	★
D4	Modbus TCP/IP, OPC	★
D5	EtherNet/IP, Modbus TCP/IP	★
D6	EtherNet/IP, OPC	★
E1 ⁽⁸⁾	DeltaV ready	★
E2 ⁽⁸⁾	Ovation ready	★
E3 ⁽⁹⁾	Webserver only	★
Antenna options		
WNA	For use with the Emerson Wireless 781 Remote Field Link	★
Product certifications		
NA	No approvals	★
N1	ATEX Type n	
N5	USA Division 2, Non-incendive	★
N6	Canada Division 2, Non-incendive	★
N7	IECEx Type n	

Table 1. Emerson Wireless 1410D Gateway Ordering Information

The starred offerings (★) represent the most common options and should be selected for best delivery. The non-starred offerings are subject to additional delivery lead time.

Redundancy options ⁽¹⁰⁾⁽¹¹⁾		
RD	Gateway redundancy	★

1. Must order the Emerson Wireless 781Remote Field Link. Reference [Emerson Wireless 781 Field Link on page 6](#) for details.
2. Single active 10/100 baseT EtherNet port with RJ45 connector.
3. Additional ports disabled.
4. Dual active 10/100 baseT EtherNet ports with RJ45 connectors.
5. Multiple active ports have separate IP addresses, firewall isolation, and no packet forwarding.
6. Selection of Dual EtherNet option code 2 is recommended.
7. Convertible to RS232 via adapter, not included with Gateway.
8. Includes Modbus TCP and OPC.
9. Requires (A) Modbus RTU via RS-485 Communication protocol.
10. Requires the selection of Dual EtherNet option code 2.
11. Not available with EtherNet/IP option codes D3, D5, and D6.

Emerson Wireless 781 Field Link

Table 2. Emerson Wireless 781 Field Link Ordering Information

The starred offerings (★) represent the most common options and should be selected for best delivery. The non-starred offerings are subject to additional delivery lead time.

Model	Product description	
781	Wireless Field Link	★
Network capacity and physical connection		
A1	100 device capacity, RS485	★
C1 ⁽¹⁾	25 Device Capacity, RS485	★
Housing		
D	Dual compartment housing - aluminum	★
E	Dual compartment housing - stainless steel	★
Conduit threads		
1	1/2–14 NPT	★
Product certifications		
I3 ⁽²⁾	China Intrinsic Safety	★
I5 ⁽²⁾	USA Intrinsically Safe, Non-incendive	★
I6 ⁽²⁾	Canada Intrinsically Safe	★
I1 ⁽²⁾	ATEX Intrinsic Safety	★
I7 ⁽²⁾	IECEX Intrinsic Safety	★
KD ⁽²⁾	USA and Canada Intrinsically Safe, ATEX and IECEX Intrinsic Safety	★
KL ⁽²⁾	USA and Canada Intrinsically Safe, ATEX Intrinsic Safety	★
IM ⁽²⁾	Technical Regulations Customs Union (EAC) Intrinsic Safety	★
NA	No approvals	★
Wireless update rate, operating frequency, and protocol		
WA3	User configurable update rate, 2.4 GHz DSSS, <i>WirelessHART</i>	★
Omnidirectional wireless antenna and SmartPower		
WM3	Extended range, external antenna, line power 10 to 30 Vdc	★
Display		
M5	LCD display	★

Table 2. Emerson Wireless 781 Field Link Ordering Information

The starred offerings (★) represent the most common options and should be selected for best delivery. The non-starred offerings are subject to additional delivery lead time.

Gland and connector options		
G2	Cable gland (7.5 to 11.9 mm)	
G4	Thin wire cable gland (3 to 8 mm)	
Typical model number: 781 A1 D 1 KL WA3 WM3 M5		

1. Only works with firmware version 4.7.53 or higher.
2. Use of the Emerson Wireless 781 Field Link with an 1410D Gateway requires the use of an appropriate intrinsic safety barrier.

Table 3. Accessories

Item description	Part number
Serial Port HART Modem and cables only	03095-5105-0001
USB Port HART Modem and cables only	03095-5105-0002

Specifications

Emerson Wireless 1410D Gateway

Functional specifications

Input voltage

10.5 to 30 Vdc

Note

For best results, use a high quality industrial galvanically isolated power supply.

Current draw

Operating current draw is based on 3.6 W power consumption.

At startup, the power supply must be capable of momentarily sourcing at least twice the operating current indicated in the figure below. The Gateway may draw significantly more current momentarily at startup if not limited by the power supply.

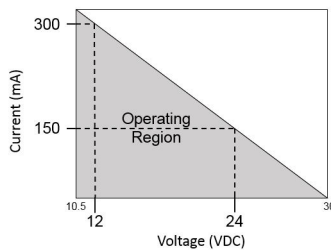

Note

For recommended intrinsic safety barrier installation:

- Input voltage 20 to 30 Vdc is needed
- Current draw is based on 6.6 W power consumption of Gateway and barriers combined

Environmental

Operating temperature range:
-40 to 167 °F (-40 to 75 °C)

Operating humidity range:
0 to 100% relative humidity

Electromagnetic Compatibility (EMC) performance

Meets all industrial environment requirements of EN61326 and NAMUR NE-21. Maximum deviation <1% span during EMC disturbance⁽¹⁾.

1. During surge event, device may exceed maximum EMC deviation limit or reset; however, device will self-recover and return to normal operation within specified start-up time.

Antenna options

See “Emerson Wireless 781 Field Link” on page -9.

Physical specifications

Material selection

Emerson provides a variety of Rosemount™ product with various product options and configurations including materials of construction that can be expected to perform well in a wide range of applications. The Rosemount product information presented is intended as a guide for the purchaser to make an appropriate selection for the application. It is the purchaser's sole responsibility to make a careful analysis of all process parameters (such as all chemical components, temperature, pressure, flow rate, abrasives, contaminants, etc.), when specifying product, materials, options and components for the particular application. Emerson is not in a position to evaluate or guarantee the compatibility of the process fluid or other process parameters with the product, options, configuration or materials of construction selected.

Weight

0.70 lb (0.318 kg)

Material of construction

Housing

Polycarbonate

Rail mount

Top hat rail EN 50022
(35 x 7.5 mm and 35 x 15 mm)

Communication specifications

Isolated RS-485

2-wire communication link for Modbus RTU multidrop connections

Baud rate: 57600, 38400, 19200, or 9600

Protocol: Modbus RTU

Wiring: Single twisted shielded pair, 18 AWG

Wiring distance: approximately 4000 ft. (1,524 m)

EtherNet

Ethernet Ports 1 and 2 are independent interfaces with unique MAC addresses, no routing or switching capabilities

10/100base-TX EtherNet communication port

Protocols: Modbus TCP, OPC, EtherNet/IP, HART-IP, https
(for Web Interface)

Wiring: Cat5E shielded cable

Wiring distance: 328 ft. (100 m)

Modbus

Supports Modbus RTU and Modbus TCP with 32-bit floating point values, integers, and scaled integers.

Modbus Registers are user-specified.

OPC

OPC server supports OPC DA v2, v3

EtherNet/IP

Supports EtherNet/IP protocol with 32-bit Floating Point values and Integers

EtherNet/IP Assembly Input-Output instances are user configurable.

EtherNet/IP specifications are managed and distributed by ODVA.

For details on capabilities, see the Emerson Wireless [Manual Supplement](#).

Self-organizing network specifications**Protocol**

IEC 62591 (*WirelessHART*), 2.4 to 2.5 GHz DSSS

Maximum network size

- 100 wireless devices at 8 seconds or more
- 50 wireless devices at 4 seconds
- 25 wireless devices at 2 seconds
- 12 wireless devices at 1 second

For information on network size and update rate, see the capacity estimator tool on the Emerson Wireless [homepage](#).

Supported device update rates

1, 2, 4, 8, 16, 32 seconds or 1 to 60 minutes

Network size/latency

100 Devices: less than 10 seconds

50 Devices: less than 5 seconds

Data reliability

> 99 percent

System security specifications**EtherNet**

Secure Sockets Layer (SSL) enabled (default) TCP/IP communications.

Emerson Wireless Gateway access

Role-Based Access Control (RBAC) including Administrator, Maintenance, Operator, and Executive. Administrator has complete control of the Gateway and connections to host systems and the self-organizing network.

Self-organizing network

AES-128 Encrypted *WirelessHART*, including individual session keys. Drag and drop device provisioning, including unique join keys and white listing.

Internal firewall

User configurable TCP ports for communications protocols, including Enable/Disable and user specified port numbers. Inspects both incoming and outgoing packets.

Third party certification

Wurldtech: Achilles Level 1 certified for network resiliency

National Institute of Standards and Technology (NIST): Advanced Encryption Standard (AES) Algorithm conforming to Federal Information Processing Standard Publication 197 (FIPS-197).

Emerson Wireless 781 Field Link**Functional specifications****Wireless output**

IEC 62591 (*WirelessHART*), 2.4 GHz DSSS

Local display

The optional five-digit integral LCD display can display wireless information.

Environmental

0 to 99 percent non-condensing relative humidity

Radio frequency power output from antenna

External antenna (WK1 option):
Maximum of 10 mW (10 dBm) EIRP

Field link wiring distance

Wiring distance between Field Link and Gateway:
up to 200 m using single twisted shielded pair, 18 AWG

Barrier Recommendations

For use in a hazardous area the recommended intrinsic safety barriers are

Signal Barrier:

- GM-International D1016S
- Stahl 9176 10-16-00

Physical specifications

Material selection

Emerson provides a variety of Rosemount product with various product options and configurations including materials of construction that can be expected to perform well in a wide range of applications. The Rosemount product information presented is intended as a guide for the purchaser to make an appropriate selection for the application. It is the purchaser's sole responsibility to make a careful analysis of all process parameters (such as all chemical components, temperature, pressure, flow rate, abrasives, contaminants, etc.), when specifying product, materials, options and components for the particular application.

Emerson is not in a position to evaluate or guarantee the compatibility of the process fluid or other process parameters with the product, options, configuration or materials of construction selected.

Materials of construction

Enclosure

Housing: Low-copper aluminum or stainless steel
Paint: Polyurethane
Cover O-ring: Buna-N

Terminal block and power module

PBT

Antenna

PBT/Polycarbonate (PC) integrated omni-directional antenna

Mounting

Mounting brackets also permit remote mounting.
See [Figure 3 on page 16](#).

Weight

Low-copper aluminum

Emerson Wireless 781 without LCD display - 4.1 lb (1.9 kg)
Emerson Wireless 781 with M5 LCD display - 4.2 lb (2.0 kg)

Stainless steel

Emerson Wireless 781 without LCD display - 8.0 lb (3.5 kg)
Emerson Wireless 781 with M5 LCD display - 8.1 lb (3.6 kg)

Enclosure ratings (781)

Housing style option codes D and E are Type 4X and IP66/67 rated dual-compartment housings

Performance specifications

EMC performance

Meet all industrial environment requirements of EN61326 and NAMUR NE-21. Maximum deviation <1% span during EMC disturbance.⁽¹⁾

Vibration effect

No effect when tested per the requirements of IEC60770-1 (1999):

High vibration level - field or pipeline (10 to 60 Hz 0.21 mm displacement peak amplitude/60 to 2000 Hz 3g).

1. During surge event, device may exceed maximum EMC deviation limit or reset; however, device will self-recover and return to normal operation within specified start-up time.

Product certifications

Emerson Wireless 1410 Gateway

Rev 2.0

European Directive Information

A copy of the EU Declaration of Conformity can be found at the end of the Quick Start Guide. The most recent revision of the EUC Declaration of Conformity can be found at Emerson.com/Rosemount.

Telecommunication Compliance

All wireless devices require certification to ensure that they adhere to regulations regarding the use of the RF spectrum. Nearly every country requires this type of product certification.

Emerson is working with governmental agencies around the world to supply fully compliant products and remove the risk of violating country directives or laws governing wireless device usage.

FCC and IC

This device complies with Part 15 of the FCC Rules. Operation is subject to the following conditions: This device may not cause harmful interference. This device must accept any interference received, including interference that may cause undesired operation. This device must be installed to ensure a minimum antenna separation distance of 20 cm from all persons.

Ordinary Location Certification

As standard, the transmitter has been examined and tested to determine that the design meets the basic electrical, mechanical, and fire protection requirements by a nationally recognized test laboratory (NRTL) as accredited by the Federal Occupational Safety and Health Administration (OSHA).

Installing Equipment in North America

The US National Electrical Code® (NEC) and the Canadian Electrical Code (CEC) permit the use of Division marked equipment in Zones and Zone marked equipment in Divisions. The markings must be suitable for the area classification, gas, and temperature class. This information is clearly defined in the respective codes.

USA

- N5** USA Division 2
 Certificate: 30349590 (FM)
 Standards: FM Class 3600 – 2011,
 FM Class 3611 – 2004,
 FM Class 3616 – 2011,
 FM Class 3810 – 2005
 Markings: NI CL 1, DIV 2, GP A, B, C, D T4;
 Suitable for use in CL II, III, DIV 2, GP F, G T4;
 T4(–40 °C ≤ T_a ≤ 60 °C)

Special Condition for Safe Use:

- When installed as Division 2 equipment, the Emerson Wireless 1410 Gateway shall be mounted within a tool-secured enclosure which meets the requirements of ANSI/ISA 61010-1 and be capable of accepting the applicable wiring methods per the NEC.

Canada

- N6** Canada Division 2
 Certificate: 2646342 (CSA)
 Standards: CAN/CSA C22.2 No. 0-10,
 CSA C22.2 No. 213-M1987 (R2013),
 CSA C22.2 No. 61010-1 – 2012,
 ANSI/ISA-12.12.01 – 2012, UL61010-1,
 3rd Edition
 Markings: Suitable for CL I, DIV 2, GP A, B, C, D.
 Temperature code: T4 (–40 °C ≤ T_a ≤ 70 °C)

Note

- Shall be powered by a Class 2 power supply.
- Suitable for dry indoor locations only.
- Equipment must be installed in a suitable tool accessible enclosure subject to the end use application.
- Using the Emerson Wireless 1410D and the Wireless Field Link 781 in a hazardous location requires barriers between the two units in some cases.

Europe

- N1** ATEX Type n
 Certificate: Baseefa14ATEX0125X
 Standards: EN 60079-0: 2012, EN 60079-15: 2010
 Markings: Ⓔ II 3 G Ex nA IIC T4 Gc, T4 (–40 °C ≤ T_a ≤ 75 °C)
 ,V_{max} = 30 Vdc

Special Conditions for Safe Use:

- The equipment must be installed in an area of not more than Pollution Degree 2 as defined in IEC 60664-1, and in an enclosure that provides a degree of protection of at least IP54 and meets the relevant requirements of EN 60079-0 and EN 60079-15.
- External connections to the equipment must not be inserted or removed unless either the area in which the equipment is installed is known to be non-hazardous, or the circuits connected have been de-energised.

3. The equipment is not capable of withstanding the 500 V electrical strength test as defined in clause 6.5.1 of EN 60079-15: 2010. This must be taken into account during installation.
4. When fitted, the surface resistivity of the remote antenna is greater than 1 G Ω . To avoid electrostatic charge build up, it must not be rubbed with a dry cloth or cleaned with solvents.

International

N7 IECEx Type n
Certificate: IECEx BAS 14.0067X
Standards: IEC 60079-0: 2011, IEC 60079-15: 2010
Markings: Ex nA IIC T4 Gc, T4(-40 °C ≤ T_a ≤ 75 °C),
V_{max} = 30 Vdc

Special Conditions for Safe Use (X):

1. The equipment must be installed in an area of not more than Pollution Degree 2 as defined in IEC 60664-1, and in an enclosure that provides a degree of protection of at least IP54 and meets the relevant requirements of EN 60079-0 and EN 60079-15.
2. External connections to the equipment must not be inserted or removed unless either the area in which the equipment is installed is known to be nonhazardous, or the circuits connected have been de-energised.
3. The equipment is not capable of withstanding the 500 V electrical strength test as defined in clause 6.5.1 of EN 60059-15: 2010. This must be taken into account during installation.
4. When fitted, the surface resistivity of the remote antenna is greater than 1 G Ω . To avoid electrostatic charge build-up, it must not be rubbed with a dry cloth or cleaned with solvents.

Emerson Wireless 781 Field Link

Rev 2.0

European Directive Information

A copy of the EU Declaration of Conformity can be found at the end of the Quick Start Guide. The most recent revision of the EU Declaration of Conformity can be found at Emerson.com/Rosemount.

Ordinary Location Certification

As standard, the transmitter has been examined and tested to determine that the design meets the basic electrical, mechanical, and fire protection requirements by a nationally recognized test laboratory (NRTL) as accredited by the Federal Occupational Safety and Health Administration (OSHA).

Installing in North America

The US National Electrical Code (NEC) and the Canadian Electrical Code (CEC) permit the use of Division marked equipment in Zones and Zone marked equipment in Divisions. The markings must be suitable for the area classification, gas, and temperature class. This information is clearly defined in the respective codes.

USA

- I5** USA Intrinsically Safe (IS), Nonincendive (NI) and Dust-ignitionproof
 Certificate: FM17US0235X
 Standards: FM Class 3600 – 2011,
 FM Class 3610 – 2010,
 FM Class 3611 – 2004,
 FM Class 3810 – 2005,
 ANSI/ISA 60079-0:2009,
 ANSI/UL 60079-11:2009,
 ANSI/ISA 61010-1:2004,
 ANSI/NEMA 250 – 2003,
 ANSI/IEC 60529 – 2004
 Markings: IS CL I, DIV 1, GP A, B, C, D; CL II, DIV 1, GP E, F, G; Class III T4; Class 1, Zone 0 AEx ia IIC T4;
 NI CL I, DIV 2, GP A, B, C, D T4; DIP CL II, DIV 1, GP E, F, G; CL III T4; when installed per drawing 00781-1010 T4(-40 °C ≤ T_a ≤ +70 °C)

Input parameters (power terminals)	Input parameters	Output parameters
	Sensor terminals	
V _{MAX} /U _i = 30 V	V _{MAX} /U _i = 11 V	V _{oc} /U _o = 7.14 V
I _{MAX} /I _i = 200 mA	I _{MAX} /I _i = 300 mA	I _{sc} /I _o = 112 mA
P _{MAX} /P _i = 1 W	P _{MAX} /P _i = 1 W	P _{MAX} /P _o = 640 mW
C _i = 10 nF	C _i = 5 nF	C _a /C _o = 13.49 μF
L _i = 3.3 μH	L _i = 2.2 μH	L _a /L _o = 2 mH

Special Conditions for Safe Use (X):

- The Emerson Wireless 781 transmitter housing contains aluminum and is considered a potential risk of ignition by impact or friction. Care must be taken into account during installation and use to prevent impact and friction.
- The surface resistivity of the unit is greater than 1 gigaohm. To avoid electrostatic charge buildup, it must not be rubbed or cleaned with solvents or a dry cloth.
- The Emerson Wireless 781 transmitter will not pass the 500 Vrms electric strength test and this must be taken into account during installation.

Canada

- I6** Canada Intrinsically Safe
 Certificate: CSA 2330424
 Standards: CSA C22.2 No. 0-10,
 CSA C22.2 No.94-M91,
 CSA Std. C22.2 No. 142-1987,
 CSA-C22.2 No. 157-92,
 CSA Std. C22.2 No. 60529 - 2005
 Markings: Intrinsically Safe Class I, Division 1, Groups A, B, C, and D T3C (T_a ≤ +60 °C) Type 4X;
 IP 66/67;when installed per 00781-1011

Europe

- I1** ATEX Intrinsic Safety
 Certificate: Baseefa11ATEX0059X
 Standards: EN 60079-0: 2012 + A11: 2013,
 EN 60079-11: 2012
 Markings: Ⓔ II 1 G Ex ia IIC T4 Ga,
 T4(-40 °C ≤ T_a ≤ +70 °C)

Input parameters (power terminals)	Input parameters	Output parameters
	RS485	
U _i = 30 V	U _i = 11 V	U _o = 7.14 V
I _i = 200 mA	I _i = 300 mA	I _o = 112 mA
P _i = 1 W	P _i = 1 W	P _o = 1 W
C _i = 0 μF	C _i = 5.1 nF	C _o = 13.9 μF
L _i = 0 mH	L _i = 0 mH	L _o = 1000 μH

Special Conditions for Safe Use (X):

- The plastic antenna may present a potential electrostatic ignition hazard and must not be rubbed or cleaned with a dry cloth.
- The Emerson Wireless 781 enclosure is made of aluminum alloy and given a protective paint finish; however, care should be taken to protect it from impact or abrasion if located in a zone 0 environment.
- The apparatus is not capable of withstanding the 500 V isolation test required by EN 60079-11. This must be taken into account when installing the apparatus.

International

I7 IECEx Intrinsic Safety
 Certificate: IECEx BAS 11.0028X
 Standards: IEC 60079-0: 2011,
 IEC 60079-11: 2011
 Markings: Ex ia IIC T4 Ga, T4(-40 °C ≤ T_a ≤ +70 °C)

Input parameters (power terminals)	Input parameters	Output parameters
	RS485	
U _i = 30 V	U _i = 11 V	U _o = 7.14 V
I _i = 200 mA	I _i = 300 mA	I _o = 112 mA
P _i = 1 W	P _i = 1 W	P _o = 1 W
C _i = 0 μF	C _i = 5.1 nF	C _o = 13.9 μF
L _i = 0 mH	L _i = 0 mH	L _o = 1000 μH

Special Conditions for Safe Use (X):

1. The plastic antenna may present a potential electrostatic ignition hazard and must not be rubbed or cleaned with a dry cloth.
2. The Emerson Wireless 781 enclosure is made of aluminum alloy and given a protective paint finish; however, care should be taken to protect it from impact or abrasion if located in a zone 0 environment.
3. The apparatus is not capable of withstanding the 500 V isolation test required by EN 60079-11. This must be taken into account when installing the apparatus.

China

I3 China Intrinsic Safety
 Certificate: GYJ13.1444X
 Standards: GB3836.1-2010,
 GB3836.4-2010,
 GB3836.20-2010
 Markings: Ex ia IIC T4 Ga, -40 ~ +70 °C

Special Condition for Safe Use (X):

1. See certificate for special conditions.

EAC - Belarus, Kazakhstan, Russia

IM Technical Regulation Customs Union (EAC) Intrinsic Safety
 Certificate: RU C-US.Gb05.B.00643
 Markings: 0Ex ia IIC T4 Ga X

Input parameters (power terminals)	Input parameters	Output parameters
	RS485	
U _i = 30 B	U _i = 11 B	U _o = 7.14 B
I _i = 200 mA	I _i = 300 mA	I _o = 112 mA
P _i = 1 B _T	P _i = 1 B _T	P _o = 1 B _T
C _i = 0 мкФ	C _i = 5.1 нФ	C _o = 13.9 мкФ
L _i = 0 мГн	L _i = 0 мГн	L _o = 0 мГн

Special Condition for Safe Use (X):

1. See certificate for special conditions.

Combinations

KD Combination of I1, I5, and I6
KL Combination of I1, I5, I6, and I7

Dimensional drawings

Figure 1. Emerson Wireless 1410D Gateway

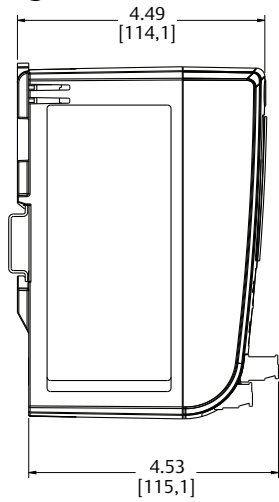

Dimensions are in inches (millimeters).

Note

Allow extra space in front of unit for wiring, antenna connector and antenna cable service loop.

Figure 2. Emerson Wireless 1410D Gateway with 781 Field Link

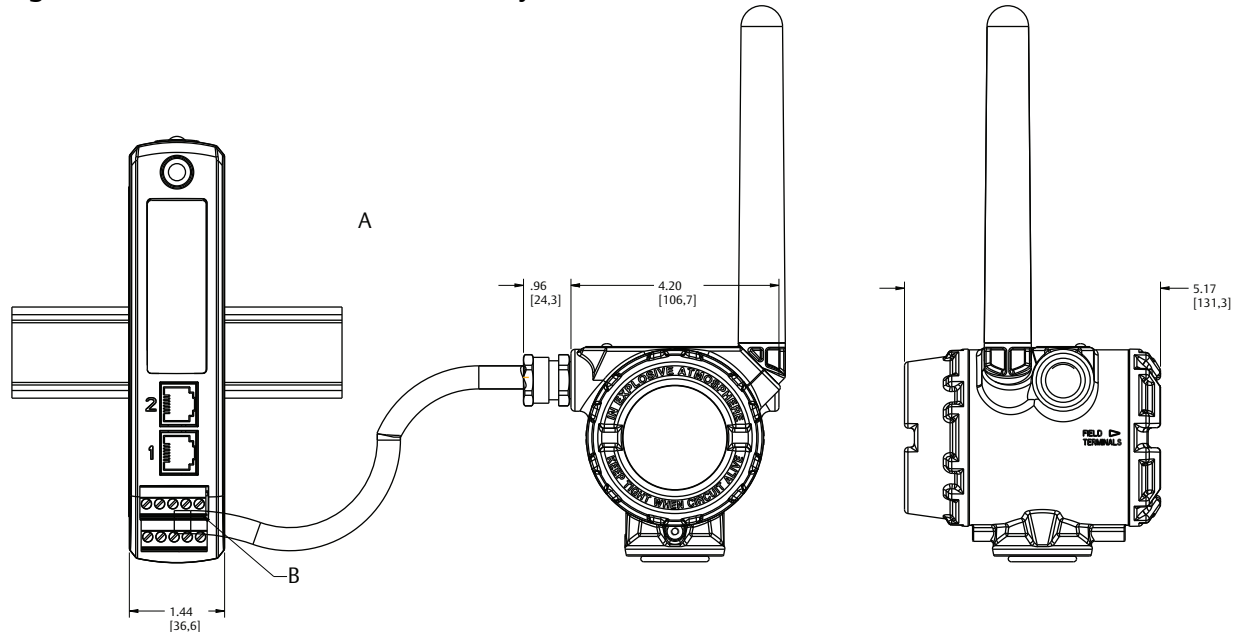

- A. Cable not provided
- B. Connectors

Dimensions are in inches (millimeters)

Figure 3. Transmitter Mounting Configurations with Optional Mounting Bracket

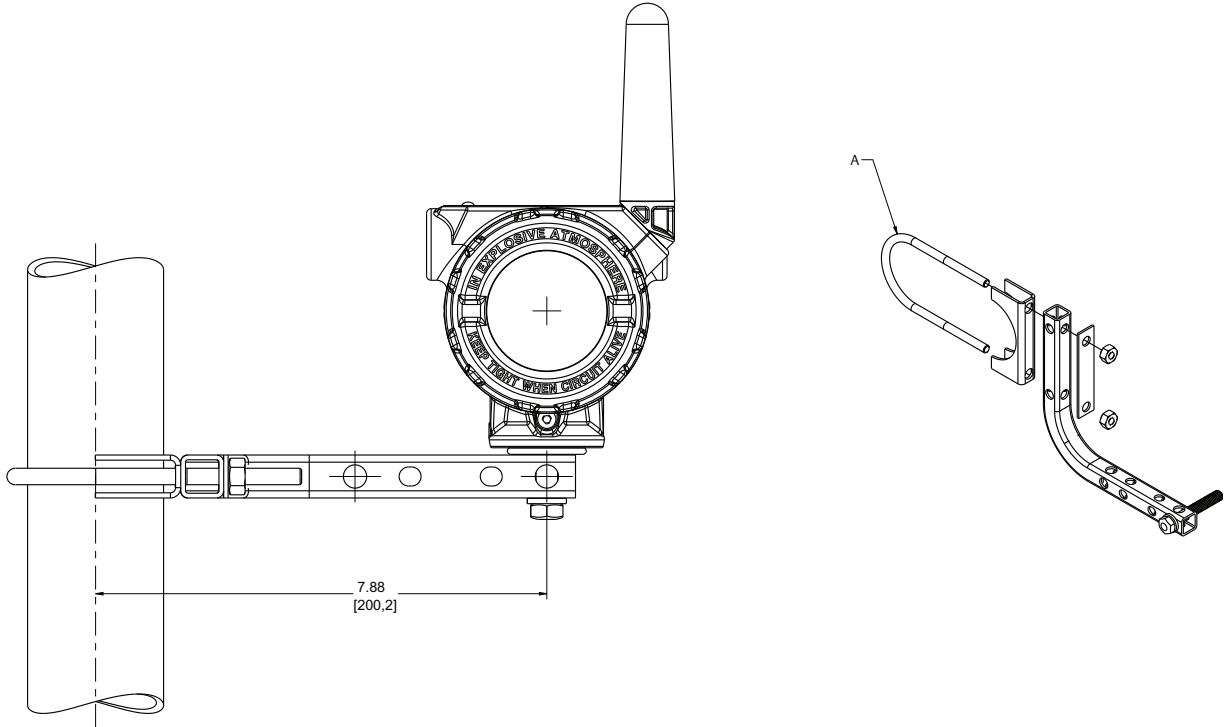



A. 2-in. U-bolt for pipe mounting

Dimensions are in inches (millimeters).



Global Headquarters

Emerson Automation Solutions

6021 Innovation Blvd.
Shakopee, MN 55379, USA
 +1 800 999 9307 or +1 952 906 8888
 +1 952 949 7001
 RFQ.RMD-RCC@Emerson.com



North America Regional Office

Emerson Automation Solutions

8200 Market Blvd.
Chanhassen, MN 55317, USA
 +1 800 999 9307 or +1 952 906 8888
 +1 952 949 7001
 RMT-NA.RCCRFQ@Emerson.com



Latin America Regional Office

Emerson Automation Solutions

1300 Concord Terrace, Suite 400
Sunrise, FL 33323, USA
 +1 954 846 5030
 +1 954 846 5121
 RFQ.RMD-RCC@Emerson.com

Europe Regional Office

Emerson Automation Solutions Europe GmbH

Neuhofstrasse 19a P.O. Box 1046
CH 6340 Baar
Switzerland
 +41 (0) 41 768 6111
 +41 (0) 41 768 6300
 RFQ.RMD-RCC@Emerson.com

Asia Pacific Regional Office

Emerson Automation Solutions

1 Pandan Crescent
Singapore 128461
 +65 6777 8211
 +65 6777 0947
 Enquiries@AP.Emerson.com

Middle East and Africa Regional Office

Emerson Automation Solutions

Emerson FZE P.O. Box 17033
Jebel Ali Free Zone - South 2
Dubai, United Arab Emirates
 +971 4 8118100
 +971 4 8865465
 RFQ.RMTMEA@Emerson.com

 [Linkedin.com/company/Emerson-Automation-Solutions](https://www.linkedin.com/company/Emerson-Automation-Solutions)

 [Twitter.com/Rosemount_News](https://twitter.com/Rosemount_News)

 [Facebook.com/Rosemount](https://www.facebook.com/Rosemount)

 [Youtube.com/user/RosemountMeasurement](https://www.youtube.com/user/RosemountMeasurement)

 [Google.com/+RosemountMeasurement](https://plus.google.com/+RosemountMeasurement)

Emerson Terms and Conditions of Sale are available upon request.
The Emerson logo is a trademark and service mark of Emerson Electric Co.
Rosemount is a mark of one of the Emerson family of companies. All other
marks are the property of their respective owners.
© 2018 Emerson. All rights reserved.