

# FLUKE®

# 714

## *Thermocouple Calibrator*

### *Instruction Sheet*

#### ***Introduction***

The Fluke 714 Thermocouple Calibrator is a precise source and measurement tool for calibrating thermocouple instruments. The calibrator sources or measures in units of °C, °F, or mV, through a thermocouple minijack.

Your calibrator is supplied with a Flex-Stand™ holster, an installed 9 V alkaline battery, and this instruction sheet. Sets of thermocouple miniplugs are available from Fluke. (Accessories Fluke-700TC1 and Fluke-700TC2 TC Miniplug Kits.)

If the calibrator is damaged or something is missing, contact the place of purchase immediately. Contact your Fluke distributor for information about accessories. To order replacement parts or spares, see "Replacement Parts."

The following tables list the thermocouple types supported by the calibrator, the standards and scales used for each type, the thermocouple properties, and calibrator resolution. Full calibrator specifications are listed at the end of this instruction sheet.

#### *Note*

*Since mV input and output units are available, you can use the calibrator for any thermocouple type by making manual calculations or referring to tables.*

### Thermocouple Standards and Scales

Thermocouple Type	Standard	Scale
J, K, T, E, R, S, B	NIST 175	ITS-90
L (J-DIN), U (T-DIN)	DIN 43710	IPTS-68

### Thermocouple Properties

Thermocouple Type	Temperature Ranges	Display Resolution
J	-200 to 1200°C, -328 to 2192°F	0.1°C or °F
K	-200 to 1370°C -328 to 2498°F	0.1°C or °F
T	-200 to 400°C -328 to 752°F	0.1°C or °F
E	-200 to 950°C -328 to 1742°F	0.1°C or °F
R	-20 to 1750°C -4 to 3182°F	1°C or °F
S	-20 to 1750°C -4 to 3182°F	1°C or °F
B	600 to 1800°C 1112 to 3272°F	1°C or °F
L	-200 to 900°C -328 to 1652°F	0.1°C or °F
U	-200 to 600°C -328 to 1112°F	0.1°C or °F







### Millivolt Range and Resolution

Mode	Range	Display Resolution
mV	-10 to 75 mV	0.01 mV

### ***Explanation of International Symbols***

The following symbols are used on the calibrator or in this instruction sheet. The table below explains their meaning.

#### International Symbols

Symbol	Meaning
	Earth ground
	Fuse
	Battery
	Refer to this instruction sheet for information about this feature.
	Double insulated
	Conforms to relevant Canadian Standards Association directives.
	Conforms to European Union directives

## ***Safety Information***

### **⚠ Warning**

To avoid possible electric shock or personal injury:

- **Never apply more than 30 V between the TC terminals, or between either TC terminal and earth ground.**
- **Make sure the battery door is closed and latched before you operate the calibrator.**
- **Remove an attached thermocouple miniplug from the calibrator before you open the battery door.**
- **Do not operate the calibrator if it is damaged.**
- **Do not operate the calibrator around explosive gas, vapor, or dust.**

When servicing the calibrator, use only specified replacement parts.

### ***Turning the Calibrator On***

Press the green © pushbutton to turn the calibrator on and off.

# Measuring a Thermocouple

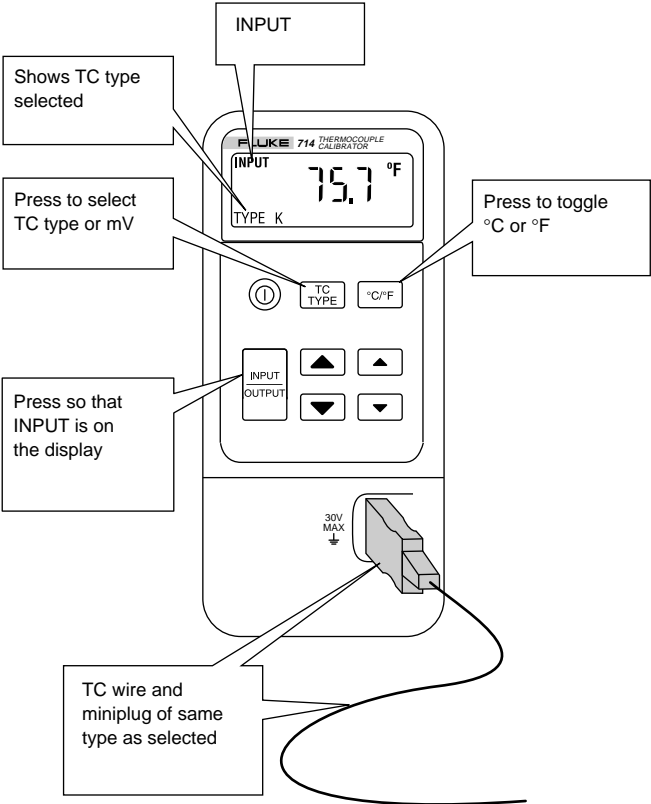

# Simulating a Thermocouple

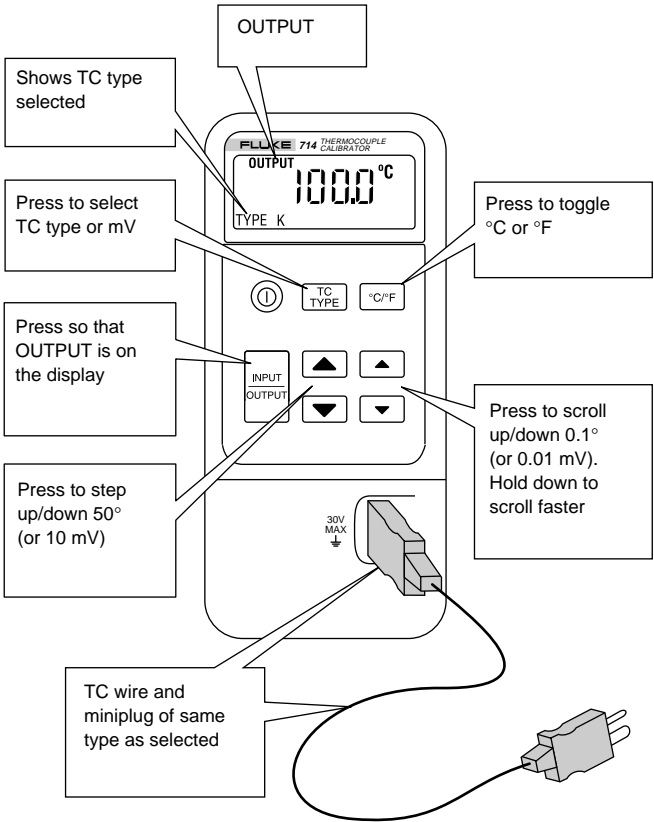

## ***Maintenance***

For maintenance procedures not described in this sheet, contact a Fluke Service Center.

### ***In Case of Difficulty***

- Check the battery and thermocouple test wiring. Replace as necessary.
- Review this sheet to make sure you are using the calibrator correctly.

If the calibrator needs repair, contact a Fluke Service Center. If the calibrator is under warranty, see the warranty statement for terms. If the warranty has lapsed, the calibrator will be repaired and returned for a fixed fee. Contact a Fluke Service Center for information and price.

### ***Cleaning***

Periodically wipe the case with a damp cloth and detergent; do not use abrasives or solvents.

### ***Calibration***

Calibrate your calibrator once a year to ensure that it performs according to its specifications. A calibration manual is available (PN 686540). Call 1-800-526-4731 from the USA and Canada. In other countries, contact a Fluke Service Center.

### ***Replacing the Battery***

When the  symbol appears on the display, replace the battery with a 9 V alkaline battery.

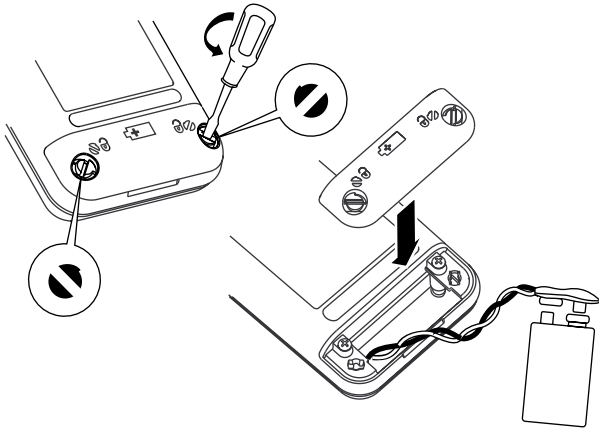

it07f.eps

## ***Replacing the Fuse***

### **⚠ Warning**

**To avoid personal injury or damage to the calibrator, use only a 0.125A 250V fast fuse, Littelfuse® 2AG.**

Fuse F1 is probably blown if in the input mode, the calibrator always reads OL, even with a thermocouple connected.



Replace the fuse as follows:

1. Remove the test leads and turn the calibrator off.
2. Remove the battery door.
3. Remove the three Phillips-head screws from the case bottom and turn the case over.
4. Gently lift the top cover from the end nearest the input/output terminals until it unsnaps from the bottom cover.
5. Replace the fuse with a 0.125 A 250 V fast fuse, Littelfuse® 2AG.
6. Fit the top and bottom covers together, engaging the two snaps. Make sure that the gasket is properly seated. Reinstall the three screws.
7. Replace the battery door.

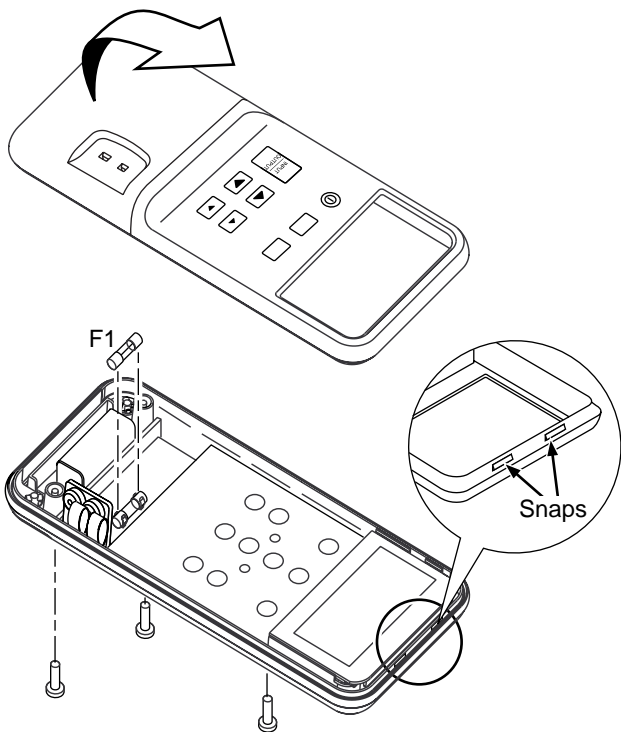

# ***Replacement Parts and Accessories***

## **Replacement Parts**

<b>Item</b>	<b>Description</b>	<b>PN or Model no.</b>	<b>Qty.</b>
BT1	9V battery, ANSI/NEDA 1604A or IEC 6LR61	614487	1
CG81Y	Holster, Yellow	CG81Y	1
 F1	Fuse, 125 mA, 250V fast	686527	1
MP85	Case top	620234	1
MP86	Case bottom	620168	1
H2, 3, 4	Case screw	832246	3
MP89, 90	Non-skid foot	824466	2
MP92	Battery door	619947	1
H5, 6	Battery door fasteners	948609	2
S1	Keypad	687076	1
–	714 Instruction Sheet	560306	1
–	71X Series Calibration Manual	686540	Option

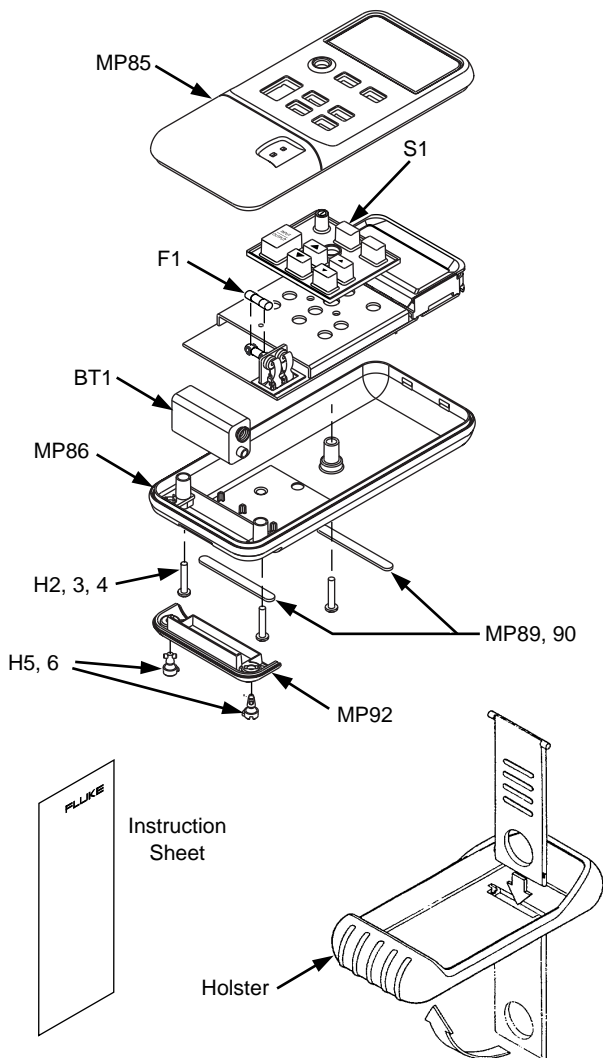

## Specifications

Specifications are based on a one year calibration cycle and apply for ambient temperature from +18°C to +28°C unless stated otherwise. “Counts” means number of increments or decrements of the least significant digit.

### Temperature Measure and Thermocouple Simulate

TC Type	Resolution	Error	Reference Junction Error
J, K, T, E, L, U	0.1°C or °F	$\pm(0.3^{\circ}\text{C} + 10 \mu\text{V})$	$\pm 0.2^{\circ}\text{C}$
B, R, S	1°C or °F	$\pm(0.3^{\circ}\text{C} + 10 \mu\text{V})$	$\pm 0.2^{\circ}\text{C}$

*Maximum input voltage: 30 V*

### Millivolt Measure and Source

Range	Resolution	Accuracy
-10 mV to 75 mV	0.01 mV	$\pm(0.025\% + 1 \text{ count})$

*Maximum input voltage: 30 V*

## ***General Specifications***

**Maximum voltage applied between any terminal and earth ground or between any two terminals:** 30 V

**Storage temperature:** -40°C to 60°C

**Operating temperature:** -10°C to 55°C

**Operating altitude:** 3000 meters maximum

**Temperature coefficient:** 0.05 x specified accuracy per °C for temperature ranges -10°C to 18°C and 28°C to 55°C

**Relative humidity:** 95% up to 30°C, 75% up to 40°C, 45% up to 50°C, and 35% up to 55°C

**Vibration:** Random 2 g, 5 Hz to 500 Hz

**Shock:** 1 meter drop test

**Safety:** Certified as compliant to CAN/CSA C22.2 No. 1010.1:1992. Complies with ANSI/ISA S82.01-1994.

**Power requirements:** Single 9 V battery (ANSI/NEDA 1604A or IEC 6LR61)

**Size:** 32 mm H x 87 mm W x 187 mm L (1.25 in H x 3.41 in W x 7.35 in L);

With holster and Flex-Stand: 52 mm H x 98 mm W x 201 mm L (2.06 in H x 3.86 in W x 7.93 in L)

**Weight:** 332 g (11.7 oz);

With holster and Flex-Stand: 584 g (20.6 oz)

## ***How to Contact Fluke***

To order accessories, receive operating assistance, or get the location of the nearest Fluke distributor or Service Center, call:

1-800-44FLUKE (1-800-443-5853) in U.S.A. and Canada

+31-402-678-200 in Europe

+1-425-356-5500 from other countries

Address correspondence to:

Fluke Corporation  
P.O. Box 9090,  
Everett, WA 98206-9090  
U.S.A.

Fluke Europe B.V.  
P.O. Box 1186,  
5602 BD Eindhoven  
The Netherlands

Visit us on the World Wide Web at: **[www.fluke.com](http://www.fluke.com)**

### **LIMITED WARRANTY & LIMITATION OF LIABILITY**

This Fluke product will be free from defects in material and workmanship for three years from the date of purchase. This warranty does not cover fuses, disposable batteries or damage from accident, neglect, misuse or abnormal conditions of operation or handling. Resellers are not authorized to extend any other warranty on Fluke's behalf. To obtain service during the warranty period, send your defective calibrator to the nearest Fluke Authorized Service Center with a description of the problem.

THIS WARRANTY IS YOUR ONLY REMEDY. NO OTHER WARRANTIES, SUCH AS FITNESS FOR A PARTICULAR PURPOSE, ARE EXPRESSED OR IMPLIED. FLUKE IS NOT LIABLE FOR ANY SPECIAL, INDIRECT, INCIDENTAL OR CONSEQUENTIAL DAMAGES OR LOSSES, ARISING FROM ANY CAUSE OR THEORY. Since some states or countries do not allow the exclusion or limitation of an implied warranty or of incidental or consequential damages, this limitation of liability may not apply to you.