

User's Manual



Datalogging AC/DC Power Clamp-on Meter

Model 382065/382068

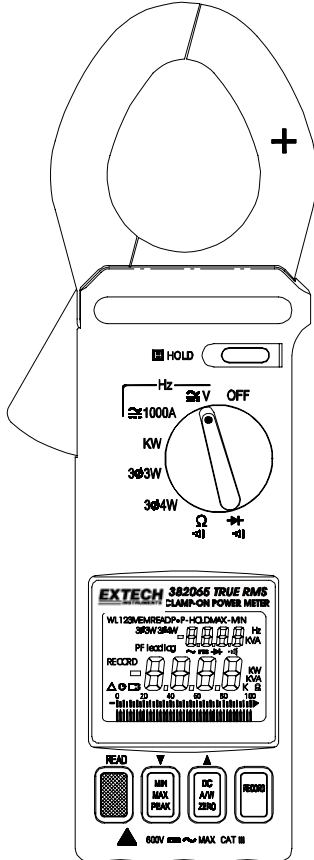

Table of Contents

Specifications	
<i>General Specifications</i>	3
<i>Range Specifications</i>	3
Safety Information	5
Meter and Display Descriptions	6
Measurements	
<i>AC/DC Power Measurements</i>	7
<i>AC/DC Voltage Measurements</i>	16
<i>AC/DC Current Measurements</i>	17
<i>Resistance and Continuity Measurements</i>	18
<i>Diode Tests</i>	19
Min/Max Mode	19
Peak Detector	19
Data Hold	19
Datalogging	20
Connecting the Meter to a PC	21
Wiring and Protocol	24
Maintenance	
<i>Battery Replacement</i>	26
<i>Cleaning</i>	26
<i>Repair and Calibration Services</i>	26
<i>Tech Support Hotlines</i>	26

Introduction

Congratulations on your purchase of the Extech 382065/382068 Datalogging AC/DC Power Clamp-on Meter. Measurements include DC and AC True Power, Apparent Power, Power Factor, and True RMS Voltage, Current, & Watts. Status indication for Lead/Lag and PF is included as well as dual displays of KW + PF, KVA + PF, V + A, A + Hz, and V + Hz. The frequency of Voltage and Current measurements can be displayed also. Datalogger and RS-232 PC interface features are built into the meter. The Datalogger/Data Acquisition Software package is for exclusive use with the Model 382065/382068 Clamp on Power Datalogger. Windows® 95, 98, NT, 2000, ME and XP operating systems are supported. Users can download readings stored in the datalogger to a PC, program sample rates for datalogging, remotely monitor readings, and save readings to ASCII files for export to spreadsheet and other programs. Careful use will provide years of reliable service.

Specifications

General Specifications

Main display	4-digit (10,000 count) multi-function LCD
Bargraph display	40-segment bargraph
Datalogger	4000 data point continuous logging (25 point manual logging) with MIN / MAX and Peak detect recording
Peak hold	Built-in detector captures positive and negative peaks to .1ms
Maximum voltage	600Vrms between any terminal and earth ground
Meter power	9V battery
Battery life	30 hours (approx.)
Low battery indication	Battery icon is displayed
Auto power off	After 30 minutes (approx.)
Display update rate	2 times per second (Bargraph); 5 times per second (Digits), (once every 6 seconds for the KW function)
Jaw opening	For Cables ϕ 1.8" (46mm)
Operating temperature	32 to 122°F (0 to 50°C)
Operating Humidity	R.H. < 80% non-condensing.
Storage temperature	14° to 140°F (-10 to 60°C)
Storage Humidity	RH < 70% non-condensing
Dimensions/Weight	10.24 x 3.66 x 1.77" (260 x 93 x 45mm) / 1 lb. (450g)
Accessories	Carrying case, test leads, and 9V battery

Range Specifications

Accuracy specs are \pm (reading + no. of digits) at 64° to 82°F (18° to 28° C) and RH to 80%

True power & Apparent power measurements (600KW Max.)

Input	Resolution	Accuracy	Frequency range	Overload protection
V<130V, A<150A	0.01	$\pm(2\%+5)$	45Hz to 500Hz	600V/1100A
V>130V, A<150A				
V<130V, A>150A	0.1	$\pm(2\%+1)$		
V>130V, A>150A				

Power Factor

Range*	Resolution	Accuracy	Frequency Range	Sensitivity
0.30 to 1.00	0.001	$\pm (4\% + 10d)$	10Hz to 5KHz	>100V / 10A
0.00 to 0.30		Not specified		

*Minimum voltage: 100V AC, Minimum Current: 20A AC

DCA

Range	Resolution	Accuracy	Overload protection
2 to 1000A	0.1A	$\pm(1.5\% + 5)$	1100A

ACA

Range	Resolution	Accuracy	Frequency range	Overload protection
2 to 1000A	0.1A	$\pm(1.5\% + 5)$	45Hz to 500Hz	1100A

Crest factor < 3 for stated accuracy

DCV

Range	Resolution	Accuracy	Input impedance	Overload protection
2 to 600V	0.1V	$\pm(0.5\% + 5)$	1M Ω	600V

ACV

Range	Resolution	Accuracy	Input impedance	Frequency range	Overload protection
2 to 600V	0.1V	$\pm(0.5\%+5)$	1M Ω	45Hz to 500Hz	600Vrms

Crest factor < 3 for stated accuracy

Peak indication

Range	Resolution	Accuracy	Overload protection
20A~80A	0.1A	$\pm(10\% + 10)$	1100A
80A~1000A	0.1A	$\pm(6\% + 10)$	1100A

Peak detect acquisition time .1ms

Peak indication

Range	Resolution	Accuracy	Overload protection
20V~80V	0.1V	$\pm(10\% + 10)$	600Vrms
80V~600V	0.1V	$\pm(6\% + 10)$	600Vrms

Peak detect acquisition time .1ms

Audible continuity

Range	Continuity beeper	Open circuit voltage	Overload protection
	< 50 Ω	3.2V	600Vrms

Resistance (Ω)

Range	Resolution	Accuracy	Open circuit voltage	Overload protection
10K Ω	1 Ω	$\pm(1\% + 5)$	3.2 V	600Vrms

Diode test

Range	Resolution	Overload protection
	0.001V	600Vrms

Frequency (Hz)

Range	Resolution	Accuracy	Voltage sensitivity	Overload protection
1KHz	0.1Hz	$\pm(0.5\% + 5)$	10V or 10A	600V / 1100A
5KHz	10 Hz			

Safety Information

1. Read the following safety information carefully before attempting to operate or service the meter.
2. Read all operating instructions before use.
3. To avoid damage to the instrument do not exceed the published input limits.
4. Do not use the meter or test leads if they appear damaged. Use extreme caution when working around bare conductors or bus bars. Accidental contact with a conductor could result in electric shock.
5. Use the meter only as specified in this manual otherwise the protection provided by the meter may be impaired.
6. Use caution when working with voltages above 60VDC or 30VAC RMS. Such voltages pose a shock hazard.
7. Before taking resistance or continuity measurements, disconnect the circuit from the main power supply and disconnect all loads from the circuit.
8. Safety Specifications:
 - Installation categories III
 - Pollution degree 2
 - Altitude: 2000m max
 - Indoor use only

Safety symbols



Caution: Refer to this manual before using the meter.



Dangerous voltages.



Meter is protected throughout by double insulation or reinforced insulation.
When servicing, use only specified replacement parts.



Complies with EN-61010-1, IEC 1010-2-32

Meter Description

- | | |
|---------------------------------|------------------------------|
| 1. Transformer jaws | 9. LCD display |
| 2. Jaw trigger | 10. RS-232 PC Interface Jack |
| 3. Data Hold button | 11. COM terminal |
| 4. Function selector | 12. VΩHz terminal |
| 5. Peak Detector READ button | 13. Low battery indication |
| 6. MIN/MAX/PEAK function button | 14. Analog Display |
| 7. DC A/W ZERO button | 15. Bargraph Display |
| 8. RECORD button | 16. Units Symbols |

Figure 1

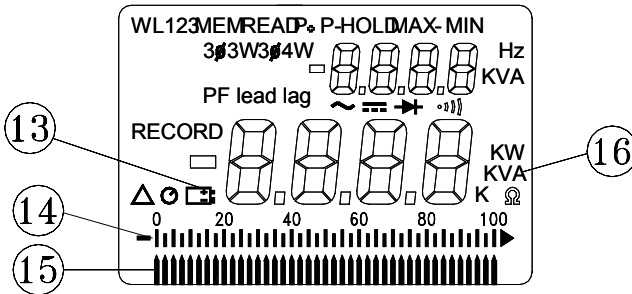
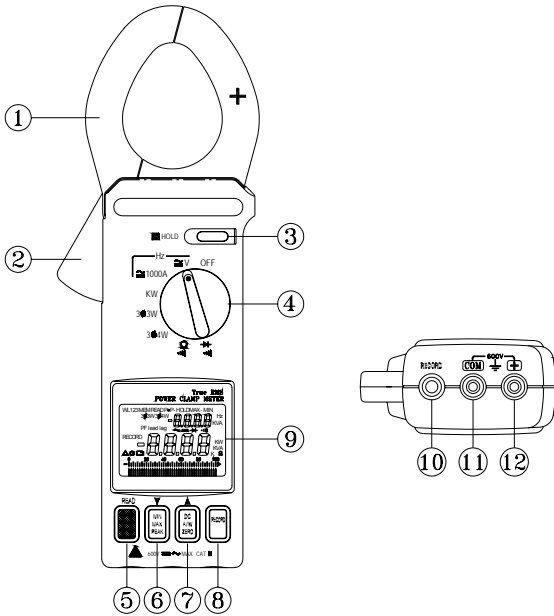

Figure 2

AC/DC Power Measurements

AC/DC 1 ϕ 2W Power (W) and Power Factor (PF) Measurements

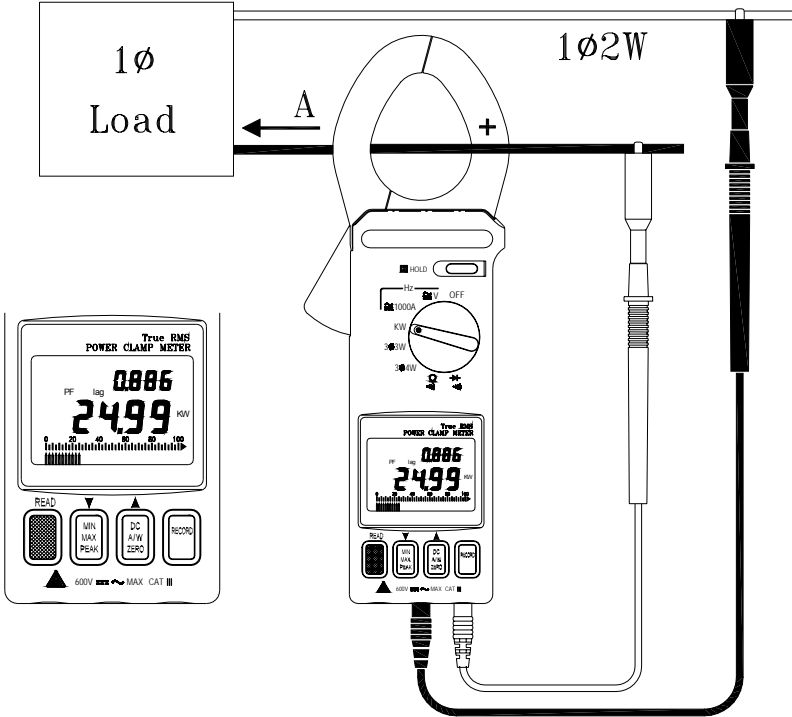

Figure 3

WARNING

Do not clamp on to a conductor when zeroing the jaw's residual magnetic field until the LCD reads zero.

1. With the clamp jaws empty, turn the clamp meter on by setting the rotary switch to the KW position (refer to figure 3).
2. Insert the test leads into the input terminals (black lead to COM and red lead to '+').
3. Connect the probe end of the black test lead to the neutral line.
4. Connect the probe end of the red lead to the power line.
5. Clamp the meter onto the conductor where the red test lead is connected.
6. The power clamp will automatically select the appropriate range.
7. Read the Watt (middle of display) and PF (top display) values on the LCD.
8. Press the READ button to scroll through the dual displays of KW + PF, A + V, and KVA + PF.

Note: When calculating KVAR, the KVAR accuracy greatly depends on V, A and KW measurement accuracy (especially when PF is very close to 1). To get a more accurate value when PF is greater than 0.91 ($\phi < 25^\circ$), use the following equation for a pure sine wave

$$PF = \frac{KW}{KVA}$$

$$KVA \text{ (Apparent Power): } KVA = \frac{V * A}{1000}$$

$$KVAR \text{ (Reactive Power): } KVAR = \sqrt{(KVA)^2 - (KW)^2}$$

Note: The "+" sign printed on the jaw must face the power source.

3 ϕ 3W AC/DC Power Measurement

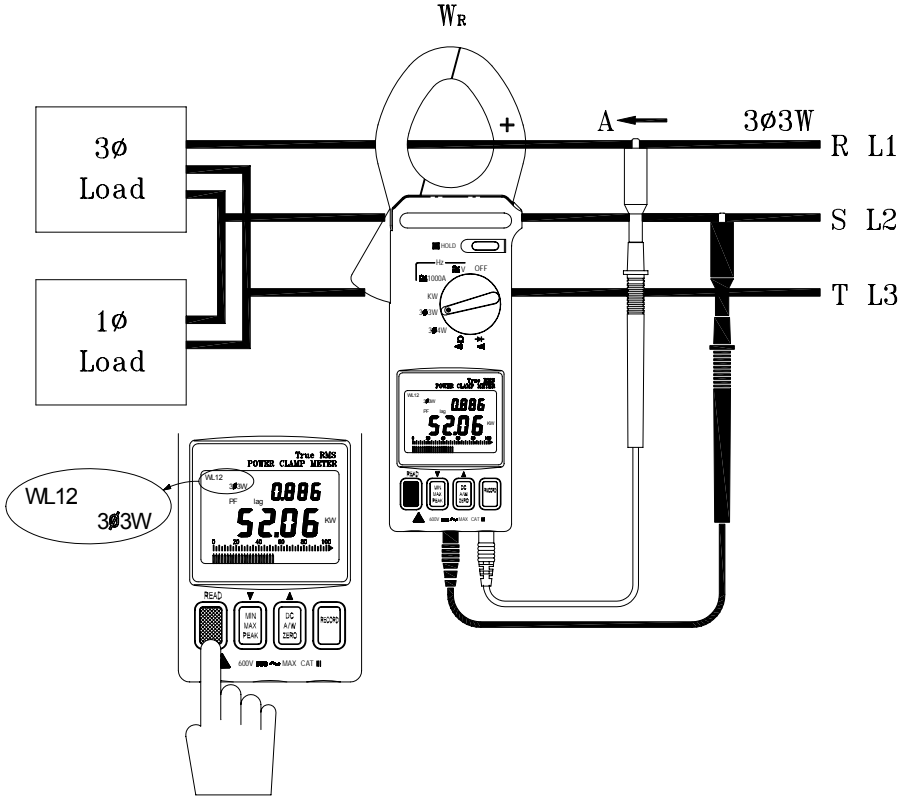

Figure 4

A. With the Clamp jaws empty, turn the meter on by setting the rotary switch to the 3 ϕ 3W position. **WL12** will appear on the upper left side of the LCD prompting the user to take a $W_{RS(L2L1)}$ measurement.

1. Insert the test leads into the input terminals (black to COM terminal and red to '+').
2. Select one phase (eg. S or L2) as COM and connect the probe end of the black lead to that phase (eg. S or L2).
3. Connect the probe end of the red test lead to the second phase (eg. R or L1).
4. Clamp the meter onto the same phase as the red test lead (eg. R or L1).
5. The meter will automatically select the proper range.
6. Wait until the reading is stable (about 6 seconds), and then press the READ button. **WL23** will appear prompting the user to take a measurement of $W_{TS}(W_{L3L2})$.

B. Measure $W_{TS}(L3L2)$ (refer to figure 5).

1. Disconnect the red test lead from the phase where the clamp is connected.
2. Connect the red test lead to the third phase (eg. T or L3).
3. Clamp onto the third phase (where the red test lead is connected; eg. T or L3).
4. The meter will automatically select the proper range.
5. Wait until the reading is stable (about 6 seconds) and then press the READ button.

C. The power clamp will process these measurements and display the result.

WL123 appears in the upper left corner of the LCD and the 3 ϕ 3W power measurement is displayed in watts (this value is now stored in meter memory). The following equations are provided for your information.

$$W_{3\phi 3W} = W_{RS(L1L2)} + W_{TS(L3L2)}$$

$$KVA_{3\phi 3W} = \sqrt{KW^2_{3\phi 3W} + KVAR^2_{3\phi 3W}}$$

$$PF_{3\phi 3W} = \frac{KW_{3\phi 3W}}{KVA_{3\phi 3W}}$$

Notes:

1. Once a phase is designated as common (COM) it should remain as such in all subsequent measurements. For example, if the S (or L2) phase is selected, S (or L2) phase is connected to COM during the measurements of W_{RS} (or W_{L1L2}) and W_{TS} (or W_{L3L2}) in 3 ϕ 3W unbalanced power.
2. The "+" sign printed on the jaw must face the power source.
3. In 3 ϕ 3W unbalanced power measurements, if either W_{RS} or W_{TS} is negative (connection error) ensure that all test lead and clamp connections are correct.

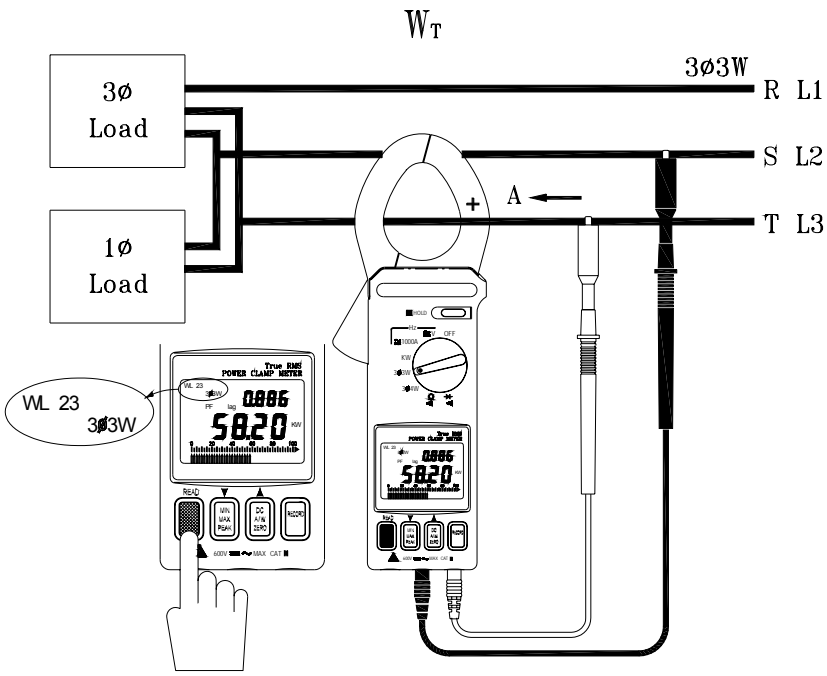

Figure 5

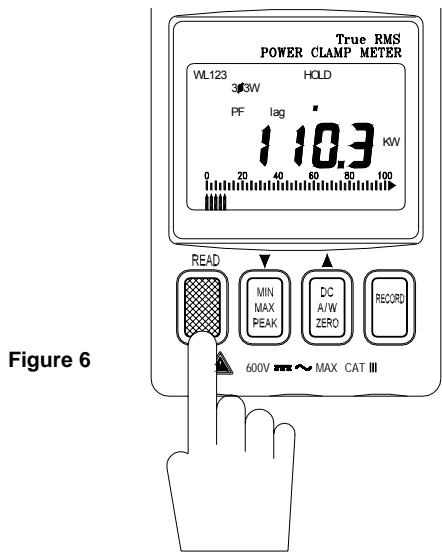

Figure 6

3 ϕ 4W AC/DC Power Measurement

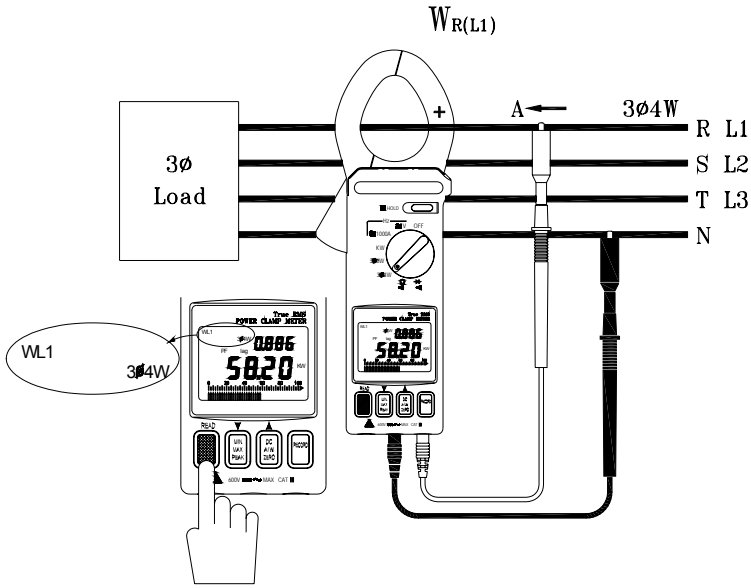

Figure 7

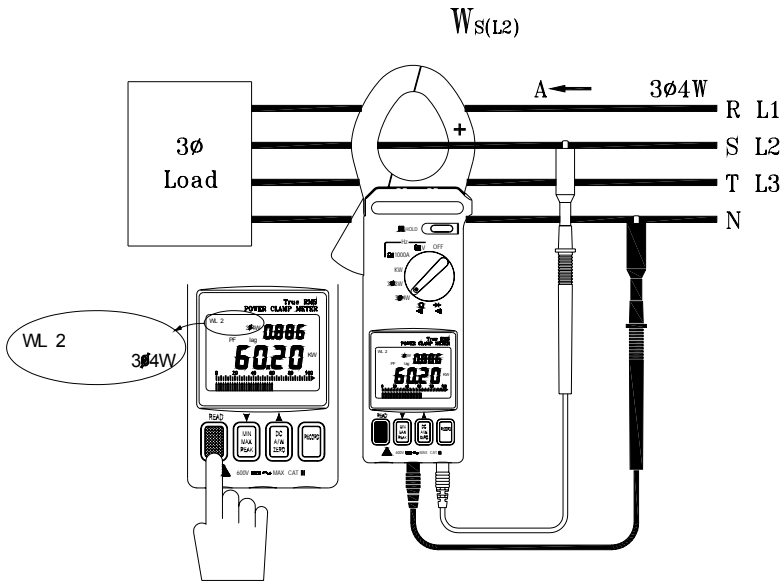

Figure 8

$W_{T(L3)}$

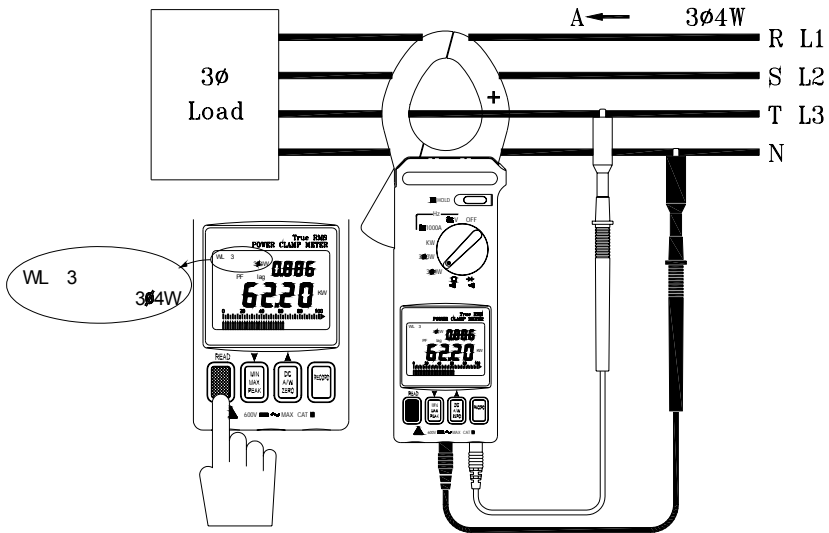

Figure 9

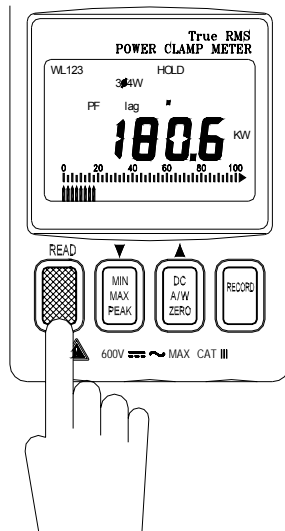

Figure 10

A. Measure $W_{R(L1)} / P_{FR(L1)}$ (refer to figure 6).

1. With the jaw enclosure empty, turn the meter on by setting the rotary switch to the 3 ϕ 4W position.
2. Insert the test leads into the input terminals (black lead to the COM terminal and red to '+').
3. Connect the black lead's probe end to the neutral line.
4. Connect the red lead's probe end to the first phase (eg. R or L1).
5. Clamp on to the same phase as the red test lead (eg. R or L1).
6. The meter will automatically select the proper range.
7. Wait until the reading is stable (about 6 seconds) then press the READ button. **WL1** will disappear and **WL2** will appear prompting the user to take a $W_{S(L2)} / P_{FS(L2)}$ measurement.

B. Measure $W_{S(L2)} / P_{FS(L2)}$ (refer to figure 7)

1. Disconnect the red test lead from the phase where the jaws are clamped.
2. Connect the red test lead to the second phase (eg. S or L2).
3. Clamp onto the phase where the red test lead is connected (eg. S or L2 phase)
4. The meter will automatically select the proper range.
5. Wait until the reading is stable (about 6 seconds) then press the READ button. **WL2** will disappear and **WL3** will appear prompting the user to take a $W_{T(L3)} / P_{FT(L3)}$ measurement.

C. Measure $W_{T(L3)} / P_{FT(L3)}$ (refer to figure 8)

1. Disconnect the red test lead from the phase where the meter's jaws are clamped.
2. Connect the red test lead to the third phase (eg. T or L3 phase).
3. Clamp onto the phase where the red test lead is now connected (eg. T or L3).
4. The meter will automatically select the proper range.
5. Wait until the reading is stable (about 6 seconds) and then press the READ button. **WL3** will disappear from the upper left hand area of the LCD.
6. The meter will process these three sets of data (refer to figure 9) and display the 3 ϕ 4W power measurement (**WL123** will be displayed). The 3 ϕ 4W measurement will then be stored in memory. The following equations are provided for your information.

$$W_{3\phi 4W} = W_{R(L1)} + W_{S(L2)} + W_{T(L3)}$$

$$KVA_{3\phi 4W} = \sqrt{KW_{3\phi 4W}^2 + KVAR_{3\phi 4W}^2}$$

$$PF_{3\phi 4W} = \frac{KW_{3\phi 4W}}{KVA_{3\phi 4W}}$$

Notes:

1. The "+" sign printed on jaw must face the power source.
2. For 3 ϕ 4W power measurements, WR or WS and WT must be positive. If any are negative, check the test lead and clamp connections for polarity errors.

1 ϕ 3W Power Measurement

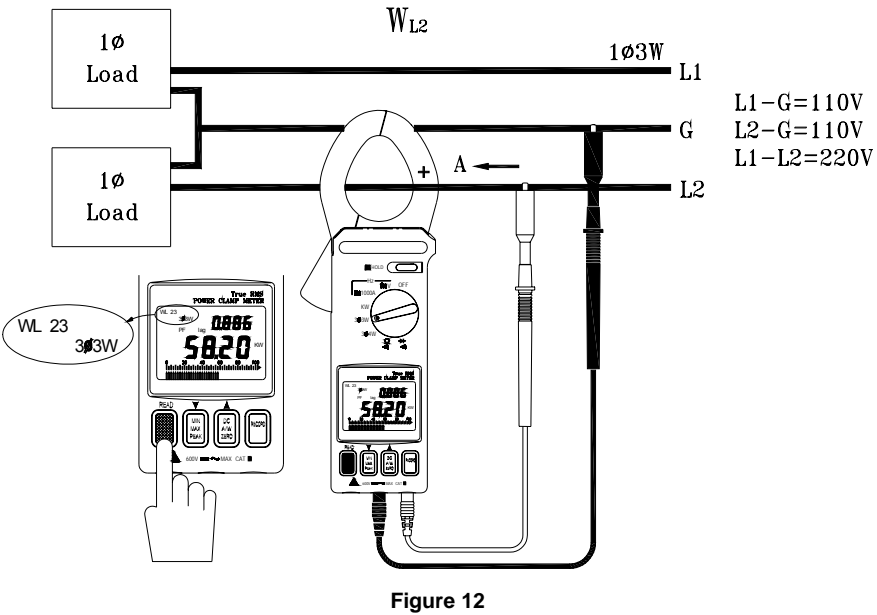
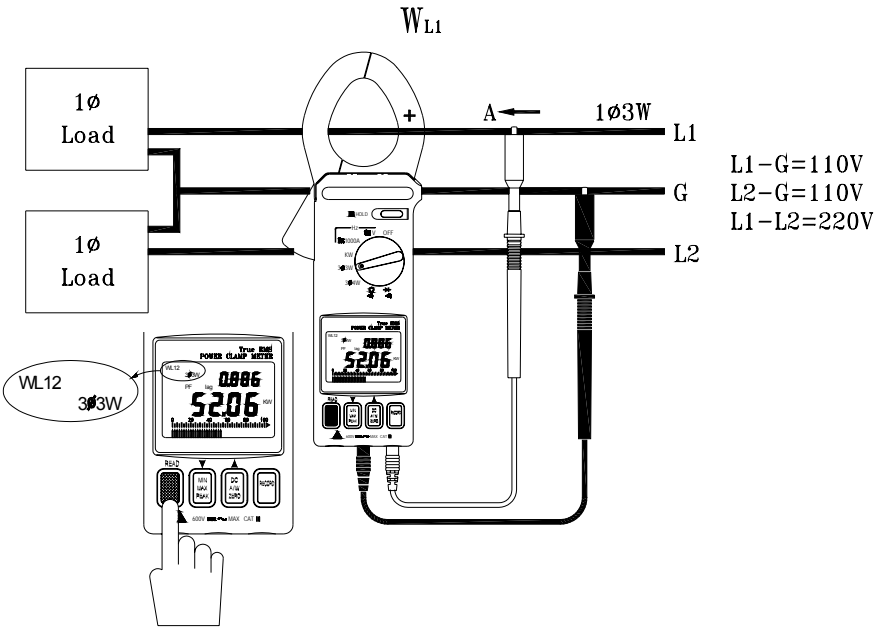

1 ϕ 3W power measurements are similar to 3 ϕ 3W unbalanced power measurement except for the nomenclature. Two measurements are required: $W_{RS(L1G)}$ and $W_{TS(L2G)}$.

A. Measure $W_{RS(L1G)}$ (refer to figure 11).

1. With the Clamp jaws empty, turn the meter on by setting the rotary switch to the 3 ϕ 3W position.
2. Insert the test leads into the input terminals.
3. Connect the probe end of the black lead to ground.
4. Connect the probe end of the red lead to the second phase (eg. L1).
5. Clamp onto the second phase (eg. L1).
6. The meter will automatically select the proper range.
7. Wait until the reading is stable (about 6 seconds) and then press the READ button.
8. **WL23** will appear prompting the user to take the $W_{TS(L2G)}$ measurement.

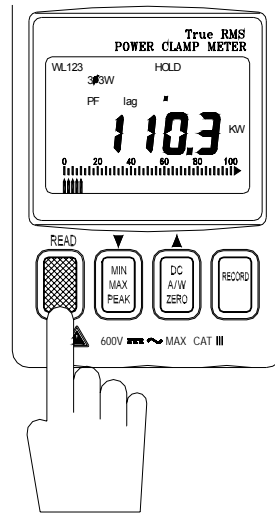

Figure 13

B. Measure W_{TS} or W_{L2G} (refer to figure 12).

1. Disconnect the red test lead from the phase where the jaws are clamped.
2. Connect the red test lead to the L2 line.
3. Clamp onto the L2 line (where the red test lead is connected).
4. The meter will automatically select the proper range.
5. Wait until the reading is stable (about 6 seconds) and then press the READ button.

C. The power clamp sums the two values, displays the result, and stores the 1 ϕ 3W power measurement in memory. Note the following equation:

$$W_{1\phi 3W} = W_{RST} = W_{RS(L1G)} + W_{TS(L2G)}$$

Current and Voltage Measurements

AC, DC, and AC+DC Voltage Measurements

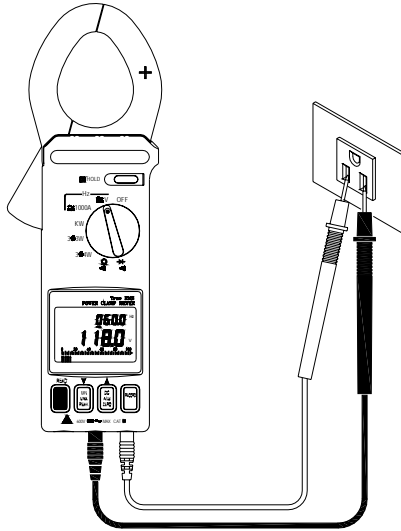

Figure 14

Warning: The maximum input is 600V. Do not attempt to take voltage measurements that exceed this limit; electrical shock and damage to the clamp meter can result.

1. Set the rotary switch to the 'V' position (refer to figure 14).
2. Insert the test leads into the input terminals (black lead to COM and red to '+').
3. Connect the probe ends of the test leads in PARALLEL to the circuit to be measured.
4. The meter will automatically select the appropriate range and units (AC or DC).
5. Read the voltage and frequency values displayed on the LCD.

Note: The sensitivity for frequency measurements is 10V. The frequency range is 45 – 500Hz. If the frequency is less than 45 Hz, the LCD will display "-----".

AC, DC, and AC+DC Current Measurements

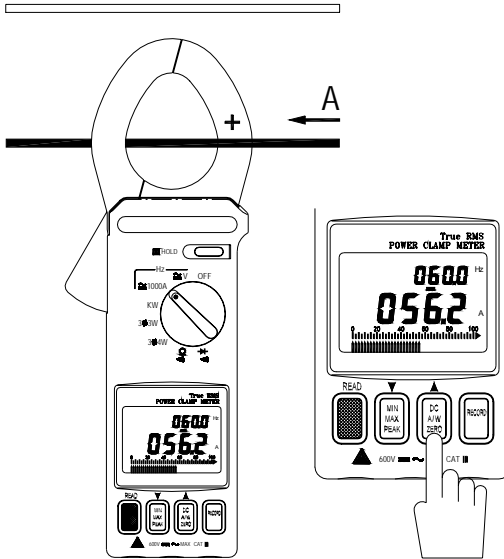

Figure 15

1. Set the rotary switch to the '1000A' position (refer to figure 15).
2. For DC, press and hold the ZERO button until a beep is heard to zero the reading; the LCD will display "- - -" while zeroing.
3. Press the trigger to open the jaw.
4. Fully enclose the conductor to be measured. Do not allow a gap between the two jaw halves when measuring.
5. The clamp will automatically select the appropriate range.
6. Read the current and frequency values displayed on the LCD.

Note: The current sensitivity for frequency measurements is 10A. The frequency range is 45 - 500Hz. If the frequency is less than 45 Hz, the LCD will display "- - - - -"

Resistance and Continuity Measurements

Warning: Before taking any in-circuit resistance measurements, remove power from the circuit under test and discharge all capacitors.

1. Set the function switch to the Ω position for both resistance and continuity measurements.
2. Connect the black test lead to the COM terminal and the red test lead to the '+' terminal.
3. Connect the test leads to the circuit being measured and read the displayed resistance value. Refer to Figure 16.
4. For Continuity measurements, an audible tone will sound when the reading is below 50Ω .

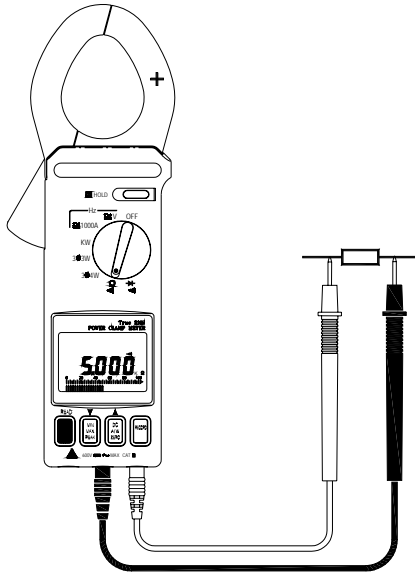



Figure 16

Diode and Continuity Measurements

1. Connect red test lead to the " + " terminal and black test lead to the "COM" terminal.
2. Set the range switch to the diode test position "  ".
3. Connect the red test lead to the anode side and black test lead to the cathode side of the diode being tested.
4. Read the forward voltage value on LCD. The value for a good diode is 0.3VDC for germanium diodes and 0.7VDC for silicon diodes.
5. If the test lead connection is reversed, the digital reading should reflect an open circuit condition if the diode is good.
6. Continuity measurement: When the reading is below 50mV an audible tone will sound.

MIN/MAX Recording

1. Set the Function Switch to the Voltage or Current position.
2. To record and view MIN and MAX values while taking measurements, press the MIN MAX button.
3. Now while measurements are being taken, the display only the MIN or the MAX reading. Use the MIN MAX button to toggle between MIN and MAX readings. The LCD will display MIN or MAX as selected.
4. To exit this mode, press and hold the MIN MAX button until the MIN and MAX display icons disappear from the LCD.

Peak Detection

Peak Detect mode is used to capture fast transients signals (to 0.1ms) such as those caused by motor startup surges or arc welding equipment switching.

1. Set the Function Switch to the Current or Voltage position.
2. Engage the Peak detector by pressing and holding the READ button until a short beep is heard. (Note that if the button is held longer, a longer beep will sound and the meter will be in the datalogging view mode; refer to the datalogging section for more info).
3. The LCD will display 'P-P+' when the Peak Detect mode is accessed correctly. Use the PEAK button to toggle between ' P+ Max' (captures positive polarity peaks) and 'P-MIN' (captures negative polarity peaks).
4. To exit the Peak mode, press and hold the PEAK button for two seconds (until the P- and P+ icons disappear).
5. Take a Voltage or Current measurement on a transient signal and the display will show the peak of the pulse. The fastest surge the meter can detect is 0.1ms.

Data Hold

1. To freeze a displayed reading, press the HOLD key.
2. The HOLD icon will appear on the top of the LCD to let the user know that the meter is in the Data Hold mode.
3. To return the meter to the normal operation mode, press the HOLD key again. The HOLD icon will extinguish.

Datalogging

Single mode

1. Single mode datalogging records one reading at a time.
2. To record one reading, press the RECORD key until one beep heard. (Note that if the button is held longer, 2 beeps will sound and the meter will be in continuous mode; see below). The record number (1 through 25 or FULL) will briefly appear on the LCD.
3. The meter can store up to 25 readings. When the memory is full, FULL will display.
4. To view the readings, press and hold the READ button until two tones are heard. The second tone is longer and louder than the first.
5. Now use the yellow ▲ and ▼ keys to scroll through the recorded readings.

Continuous mode (for use with PC interface only)

1. In continuous mode the meter records one reading after another automatically. Up to 4000 records can be recorded.
2. Press and hold the RECORD until two tones are heard (not available in 3 ϕ 3W and 3 ϕ 4W function positions). The meter will begin recording data and the RECORD icon will appear on the LCD.
3. To exit the Record mode, press and hold the RECORD button until the RECORD display icon disappears.
4. Readings can only be transferred to a PC with optional Windows® software and interface cable. Instructions for use are provided with optional software/hardware kit.

Clearing Datalog Data

1. Turn the meter off and hold down the RECORD button while turning the meter on.
2. Release the RECORD key when CLR appears. The datalog memory is now clear.

Connecting the meter to a PC

The Model 382065 includes an attachment that affixes to the bottom of the meter via its banana jacks. The PC interface cable is hardwired to this attachment. Connect the other end (DB-9) of the cable to an available PC com port.

Operation

Software Setup

1. Start Windows® and close all applications.
2. Insert the supplied program disk in the CD-ROM drive.
3. The Setup program will run automatically.

Starting the Clamp Meter Software

1. Click the Windows® START button.
2. Select PROGRAMS.
3. Select CLAMPMETER.
4. Double click the CLAMPMETER icon.
5. Click on the appropriate COM port when prompted.
6. The Main Software Screen will appear (see below).



Main Software Screen

1. GRAPH button – Press to view real-time data in x-y plot format.
2. LIST button – View data in list format as it's recorded.
3. TIME SET button – Press to allow the PC system time to be used by the meter (reflected in the TIME window - item 8)
4. MEMORY button – Open Memory window (see subsequent section).
5. Meter Remote Display
6. Sampling Rate – The rate at which data is recorded while the meter is connected to the PC.
7. OPEN FILE button – Open a previously saved data file.
8. TIME – Shows the time from item 3 above.
9. SAVE AS – Click to open new data file in which to record.
10. Communication Status – COM1 or COM2 will display when connection is good. NO COM will appear if communication is faulty.

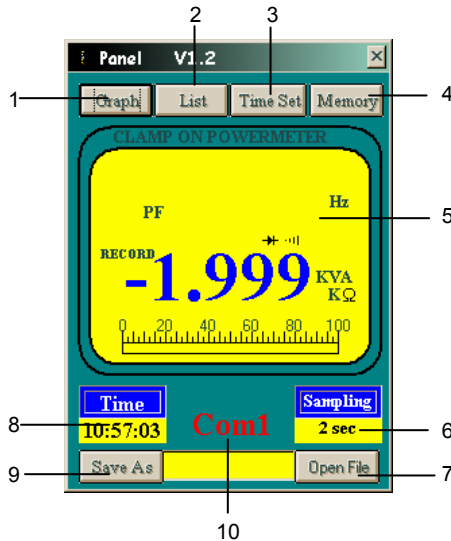

Memory Window

1. REMAIN – Meter's available memory.
2. ID Code – User selectable reference number. Type number in the yellow field below the ID CODE button then press the ID CODE button to confirm.
3. MEMORY – Total meter memory (amount of memory available when no readings are stored in the logger).
4. REAL TIME CLOCK – Click on this bar to display the PC system clock in the field below the REAL TIME CLOCK button.
5. List of downloaded data sets: Recording time shows the date and time of data recording, FUNC1 and FUNC2 show the measurement types for the recorded data, and Records indicates how many readings are in the set.
6. Download status.
7. Sampling – Datalogger Sample rate (rate at which meter will record readings remotely). With the meter connected, click in the yellow field below the SAMPLING button and type in the desired sampling rate. Click the Sampling button to confirm.

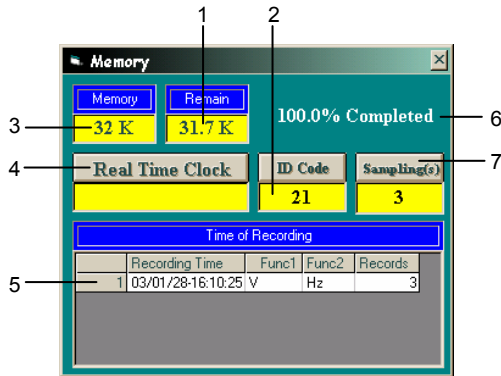

NOTE: This differs from the Sampling rate in the Main Software screen. The Sampling rate in the Main Software window is the rate that the PC records the measurements made by the meter while connected to the PC (this is known as data acquisition).

Measuring and recording readings with meter connected to PC

1. With the meter connected to the PC and with the meter and the program running, click the SAVE AS button on the Main Software window.
2. Type a filename when prompted and click OK.
3. The filename will appear on the Main Software window and the computer will begin storing the meter readings in real time to the file named in above step.
4. The Main Software window will display the meter readings and the number of records recorded.
5. To change the rate at which the readings are taken, click on the yellow field below the SAMPLING button. Type in the desired sample rate when prompted.
6. Click STOP RECORDING button on the Main Software button when desired. The data will remain in the file named earlier. Open the file at a later time using the OPEN FILE button on the Main Software window.

Remotely datalog readings with the clamp meter

1. Press and hold the RECORD button on the meter until the audible tone beeps twice.
2. The meter will begin recording at the rate programmed in the MEMORY window (not the Main Software window).
3. The RECORD display icon will switch on during the recording session.
4. Press and hold the RECORD button until one audible tone beeps to stop recording. The RECORD display icon will switch off.

Transfer (Download) remotely recorded readings to a PC

1. Connect the meter to the PC, open the software program, and turn the meter on.
2. Open the Memory window by clicking on the MEMORY button in the Main Software window.
3. All of the sets contained within the clamp meter datalogger will be transferred to the PC at this time.
4. All of the sets will be listed in the Memory window. In the example Memory window above, there is one set with 3 records (readings).
5. Double click on a set to open the data file. At that point the data can be printed, saved, plotted, and viewed using the menu selection in the data window.

Import a stored data file in a spreadsheet

1. Open the spreadsheet program, select OPEN FILE from the FILE menu.
2. From the FILES OF TYPE in the OPEN window, choose ALL FILES from the pull-down menu.
3. Located and select the desired file.
4. The Text Import Wizard will appear.
5. Click on the FINISH button in the Text Import Window.

Wiring and Protocol

Wiring

In order to ignore hardware handshake, the wiring should be configured as shown in the diagram below (left). The RTS must be pulled low (-10V to -12V). Note: In QBASIC, add RS in the OPEN statement. The diagram at right is the DB-9 connector schematic.

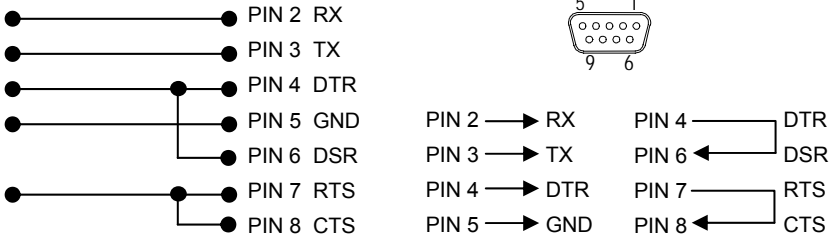

NOTE: For some computers, a 9-pin (male) to 25-pin (female) adapter is required. The wiring for such an adapter is shown below:

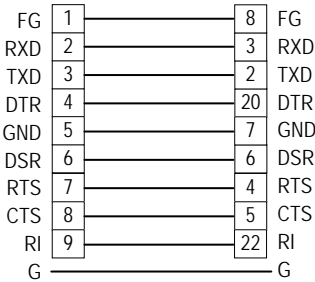

Clamp Meter PC Interface activation

No action required. Once connected to a PC, the meter is ready to communicate.

Datalogging activation

To start recording, press the clamp meter's RECORD button (RECORD appears on the LCD). To stop recording, press the RECORD button again (RECORD icon switches off).

Default RS-232 Settings

Baud Rate: 9600; Stop bit: 1; Data bits: 8; Parity: None

Communicating with the Clamp Meter

To request data from the Clamp Meter, send a SPACE character to the Clamp meter from the PC (the ASCII code for the SPACE bar is 20 hex). Having received a character, the meter will send a 9 byte string. Refer to the following sections.

Decoding the 9 Data Bytes

Each byte of the 9 byte string contains specific information and is used for a specific purpose. The information contained in the 9 byte string is shown in the following table:

Byte 1	Byte 2	Byte 3	Byte 4	Byte 5	Byte 6	Byte 7	Byte 8	Byte 9
02	Function	Lower LCD		Upper LCD		Status1	Status 2	03

Byte 1

This byte is fixed. If its value is not 02, the interface is compromised or the meter is defective.

Byte 2

The 7 bits in Byte 2 represent the meter's selected mode of operation (its function).

Bit 7	Bit 6	Bit 5	Bit 4	Bit 3	Bit 2	Bit 1	Bit 0
X	Volts	Amps	Kilowatt	3 phase / 3 wire	3 phase / 4 wire	Resistance	Diode

Bytes 3, 4, 5, and 6

Bytes 3 & 4 represent the lower LCD display reading in hex. Bytes 5 & 6 represent the meter's upper LCD reading in hex (for an 'E0' 'DE' value for bytes 3 through 6 the meter is in OVERLOAD condition, meaning that the measurement it is taking is out of range).

Byte 7

Byte 7 is the 'Status 1' byte representing the state of the LCD display indicators.

Bit 7	Bit 6	Bit 5	Bit 4	Bit 3	Bit 2	Bit 1	Bit 0
Bit (low battery)	Minus sign for lower LCD display	Record	Max	Min	Hold	00 → PF/KW 01 → V/A 10 → PF/KVA	

Byte 8

Byte 8 is the 'Status 2' byte representing the state of the LCD display indicators.

Bit 7	Bit 6	Bit 5	Bit 4	Bit 3	Bit 2	Bit 1	Bit 0
n/a	P-	P+	Minus sign for upper LCD display	Upper decimal (refer to bit 2 → for selection)	00 = 10 ⁰ 01 = 10 ⁻¹ 10 = 10 ⁻² 11 = 10 ⁻³	Upper decimal (refer to bit 0 → for selection)	00 = 10 ⁰ 01 = 10 ⁻¹ 10 = 10 ⁻² 11 = 10 ⁻³

Byte 9

End byte is fixed (03).

Commands

"D" + Year + Month + Date + Hour + Minute + Second
(1 Byte + 1 Byte + 1 Byte + 1 Byte + 1 Byte + 1 Byte + 1 Byte)
Function: Programs the meter's clock

"Y" (1 Byte)
Function: Load the number of Recorded Sets + Last Address + Sampling + ID Code
(1 Byte + 2 Bytes + 1 Byte + 1 Byte)

"U" (1 Byte)
Function: Download Recorded Data
00 55 AA 00 + First Recorded Set + 00 55 AA 00 + Second Recorded Set +...

Each set contains: Time + Function + Down LCD + Up LCD + Status1 + Status2 +...
(6 Bytes + 1 Byte + 1 Byte + 2 Byte + 1 Byte + 1 Byte + 1 Byte)

Maintenance

Battery Replacement

Warning: To prevent electrical hazard or shock, turn off the clamp meter and disconnect the test leads before removing the back cover.

When the 9V battery expires, the LCD will display the battery icon. To replace the battery:

1. Set the Range switch to the OFF position.
2. Remove the meter's three rear screws and carefully open the meter housing.
3. Replace the 9V battery and re-assemble the meter housing.

Cleaning

Periodically wipe the case with a dry cloth; do not use abrasives or solvents.

Warranty

EXTECH INSTRUMENTS CORPORATION warrants this instrument to be free of defects in parts and workmanship for **one year** from date of shipment (a six month limited warranty applies to sensors and cables). If it should become necessary to return the instrument for service during or beyond the warranty period, contact the Customer Service Department at (781) 890-7440 ext. 210 for authorization or visit our website www.extech.com for contact information. A Return Authorization (RA) number must be issued before any product is returned to Extech. The sender is responsible for shipping charges, freight, insurance and proper packaging to prevent damage in transit. This warranty does not apply to defects resulting from action of the user such as misuse, improper wiring, operation outside of specification, improper maintenance or repair, or unauthorized modification. Extech specifically disclaims any implied warranties or merchantability or fitness for a specific purpose and will not be liable for any direct, indirect, incidental or consequential damages. Extech's total liability is limited to repair or replacement of the product. The warranty set forth above is inclusive and no other warranty, whether written or oral, is expressed or implied.

Calibration and Repair Services

Extech offers repair and calibration services for the products we sell. Extech also provides NIST certification for most products. Call the Customer Service Department for information on calibration services available for this product. Extech recommends that annual calibrations be performed to verify meter performance and accuracy.



Support line (781) 890-7440

Technical support: Extension 200; E-mail: support@extech.com

Repair & Returns: Extension 210; E-mail: repair@extech.com

Product specifications subject to change without notice

For the latest version of this User's Guide, Software updates, and other up-to-the-minute product information, visit our website: www.extech.com
Extech Instruments Corporation, 285 Bear Hill Rd., Waltham, MA 02451

Copyright © 2005 Extech Instruments Corporation

All rights reserved including the right of reproduction in whole or in part in any form.