

190501 Velomitor CT Transducer

Datasheet

Bently Nevada Machinery Condition Monitoring

141636 Rev. AC



Description

The Velomitor CT Velocity Transducer is a low-frequency version of our standard Velomitor Piezo-velocity Sensor. Its design specifically measures casing vibration velocity on cooling tower and air-cooled heat-exchanger fan assemblies that operate at or above 90 rpm (100 to 300 rpm typical).

The Velomitor CT Transducer can measure vibration amplitudes at these frequencies as well as the vibration frequencies generated by the fan motor and speed reducer.



If you are measuring a machine housing to determine where to install transducers, consider what kinds of data you need to obtain. Most common machine malfunctions (imbalance, misalignment, and so forth) originate at the rotor and cause a change in rotor vibration. The location you select on the housing must accurately conduct rotor vibration to the transducer.

Install the transducer carefully. If you don't, the transducer may not accurately detect vibrations and can transmit invalid data. Bently Nevada provides engineering services to accurately measure machine housings and to install transducers.



Specifications

Parameters are specified from +20 °C to +30 °C (+68 °F to +86 °F) and 100 Hz unless otherwise indicated.

 Operating the transducer outside the specified limits will result in false readings or loss of machine monitoring.

Electrical

Sensitivity	3.94 mV/mm/s (100 mV/in/s) ±5%.
Frequency Response	3.0 Hz to 900 Hz (180 to 54,000 cpm) ±1.0 dB 1.5 Hz to 1.0 kHz (90 to 60,000 cpm) ±3.0 dB
Temperature Sensitivity	-8% to +5% typical over the operating temperature range.
Velocity Range	63.5 mm/s pk (2.5 in/s pk) see Operating Range for Metric Units on page 14. See Operating Range for English Units on page 15. Vibration components in excess of 10g pk above 1 kHz can significantly reduce this range.
Transverse Response	Less than 5% of the axial sensitivity.
Amplitude Linearity	±2% to 63.5 mm/s pk (2.5 in/s pk)
Mounted Resonant Frequency	9 kHz, minimum (stud mounted, except quick disconnect)
Output Bias Voltage	10.1 Vdc ± 1.0 Vdc, Pin A referenced to Pin B
Dynamic Output Impedance	<400 Ω typical
Broadband Noise Floor (1.5 Hz to 1	0.229 mm/s (0.009 in/s) pk. For more information, see

kHz)	Typical Low Frequency Noise Floor on page 16.
Base Strain Sensitivity	0.43 mm/s/μstrain (0.017 in/s/μstrain).
Grounding	Internal electronics are isolated from case.
Maximum Cable Length	305 metres (1,000 ft.) of cable (part number 02173006) with no degradation of signal.

 Maximum continuous length of cable available is 91.44 metres (300 ft.) If longer lengths are required they must be spliced or have a connector installed on them.

Environmental Limits

Operating Temperature	-40 °C to +85 °C (-40 °F to +185 °F).
Storage Temperature	-40 °C to +100 °C (-40 °F to +212 °F).
Shock Limit	5000 g pk, maximum.
Humidity Limit	100% condensing, non-submerged.
Magnetic Field Susceptibility	<0.0068 mm/s/gauss (0.268 mil/s/gauss) @ 50 gauss, 50-60Hz

Mechanical

Weight	<297 g (10.5 oz.), typical.
Mounting Surface	33 mm diameter (1.3 in diameter).
Height	82 mm (3.2 in).
Case Material	316L stainless steel
Connector	2-pin 316L stainless steel MIL-C-5015, top.
Mounting Torque	4.5 N-m \pm 0.6 N-m (40 in-lbf \pm 5 in-lbf).
Polarity	Pin A goes positive with respect to Pin B when velocity is from base to top of the transducer.
Mounting Angle	Any orientation.

For more information on this product, please refer to the Velomitor CT Piezo-Velocity Transducer User Guide (document 125389).

Compliance and Certifications

FCC

This device complies with part 15 of the FCC Rules. Operation is subject to the following two conditions:

- This device may not cause harmful interference.
- This device must accept any interference received, including interference that may cause undesired operation.

EMC

EMC Directive 2014/30/EU

RoHS

RoHS Directive 2011/65/EU

Maritime

330400 and 330425 only

ABS 2009 Steel Vessels Rules

1-1-4/7.7,4-8-3/1.11.1,4-9-7/13

Hazardous Area Approvals



For the detailed listing of country and product specific approvals, refer to the *Approvals Quick Reference Guide* (108M1756) available from Bently.com.

CSA/NRTL/C

190501 (Agency Approval Options 01 through 04)





Intrinsically Safe	Ex ia IIC T4: Class I, Div 1, Groups A, B, C, D. Class II, Group E, F and G Class III AEx ia IIC T4:
--------------------	--

	Class I, Div 1, Groups A, B, C, D; Class II, Groups E, F, G Class III Install per drawing 167536 $T4 @ -40^{\circ}C \leq Ta \leq +100^{\circ}C$ $(-40^{\circ}F \leq Ta \leq +212^{\circ}F)$
Intrinsically Safe and Non-Incendive	Ex nL IIC T4 Class I, Division 2, Groups A, B, C and D AEx nA T4 Class I, Division 2, Groups A, B, C and D Install per drawing 167536 $T4 @ -40^{\circ}C \leq Ta \leq +100^{\circ}C$ $(-40^{\circ}F \leq Ta \leq +212^{\circ}F)$
330400, 330425	Ex ia IIC T4 AEx ia IIC T4 Class I, Div 1 Groups A, B, C and D Class II, Groups E, F, and G Class III $T4 @ -40^{\circ}C \leq Ta \leq 100^{\circ}C$ Install per dwg 167538
330500	Ex ia IIC T4 AEx ia IIC T4 Class I, Division 1, Groups A, B, C and D Class II, Groups E, F, G Class III Install per dwg 167537 $T4 @ -40^{\circ}C \leq Ta \leq 100^{\circ}C$ Ex nL IIC T4 AEx nA IIC T4 Class I, Div 2, Groups A, B, C, D Install per dwg 167537 $T4 @ -40^{\circ}C \leq Ta \leq 100^{\circ}C$
330525	Ex ia IIC T4 AEx ia IIC T4 Class I, Division 1, Groups A, B, C and D Class II, Groups E, F, G Class III $T4 @ -40^{\circ}C \leq Ta \leq 100^{\circ}C$

Ex nL IIC T4 AEx nA IIC T4 Class I, Div 2, Groups A, B, C, D Install per dwg 167539 T4 @ $-40^{\circ}\text{C} \leq T_a \leq 100^{\circ}\text{C}$	Ci-10.8nF	
	Li= 0	

ATEX/IECEx

190501, 330400, 330425, 330500, 330525

190501	 Ex II 1 G Ex ia IIC T4 Ga	
	 Ex II 3 D Ex na IIC T4 Gc Ex tc III T130°C Dc T4@ Ta = -55°C to 121°C	
	Zone 0/1	Zone 2
	Ui= 30V	Ui= 30V
	Ii= 200mA	Ii= 200mA
	Pi= 0.75W	Pi= 1.14W
	Ci=27.2nF	
Li= 0		
330400, 330425, 330500, 330525	 Ex II 1 G Ex ia IIC T4 Ga	
	 Ex II 3 D Ex na IIC T4 Gc Ex tc III T130°C Dc T4@ Ta = -55°C to 121°C	
	Zone 0/1	Zone 2
	Ui= 28V	Ui= 28V
	Ii= 150mA	Ii= 150mA
	Pi= 0.84W	Pi= 1.26W

Hazardous Area Conditions of Safe Use

ATEX/IECEX

Zone 0/1:

Equipment must be connected to equipment, which meets the abovelisted entity parameters.

The cables type A or B (in compliance with EN 60079-25) must respect the cable parameters listed with the entity parameters.

Zone 2 :

The supply electrical parameters shall not exceed the values mentioned in the tables above.

Ordering Information

Velomitor CT Velocity Transducer

190501 - AA - BB - CC

A: Mounting Hardware Option

0 0	No stud
0 1	Stud 3/8-in 24 to 3/8-in 24
0 2	Stud 3/8-in 24 to 1/2-in 20
0 3	Adhesive Stud 3/8-in 24
0 4	Stud M6x1 with 3/8-in 24 adapter
0 5	Adhesive Stud M6x1 with 3/8-24 adapter
0 6	Stud 3/8-in 24 to 1/4-in 28
0 7	Plate Stud 3/8-in 24 to 3/8-in 24
0 8	Plate Stud 3/8-in 24 to 1/2-in 20
0 9	Plate Stud 3/8-in 24 to 1/4-in NPT
1 0	Plate Stud M6x1 to M6x1with 3/8-in 24 adapter
1 1	Plate Stud 3/8-in 24 to 1/4-in 28
1 2	Plate Stud 3/8-in 24 to M8x1
1 3	Quick disconnect stud
1 4	Adapter, 3/8-in 24 to 1/4-in 20
1 5	Adapter, 3/8-in 24 to 5/16-in 18
1 6	Adapter, 3/8-in 24 to 3/8-in 24
1 7	Adapter, 3/8-in 24 to 3/8-in 16
1 8	Adapter, 3/8-in 24 to 1/2-in 13
1 9	Adapter, 3/8-in 24 to 1/4-in 18 NPT
2 0	Adapter, 3/8-in 24 to 3/8-in 18 NPT
2 1	Adapter, 3/8-in 24 to 1/2-in 14

	NPT
2 2	Adapter, 3/8-in 24 to 3/4-in 14 NPT
2 3	Adapter, 3/8-in 24 to 1.0-in 11.5 NPT
2 4	Adapter, 3/8-in 24 to 1.25-in 11.5 NPT

B: Connection Option

0 0	MIL-C-5015 connection interface
9 9	Unit with included 32-foot cable

C: Agency Approval Option

0 0	No Approvals
0 1 through 0 4	CSA/NRTL/C (Class I, Division 1), ATEX/IECEX/CSA (Class I, Zone 0/1)

Interconnect Cable

CB2W100 - AAA

Description: Connectors: MIL-C 5015, 2 Socket, Splash Proof, Premium, isolated to blunt cut, Cable: 20 AWG, twisted pair, shielded, yellow Teflon jacket. LOCKING RING, ADAPTER SEAL, AND O-RING ARE INCLUDED.

A: Length

0 1 5	15 feet (4.57 metres)
0 3 2	32 feet (9.75 metres)
0 6 4	64 feet (19.5 metres)
1 1 2	112 feet (34.1 metres)
1 2 5	125 feet (38.1 metres)
1 5 0	150 feet (45.7 metres)
2 0 0	200 feet (61.0 metres)
2 5 0	250 feet (76.2 metres)

Accessories

128608-02	1/2-in NPT conduit adapter
04284020-01	Adhesive mount base kit. The adhesive mount base kit design is for machines with thin casings that do not permit drilling and tapping a mounting hole. Kit contains material (adhesive and bases) for 2 each 3/8-in 24 UNF adhesive-mount bases. One kit can outfit 2 Velomitor CT Transducers.

Spare Mounting Adapters

All mounting adapters are made from 300 series stainless steel.

Standard Studs

04365657	3/8-in 24 to 3/8-in 24 stud
87910-01	3/8-in 24 to 1/2-in 20 stud
87931-01	M6x1 to M6x1 metric stud (requires metric adapter)
87055-01	3/8-in 24 to M6x1 metric adapter
89139-01	3/8-in 24 to 1/4-in 28 stud

Hex Plate Studs

107756-01	3/8-in 24 to 3/8-in 24 plate stud
107755-01	3/8-in 24 to 1/2-in 20 plate stud
107754-01	3/8-in 24 to 1/4-in NPT plate stud
107757-01	M6x1 to M6x1 plate stud (requires metric adapter)
125094-01	3/8-in 24 to M8x1 metric plate stud
128038-01	3/8-in 24 to 1/4-in 28 Plate Stud

Quick Disconnect Components

The following three components are included with the quick disconnect mounting option for the Velomitor CT Transducer. The quick disconnect option allows you to remove the

transducer without rotating it, allowing you to keep the cable connected to the transducer.

128689-01	3/8-in 24 to 1/4-in 16 quick disconnect stud base. Attached to the machine.
43055-01	1/4-in 16 mounting base nut. Interface between stud base and transducer piece.
128690-01	3/8-in 24 quick disconnect stud transducer piece. Attached to the Velomitor CT Transducer.

Fittings

Conduit fittings allow connection of flexible, metal, liquid-tight conduit or armor to the conduit adapter.

03839201	1/2-in NPT straight male conduit fitting. For connecting flexible, liquid-tight conduit to the conduit adapter or a weatherproof enclosure.
03850000	1/2-in NPT straight, male compression-type fitting. For connecting Teflon™-coated 3/8-in stainless steel armor to the transducer or a weatherproof enclosure. Fitting will fit Teflon™-coated armor with a maximum outer diameter of 13.8 mm (0.543 in) (including Teflon™ thickness).

[caption]

Teflon-Coated Stainless Steel Armor

106924-AA



This part includes the Teflon-coated armor but not the cable. You will require 2 1/2-in NPT compression fittings (part number 03850000) to attach the armor to the conduit adapter and terminate it at an enclosure.

A: Armor Length Option in Feet

Order in increments of 10 ft (3.0 m)

Minimum Length: 10 ft (3.0 m)

Maximum Length: 60 ft (18.3 m)

Flexible Metal Conduit

14847-AA

A: Flexible Conduit Length Option in Feet

Order in increments of 1 ft (0.3 m)

Minimum Length: 01 ft (0.3 m)

Maximum Length: 99 ft (30.2 m)

106769-01	Terminal housing. Provides a convenient interface between the transducer signal cable and monitor signal cable.
-----------	---

Graphs and Figures

Note: All dimensions shown are in millimeters (inches) unless noted otherwise.

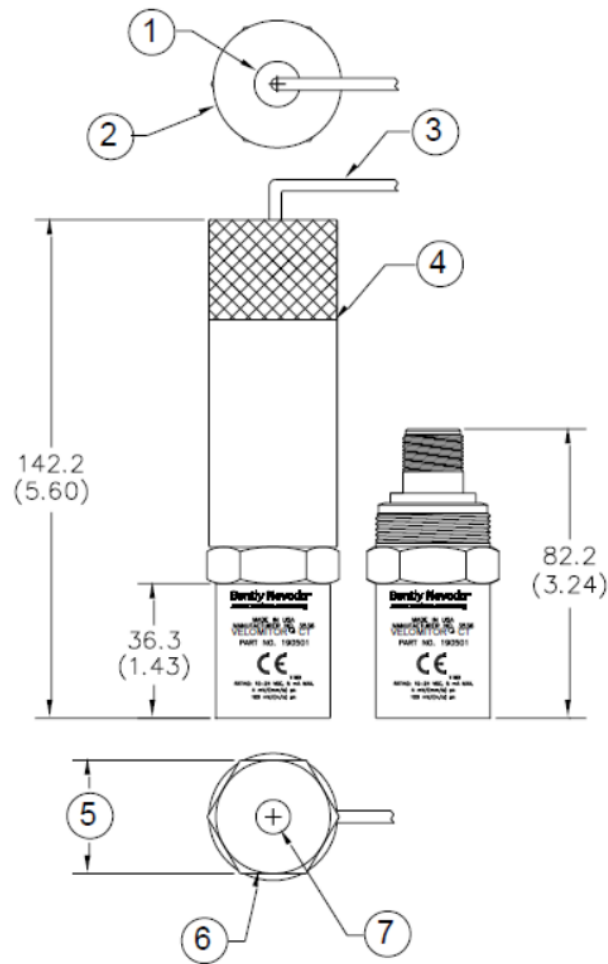

1. 1/2" NPT x 12.2 DP (1/2" NPT x 0.48 DP)
2. 35.6 (1.40) diameter
3. Cable (not included)
4. Conduit adaptor P/N 128608-02 (not included)
5. 31.8 (1.25) hex flat
6. 31.5 (1.24) diameter
7. 3/8-24 UNF X 8.9 DP (3/8-24 UNF X 0.35 DP)

Figure 1: Velomitor CT Outline Drawing

Spare Mounting Adapters



All mounting adapters are made from 300 series stainless steel. Illustrations shown are not to scale.

Table 1: Standard Studs

Part Number	Size	Illustration
04365657	3/8-24 to 3/8-24	
87055-01	3/8-24 to M6X1	
87910-01	3/8-24 to 1/2-20	
87931-01	M6X1 to M6X1	
89139-01	3/8-24 to 1/4-28	

Table 2: Adhesive Studs

Part Number	Size	Illustration
04284020	3/8-24	

Table 3: 1-3/8 Hex Plate Studs

Part Number	Size	Illustration
107754-01	3/8-24 UNF to 1/4 NPT	
107755-01	3/8-24 UNF to 1/2-20 UNF	
107756-01	3/8-24 to 3/8-24	
197757-01	M6X1 to M6X1	
125094-01	3/8-24 UNF to M8X1	
128038-01	3/8-24 UNF to 1/4-28 UNF	

Table 4: Quick Disconnect Studs

Part Number	Description	Illustration
43055-01	Union Mounting Base Nut	
128689-01	Quick Disconnect Stud Base	

Part Number	Description	Illustration
128690-01	Quick Disconnect Transducer Piece	

Graphs

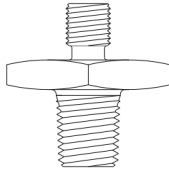
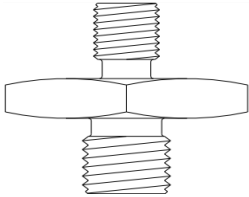
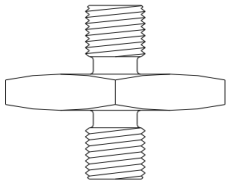
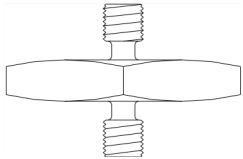
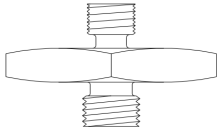
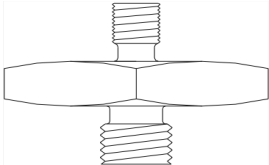
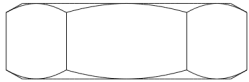
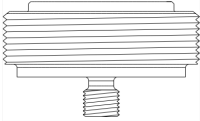
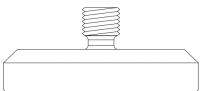
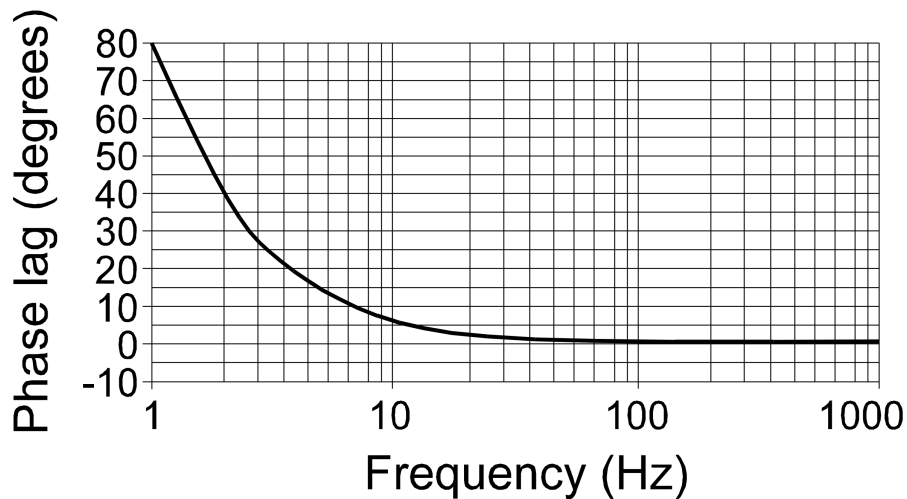

Figure 2: Typical Phase Response

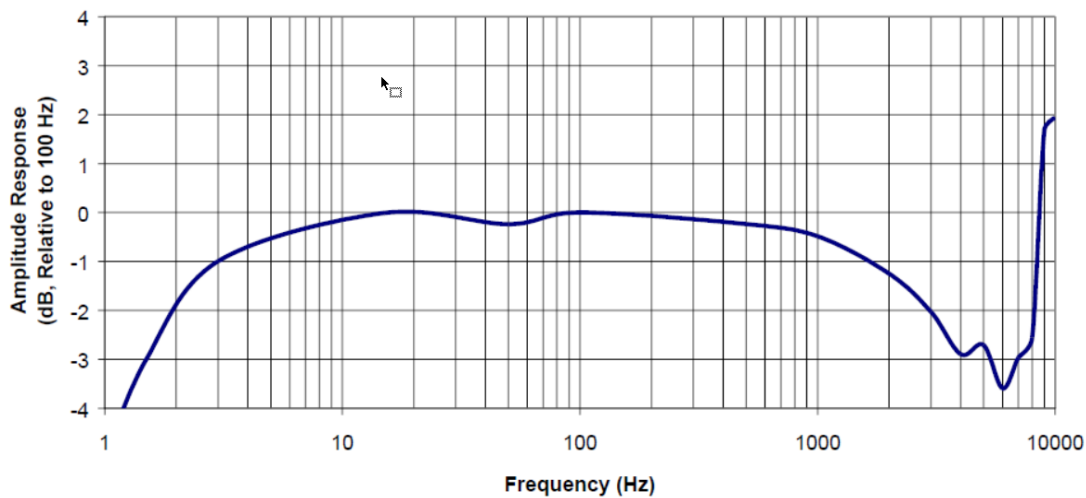
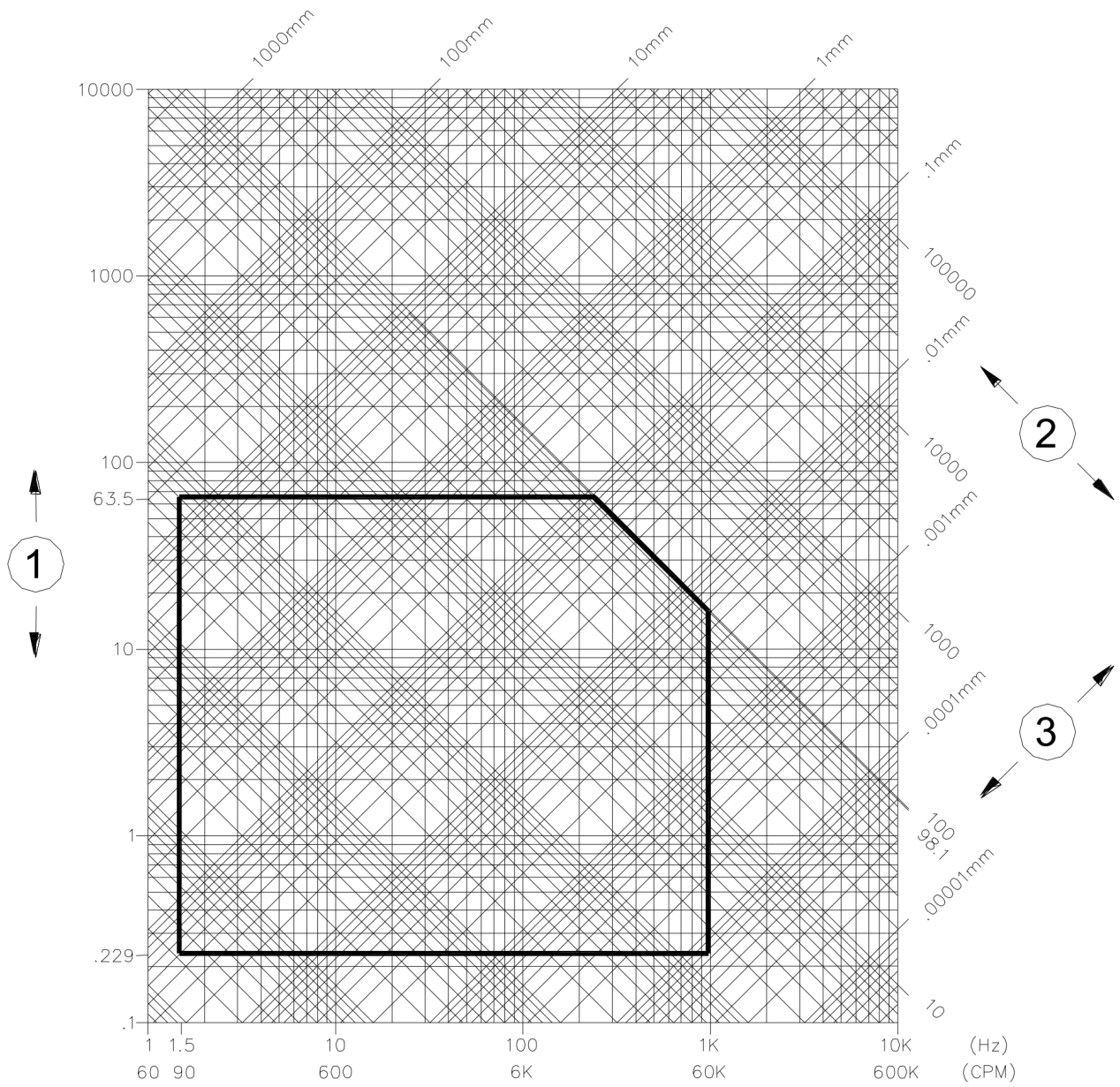
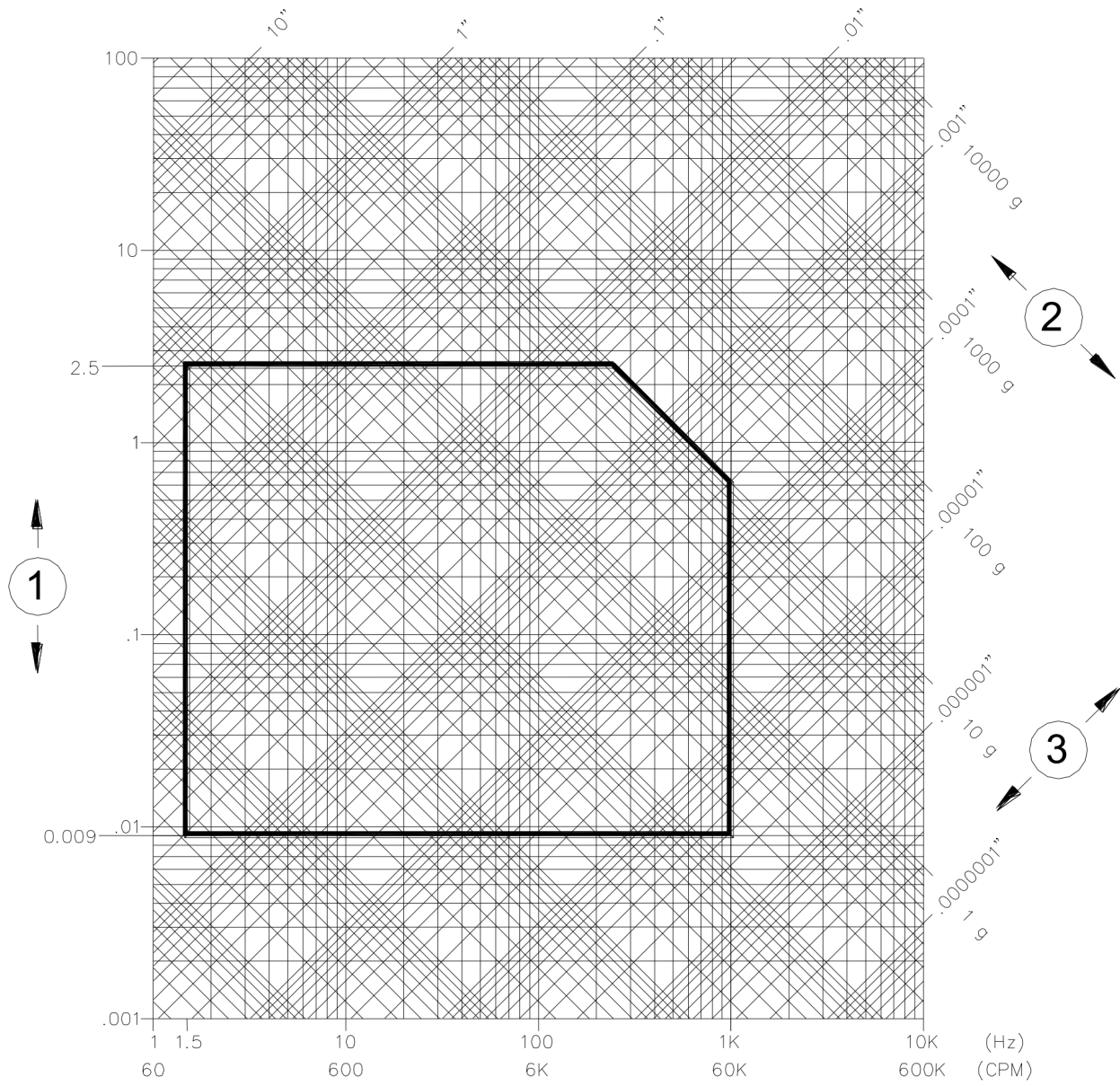

Figure 3: Typical Amplitude Response



1. Velocity axis (mm/s peak-peak)
2. Displacement axis (mm peak-peak)
3. Acceleration axis (m/s² peak-peak)

Figure 4: Operating Range for Metric Units



1. Velocity axis (in./s peak-peak)
2. Displacement axis (in. peak-peak)
3. Acceleration axis (g peak-peak)

Figure 5: Operating Range for English Units

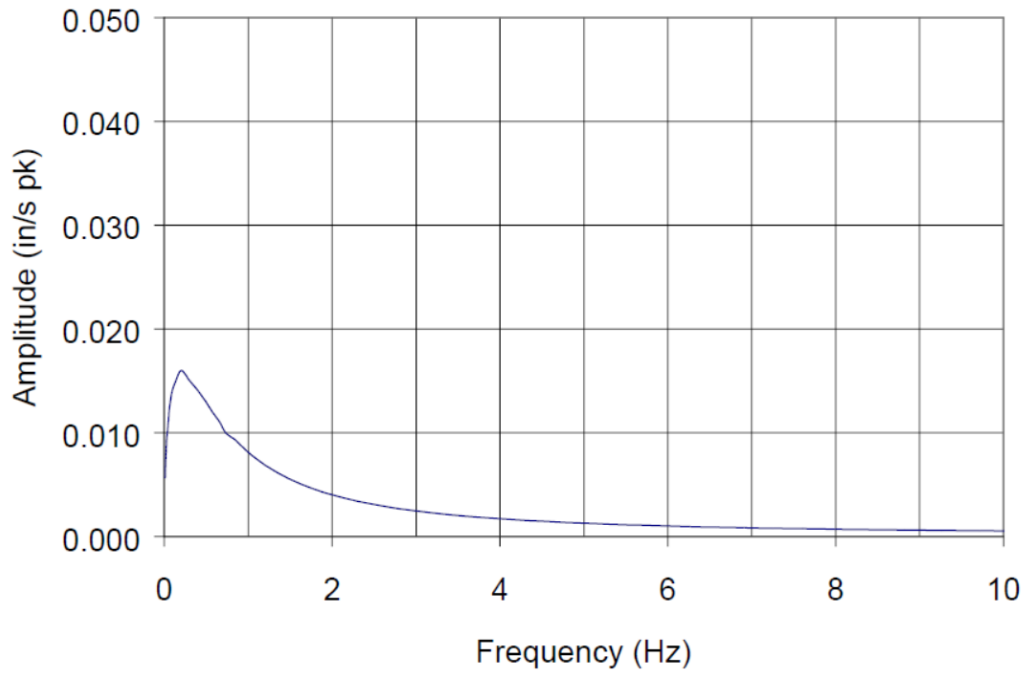

Figure 6: Typical Low Frequency Noise Floor

Copyright 2020 Baker Hughes Company. All rights reserved.



Bently Nevada, Orbit Logo and Velomitor are registered trademarks of Bently Nevada, a Baker Hughes Business, in the United States and other countries. The Baker Hughes logo is a trademark of Baker Hughes Company. All other product and company names are trademarks of their respective holders. Use of the trademarks does not imply any affiliation with or endorsement by the respective holders.

Baker Hughes provides this information on an "as is" basis for general information purposes. Baker Hughes does not make any representation as to the accuracy or completeness of the information and makes no warranties of any kind, specific, implied or oral, to the fullest extent permissible by law, including those of merchantability and fitness for a particular purpose or use. Baker Hughes hereby disclaims any and all liability for any direct, indirect, consequential or special damages, claims for lost profits, or third party claims arising from the use of the information, whether a claim is asserted in contract, tort, or otherwise. Baker Hughes reserves the right to make changes in specifications and features shown herein, or discontinue the product described at any time without notice or obligation. Contact your Baker Hughes representative for the most current information.

The information contained in this document is the property of Baker Hughes and its affiliates; and is subject to change without prior notice. It is being supplied as a service to our customers and may not be altered or its content repackaged without the express written consent of Baker Hughes. This product or associated products may be covered by one or more patents. See [Bentley.com/legal](https://www.bentley.com/legal).

1631 Bently Parkway South, Minden, Nevada USA 89423
Phone: 1.775.782.3611 or 1.800.227.5514 (US only)
[Bentley.com](https://www.bentley.com)