

FLUKE®

Fluke 19xC-2x5C
ScopeMeter

Software version 8.00 onwards

Users Manual

4822 872 30805

July 2008, Rev. 1, 09/2009

© 2008, 2009 Fluke Corporation. All rights reserved.

All product names are trademarks of their respective companies.

SCOPE

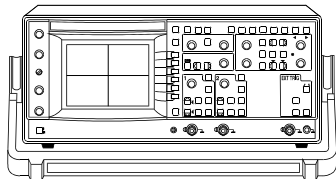

CURSOR

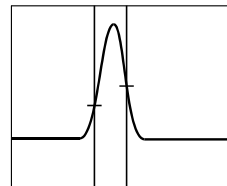

METER

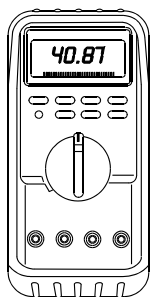

ZOOM

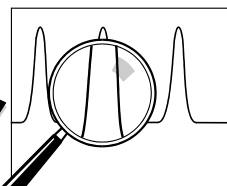

RECORDER

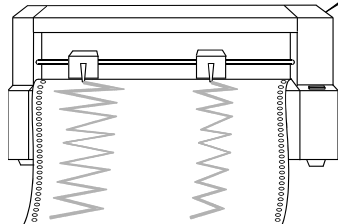

REPLAY

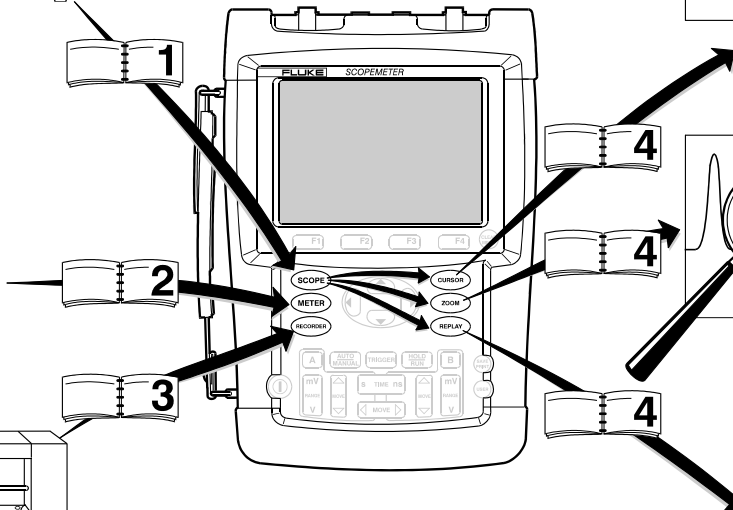

LIMITED WARRANTY & LIMITATION OF LIABILITY

Each Fluke product is warranted to be free from defects in material and workmanship under normal use and service. The warranty period is three years for the test tool and one year for its accessories. The warranty period begins on the date of shipment. Parts, product repairs and services are warranted for 90 days. This warranty extends only to the original buyer or end-user customer of a Fluke authorized reseller, and does not apply to fuses, disposable batteries or to any product which, in Fluke's opinion, has been misused, altered, neglected or damaged by accident or abnormal conditions of operation or handling. Fluke warrants that software will operate substantially in accordance with its functional specifications for 90 days and that it has been properly recorded on non-defective media. Fluke does not warrant that software will be error free or operate without interruption.

Fluke authorized resellers shall extend this warranty on new and unused products to end-user customers only but have no authority to extend a greater or different warranty on behalf of Fluke. Warranty support is available if product is purchased through a Fluke authorized sales outlet or Buyer has paid the applicable international price. Fluke reserves the right to invoice Buyer for importation costs of repair/replacement parts when product purchased in one country is submitted for repair in another country.

Fluke's warranty obligation is limited, at Fluke's option, to refund of the purchase price, free of charge repair, or replacement of a defective product which is returned to a Fluke authorized service center within the warranty period.

To obtain warranty service, contact your nearest Fluke authorized service center or send the product, with a description of the difficulty, postage and insurance prepaid (FOB Destination), to the nearest Fluke authorized service center. Fluke assumes no risk for damage in transit. Following warranty repair, the product will be returned to Buyer, transportation prepaid (FOB Destination). If Fluke determines that the failure was caused by misuse, alteration, accident or abnormal condition of operation or handling, Fluke will provide an estimate of repair costs and obtain authorization before commencing the work. Following repair, the product will be returned to the Buyer transportation prepaid and the Buyer will be billed for the repair and return transportation charges (FOB Shipping Point).

THIS WARRANTY IS BUYER'S SOLE AND EXCLUSIVE REMEDY AND IS IN LIEU OF ALL OTHER WARRANTIES, EXPRESS OR IMPLIED, INCLUDING BUT NOT LIMITED TO ANY IMPLIED WARRANTY OF MERCHANTABILITY OR FITNESS FOR A PARTICULAR PURPOSE. FLUKE SHALL NOT BE LIABLE FOR ANY SPECIAL, INDIRECT, INCIDENTAL OR CONSEQUENTIAL DAMAGES OR LOSSES, INCLUDING LOSS OF DATA, WHETHER ARISING FROM BREACH OF WARRANTY OR BASED ON CONTRACT, TORT, RELIANCE OR ANY OTHER THEORY.

Since some countries or states do not allow limitation of the term of an implied warranty, or exclusion or limitation of incidental or consequential damages, the limitations and exclusions of this warranty may not apply to every buyer. If any provision of this Warranty is held invalid or unenforceable by a court of competent jurisdiction, such holding will not affect the validity or enforceability of any other provision.

Fluke Corporation, P.O. Box 9090, Everett, WA 98206-9090 USA, or

Fluke Industrial B.V., P.O. Box 90, 7600 AB, Almelo, The Netherlands

SERVICE CENTERS

To locate an authorized service center, visit us on the World Wide Web:

<http://www.fluke.com>

or call Fluke using any of the phone numbers listed below:

+1-888-993-5853 in U.S.A. and Canada

+31-40-2675200 in Europe

+1-425-446-5500 from other countries

Table of Contents

Chapter	Title	Page
	Unpacking the Test Tool Kit.....	0-2
	Safety Information: Read First	0-4
1	Using The Scope.....	1-7
	Powering the Test Tool.....	1-7
	Resetting the Test Tool.....	1-8
	Navigating a Menu	1-9
	Hiding Key Labels and Menus	1-10
	Input Connections	1-10
	Making Scope Connections	1-11
	Displaying an Unknown Signal with Connect-and-View™	1-12
	Making Automatic Scope Measurements.....	1-13
	Freezing the Screen.....	1-14
	Using Average, Persistence and Glitch Capture	1-15
	Acquiring Waveforms.....	1-18
	Pass - Fail Testing	1-24
	Analyzing Waveforms	1-25

2	Using The Multimeter	2-27
	Making Meter Connections	2-27
	Making Multimeter Measurements	2-28
	Freezing the Readings.....	2-31
	Selecting Auto/Manual Ranges.....	2-31
	Making Relative Measurements.....	2-32
3	Using The Recorder Functions	3-33
	Opening the Recorder Main Menu.....	3-33
	Plotting Measurements Over Time (TrendPlot™).....	3-34
	Recording Scope Waveforms In Deep Memory (Scope Record).....	3-37
	Analyzing a TrendPlot or Scope Record	3-40
4	Using Replay, Zoom and Cursors	4-41
	Replaying the 100 Most Recent Scope Screens.....	4-41
	Zooming in on a Waveform.....	4-44
	Making Cursor Measurements.....	4-46
5	Triggering on Waveforms	5-51
	Setting Trigger Level and Slope.....	5-52
	Using Trigger Delay or Pre-trigger	5-53
	Automatic Trigger Options	5-54
	Triggering on Edges	5-55
	Triggering on External Waveforms	5-58
	Triggering on Video Signals.....	5-59
	Triggering on Pulses.....	5-61

6	Using The Bushealth Function	6-65
	Bushealth Function Availability	6-65
	Introduction	6-65
	Performing Bushealth Measurements	6-66
	Reading the Screen	6-68
	Input Connections and Tested Signals	6-70
	Viewing the Bus Waveform Screen	6-80
	Setting the Test Limits	6-81
	Saving and Recalling Test Limits	6-82
7	Using Memory, PC and Printer	7-83
	Saving and Recalling	7-83
	Documenting Screens	7-88
8	Tips	8-91
	Using the Standard Accessories	8-91
	Using the Independently Floating Isolated Inputs	8-93
	Using the Tilt Stand	8-95
	Resetting the Test Tool	8-95
	Suppressing Key Labels and Menu's	8-95
	Changing the Information Language	8-96
	Adjusting the Contrast and Brightness	8-96
	Changing the Display Color	8-97
	Changing Date and Time	8-97
	Saving Battery Life	8-98
	Changing the Auto Set Options	8-99
9	Maintaining the Test Tool	9-101

	Cleaning the Test Tool.....	9-101
	Storing the Test Tool	9-101
	Charging the Batteries	9-102
	Extending Battery Operation Time.....	9-103
	Replacing the NiMH Battery Pack BP190	9-104
	Calibrating the Voltage Probes	9-104
	Displaying Calibration Information	9-106
	Parts and Accessories	9-106
	Troubleshooting	9-111
10	Specifications	10-113
	Introduction	10-113
	Dual Input Oscilloscope	10-114
	Automatic Scope Measurements	10-116
	Meter	10-120
	DMM Measurements on Meter Inputs.....	10-120
	Recorder.....	10-122
	Zoom, Replay and Cursors	10-123
	Fieldbus – Bushealth	10-123
	Miscellaneous	10-124
	Environmental.....	10-125
	 Safety	10-126
	10:1 Probe	10-127
	Electromagnetic Immunity.....	10-129

Appendices

A Bushealth Measurements A-1

Declaration of Conformity

for

Fluke 192C - 196C - 199C – 215C – 225C

ScopeMeter® test tools

Manufacturer

Fluke Industrial B.V.
Lelyweg 14
7602 EA Almelo
The Netherlands

Statement of Conformity

Based on test results using appropriate standards,
the product is in conformity with
Electromagnetic Compatibility Directive 2004/108/EC
Low Voltage Directive 2006/95/EC

Sample tests

Standards used:

EN 61010.1 : 2001
Safety Requirements for Electrical Equipment for
Measurement, Control, and Laboratory Use

EN61326-1:2006
Electrical equipment for
measurements and laboratory
use -EMC requirements-

The tests have been performed in a
typical configuration.

This Conformity is indicated by the symbol **CE**,
i.e. “Conformité Européenne”.

Unpacking the Test Tool Kit

The following items are included in your test tool kit:

Note

When new, the rechargeable NiMH battery is not fully charged. See Chapter 9.

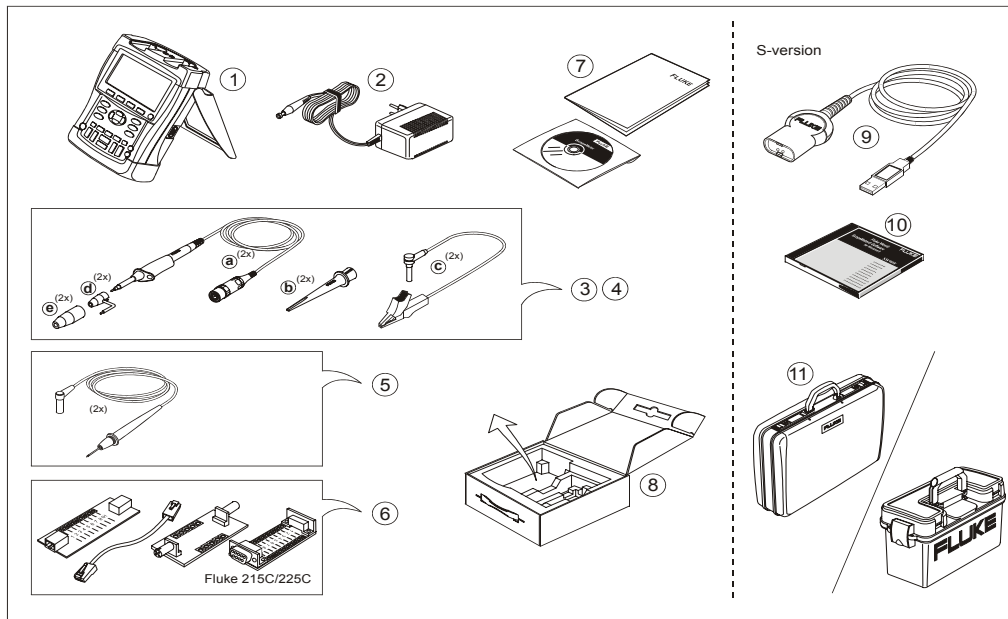

Figure 1. ScopeMeter Test Tool Kit

Unpacking the Test Tool Kit

#	Description
1	ScopeMeter Test Tool
2	Battery Charger (country dependent)
3	10:1 Voltage Probe Set (red) a) 10:1 Voltage Probe (red) b) Hook Clip for Probe Tip (red) c) Ground Lead with Mini Alligator Clip (black) d) Ground Spring for Probe Tip (black) e) Insulation Sleeve (red)
4	10:1 Voltage Probe Set (gray) a) 10:1 Voltage Probe (gray) b) Hook Clip for Probe Tip (gray) c) Ground Lead with Mini Alligator Clip (black) d) Ground Spring for Probe Tip (black) e) Insulation Sleeve (gray)

5	Test Lead Set
6	BHT190 Bus Health Test adapter (<i>2x5C only</i>)
7	Safety Information + CD ROM with Users Manual (multi-language)
8	Shipment box (<i>basic version only</i>)

Fluke 19xC and 2x5C -S versions include also the following items:

#	Description
9	Optically Isolated USB Adapter/Cable
10	FlukeView® ScopeMeter® Software for Windows®
11	Hard Case

Safety Information: Read First









Carefully read the following safety information before using the test tool.

Specific warning and caution statements, where they apply, appear throughout the manual.

A “Warning” identifies conditions and actions that pose hazard(s) to the user.

A “Caution” identifies conditions and actions that may damage the test tool.

The following international symbols are used on the test tool and in this manual:

	See explanation in manual		Double Insulation (Protection Class)
	Safety Approval		Earth ground
	Recycling information		Conformité Européenne
	Direct Current		Alternating Current
	Do not dispose of this product as unsorted municipal waste. Go to Fluke's website for recycling information.		

Warning

To avoid electrical shock or fire:

- **Use only the Fluke power supply, Model BC190 (Battery Charger / Power Adapter).**
- **Before use check that the selected/indicated range on the BC190 matches the local line power voltage and frequency.**
- **For the BC190/808 universal Battery Charger / Power Adapter) only use line cords that comply with the local safety regulations.**

Note:

To accommodate connection to various line power sockets, the BC190/808 universal Battery Charger / Power Adapter is equipped with a male plug that must be connected to a line cord appropriate for local use. Since the adapter is isolated, the line cord does not need to be equipped with a terminal for connection to protective ground. Since line cords with a protective grounding terminal are more commonly available you might consider using these anyhow.

Warning

To avoid electrical shock or fire if a test tool input is connected to more than 42 V peak (30 Vrms) or on circuits of more than 4800 VA:

- Use only insulated voltage probes, test leads and adapters supplied with the test tool, or indicated by Fluke as suitable for the Fluke 19xC – 2x5C ScopeMeter series.
- Before use, inspect voltage probes, test leads and accessories for mechanical damage and replace when damaged.
- Remove all probes, test leads and accessories that are not in use.
- Always connect the battery charger first to the ac outlet before connecting it to the test tool.
- Do not connect the ground spring (figure 1, item f) to voltages higher than 42 V peak (30 Vrms) from earth ground.
- Do not apply voltages that differ more than 600 V from earth ground to any input when measuring in a CAT III environment.
Do not apply voltages that differ more than 1000 V from earth ground to any input when measuring in a CAT II environment.

- Do not apply voltages that differ more than 600 V from each other to the isolated inputs when measuring in a CAT III environment.
Do not apply voltages that differ more than 1000 V from each other to the isolated inputs when measuring in a CAT II environment.
- Do not apply input voltages above the rating of the instrument. Use caution when using 1:1 test leads because the probe tip voltage will be directly transmitted to the test tool.
- Do not use exposed metal BNC or banana plug connectors.
- Do not insert metal objects into connectors.
- Always use the test tool only in the manner specified.

Voltage ratings that are mentioned in the warnings, are given as limits for “working voltage”. They represent V ac rms (50-60 Hz) for ac sinewave applications and as V dc for dc applications.

Measurement Category III refers to distribution level and fixed installation circuits inside a building.
Measurement Category II refers to local level, which is applicable for appliances and portable equipment.

The terms 'Isolated' or 'Electrically floating' are used in this manual to indicate a measurement in which the test tool input BNC or banana jack is connected to a voltage different from earth ground.

The isolated input connectors have no exposed metal and are fully insulated to protect against electrical shock.

The red and gray BNC jacks, and the red and black 4-mm banana jacks can independently be connected to a voltage above earth ground for isolated (electrically floating) measurements and are rated up to 1000 Vrms CAT II and 600 Vrms CAT III above earth ground.

If Safety Features are Impaired

Use of the test tool in a manner not specified may impair the protection provided by the equipment.

Before use, inspect the test leads for mechanical damage and replace damaged test leads!

Whenever it is likely that safety has been impaired, the test tool must be turned off and disconnected from the line power. The matter should then be referred to qualified personnel. Safety is likely to be impaired if, for example, the test tool fails to perform the intended measurements or shows visible damage.

Chapter 1

Using The Scope

About this Chapter

This chapter provides a step-by-step introduction to the scope functions of the test tool. The introduction does not cover all of the capabilities of the scope functions but gives basic examples to show how to use the menus and perform basic operations.

Powering the Test Tool

Follow the procedure (steps 1 through 3) in Figure 2 to power the test tool from a standard ac outlet. See Chapter 8 for instructions on using battery power.



Turn the test tool on with the on/off key.

The test tool powers up in its last setup configuration.

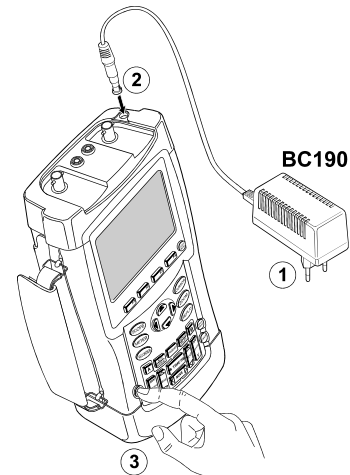





Figure 2. Powering the Test Tool

Resetting the Test Tool

If you want to reset the test tool to the factory settings, do the following:

- 1  Turn the test tool off.
- 2  Press and hold the **USER** key.
- 3  Press and release.

The test tool turns on, and you should hear a double beep, indicating the reset was successful.

- 4  Release the **USER** key.

Now look at the display; you will see a screen that looks like Figure 3.

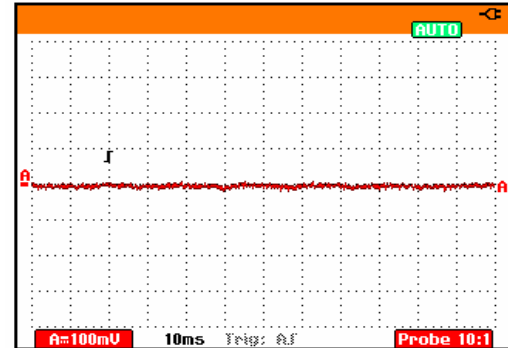



Figure 3. The Screen After Reset

Navigating a Menu

The following example shows how to use the test tool's menus to select a function. Subsequently follow steps 1 through 4 to open the scope menu and to choose an item.

- 1  Press the **SCOPE** key to display the labels that define the present use for the four blue function keys at the bottom of the screen.

READINGS	READING 1	READING 2	WAVEFORM OPTIONS...
ON OFF	

Note

To hide the labels for full screen view, press the **SCOPE** key again. This toggling enables you to check the labels without affecting your settings.

- 2  Open the **Waveform Options** menu. This menu is displayed at the bottom of the screen.

Waveform Options		
Glitch Detect:	Average:	Waveform:
<input checked="" type="checkbox"/> On	<input checked="" type="checkbox"/> Off	<input checked="" type="checkbox"/> Normal
<input type="checkbox"/> Off	<input type="checkbox"/> On...	<input type="checkbox"/> Persistence...
		<input type="checkbox"/> Mathematics...
		<input type="checkbox"/> Reference...

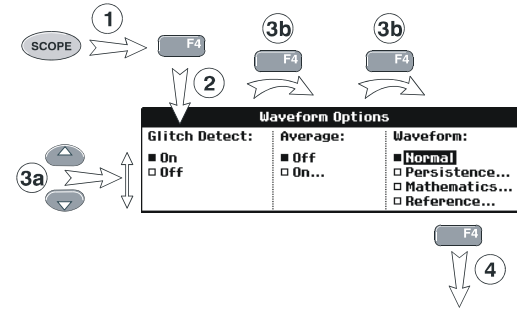





Figure 4. Basic Navigation

- 3a  Use the blue arrow keys to highlight the item.
- 3b  Press the blue **ENTER** key to accept the selection.
- 4  Press the **ENTER** key until you exit the menu.

Note

Repeatedly pressing  lets you to step through a menu without changing the settings.

Hiding Key Labels and Menus

You can hide a menu or key label at any time:



Press the **CLEAR MENU** key to hide any key label or menu.

To display menus or key labels, press one of the yellow menu keys, e.g. the **SCOPE** key.

Input Connections

Look at the top of the test tool. The test tool has four signal inputs: two safety BNC jack inputs (red input A and gray input B) and two safety 4-mm banana jack inputs (red and black). Use the two BNC jack inputs for scope measurements, and the two banana jack inputs for meter measurements.

Isolated input architecture allows independent floating measurements with each input.

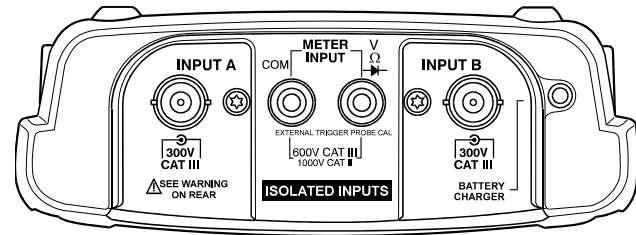

Figure 5. Measurement Connections

Making Scope Connections

To make dual input scope measurements, connect the red voltage probe to input A, and the gray voltage probe to input B. Connect the short ground leads of **each** voltage probe to its **own** reference potential. (See Figure 6.)

Note

To maximally benefit from having independently isolated floating inputs and to avoid problems caused by improper use, read Chapter 8: "Tips".

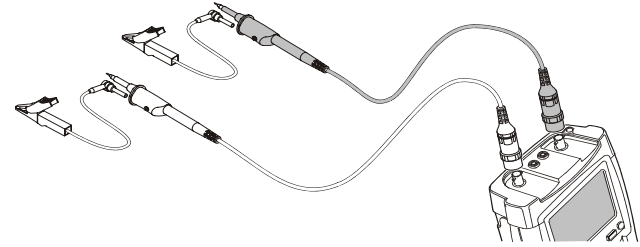



Figure 6. Scope Connections

Displaying an Unknown Signal with Connect-and-View™

The Connect-and-View feature lets the test tool display complex, unknown signals automatically. This function optimizes the position, range, time base, and triggering and assures a stable display of virtually any waveform. If the signal changes, the setup is automatically adjusted to maintain the best display result. This feature is especially useful for quickly checking several signals.

To enable the Connect-and-View feature, do the following:

- 1  Perform an Auto Set. **AUTO** appears at the top right of the screen.

The bottom line shows the range, the time base, and the trigger information.

The waveform identifier (**A**) is visible on the bottom right side of the screen, as shown in Figure 7. The input A zero icon (**⏏**) at the left side of the screen identifies the ground level of the waveform.

- 2  Press a second time to select the manual range again. **MANUAL** appears at the top right of the screen.

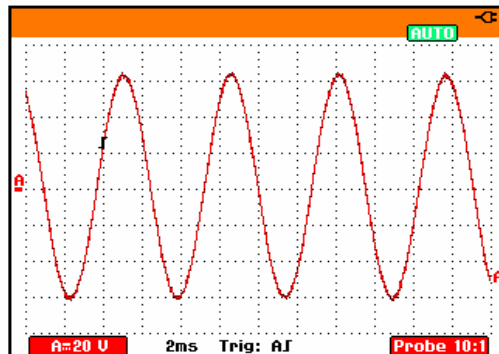



Figure 7. The Screen After an Auto Set

Use the light-gray **RANGE**, **TIME** and **MOVE** keys at the bottom of the keypad to change the view of the waveform manually.



Making Automatic Scope Measurements

The test tool offers a wide range of automatic scope measurements. You can display two numeric readings: **READING 1** and **READING 2**. These readings are selectable independently, and the measurements can be done on the input A or input B waveform

To choose a frequency measurement for input A, do the following:

- 1  Display the **SCOPE** key labels.

READINGS ON OFF	READING 1 ...	READING 2 ...	WAVEFORM OPTIONS...
-----------------	---------------	---------------	---------------------
- 2  Open the **Reading 1** menu.



Reading 1			
<input checked="" type="checkbox"/> on A	<input type="checkbox"/> V ac	<input type="checkbox"/> A ac...	<input type="checkbox"/> Hz
<input type="checkbox"/> on B	<input type="checkbox"/> V dc	<input type="checkbox"/> A dc...	<input type="checkbox"/> Rise time
<input type="checkbox"/> Off	<input type="checkbox"/> U ac+dc	<input type="checkbox"/> A ac+dc...	<input type="checkbox"/> Fall time
	<input type="checkbox"/> Peak...	<input type="checkbox"/> Power...	<input type="checkbox"/> Pulse...
	<input type="checkbox"/> U pwm...	<input type="checkbox"/> Phase	<input type="checkbox"/> Duty...
- 3  Select **on A**. Observe that the highlight jumps to the present measurement.
- 4  Select the **Hz** measurement.

Observe that the top left of the screen displays the Hz measurement. (See Figure 8.)

To choose also a **Peak-Peak** measurement for Input B as second reading, do the following:

- 1  Display the **SCOPE** key labels.

READINGS ON OFF	READING 1 ...	READING 2 ...	WAVEFORM OPTIONS...
-----------------	---------------	---------------	---------------------
- 2  Open the **Reading 2** menu.

Reading 2			
<input checked="" type="checkbox"/> on A	<input type="checkbox"/> V ac	<input type="checkbox"/> A ac...	<input checked="" type="checkbox"/> Hz
<input type="checkbox"/> on B	<input type="checkbox"/> V dc	<input type="checkbox"/> A dc...	<input type="checkbox"/> Rise time
<input type="checkbox"/> Off	<input type="checkbox"/> U ac+dc	<input type="checkbox"/> A ac+dc...	<input type="checkbox"/> Fall time
	<input type="checkbox"/> Peak...	<input type="checkbox"/> Power...	<input type="checkbox"/> Pulse...
	<input type="checkbox"/> U pwm...	<input type="checkbox"/> Phase	<input type="checkbox"/> Duty...
- 3  Select **on B**. The highlight jumps to the measurements field.
- 4  Open the **PEAK** menu.

Peak	
Peak Type:	
<input type="checkbox"/> Peak Max	
<input checked="" type="checkbox"/> Peak-Peak	
<input type="checkbox"/> Peak Min	
- 5  Select the **Peak-Peak** measurement.

Figure 8 shows an example of the screen. Note that the Peak-Peak reading for input B appears next to the input A frequency reading at the top of the screen.

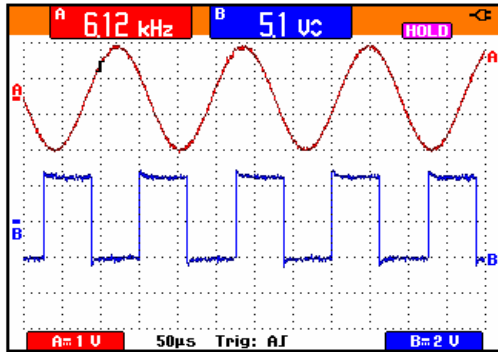



Figure 8. Hz and V peak-peak as Scope Readings

Freezing the Screen



You can freeze the screen (all readings and waveforms) at any time.



- | | | |
|---|---|---|
| 1 |  | Freeze the screen. HOLD appears at the right of the reading area. |
| 2 |  | Resume your measurement. |

Using Average, Persistence and Glitch Capture



Using Average for Smoothing Waveforms

To smooth the waveform, do the following:

- 1  Display the **SCOPE** key labels.
- 2  Open the **Waveform Options** menu.

Waveform Options		
Glitch Detect:	Average:	Waveform:
<input checked="" type="checkbox"/> On	<input checked="" type="checkbox"/> Off	<input checked="" type="checkbox"/> Normal
<input type="checkbox"/> Off	<input type="checkbox"/> On...	<input type="checkbox"/> Persistence...
		<input type="checkbox"/> Mathematics...
		<input type="checkbox"/> Reference...
- 3  Jump to **Average**:
- 4  Select **On...** to open the **Average Factors** menu

Average Factors
Average Factor:
<input type="checkbox"/> Average 2
<input type="checkbox"/> Average 4
<input checked="" type="checkbox"/> Average 8
<input type="checkbox"/> Average 64

- 5  Select **Average 64**. This averages the outcomes of 64 acquisitions.
- 6  Exit the menu.

You can use the average functions to suppress random or uncorrelated noise in the waveform without loss of bandwidth. Waveform samples with and without smoothing are shown in Figure 9.

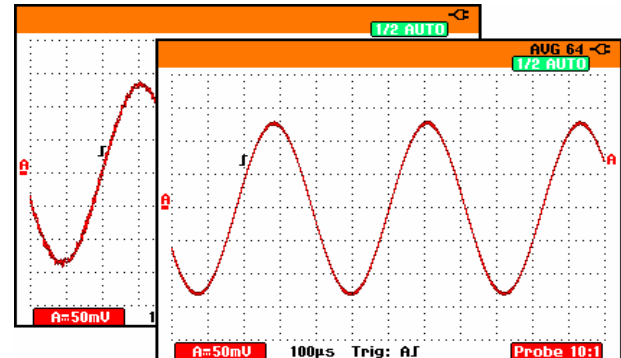



Figure 9. Smoothing a Waveform

Using Persistence to Display Waveforms

You can use Persistence to observe dynamic signals.

1  Display the **SCOPE** key labels.

2  Open the **Waveform Options** menu.

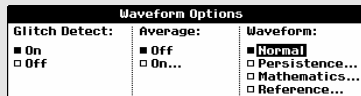

3  Jump to **Waveform:** and open the **Persistence...** menu.

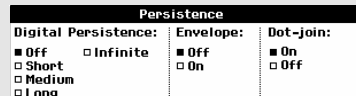

4  Select **Digital Persistence: Short, Medium, Long** or **Infinite** to observe dynamic waveforms .

Select **Digital Persistence: Off** , **Envelope: On** to see the upper and lower boundaries of dynamic waveforms (envelope mode).

Select **Dot-join: On** or **Off** to choose your personal preference for the waveform representation.

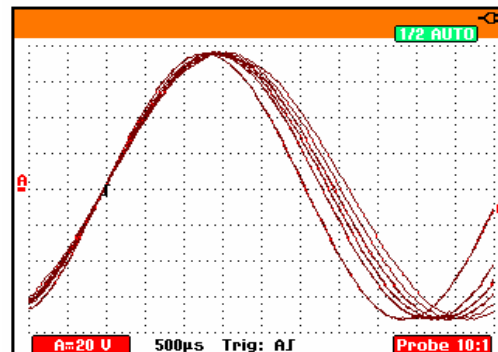





Figure 10. Using Persistence to Observe Dynamic Signals

Displaying Glitches

To capture glitches on a waveform, do the following:

- 1  Display the **SCOPE** key labels.
- 2  Open the **Waveform Options** menu.



Waveform Options		
Glitch Detect:	Average:	Waveform:
<input checked="" type="checkbox"/> On	<input checked="" type="checkbox"/> Off	<input checked="" type="checkbox"/> Normal
<input type="checkbox"/> Off	<input type="checkbox"/> On...	<input type="checkbox"/> Persistence...
		<input type="checkbox"/> Mathematics...
		<input type="checkbox"/> Reference...
- 3  Select **Glitch Detect: On**
- 4  Exit the menu.



You can use this function to display events (glitches or other asynchronous waveforms) of 50 ns (nanoseconds) or wider, or you can display HF modulated waveforms.

When you select the 2 mV/div range Glitch Detect will be turned Off. In the 2 mV/div range you can set Glitch Detect On .

Suppressing High Frequency Noise

Switching **Glitch Detect** to **Off** will suppress the high frequency noise on a waveform. Averaging will suppress the noise even more.

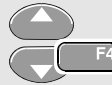
- 1  Display the **SCOPE** key labels.
- 2  Open the **Waveform Options** menu.

Waveform Options		
Glitch Detect:	Average:	Waveform:
<input checked="" type="checkbox"/> On	<input checked="" type="checkbox"/> Off	<input checked="" type="checkbox"/> Normal
<input type="checkbox"/> Off	<input type="checkbox"/> On...	<input type="checkbox"/> Persistence...
		<input type="checkbox"/> Mathematics...
		<input type="checkbox"/> Reference...
- 3  Select **Glitch Detect: Off**, then select **Average: On** to open the **Average** menu
- 4  Select **Factor : 8x**

Tip

Glitch capture and average do not affect bandwidth. Further noise suppression is possible with bandwidth limiting filters. See Chapter 1: “Working with Noisy Waveforms”.

Acquiring Waveforms

Selecting AC-Coupling

After a reset, the test tool is dc-coupled so that ac and dc voltages appear on the screen.

Use ac-coupling when you wish to observe a small ac signal that rides on a dc signal. To select ac-coupling, do the following:

1		Display the INPUT A key labels.				
<table border="1"> <tr> <td>INPUT A ON OFF</td> <td>COUPLING DC AC</td> <td>PROBE A 10:1...</td> <td>INPUT A OPTIONS..</td> </tr> </table>			INPUT A ON OFF	COUPLING DC AC	PROBE A 10:1...	INPUT A OPTIONS..
INPUT A ON OFF	COUPLING DC AC	PROBE A 10:1...	INPUT A OPTIONS..			
2		Highlight AC .				

Observe that the bottom left of the screen displays the ac-coupling icon: .

Reversing the Polarity of the Displayed Waveform

To invert the input A waveform, do the following:

1		Display the INPUT A key labels.										
<table border="1"> <tr> <td>INPUT A ON OFF</td> <td>COUPLING DC AC</td> <td>PROBE A 10:1...</td> <td>INPUT A OPTIONS..</td> </tr> </table>			INPUT A ON OFF	COUPLING DC AC	PROBE A 10:1...	INPUT A OPTIONS..						
INPUT A ON OFF	COUPLING DC AC	PROBE A 10:1...	INPUT A OPTIONS..									
2		Open the Input A menu.										
<table border="1"> <thead> <tr> <th colspan="2">Input A</th> </tr> </thead> <tbody> <tr> <td>Polarity:</td> <td>Bandwidth:</td> </tr> <tr> <td><input checked="" type="checkbox"/> Normal</td> <td><input checked="" type="checkbox"/> Full</td> </tr> <tr> <td><input type="checkbox"/> Inverted</td> <td><input type="checkbox"/> 10 kHz (HF reject)</td> </tr> <tr> <td><input type="checkbox"/> Variable</td> <td><input type="checkbox"/> 20 MHz</td> </tr> </tbody> </table>			Input A		Polarity:	Bandwidth:	<input checked="" type="checkbox"/> Normal	<input checked="" type="checkbox"/> Full	<input type="checkbox"/> Inverted	<input type="checkbox"/> 10 kHz (HF reject)	<input type="checkbox"/> Variable	<input type="checkbox"/> 20 MHz
Input A												
Polarity:	Bandwidth:											
<input checked="" type="checkbox"/> Normal	<input checked="" type="checkbox"/> Full											
<input type="checkbox"/> Inverted	<input type="checkbox"/> 10 kHz (HF reject)											
<input type="checkbox"/> Variable	<input type="checkbox"/> 20 MHz											
3		Select Inverted and accept inverted waveform display.										
4		Exit the menu.										

For example, a negative-going waveform is displayed as positive-going waveform which may provide a more meaningful view. An inverted display is identified by an inverted trace identifier () at the right of the waveform.

Variable Input Sensitivity

The variable input sensitivity allows you to adjust the input A sensitivity continuously, for example to set the amplitude of a reference signal to exactly 6 divisions.

The input sensitivity of a range can be increased up to 2.5 times, for example between 10 mV/div and 4 mV/div in the 10 mV/div range.

To use the variable input sensitivity, do the following:

1 Apply the input signal

2  Perform an Auto Set (AUTO must appear at the top of the screen)



An Auto Set will turn off the variable input sensitivity. You can now select the required input range. Keep in mind that the sensitivity will increase when you start adjusting the variable sensitivity (the displayed trace amplitude will increase).

3  Display the INPUT A key labels.

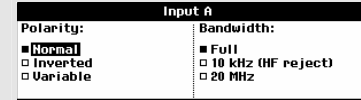

4  Open the Input A Options... menu.



5   Select and accept **Variable**.

6  Exit the menu.

At the bottom left of the screen the text **A Var** is displayed.

Selecting Variable will turn off cursors and automatic input ranging.

7  Press mV to increase the sensitivity, press V to decrease the sensitivity.



Working with Noisy Waveforms

To suppress high frequency noise on waveforms, you can limit the working bandwidth to 10 kHz or 20 MHz. This function smoothes the displayed waveform. For the same reason, it improves triggering on the waveform.

To choose HF reject, do the following:

- 1  Display the **INPUT A** key labels.

INPUT A	COUPLING	PROBE A	INPUT A
<input checked="" type="checkbox"/> ON <input type="checkbox"/> OFF	<input checked="" type="checkbox"/> DC <input type="checkbox"/> AC	10:1...	OPTIONS..
- 2  Open the **Input A** menu.

Input A	
Polarity:	Bandwidth:
<input checked="" type="checkbox"/> Normal	<input checked="" type="checkbox"/> Full
<input type="checkbox"/> Inverted	<input type="checkbox"/> 10 kHz (HF reject)
<input type="checkbox"/> Variable	<input type="checkbox"/> 20 MHz
- 3  Jump to **Bandwidth**.
- 4  Select **10kHz (HF reject)** to accept the bandwidth limitation.

Tip

To suppress noise without loss of bandwidth, use the average function or turn off **Display Glitches**.



Using Mathematics Functions $A \pm B$, $A \times B$, A vs B

When adding (A+B), subtracting (A-B), or multiplying (A*B) the input A and input B waveform, the test tool will display the mathematical result waveform and the input A and input B waveforms.

A versus B provides a plot with input A on the vertical axis and input B on the horizontal axis.



The Mathematics functions perform a point-to-point operation on waveforms A and B.

To use a Mathematics function, do the following:

- 1  Display the **SCOPE** key labels.
- 2  Open the **Waveform Options** menu.

Waveform Options		
Glitch Detect:	Average:	Waveform:
<input checked="" type="checkbox"/> On	<input checked="" type="checkbox"/> Off	<input checked="" type="checkbox"/> Normal
<input type="checkbox"/> Off	<input type="checkbox"/> On...	<input type="checkbox"/> Persistence...
		<input type="checkbox"/> Mathematics...
		<input type="checkbox"/> Reference...

- 3**  Jump to **Waveform:** and Select **Mathematics...** to open the **Mathematics** menu.

Mathematics		
Function:	Scalefactor:	Window:
<input type="checkbox"/> Off	<input type="checkbox"/> A vs B	<input checked="" type="checkbox"/> 1
<input checked="" type="checkbox"/> A + B	<input type="checkbox"/> Spectrum	<input type="checkbox"/> /2
<input type="checkbox"/> A - B		<input type="checkbox"/> /4
<input type="checkbox"/> A x B		<input type="checkbox"/> /8
		<input checked="" type="checkbox"/> Auto
		<input type="checkbox"/> Hanning
		<input type="checkbox"/> Hanning
		<input type="checkbox"/> None
- 4**  Select Function: **A+B, A-B, Ax B** or **A vs B**.
- 5**  Select a scale factor to fit the mathematical result waveform onto the display, and return.

The sensitivity range of the mathematical result is equal to the sensitivity range of the least sensitive input divided by the scale factor.

Using Mathematics Function Spectrum (FFT)



The Spectrum function shows the spectral content of the input A or input B waveform. It performs an FFT to transform the amplitude waveform from the time domain into the frequency domain.

To reduce the effect of side-lobes (leakage) it is recommended to use auto windowing. It will automatically adapt the part of the waveform that is analyzed to a complete number of cycles

Selecting Hanning, Hamming or no windowing results in a faster update, but also in more leakage.

Ensure that the entire waveform amplitude remains on the screen.

To use the Spectrum function, do the following:

- 1**  Display the **SCOPE** key labels.
- 2**  Open the **Waveform Options** menu.

Waveform Options		
Glitch Detect:	Average:	Waveform:
<input checked="" type="checkbox"/> On	<input checked="" type="checkbox"/> Off	<input checked="" type="checkbox"/> Normal
<input type="checkbox"/> Off	<input type="checkbox"/> On...	<input type="checkbox"/> Persistence...
		<input type="checkbox"/> Mathematics...
		<input type="checkbox"/> Reference...

3  Jump to **Waveform:** and select **Mathematics...** to open the **Mathematics** menu.

Mathematics		
Function:	Scalefactor:	Window:
<input type="checkbox"/> Off	<input type="checkbox"/> A vs B	<input checked="" type="checkbox"/> Auto
<input type="checkbox"/> A + B	<input type="checkbox"/> Z2	<input type="checkbox"/> Hamming
<input type="checkbox"/> A - B	<input type="checkbox"/> Z4	<input type="checkbox"/> Hanning
<input type="checkbox"/> A x B	<input type="checkbox"/> Z8	<input type="checkbox"/> None

4  Select **Function: Spectrum.**

5  Select **Window: Auto** (automatic windowing), **Hanning**, **Hamming**, or **None** (no windowing).

You will see a screen that looks like Figure 11.

Observe that the top right of the screen displays SPECTRUM.

If it displays LOW AMPL a spectrum measurement cannot be done as the waveform amplitude is too low.

If it displays WRONG TB the time base setting does not enable the test tool to display an FFT result. It is either too slow, which can result in aliasing, or too fast, which results in less than one signal period on the screen.

6  Perform a spectrum analysis on trace A, or trace B.

7  Set the vertical amplitude scale to linear or logarithmic. The horizontal frequency scale is always logarithmic.

8  Turn the spectrum function off/on (toggle function).

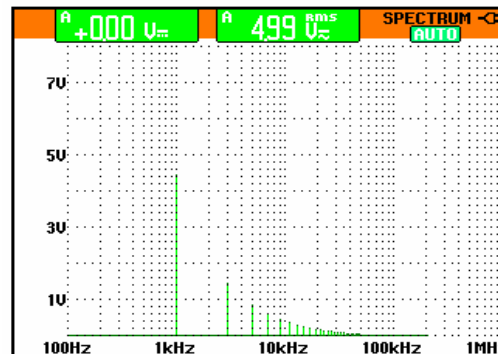





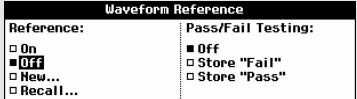

Figure 11. Spectrum measurement

Comparing Waveforms

You can display a fixed reference waveform with the actual waveform for comparison.

To create a reference waveform and to display it with the actual waveform, do the following:

1		Display the SCOPE key labels.
2		Open the Waveform Options menu.
		
3	 2x	Jump to the Waveform field.
4		Select Reference... to open the Waveform Reference menu.
		

5

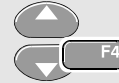

Select **On** to display the reference waveform. This can be:

- the last used reference waveform (if not available no reference waveform will be shown).
- the envelope waveform if the persistence function Envelope is on.

Select **Recall...** to recall a saved waveform (or waveform envelope) from memory and use it as a reference waveform.

Select **New...** to open the New Reference menu.



Continue at step 6.

6



Select the width of an additional envelope to be added to the momentary waveform.

7



Store the momentary waveform and display it permanently for reference. The display also shows the actual waveform.

To recall a saved waveform from memory and use it as a reference waveform refer also to Chapter 6 Recalling Screens with Associated Setups.

Example of reference waveform with an additional envelope of ± 2 pixels:

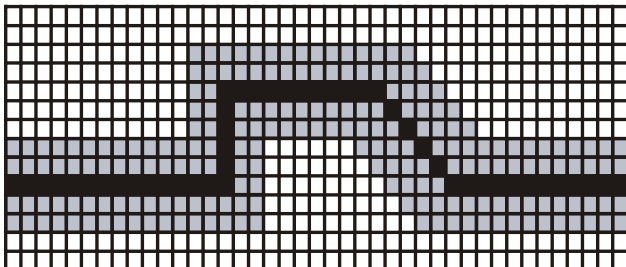

black pixels: basic waveform
gray pixels: ± 2 pixels envelope

1 vertical pixel on the display is $0.04 \times \text{range/div}$
1 horizontal pixel on the display is $0.0375 \times \text{range/div}$

Pass - Fail Testing

You can use a reference waveform as a test template for the actual waveform. If at least one sample of a waveform is outside the test template, the failed or passed scope screen will be stored. Up to 100 screens can be stored. If the memory is full, the first screen will be deleted in favor of the new screen to be stored.

The most appropriate reference waveform for the Pass-Fail test is a waveform envelope.

To use the Pass - Fail function using a waveform envelope, do the following:

- 1 Display a reference waveform as described in the previous section "Comparing Waveforms"
- 2  From the **Pass Fail Testing:** menu select
Store Fail : each scope screen with samples outside the reference will be stored
Store Pass: each scope screen with no samples outside the reference will be stored

Each time a scope screen is stored you will hear a beep. Chapter 4 provides information on how to analyze the stored screens.

Analyzing Waveforms

You can use the analysis functions **CURSOR**, **ZOOM** and **REPLAY** to perform detailed waveform analysis. These functions are described in Chapter 4: *“Using Cursors, Zoom and Replay”*.

Chapter 2

Using The Multimeter

About this Chapter

This chapter provides a step-by-step introduction to the multimeter functions of the test tool (hereafter called “meter”). The introduction gives basic examples to show how to use the menus and perform basic operations.

Making Meter Connections

Use the two 4-mm safety red ($\text{V}\Omega\text{--}$) and black (**COM**) banana jack inputs for the Meter functions. (See Figure 12.)

Note

Typical use of the Meter test leads and accessories is shown in Chapter 8.

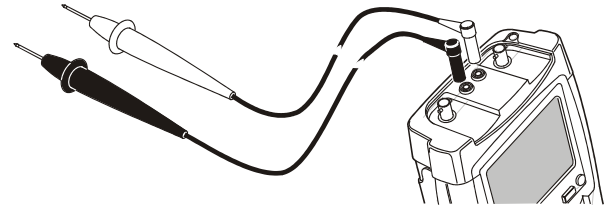

Figure 12. Meter Connections

Making Multimeter Measurements

The screen displays the numeric readings of the measurements on the meter input.

Measuring Resistance Values

To measure a resistance, do the following:

1 Connect the red and black test leads from the 4-mm banana jack inputs to the resistor.

2  Display the METER key labels.



3  Open the Measurement menu.

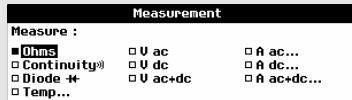

4  Highlight Ohms.

5  Select Ohms measurement.

The resistor value is displayed in ohms. Observe also that the bargraph is displayed. (See Figure 13.)

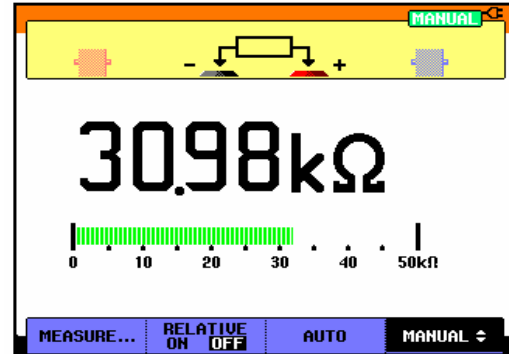

Figure 13. Resistor Value Readings

Making a Current Measurement

You can measure current in both Scope mode and Meter mode. Scope mode has the advantage of two waveforms being displayed while you perform measurements. Meter mode has the advantage of high measurement resolution.

The next example explains a typical current measurement in Meter mode.

Warning

Carefully read the instructions about the current probe you are using.

To set up the test tool, do the following:

- 1 Connect a current probe (e.g. i400, optional) from the 4-mm banana jack outputs to the conductor to be measured.

Ensure that the red and black probe connectors correspond to the red and black banana jack inputs. (See Figure 14.)
- 2  Display the METER key labels.



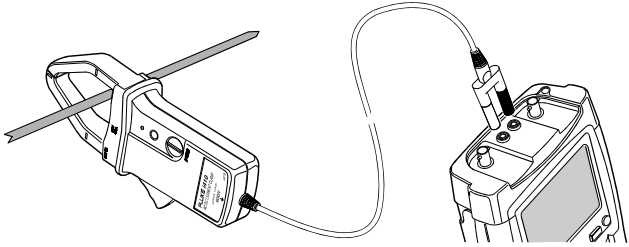







Figure 14. Measurement Setup

- 3  Open the **Measurement** menu.

Measurement		
Measure :		
<input checked="" type="checkbox"/> Ohms	<input type="checkbox"/> V ac	<input type="checkbox"/> A ac...
<input type="checkbox"/> Continuity®	<input type="checkbox"/> V dc	<input type="checkbox"/> A dc...
<input type="checkbox"/> Diode \leftarrow	<input type="checkbox"/> V ac+dc	<input type="checkbox"/> A ac+dc...
<input type="checkbox"/> Temp...		
- 4  Highlight **A ac....**
- 5  Open the **Current Probe** submenu.

Current Probe	
Sensitivity :	
<input type="checkbox"/> 100 μ V/A	<input type="checkbox"/> 400 mV/A
<input type="checkbox"/> 1 mV/A	<input type="checkbox"/> 1 V/A
<input checked="" type="checkbox"/> 10 mV/A	<input type="checkbox"/> 10 V/A
<input type="checkbox"/> 100 mV/A	<input type="checkbox"/> 100 V/A

- 6  Observe the sensitivity of the current probe. Highlight the corresponding sensitivity in the menu, e.g. **10 mV/A**.
- 7  Accept the current measurement.

Now, you will see a screen like in Figure 15

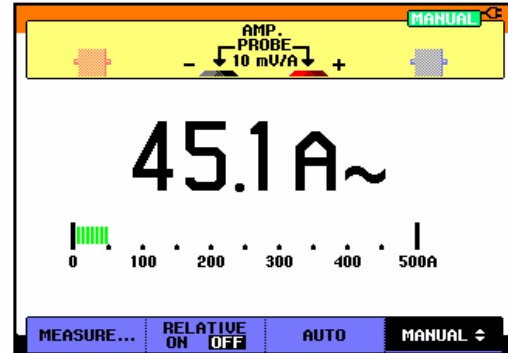



Figure 15. Ampere Measurement Readings

Freezing the Readings

You can freeze the displayed readings at any time.

- | | | |
|---|---|--|
| 1 |  | Freeze the screen. HOLD appears at the top right of the reading area. |
| 2 |  | Resume your measurement. |



You can use this function to hold accurate readings for later examination.

Note

For saving screens into memory, see Chapter 7.

Selecting Auto/Manual Ranges

To activate manual ranging, do the following during any Meter measurement:

- | | | |
|---|--|---------------------------------|
| 1 |  | Activate manual ranging. |
| 2 |  | Increase or decrease the range. |

Observe how the bargraph sensitivity changes.

Use manual ranging to set a fixed bargraph sensitivity and decimal point.



- | | | |
|---|--|----------------------------|
| 3 |  | Choose auto ranging again. |
|---|--|----------------------------|

When in auto ranging, the bargraph sensitivity and decimal point are automatically adjusted while checking different signals.

Making Relative Measurements

A relative measurement displays the present measurement result relative to a defined reference value.

The following example shows how to perform a relative voltage measurement. First obtain a reference value:

1		Display the METER key labels.
		
2		Measure a voltage to be used as reference value.
3		Set RELATIVE to ON. (ON is highlighted.)

This stores the reference value as reference for subsequent measurements. The stored reference value is displayed in small digits at the bottom right side of the screen after the word REFERENCE.

4		Measure the voltage to be compared to the reference.
---	--	--

Observe that the main reading is displayed as variations from the reference value. The actual reading with its bargraph is displayed beneath these readings. (See Figure 16.)

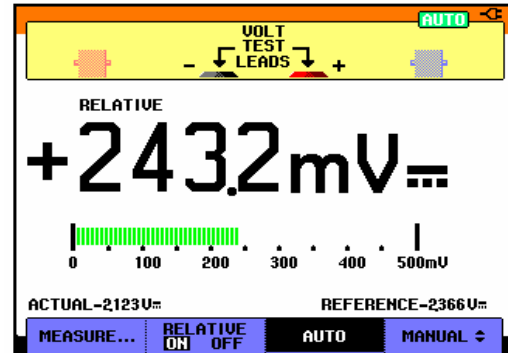

Figure 16. Making a Relative Measurement

You can use this feature when, for example, you need to monitor input activity (voltage, resistance, temperature) in relation to a known good value.

Chapter 3

Using The Recorder Functions

About this Chapter

This chapter provides a step-by-step introduction to the recorder functions of the test tool. The introduction gives examples to show how to use the menus and perform basic operations.

Opening the Recorder Main Menu

First choose a measurement in scope or meter mode. Now you can choose the recorder functions from the recorder main menu. To open the main menu, do the following:

1  Open the **RECORDER** main menu. (See Figure 17.)



Figure 17. Recorder Main Menu

Plotting Measurements Over Time (TrendPlot™)



Use the TrendPlot function to plot a graph of Scope or Meter measurements as function of time.

Note

Because the navigations for the dual input TrendPlot (Scope) and the single input TrendPlot (Meter) are identical, only TrendPlot (Scope) is explained in the next sections.

Starting a TrendPlot Function

To start plotting a graph of the reading over time, do the following:

- | | | |
|----------|--|--|
| 1 | | Apply a signal to the red BNC input A and turn on Reading 1 in scope mode |
| 2 |  | Open the RECORDER main menu. |
| 3 |  | Highlight Trend Plot (Scope) . |
| 4 |  | Start the TrendPlot recording. |

The test tool continuously records the digital readings of the input A measurements and displays these as a graph. The TrendPlot graph rolls from right to left like a paper chart recorder.

Observe that the recorded time from start appears at the bottom of the screen. The present reading appears on top of the screen. (See Figure 18.)

Note

When simultaneously TrendPlotting two readings, the screen area is split into two sections of four divisions each.

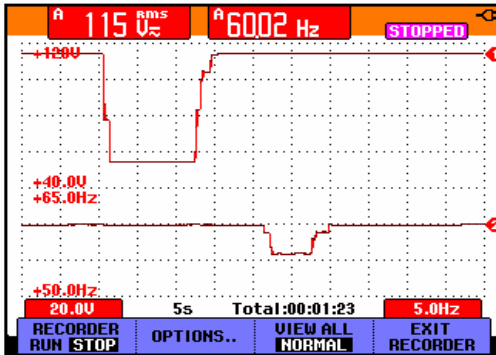

Figure 18. TrendPlot Reading

When the Scope is in automatic mode, automatic vertical scaling is used to fit the TrendPlot graph on the screen.

- 5 Set RECORDER to STOP to freeze the recorder function.
- 6 Set RECORDER to RUN to restart.

Displaying Recorded Data

When in normal view (**NORMAL**), only the twelve most recently recorded divisions are displayed on screen. All previous recordings are stored in memory.

VIEW ALL shows **all** data in memory:

- 7 Display an overview of the full waveform.

Press repeatedly to toggle between normal view (**NORMAL**) and overview (**VIEW ALL**)

When the recorder memory is full, an automatic compression algorithm is used to compress all samples into half of the memory without loss of transients. The other half of the recorder memory is free again to continue recording.



Changing the Recorder Options

At the right bottom of the display you can choose to display the time elapsed from start and the actual time of the day.

To change the time reference, proceed from step 6 as follows:

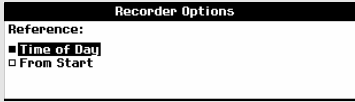
7  Open the **Recorder Options** menu.



8   Select **Time of Day** or **From Start**

Now the recorded time or the current time appear at the bottom of the screen.



Turning Off the TrendPlot Display

9  Exit the recorder function.

Recording Scope Waveforms In Deep Memory (Scope Record)

The **SCOPE RECORD** function is a roll mode that logs one or two long waveforms. This function can be used to monitor waveforms like motion control signals or the power-on event of an Uninterruptable Power Supply (UPS). During recording, fast transients are captured. Because of the deep memory, recording can be done for more than one day. This function is similar to the roll mode in many DSO's but has deeper memory and better functionality.

Starting a Scope Record Function

- 1 Apply a signal to the red BNC input A.
- 2  From the Recorder main menu, highlight **Scope Record**.
- 3  Start the recording.

The waveform moves across the screen from right to left like a normal chart recorder. (See Figure 19.)

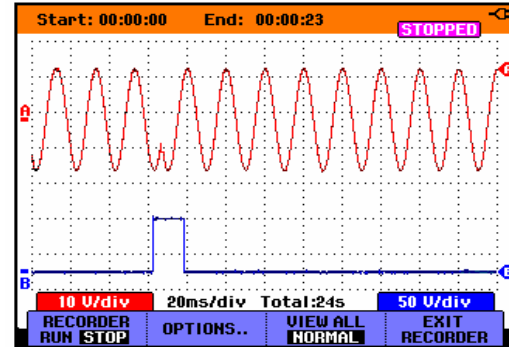

Figure 19. Recording Waveforms

Observe that the top of the screen displays the following:

- Time from start at the top of the screen.
- The status at the bottom of the screen which includes the time/div setting as well as the total timespan that fits the memory.

Note

For accurate recordings it is advised to let the instrument first warm up for five minutes.

Displaying Recorded Data

In Normal view, the samples that roll off the screen are stored in deep memory. When the memory is full, recording continues by shifting the data in memory and deleting the first samples out of memory.

In View All mode, the complete memory contents are displayed on the screen.

4  Press to toggle between **VIEW ALL** (overview of all recorded samples) and **NORMAL** view.

You can analyze the recorded waveforms using the Cursors and Zoom functions. See Chapter 4: “Using Replay, Zoom and Cursors”.

Using Scope Record in Single Sweep Mode



Use the recorder **Single Sweep** function to automatically stop recording when the deep memory is full.

Continue from step 3 of the previous section:

4  Open the **Recorder options** menu.

Recorder Options		
Reference:	Display	Mode:
<input checked="" type="checkbox"/> Time of Day	<input checked="" type="checkbox"/> Glitches:	<input checked="" type="checkbox"/> Single Sweep
<input type="checkbox"/> From Start	<input checked="" type="checkbox"/> Glitch On	<input type="checkbox"/> Continuous
	<input type="checkbox"/> 10 kHz	<input type="checkbox"/> on Ext. ...

5  (2x) Jump to the **Mode** field

6   Select **Single Sweep** and accept the recorder options.

Using External Triggering to Start or Stop Scope Record

To record an electrical event that causes a fault, it might be useful to start or stop recording on an external trigger signal:

Start on trigger to start recording; recording stops when the deep memory is full

Stop on trigger to stop recording.

Stop when untriggered to continue recording as long as a next trigger comes within 1 division in view all mode.

To set up the test tool, continue from step 3 of the previous section:

- 4 Apply the signal to be recorded to the red BNC input A. Apply a trigger signal to the red and black external trigger banana inputs. (See Figure 20.)

- 5  Open the **Recorder Options** menu.

Recorder Options		
Reference:	Display Glitches:	Mode:
<input checked="" type="checkbox"/> Time of Day	<input checked="" type="checkbox"/> Glitch On	<input checked="" type="checkbox"/> Single Sweep
<input type="checkbox"/> From Start	<input type="checkbox"/> 10 kHz	<input type="checkbox"/> Continuous
		<input type="checkbox"/> on Ext. ...

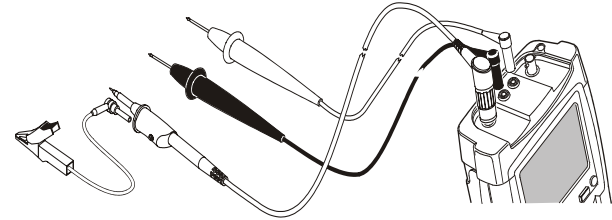







Figure 20. Scope Record Using External Triggering

- 6  Jump to **Display Glitches:**.

- 7  Jump to **Mode:**.

- 8  Select on **EXT. ...** to open the **Single Sweep on Ext.** menu.

Start Single Sweep on Ext.		
Conditions:	Slope:	Level:
<input checked="" type="checkbox"/> Start on trigger	<input checked="" type="checkbox"/> J	<input type="checkbox"/> 0.12 V
<input type="checkbox"/> Stop on trigger	<input type="checkbox"/> L	<input checked="" type="checkbox"/> 1.2 V
<input type="checkbox"/> Stop when untriggered		

- 9  Select one of the **Conditions:** and jump to **Slope:**.
- 10  Select the desired trigger slope, and jump to **Level:**.
- 11  Select the **0.12V** or **1.2 V** trigger level and accept all recorder options.

During recording samples are continuously saved in deep memory. The last twelve recorded divisions are displayed on the screen. Use View All to display the full memory contents.

Note

To learn more about the Single Shot trigger function, see Chapter 5 “Triggering on Waveforms”.

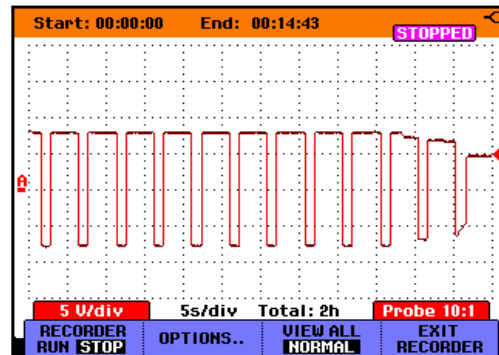

Figure 21. Triggered Single Sweep Recording

Analyzing a TrendPlot or Scope Record

From a Scope TrendPlot or Scope Record you can use the analysis functions CURSORS and ZOOM to perform detailed waveform analysis. These functions are described in Chapter 4: “Using Replay, Zoom and Cursors”.

Chapter 4

Using Replay, Zoom and Cursors

About this Chapter

This chapter covers the capabilities of the analysis functions **Cursor**, **Zoom**, and **Replay**. These functions can be used with one or more of the primary functions Scope, TrendPlot or Scope Record.

It is possible to combine two or three analysis functions. A typical application using these functions follows:

- First **replay** the last screens to find the screen of special interest.
- Then **zoom** in on the signal event.
- Finally, make measurements using the **cursors**.

Replaying the 100 Most Recent Scope Screens

When you are in scope mode, the test tool automatically stores the 100 most recent screens. When you press the **HOLD** key or the **REPLAY** key, the memory contents are frozen. Use the functions in the **REPLAY** menu to “go back in time” by stepping through the stored screens to find the screen of your interest. This feature lets you capture and view signals even if you did not press **HOLD**.

Replaying Step-by-Step

To step through the last scope screens, do the following:

- 1  From scope mode, open the **REPLAY** menu.



Observe that the trace is frozen and that **REPLAY** appears at the top of the screen (see Figure 22).

- 2  Step through the previous screens.

- 3  Step through the next screens.

Observe that the bottom of the waveform area displays the replay bar with a screen number and related time stamp:

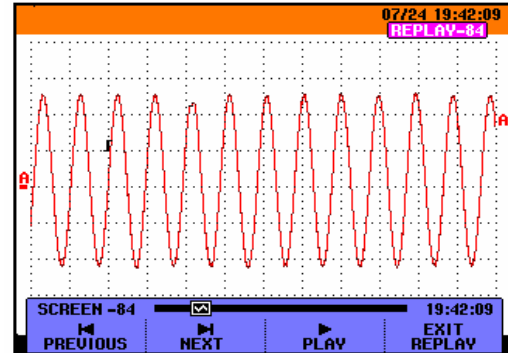



Figure 22. Replaying a Waveform



The replay bar represents all 100 stored screens in memory. The  icon represents the picture being displayed on the screen (in this example: SCREEN -84). If the bar is partly white, the memory is not completely filled with 100 screens.

From this point you can use the zoom and cursor functions to study the signal in more detail.

Replaying Continuously

You can also replay the stored screens continuously, like playing a video tape.

To replay continuously, do the following:

-  From Scope mode, open the **REPLAY** menu.

Observe that the trace is frozen and **REPLAY** appears at the top of the screen.
-  Continuously replay the stored screens in ascending order.

Wait until the screen with the signal event of interest appears.

-  Stop the continuous replay.

Turning Off the Replay Function

-  Turn off **REPLAY**.

Capturing 100 Intermittents Automatically

When you use the test tool in triggered mode, 100 *triggered* screens are captured. This way you could use Pulse Triggering to trigger and capture 100 intermittent glitches or you could use External Triggering to capture 100 UPS startups.





By combining the trigger possibilities with the capability of capturing 100 screens for later replay, you can leave the test tool unattended to capture intermittent signal anomalies.

For triggering, see Chapter 5: “*Triggering on Waveforms*”.

Zooming in on a Waveform

To obtain a more detailed view of a waveform, you can zoom in on a waveform using the **ZOOM** function.

To zoom in on a waveform, do the following:

-  Display the **ZOOM** key labels.

Observe that the trace is frozen, **ZOOM** appears at the top of the screen, and the waveform is magnified.
-  Enlarge (decrease the time/div) or shrink (increase the time/div) the waveform.
-  Scroll. A position bar displays the position of the zoomed part in relation to the total waveform.

Tip

Even when the key labels are not displayed at the bottom of the screen, you can still use the arrow keys to zoom in and out.

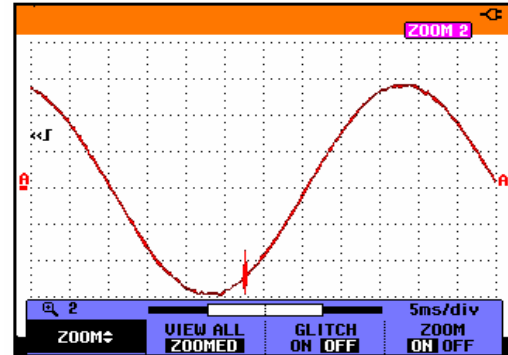



Figure 23. Zooming in a Waveform

Observe that the bottom of the waveform area displays the zoom ratio, position bar, and time/div (see Figure 23). The zoom range depends on the amount of data samples stored in memory.

From this point you can use the cursor function for further measurements on the waveform.

Displaying the Zoomed Waveform

The **VIEW ALL** feature is useful when you quickly need to see the complete waveform and then return to the zoomed part.

4  Display the complete waveform.

Press  repeatedly to toggle between the zoomed part of the waveform and the complete waveform.

Turning Off the Zoom Function

5  Turn off the **ZOOM** function.







Making Cursor Measurements

Cursors allow you to make precise digital measurements on waveforms. This can be done on live waveforms, recorded waveforms, and on saved waveforms.

Using Horizontal Cursors on a Waveform

To use the cursors for a voltage measurement, do the following:

- 1  From scope mode, display the cursor key labels.

CURSOR | II | F1 | MOVE | CURSOR | OFF
- 2  Press to highlight . Observe that two **horizontal** cursors are displayed.
- 3  Highlight the upper cursor.
- 4  Move the upper cursor to the desired position on the screen.
- 5  Highlight the lower cursor.
- 6  Move the lower cursor to the desired position on the screen.

Note

Even when the key labels are not displayed at the bottom of the screen, you still can use the arrow keys. This allows full control of both cursors while having full screen view.

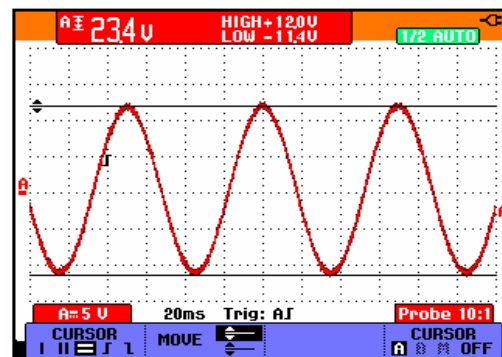



Figure 24. Voltage Measurement with Cursors







The screen shows the voltage difference between the two cursors and the voltage at the cursors. (See Figure 24.)

Use horizontal cursors to measure the amplitude, high or low value, or overshoot of a waveform.

Using Vertical Cursors on a Waveform

To use the cursors for a time measurement, or for an RMS measurement of the trace section between the cursors (C versions), do the following:

- 1  From scope mode, display the cursor key labels.

CURSOR
MOVE
READING
CURSOR
- 2  Press to highlight . Observe that two **vertical** cursors are displayed. Markers (–) identify the point where the cursors cross the waveform.
- 3  Choose for example time measurement: **READING T**.
- 4  If necessary, choose the trace: **TRACE A ,B, or M** (Mathematics).
- 5  Highlight the left cursor.
- 6  Move the left cursor to the desired position on the waveform.
- 7  Highlight the right cursor.

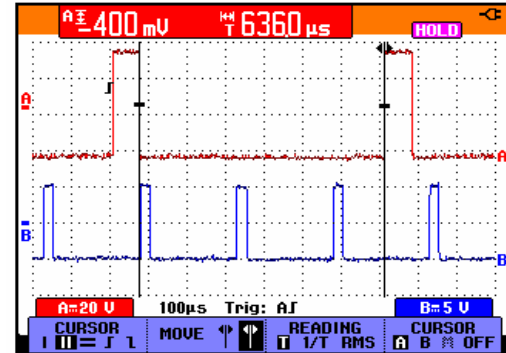



Figure 25. Time Measurement with Cursors

- 8  Move the right cursor to the desired position on the waveform.
- The screen shows the time difference between the cursors and the voltage difference between the two markers. (See Figure 25.)
- 9  Select **OFF** to turn off the cursors.

Using Cursors on a A+B, A-B or A*B Waveform

Cursor measurements on a A*B waveform give a reading in Watts if input A measures (milli)Volts and input B measures (milli)Amperes.

For other cursor measurements on a A+B, A-B or A*B waveform no reading will be available if the input A and input B measurement unit are different.

Using Cursors on Spectrum Measurements

To do a cursor measurement on a spectrum, do the following:

1



From Spectrum measurement display the cursor key label.



2









Move the cursor and observe the readings at the top of the screen.

Making Rise Time Measurements

To measure rise time, do the following:

- 1  From scope mode, display the cursor key labels.

CURSOR
MOVE
AUTO
CURSOR
- 2  Press to highlight  (rise time). Observe that two **horizontal** cursors are displayed.
- 3  For multiple traces select the required trace A, B, or M (if a math function is active).
- 4  Select MANUAL or AUTO (this automatically does steps 5 to 7).
- 5  Move the upper cursor to 100% of the trace height. A marker is shown at 90%.
- 6  Highlight the other cursor.

- 7  Move the lower cursor to 0% of the trace height. A marker is shown at 10%.

The reading shows the risetime from 10%-90% of the trace amplitude.

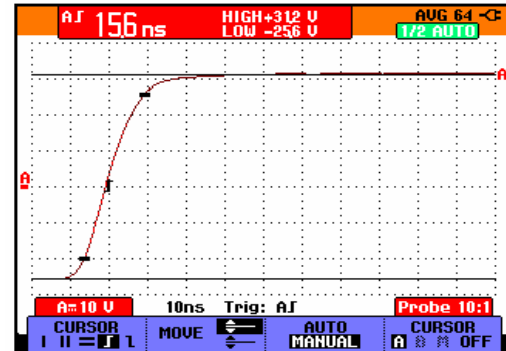

Figure 26. Rise time Measurement

Chapter 5

Triggering on Waveforms

About this Chapter

This chapter provides an introduction to the trigger functions of the test tool. Triggering tells the test tool when to begin displaying the waveform. You can use fully automatic triggering, take control of one or more main trigger functions (semi-automatic triggering), or you can use dedicated trigger functions to capture special waveforms.

Following are some typical trigger applications:

- Use the Connect-and-View™ function to have full automatic triggering and instant display of virtually any waveform.
- If the signal is unstable or has a very low frequency, you can control the trigger level, slope, and trigger delay for a better view of the signal. (See next section.)
- For dedicated applications, use one of the four manual trigger functions:
 - Edge triggering
 - External triggering
 - Video triggering
 - Pulse Width triggering

Setting Trigger Level and Slope

The Connect-and-View™ function enables hands-off triggering to display complex unknown signals.

When your test tool is in manual range, do the following:



Perform an auto set. **AUTO** appears at the top right of the screen.

Automatic triggering assures a stable display of virtually any signal.

From this point, you can take over the basic trigger controls such as level, slope and delay. To optimize trigger level and slope manually, do the following:

1



Display the **TRIGGER** key labels.

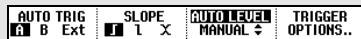

2



Trigger on either positive slope or negative slope of the chosen waveform.

Dual Slope Triggering (X):

19xC-2x5C versions can trigger on both positive slope and negative slope.

3



Enable the arrow keys for manual trigger level adjustment.

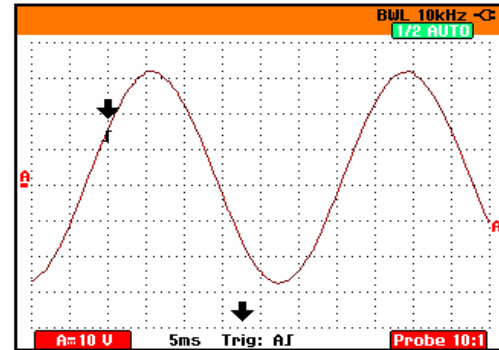

Figure 27. Screen with all Trigger Information

4



Adjust the trigger level.

Observe the trigger icon **┐** that indicates the trigger position, trigger level, and slope.

At the bottom of the screen the trigger parameters are displayed (See **Error! Reference source not found.**) . For example, **Trig : A┐** means that input A is used as the trigger source with a positive slope.

When no trigger is found, the trigger parameters appear in gray.

Using Trigger Delay or Pre-trigger

You can begin to display the waveform some time before or after the trigger point has been detected. Initially, you have 2 divisions of pre-trigger view (negative delay).

To set the trigger delay, do the following:

- 5**  Hold down to adjust the trigger delay.

Observe that the trigger icon **J** on the screen moves to show the new trigger position. When the trigger position moves left off of the screen, the trigger icon changes into **«J** to indicate that you have selected a trigger delay. Moving the trigger icon to the right on the display gives you a pre-trigger view.

In case of a trigger delay, the status at the bottom of the screen will change. For example:

AJ →500.0ms

This means that input A is used as the trigger source with a positive slope. The 500.0 ms indicates the (positive) delay between trigger point and waveform display.

When no trigger is found, the trigger parameters appear in gray.

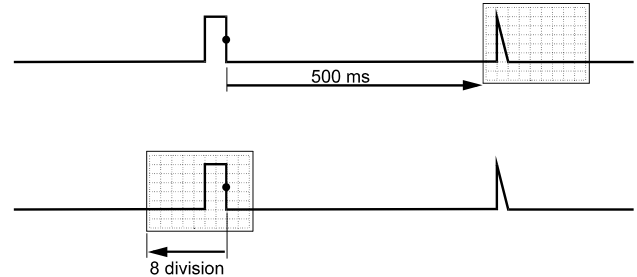



Figure 28. Trigger Delay or Pre-trigger View

Figure 28 shows an example of a trigger delay of 500 ms (top) and an example of pre-trigger view of 8 divisions (bottom).

Automatic Trigger Options

In the trigger menu, settings for automatic triggering can be changed as follows. (See also Chapter 1: “Displaying an Unknown Signal with Connect-and-View”)

- 1  Display the **TRIGGER** key labels.

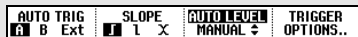

Note

The **TRIGGER** key labels can differ depending on the latest trigger function used.

- 2  Open the **Trigger Options** menu.



- 3  Open the **Automatic Trigger** menu.









If the frequency range of the automatic triggering is set to > 15 Hz, the Connect-and-View™ function responds more quickly. The response is quicker because the test tool is instructed not to analyze low frequency signal components. However, when you measure frequencies lower than 15 Hz, the test tool must be instructed to analyze low frequency components for automatic triggering:

- 4  Select **> 1 Hz** and return to the measurement screen.

Triggering on Edges

If the signal is instable or has a very low frequency, use edge triggering to obtain full manual trigger control.

To trigger on rising edges of the input A waveform, do the following:

- 1  Display the **TRIGGER** key labels.
 
- 2  Open the **Trigger Options** menu.
 
- 3  Open the **Trigger on Edge** menu.
 

When **Free Run** is selected, the test tool updates the screen even if there are no triggers. A trace always appears on the screen.

When **On Trigger** is selected, the test tool needs a trigger to display a waveform. Use this mode if you want to update the screen *only* when valid triggers occur.

When **Single Shot** is selected, the test tool waits for a trigger. After receiving a trigger, the waveform is displayed and the instruments is set to HOLD.

In most cases it is advised to use the Free Run mode:

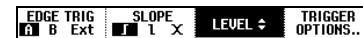

- 4  Select **Free Run**, jump to **Noise reject Filter**.
- 5  Set **Noise reject Filter** to **Off**.
- 6  Set **NCycle** to **Off**

Observe that the key labels at the bottom of the screen have adapted to allow further selection of specific edge trigger settings:



Triggering on Noisy Waveforms



To reduce jitter on the screen when triggering on noisy waveforms, you can use a noise rejection filter. Continue from step 3 of the previous example as follows:

- 4  Select **On Trigger**, jump to **Noise reject Filter**.
- 5  Set **Noise reject Filter** to **On**.

Observe that the trigger gap has increased. This is indicated by a taller trigger icon .

Making a Single Acquisition

To catch single events, you can perform a **single shot** acquisition (one-time screen update). To set up the test tool for a single shot of the input A waveform, continue from step 3 again:

- 4  Select **Single Shot**.
- 5  Accept the settings.

The word **WAITING** appears at the top of the screen indicating that the test tool is waiting for a trigger. As soon as the test tool receives a trigger, the waveform is displayed and the instrument is set to hold. This is indicated by the word **HOLD** at top of the screen.

The test tool will now have a screen like Figure 29.

- 6  Arm the test tool for a new single shot.

Tip

The test tool stores all single shots in the replay memory. Use the Replay function to look at all the stored single shots.

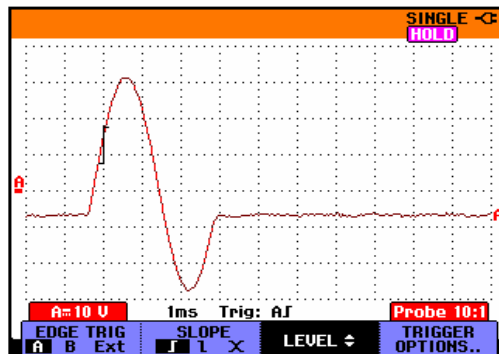





Figure 29. Making a Single Shot Measurement

N-Cycle Triggering

N-Cycle triggering enables you to create a stable picture of for example n-cycle burst waveforms.

Each next trigger is generated after the waveform has crossed the trigger level N times in the direction that complies with the selected trigger slope.

To select N-Cycle triggering, continue from step 3 again:

- 4  Select **On Trigger** or **Single Shot**, jump to **Noise reject Filter**.
- 5  Set **Noise reject Filter On** or **Off**.
- 6  Set **NCycle** to **On**

Observe that the key labels at the bottom of the screen have been changed to allow further selection of specific N-Cycle trigger settings:

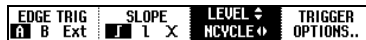

7  Set the number of cycles N

8  Adjust the trigger level

Traces with N-Cycle triggering (N=2) and without N-Cycle triggering are shown in Figure 30.

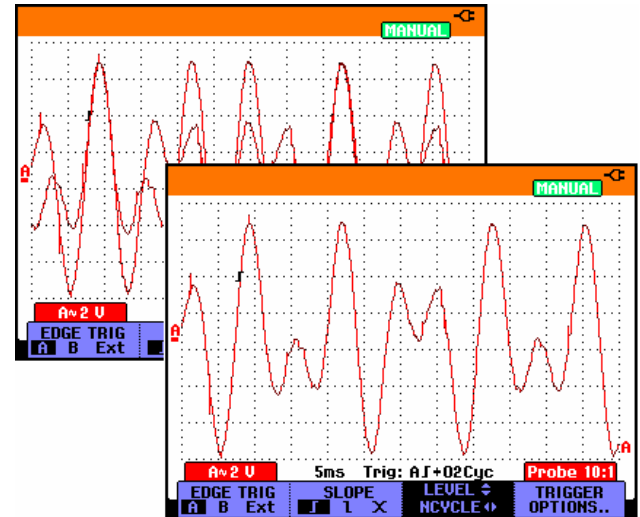



Figure 30. N-Cycle triggering

Triggering on External Waveforms

Use external triggering when you want to display waveforms on inputs A and B while triggering on a third signal. You can choose external triggering with automatic triggering or with edge triggering.

- 1 Supply a signal to the red **and** black 4-mm banana jack inputs. See Figure 31.

In this example you continue from the Trigger on Edges example. To choose the external signal as trigger source, continue as follows:

- 2  Display the **TRIGGER** (On Edges) key labels.

- 3  Select **Ext** (external) edge trigger.

Observe that the key labels at the bottom of the screen have been adapted to allow selection of two different external trigger levels: 0.12 V and 1.2 V:

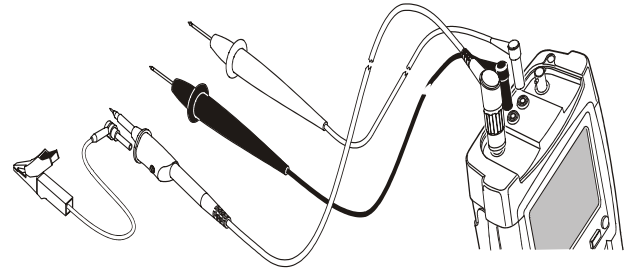



Figure 31. External Triggering

- 4  Select **1.2V** under the **Ext LEVEL** label.

From this point the trigger level is fixed and is compatible with logic signals.

Triggering on Video Signals

To trigger on a video signal, first select the standard of the video signal you are going to measure:

- 1 Apply a video signal to the red input A.
- 2  Display the TRIGGER key labels.

AUTO TRIG	SLOPE	AUTO LEVEL	TRIGGER
<input checked="" type="checkbox"/> B Ext	<input checked="" type="checkbox"/> L X	MANUAL	OPTIONS..
- 3  Open the Trigger Options menu.

Trigger Options	
Trigger:	
<input checked="" type="checkbox"/> Automatic...	
<input type="checkbox"/> On Edges...	
<input type="checkbox"/> Video on A...	
<input type="checkbox"/> Pulse Width on A...	
- 4  Select **Video on A ...** to open the Trigger on Video menu.

Trigger on Video	
Polarity:	
<input checked="" type="checkbox"/> Positive	<input checked="" type="checkbox"/> PAL
<input type="checkbox"/> Negative	<input type="checkbox"/> NTSC
	<input type="checkbox"/> PALPlus
	<input type="checkbox"/> SECAM
- 5  Select positive signal polarity for video signals with negative going sync pulses.

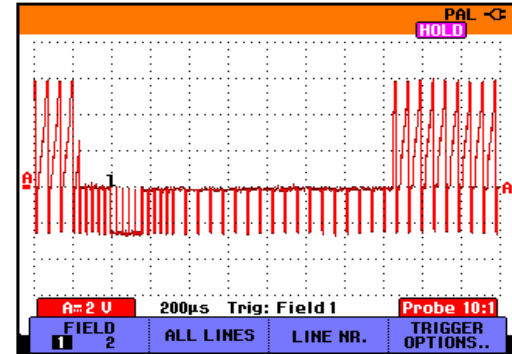



Figure 32. Measuring Interlaced Video Signals

- 6  Select the video standard and return.

Trigger level and slope are now fixed.

Observe that the key labels at the bottom of the screen have been changed to allow further selection of specific video trigger settings:



Triggering on Video Frames

Use **FIELD 1** or **FIELD 2** to trigger either on the first half of the frame (odd) or on the second half of the frame (even). To trigger on the second half of the frame, do the following:

7  Choose **FIELD 2**.

The signal part of the even field is displayed on the screen.

Triggering on Video Lines



Use **ALL LINES** to trigger on all line synchronization pulses (horizontal synchronization).

7  Choose **ALL LINES**.

The signal of one line is displayed on the screen. The screen is updated with the signal of the next line immediately after the test tool triggers on the horizontal synchronization pulse.

To view a specific video line in more detail, you can select the line number. For example, to measure on video line 123, continue from step 6 as follows:

7  Enable video line selection.

8   Select number 123.





The signal of line 123 is displayed on the screen. Observe that the status line now also shows the selected line number. The screen is continuously updated with the signal of line 123.





Triggering on Pulses

Use pulse width triggering to isolate and display specific pulses that you can qualify by time, such as glitches, missing pulses, bursts or signal dropouts.

Detecting Narrow Pulses

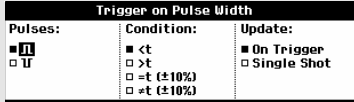
To set the test tool to trigger on narrow positive pulses shorter than 5 ms, do the following:



- 1 Apply a video signal to the red input A.
- 2  Display the **TRIGGER** key labels.

- 3  Open the **Trigger Options** menu.

- 4  Select **Pulse Width on A...** to open the **Trigger on Pulse Width** menu.

- 5  Select the positive pulse icon, then jump to **Condition**.
- 6  Select **<t**, then jump to **Update**.
- 7  Select **On Trigger**.

The test tool is now prepared to trigger on narrow pulses only. Observe that the trigger key labels at the bottom of the screen have been adapted to set the pulse conditions:



To set the pulse width to 5 ms, do the following:

- | | | |
|---|---|--|
| 7 |  | Enable the arrow keys to adjust the pulse width. |
| 8 |  | Select 5 ms. |

All narrow positive pulses shorter than 5 ms are now displayed on the screen. (See Figure 33.)

Tip

The test tool stores all triggered screens in the replay memory. For example, if you setup your triggering for glitches, you can capture 100 glitches with time stamps. Use the REPLAY key to look at all the stored glitches.

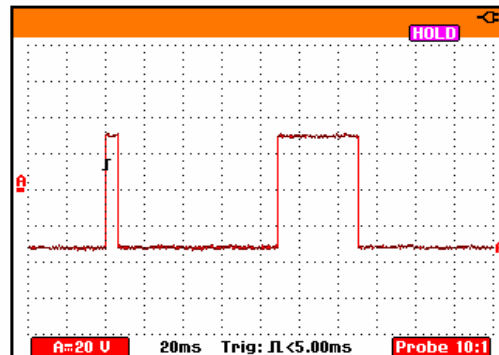



Figure 33. Triggering on Narrow Glitches

Finding Missing Pulses

The next example covers finding missing pulses in a train of positive pulses. In this example it is assumed that the pulses have a 100 ms distance between the rising edges. If the time accidentally increases to 200 ms, a pulse is missing. To set the test tool to trigger on such missing pulses, let it trigger on gaps bigger than about 150 ms. Do the following:

1  Display the **TRIGGER** key labels.

μ WIDTH 110ms	CONDITION >t <input checked="" type="checkbox"/> OFF	LEVEL	TRIGGER OPTIONS..
----------------------	---	-------	----------------------

2  Open the **Trigger Options** menu.

Trigger Options

Trigger:

- Automatic...
- On Edges...
- Video on A...
- Pulse Width on A...

3  Select **Pulse Width on A...** to open the **Trigger on Pulse Width** menu.

Trigger on Pulse Width

Pulses:	Condition:	Update:
<input checked="" type="checkbox"/> \uparrow	<input checked="" type="checkbox"/> ct	<input checked="" type="checkbox"/> On Trigger
<input type="checkbox"/> \downarrow	<input type="checkbox"/> >t	<input type="checkbox"/> Single Shot
	<input type="checkbox"/> =t ($\pm 10\%$)	
	<input type="checkbox"/> +t ($\pm 10\%$)	

4  Select the positive pulse icon to trigger on the gap between the positive pulses, then jump to **Condition**.



5  Select **>t**, then jump to **Update**.

6  Select **On Trigger**.

The test tool is now prepared to trigger on pulse gaps. Observe that the trigger menu at the bottom of the screen has been adapted to set the pulse condition:

μ WIDTH 110ms	CONDITION >t <input checked="" type="checkbox"/> OFF	LEVEL	TRIGGER OPTIONS..
----------------------	---	-------	----------------------

To set the pulse width to 150 ms, continue as follows:

- | | | |
|---|---|--|
| 7 |  | Enable the arrow keys to adjust the pulse width. |
| 8 |  | Select 150 ms. |

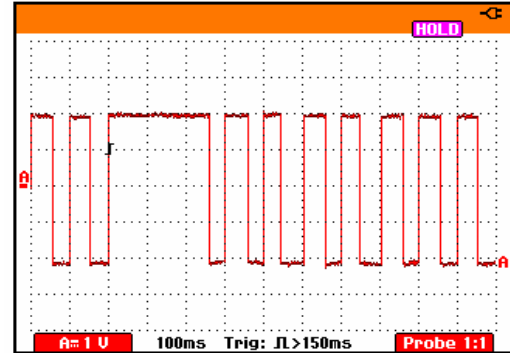

Figure 34. Triggering on Missing Pulses

Chapter 6

Using The Bushealth Function

About this Chapter

This chapter provides a step-by-step introduction to the Bushealth function of the test tool. For extended information on Fieldbuses and fieldbus measurement please consult Appendix A of this manual.

Bushealth Function Availability

The Bushealth function is available in the models Fluke 215C and Fluke 225C.

Introduction

Fieldbuses are bi-directional, digital, serial control networks used in process control and industrial automation.

The test tool bushealth function indicates the status of the following aspects of the OSI model Physical Layer:

- Voltage levels (bias, high level, low level)
- Bit width – baud rate
- Rise and fall time
- Distortion

Moreover the test tool can show the bus signal waveform in the Eye-pattern mode, see Figure 46.

The bushealth measurement is based upon the test tool Scope mode. The test tool selects settings that are optimized to the signal characteristics of the selected bus type. It operates in full automatic (ranging and triggering) mode.

Test limits are preset, but can be changed, see page 81.

For supported bus types and protocols see Chapter 10, Specifications, section 'Fieldbus Measurements'.

Note

You can perform resistance measurements using the Meter mode to check a suspected cable or bus termination.





Performing Bushealth Measurements



Caution

Fieldbuses often are controlling delicate processes that must not be disturbed. It is strongly recommended to contact the system manager before any connections are made!

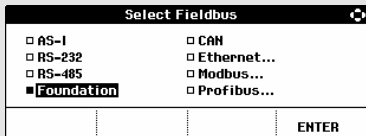
Selecting the bus type

To select the fieldbus type do the following:

1		Open the bushealth/fieldbus main selection screen.
2		Highlight Bushealth .
3		Open the Select Fieldbus menu:
		
4		Select the bus type.

- 5  Accept your choice.
For bus types followed by 3 dots ... a new menu will open:
Select the required item and press .

The test tool starts measuring now. You will see a screen like Figure 35.

Each bus type has a default probe setting (e.g. 10:1). If the probe setting before selecting the fieldbus type was different from this default probe setting, the probe menu is shown with the default setting highlighted. To accept the default setting press . You can also select another probe type now using the arrow keys.



- 6 Connect the inputs as indicated in section Input Connections and Tested Signals on page 70

Tip

Press  (*WIRING INFO*) to get information on measurement connections.





Starting and Stopping Measuring

Measuring starts immediately after you selected a bus type. The test tool now continuously monitors the bus signal and shows the signal properties. Measured minimum and maximum values (the extremes) will be stored and displayed from now on. To clear these values you can stop and start measuring as follows:

- 1  Press to stop measuring. The screen is frozen now. Press again to start a new measurement
- 2  Press to clear the screen and start measuring again.

Selecting a probe type

To select another probe type, do the following:

- 1   Select the input A or B key labels.
- 2  Open the **Probe On A (B)** menu
- 3  Select and accept () the required probe attenuation.

Reading the Screen

The bus test screen (see the example Figure 35) shows the status of the various signal properties.

Information is represented in five columns:

- A. signal property that is being tested, for example **V-Level Bias**. See page 70 for a description of the tested signal properties for each bus.
- B. status indicator, for example . See Table 1 for a description of the indicators.
- C. most recent measurement value, for example **3.5**.
--- indicates that no reading is available
OL indicates that the signal is out of the measurement range (overload)
- D. **Min Max** : the lowest and highest measured value
- E. **Limit**: used low (left) and high (right) test limits, for example **18.5 31.6V**.
LIMIT * the * indicates that one or more of the limits are not set to the default value!
N/A indicates that limit does Not Apply to this bus type.

The F1...F4 function key labels are explained in Table 2.

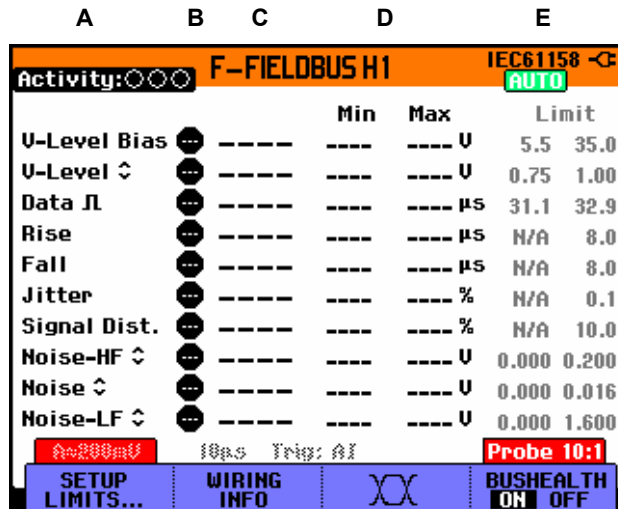

Figure 35. Field Bus Test Screen Example

Table 1. Bus Test Screen Indicators





○ ○ ○	Activity: ○ ○ ○ : bus activity indicators.
1 ○ ○ ○	Bus activity indicator 1: ● (filled) : voltage measured ○ (open) : no voltage measured
2 3 ○ ○ ○	Bus activity indicators 2 and 3: ○ ○ (both open) : no activity * * (blinking) : activity
	Busy, the test tool is measuring/processing data.
	No reading available.
	Test OK. Measurement results are within 80% of allowable range, see Figure 36.
	Warning. Measurement results are between 80% and 100% of allowable range, see Figure 36
	Test failed. Measurement results are out of allowable range, see Figure 36.

Figure 36 shows the bus health indicator boundaries.

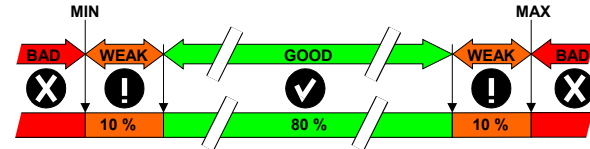

Figure 36. Bus Health Indicator Boundaries

Example:

the high level voltage of a bus must be between +3.0 V (MIN) and +15.0 V (MAX). Depending on the measurement result the displayed indicator will be:



-  If the result is between 4.2 and 13.8V. (10% of 12 V = 1.2 V)
-  If the result is between 3 V and 4.2 V, or between 13.8 V and 15 V.
-  If the result is <math>< 3 V</math> or $> 15 V$.

Table 2. F1...F4 Key Functions

	Select the Limit Setup function, see page 81.
	Shows how to connect the test tool to the bus.
	Select the Eye-pattern screen mode, see Viewing the Bus Waveform Screen on page 79.
	Turn fieldbus test function ON/OFF.

Input Connections and Tested Signals

This section provides a short description of the required bus connection and the measured signal properties.

See Appendix A for detailed information.

For correct measurements you should calibrate your probe to match its characteristics to the test tool. A poorly calibrated probe can introduce measurement errors. See Chapter 9, section ‘Calibrating the Voltage Probes’ for calibration instructions.

Data Traffic

In some bus systems (AS-i for instance) the protocol uses continuous polling of all devices in a fixed time schedule so that there is continuous data traffic. Other systems such as RS-232 only carry data when communication is required. Bushealth requires continuous data traffic to perform its measurements. In case of very low data repetition rates, the banner ‘NO DATA’ is displayed. In systems with low data rates, it is recommended to increase the data rate by e.g. knob operation. Contact the system manager for this.

AS-i Bus

Default probe setting 10:1. Use the Fluke 10:1 probe.

- 1 Connect the red probe to test tool input A
- 2 Connect the probe ground lead to the AS-i bus -
- 3 Connect the probe tip to the AS-i bus +

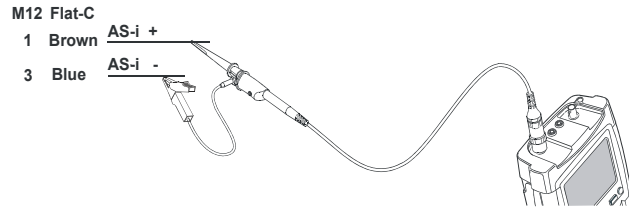

Figure 37. AS-i Bus Measurement Connections

Table 3. AS-i Bus Tested Signal Properties

Signal	Description
V-Level Bias	Bias voltage
V-Level ↕	Peak-Peak voltage

Note

The bus normally has continuous data traffic.

CAN Bus

Default probe setting 10:1. Use the Fluke 10:1 probes.

- 1** Connect the red probe to the test tool input A, connect the grey probe to input B.
- 2** Connect the ground lead of the input A probe to the CAN bus High (CAN_H)
- 3** Connect the probe tip of the input A probe to the CAN bus Low (CAN_L)
- 4** Connect the ground lead of the input B probe to the CAN bus ground (CAN_GND)
- 5** Connect the probe tip of the input B probe to the CAN bus high (CAN_H)

Note

The bus normally has continuous data traffic.

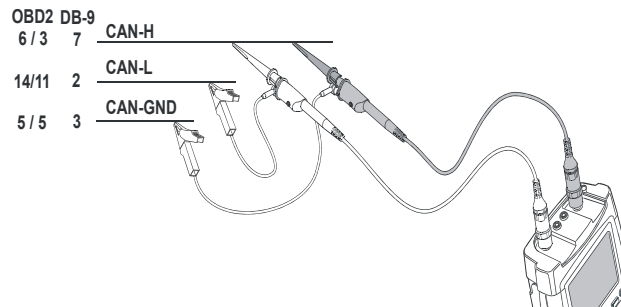

Figure 38. CAN Bus Measurement Connections

Table 4. CAN Bus Tested Signal Properties

Signal	Description
CAN Dom. H-L	Dominant high to low level voltage
CAN Rec. H-L	Recessive high to low level voltage
CAN-Level	Common mode voltage
Data \square	Bit width
Rise	Rise time as % of bit width
Fall	Fall time as % of bit width
Jitter	Jitter distortion
Overshoot	Overshoot distortion

RS-232 Bus & Modbus IEA-232/RS-232

Default probe setting 10:1. Use the Fluke 10:1 probe.

- 1** Connect the red probe to the test tool input A.
- 2** Connect the probe ground lead to the RS-232 bus Signal Ground.
- 3** Connect the probe tip to the RS-232 bus TxD or RxD.

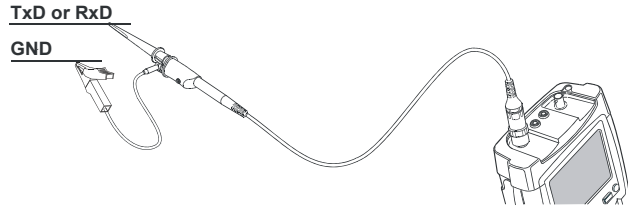

Figure 39. RS-232 Bus Measurement Connections

Table 5. RS-232 Bus Tested Signal Properties

Signal	Description
V-Level High	High level voltage
V-Level Low	Low level voltage
Data \square	Bit width
Rise	Rise time as % of bit width
Fall	Fall time as % of bit width
Jitter	Jitter distortion
Overshoot	Overshoot distortion

Note

Continuous data traffic is not ensured . See Data Traffic on page 70

RS-485 Bus & MOD Bus IEA-485/RS-485

Default probe setting 10:1. Use the Fluke 10:1 probes.

- 1 Connect the red probe to the test tool input A and the grey probe to input B.
- 2 Connect the ground lead of the input A probe to the RS-485 bus RxD/TxD N (-)
- 3 Connect the ground lead of the input B probe to the RS-485 bus cable shield.
- 4 Connect the probe tip of both probes to the RS-485 bus RxD/TxD P (+)

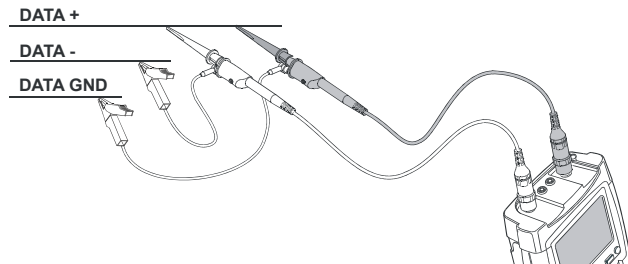

Figure 40. RS-485 Bus Measurement Connections

Table 6. RS-485 Bus Tested Signal Properties

Signal	Description
V-Offset	High level voltage
V-Level ↕	Peak-peak voltage
Data □	Bit width
Rise	Rise time as % of bit width
Fall	Fall time as % of bit width
Jitter	Jitter distortion
Signal Dist.	Signal distortion (Manchester decoding, default setting)
Overshoot	Overshoot (NRZ decoding, can be selected via limit setup)

Note

Continuous data traffic is not ensured . See Data Traffic on page 70

Foundation H1 Bus

Default probe setting 10:1. Use the Fluke 10:1 probe.

- 1** Connect the red probe to test tool input A
- 2** Connect the probe ground lead to the H1 bus +
- 3** Connect the probe tip to the H1 bus -

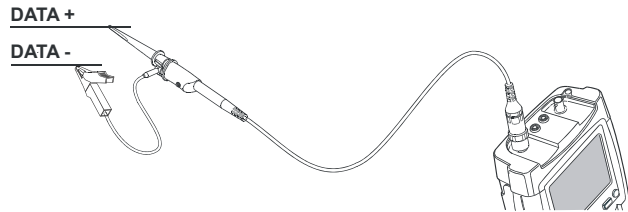

Figure 41. Foundation H1 Bus Measurement Connections

Table 7. Foundation H1 Bus Tested Signal Properties

Signal	Description
V-Level Bias	Bias voltage level
V-Level ↕	Peak-peak voltage
Data □	Bit width
Rise	Rise time as % of bit width
Fall	Fall time as % of bit width
Jitter	Jitter distortion
Signal Dist.	Signal distortion
Noise-HF ↕	High Frequency noise >39.1 kHz
Noise ↕	Mid Frequency noise 7.839.1 kHz
Noise-LF ↕	Low Frequency noise < 7.8 kHz

Note

The bus normally has continuous data traffic.

Profibus PA/31.25 kBit/s

Default probe setting 10:1. Use the Fluke 10:1 probe.

- 1 Connect the red probe to test tool input A
- 2 Connect the probe ground lead to the PA bus -
- 3 Connect the probe tip to the PA bus +

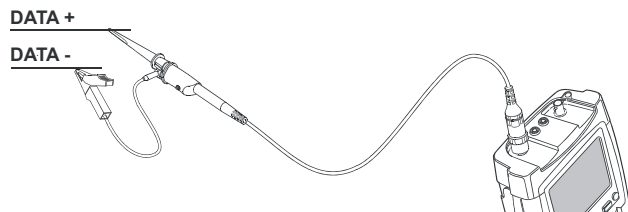

Figure 42. Profibus PA Measurement Connections

Warning

Profibus PA is optimized for process control with focus on explosion safety.

When planning tests on this bus type, make sure the proper safety rules are adhered to!

Table 8. Profibus PA Tested Signal Properties

Signal	Description
V-Level Bias	Bias voltage level
V-Level \Updownarrow	Peak-peak voltage
Data \square	Bit width
Rise	Rise time as % of bit width
Fall	Fall time as % of bit width
Jitter	Jitter distortion
Signal Dist.	Signal distortion
Noise-HF \Updownarrow	High Frequency noise >39.1 kHz
Noise \Updownarrow	Mid Frequency noise 7.8 -39.1 kHz
Noise-LF \Updownarrow	Low Frequency noise < 7.8 kHz

Note

The bus normally has continuous data traffic.

Profibus DP/RS-485

Default probe setting 10:1. Use the Fluke 10:1 probes.

- 1** Connect the red probe to the test tool input A and the grey probe to input B.
- 2** Connect the ground lead of the input A probe to the DP bus RxD/TxD N (-)
- 3** Connect the ground lead of the input B probe to the DP bus cable shield.
- 4** Connect the probe tip of both probes to the DP bus RxD/TxD P (+)

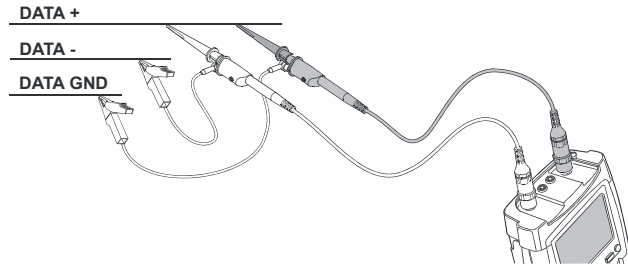





Figure 43. Profibus DP Measurement Connections

Table 9. Profibus DP Tested Signal Properties

Signal	Description
V-Offset	V offset 
V-Level 	Peak-peak voltage
Data 	Bit width
Rise	Rise time as % of bit width
Fall	Fall time as % of bit width
Jitter	Jitter distortion
Signal Dist.	Signal distortion (Manchester decoding, default setting)
Overshoot	Overshoot (NRZ decoding, can be selected via limit setup)

Note
 The bus normally has continuous data traffic.

Ethernet Coax/10Base2

Default probe setting 1:1. Use the Fluke 1:1 probes.

- 1 Connect a male BNC to dual female BNC adapter (Fluke PM9093) to input A.
- 2 Connect the Ethernet bus as shown below, using an additional coax cable.

Caution

The Ethernet cabling may be interrupted for only a few seconds during normal process operation!

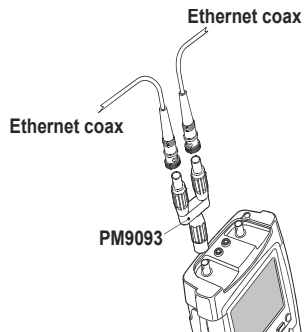

Figure 44. Ethernet Bus Measurement Connections

Table 10. Ethernet Coax Bus Tested Signal Properties

Signal	Description
V-Level High	Voltage level high
V-Level Low	Voltage level low
Data \square	Bit width
Rise	Rise time as % of bit width
Fall	Fall time as % of bit width
Jitter	Jitter distortion
Signal Dist.	Signal distortion

Note

Normally the Ethernet bus has continuous data traffic. Incidentally the bus may have no continuous data traffic. See Data Traffic on page 70.

Ethernet Twisted Pair/10BaseT/100BaseT

Default probe setting 10:1. Use the Fluke 10:1 probe.

- 1 Connect the red probe to test tool input A
- 2 Connect the probe ground lead to the bus TD+ (RD+)
- 3 Connect the probe tip to the bus TD- (RD-)

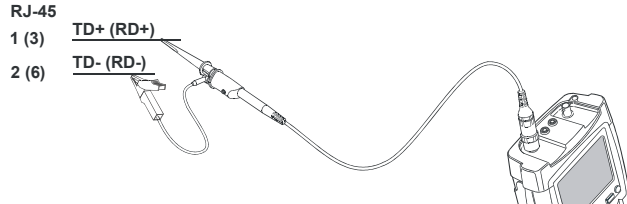

Figure 45. Ethernet Twisted Pair Measurement Connections

Note



Normally the Ethernet bus has continuous data traffic. Incidentally the bus may have no continuous data traffic. See Data Traffic on page 70.

Table 11. Ethernet Twisted Pair Tested Signal Properties

Signal	Description
V-Level ↕	Peak-Peak voltage
Data ▭	Bit width
Rise	Rise time as % of bit width
Fall	Fall time as % of bit width
Jitter	Jitter distortion
Signal Dist.	Signal distortion



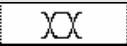

Viewing the Bus Waveform Screen

To view the waveform eye pattern of the bus voltage, do the following:

1  In the main screen select eye pattern mode. You will see a screen like Figure 46.

The screen shows the waveforms of one bit time triggered on a positive as well as on a negative edge in persistence mode.

2  Clear the persisted waveforms and restart showing the waveform.

3  Open the **Persistence** menu.

  Select **Digital Persistence: Short, Medium, Long or Infinite** to observe dynamic waveforms .
 Select **Dot-join: On or Off** to choose your personal preference for the waveform representation.

4  Return to the test screen.

5  Exit the Bushealth mode and enter the Scope/Meter mode.

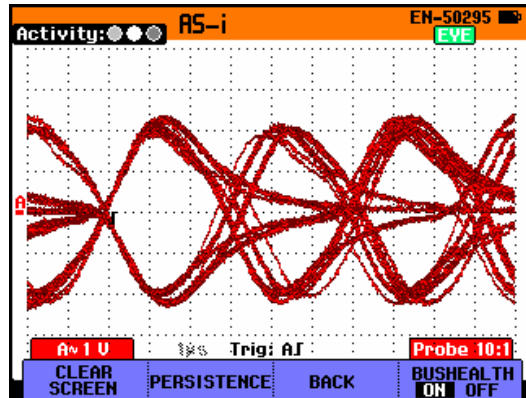







Figure 46. Eye Pattern Screen

Notes

- Press  to freeze the screen. Pressing  again will clear the persistence waveform and restart showing the waveform eye pattern.

- When saving a screen the most recently acquired waveform will be stored. Persistence waveforms will not be stored.

Setting the Test Limits



You can change the test limits used to generate the messages OK , WARNING , and NOT OK .

The test limits apply to the selected bus type. To select a bus type do steps 1-5 on page 66.

To change the test limits of the selected bus, do the following:



-  From the bus test screen open the **SETUP LIMITS** menu. You will see a screen like Figure 47.

The header does not show the bus type. To see the bus type when you are changing the limits press the **CLEAR MENU** key. Press this key again to return to the setup limits screen.

-  Select the signal property for which you want to set the limit.
-  Select the level to be adjusted: **LOW** (low level), **HIGH** (high level) or **WARNING !** (warning level)
-  Change the limits.

A * before a line in the **SETUP LIMITS** screen indicates that a signal property in that line has limits that differ from the default setting.

Press  **N/A** if a limit should not be involved in the test.

Press  **DEFAULTS** to set all limits to the default values.
-  Accept the limits and return to the test screen.

In the test screen the word **LIMIT** will be followed by a * if any of the limits has not the default value.

Note

Changed limits will persist until:

- you change them again,
- you reset the test tool; resetting will restore the default limits.

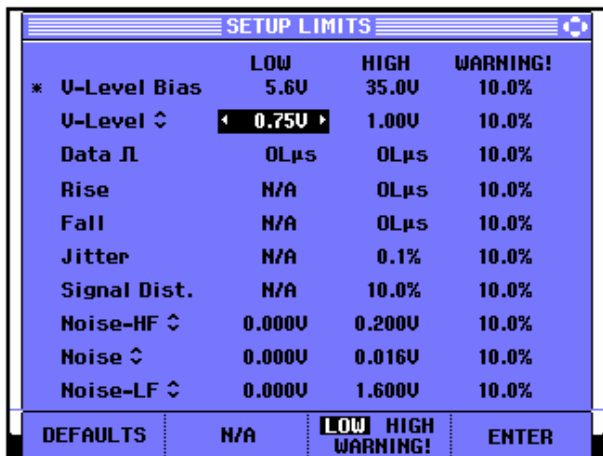

	LOW	HIGH	WARNING!
* U-Level Bias	5.6V	35.0V	10.0%
U-Level ↕	0.75V	1.00V	10.0%
Data Ω	0L μ s	0L μ s	10.0%
Rise	N/A	0L μ s	10.0%
Fall	N/A	0L μ s	10.0%
Jitter	N/A	0.1%	10.0%
Signal Dist.	N/A	10.0%	10.0%
Noise-HF ↕	0.000V	0.200V	10.0%
Noise ↕	0.000V	0.016V	10.0%
Noise-LF ↕	0.000V	1.600V	10.0%
DEFAULTS	N/A	LOW HIGH WARNING!	ENTER

Figure 47. Setup Limits Menu Screen

Saving and Recalling Test Limits

You can save a screen, plus the test setup with (adjusted) test limits, plus the most recent eye pattern trace as a new dataset. By recalling this dataset you can do a bus test according to your own pre-defined test limits.

Refer to chapter 7 'Saving and Recalling Datasets'.

Chapter 7

Using Memory, PC and Printer

About this Chapter

This chapter provides a step-by-step introduction to the general functions of the test tool that can be used in the three main modes: Scope, Meter, or Recorder. You will find information on printer and computer communication at the end of this chapter.

Saving and Recalling

You can:

- Save screens and setups to memory, and recall them again from memory. The test tool has 15 'screen and setup' memories and 2 'record and setup' memories.
- Name saved screens and setups according to your own preferences.
- Recall screens and recordings to analyze or print the screen image at a later date.
- Recall a setup to continue a measurement with the recalled operating configuration.

Saving Screens with Associated Setups

To save for example a screen+setup in Scope mode, do the following:

1  Display the **SAVE/PRINT** key labels.

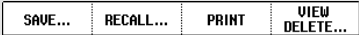

SAVE...	RECALL...	PRINT	VIEW DELETE...
---------	-----------	-------	----------------

From this point the screen is frozen until you hide the **SAVE/PRINT** key labels again.

2  Open the **Save** menu.





Save		
Save:	Available	Used
Screen + Setup	14	1
Replay + Setup	2	0
CANCEL		ENTER

Observe the number of available and used memory locations.

In METER mode the Edit Name menu will be shown now as only a setup+screen can be saved.

3   Highlight **Screen+Setup** .

4  Open the **Edit Name** menu. This menu enables you to name the saved screen+setup (**Save as:**)



Edit Name	
Save as:	abcdefghijklmnop
DCOPE 8	qrstuvwxyzABCDEF
01/03/07 00:59:11	GHIJKLMNOPQRSTUW
	XYZ0123456789?!.
	+ - @ # \$ % & : _ SPACE
DEFAULT NAME	
PREV ←	→ NEXT
	SAVE

If no free memory locations are available a message pops up that proposes to you to overwrite the oldest data set.

Do one of the following:



If you don't want to overwrite the oldest data set,



- press , then delete one or more memory locations, and save again.

If you want to overwrite the oldest data set,



- press  and continue at step 4.

To name the screen+setup according to your own preferences, do the following:

5   Skip to a new character position.

- 6  Select another character.
Repeat 5 and 6 until done.
- 7  Save the actual screen.

To use the default name generated by the test tool, continue from step 4 as follows:

- 5  Use default name.
- 6  Save the actual screen.

Notes

The two record+setup memory locations store more than what is just visible on the screen. In TrendPlot or scope record mode the full recording is saved. In scope mode you can save all 100 replay screens in a single record+setup memory location. The table below shows what you can store for the various test tool modes.





To save a Trendplot press STOP first.

Mode	Memory locations	
	15x 'screen+setup'	2x 'record+setup'
METER	setup+1screen	N/A
SCOPE	setup+1screen	setup+100 replay screens
SCOPE REC	setup	setup+record data
TRENDPLOT	setup	setup+trendplot data
BUSHEALTH	setup+1 screen *)	N/A

**) in eye pattern mode and persistence mode the most recently written trace will be saved, not all persistence traces.*

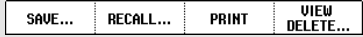



Deleting Screens with Associated Setups

To delete a screen and associated setup, do the following:

- 1  Display the **SAVE/PRINT** key labels.

- 2  Open the **View/Delete** menu.
- 3  Highlight a screen+setup
- 4  Delete the saved screen+setup.



Recalling Screens with Associated Setups

To recall a screen+setup, do the following:

1		Display the SAVE/PRINT key labels.
		
2		Open the Recall menu.
3		Highlight a screen+setup.
4		Recall the saved screen+setup.





Observe that the recalled waveform is displayed and that **HOLD** appears on the screen. From this point you can use cursors and zoom for analysis or you can print the recalled screen.

To recall a screen as a reference waveform to compare it with an actually measured waveform, continue from step 3 as follows:

4		Use RECALL FOR REFERENCE to recall the saved screen.
5		Resume the measurement. Both, the reference screen and the measurement screen will be displayed.

Recalling a Setup Configuration







To recall a setup configuration, do the following:

1		Display the SAVE/PRINT key labels.
		
2		Open the Recall menu.
3		Highlight a screen+setup.
4		Recall the saved setup.

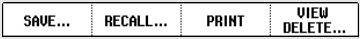
Observe that **RUN** appears at the top right of the screen. From this point you continue in the new operating configuration.

Viewing Stored Screens

To scroll through the memories while looking at the stored screens, do the following:







1		Display the SAVE/PRINT key labels.
		
2		Open the View/Delete menu.
3		Highlight a screen+setup location..
4		View the screen, and open the viewer.
		
5		Scroll through all stored screens.
6		Exit the View mode.

Note:

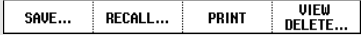

The replay stores (max. 2) cannot be viewed!

Renaming Stored Screens

To modify the name of stored screens, do the following:

1		Display the SAVE/PRINT key labels.
		
2		Open the View/Delete menu.
3		Highlight a screen+setup location.
4		Open the Rename menu.
5		Skip to a new character position.
6		Select another character. Repeat 5 and 6 until done.
7		Save the new name.

To select a default name generated by the test tool, continue from step 4 as follows:

5		Generate the default name.
6		Save the new name.

Documenting Screens

With the FlukeView[®] software you can upload waveform data and screen bitmaps to your PC or notebook computer for further processing. Printing can also be done by connecting the test tool directly to a printer.

Connecting to a Computer

To connect the test tool to a PC or notebook computer and use the FlukeView software for Windows[®] (SW90W), do the following:

- Use the Optically Isolated Adapter/Cable (USB: OC4USB; RS-232: PM9080) to connect a computer to the OPTICAL PORT of the test tool. (See Figure 48.)

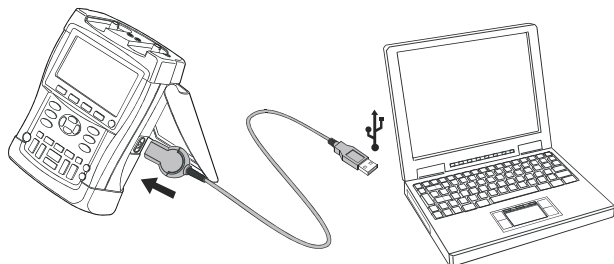

Figure 48. Connecting a Computer

Note

For information about installing and using the FlukeView ScopeMeter software, see the SW90W Users Manual.

A Software & Cable Carrying Case Kit is optionally available as model number SCC190.

Connecting to a Printer

To print a screen directly to a printer, use one of the following adapters:

- The Optically Isolated RS-232 Adapter/Cable (PM9080, optional) to connect a serial printer to the OPTICAL PORT of the test tool. (See Figure 49.)
- The Print Adapter Cable (PAC91, optional) to connect a parallel printer to the OPTICAL PORT of the test tool. (See Figure 50.)

Before printing, you must setup the test tool for a specific printer.

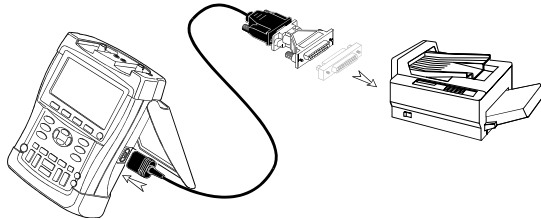

Figure 49. Connecting a Serial Printer

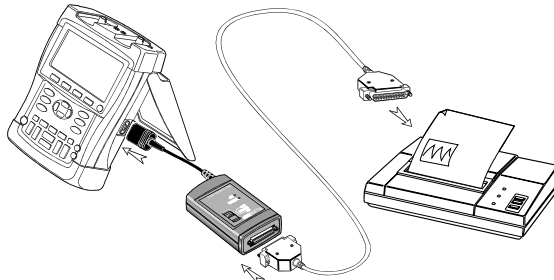

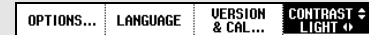



Figure 50. Connecting a Parallel Printer

Setting up the Printing Configuration

This example demonstrates how to set up the test tool for printing on a postscript printer with a 9600 baud rate:

- 1  Display the **USER OPTIONS** key labels.



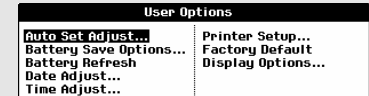

- 2  Open the **User Options** menu.

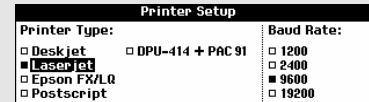

- 3  Open the **Printer Setup** submenu.



- 4  Select **Postscript** and jump to **Baud Rate**.



- 5  Select a baud rate of 9600 and return to normal mode.

Whenever possible, choose the option Postscript when printing screens. This option gives the best printing results. Consult the manual that came with your printer to find out whether it has Postscript printing possibilities.

To connect the SII (Seiko Instruments Inc.) DPU-414 thermal printer you must use the printer adapter cable PAC91. (See Figure 50)

Printing a Screen

To print the currently displayed screen, do the following:

- 1**  Clear the menu if you do not want to print it.
- 2**  Display the **SAVE/PRINT** key labels.
- 3**  Start printing.

A message appears at the bottom of the screen indicating that the test tool is busy printing.

Screens will be printed in black and white.

Chapter 8

Tips

About this Chapter

This chapter gives you information and tips on how you can make the best use of the test tool.

Using the Standard Accessories

The following illustrations show the use of the standard accessories such as voltage probes, test leads, and the various clips.

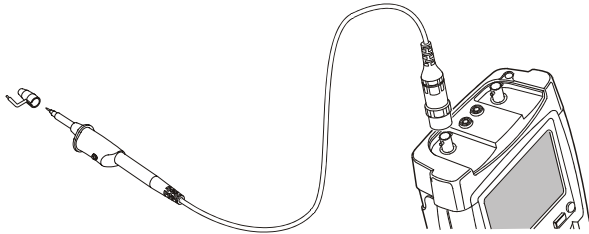

Figure 51. HF Voltage Probe Connection Using Ground Spring

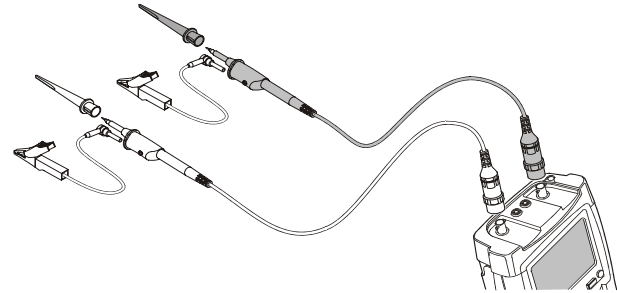

Figure 52. Electronic Connections for Scope Measurements Using Hook Clips and Alligator Clip Grounding

Warning

To avoid electrical shock or fire, do not connect the ground spring to voltages higher than 30 Vrms from earth ground.

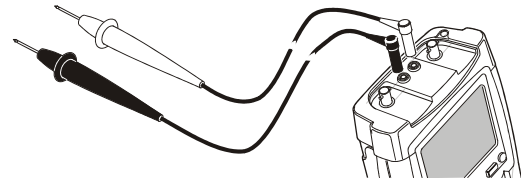

Figure 53. Manual Probing for Meter Measurements using the Test Lead Set

Using the Independently Floating Isolated Inputs

You can use the independently floating isolated inputs to measure signals that are independently floating from each other.

Independently floating isolated inputs offer additional safety and measurement capabilities compared to inputs with common references or grounds.

Measuring Using Independently Floating Isolated Inputs

The test tool has independently floating isolated inputs. Each input section (A, B, External Trigger / DMM) has its own signal input and its own reference input. The reference input of each input section is electrically isolated from the reference inputs of the other input sections. The isolated input architecture makes the test tool about as versatile as having three independent instruments. The advantages of having independently floating isolated inputs are:

- It allows simultaneous measurement of independently floating signals.

- Additional safety. Since the commons are not directly connected, the chance of causing short circuit when measuring multiple signals is greatly reduced.
- Additional safety. When measuring in systems with multiple grounds, the ground currents induced are kept to a minimum.

Because the references are not connected together inside the test tool, each reference of the used inputs must be connected to a reference voltage.

Independently floating isolated inputs are still coupled by parasitic capacitance. This can occur between the input references and the environment, and between the input references mutually (see Figure 54). For this reason, you should connect the references to a system ground or another stable voltage. If the reference of an input is connected to a high speed and / or high voltage signal, you should be aware of parasitic capacitance. (See Figure 54 , Figure 55, Figure 56 and Figure 57.)

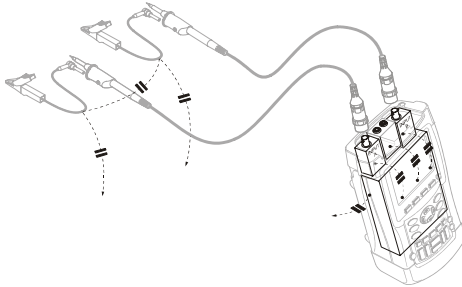

Figure 54. Parasitic capacitance between probes, instrument and environment

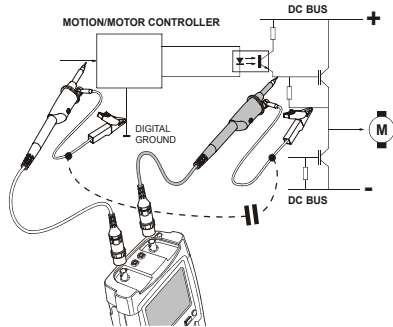

Figure 55. Parasitic capacitance between analog and digital reference

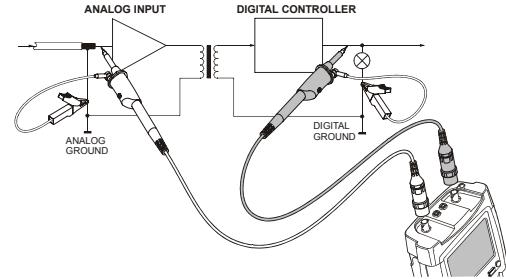

Figure 56. Correct connection of reference leads

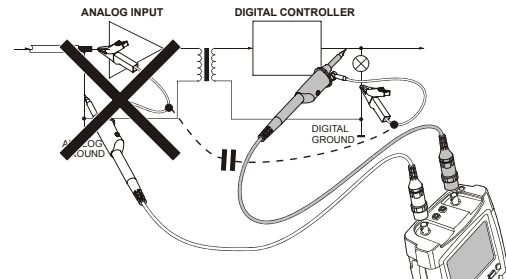

Figure 57. Wrong connection of reference leads

Noise that is picked up by reference lead B can be transmitted by parasitic capacitance to the analog input amplifier.

Using the Tilt Stand

The test tool is equipped with a tilt stand, allowing viewing from an angle while placed on a table. From this position you can access the OPTICAL PORT at the side of the test tool. The typical position is shown in Figure 58.

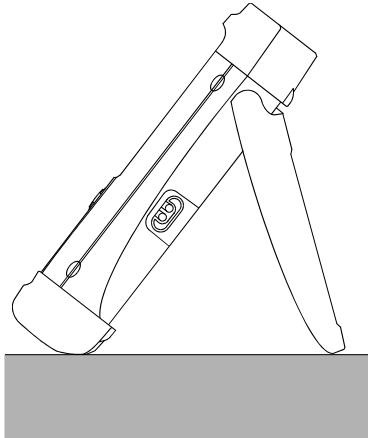





Figure 58. Using the Tilt Stand

Resetting the Test Tool

If you want to reset the test tool to the factory settings, do the following:

- 1  Turn the test tool off.
- 2  Press and hold.
- 3  Press and release.

The test tool turns on, and you should hear a double beep, indicating the reset was successful.

- 4  Release.

Suppressing Key Labels and Menu's







You can hide a menu or key label at any time:

- 1  Hide any key label or menu.

To display menus or key labels, press one of the yellow menu keys, e.g. the SCOPE key.





Changing the Information Language

During operation of the test tool, messages may appear at the bottom of the screen. You can select the language in which these messages are displayed. In this example you can select English or French . To change the language from English to French, do the following:

1		Display the USER key labels.	
2		Open the Language Select menu.	
3		Highlight FRENCH .	
4		Accept French as the language.	

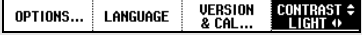
Adjusting the Contrast and Brightness

To adjust the contrast and backlight brightness, do the following:

1		Display the USER key labels.	
2		Enable the arrow keys for manual contrast and backlight adjustment.	
3		Adjust the contrast of the screen.	
4		Change the backlight.	

Note

The new contrast and brightness are stored until a new adjustment is made.







To save battery power, the test tool is in economic brightness mode when operated on the battery. The high brightness intensity increases when you connect the power adapter.

Note

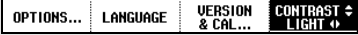
Using dimmed light lengthens maximum battery power operation by about one hour.







Changing the Display Color



To set the display to color or Black and White, do the following:

- 1  Display the **USER** key labels.

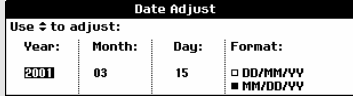
- 2  Open the **User Options** menu.

- 3  Open **Display Options** menu.

- 4  Choose display mode Color or Black and White, and accept it.

Changing Date and Time

The test tool has a date and time clock. For example, to change the date to 19 April, 2002, do the following:

- 1  Display the **USER** key labels.

- 2  Open the **User Options** menu.

- 3  Open **Date Adjust** menu.

- 4  Choose 2002, jump to **Month**.
- 5  Choose 04, jump to **Day**.

- 6  Choose 19, jump to **Format**.
- 7  Choose **DD/MM/YY**, accept the new date.

You can change the time in a similar way by opening the **Time Adjust** menu (steps 2 and 3.)

Saving Battery Life

When operated on the battery (no battery charger connected), the test tool conserves power by shutting itself down. If you have not pressed a key for at least 30 minutes, the test tool turns itself off automatically.







Note

If the power adapter is connected, there is no automatic power shutdown.

Automatic power shutdown will not occur if TrendPlot or Scope Record is on, but the backlight will dim. Recording will continue even if the battery is low, and retention of memories is not jeopardized.

Setting the Power Down Timer

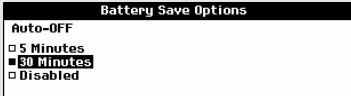
Initially the power shutdown time is 30 minutes. You can set the power shutdown time to 5 minutes as following:

- 1  Display the **USER** key labels.

- 2  Open the **User Options** menu.

- 3  Open the **Battery Save Options** menu.

- 4  Select **5 Minutes**.

Changing the Auto Set Options

With the next procedure you can choose how auto set behaves when you press the **AUTO** (auto set) key.

1  Display the **USER** key labels.

OPTIONS...	LANGUAGE	VERSION & CAL...	CONTRAST LIGHT
------------	----------	------------------	----------------

2  Open the **User Options** menu.

User Options	
Auto Set Adjust...	Printer Setup...
Battery Save Options...	Factory Default
Battery Refresh	Display Options...
Date Adjust...	
Time Adjust...	

3  Open the **Auto Set Adjust** menu.

Auto Set Adjust		
Search for signals of:	Input coupling:	Display glitches:
<input checked="" type="checkbox"/> 15 Hz and up	<input checked="" type="checkbox"/> Set To DC	<input checked="" type="checkbox"/> Set to On
<input type="checkbox"/> 1 Hz and up	<input type="checkbox"/> Unchanged	<input type="checkbox"/> Unchanged

If the frequency range is set to > 15 Hz, the Connect-and-View function responds more quickly. The response is quicker because the test tool is instructed not to analyze low frequency signal components. However, when you measure frequencies lower than 15 Hz, the test tool must be instructed to analyze low frequency components for automatic triggering:

4  Select **Signal > 1 Hz**, then jump to **Coupling**.

With the coupling option you can choose how auto set behaves. When you press the **AUTO** (auto set) key, the coupling can either be set to dc or left unchanged:

5  Select **Unchanged**.

Note

The auto set option for the signal frequency is similar to the automatic trigger option for the signal frequency. (See Chapter 5: “Automatic Trigger Options”). However, the auto set option determines the behavior of the auto set function and shows only effect when you press the auto set key.

Chapter 9

Maintaining the Test Tool

About this Chapter

This chapter covers basic maintenance procedures that can be performed by the user. For complete service, disassembly, repair, and calibration information, see the Service Manual. (www.fluke.com)

Cleaning the Test Tool

Clean the test tool with a damp cloth and a mild soap. Do not use abrasives, solvents, or alcohol. These may damage the text on the test tool.

Storing the Test Tool

If you are storing the test tool for an extended period of time, charge the NiMH (Nickel-Metal Hydride) batteries before storing.



Extending Battery Operation Time

Typically, NiMH batteries always meet the specified operating time. However, if the batteries have been extremely discharged (for example, when empty batteries were stored for a long period) it is possible that the battery condition has deteriorated.

To keep the batteries in optimal condition, observe the following guidelines:

- Operate the test tool on batteries until the  symbol appears at the bottom of the screen. This indicates that the battery level is low and that the NiMH batteries need to be recharged.
- To obtain optimal battery condition again, you can *refresh* the batteries. During a battery refresh, the batteries will be fully discharged and charged again. A complete refresh cycle takes about 12 hours and should be done about four times a year. You can check the latest battery refresh date. See section “Displaying Calibration Information”.

To refresh the battery, make sure that the test tool is line powered and proceed as follows:

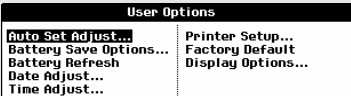
1		Display the USER key labels.
		
2		Open the User Options menu.
		

A message appears asking whether you want to start the refresh cycle now.

3		Start the refresh cycle.
----------	--	--------------------------

Do not disconnect the battery charger during the refresh cycle. This will interrupt the refresh cycle.

Note

After starting the refresh cycle, the screen will be black.

Replacing the NiMH Battery Pack BP190

Usually it should not be necessary to replace the battery pack. However, if replacement is needed, this should be done by qualified personnel only. Contact your nearest Fluke center for more information.

Calibrating the Voltage Probes

To meet full user specifications, you need to adjust the red and gray voltage probes for optimal response. The calibration consists of a high frequency adjustment and a dc calibration for 10:1 probes.

This example shows how to calibrate the 10:1 voltage probes:

-  Display the input A key labels.

INPUT A	COUPLING	PROBE A	INPUT A
ON OFF	DC AC	10:1...	OPTIONS..
-  Open the **Probe on A** menu.

Probe on A		
Probe Type:	Attenuation:	
<input checked="" type="checkbox"/> Voltage	<input type="checkbox"/> 1:1	<input type="checkbox"/> 20:1
<input type="checkbox"/> Current	<input checked="" type="checkbox"/> 10:1	<input type="checkbox"/> 200:1
<input type="checkbox"/> Temp	<input type="checkbox"/> 100:1	
	<input type="checkbox"/> 1000:1	<input type="checkbox"/> Probe Cal
-  Select **Voltage**, then jump to **Attenuation**.

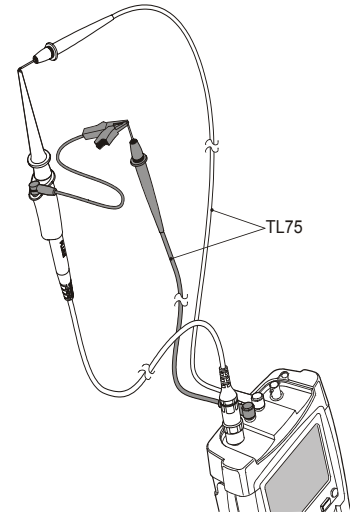





Figure 60. Adjusting Voltage Probes

If the 10:1 option is already selected, proceed with step 5.

-  Select **10:1**, then return.

Repeat steps 2 and 3 and proceed as follows:

5    Select **Probe Cal** with the arrow keys, then accept.

A message appears asking you whether to start the 10:1 probe calibration.

6  Start the probe calibration.

A message appears telling you how to connect the probe. Connect the red 10:1 voltage probe from the red input A jack to the red banana jack. Connect the reference lead to the black banana jack. (See Figure 60.)

7 Adjust the trimmer screw in the probe housing until a pure square wave is displayed.

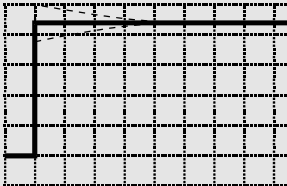

8  Continue with DC calibration. Automatic DC calibration is only possible for 10:1 voltage probes.

The test tool automatically calibrates itself to the probe. During calibration you should not touch the probe. A message indicates when the DC calibration has completed successfully.

9  Return.

Repeat the procedure for the gray 10:1 voltage probe. Connect the grey 10:1 voltage probe from the grey input B jack to the red banana jack. Connect the reference lead to the black banana jack.

Note

When using 100:1 voltage probes, choose 100:1 attenuation to perform an adjustment.

Displaying Calibration Information

You can display version number and calibration date:

1  Display the **USER** key labels.



2  Open the **Version & Calibration** menu.



Version & Calibration	
Model Number :	199C
Software Version:	V07.00
Option:	None
Calibration Number:	#4
Calibration Date:	01/19/2004
Battery Refresh Date:	01/19/2004

The screen gives you information about the model number with software version, the calibration number with latest calibration date, and the latest battery refresh date.

3  Return.

Recalibration must be carried out by qualified personnel. Contact your local Fluke representative for recalibration.

Parts and Accessories

The following tables list the user-replaceable parts for the various test tool models. For additional optional accessories, see the ScopeMeter Accessories booklet.



To order replacement parts or additional accessories, contact your nearest service center.



Replacement Parts

Item	Ordering Code
<p>Battery Charger, available models:</p> <p>Universal Europe 230 V, 50 and 60 Hz</p> <p>North America 120 V, 50 and 60 Hz</p> <p>United Kingdom 240 V, 50 and 60 Hz</p> <p>Japan 100 V, 50 and 60 Hz</p> <p>Australia 240 V, 50 and 60 Hz</p> <p>Universal 115 V/230 V, 50 and 60 Hz *</p> <p><i>* UL listing applies to BC190/808 with UL listed line plug adapter for North America.</i></p> <p><i>The 230 V rating of the BC190/808 is not for use in North America.</i></p> <p><i>For other countries, a line plug adapter complying with the applicable National Requirements must be used.</i></p>	<p>BC190/801</p> <p>BC190/813</p> <p>BC190/804</p> <p>BC190/806</p> <p>BC190/807</p> <p>BC190/808</p>
<p>Voltage Probe Set (Red), designed for use with the Fluke ScopeMeter 19xC-2x5C series test tool.</p> <p>The set includes the following items (not available separately):</p> <ul style="list-style-type: none"> • 10:1 Voltage Probe (red) • 4-mm Test Probe for Probe Tip (red) • Hook Clip for Probe Tip (red) • Ground Lead with Hook Clip (red) • Ground Lead with Mini Alligator Clip (black) • Ground Spring for Probe Tip (black) • Insulation Sleeve (red) 	<p>VPS210-R</p>

Fluke 19xC-2x5C

Users Manual

Item	Ordering Code
<p>Voltage Probe Set (Gray), designed for use with the Fluke ScopeMeter 19xC-2x5C series test tool.</p> <p>The set includes the following items (not available separately):</p> <ul style="list-style-type: none">• 10:1 Voltage Probe (gray)• 4-mm Test Probe for Probe Tip (gray)• Hook Clip for Probe Tip (gray)• Ground Lead with Hook Clip (gray)• Ground Lead with Mini Alligator Clip (black)• Ground Spring for Probe Tip (black)• Insulation Sleeve (gray)	<p> VPS210-G</p>
<p>Test Lead Set (red and black)</p>	<p> TL75</p>
<p>Accessory Set (Red)</p> <p>The set includes the following items (not available separately):</p> <ul style="list-style-type: none">• Industrial Alligator for Probe Tip (red)• 2-mm Test Probe for Probe Tip (red)• Industrial Alligator for Banana Jack (red)• 2-mm Test Probe for Banana Jack (red)• Ground Lead with 4-mm Banana Jack (black)	<p> AS200-R</p>

Item	Ordering Code
<p>Accessory Set (Gray) </p> <p>The set includes the following items (not available separately):</p> <ul style="list-style-type: none"> • Industrial Alligator for Probe Tip (gray) • 2-mm Test Probe for Probe Tip (gray) • Industrial Alligator for Banana Jack (gray) • 2-mm Test Probe for Banana Jack (gray) • Ground Lead with 4-mm Banana Jack (black) 	AS200-G
<p>Replacement Set for Voltage Probe </p> <p>The set includes the following items (not available separately):</p> <ul style="list-style-type: none"> • 2x 4-mm Test Probe for Probe Tip (red and gray) • 3x Hook Clip for Probe Tip (2 red, 1 gray) • 2x Ground Lead with Hook Clip (red and gray) • 2x Ground Lead with Mini Alligator Clip (black) • 5x Ground Spring for Probe Tip (black) 	RS200
Bus Health Test adapter	BHT190

Optional Accessories

Item	Ordering Code
Software & Cable Carrying Case Kit Set contains the following parts: Optically Isolated USB Adapter/Cable Hard Carrying Case FlukeView [®] ScopeMeter [®] Software for Windows [®]	SCC190 OC4USB C190 SW90W
Optically Isolated USB Adapter/Cable	OC4USB
Optically Isolated RS-232 Adapter/Cable	PM9080
Hard Case	C190
Soft Case	C195
Current Shunt 4-20 mA	CS20MA
Print Adapter Cable for Parallel Printers	PAC91

Troubleshooting



The Test Tool Does Not Start Up

- The batteries may be completely empty. In this case the test tool will not start up, even if it is powered by the battery charger. Charge the batteries first: power the test tool with the battery charger without turning it on. Wait about 15 minutes and try turning on the test tool again.

The Test Tool Shuts Down After A Few Seconds

- The batteries may be empty. Check the battery symbol at the top right of the screen. A  symbol indicates that the batteries are empty and must be charged.

The Screen Remains Black

- Make sure that the test tool is on.
- You might have a problem with the screen contrast. Press , then press . Now you can use the arrow keys to adjust the contrast.

The Operation Time Of Fully Charged Batteries Is Too Short

- The batteries may be in poor condition. Refresh the batteries to optimize the condition of the batteries again. It is advised to refresh the batteries about four times a year.

The Printer Does Not Print

- Make sure that the interface cable is properly connected between the test tool and the printer.
- Make sure that you have selected the correct printer type. (See Chapter 7.)
- Make sure that the baud rate matches with the printer. If not, select another baud rate. (See Chapter 7.)
- If you are using the PAC91 (Print Adapter Cable), make sure that it is turned on.

FlukeView Does Not Recognize The Test Tool

- Make sure that the test tool is turned on.
- Make sure that the interface cable is properly connected between the test tool and the PC.
- Make sure that the correct COM port has been selected in FlukeView. If not, change the COM port setting or connect the interface cable to another COM port.

Battery Operated Fluke Accessories Do Not Function

- When using battery operated Fluke accessories, always first check the battery condition of the accessory with a Fluke multimeter.

Chapter 10

Specifications

Introduction

Performance Characteristics

FLUKE guarantees the properties expressed in numerical values with the stated tolerance. Specified non-tolerance numerical values indicate those that could be nominally expected from the mean of a range of identical ScopeMeter test tools.

Specifications are based on a 1-year calibration cycle.

Environmental Data

The environmental data mentioned in this manual are based on the results of the manufacturer's verification procedures.

Safety Characteristics

The test tool has been designed and tested in accordance with Standards ANSI/ISA S82.01-1994, EN/IEC 61010.1:2001 , CAN/CSA-C22.2 No.61010-1-04 (including approval), UL61010B-1 (including approval) Safety Requirements for Electrical Equipment for Measurement, Control, and Laboratory Use.

This manual contains information and warnings that must be followed by the user to ensure safe operation and to keep the instrument in a safe condition. Use of this equipment in a manner not specified by the manufacturer may impair protection provided by the equipment.

Dual Input Oscilloscope

Isolated Inputs A and B (Vertical)

Bandwidth, DC Coupled

FLUKE 199C, 225C	200 MHz (-3 dB)
FLUKE 196C, 215C	100 MHz (-3 dB)
FLUKE 192C	60 MHz (-3 dB)

Lower Frequency Limit, AC Coupled

with 10:1 probe	<2 Hz (-3 dB)
direct (1:1)	<5 Hz (-3 dB)

Rise Time

FLUKE 199C, 225C	1.7 ns
FLUKE 196C, 215C	3.5 ns
FLUKE 192C	5.8 ns

Analog Bandwidth Limiters

20 MHz and 10 kHz

Input Coupling

AC, DC

Polarity

Normal, Inverted

Sensitivity Ranges

with 10:1 probe	20 mV to 1000 V/div
direct (1:1)	2 mV to 100 V/div

Dynamic Range

> ±8 div (< 10 MHz)

> ±4 div (> 10 MHz)

Trace Positioning Range

±4 divisions

Input Impedance on BNC

DC Coupled 1 MΩ (±1 %)/15 pF (±2 pF)

Max. Input Voltage

with 10:1 probe	600 V CAT III; 1000 V CAT II
direct (1:1)	300 V CAT III

(For detailed specifications, see "Safety")

Vertical Accuracy

±(1.5 % + 0.04 range/div)

2 mV/div:±(2.5 % + 0.08 range/div)

For voltage measurements with 10:1 probe, add probe accuracy, see section '10:1 Probe' on page 127.

Digitizer Resolution

8 bits, separate digitizer

for each input

Horizontal

Maximum Time Base Speed:

FLUKE 196C, 199C, 215C, 225C	5 ns/div
FLUKE 192C	10 ns/div

Minimum Time Base Speed (Scope Record)

2 min/div

Real Time Sampling Rate (for both inputs simultaneously)

FLUKE 199C, 225C:

5 ns to 5 μs /div up to 2.5 GS/s

10 μs to 120 s/div 20 MS/s

FLUKE 196C, 215C:

5 ns to 5 μs /div up to 1 GS/s

10 μs to 120 s/div 20 MS/s

FLUKE 192C:

10 ns to 5 μs /div up to 500 MS/s

10 μs to 120 s/div 20 MS/s

Record Length

Pulse Width Trigger

Screen Update.....On Trigger, Single Shot
Trigger Conditions <T, >T, =T ($\pm 10\%$), $\neq T$ ($\pm 10\%$)
SourceA
Polarity..... Positive or negative pulse
Pulse Time Adjustment Range 0.01 div. to 655 div.
with a minimum of 300 ns (<T, >T) or 500 ns (=T, $\neq T$),
a maximum of 10 s,
and a resolution of 0.01 div. with a minimum of 50 ns

Continuous Auto Set

Autoranging attenuators and time base, automatic
Connect-and-View™ triggering with automatic source
selection.

Modes

Normal 15 Hz to max. bandwidth
Low Frequency 1 Hz to max. bandwidth

Minimum Amplitude A and B

DC to 1 MHz 10 mV
1 MHz to max. bandwidth..... 20 mV

Automatic Capturing Scope Screens

Capacity..... 100 dual input scope Screens

For viewing screens, see Replay function.

Automatic Scope Measurements

The accuracy of all readings is within \pm (% of reading + number of counts) from 18 °C to 28 °C. Add 0.1x (specific accuracy) for each °C below 18 °C or above 28 °C. For voltage measurements with 10:1 probe, add probe accuracy, see section '10:1 Probe' on page 127. At least 1.5 waveform period must be visible on the screen.

General

Inputs A and B
DC Common Mode Rejection (CMRR) >100 dB
AC Common Mode Rejection at 50, 60, or 400 Hz >60 dB

DC Voltage (VDC)

Maximum Voltage
with 10:1 probe..... 1000 V
direct (1:1)..... 300 V

Maximum Resolution

with 10:1 probe..... 1 mV
direct (1:1)..... 100 μ V

Full Scale Reading..... 1100 counts

Accuracy at 5 s to 10 μ s/div

2 mV/div \pm (1.5 % + 10 counts)
5 mV/div to 100 V/div \pm (1.5 % + 5 counts)

Normal Mode AC Rejection at 50 or 60 Hz >60 dB

AC Voltage (VAC)

Maximum Voltage	
with 10:1 probe.....	1000 V
direct (1:1).....	300 V
Maximum Resolution	
with 10:1 probe.....	1 mV
direct (1:1).....	100 μ V
Full Scale Reading.....	1100 counts
Accuracy	
DC coupled:	
DC to 60 Hz.....	$\pm(1.5\% + 10 \text{ counts})$
AC coupled, low frequencies:	
50 Hz direct (1:1).....	$\pm(2.1\% + 10 \text{ counts})$
60 Hz direct (1:1).....	$\pm(1.9\% + 10 \text{ counts})$
With the 10:1 probe the low frequency roll off point will be lowered to 2 Hz, which improves the AC accuracy for low frequencies. When possible use DC coupling for maximum accuracy.	
AC or DC coupled, high frequencies:	
60 Hz to 20 kHz.....	$\pm(2.5\% + 15 \text{ counts})$
20 kHz to 1 MHz.....	$\pm(5\% + 20 \text{ counts})$
1 MHz to 25 MHz.....	$\pm(10\% + 20 \text{ counts})$
For higher frequencies the instrument's frequency roll off starts affecting accuracy.	
Normal Mode DC Rejection.....	>50 dB

All accuracies are valid if:

- The waveform amplitude is larger than one division
- At least 1.5 waveform period is on the screen

AC+DC Voltage (True RMS)

Maximum Voltage	
with 10:1 probe.....	1000 V
direct (1:1).....	300 V
Maximum Resolution	
with 10:1 probe.....	1 mV
direct (1:1).....	100 μ V
Full Scale Reading.....	1100 counts
Accuracy	
DC to 60 Hz.....	$\pm(1.5\% + 10 \text{ counts})$
60 Hz to 20 kHz.....	$\pm(2.5\% + 15 \text{ counts})$
20 kHz to 1 MHz.....	$\pm(5\% + 20 \text{ counts})$
1 MHz to 25 MHz.....	$\pm(10\% + 20 \text{ counts})$
For higher frequencies the instrument's frequency roll off starts affecting accuracy.	

Amperes (AMP)

With Optional Current Probe or Current Shunt

Rangessame as VDC, VAC, VAC+DC

Probe Sensitivity 100 μ V/A, 1 mV/A, 10 mV/A,
100 mV/A, 1 V/A, 10 V/A, and 100 V/A

Accuracysame as VDC, VAC, VAC+DC
(add current probe or current shunt accuracy)

Peak

ModesMax peak, Min peak, or pk-to-pk

Maximum Voltage
with 10:1 probe 1000 V
direct (1:1)..... 300 V

Maximum Resolution
with 10:1 probe 10 mV
direct (1:1)..... 1 mV

Full Scale Reading 800 counts

Accuracy
Max peak or Min peak \pm 0.2 division
Peak-to-peak \pm 0.4 division

Frequency (Hz)

Range 1.000 Hz to full bandwidth

Full Scale Reading 9 999 counts
with at least 10 waveform periods on screen.

Accuracy
1 Hz to full bandwidth \pm (0.5 % +2 counts)

Duty Cycle (DUTY)

Range 4.0 % to 98.0 %

Pulse Width (PULSE)

Resolution (with GLITCH off) 1/100 division

Full Scale Reading 999 counts

Accuracy
1 Hz to full bandwidth \pm (0.5 % +2 counts)

V_{pwm}

Purpose to measure on pulse width modulated
signals, like motor drive inverter outputs

Principle readings show the effective voltage based
on the average value of samples over a
whole number of periods of the fundamental
frequency

Accuracy as V_{rms} for sinewave signals

Power

Power Factor..... ratio between Watts and VA
 Range0.00 to 1.00

Watt RMS reading of multiplication
 corresponding samples of input A (volts)
 and Input B (amperes)
 Full Scale Reading 999 counts

VA..... $V_{rms} \times A_{rms}$
 Full Scale Reading 999 counts

VA Reactive $\sqrt{((VA)^2 - W^2)}$
 Full Scale Reading 999 counts

Phase

Range -180 to +180 degrees

Resolution..... 1 degree

Accuracy

0.1 Hz to 1 MHz ± 2 degrees

1 MHz to 10 MHz ± 3 degrees

Temperature (TEMP)

With Optional Temperature Probe

Ranges (°C or °F).....-40.0 to +100.0 °
 -100 to +250 °
 -100 to +500 °
 -100 to +1000 °
 -100 to + 2500 °

Probe Sensitivity 1 mV/°C and 1 mV/°F

Decibel (dB)

dBVdB relative to one volt

dBm.....dB relative to one mW in 50 Ω or 600 Ω

dB on..... VDC, VAC, or VAC+DC

Accuracy same as VDC, VAC, VAC+DC

Meter

Meter Input

Input Coupling.....DC

Frequency Response.....DC to 10 kHz (-3 dB)

Input Impedance..... 1 M Ω (± 1 %)//10 pF (± 1.5 pF)

 Max. Input Voltage1000 V CAT II
600 V CAT III

(For detailed specifications, see “Safety”)

Meter Functions

Ranging Auto, Manual

ModesNormal, Relative

DMM Measurements on Meter Inputs

The accuracy of all measurements is within \pm (% of reading + number of counts) from 18 °C to 28 °C.
Add 0.1x (specific accuracy) for each °C below 18 °C or above 28 °C.

General

DC Common Mode Rejection (CMRR)>100 dB

AC Common Mode Rejection at 50, 60, or 400 Hz>60 dB

Ohms (Ω)

Ranges.....500.0 Ω , 5.000 k Ω , 50.00 k Ω ,
500.0 k Ω , 5.000 M Ω , 30.00 M Ω

Full Scale Reading

500 Ω to 5 M Ω5000 counts

30 M Ω 3000 counts

Accuracy $\pm(0.6$ % +5 counts)

Measurement Current 0.5 mA to 50 nA, ± 20 %
decreases with increasing ranges

Open Circuit Voltage<4 V

Continuity (CONT)

Beep <50 Ω (± 30 Ω)

Measurement Current0.5 mA, ± 20 %

Detection of shorts of ≥ 1 ms

Amperes (AMP)

With Optional Current Probe or Current Shunt

Rangessame as VDC, VAC, VAC+DC

Probe Sensitivity 100 μ V/A, 1 mV/A, 10 mV/A,
100 mV/A, 1 V/A, 10 V/A, and 100 V/A

Accuracysame as VDC, VAC, VAC+DC
(add current probe or current shunt accuracy)

Recorder

TrendPlot (Meter or Scope)

Chart recorder that plots a graph of min and max values of Meter or Scope measurements over time.

Measurement Speed 5 measurements/s max

Time/Div 5 s/div to 30 min/div

Record Size \geq 18000 points

Recorded Time Span... 60 min to 22 days(single reading)
30 min to 11 days (dual reading)

Time Reference time from start, time of day

Scope Record

Records scope waveforms in deep memory while displaying the waveform in Roll mode.

Source..... Input A, Input B

Max. Sample Speed (5 ms/div to 1 min/div).....20 MS/s

Glitch capture (5 ms/div to 1 min/div)..... 50 ns

Time/Div in normal mode 5 ms/div to 2 min/div

Record Size 27000 points per input

Recorded Time Span 6 s to 48 hours

Acquisition Modes Single Sweep
Continuous Roll
External Triggering

Time Reference time from start, time of day

Miscellaneous

Display

View Area 115 x 86 mm (4.5 x 3.4 inches)

Backlight Cold Cathode Fluorescent (CCFL)
Temperature compensated

Brightness Power Adapter: 80 cd/m²
Batteries: 50 cd/m²

Power

Rechargeable NiMH Batteries:

Operating Time 4 hours

Charging Time 4 hours

Allowable ambient

temperature during charging: 0 to 40 °C (32 to 104 °F)

Auto power down

time (battery saving): 5 min, 30 min or disabled

Battery Charger / Power Adapter BC190:

- BC190/801 European line plug 230 V ±10 %
- BC190/813 North American line plug 120 V ±10 %
- BC190/804 United Kingdom line plug 230 V ±10 %
- BC190/806 Japanese line plug 100 V ±10 %
- BC190/807 Australian line plug 230 V ±10 %
- BC190/808 Universal switchable adapter 115 V ±10 %
or 230 V ±10 %, with plug EN60320-2.2G

Line Frequency 50 and 60 Hz

Probe Calibration

Manual pulse adjustment and automatic DC adjustment
with probe check.

Generator Output 3 Vpp / 500 Hz
square wave

Memory

Number of Scope Memories 15
Each memory can contain two waveforms plus
corresponding setups

Number of Recorder Memories 2

Each memory can contain:

- a dual input TrendPlot
(2 x 9000 points per input)
- a dual input Scope Record
(2 x 27000 points per input)
- 100 dual input Scope screens

Mechanical

Size 64 x 169 x 256 mm (2.5 x 6.6 x 10.1 in)

Weight 2 kg (4.4 lbs)
including battery

Optical InterfacePort

- Type.....RS-232, optically isolated
- To Printer supports SII DPU-414, Epson FX/LQ, and HP Deskjet®, Laserjet®, and Postscript
- Serial via PM9080 (optically isolated RS-232 Adapter/Cable, optional).
 - Parallel via PAC91 (optically isolated Print Adapter Cable, optional).
- To PC/Notebook
- Serial via PM9080 (optically isolated RS-232 Adapter/Cable, optional), using SW90W (FlukeView® software for Windows®).
 - Serial via OC4USB (optically isolated USB Adapter/Cable, optional), using SW90W (FlukeView® software for Windows®).

Environmental

- Environmental MIL-PRF-28800F, Class 2
- Temperature
- Operating:
- battery only 0 to 50 °C (32 to 122 °F)
- power adapter..... 0 to 40 °C (32 to 104 °F)
- Storage..... -20 to +60 °C (-4 to +140 °F)
- Humidity
- Operating:
- 0 to 10 °C (32 to 50 °F)..... noncondensing
- 10 to 30 °C (50 to 86 °F)..... 95 %
- 30 to 40 °C (86 to 104 °F)..... 75 %
- 40 to 50 °C (104 to 122 °F)..... 45 %
- Storage:
- 20 to +60 °C (-4 to +140 °F)..... noncondensing
- Altitude
- Operating.....3 km (10 000 feet)
- Storage.....12 km (40 000 feet)
- Vibration (Sinusoidal) max. 3 g
- Shock max. 30 g
- Electromagnetic Compatibility (EMC)
- Emission and immunity..... EN-IEC61326-1:2006
- Enclosure Protection IP51, ref: EN-IEC60529

! Safety

Designed for 1000 V measurements Category II , 600 V measurements Category III , Pollution Degree 2, per:

- ANSI/ISA S82.01-1994
- EN/IEC61010-1 : 2001
- CAN/CSA-C22.2 No.61010-1-04
- UL61010B-1

! Max. Input Voltages

Input A and B directly	300 V CAT III
Input A and B via 10:1 probe.....	1000 V CAT II 600 V CAT III
METER/EXT TRIG inputs	1000 V CAT II 600 V CAT III

! Max. Floating Voltage

From any terminal to earth ground.....	1000 V CAT II 600 V CAT III
Between any terminal.....	1000 V CAT II 600 V CAT III

Voltage ratings are given as “working voltage”. They should be read as Vac-rms (50-60 Hz) for AC sinewave applications and as Vdc for DC applications.

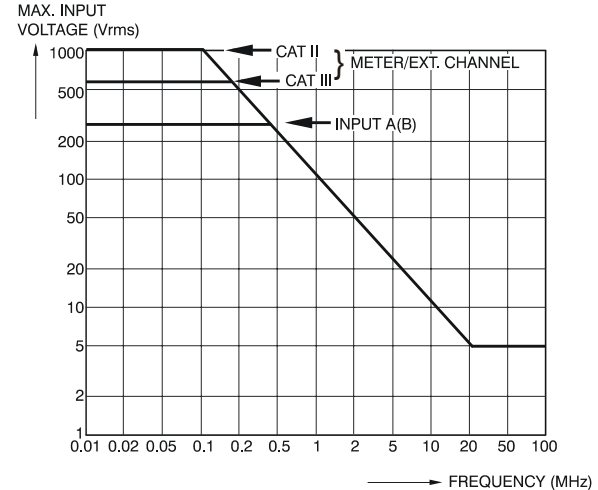

Figure 62. Max. Input Voltage vs. Frequency

Note

Measurement Category III refers to distribution level and fixed installation circuits inside a building. Measurement Category II refers to local level, which is applicable for appliances and portable equipment.

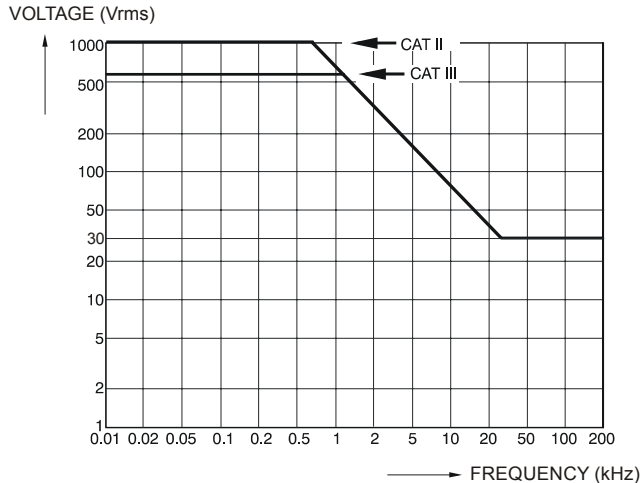

Figure 63. Safe Handling: Max. Voltage Between Scope References, Between Scope References and Meter Reference, and Between Scope References/Meter Reference and earth ground.

10:1 Probe

Safety

⚠ Max. Input Voltage 1000 V CAT II
600 V CAT III

⚠ Max. Floating Voltage
from any terminal to earth ground..... 1000 V CAT II
600 V CAT III

Electrical specifications

Input Impedance at probe tip 10 MΩ ±2 %//14 pF ±2 pF
Capacity Adjustment Range 10 to 22 pF
Attenuation at DC (1 MΩ input) 10 x
Bandwidth (with FLUKE 199C)..... DC to 200 MHz (-3 dB)

Accuracy

Probe accuracy when adjusted on the test tool:
DC to 20 kHz ±1 %
20 kHz to 1 MHz ±2 %
1 MHz to 25 MHz ±3 %

For higher frequencies the probe's roll off starts affecting the accuracy

Environmental

Temperature

Operating 0 to 50 °C (32 to 122 °F)
Storage -20 to +60 °C (-4 to +140 °F)

Altitude

Operating 3 km (10 000 feet)
Storage 12 km (40 000 feet)

Humidity

Operating at 10 to 30 °C (50 to 86 °F) 95 %

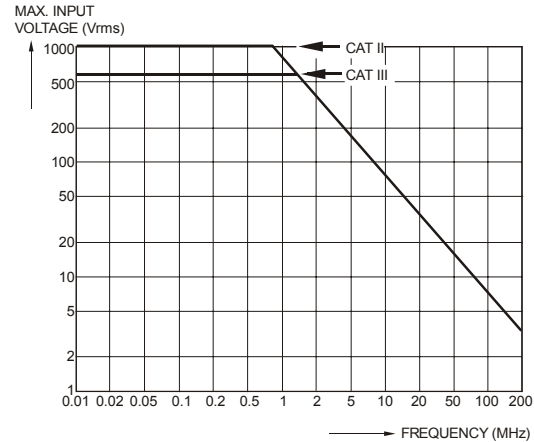

Figure 64. Max. Voltage From Probe Tip to earth ground and From Probe Tip to Probe Reference

Electromagnetic Immunity

The Fluke 19xC-2x5C series, including standard accessories, conforms with the EEC directive 2004/108/EC for EMC immunity, as defined by EN-61326-1:2006, with the addition of the following tables.

Scope Mode (10 ms/div): Trace disturbance with VPS210 voltage probe shorted

Table 12

No visible disturbance	E = 3V/m
Frequency range 10 kHz to 20 MHz	2 mV/div to 100 V/div
Frequency range 20 MHz to 100 MHz	200 mV/div to 100 V/div
Frequency range 100 MHz to 1 GHz	500 mV/div to 100 V/div ^{*)}
Frequency range 1.4 GHz to 2.0 GHz	2 mV/div to 100 V/div

(*) With the 20 MHz Bandwidth Filter switched on: no visible disturbance.
With the 20 MHz Bandwidth Filter switched off: disturbance is max 2 div.

Table 13

No visible disturbance	E = 1V/m
Frequency range 2.0 GHz to 2.7 GHz	2 mV/div to 100 V/div

Table 14

Disturbance less than 10% of full scale	E = 3V/m
Frequency range 20 MHz to 100 MHz	10 mV/div to 100 mV/div

Test Tool ranges not specified in tables 12, 13 and 14 may have a disturbance of more than 10% of full scale.

Meter Mode (Vdc, Vac, Vac+dc, Ohm and Continuity): Reading disturbance with test leads shorted

Table 15

Disturbance less than 1% of full scale	E = 3V/m
Frequency range 10 kHz to 1 GHz	500 mV to 1000 V , 500 Ohm to 30 MOhm ranges

Table 16

No visible disturbance	E = 3V/m
Frequency range 1.4 GHz to 2 GHz	500 mV to 1000 V , 500 Ohm to 30 MOhm ranges

Table 17

No visible disturbance	E = 1V/m
Frequency range 2 GHz to 2.7 GHz	500 mV to 1000 V , 500 Ohm to 30 MOhm ranges

Index

—1—

10-1 Voltage Probe, 107

—2—

2-mm Test Probes, 108

—4—

4-mm Test Probes, 3, 107

—A—

A versus B, 20

A*B, 20

A+B, 20

A-B, 20

Accessories, 91, 106

AC-Coupling, 18

Acquiring the Waveform, 18

Altitude, 125, 128

Ampere Measurement, 29

Amperes, 118, 122

Analysis Functions, 41, 123

AS200 Accessory Set, 108

Auto Ranges, 31

Auto Set, 116

Automatic Connect-and-View

Trigger, 115

Automatic Power Shutdown, 98

Automatic Scope Measurements,

13

Automatic Triggering, 54

Average, 15

—B—

Banana Jack Inputs, 10, 27, 34

Bandwidth, 114, 120

Bargraph, 28

Battery

Charger, 3, 107

Charging, 2, 102

Indicator, 102

Life, 98

Refresh, 103

Refresh Date, 106

Replacing, 104

BC190 Battery Charger, 3, 107

BHT190, 109

Bus type, 66

Bushealth, 65

—C—

C190 Hard Case, 3, 110

C195 Soft Case, 110

Calibrating the Test Tool, 106

Calibrating Voltage Probes, 104,

124

Calibration, 124

Capturing 100 Screens, 43, 116

Case, 110

Charge Time, 124

Charger, 107

Charging, 102

Cleaning, 101

Clear Menu, 10, 95
Common Leads, 3
Comparing Waveforms, 23
Connect-and-View, 51, 116
Connecting a Computer, 88
Connecting A Printer, 88
Connections, 10, 27
Continuity, 120
Contrast, 96
CS20MA Current Shunt, 110
Current Measurement, 29
Current Probe, 29
Current Shunt, 110
Cursors Measurements, 46

—D—

Date, 97
DC Voltage (VDC), 116, 121
Decibel (dB), 119
Delay, Trigger, 115
Deleting Screens, 85
Diode, 121
Display, 124
Displaying Recorded Data, 35, 38
DMM Measurements, 28
Documenting Screens, 88
Dot-join, 16, 80
Dual Slope Triggering, 52

Duty Cycle, 118

—E—

Earth Ground, 6
Edge Trigger, 55, 115
Electrical Shock, 5
Electrically Floating, 6
Electromagnetic Compatibility, 125
Electronic Scope Connections, 92
Emission, 125
envelope mode, 16
Environmental, 125
Environmental Data, 113
External Trigger, 115
External Triggering, 58
Eye pattern, 80

—F—

FFT, 21
Fieldbus, 65
Fieldbus test limits, 68
Fieldbus type, 66
Filtering, 20
FlukeView, 88, 110
Freezing the Readings, 31
Freezing the Screen, 14
Frequency (Hz), 118
Frequency Response, 114, 120

—G—

Glitch Capture, 17
Ground Leads, 3, 107
Ground Spring, 3, 107, 108

—H—

Hard Case, 3, 110
HF Voltage Probe Connection, 92
Hook Clips, 3, 107
Horizontal Cursors, 46
Humidity, 125
Hz, 118

—I—

Immunity, 125
Information Language, 96
Input A Measurement, 13
Input B Measurement, 13
Input Coupling, 120
Input Impedance, 114, 120, 127
Input Sensitivity
 Variable, 19
Interface, 125
Inverted Display, 18
Isolated, 6

—L—

Language, 96

—M—

Maintenance, 101

Manual Ranges, 31

Mathematics Functions, 20

Max. Floating Voltage, 126, 127

Max. Input Voltage, 126

Measurement Connections, 10, 27

Measurements, 13, 28

Measurements on Meter Inputs,
120

Mechanical, 124

Memory, 124

Meter Measurements, 28

Multi Meter Measurements, 28

—N—

N/A, 68

Navigating a Menu, 9

N-Cycle Triggering, 57

NiMH Battery, 102

NiMH Battery, 101

Noisy Waveforms, 20, 56

—O—

Ohm (Ω), 120

Operating Time, 124

Optical Interface, 88, 125

Oscilloscope, 114

OVERVIEW, 45

—P—

PAC91, 88, 110

Parallel Print Cable, 110

Parallel Printer, 89

Parts, 106

Pass - Fail Testing, 24

Peak, 118

Performance Characteristics, 113

Persistence, 16

Phase, 119

PM9080, 88, 110

Polarity, 18

Power, 119, 124

Power Adapter, 98, 107

Power Down Timer, 98

Power Factor, 119

Power Factor (Power...), 13

Powering the Test Tool, 7

Pre Trigger, 53

Print Cable, 110

Probe, 104

Probe Calibration, 104, 124

Pulse Trigger, 61

Pulse Width, 118

Pulse Width Trigger, 116

—R—

Readings, 13

Recalibrating, 106

Recalling Screens, 86

Recalling Setups, 86

Record Length, 115

Record+Setup Memory, 85

Recorder, 122

Recorder Options, 36

Recording Waveforms, 37

Refreshing Batteries, 106

Relative Measurements, 32

Replaceable Parts, 106

Replacement Set, 109

Replacing Batteries, 104

Replay, 41, 85, 123

Reset, 8

Resetting the Test Tool, 8, 95

Resistance Measurement, 28

Reversing the Polarity, 18

Rise Time, 49, 114

RMS Voltage, 117

Fluke 19xC-2x5C

Users Manual

Roll Mode Function, 122
RS200 Replacement Set, 109
RS-232 Adapter/Cable, 3, 88, 110

—S—

Safety, 126
Safety Characteristics, 113
Safety Requirements, 1
Sampling Rate, 114
Saving, 84
SCC 190, 88, 110
Scope, 114
Scope Connections, 11
Scope Cursor Measurements, 123
Scope Measurements, 13
Scope Record, 122
Scope Record, 37
Screen Contrast, 96
Screen Without Menus, 10, 95
Serial Printer, 89
Shock, 125
Single Shot, 56
Single Sweep Mode, 38
Slope, 52, 115
Slow Variations, 34
Smooth, 15
Soft Case, 110
Software, 3, 110

Software Version, 106
Specifications, 113
Spectrum, 21
Spike Capture, 17
Stand, 95
Storing, 101
SW90W Software, 3, 88, 110

—T—

Temperature, 119, 121, 125, 128
Test adapter, 109
Test Leads, 3
Test Limits, 81, 82
Test Probes, 3, 107
Tilt Stand, 95
Time, 97
Time Base Accuracy, 115
TrendPlot (Meter), 122
TrendPlot™ Function, 34
Trigger
 Delay, 53, 115
 Level, 52
 Modes, 115
 Pre-trigger, 53
Trigger Sensitivity, 115
Triggering
 Automatic, 54, 115
 Dual Slope, 52

External, 58
N-Cycle, 57
On Edges, 55
On Pulses, 61
On Video, 59
On Waveforms, 51
Troubleshooting, 111
TV Triggering, 59

—U—

Unpacking, 2
Users Manual, 3

—V—

VA, 119
VA (Power...), 13
VA Reactive, 119
VA Reactive (Power...), 13
Vertical Accuracy, 114
Vertical Cursors, 47
Vibration, 125
Video Frames, 60
Video Lines, 60
Video Trigger, 59, 115
Viewing Stored Screens, 87
Voltage Probes, 3, 104, 107
VP210 Voltage Probe, 107
VP210 Voltage Probe Set, 3

Vpwm, 13, 118

—W—

Watt, 119

Watts (Power...), 13

Waveform comparing, 23

Waveform Mathematics, 20

Waveform Options, 15

Waveform storage, 84

—X—

X-Y mode, 20

—Z—

Zoom, 44, 123

Appendices

Appendix	Title	Page
	Bushealth Measurements	A-1

Appendix A

Bushealth Measurements

Introduction

This Appendix contains information to extend the information presented in Chapter 6 of this manual.

The purpose of this appendix is to give more information on how to connect Probe(s) and Ground Lead(s) to the Fieldbus system under test. Bear in mind however that due to the variety of Bus Standards and Connectors used worldwide it is impossible to cover all situations. The connection solutions in this appendix cover those most commonly found.

General

The Bushealth measurement is based upon the test tool's Scope mode. In addition to that it selects settings that are optimized to the signal characteristics of the selected Bus Type. The captured waveform(s) are compared to voltage and timing criteria belonging to the tested Bus Type. This results in quality information of these criteria (OK, marginal, or out of range).

Caution

Fieldbuses often are controlling delicate processes that must not be disturbed. It is strongly recommended to contact the system manager before any connections are made!

Used Probes and Accessories

Refer to page 2 and 3 of this manual for an overview of accessories as supplied with the test tool.

For most bushealth measurements the 10:1 probe(s) are used. To hook up to bus line nodes you can use the Alligator Clips or Hook Clips that fit on to the probe tip. TP88 Back Probe Pins (optional) can be used to probe screw terminals at the wire entry point.

Important. For correct measurements you should calibrate your probe to match its characteristics to the test tool. A poorly calibrated probe can introduce measurement errors. See Chapter 9 'Calibrating the Voltage Probes' for calibration instructions.

You can use the BHT190 test adapter to measure on busses that use a DB9 or a M12 connector.

Tips and Hints per Bus Type

AS-i bus

The Actuator-Sensor-Interface (AS-i) is used to control on/off devices at the factory floor. The bus consists of 2 wires marked + and – that carry a 30 Vdc supply with superimposed data. The AS-i protocol uses continuous polling of all devices in a fixed time schedule so that there is continuous data traffic.

To check AS-i, ScopeMeter Channel A is on and alternately AC coupled for data or DC coupled to test 30 Vdc. The recommended probe is the Fluke 10:1 probe. Connect the probe as shown below.

M12 Flat-C

- 1 Brown AS-i +
- 3 Blue AS-i -

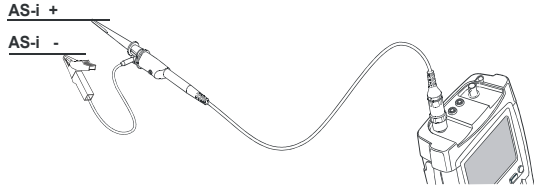

Connection between controller and devices is made using a dedicated yellow flat cable as shown in the figure below (cross section). Connection to the devices is done with piercing connectors. To connect Probe Tip and Black Ground Lead to + (brown conductor) and – (blue), the TP88 Back Probe Pins (optional) can be used to probe screw terminals at the end of the flat cable or as piercing probes. The material of the flat cable also allows to pierce the pin into it. After removal of the pin the material closes again.

AS-i also uses M12-connectors for data as well as on/off signals. The figure below shows where to find + and – on such a connector.

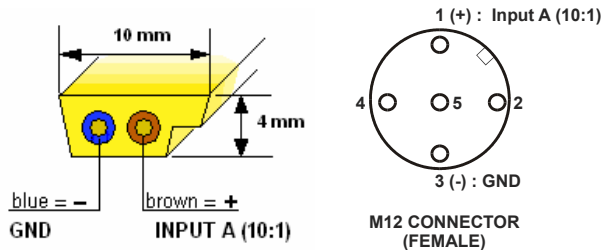

CAN Bus/DeviceNet.

The Controller Area Network (CAN) is used on board of automobiles and also in industrial applications. The industrial bussystem DeviceNet is based on CAN hardware. CAN is a two-wire differential bus used to control actuators and to read out sensors. The bus allows data exchange between different devices. The signal behavior in time is shown in the figure below. The signal wires are marked CAN_L and CAN_H. There is also a common (reference wire) CAN_GND. Data traffic is continuous.

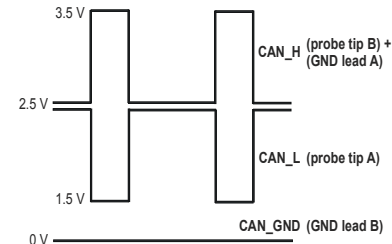

To check CAN Bus, ScopeMeter Channel A and B are on and DC coupled. The recommended probes are Fluke 10:1 probes.

Fluke 19xC-2x5C Users Manual

Connect the probes as shown below.

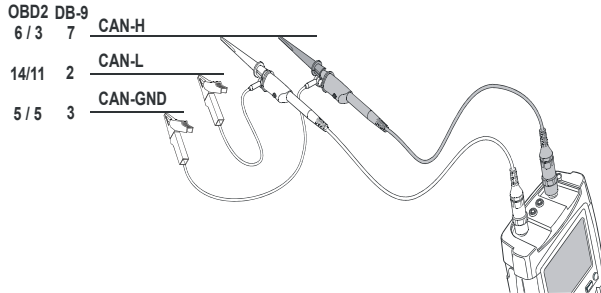

Bus lines can be reached with Back Probe Pins at screw terminals at a device's wire entry point: wire colors commonly used are white for CAN_H, blue for CAN_L, and black for CAN_GND.

Alternatively you can use a third party DB-9 to 4 mm banana breakout box. In addition the figure below shows the pinning of a DB-9 female connector and a typical Automotive (OBD2) connector. Bear in mind that some automobile manufacturers leave bus signals at the connector default on, other manufacturers require bus signals to be enabled via an external controller.

DB-9 (FEMALE)

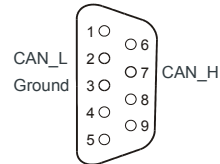

OBD2 (FEMALE)

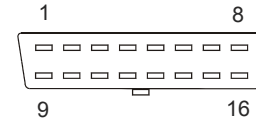

High Speed: HS_CAN_H: Pin 6
HS_CAN_L: Pin 14

Medium Speed: MS_CAN_H: Pin 3
MS_CAN_L: Pin 11

Common (Signal Ground): Pin 5
Battery: Plus: Pin 16 / Minus: Pin 4

Modbus IEA-232/RS-232.

Is in use in Process Industry, Building and Factory Automation. Modbus RS-232 is used for point-to-point communication. System layout is shown in the figure below. Continuous data traffic is not ensured.

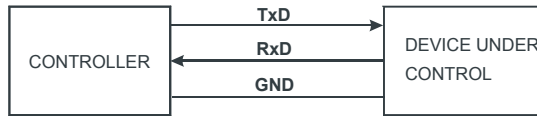

Modbus IEA-232/RS-232

To check this type of bus, ScopeMeter Channel A is on and DC coupled. The recommended probe is the Fluke 10:1 probe. Connect the probe as shown below.

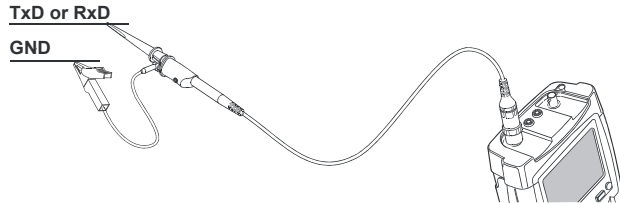

In case there are handshake lines, they can be measured as well as far as V-Levels are concerned.

Modbus IEA-485/RS-485.

Is in use in Process Industry, Building and Factory Automation. Modbus System layout is shown in the figure below. Continuous data traffic is not ensured.

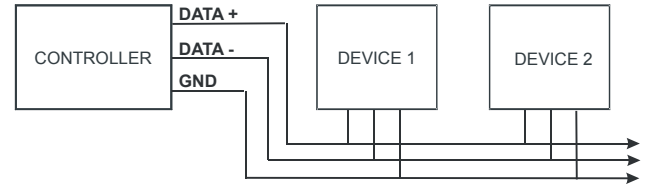

Modbus IEA-485/RS-485

To check this type of bus, ScopeMeter Channel A and B are on and DC coupled. The recommended probes are Fluke 10:1 probes.

Connect the probes as shown below.

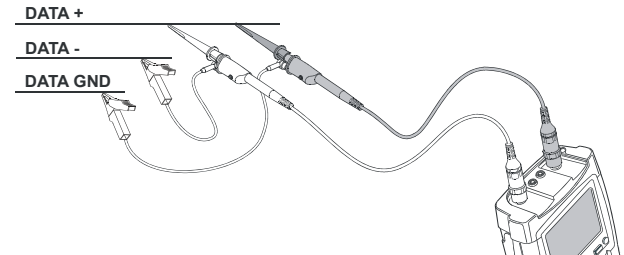

Foundation Fieldbus H1 31.25 kBits/s.

Is used to control ‘field equipment’ such as sensors, actuators, valves, and I/O devices via a two-wire connection. The system allows two-way communication between controller and the devices. Data traffic is continuous. The wires are marked + and – and carry a DC supply of about 24 Vdc with superimposed data of about 800 mVpp. The figure below shows the bus structure.

To check Foundation Fieldbus, ScopeMeter Channel A is on and alternately AC coupled for data or DC coupled to test 24 Vdc. The recommended probe is the Fluke 10:1 probe.

Connect the probe as shown below.

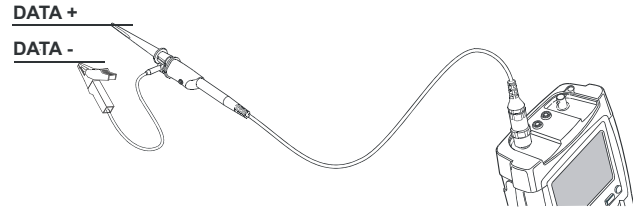

Suitable measuring spots are the screw terminals that are present in a system’s junction boxes. If preferred, you can use the TP88 Back Probe Pins (optional) to probe these terminals at the wire entry point. Commonly used wire colors are orange for + and blue for –.

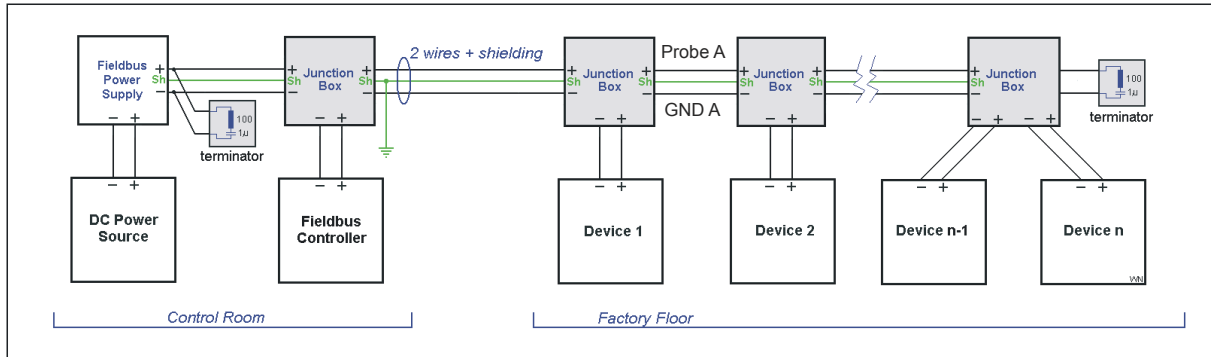

Profibus DP/RS-485.

Profibus DP (Decentralized Periphery) is an open field bus standard used in Process Industry and Factory Automation. It is optimized for speed, efficiency, and low connection costs and allows for multiple data senders and receivers to be connected to an ongoing cable. Data traffic is continuous.

To check this bustype, ScopeMeter Channel A and B are on and DC coupled. The recommended probes are the Fluke 10:1 probes. Connect the probe as shown below.

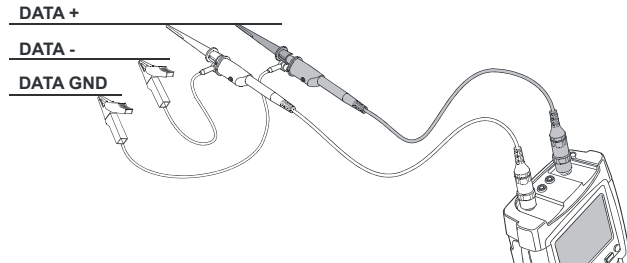

The positive (RxD/TxD-P, DATA +) wire is usually green; the negative (RxD/TxD-N, DATA -) wire is usually red.

Cabling and some connector examples are shown in the adjacent figures. Please note that cables often incorporate termination resistors at the end of the network chain.

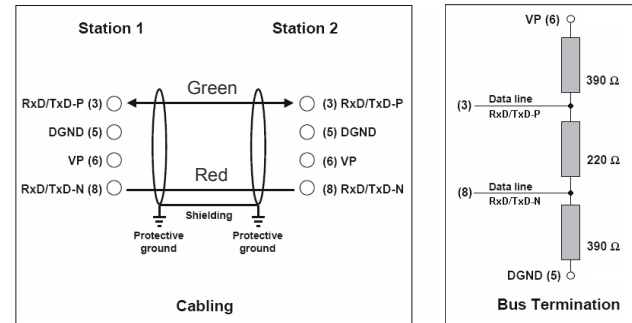

Wiring and bus termination for RS-485 transmissions in PROFIBUS

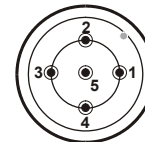

M12 connector for RS-485 in IP65/67

- Pin assignment:**
 1: VP
 2: Rxd/TxD-N
 3: DGND
 4: RxD/TxD-P
 5: Shield

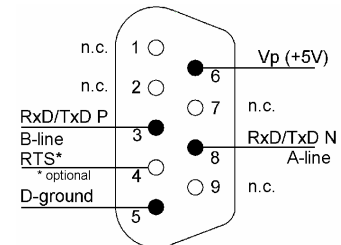

DB-9 female wired for Profibus

Profibus PA/31.25 kBits/s.

Profibus PA (Process Automation) is optimized for process control with focus on explosion safety. The wires are marked Data + and Data – and carry a DC supply with superimposed data. Additionally there are wires with DC power only. Data traffic is continuous.

To check this bustype, ScopeMeter Channel A is on and alternately AC coupled for data or DC coupled to test the DC supply. The recommended probe is the Fluke 10:1 probe. Connect the probe as shown below.

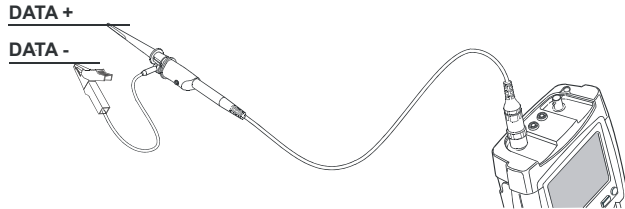

⚠ Warning

When planning tests on this bustype, make sure the proper safety rules are adhered to!

The figures below show some connector types.

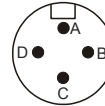

Connector acc. IEC61158-2
for harsh environment
(fixed device side, male contacts)

- A: Data + and Power
- B: Data - and Power
- C: Optional Power +
- D: Optional Power -

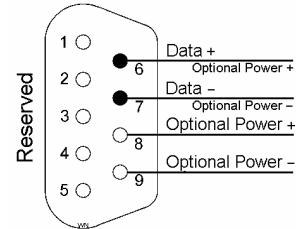

DB-9 female
wired as per 61158-2

Ethernet Coax/10Base2.

To check this bustype, ScopeMeter Channel A is on and DC coupled. To connect to the System Under Test use a PM9083 male BNC to dual Female BNC adapter (T-piece, optional), and an extra BNC cable (PM9092, optional) as shown in the figure below.

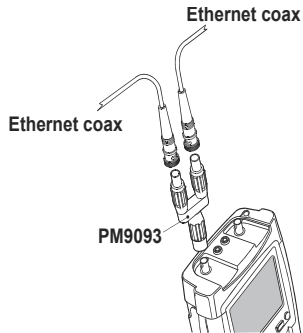

Bear in mind that in Ethernet cabling may be interrupted for only a few seconds during normal process operation. Data traffic usually is continuous.

The figure below shows the typical bus structure.

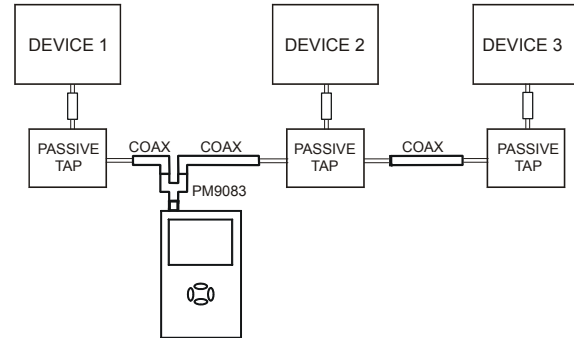

Ethernet Twisted pair/10BaseT.

To check this bustype, ScopeMeter Channel A is on and DC coupled. The recommended probe is the Fluke 10:1 probe. Connect the probe as shown below.

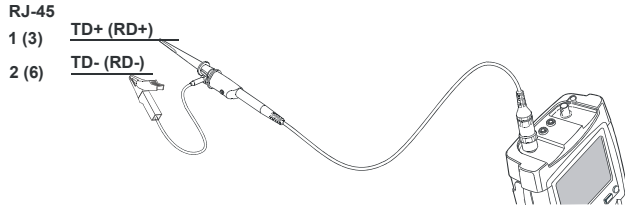

Data traffic is not always continuous.

The wires can be reached with Back Probe Pins TP88 (optional) at screw terminals at a device's wire entry point: for instance at a Junction Box.

The figure below shows pinning and wire colors of a RJ-45 connector.

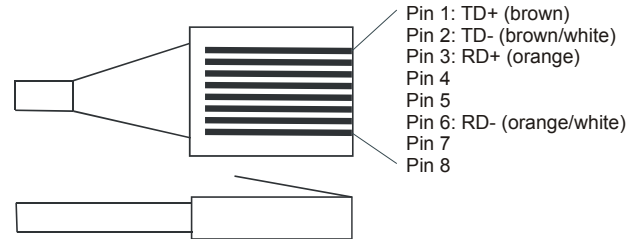

RS-232 Bus.

RS-232 allows two-way communication between a controller and a device such as modem, printer, or sensor. Per device a dedicated link is needed. Initially the RS-232 definition offered an extensive handshake protocol with separate handshake lines (hardware handshake); later software handshake allowed data exchange via only 2 lines (plus ground). Data rates may be low, depending on the application.

To check this bustype, ScopeMeter Channel A is on and DC coupled. The recommended probe is the Fluke 10:1 probe. Connect the probe as shown below.

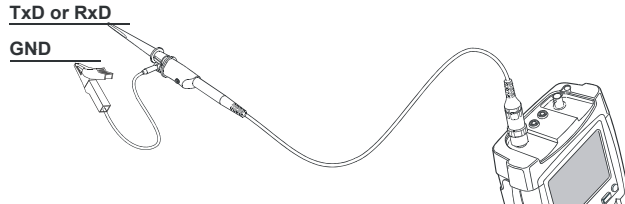

In case there are handshake lines, they each can be checked individually because all use the same voltage levels.

The figure below shows a Female DB-9 connector wired for hardware handshake. Lines used for software handshake are indicated with black dots.

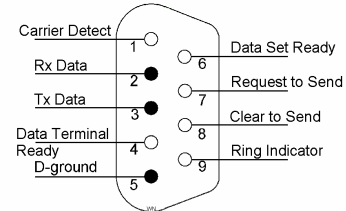

DB-9 female
wired for RS-232

RS-485 Bus.

The RS-485 definition specifies differential (balanced) data lines that are referenced to a ground level. Because of this, noise immunity is better than for RS-232. The impedance between the lines is $120\ \Omega$. RS-485 allows for multiple transmitters and receivers to be connected to the same bus. Data transmission is addressed to a dedicated receiver. Data traffic is not continuous.

To check this bustype, ScopeMeter Channel A and B are on and DC coupled. The recommended probes are the Fluke 10:1 probes. Connect the probes as shown below.

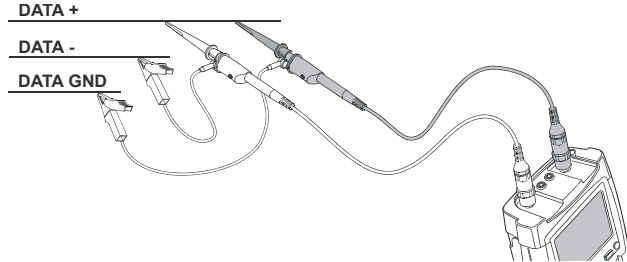

RS-485 bus system layout is shown in the figure below.

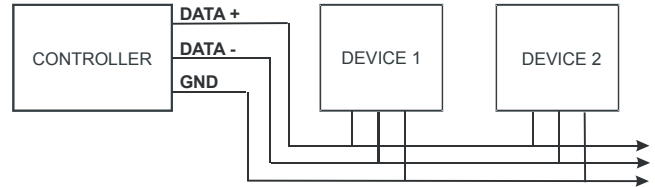

Modbus IEA-485/-RS-485